

FLUKE®

1587 FC/1587/1577

Insulation Multimeter

Users Manual

April 2005 Rev.3, 9/15

© 2005-2015 Fluke Corporation. All rights reserved. Specifications are subject to change without notice.

All product names are trademarks of their respective companies.

LIMITED WARRANTY AND LIMITATION OF LIABILITY

Each Fluke product is warranted to be free from defects in material and workmanship under normal use and service. The warranty period is three years and begins on the date of shipment. Parts, product repairs, and services are warranted for 90 days. This warranty extends only to the original buyer or end-user customer of a Fluke authorized reseller, and does not apply to fuses, disposable batteries, or to any product which, in Fluke's opinion, has been misused, altered, neglected, contaminated, or damaged by accident or abnormal conditions of operation or handling. Fluke warrants that software will operate substantially in accordance with its functional specifications for 90 days and that it has been properly recorded on non-defective media. Fluke does not warrant that software will be error free or operate without interruption.

Fluke authorized resellers shall extend this warranty on new and unused products to end-user customers only but have no authority to extend a greater or different warranty on behalf of Fluke. Warranty support is available only if product is purchased through a Fluke authorized sales outlet or Buyer has paid the applicable international price. Fluke reserves the right to invoice Buyer for importation costs of repair/replacement parts when product purchased in one country is submitted for repair in another country.

Fluke's warranty obligation is limited, at Fluke's option, to refund of the purchase price, free of charge repair, or replacement of a defective product which is returned to a Fluke authorized service center within the warranty period.

To obtain warranty service, contact your nearest Fluke authorized service center to obtain return authorization information, then send the product to that service center, with a description of the difficulty, postage and insurance prepaid (FOB Destination). Fluke assumes no risk for damage in transit. Following warranty repair, the product will be returned to Buyer, transportation prepaid (FOB Destination). If Fluke determines that failure was caused by neglect, misuse, contamination, alteration, accident, or abnormal condition of operation or handling, including overvoltage failures caused by use outside the product's specified rating, or normal wear and tear of mechanical components, Fluke will provide an estimate of repair costs and obtain authorization before commencing the work. Following repair, the product will be returned to the Buyer transportation prepaid and the Buyer will be billed for the repair and return transportation charges (FOB Shipping Point).

THIS WARRANTY IS BUYER'S SOLE AND EXCLUSIVE REMEDY AND IS IN LIEU OF ALL OTHER WARRANTIES, EXPRESS OR IMPLIED, INCLUDING BUT NOT LIMITED TO ANY IMPLIED WARRANTY OF MERCHANTABILITY OR FITNESS FOR A PARTICULAR PURPOSE. FLUKE SHALL NOT BE LIABLE FOR ANY SPECIAL, INDIRECT, INCIDENTAL OR CONSEQUENTIAL DAMAGES OR LOSSES, INCLUDING LOSS OF DATA, ARISING FROM ANY CAUSE OR THEORY.

Since some countries or states do not allow limitation of the term of an implied warranty, or exclusion or limitation of incidental or consequential damages, the limitations and exclusions of this warranty may not apply to every buyer. If any provision of this Warranty is held invalid or unenforceable by a court or other decision-maker of competent jurisdiction, such holding will not affect the validity or enforceability of any other provision.

Fluke Corporation
P.O. Box 9090
Everett, WA 98206-9090
U.S.A.

Fluke Europe B.V.
P.O. Box 1186
5602 BD Eindhoven
The Netherlands

Table of Contents

Title	Page
Introduction	1
Contacting Fluke	2
Safety Information.....	2
Unpack List.....	5
Accessories	5
Hazardous Voltage	6
Test Lead Alert	6
Battery Saver (Sleep Mode)	6
Rotary Switch Positions	7
Buttons	9
Display.....	11
Input Terminals.....	14
Power-Up Options	15
AutoHold Mode.....	16
MIN MAX AVG Recording Mode.....	16
Manual Ranging and Auto Ranging.....	17
AC Zero Input Behavior of True RMS Meters	17
VFD Low-Pass Filter (all 1587 Models)	17

Basic Measurements	18
AC and DC Voltage.....	19
Temperature (all 1587 Models).....	20
Resistance	21
Capacitance (all 1587 models).....	21
Continuity	22
Diodes (all 1587 models)	23
AC or DC Current.....	24
Insulation.....	26
Frequency (all 1587 Models).....	28
Fluke Connect™ Wireless System.....	30
How to Clean	31
Battery Test	31
Fuse Test.....	31
Battery and Fuse Replacement	32
General Specifications	33
Electrical Specifications	35

List of Tables

Table	Title	Page
1.	Symbols	4
2.	Unpack List	5
3.	Accessories	5
4.	Rotary Switch Selections	7
5.	Buttons.....	9
6.	Display Indicators	11
7.	Error Messages	14
8.	Input Terminal Descriptions	14
9.	Power-Up Options	15
10.	Fuse and Battery Replacement	32

List of Figures

Figure	Title	Page
1.	VFD Low Pass Filter	18
2.	Measuring AC and DC Voltage.....	19
3.	Measuring Temperature.....	20
4.	Measuring Resistance	21
5.	Measuring Capacitance	21
6.	Testing for Continuity	22
7.	Testing Diodes.....	23
8.	Measuring AC or DC Current.....	25
9.	Testing Insulation.....	27
10.	Measuring Frequency	29
11.	Fluke Connect™	30
12.	Testing the Fuse	31

Introduction

The Fluke 1587 FC, 1587, 1587T, and 1577 are battery-powered, true-RMS insulation multimeters (the Product or Meter) with a 6000-count display. Although this manual describes the operation of all models, all illustrations and examples assume use of Model 1587 FC.

The Meter measures or tests:

- AC / DC voltage and current
- Resistance
- Continuity
- Insulation resistance
- Voltage and current frequency
- Diodes (all 1587 models)
- Temperature (all 1587 models)
- Capacitance (all 1587 models)

The 1587 FC supports the Fluke Connect™ Wireless System (may not be available in all regions). Fluke Connect™ is a system that wirelessly connects your Meter with an app on your smartphone or tablet. The app shows the Meter measurement on your smartphone or tablet screen. You can save these measurements with Fluke Connect™ to share with your team.

More information about how to use Fluke Connect is on page 30.

Contacting Fluke

To contact Fluke, call one of the following telephone numbers:

- Technical Support USA: 1-800-44-FLUKE (1-800-443-5853)
- Calibration/Repair USA: 1-888-99-FLUKE (1-888-993-5853)
- Canada: 1-800-36-FLUKE (1-800-363-5853)
- Europe: +31 402-675-200
- Japan: +81-3-6714-3114
- Singapore: +65-6799-5566
- Anywhere in the world: +1-425-446-5500

Or, visit Fluke's website at www.fluke.com.

To register your product, visit <http://register.fluke.com>.

To view, print, or download the latest manual supplement, visit <http://us.fluke.com/usen/support/manuals>.

Safety Information

A **Warning** identifies conditions and procedures that are dangerous to the user. A **Caution** identifies conditions and procedures that can cause damage to the Product or the equipment under test. See Table 1 for a list of symbols used on the Meter and in this manual.

Warning

To prevent possible electric shock, fire, or personal injury:

- Read all safety information before you use the Product
- Examine the case before you use the Product. Look for cracks or missing plastic. Carefully look at the insulation around the terminals.
- Do not use test leads if they are damaged. Examine the test leads for damaged insulation and measure a known voltage.
- Do not use the Meter around explosive gas, vapor, or in damp or wet environments.
- Do not touch voltages >30 V ac rms, 42 V ac peak, or 60 V dc.
- Only use probes, test leads, and accessories that have the same measurement category, voltage, and amperage ratings as the Product.

















- **Keep fingers behind the finger guards on the probes.**
- **Do not exceed the Measurement Category (CAT) rating of the lowest rated individual component of a Product, probe, or accessory.**
- **Use the Product only as specified, or the protection supplied by the Product can be compromised.**
- **Comply with local and national safety codes. Use personal protective equipment (approved rubber gloves, face protection, and flame-resistant clothes) to prevent shock and arc blast injury where hazardous live conductors are exposed.**
- **Do not work alone.**
- **Do not apply more than the rated voltage between the terminals or between each terminal and earth ground.**
- **Limit operation to the specified measurement category, voltage, or amperage ratings.**
- **Use Product-approved measurement category (CAT), voltage, and amperage rated accessories (probes, test leads, and adapters) for all measurements.**
- **Measure a known voltage first to make sure that the Product operates correctly.**
- **Use the correct terminals, function, and range for measurements.**
- **Measure for hazardous voltage without the Low-Pass Filter.**
- **Do not use the Product if it operates incorrectly.**
- **Replace the battery when the low battery indicator () shows to prevent incorrect measurements.**
- **Remove the batteries if the Product is not used for an extended period of time, or if stored in temperatures >50 °C. If the batteries are not removed, battery leakage can damage the Product.**
- **The battery door must be closed and locked before you operate the Product.**
- **Remove all probes, test leads, and accessories before the battery door is opened.**
- **Do not use the Product if it is damaged.**
- **Disable the Product if it is damaged.**

Table 1. Symbols

Symbol	Description	Symbol	Description
	WARNING. RISK OF DANGER.		WARNING. HAZARDOUS VOLTAGE. Risk of electric shock.
	Consult user documentation.		Battery (Low battery when shown on display.)
	AC (Alternating Current)		Earth
	DC (Direct Current)		Fuse
	Double Insulated		Conforms to relevant South Korean EMC Standards.
	Conforms to relevant Australian EMC standards.		Certified by CSA Group to North American safety standards.
	Conforms to European Union directives.		Certified by TÜV SÜD Product Service.
CAT II	Measurement Category II is applicable to test and measuring circuits connected directly to utilization points (socket outlets and similar points) of the low-voltage MAINS installation.		
CAT III	Measurement Category III is applicable to test and measuring circuits connected to the distribution part of the building's low-voltage MAINS installation.		
CAT IV	Measurement Category IV is applicable to test and measuring circuits connected at the source of the building's low-voltage MAINS installation.		
	This product complies with the WEEE Directive marking requirements. The affixed label indicates that you must not discard this electrical/electronic product in domestic household waste. Product Category: With reference to the equipment types in the WEEE Directive Annex I, this product is classed as category 9 "Monitoring and Control Instrumentation" product. Do not dispose of this product as unsorted municipal waste.		

Unpack List

Table 2 is a list of accessories included with your Product.

Table 2. Unpack List

Accessory	Model	
	1587, 1587T, 1587 FC	1577
Leads	TL224	TL224
Probes	TP74	TL74
Clips	AC285	AC285
Holster	Yes	Yes
Hard Case	Yes	Yes
K Type Thermocouple	Yes	No
Remote Probe	Yes	Yes

Accessories

Table 3 is list of optional accessories that are available for the Product.

Table 3. Accessories

Accessory	Part Number
ToolPak™ Magnetic Meter Hanger Kit	go to www.fluke.com/tpak
AC 400A Clamp	I400

Hazardous Voltage

To alert you to the presence of a potentially hazardous voltage, when the Meter detects a voltage ≥ 30 V or a voltage overload (OL), the ⚡ symbol is displayed.

Test Lead Alert

To remind you to check that the test leads are in the correct terminals, LEAd shows momentarily when you move the rotary switch to or from the $\frac{\infty}{\text{mA}}$ position.

⚠⚠ Warning

To prevent possible electric shock, fire, or personal injury, use the correct terminals, function, and range for measurements.

Battery Saver (Sleep Mode)

The Meter enters "Sleep mode" and blanks the display if there is no function change or button press for 20 minutes. This is done to conserve battery power. The Meter comes out of Sleep mode when a key is pressed or when the rotary switched is turned.

To disable Sleep mode, hold down the blue button while you turn on the Meter. Sleep mode is always disabled in the MIN MAX AVG recording mode, AutoHold mode, or when the insulation test is active.

Rotary Switch Positions

Turn the Meter on by selecting any measurement function. The Meter presents a standard display for that function (range, measurement units, modifiers, etc.). Use the blue button to select any rotary switch alternate functions (labelled with blue letters). Rotary switch selections are shown and described in Table 4.

Table 4. Rotary Switch Selections









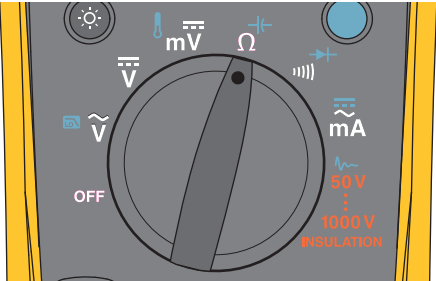

		1587 FC	1587	1587T	1577
Switch Position	Measurement Function				
	AC voltage from 30.0 mV to 1000 V.	●	●	●	●
	AC voltage with 800 Hz VFD low-pass filter.	●	●	●	
	DC voltage 1 mV to 1000 V.	●	●	●	●
	DC mV 0.1 mV to 600 mV.	●	●	●	●

Table 4. Rotary Switch Selections (cont.)

Switch Position	Measurement Function	1587 FC	1587	1587T	1577
	Temperature from - 40 °C to + 537 °C (- 40 °F to + 998 °F). Celsius is the default temperature measurement unit. The temperature measurement you select is retained in memory when the Meter is turned off.	●	●	●	
Ω	Ohms from 0.1 Ω to 50 M Ω .	●	●	●	●
	Capacitance from 1 nF to 9999 μ F.	●	●	●	
	Continuity test. Beeper turns on at <25 Ω and turns off at >100 Ω .	●	●	●	●
	Diode test. There is no ranging in this function. Displays Ω above 6.600 V.	●	●	●	
	AC mA from 3.00 mA to 400 mA (600 mA overload for 2 minutes maximum). DC mA from 0.01 mA to 400 mA (600 mA overload for 2 minutes maximum).	●	●	●	●
 INSULATION	Ohms from 0.01 M Ω to 2 G Ω . The last selected output voltage setting is retained in memory when the Meter is turned off.	●	●	●	
	Ohms from 0.01 M Ω to 600 M Ω . The last selected output voltage setting is retained in memory when the Meter is turned off.				●
	Performs insulation test with: 50 V, 100 V, 250 V, 500 V (default), and 1000 V source	●	●		
	500 V (default) and 1000 V source				●
	50 V (default) and 100 V source			●	
	Press the blue button to activate smoothing during insulation testing.	●	●	●	

Buttons

Use the buttons to activate features that augment the function selected with the rotary switch. The buttons are shown and described in Table 5.

Table 5. Buttons











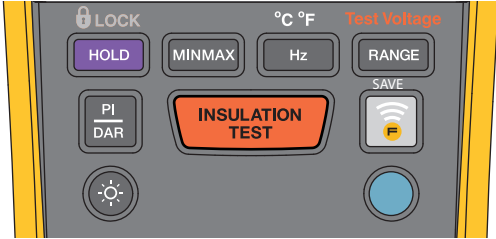

					
Button	Description	1587 FC	1587	1587T	1577
HOLD	<p>Press to freeze the displayed value. Press again to release the display. When a reading changes, the display updates and the Meter beeps.</p> <p>In Insulation Test mode, this schedules a test lock the next time you press  on the Meter or on the remote probe. The test lock acts to hold down the button until your press  or  again to release the lock.</p> <p>In MIN MAX AVG or Hz mode, this button is the display hold.</p>	●	●	●	●
MINMAX	Press to start retaining maximum, minimum, and average values. Press successively to display maximum, minimum, average, and present values. Press and hold to cancel MIN MAX AVG.	●	●	●	
Hz	<p>Activate frequency measurement.</p> <p>Toggles between degrees C and degrees F.</p>	●	●	●	

Table 5. Buttons (cont.)

Button	Description	1587 FC	1587	1587T	1577
	Changes Ranging mode from Auto (default) to Manual Ranging mode. Switches between available ranges in a function. Press and hold to return to Auto Ranging mode. In Insulation Test mode, switches between available source voltages.	●	●	●	●
	Toggles between degrees C and degrees F.		●	●	
	Turns the backlight on and off. The backlight goes off after two minutes.	●	●	●	●
	Initiates an insulation test when the rotary switch is on the INSULATION position. Causes the Meter to source (output) a high voltage and measure insulation resistance.	●	●	●	●
	The blue button functions as a shift key. Press to access blue functions on the rotary switch.	●	●	●	●
	Configures the Tester for a polarization index (PI) or dielectric absorption ratio test (DAR). Press to configure for PI mode, press again to configure for DAR mode. The test starts when you press the  .	●			
	<ul style="list-style-type: none"> Turn on the radio and set the Product to the module mode.  shows in the display when the radio is on. When used with the Fluke Connect App on your smart device, saves a measurement to the Fluke Connect app. Press >2 s. to turn off the radio and exit the module mode. 	●			

Display

Display indicators are shown and described in Table 6. Error messages that may appear on the display are described in Table 7.

⚠⚠ Warning

To prevent possible electric shock or personal injury, replace the battery when the low battery indicator (🔋) shows to prevent incorrect measurements.

Table 6. Display Indicators

		Model			
		1587 FC	1587	1587T	1577
Indicator	Description	1587 FC	1587	1587T	1577
	Low battery. Time to replace the battery. When is on, the backlight button is disabled to conserve battery life. 1587 FC model: module mode is disabled when the battery is low.	●	●	●	●
 LOCK	Indicates a test lock will be applied the next time you press on the Meter or on the remote probe. The test lock acts to hold down the button until you press or again.	●	●	●	●
< - >	Less than, minus, or greater than symbols	●	●	●	●

Table 6. Display Indicators (cont.)











Indicator	Description	1587 FC	1587	1587T	1577
	Hazardous voltage warning. Indicates 30 V or greater (ac or dc depending on the rotary switch position) is detected on the input. Also appears when the display shows Ω in the \tilde{V} , \bar{V} , or $m\bar{V}$ switch positions, and when batt appears on the display. The ⚡ also appears when insulation test is active, or in Hz.	●	●	●	●
	“Smoothing” enabled. Smoothing dampens display fluctuations of rapidly changing inputs by digital filtering. Smoothing is available for insulation testing on 1587 models only. For more on smoothing, see <i>Power-Up Options</i> .	●	●	●	
	Indicates the VFD low-pass filter function for ac volts is selected.	●	●	●	
 HOLD	Indicates AutoHold is active.	●	●	●	●
 HOLD	Indicates display hold is active.				
 MIN MAX MAX MIN AVG	Indicates minimum, maximum, or average reading has been selected using the  button.	●	●	●	
	Continuity test function is selected.	●	●	●	●
	Diode test function is selected.	●	●	●	
nF, μ F, °C, °F, AC, DC, V, mV, mA, Hz, kHz, Ω , k Ω , M Ω , G Ω	Measurement units.	●	●	●	●
	Primary display.	●	●	●	●
V _{DC}	Volts source for Insulation test.	●	●	●	●

Table 6. Display Indicators (cont.)







Indicator	Description	1587 FC	1587	1587T	1577
1000	Secondary display for insulation test voltage.	●	●	●	●
Auto Range ManualRange 610000	Display range in use.	●	●	●	●
2500V 1000V	Source voltage rating for insulation test: 50, 100, 250, 500 (default) or 1000 V on the 1587. 500 (default) and 1000 V ranges available on the 1577. 50 (default) and 100 V on the 1587T.	●	●	●	●
	Insulation test indicator. Appears when insulation test voltage is present.	●	●	●	●
	Shows the Product is in PI or DAR mode.	●			
	Shows that the radio is enabled.	●			
ID#	When the Product is discovered by a Fluke Connect device, an ID number is shown on the secondary display. The ID number also shows on the Fluke Connect device with the Product's model number.	●			



Table 7. Error Messages

Message	Description
batt	Appears on the primary display and indicates that the battery is too low for reliable operation. The Meter will not operate at all until the battery is replaced. The  also appears when batt is on the primary display.
batt	Appears on the secondary display and indicates that the battery is too low to perform an insulation test. The  button is disabled until the battery is replaced. This message disappears when the rotary switch is turned to any other function.
OPEN	Appears when an open thermocouple is detected.
LEAD	Test lead alert. The message appears briefly and a single beep will sound when you move the switch in or out of the  position.
IS-- Err	Model detect error. Service Meter if this is displayed.
dsc	Meter cannot discharge a capacitor.
EPP-- Err	Invalid EEPROM data. Have the Meter serviced.
CAL Err	Invalid calibration data. Calibrate the Meter.

Input Terminals

Input terminals are shown and described in Table 8.

Table 8. Input Terminal Descriptions

Item	Description
①	 input terminal for insulation test.
②	 input terminal for insulation test. Use for ac and dc milliamp measurements to 400 mA and current frequency measurements.
③	1577: input terminal for voltage, continuity, resistance 1587: input terminal for voltage, continuity, resistance, diode, capacitance, voltage frequency, and temperature measurements.
④	Common (return) terminal for all measurements except insulation test.

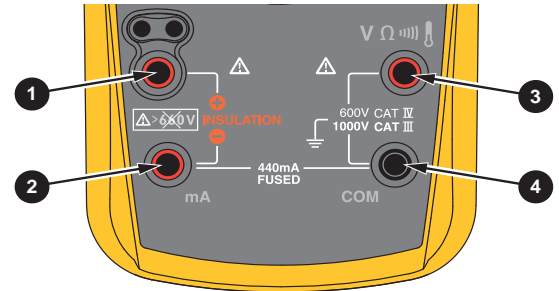

bav04f.eps





Power-Up Options

Holding a button down while turning the Meter on activates a power-up option. Power-up options allow you to use additional features and functions of the Meter. To select a power-up option, hold down the appropriate button indicated while turning the Meter from **OFF** to any switch position. Power-up options are cancelled when the Meter is turned **OFF**. Power-up options are described in Table 9.

Note

Power Up options are active when the button is pressed.

Table 9. Power-Up Options

Button	Description
HOLD	\tilde{V} (V ac and mA ac) switch position turns on all LCD segments.
	\bar{V} (V dc) switch position displays the software version number.
	m \bar{V} (mV) switch position displays the model number.
	Ω^{\dagger} (Ohms/Capacitance) switch position turns on the backlight and the radio LED.
	 ^{\dagger} (Continuity/Diode) switch position starts the Calibration Mode. The Meter shows \square and enters the Calibration Mode when you release the button.
	INSULATION switch position initiates a fully loaded battery test and displays the charge level of the battery until the button is released.
	Enables "Smoothing" mode for all of the functions except insulation. The display shows 5--- until the button is released. Smoothing dampens display fluctuations of rapidly changing inputs by digital filtering.
	Disables automatic power-off ("Sleep mode"). Display shows P _o FF until you release the button. Sleep mode is also disabled while the Meter is in a MIN MAX AVG Recording mode, AutoHold mode, and when performing an insulation test.
	Disables the beeper. The display shows bEEP until you release the button.
	Disables the automatic backlight timeout. Display shows L _o FF until you release the button.

AutoHold Mode

Warning

To prevent electrical shock, do not use the Display AutoHold mode to determine if a circuit is live. Unstable or noisy readings will not be captured.

In the AutoHold mode, the Meter holds the reading on the display until it detects a new stable reading. Then the Meter beeps and displays the new reading.

- Press **HOLD** to activate AutoHold. **A-HOLD** shows on the display.
- Press **HOLD** again or turn the rotary switch to resume normal operation.

MIN MAX AVG Recording Mode

The MIN MAX AVG mode records minimum and maximum input values. The Meter beeps and records a new value when the inputs go below the recorded minimum value, or above the recorded maximum value. This mode can be used to capture intermittent readings, record maximum readings while you are away or record readings while you are operating the equipment under test and cannot watch the Meter. MIN MAX AVG mode can also calculate an average of all readings taken since the MIN MAX AVG mode was activated.

The Meter tracks the minimum, maximum, and average values for each display which are updated 4 times per second.

To use MIN MAX AVG recording:

- Make sure the Meter is in the desired measurement function and range. (Autoranging is disabled in the MIN MAX AVG mode).
- Press **MINMAX** to activate MIN MAX AVG mode. **MIN MAX** shows on the display.
- Press **MINMAX** to step through the high (MAX), low (MIN), average (AVG), and present readings.
- To pause MIN MAX AVG recording without erasing stored values, press **HOLD**. **HOLD** shows on the display.
- To resume MIN MAX AVG recording, press **HOLD** again. **HOLD** turns off.
- To exit and erase stored readings, press **MINMAX** for one second or turn the rotary switch.

Manual Ranging and Auto Ranging

The Meter has both Manual Range and Auto Range modes.

- In the Auto Range mode, the Meter selects the range with the best resolution.
- In the Manual Range mode, you override Auto Range and select the range yourself.

When you turn the Meter on, it defaults to Auto Range and **Auto Range** is shown.

1. To enter the Manual Range mode, press **RANGE**. **Manual Range** is shown.
2. In the Manual Range mode, press **RANGE** to increment the range. After the highest range, the Meter wraps to the lowest range.

Note

You cannot manually change the range in the MIN MAX AVG, or Display HOLD modes.

*If you press **RANGE** while in MIN MAX AVG, or Display HOLD the Meter beeps twice, indicating an invalid operation and the range does not change.*

3. To exit Manual Range, press **RANGE** for one second or turn the rotary switch. The Meter returns to Auto Range and **Auto Range** is shown.

AC Zero Input Behavior of True RMS Meters

True RMS Meters accurately measure distorted waveforms, but when the input leads are shorted together in the AC functions, the Meter displays a residual reading between 1 and 30 counts. When the test leads are open, the display readings may fluctuate due to interference. These offset readings are normal. They do not affect the Meter's ac measurement accuracy over the specified measurement ranges.

Unspecified input levels are:

- AC voltage: below 5 % of 600 mV ac, or 30 mV ac.
- AC current: below 5 % of 60 mA ac, or 3 mA ac.

VFD Low-Pass Filter (all 1587 Models)

The 1587 is equipped with an ac low-pass filter to measure the output of variable frequency motor drives (VFD). For ac voltage or ac frequency (\tilde{v}) measurements, press the blue button to activate the Low-Pass Filter function (**LPF**). The Meter continues measuring in the selected ac mode, but now the signal diverts through a filter that blocks unwanted frequencies above 800 Hz. Refer to Figure 1. The low pass filter can improve measurement performance on composite sine waves that are typically generated by inverters and variable frequency motor drives.

⚠⚠ Warning

To prevent possible electric shock or personal injury, do not use the VFD Low-Pass Filter function to verify the presence of hazardous voltages. Voltages that are greater than what is indicated may be present. First, make a voltage measurement without the filter to detect the possible presence of hazardous voltage. Then, select the filter function.

Note

When using the VFD Low-Pass filter function, the Meter goes to Manual mode. Select ranges by pressing the **[RANGE]** button. Autoranging is not available with the Low-Pass filter function.

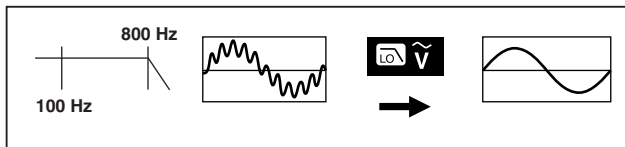

bav16f.eps

Figure 1. VFD Low Pass Filter

Basic Measurements

The figures on the following pages show how to make basic measurements.

When connecting the test leads to the circuit or device, connect the common (**COM**) test lead before connecting the live lead; when removing the test leads, remove the live lead before removing the common test lead.

⚠⚠ Warning

To prevent possible electrical shock, fire, or personal injury:

- **Disconnect circuit power and discharge all high-voltage capacitors before you measure resistance, continuity, capacitance, or a diode junction.**
- **Remove circuit power before you connect the Product in the circuit when you measure current. Connect the Product in series with the circuit.**

For better accuracy when measuring the dc offset of an ac voltage, measure the ac voltage first. Note the ac voltage range, then manually select a dc voltage range equal to or higher than the ac range. This procedure improves the accuracy of the dc measurement by ensuring that the input protection circuits are not activated.

AC and DC Voltage

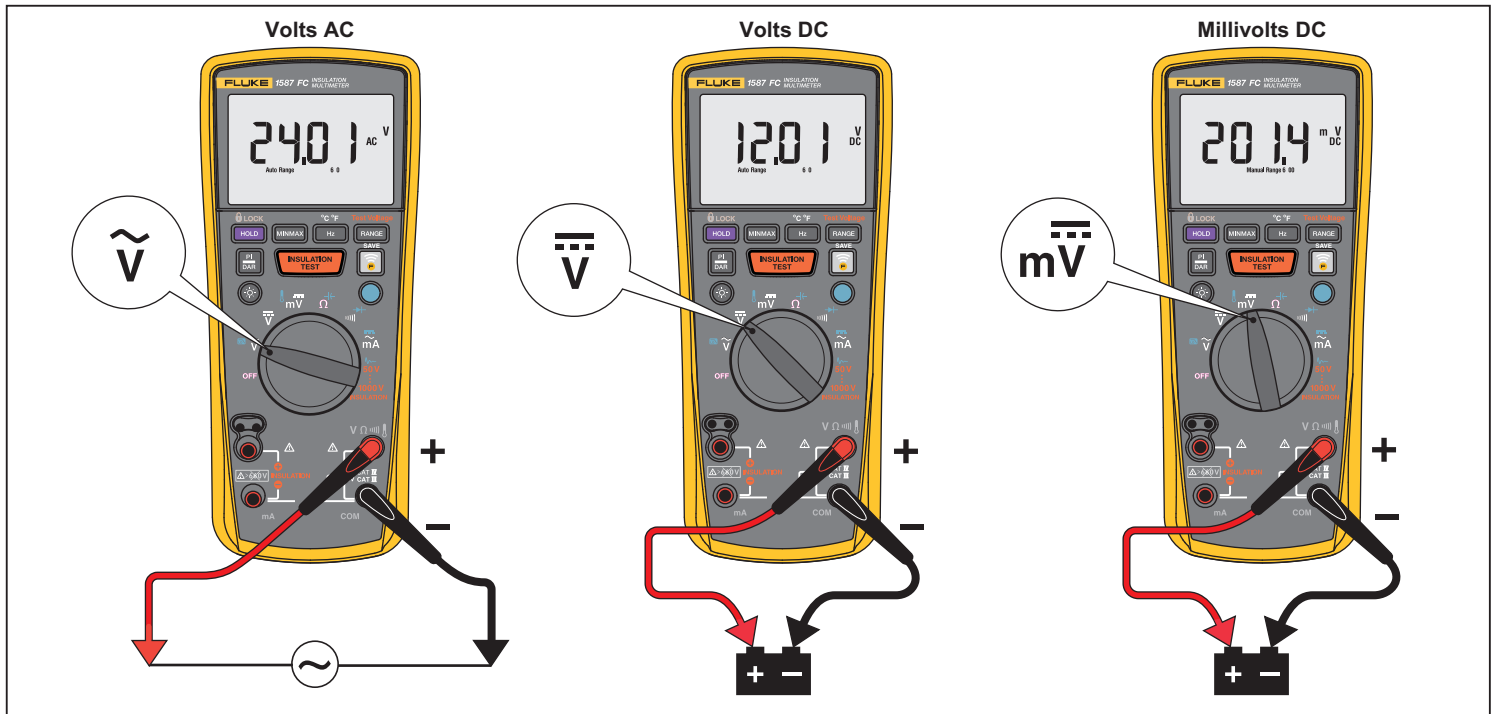

Figure 2. Measuring AC and DC Voltage

bav05f.eps

Temperature (all 1587 Models)

The Meter measures the temperature of a type-K thermocouple (included). Choose between degrees Celsius (°C) or degrees Fahrenheit (°F).

1587 FC:

Press **[Hz]** to toggle between °C or °F.

1587/1587T:

Press **[RANGE]** to toggle between °C or °F.

⚠⚠ Caution

To prevent possible damage to the Meter or other equipment, remember that while the Meter is rated for -40 °C to 537 °C (-40 °F to 998.0 °F), the included K-type thermocouple is rated for 260 °C (500 °F). For temperatures out of that range, use a higher rated thermocouple.

⚠⚠ Warning

To prevent risk of electric shock do not connect thermocouple to electrically live circuits.

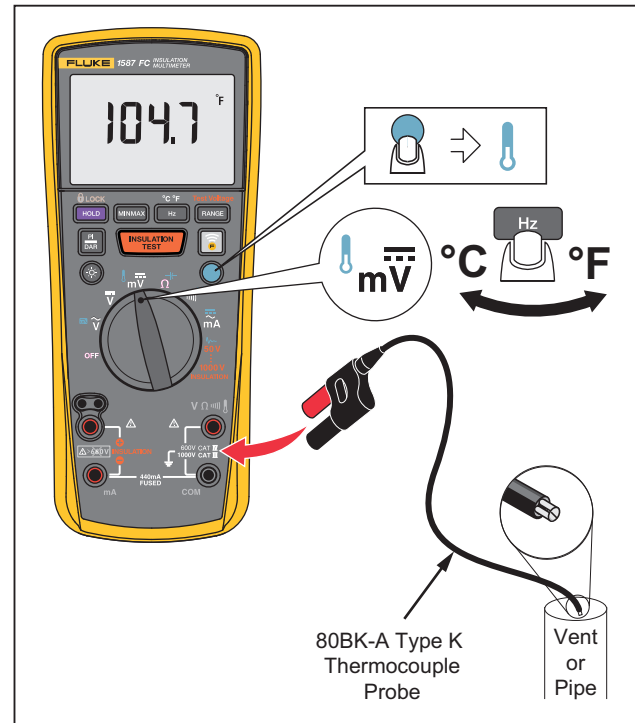

bav09f.eps

Figure 3. Measuring Temperature

Resistance

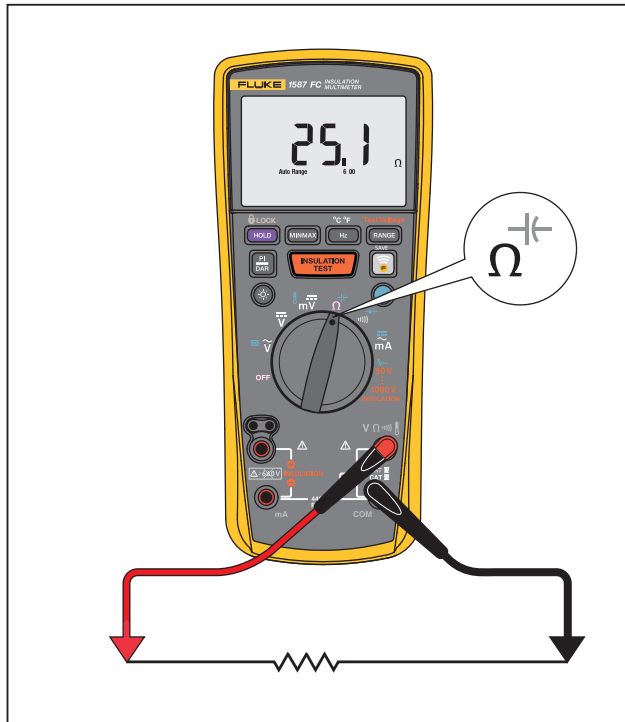

bav06f.eps

Figure 4. Measuring Resistance

Capacitance (all 1587 models)

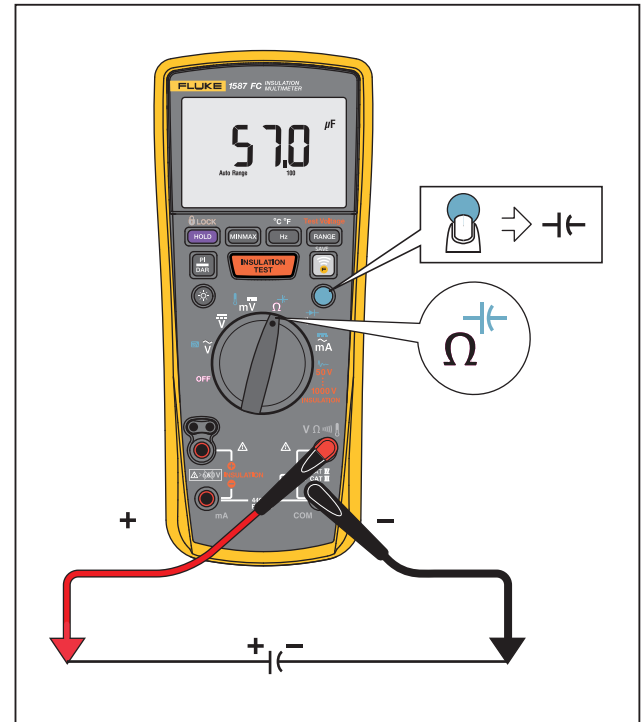

bav07f.eps

Figure 5. Measuring Capacitance

Continuity

The continuity test features a beeper that sounds as long as a circuit is complete. The beeper allows you to perform quick continuity tests without having to watch the display. To test for continuity, set up the Meter as shown in Figure 6. The beeper sounds when a short ($<25\ \Omega$) is detected.

Caution

To prevent possible damage to the Meter or to the equipment under test, disconnect circuit power and discharge all high voltage capacitors before testing for continuity.

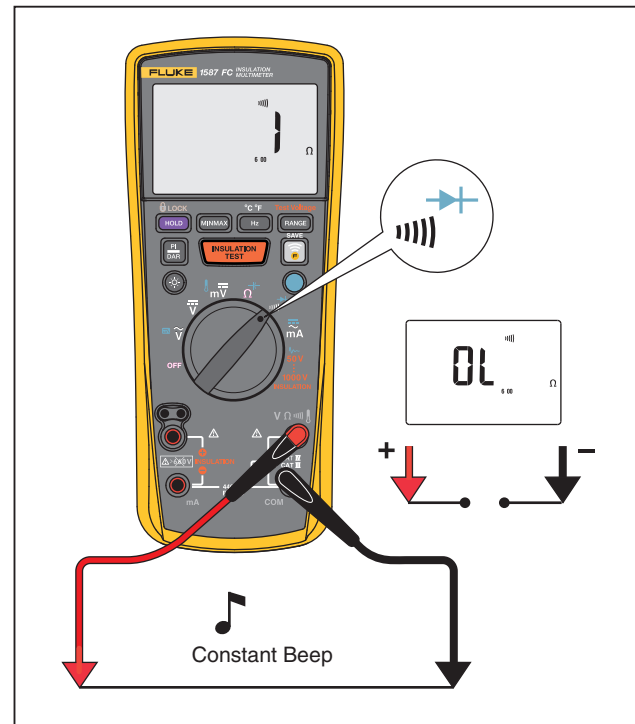

bav08f.eps

Figure 6. Testing for Continuity

Diodes (all 1587 models)

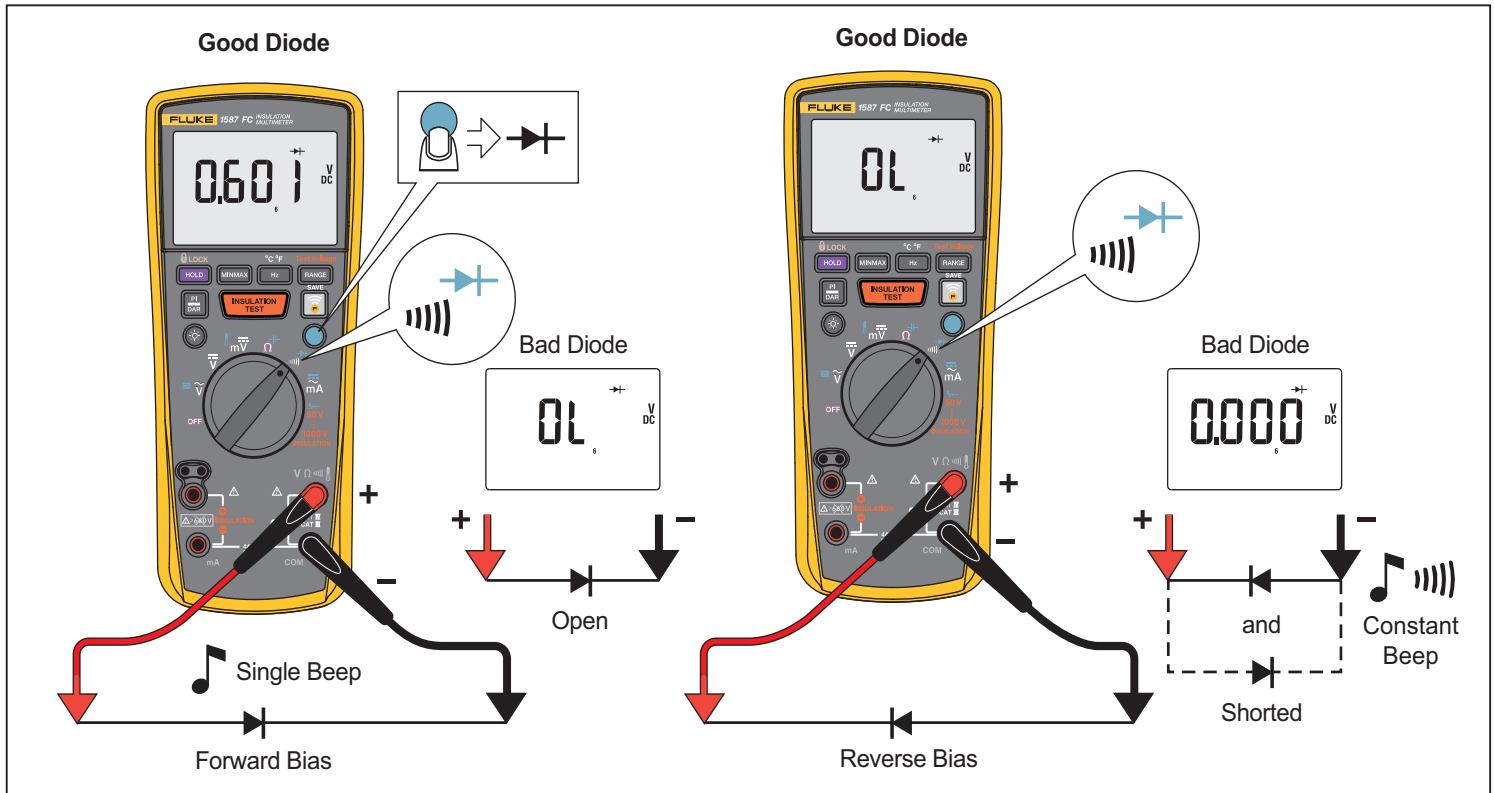

Figure 7. Testing Diodes

bav10f.eps

AC or DC Current

Warning

To prevent personal injury or damage to the Meter:

- Never attempt to make an in-circuit current measurement when the open-circuit potential to earth is >1000 V.
- Check the Meter's fuses before testing. See *Testing the Fuses* later in this manual.
- Use the proper terminals, switch position, and range for your measurement.
- Never place the probes in parallel with a circuit or component when the leads are plugged into the current terminals.

Turn **OFF** power to the circuit under test, break circuit, insert Meter in series, and turn **ON** power. To measure ac or dc current, set up the Meter as shown in Figure 8.

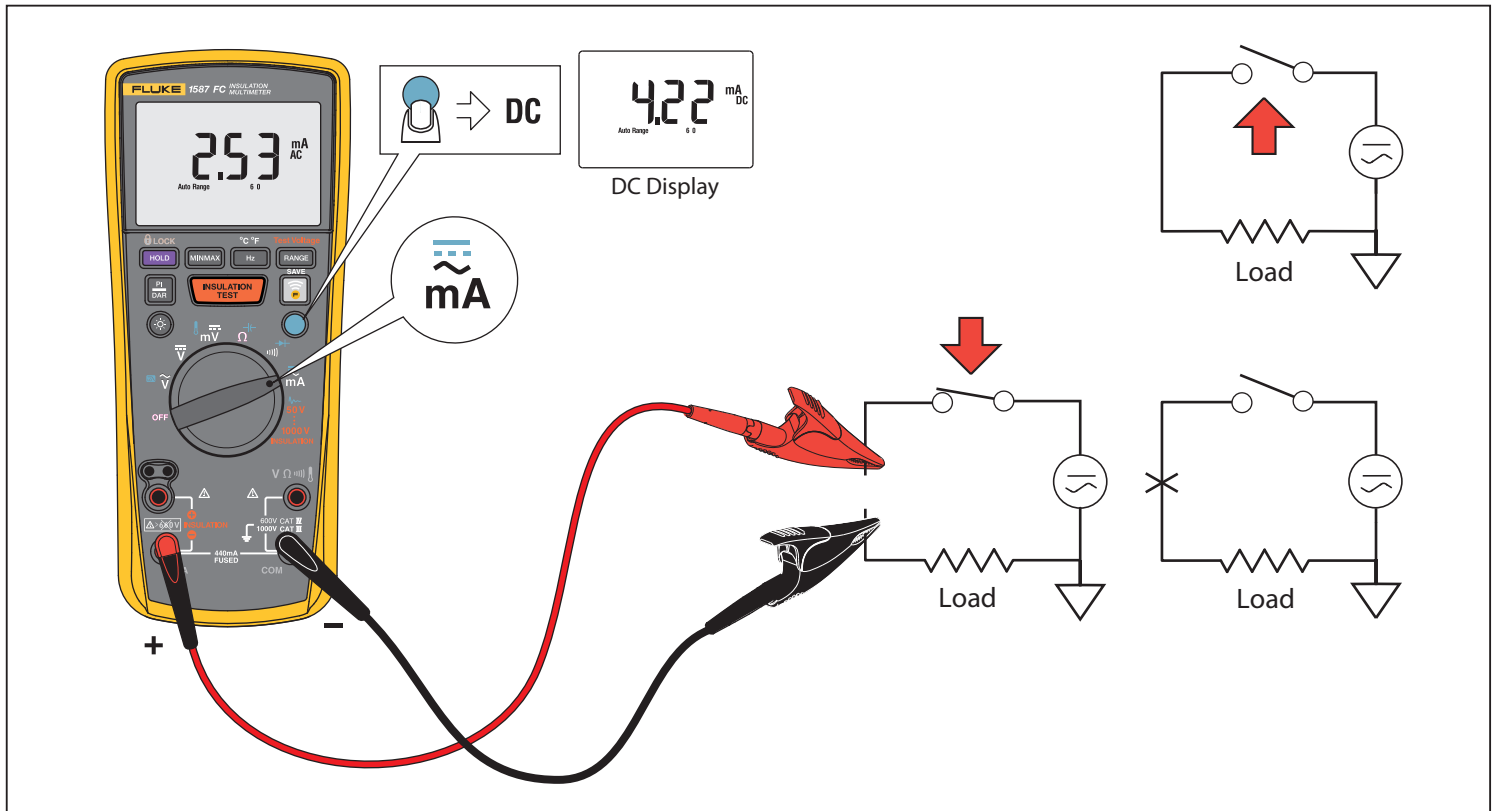

Figure 8. Measuring AC or DC Current

bav11f.eps

Insulation

Insulation tests should only be performed on dead circuits. Check the fuse before testing. See *Fuse Test* later in this manual. To measure insulation resistance, set up the Meter as shown in Figure 9 and follow the steps below:

1. Insert test probes in the \oplus and \ominus input terminals.
2. Turn the knob to **INSULATION** position. A battery load check is initiated when the switch is moved to this position. If the battery fails the test + and **batt** appear in the lower display. Insulation tests cannot be performed until the batteries are replaced.
3. Press **RANGE** to select the voltage.
4. Connect the probes to the circuit to be measured. The Meter automatically detects if the circuit is energized.
 - The primary display shows - - - - until you press **INSULATION TEST** and a valid insulation resistance reading is obtained.
 - The high voltage symbol (⚡) along with a primary display of >30 V warns if voltage more than 30 V ac or dc is present. In this condition, the test is inhibited. Disconnect the Meter and remove power before proceeding.
5. Push and hold **INSULATION TEST** to start the test. The secondary display shows the test voltage applied to the circuit under test. The high voltage symbol (⚡) along with a primary display showing the resistance in M Ω or G Ω appears. The **TEST** icon appears on the lower portion of the display until **INSULATION TEST** is released.

When resistance is higher than the maximum display range, the Meter displays the > symbol and the maximum resistance for the range.
6. Keep the probes on the test points and release the **INSULATION TEST** button. The circuit under test then discharges through the Meter. The resistance reading remains on the primary display until a new test is started, a different function/range is selected, or >30 V is detected.

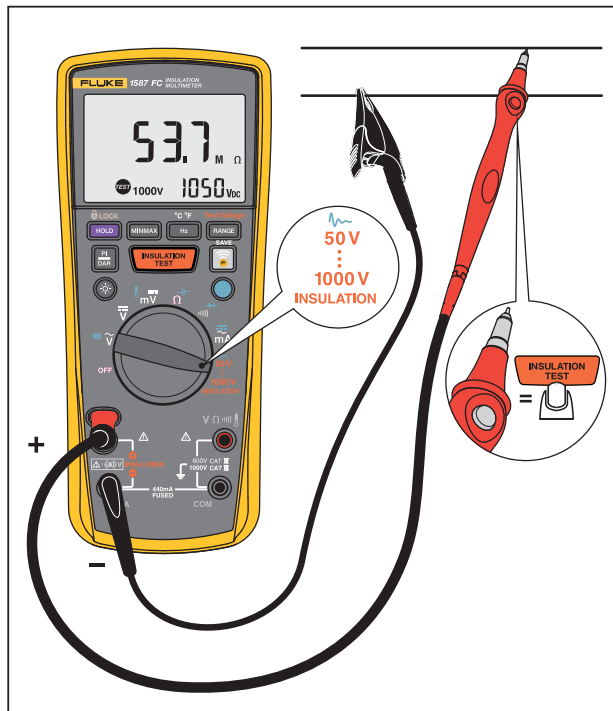

bav13f.eps

Figure 9. Testing Insulation

PI/DAR

Polarization Index (PI) is the ratio of the 10-minute insulation resistance to the 1 minute insulation resistance. Dielectric Absorption Ratio (DAR) is the ratio of the 1-minute insulation resistance to the 30 second insulation resistance.



Insulation tests should only be performed on de-energized circuits. To measure the polarization index or dielectric absorption ratio:

1. Insert test probes in the \oplus and \ominus input terminals.



Note

Because of the time required to perform the PI and DAR tests, use of test clips is recommended.

2. Press **RANGE** repeatedly to select the test voltage.
3. Press **PI/DAR** to select polarization index or dielectric absorption ratio.
4. Connect the probes to the circuit to be measured. The Tester automatically detects if the circuit is energized:
 - The primary display shows ---- until you press the **PI/DAR** button and a valid resistance reading is obtained.
 - The high voltage symbol (⚡) and a primary display of >30 V warns if voltage greater than 30 V ac or dc is present. If high voltage is present, the test is inhibited.



5. Press and release  to start the test. The secondary display shows the test voltage applied to the circuit under test. The high voltage symbol (H) along with the primary display show the resistance in $\text{M}\Omega$ or $\text{G}\Omega$. The  icon shows on the lower portion of the display until the test is finished.

When the test is completed, the PI or DAR value is displayed on the primary display. The circuit under test will automatically be discharged through the Tester. If either value used to calculate PI or DAR was greater than the maximum display range, or the 1-minute value was greater than $5000 \text{ M}\Omega$, the primary display will show Err:

- When resistance is higher than the maximum display range, the Tester displays the > symbol and the maximum resistance for the range.
- To interrupt a PI or DAR test before it is completed, momentarily press . When you release , the circuit under test will automatically be discharged through the Tester.

Frequency (all 1587 Models)

The Meter measures the frequency of a voltage or current signal by counting the number of times the signal crosses a threshold level each second. To measure frequency, set up the Meter as shown in Figure 10 and follow the steps below.

1. Connect the Meter to the signal source.
2. Turn the rotary switch to the $\tilde{\text{V}}$, $\bar{\text{V}}$, or $\bar{\text{mA}}$ position.
3. In the $\bar{\text{mA}}$ position press the blue button to select dc if needed.
4. Press the  button.
5. Press the  button or change the rotary switch position to end this function.

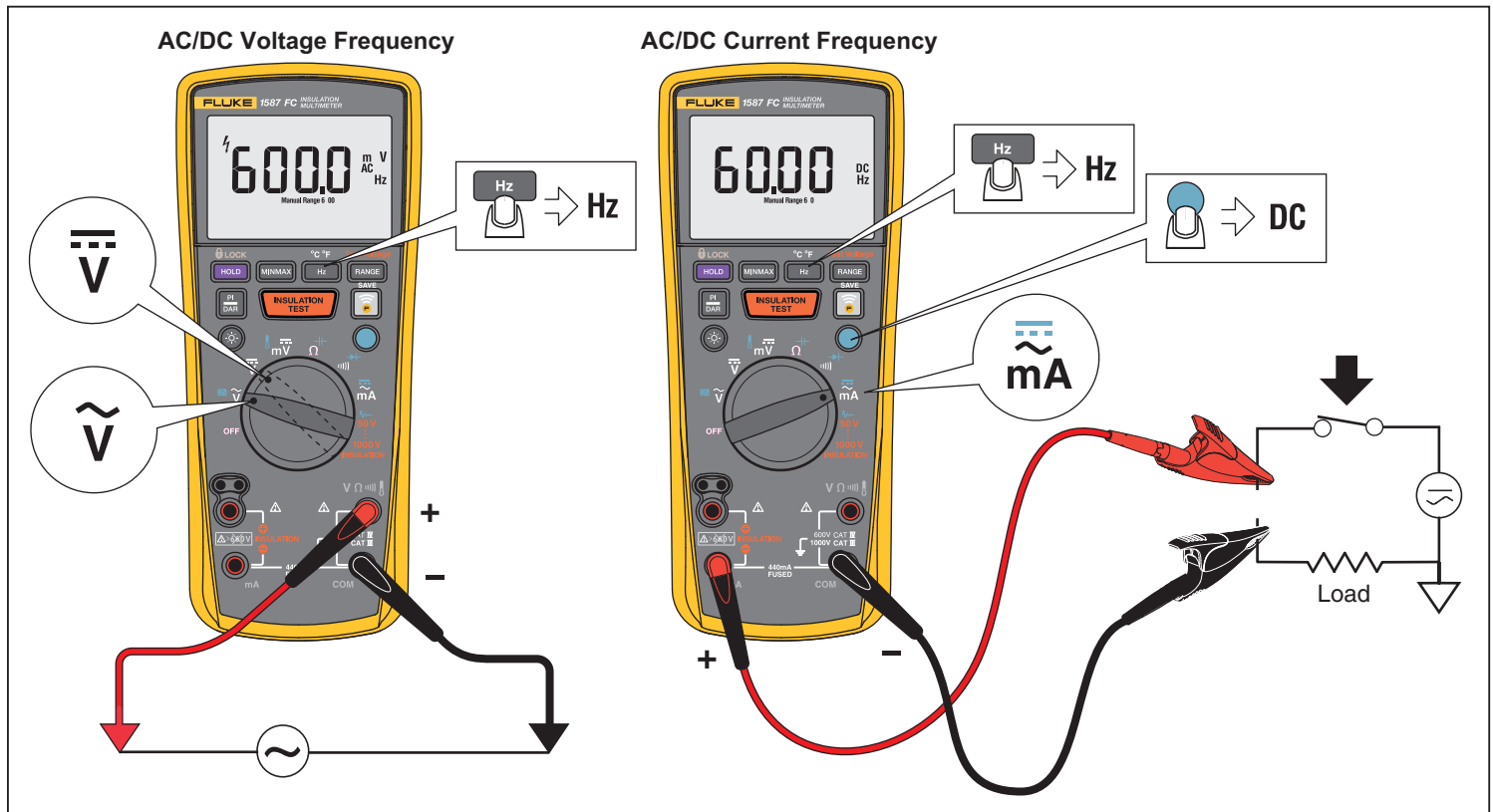

Figure 10. Measuring Frequency

bav12f.eps

Fluke Connect™ Wireless System

The Product supports the Fluke Connect™ Wireless System (may not be available in all regions). Fluke Connect™ is a system that wirelessly connects your Fluke test tools with an app on your smartphone or tablet. It can show measurements from your Meter on a smartphone or tablet screen, save measurements to the asset's EquipmentLog™ history in the Fluke Cloud™, and share the information with your team.

Fluke Connect™ App

The Fluke Connect™ app works with the Apple and Android products. The app is available for download from the Apple App Store and Google Play.

How to access Fluke Connect:

1. Turn on the Meter.
2. Press  to activate the Product's radio. See Figure 11.
3. On your smartphone, go to **Settings > Bluetooth**. Turn on the Bluetooth function.
4. Go to the Fluke Connect App and select your Meter from the list that shows in the app.

You are now able to take, save, and share measurements.

Go to www.flukeconnect.com for more information about how to use the app.

While in insulation test mode, the secondary display shows the output voltage of the test. When the radio is enabled (1587 FC only) the secondary display shows the ID number. If the radio is on while in insulation test mode, the secondary display shows the ID number for 2 seconds and then shows the test voltage.

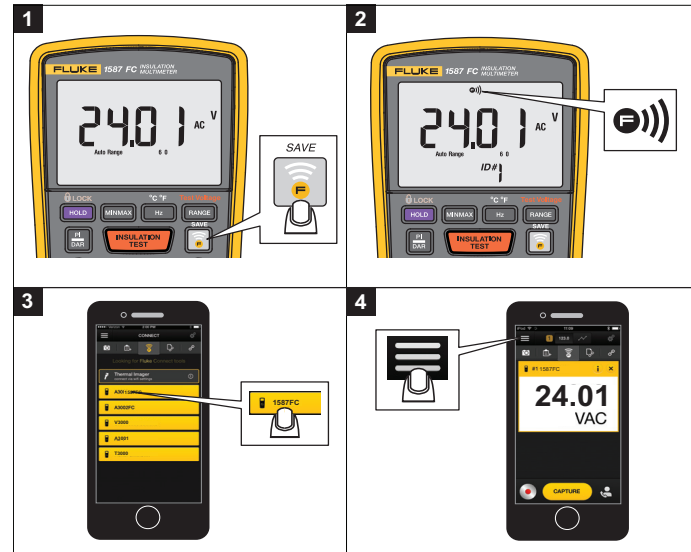

Figure 11. Fluke Connect™

bav17.eps

How to Clean

Periodically wipe the case with a damp cloth and mild detergent. Do not use abrasives or solvents. Dirt or moisture in the terminals can affect readings.

Battery Test

To test the batteries, press **HOLD** and turn to the rotary switch to the **INSULATION** position. This initiates a battery test and displays the charge level of the battery.

Fuse Test

⚠⚠ Warning

To prevent electrical shock or injury, remove the test leads and any input signals before replacing the fuse.

Test the fuse as described below and shown in Figure 12. Replace the fuse as shown in Table 10.

1. Insert a test probe in the $V \Omega \text{ } \text{mV} \text{ } \mu\Omega$ input terminal.
2. Turn the rotary switch to the $\Omega \text{ } \text{m}\Omega$ position and verify the Meter is in Auto Range.
3. Insert the probe in the **mA** input terminal. If the display reading is **OL**, the fuse is bad and should be replaced.

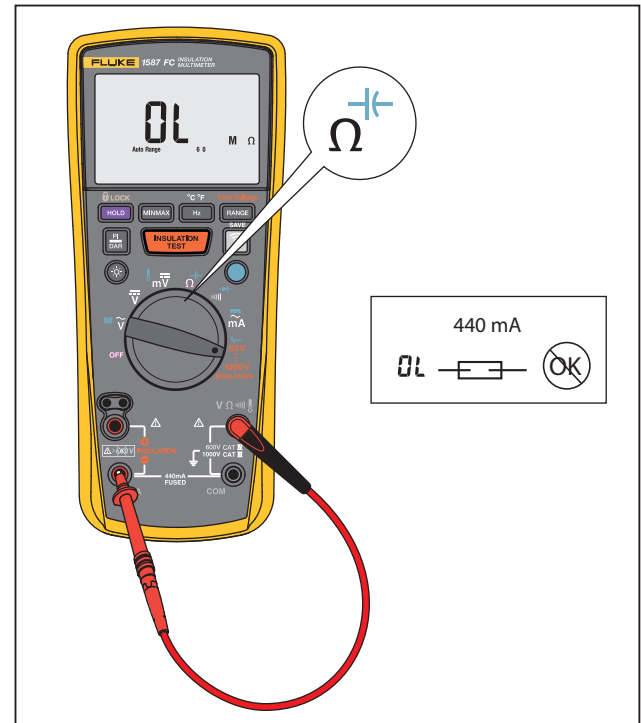

Figure 12. Testing the Fuse

bav14f.eps

Battery and Fuse Replacement

Replace the fuse and batteries as shown in Table 10. Follow the steps below to replace the batteries.

⚠️⚠️ Warning

To prevent possible electrical shock, fire, or personal injury:

- Replace the batteries when the battery indicator (🔋) shows to prevent incorrect measurements.
 - Replace a blown fuse with exact replacement only for continued protection against arc flash.
 - Do not operate the Product with covers removed or the case open. Hazardous voltage exposure is possible.
 - Remove the input signals before you clean the Product.
 - Have an approved technician repair the Product.
1. Turn the rotary switch to OFF and remove the test leads from the terminals.
 2. Remove the battery door by using a standard screwdriver to turn the battery door lock until the unlock symbol aligns with the arrow.

3. Remove and replace the batteries.
4. Replace the battery door and secure by turning the battery door lock until the lock symbol aligns with the arrow.

Table 10. Fuse and Battery Replacement

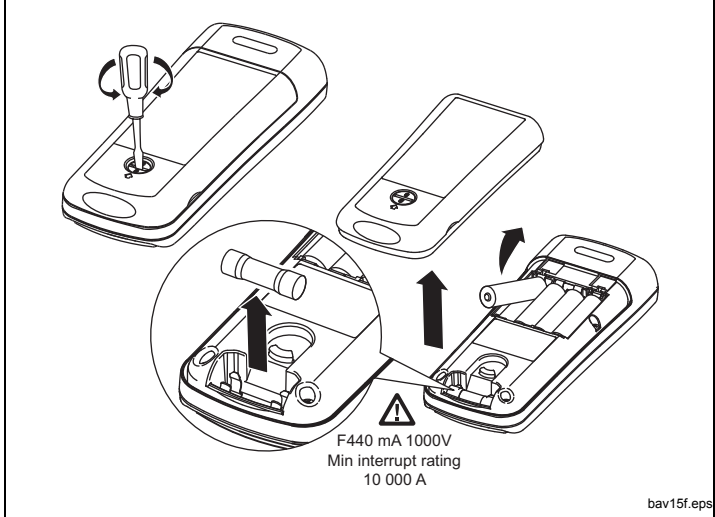

Description	Part Number
Fuse, Fast, 440 mA, 1000 V, Min Interrupt Rating 10000 A	Fluke PN 943121
Battery, 1.5 V AA Alkaline, NEDA 15A, IEC LR6	Fluke PN 376756

General Specifications

Maximum Voltage Applied to any Terminal and Common	1000 V
Fuse Protection for mA input	0.44 A, 1000 V, IR 10 kA
Batteries.....	Four AA batteries (NEDA 15A or IEC LR6)
Battery Life.....	Meter use 1000 hours; Insulation test use: Meter can perform at least 1000 insulation tests with fresh alkaline batteries at room temperature. These are standard tests of 1000 V into 1 M Ω with a duty cycle of 5 seconds on and 25 seconds off.
Size.....	5.0 cm H x 10.0 cm W x 20.3 cm L (1.97 in H x 3.94 in W x 8.00 in L)
Weight.....	550 g (1.2 lb)
Altitude	
Operating.....	2000 m
Storage	12,000 m
Over-Range Capability	110 % of range except for capacitance which is 100 %
Frequency Overload Protection.....	$\leq 10^7$ V Hz
Storage Temperature.....	-40 °C to 60 °C (-40 °F to 140 °F)
Operating Temperature	-20 °C to 55 °C (-4 °F to 131 °F)
Temperature Coefficient	0.05 x (specified accuracy) per °C for temperatures <18 °C or >28 °C (<64 °F or >82 °F)
Relative Humidity.....	Noncondensing
	0 % to 95 % @ 10 °C to 30 °C (50 °F to 86 °F)
	0 % to 75 % @ 30 °C to 40 °C (86 °F to 104 °F)
	0 % to 40 % @ 40 °C to 55 °C (104 °F to 131 °F)
Enclosure Protection.....	IEC 60529: IP40 (non-operating)
Safety	
IEC 61010-1	Pollution Degree 2
IEC 61010-2-033	CAT IV 600 V / CAT III 1000 V

Wireless Radio with Adapter

- Frequency Range 2402 MHz to 2480 MHz
- Output Power <10 mW
- Radio Frequency Certification FCC: T68-FBLE, IC: 6627A-FBLE

Electromagnetic Compatibility

- International IEC 61326-1:Portable Electromagnetic Environment; IEC 61326-2-2 CISPR 11: Group 1, Class A
Group 1: Equipment has intentionally generated and/or uses conductively-coupled radio frequency energy that is necessary for the internal function of the equipment itself.
Class A: Equipment is suitable for use in all establishments other than domestic and those directly connected to a low-voltage power supply network that supplies buildings used for domestic purposes. There may be potential difficulties in ensuring electromagnetic compatibility in other environments due to conducted and radiated disturbances.
Emissions that exceed the levels required by CISPR 11 can occur when the equipment is connected to a test object. The equipment may not meet the immunity requirements of this standard when test leads and/or test probes are connected.
- Korea (KCC) Class A Equipment (Industrial Broadcasting & Communication Equipment)
Class A: Equipment meets requirements for industrial electromagnetic wave equipment and the seller or user should take notice of it. This equipment is intended for use in business environments and not to be used in homes.
- USA (FCC)..... 47 CFR 15 subpart B. This product is considered an exempt device per clause 15.103.

Electrical Specifications

AC Voltage Measurement

Accuracy (all 1587 models)

Range	Resolution	50 Hz to 60 Hz $\pm(\% \text{ of Rdg} + \text{Counts})$	60 Hz to 5000 Hz $\pm(\% \text{ of Rdg} + \text{Counts})$
600.0 mV	0.1 mV	$\pm(1 \% + 3)$	$\pm(2 \% + 3)$
6.000 V	0.001 V	$\pm(1 \% + 3)$	$\pm(2 \% + 3)$
60.00 V	0.01 V	$\pm(1 \% + 3)$	$\pm(2 \% + 3)$
600.0 V	0.1 V	$\pm(1 \% + 3)$	$\pm(2 \% + 3)$ ^[1]
1000 V	1 V	$\pm(2 \% + 3)$	$\pm(2 \% + 3)$ ^[1]

[1] 1 kHz bandwidth.

Low-Pass Filter Voltage (all 1587 models)

Range	Resolution	50 Hz to 60 Hz $\pm(\% \text{ of Rdg} + \text{Counts})$	60 Hz to 400 Hz $\pm(\% \text{ of Rdg} + \text{Counts})$
600.0 mV	0.1 mV	$\pm(1 \% + 3)$	+ (2 % + 3) - (6 % - 3)
6.000 V	0.001 V	$\pm(1 \% + 3)$	+ (2 % + 3) - (6 % - 3)
60.00 V	0.01 V	$\pm(1 \% + 3)$	+ (2 % + 3) - (6 % - 3)
600.0 V	0.1 V	$\pm(1 \% + 3)$	+ (2 % + 3) - (6 % - 3)
1000 V	1 V	$\pm(2 \% + 3)$	+ (2 % + 3) - (6 % - 3)

1577 Accuracy

Range	Resolution	50 Hz to 60 Hz ±(% of Rdg + Counts)
600.0 mV	0.1 mV	±(2 % + 3)
6.000 V	0.001 V	±(2 % + 3)
60.00 V	0.01 V	±(2 % + 3)
600.0 V	0.1 V	±(2 % + 3)
1000 V	1 V	±(2 % + 3)

AC Conversion Inputs are ac-coupled and calibrated to the rms value of sine wave input. Conversions are true-rms responding and specified from 5 % to 100 % of range. Input signal crest factor can be up to 3 at up to 500 V, decreasing linearly to crest factor ≤1.5 at 1000 V. For non-sinusoidal waveforms add ±(2 % reading + 2 % FS) typical, for a crest factor up to 3.

Input Impedance 10 MΩ (nominal), <100 pF, ac-coupled

Common Mode Rejection Ratio
 (1 kΩ unbalanced) >60 dB at dc, 50 or 60 Hz

DC Voltage Measurement

Range	Resolution	Accuracy 1587 and 1587T ^[1] ±(% of Rdg + Counts)	Accuracy 1577 ^[1] ±(% of Rdg + Counts)
6.000 V dc	0.001 V	±(0.09 % + 2)	±(0.2 % + 2)
60.00 V dc	0.01 V	±(0.09 % + 2)	±(0.2 % + 2)
600.0 V dc	0.1 V	±(0.09 % + 2)	±(0.2 % + 2)
1000 V dc	1 V	±(0.09 % + 2)	±(0.2 % + 2)

[1] Accuracies apply to ± 100% of range.

Input Impedance 10 MΩ (nominal), <100 pF

Normal Mode Rejection Ratio >60 dB @ 50 Hz or 60 Hz

Common Mode Rejection Ratio >120 dB @ dc, 50 Hz or 60 Hz (1 kΩ unbalance)

DC Millivolts Measurement

Range	Resolution	Accuracy all 1587 models ±(% of Rdg + Counts)	Accuracy 1577 ±(% of Rdg + Counts)
600.0 mV dc	0.1 mV	±(0.1 % + 1)	±(0.2 % + 1)

DC and AC Current Measurement

Range		Resolution	Accuracy all 1587 models ±(% of Rdg+Counts)	Accuracy 1577 ±(% of Rdg+Counts)	Burden Voltage (Typical)
AC 45 Hz to 1000 Hz	400 mA	0.1 mA	±(1.5 % + 2) ^[1]	±(2 % + 2) ^[1]	2 mV/mA
	60 mA	0.01 mA	±(1.5 % + 2) ^[1]	±(2 % + 2) ^[1]	
DC	400 mA	0.1 mA	±(0.2 % + 2)	±(1.0 % + 2)	2 mV/mA
	60 mA	0.01 mA	±(0.2 % + 2)	±(1.0 % + 2)	

[1] 1 kHz bandwidth.

Overload 600 mA for 2 minutes maximum

Fuse Protection for mA Input 0.44 mA, 1000 V, IR 10 kA

AC Conversion Inputs are ac-coupled and calibrated to the rms value of sine wave input. Conversions are true-rms responding and specified from 5 % to 100 % of range. Input signal crest factor can be up to 3 up to 300 mA, decreasing linearly to crest factor ≤1.5 at 600 mA. For non-sinusoidal waveforms add +(2 % reading + 2 % FS) typical, for a crest factor up to 3.

Ohms Measurement

Range	Resolution	Accuracy all 1587 models ^[1] +(% of Rdg+Counts)	Accuracy 1577 ^[1] +(% of Rdg+Counts)
600.0 Ω	0.1 Ω	±(0.9 % + 2)	±(1.2 % + 2)
6.000 kΩ	0.001 kΩ		
60.00 kΩ	0.01 kΩ		
600.0 kΩ	0.1 KΩ		
6.000 MΩ	0.001 MΩ	±(1.5 % + 3)	±(2.0 % + 3)
50.0 MΩ ^[2]	0.01 MΩ		
[1] Accuracies apply from 0 % to 100 % of range.			
[2] Up to 80 % relative humidity.			

Overload Protection 1000 V rms or dc

Open Circuit Test Voltage <8.0 V dc

Short Circuit Current <1.1 mA

Diode Test (all 1587 models)

Diode Test Indication Display voltage drop: 0.6 V at 1.0 mA nominal test current:

Accuracy ±(2 % + 3)

Continuity Test

Continuity Indication Continuous audible tone for test resistance below 25 Ω and off above 100 Ω. Maximum Reading; 1000 Ω

Open Circuit Voltage <8.0 V

Short Circuit Current 1.0 mA typical

Overload Protection 1000 V rms

Response Time >1 m sec

Frequency Measurement (all 1587 models)

Range	Resolution	Accuracy ±(% of Rdg+Counts)
99.99 Hz	0.01 Hz	±(0.1 % + 1)
999.9 Hz	0.1 Hz	±(0.1 % + 1)
9.999 kHz	0.001 kHz	±(0.1 % + 1)
99.99kHz	0.01 kHz	±(0.1 % + 1)

Frequency Counter Sensitivity (all 1587 models)

Input Range	V ac Sensitivity (RMS Sine Wave) ^[1]		DC Trigger Levels ^[1] to 20 kHz ^[2]
	5 Hz to 20 kHz	20 kHz to 100 kHz	
600.0 mV ac	100.0 mV	150.0 mV	na
6.0 V	1.0 V	1.5 V	-400.0 mV and 2.5 V
60.0 V	10.0 V	36.0 V	1.2 V and 4.0 V
600.0 V	100.0 V	-	12.0 V and 40.0 V
1000.0 V	300.0 V	-	12.0 V and 40.0 V

[1] Maximum input for specified accuracy = 10x range (1000 V max). Noise at low frequencies and amplitudes may affect accuracy.
 [2] Usable to 100 kHz with full scale input.

Capacitance (all 1587 models)

Range	Resolution	Accuracy ±(% of Rdg+Counts)
1000 nF	1 nF	±(1.2 % + 2)
10.00 μF	0.01 μF	
100.0 μF	0.1 μF	±(1.2 % ±90 counts)
9999 μF	1 μF	

Temperature Measurement (all 1587 models)

Range	Resolution	Accuracy ^[1] ±(% of Rdg+Counts)
-40 °C to 537 °C	0.1 °C	±(1 % + 10 counts)
-40 °F to 998 °F	0.1 °F	±(1 % + 18 counts)

[1] Accuracies apply following 90 minutes settling time after a change in the ambient temperature of the instrument.

Insulation Specifications

Measurement Range

Model 1587, 1587 FC	0.01 M Ω to 2 G Ω
Model 1577	0.1 M Ω to 600 M Ω
Model 1587T	0.01 M Ω to 100 M Ω

Test Voltages

Model 1587, 1587 FC	50, 100, 250, 500, 1000 V
Model 1577	500, 1000 V
Model 1587T	50, 100 V

Test Voltage Accuracy..... +20 %, -0 %

Short-Circuit Test Current..... 1 mA nominal

Auto Discharge

Discharge time <0.5 second for C = 1 μ F or less
--

Live Circuit Detection..... Inhibit test if terminal voltage > 30 V prior to initialization of test

Maximum Capacitive Load

Operable with up to 1 μ F load

Model 1587/1587 FC

Output Voltage	Display Range	Resolution	Test Current	Resistance Accuracy ±(% of R _{dg} + Counts)
50 V (0 % to +20 %)	0.01 to 6.00 MΩ	0.01 MΩ	1 mA @ 50 kΩ	±(3 % + 5 counts)
	6.0 to 50.0 MΩ	0.1 MΩ		
100 V (0 % to +20 %)	0.01 to 6.00 MΩ	0.01 MΩ	1 mA @ 100 kΩ	±(3 % + 5 counts)
	6.0 to 60.0 MΩ	0.1 MΩ		
	60 to 100 MΩ	1 MΩ		
250 V (0 % to +20 %)	0.1 to 60.0 MΩ	0.1 MΩ	1 mA @ 250 kΩ	±(1.5 % + 5 counts)
	60 to 250 MΩ	1 MΩ		
500 V (0 % to +20 %)	0.1 to 60.0 MΩ	0.1 MΩ	1 mA @ 500 kΩ	±(1.5 % + 5 counts)
	60 to 500 MΩ	1 MΩ		
1000 V (0 % to +20 %)	0.1 to 60.0 MΩ	0.1 MΩ	1 mA @ 1 MΩ	±(1.5 % + 5 counts)
	60 to 600 MΩ	1 MΩ		±(1.5 % + 5 counts)
	0.6 to 2.0 GΩ	100 MΩ		±(10 % + 3 counts)

Model 1577

Output Voltage	Display Range	Resolution	Test Current	Resistance Accuracy ±(% of R _{dg} + Counts)
500 V (0 % to +20 %)	0.1 to 60.0 MΩ	0.1 MΩ	1 mA @ 500 kΩ	±(2.0 % + 5 counts)
	60 to 500 MΩ	1 MΩ		
1000 V (0 % to +20 %)	0.1 to 60.0 MΩ	0.1 MΩ	1 mA @ 1 MΩ	±(2.0 % + 5 counts)
	60 to 600 MΩ	1 MΩ		

Model 1587T

Output Voltage	Display Range	Resolution	Test Current	Resistance Accuracy ±(% of Rdg + Counts)
50 V (0 % to +20 %)	0.01 to 6.00 MΩ	0.01 MΩ	1 mA @ 50 kΩ	±(3 % + 5 counts)
	6.0 to 50.0 MΩ	0.1 MΩ		
100 V (0 % to +20 %)	0.01 to 6.00 MΩ	0.01 MΩ	1 mA @ 100 kΩ	±(3 % + 5 counts)
	6.0 to 60.0 MΩ	0.1 MΩ		
	60 to 100 MΩ	1 MΩ		

Model 1587C FC

Output Voltage	Display Range	Resolution	Test Current	Resistance Accuracy ±(% of Rdg + Counts)
50 V (-10 % to +10 %)	0.01 to 6.00 MΩ	0.01 MΩ	1 mA @ 50 kΩ	±(3 % + 5 counts)
	6.0 to 50.0 MΩ	0.1 MΩ		
100 V (-10 % to +10 %)	0.01 to 6.00 MΩ	0.01 MΩ	1 mA @ 100 kΩ	±(3 % + 5 counts)
250 V (-10 % to +10 %)	0.1 to 60.0 MΩ	0.1 MΩ	1 mA @ 250 kΩ	±(1.5 % + 5 counts)
	60 to 250 MΩ	1 MΩ		
500 V (0 % to +20 %)	0.1 to 60.0 MΩ	0.1 MΩ	1 mA @ 500 kΩ	±(1.5 % + 5 counts)
	60 to 500 MΩ	1 MΩ		
1000 V (0 % to +20 %)	0.1 to 60.0 MΩ	0.1 MΩ	1 mA @ 1 MΩ	±(1.5 % + 5 counts)
	60 to 600 MΩ	1 MΩ		±(1.5 % + 5 counts)
	0.6 to 2.0 GΩ	100 MΩ		±(10 % + 3 counts)