

Rosemount™ 2555 Solids Level Switch

Capacitance Probe



- Very high sensitivity (dielectric constant, $DK \geq 1.5$)
- Supports high mechanical loads of up to 10 kN
- Simple to install and set-up
- Robust version for overpressure up to 363 psi (25 bar)
- Temperature from -40 to 932 °F (-40 to 500 °C)

Introduction

Measurement principles

The Rosemount™ 2555 Solids Level Switch uses the principle of measuring capacitance through RF (Radio Frequency) to detect the presence or absence of a solids medium and monitors the change in capacitance between the probe and the silo wall.

When the solids medium in the vessel (silo) falls away from the probe level, it causes an increase in capacitance that is detected by the electronics and the output switches to indicate an 'uncovered' state.

When the solids medium in the vessel (silo) rises and covers the rod, it causes a decrease of capacitance that is detected by the electronics and the output switches to indicate a 'covered' state.

The electrical output will vary depending on the electronics selected.

Key features and benefits

- Flexible, robust solids switch - suitable for point level measurement of nearly all types of bulk materials
- Reliable measurement of materials with low dielectric constants (DK from 1.5)
- Designed for operation in high temperatures and pressures of up to 932 °F (500 °C) and 363 psi (25 bar)
- Simple and quick automatic calibration for easy commissioning
- Special probe design with high resistance to material build-up for safe maintenance-free operation
- Continuous self-checking diagnostics for condition monitoring with easy-to-read display and push buttons
- Approvals for hazardous locations (gas and dust)
- Versatile installation options:
 - rod version: vertical, horizontal, and angled installation
 - cable version: vertical installation

Note

A listing of dielectric (DK) values for solids materials can be in the [Dielectric Values \(DK Values\) Data Sheet](#) on-line document.

Contents

Introduction.....	2
Ordering information.....	4
Spares and accessories.....	8
Specifications.....	10
Product certifications.....	15
Dimensional drawings.....	19

Applications

- Level measurements of most bulk solids materials, including:
 - Flour, grains, sugar, cement, granulate, carbon black, and materials with coating properties
- All types of vessel from small process silos to large storage silos
- Extreme-temperature and high-pressure applications
- Environments with heavy vibration
- High-reliability and high-safety
- Approvals for hazardous and explosive environments

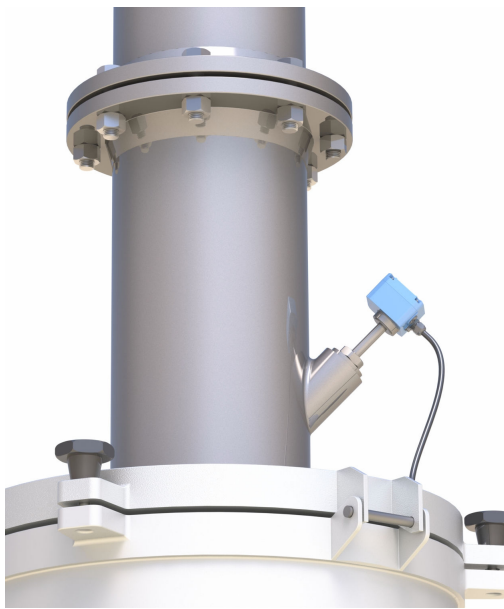

Ordering information

The specification and selection of product materials, options, or components must be made by the purchaser of the equipment. See [Materials selection](#) for more information.

Table 1: Rosemount 2555 Ordering Information

The starred offerings (★) represent the most common options and should be selected for best delivery. The non-starred offerings are subject to additional delivery lead time.

Model	Product description		
2555	Rosemount Solids Level Switch - Capacitance Probe		★
Probe thermal profile			
S	Standard 10-mm diameter probe (T _{process} = -40 to +464 °F (-40 to +240 °C), P _{op} -14.5 to 363 psi (-1 to +25 bar))		★
M	Medium 22-mm diameter probe (T _{process} = -40 to +464 °F (-40 to +240 °C), P _{op} -14.5 to 363 psi (-1 to +25 bar))		★
E	Extreme 22-mm diameter probe (T _{process} = -40 to +932 °F (-40 to +500 °C), P _{op} -14.5 to 145 psi (-1 to +10 bar))		★
R	Standard 4-mm diameter rope (T _{process} = -40 to +464 °F (-40 to +240 °C), P _{op} -14.5 to 363 psi (-1 to +25 bar))		★
P	Medium 8-mm diameter rope (T _{process} = -40 to +464 °F (-40 to +240 °C), P _{op} -14.5 to 363 psi (-1 to +25 bar))		★
V	Extreme 8-mm diameter rope (T _{process} = -40 to +932 °F (-40 to +500 °C), P _{op} -14.5 to 145 psi (-1 to +10 bar))		★
Materials of construction: process connection/active probe and inactive extension rod			Profiles
D	303/304/321 Stainless steel (1.4301/1.4305/1.4541)	All	★
E	303/304/321 Stainless steel (1.4301/1.4305/1.4541), PFA coating to active probe only	S	★
F	303/304/321 Stainless steel (1.4301/1.4305/1.4541), PFA coating to rope only	R	★
G	303/304/321 Stainless steel (1.4301/1.4305/1.4541), PFA coating	S	★
S	316/316L Stainless steel (1.4404/1.4401)	All	★
T	316/316L Stainless steel (1.4404/1.4401), PFA coating to active probe only	S	★
U	316/316L Stainless steel (1.4404/1.4401), PFA coating to rope only	R	★
V	316/316L Stainless steel (1.4404/1.4401), PFA coating	S	★
Conduit entry / cable threads			
1	M20 x 1.5, 1 off screwed cable gland + 1 off blind plug for CE, ATEX, and IECEx		★
2	M20 x 1.5, 2 off screwed cable glands		★
3	M20 x 1.5, 1 off screwed cable gland + 1 off blind plug for FM		★
4	NPT ½-in. tapered ANSI B1.20.1 (1 off conduit + 1 off Ex-d blind plug)		★
Process connection size			Profiles
9 ⁽¹⁾	¾-in./19 mm (DN25)/25A	S and R	★
1 ⁽¹⁾	1-in./25 mm (DN25)/25A	S and R	★
A ⁽¹⁾	1.25-in./32 mm	All	★
5	1.5 in./((DN38)/40A	All	★
2 ⁽¹⁾	2 in./50 mm (DN50)/50A	All	★
3 ⁽¹⁾	3 in./80 mm (DN80)/80A	All	★
4 ⁽¹⁾	4 in./100 mm (DN100)/100A	All	★

Table 1: Rosemount 2555 Ordering Information (continued)

B ⁽¹⁾	M30 x 1.5 mm	S and R	★
C ⁽¹⁾	M32 x 1.5 mm	S and R	★
Process connection rating		Sizes	
AA	ASME B16.5 Class 150 flange	2, 3, and 4	★
DZ	EN 1092-1 PN6 flange	4	★
DA	EN 1092-1 PN16 flange	4	★
NN	For use with non-flange process connection type	All except 3 and 4	★
Process connection type		Ratings	
F	Flat-face flange	DZ and DA	★
R	Raised-face flange	AA	★
G	BSPP (G) thread	NN	★
N	NPT thread	NN	★
M	Metric thread	NN	★
C	Tri Clamp (ISO 2852)	NN	★
Electronic type			
V	Relay DPDT 21 to 230 Vac/Vdc		★
Active probe length		Profiles	
A ⁽²⁾	Standard length 3.94-in. (100 mm)	S, M, and E	★
B ⁽²⁾	Standard length 7.87-in. (200 mm)	S, M, and E	★
C ⁽²⁾	Standard length 11.8-in. (300 mm)	S, M, and E	★
E	Extended, customer-specified length in tenths of inches	All	★
M	Extended, customer-specified length in millimeters	All	★
Specific extended active probe length		All	
00000	Factory default length (only if active probe length A, B, or C is selected)		★
XXXXX	Specific customer-specified length in tenths of inches (XXXX.X inches) or millimeters (XXXXX mm)		★
Inactive extension length			
A ⁽³⁾	No inactive extension		★
E	Inactive extension, customer-specified length in tenths of inches		★
M	Inactive extension, customer-specified length in millimeters		★
Specific inactive extension length			
0000	Factory default length (only if inactive extension length A is selected)		★
XXXX	Specific customer-specified length in tenths of inches (XXX.X inches) or millimeters (XXXX mm)		★
Product certifications		Conduit entry	
NA	No hazardous locations certifications	1, 2, and 4	★
ND ⁽⁴⁾	ATEX, Dust Certification	1, 2, and 4	★

Table 1: Rosemount 2555 Ordering Information (continued)

NK ⁽⁴⁾	IECEX, Dust Certification	1, 2, and 4	★
NL ⁽⁴⁾	American, DIP	2, 3, and 4	★
E5 ⁽⁴⁾⁽⁵⁾	American, Flameproof/Dust certification	4	
E7 ⁽⁴⁾⁽⁵⁾	IECEX, Flameproof/Dust certification	4	
E8 ⁽⁴⁾⁽⁵⁾	ATEX, Flameproof/Dust certification	4	
EM ⁽⁴⁾⁽⁵⁾	Technical Regulations Customs Union (EAC), Dust Certification	1, 2, and 4	
K1 ⁽⁴⁾⁽⁵⁾	ATEX, Flameproof/Increased Safety/Dust Certification	1, 2, and 4	
K7 ⁽⁴⁾⁽⁵⁾	IECEX, Flameproof/Increased Safety/Dust Certification	1, 2, and 4	
KM ⁽⁴⁾⁽⁵⁾	Technical Regulations Customs Union (EAC), Flameproof/Increased Safety/Dust certification	1, 2, and 4	
KY ⁽⁴⁾⁽⁵⁾	American, Flameproof/Dust certification	4	
KZ	American and Canadian Ordinary Location (unclassified, safe area)	2, 3, and 4	★
Options (include with selected model number)			
Calibration data certification			
Q4	Certificate of functional test		★
Weather protection			
P2	Weather protection cover		★
Electronics sensitivity configuration			
V1	Calibrate to 0.5 pF		★
V2	Calibrate to 1 pF		★
V3	Calibrate to 4 pF		★
V4	Calibrate to 10 pF		★
Active probe extension		Profiles	
R0	Rigid, 316L (1.4404) stainless steel, 15.7 in. (400 mm) long, ø10-mm probe	S	★
R1	Rigid, 316L (1.4404) stainless steel, 15.7 in. (400 mm) long, ø10-mm probe, includes fixing hole	S	★
R2	Rigid, 316L (1.4404) stainless steel, 15.7 in. (400 mm), ø22-mm probe	M, E, P, V	★
R3	Flexible, 304/303 (1.4301/1.4305) stainless steel, 39.4 in. (1000 mm) long, ø10-mm probe	S	★
R4	Flexible, 304/303 (1.4301/1.4305) stainless steel, 39.4 in. (1000 mm) long, ø10-mm probe, includes fixing hole	S	★
R5	Rope, 304/303 (1.4301/1.4305) stainless steel, 78.7 in. (2000 mm) long, ø10-mm probe and ø4-mm rope	S	★
R6	Rope, 304/303 (1.4301/1.4305) stainless steel, 78.7 in. (2000 mm) long, ø10-mm probe, includes fixing hole and ø4-mm rope	S	★
R7	Rope, 316L/316 (1.4404/1.4401) stainless steel, 78.7 in. (2000 mm) long, ø10-mm probe and ø4-mm rope	S	★
R8	Rope, 316L/316 (1.4404/1.4401) stainless steel, 78.7 in. (2000 mm) long, ø10-mm probe, includes fixing hole and ø4-mm rope	S	★

Table 1: Rosemount 2555 Ordering Information (continued)

R9	Rope, 316L/316 (1.4404/1.4401) stainless steel, 78.7 in. (2000 mm) long, ø22-mm probe, ø8-mm rope	M, E, P, V	★
Sliding sleeve⁽⁶⁾		Profiles	
S1	Sliding sleeve	S, M, R, P	★
Extended product warranty			
WR5	5-year limited warranty		★
Typical model number: 2555 S D 1 5 NN G V A 00000 A 0000 NA			

- (1) This process connection size is not available when Materials of Construction codes G or V is selected.
- (2) This active probe length is not available when Materials of Construction codes F or U are selected.
- (3) The No Inactive Extension option is not available when Materials of Construction codes G or V is selected.
- (4) This product certification is available when Materials of Construction codes D or S are selected.
- (5) Contact your local Emerson representative for the availability of this option code.
- (6) The Sliding Sleeve option is not available when Materials of Construction codes G or V are selected.

Spares and accessories

The specification and selection of product materials, options, or components must be made by the purchaser of the equipment. See [Materials selection](#) for more information.

The starred offerings (★) represent the most common options and should be selected for best delivery. The non-starred offerings are subject to additional delivery lead time.

Table 2: Spares

Part number	Description	
02500-1000-0106	Electronics board: Relay DPDT, universal voltage	★
02500-7000-0001	Extension: Rigid 316L SST (1.4404), 15.7 in. (400 mm) long, Ø10 mm probe	★
02500-7000-0002	Extension: Rigid 316L SST (1.4404), 15.7 in. (400 mm) long, Ø22 mm probe	★
02500-7000-0003	Extension: Flexible 304/303 SST (1.4301/14305), 39.4 in. (1000 mm) long, Ø10 mm probe	★
02500-7000-0004	Extension: Rope 304/303 SST (1.4301/14305), 78.7 in. (2000 mm) long, Ø10 mm probe, Ø4 mm rope	★
02500-7000-0005	Extension: Rope 316L SST (1.4404), 78.7 in. (2000 mm) long, Ø10 mm probe, Ø4 mm rope	★
02500-7000-0006	Extension: Rope 316L SST (1.4404), 78.7 in. (2000 mm) long, Ø10 mm probe, Ø8 mm rope	★
02500-1000-0109	Standard Ø4 mm rope, 316 SST (1.4401), not coated, price per 39.4 in, (1000 mm)	★
02500-1000-0110	Standard Ø4 mm rope, 316 SST (1.4401), coated, price per 39.4 in, (1000 mm)	★
02500-1000-0111	Weight Ø22 mm for 4 mm rope, 304/303 SST (1.4301/14305), including fixings	★
02500-1000-0112	Weight Ø22 mm for 4 mm rope, 316L SST (1.4404), including fixings	★
02500-1000-0113	Rope holder Ø22 mm for 4 mm rope, 304/303 SST (1.4301/14305), including fixings	★
02500-1000-0114	Rope holder Ø22 mm for 4 mm rope, 316L SST (1.4404), including fixings	★
02500-1000-0115	Medium Ø8 mm rope, 316 SST (1.4401), not coated, price per 39.4 in, (1000 mm)	★
02500-1000-0116	Weight Ø35 mm for 8 mm rope, 304/303 SST (1.4301/14305), including fixings	★
02500-1000-0117	Weight Ø35 mm for 8 mm rope, 316L SST (1.4404), including fixings	★
02500-1000-0118	Rope holder Ø22 mm for 8 mm rope, 304/303 SST (1.4301/14305), including fixings	★
02500-1000-0119	Rope holder Ø22 mm for 8 mm rope, 316L SST (1.4404), including fixings	★
02500-1000-0056	1 off M32 x 1½ mm hexagon nut (kit), 303 SST (1.4305),	★
02500-1000-0121	1 off ¾-in. BSPP hexagon nut (kit), 303 SST (1.4305)	★
02500-1000-0058	1 off 1-in. BSPP hexagon nut (kit), 303 SST (1.4305)	★
02500-1000-0060	1 off M30 x 1½ mm hexagon nut (kit), 303 SST (1.4305)	★
02500-1000-0063	1 off 1½ in. BSPP hexagon nut (kit), 303 SST (1.4305)	★
02500-1000-0064	1 off 1¼ in. BSPP hexagon nut (kit), 303 SST (1.4305)	★
02500-1000-0126	Weather protection for housing	★

Table 3: Accessories

Part number	Description	
02500-7500-0003	Mounting kit 1 for DN100 PN6 and EN1092-1 flange with \varnothing 18 mm holes, containing: 4 off M16 x 60 mm screws (304-grade stainless steel) 4 off M16 nuts 4 off washers 1 off seal (non-food grade) for up to 464 °F (240 °C)	★
02500-7500-0006	Mounting kit 2 for DN100 PN6 and EN1092-1 flange with M16 threaded holes, containing: 4 off M16 x 40 mm screws (A2-grade stainless steel) 4 off M16 washers (A2-grade stainless steel) 1 off seal (non-food grade) for up to 464 °F (240 °C)	★
02500-7500-0009	Mounting kit 3 for DN100 PN16 and EN1092-1 flange with \varnothing 18 mm holes, containing: 8 off M16 x 60 mm screws (A2-grade stainless steel) 8 off M16 nuts (A2-grade stainless steel) 8 off M16 washers (A2-grade stainless steel) 1 off seal (non-food grade) for up to 464 °F (240 °C)	★
02500-7500-0012	Mounting kit 4 for DN100 PN16 and EN1092-1 flange with M16 threaded holes, containing: 8 off M16 x 40 mm screws (A2-grade stainless steel) 8 off M16 washers (A2-grade stainless steel) 1 off seal (non-food grade) for up to 464 °F (240 °C)	★
02500-7501-0001	Flat sealing gasket for 1-in. threaded process connection Maximum operating temperature of 464 °F (240 °C)	★

Specifications

Electrical data

Connection terminals	0.14 - 2.5 mm ² (AWG 26-14)
Cable entry	M20 × 1.5 screwed cable gland ½-in. NPT conduit connection Clamping range (diameter) of the factory provided cable glands: 0.24 to 0.47-in. (6 to 12 mm) for M20 × 1.5
Signal output delay	Configurable from 0.5 to 60 seconds.
Safety operation (FSL or FSH)	Configurable switches for each signal output. Select Fail Safe High (FSH) or Fail Safe Low (FSL) depending on application.
Operation frequency	100 kHz
Overvoltage category	II
Pollution degree	2 (inside housing)

Electronics

	Universal voltage Relay DPDT
Power supply	21 to 230 Vac (50/60 Hz) or Vdc ±10%* *includes ±10% from EN 61010
Maximum ripple of power supply	7 V _{ss} for dc supply
Maximum installed load	1.5 VA or 1.5 W
Signal output	Floating relay DPDT Maximum 250 Vac, 8 A (non-inductive) Maximum 30 Vdc, 5 A (non-inductive)
Display	Four digit LCD Displays actual measured capacitance, signal output state, and self diagnostics Lowest operating temperature: -22 °F (-30 °C)
Status indication	Tri-color built-in LED (according to NE44): Power on, signal output, failure/maintenance
Data storage	Non-volatile EPROM for configuration settings and calibration data.
Isolation	Power supply to signal output: 2225 Vrms Signal output to signal output: 2225 Vrms
Protection class	I

Mechanical data

Housing	<p>Aluminum housing, powder coated</p> <p>Seal between housing and lid: NBR</p> <p>Seal between housing and process connection: NBR</p> <p>Nameplate: polyester film</p>
Ingress protection	IP67 (EN 60529), NEMA® Type 4X
Process connection/probes	<p>Rosemount 2555S and 2555R</p> <p>Materials:</p> <p>Stainless steel 303/304 (1.4301/1.4305) or 316/316L (1.4401/1.4404) for rope</p> <p>Reinforced-PPS probe isolation</p> <p>FKM or FFKM probe gaskets</p> <p>PFA coating of probe/rope (optional)</p> <p>Thread: G (¾-in., 1-in., 1¼-in., or 1½-in.) DIN 228; M30 x 1.5, M32 x 1.5; NPT (¾-in. 1-in., 1¼-in., or 1½-in.) tapered ANSI B 1.20.1</p> <p>Tri Clamp: 1-in. (DN25), 1½-in. (DN40), or 2-in. (DN50) ISO 2852</p> <p>Rosemount 2555M and 2555P</p> <p>Materials:</p> <p>Stainless steel 303/304 (1.4301/1.4305) or 316/316L (1.4401/1.4404) for rope</p> <p>Reinforced-PPS probe isolation</p> <p>FKM or FFKM probe gaskets</p> <p>Thread: G (1¼-in. or 1½-in.) DIN 228; NPT (1¼-in. or 1½-in.) tapered ANSI B 1.20.1</p> <p>Rosemount 2555E and 2555V</p> <p>Materials:</p> <p>Stainless steel 303/304 (1.4301/1.4305) or 316/316L (1.4401/1.4404) for rope</p> <p>Ceramic probe isolation</p> <p>Graphite probe gaskets</p> <p>Thread: G (1¼-in. or 1½-in.) DIN 228; NPT (1¼-in. or 1½-in.) tapered ANSI B 1.20.1</p> <p>Other:</p> <p>Flanges according to selection, stainless steel 321 (1.4541) or 316L (1.4404)</p> <p>All materials are food grade.</p>
Maximum noise level	40 dBA
Overall weight (approximated)	See Table 4 .

Table 4: Overall Weight (Approximated)

Total weight = Basic weight + active probe length L1 + inactive length L2.

All weights with 1¼-in. NPT process connection and without flanges.

	Standard housing		
	Basic weight ⁽¹⁾	Active probe length: L1 ⁽²⁾	Inactive length: L2 ⁽²⁾
Rosemount 2555S rod version	3.7 lbs (1.7 kg)	1.37 lbs per 39.3 in. (+0.62 kg per m)	2.65 lbs per 39.3 in. (+1.2 kg per m)

Table 4: Overall Weight (Approximated) (continued)

	Standard housing		
	Basic weight ⁽¹⁾	Active probe length: L1 ⁽²⁾	Inactive length: L2 ⁽²⁾
Rosemount 2555R rope version	5.1 lbs (2.3 kg)	0.13 lbs per 39.3 in. (+0.06 kg per m)	2.65 lbs per 39.3 in. (+1.2 kg per m)
Rosemount 2555M rod version	6.2 lbs (2.8 kg)	6.61 lbs per 39.3 in. (+3.0 kg per m)	7.19 lbs per 39.3 in. (+3.26 kg per m)
Rosemount 2555P rope version	8.8 lbs (4.0 kg)	0.57 lbs per 39.3 in. (+0.26 kg per m)	7.19 lbs per 39.3 in. (+3.26 kg per m)
Rosemount 2555E rod version	8.0 lbs (3.6 kg)	6.61 lbs per 39.3 in. (+3.0 kg per m)	7.19 lbs per 39.3 in. (+3.26 kg per m)
Rosemount 2555V rope version	11 lbs (4.8 kg)	0.57 lbs per 39.3 in. (+0.26 kg per m)	7.19 lbs per 39.3 in. (+3.26 kg per m)

(1) Rod version with shortest length L1=3.9 in. (100 mm), and rope version without rope.

(2) See *Dimensional drawings*.

Operating conditions

Ambient temperature (housing) -40 to +158 °F (-40 to +70 °C)

Process temperature Rosemount 2555S, 2555R, 2555M and 2555P: -40 to +464 °F (-40 to +240 °C)

Rosemount 2555E or 2555V: -40 to +932 °F (-40 to +500 °C); versions with Ex-approvals: +833 °F (+445 °C)

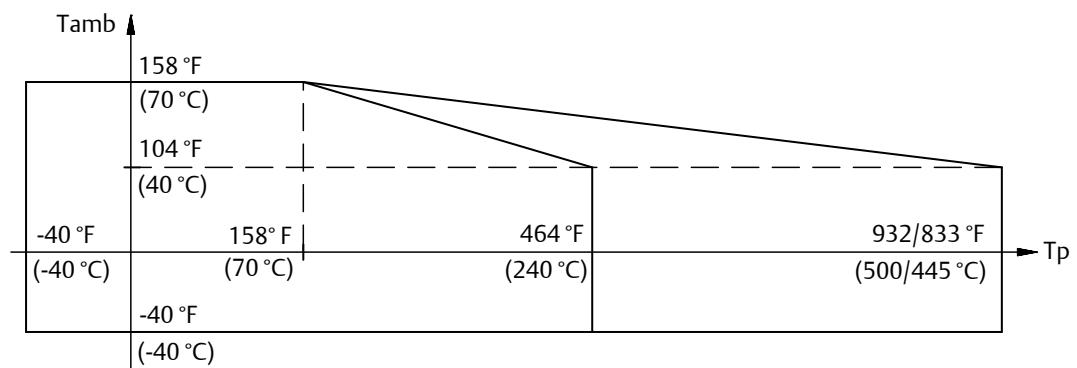

For versions with Ex-approvals: see also [Product Certifications](#).

Ventilation Ventilation is not required.

Maximum range and sensitivity 3 to 100 pF, 0.5 pF
3 to 400 pF, 2 pF

Spark protection Robust built-in protection against static-electricity discharge from the bulk materials.

Bulk material restrictions

Dielectric constants (DK values) > 1.5

Maximum mechanical load

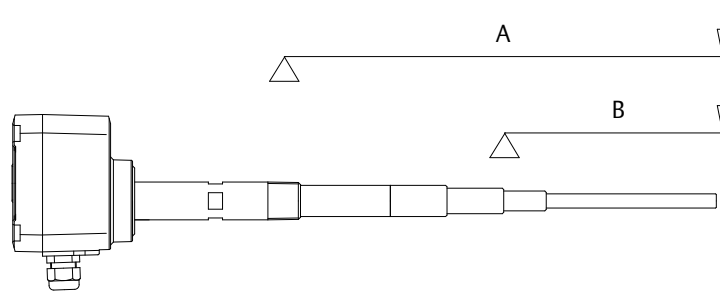

Note

All ratings are for 104 °F (40 °C).

Rosemount 2555S	Rod version:	A: 125 Nm	B: 20 Nm
Rosemount 2555R	Rope version:	4 kN tensile load	
Rosemount 2555M	Rod version:	A: 525 Nm	B: 90 Nm
Rosemount 2555P	Rope version:	40 kN tensile load	
Rosemount 2555E	Rod version:	A: 525 Nm	B: 20 Nm
Rosemount 2555V	Rope version:	10 kN tensile load	

Maximum process pressure

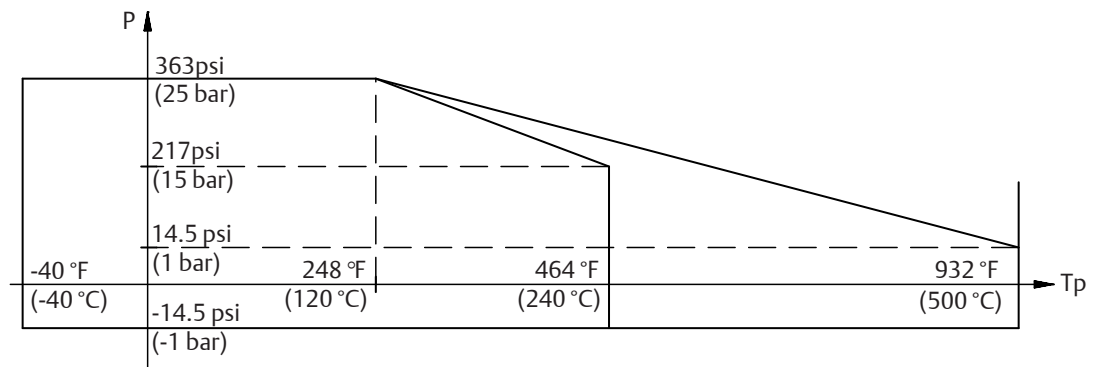

The maximum process pressure may be reduced when flanges are used. Refer to the flange standards for pressure ratings and pressure de-ratings with higher temperatures.

For versions with Ex-approvals: see also [Product Certifications](#).

Vibration

1.5 (m/s²)²/ Hz according to EN 60068-2-64

Relative Humidity

0 to 100%, suitable for outdoor use

Maximum altitude

6562 ft. (2000 m)

Expected product lifetime

The following parameters have a negative influence on the expected product lifetime:

High ambient- and process temperatures, corrosive environments, high plant vibrations, and high flow rate of abrasive bulk.

Transport and storage

Transport

Refer to the instructions as stated on the transport packaging, otherwise the products may get damaged.

Transport temperature: -40 to +176 °F (-40 to +80 °C)

Transport humidity: 20 to 85%

Always inspect the received goods for any damage occurred during shipment from the factory. Notify Emerson of damaged goods as soon as possible.

Storage

Products must be stored at a dry and clean place. They must be protected from influence of corrosive environments, vibrations, and exposure to direct sunlight.

Storage temperature: -40 to +176 °F (-40 to +80 °C)

Storage humidity: 20 to 85%

Product certifications

European Union directive information

A copy of the EU Declaration of Conformity can be found at the end of the Rosemount 2555 [Product Certifications document](#). The most recent revision of the EU Declaration of Conformity can be found at Emerson.com/Rosemount.

Ordinary location certification

As standard, the level switch has been examined and tested to determine that the design meets the basic electrical, mechanical, and fire protection requirements by a nationally recognized test laboratory (NRTL) as accredited by the Federal Occupational Safety and Health Administration (OSHA).

Installing equipment in North America

The US National Electrical Code® (NEC) and the Canadian Electrical Code (CEC) permit the use of Division marked equipment in Zones and Zone marked equipment in Divisions. The markings must be suitable for the area classification, gas, and temperature class. This information is clearly defined in the respective codes.

U.S.A.

U.S.A. Dust certification

NL

Summary of product certification

Protection	Dust-ignition proof
Project ID	3053298
Standards	FM Class 3600:2011 FM Class 3616:2011 FM Class 3810:2005 ANSI/ISA 61010:2012 ANSI/ISA 60079-0:2013 ANSI/ISA 60079-11:2013 ANSI/NEMA® 250:1991 ANSI/IEC 60529:2004
Markings	DIP-IS Class II,III Division 1 Groups E, F, G T4A T _(amb) = -40 °C to +70 °C Enclosure IP67, Type 4 or Type 4X

U.S.A. Ordinary Location certification

KZ

Summary of product certification:

Protection	Ordinary location (unclassified, safe area)
Project ID	3053298
Standards	FM Class 3810:2005 ANSI/ISA 61010:2012 ANSI/ISA 60079-11:2013 ANSI/NEMA® 250:1991 ANSI/IEC 60529:2004
Markings	Type 4/4X, IP67

Canada

Canada Ordinary Location certification

KZ

Summary of product certification

Protection	Ordinary location (unclassified, safe area)
Project ID	3053298
Standards	CSA-C22.2 No. 94:R2011 CSA-C22.2 No. 60529:R2010 CSA-C22.2 No. 61010-1:2012
Markings	Type 4/4X, IP67

Europe

ATEX Dust certification

ND

Summary of product certification

Protection	By enclosure
Certificate	BVS 19 ATEX E 073
Standards	EN60079-0:2012/A11:2013 EN 60079-11:2012 EN 60079-31:2014
Markings	⊕ II 1/2 D Ex ia/tb IIIC T* Da/Db
Temperature	See Table 5

Table 5: Thermal data

Maximum ambient temperature	Maximum process temperature	Maximum surface temperature
70 °C	<= 80 °C	120 °C
	<= 120 °C	(1)
	<= 240 °C	(1)
	<= 445 °C ⁽²⁾	(1)

(1) Maximum surface temperature is identical to the maximum process temperature.

(2) Available only when Probe Thermal Profile code E is selected.

Permitted ambient temperature at the electronics enclosure:

- $-40\text{ °C} \leq T_{\text{Amb}} \leq +70\text{ °C}$

The maximum surface temperature is limited to 120 °C by a thermal fuse.

Permitted temperature at sensor extension, process connection:

- -40 to 240 °C (when Probe Thermal Profile code S, M, R or P is selected.)
- -40 to 445 °C (when Probe Thermal Profile code E or V is selected.)

International

IECEX Dust certification

NK

Summary of product certification

Protection	By enclosure
Certificate	IECEX BVS 19.0069
Standards	IEC 60079-0:2011
	EN 60079-11:2011
	IEC 60079-31:2013
Markings	IEC Ex ia/tb IIIC T* Da/Db
Temperature	See Table 6

Table 6: Thermal data

Maximum ambient temperature	Maximum process temperature	Maximum surface temperature
70 °C	<= 80 °C	120 °C
	<= 120 °C	(1)
	<= 240 °C	(1)
	<= 445 °C ⁽²⁾	(1)

(1) Maximum surface temperature is identical to the maximum process temperature.

(2) Available only when Probe Thermal Profile code E is in the model number.

The maximum surface temperature is limited to 120 °C by a thermal fuse.

Permitted temperature at sensor extension, process connection:

- -40 to 240 °C (when Probe Thermal Profile code S, M, R or P is selected.)
- -40 to 445 °C (when Probe Thermal Profile code E or V is selected.)

Dimensional drawings

Figure 1: Rosemount 2555 Capacitance Probe Level Switch (Thermal Profile code S)

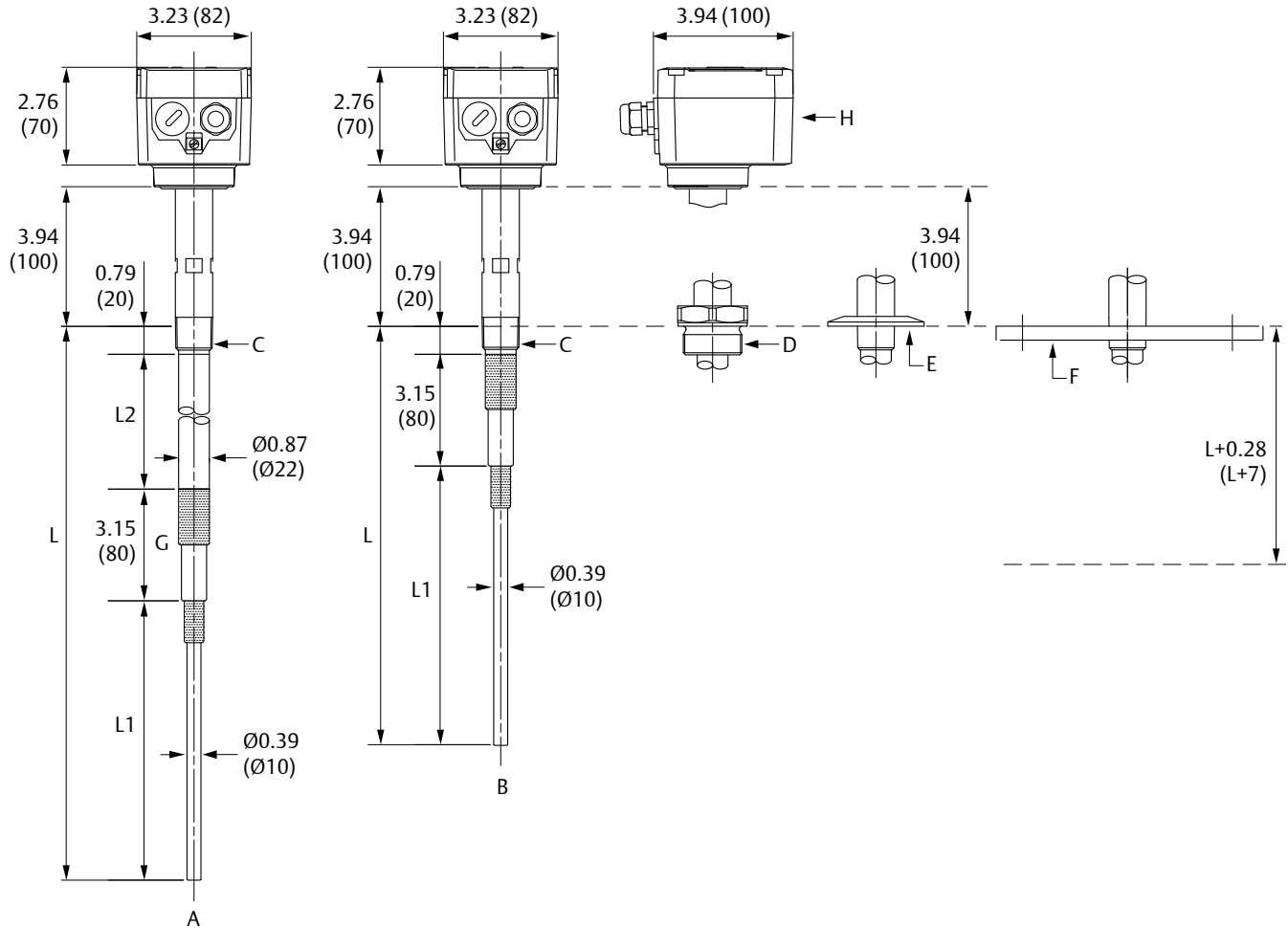

- A. Rod version, inactive extension
- B. Rod version, shortest length
- C. G $\frac{3}{4}$ -in. or $\frac{3}{4}$ -in. NPT threaded process connection
- D. G1 $\frac{1}{2}$ -in., G1 $\frac{1}{4}$ -in., G1-in., M32x1.5, M30x1.5, 1 $\frac{1}{2}$ -in. NPT, 1 $\frac{1}{4}$ -in. NPT, 1-in. NPT threaded process connection
- E. 1-in. or 2-in. Tri Clamp process connection
- F. Flanged process connections - various sizes
- G. Active shield
- H. Aluminum housing with M20 or $\frac{1}{2}$ -in. conduit/cable entries

Dimensions are in inches (millimeters).

See Table 7 for L, L1, and L2 dimensions.

Table 7: Dimensions L1 and L2 for Rosemount 2555 with Thermal Profile code S

L1: Active probe (standard length)	L1: Active probe (customer length)		L2: Inactive extension length	
	Minimum	Maximum	Minimum	Maximum
3.94 in. (100 mm)	1.97 in. (50 mm)	78.74 in. (2000 mm)	1.97 in. (50 mm)	94.49 in. (2400 mm) - L1
7.87 in. (200 mm)				
11.81 in. (300 mm)				

Note

Length L = L1 + L2 + 3.94-in. (100 mm)

Minimum L length is 5.91-in. (150 mm)

Maximum L length is 98.4-in. (2500 mm)

Inactive extension: the active probe shall have at least 1.97 in. (50 mm) distance to the silo wall.

Figure 2: Rosemount 2555 Capacitance Probe Level Switch (Thermal Profile code R)

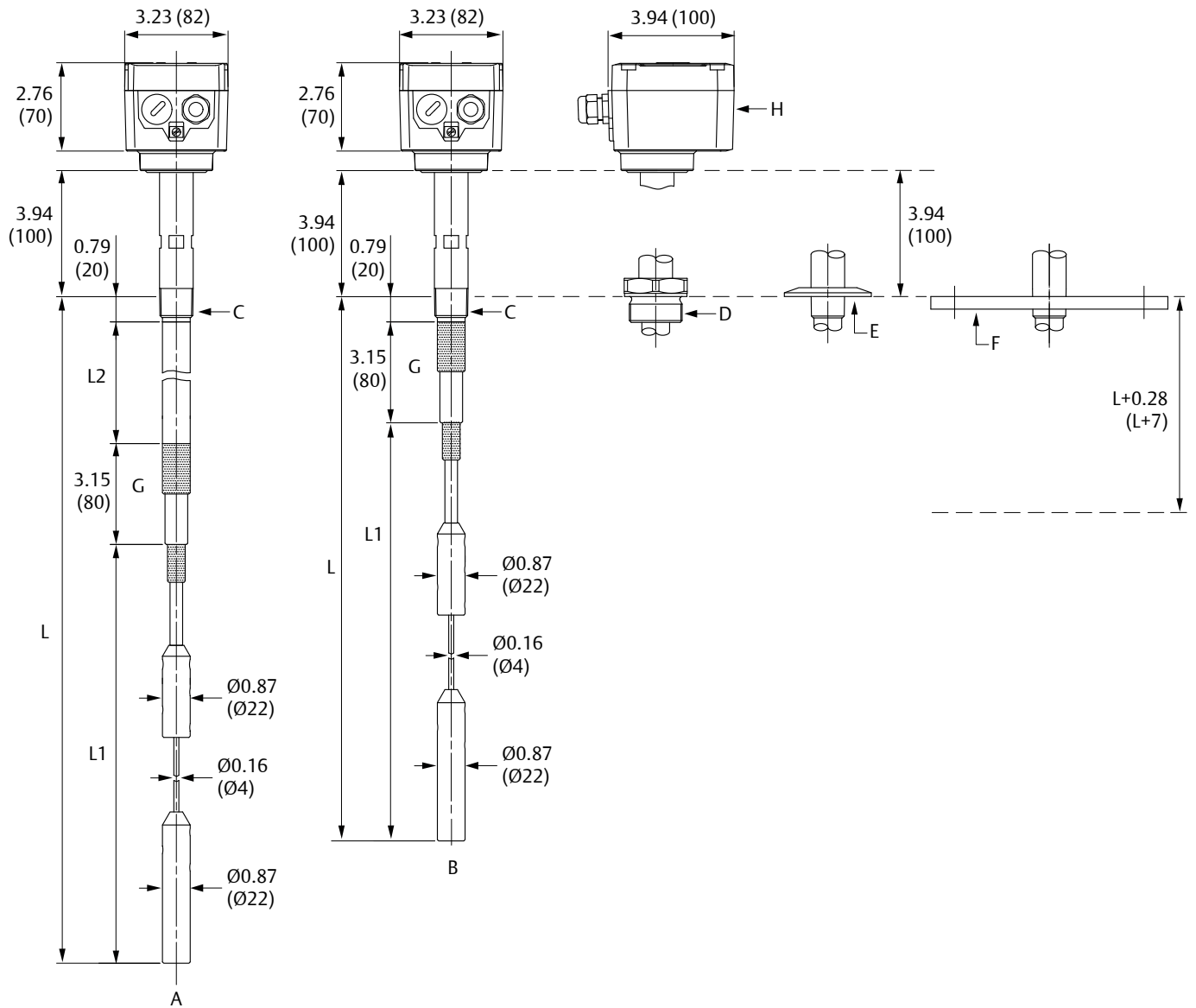

- A. Rope version, inactive extension
- B. Rope version, shortest length
- C. G 3/4-in. or 3/4-in. NPT threaded process connection
- D. G 1 1/2-in., G 1 1/4-in., G 1-in., M32x1.5, M30x1.5, 1 1/2-in. NPT, 1 1/4-in. NPT, 1-in. NPT threaded process connection
- E. 1-in. or 2-in. Tri Clamp process connection
- F. Flanged process connections - various sizes
- G. Active shield
- H. Aluminum housing with M20 or 1/2-in. conduit/cable entries

Dimensions are in inches (millimeters). See Table 8 for L, L1, and L2 dimensions.

Table 8: Dimensions L1 and L2 for Rosemount 2555 with Thermal Profile code R

L1: Active probe (customer length)		L2: Inactive extension length	
Minimum	Maximum	Minimum	Maximum
13.77 in. (350 mm)	787.4 in. (20000 mm)	1.97 in. (50 mm)	74.8 in. (1900 mm)

Note

Length L = L1 + L2 + 3.94-in. (100 mm)

Minimum L length is 17.7-in. (450 mm)

Maximum L length is 866.1-in. (22000 mm)

Inactive extension: the active probe shall have at least 1.97 in. (50 mm) distance to the silo wall.

Figure 3: Rosemount 2555 Capacitance Probe Level Switch (Thermal Profile code M)

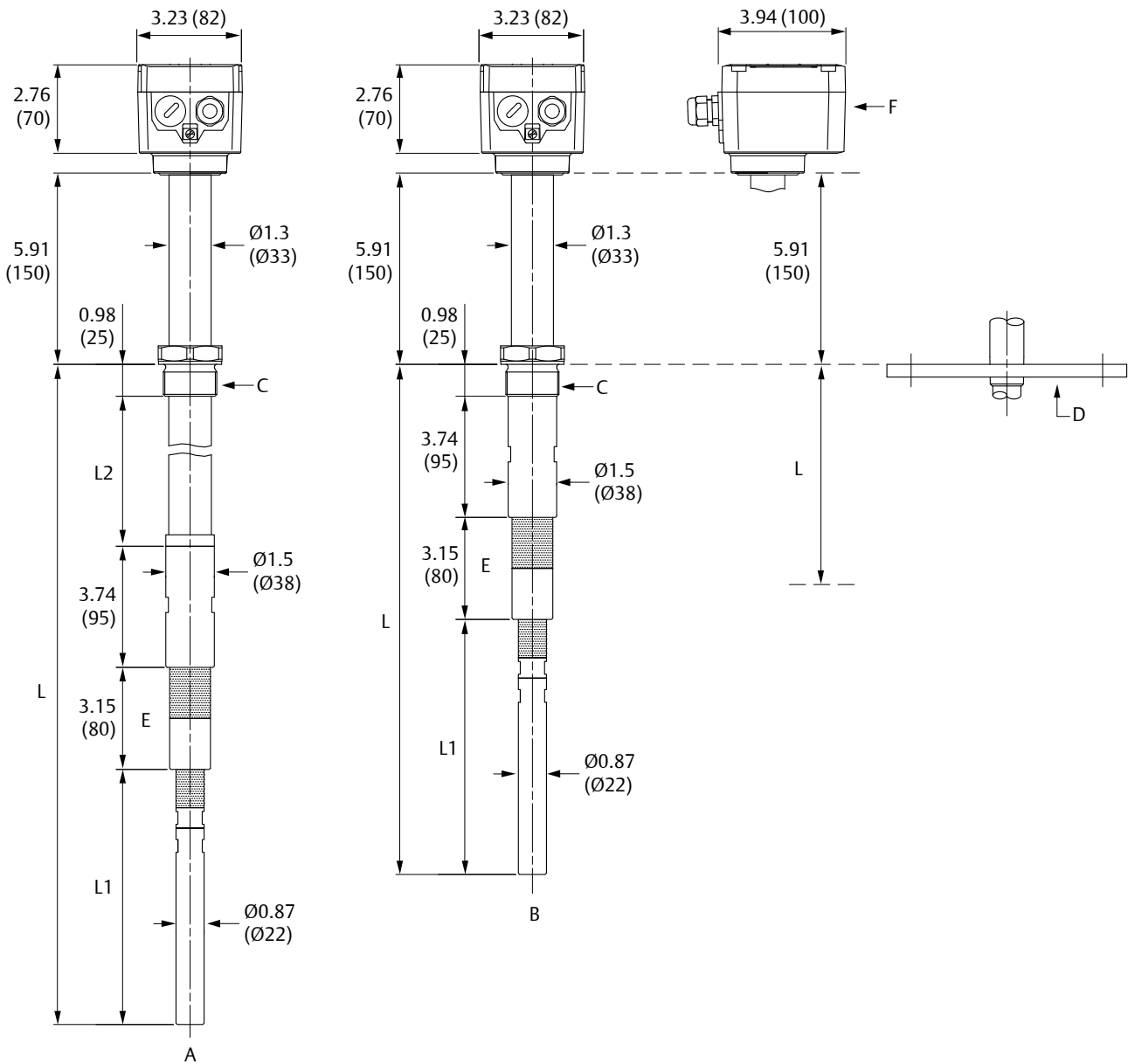

- A. Rod version, inactive extension
- B. Rod version, shortest length
- C. G1½-in., G1¼-in., 1½-in. NPT or 1¼-in. NPT threaded process connection
- D. Flanged process connections - various sizes
- E. Active shield
- F. Aluminum housing with M20 or ½-in. conduit/cable entries

Dimensions are in inches (millimeters). See Table 9 for L, L1, and L2 dimensions.

Table 9: Dimensions L1 and L2 for Rosemount 2555 with Thermal Profile code M

L1: Active probe (standard length)	L1: Active probe (customer length)		L2: Inactive extension length	
	Minimum	Maximum	Minimum	Maximum
3.94 in. (100 mm)	3.94 in. (100 mm)	78.74 in. (2000 mm)	3.94 in. (100 mm)	90.55 in. (2300 mm) - L1
7.87 in. (200 mm)				
11.81 in. (300 mm)				

Note

Length L = L1 + L2 + 7.87-in. (200 mm)

Minimum L length is 11.81-in. (300 mm)

Maximum L length is 98.4-in. (2500 mm)

Inactive extension: the active probe shall have at least 1.97 in. (50 mm) distance to the silo wall.

Figure 4: Rosemount 2555 Capacitance Probe Level Switch (Thermal Profile code P)

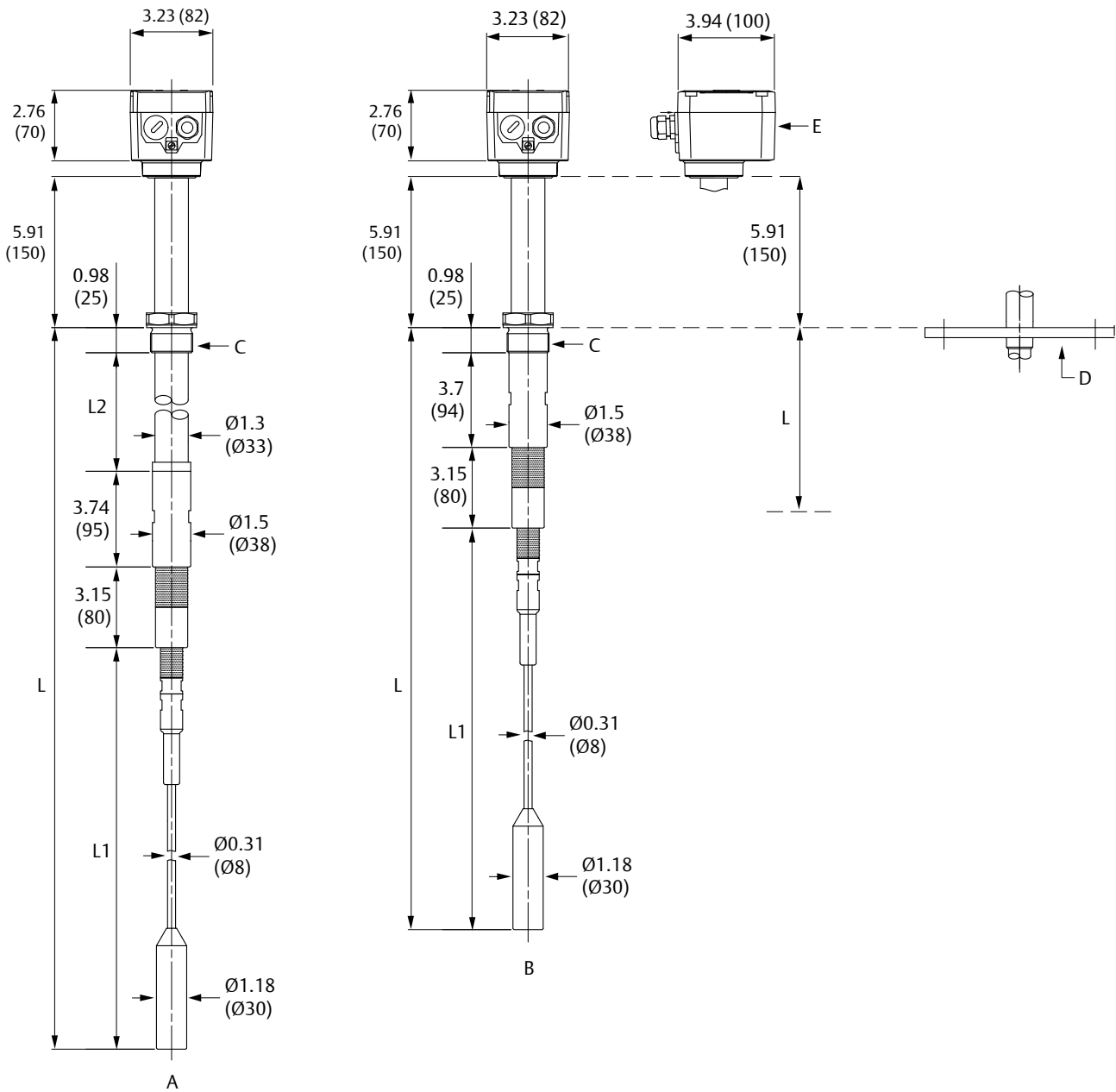

- A. Rope version, inactive extension
- B. Rope version, shortest length
- C. G1½-in., G1¼-in., 1½-in. NPT or 1¼-in. NPT threaded process connection
- D. Flanged process connections - various sizes
- E. Aluminum housing with M20 or ½-in. conduit/cable entries

Dimensions are in inches (millimeters). See Table 10 for L, L1, and L2 dimensions.

Table 10: Dimensions L1 and L2 for Rosemount 2555 with Thermal Profile code P

L1: Active probe (customer length)		L2: Inactive extension length	
Minimum	Maximum	Minimum	Maximum
13.78 in. (350 mm)	787.4 in. (20000 mm)	3.94 in. (100 mm)	70.87 in. (1800 mm)

Note

Length L = L1 + L2 + 7.87-in. (200 mm)

Minimum L length is 21.65-in. (550 mm)

Maximum L length is 866.1-in. (22000 mm)

Inactive extension: the active probe shall have at least 1.97 in. (50 mm) distance to the silo wall.

Maximum process temperature for Ex-approved versions is limited to 445 °C.

Figure 5: Rosemount 2555 Capacitance Probe Level Switch (Thermal Profile code E)

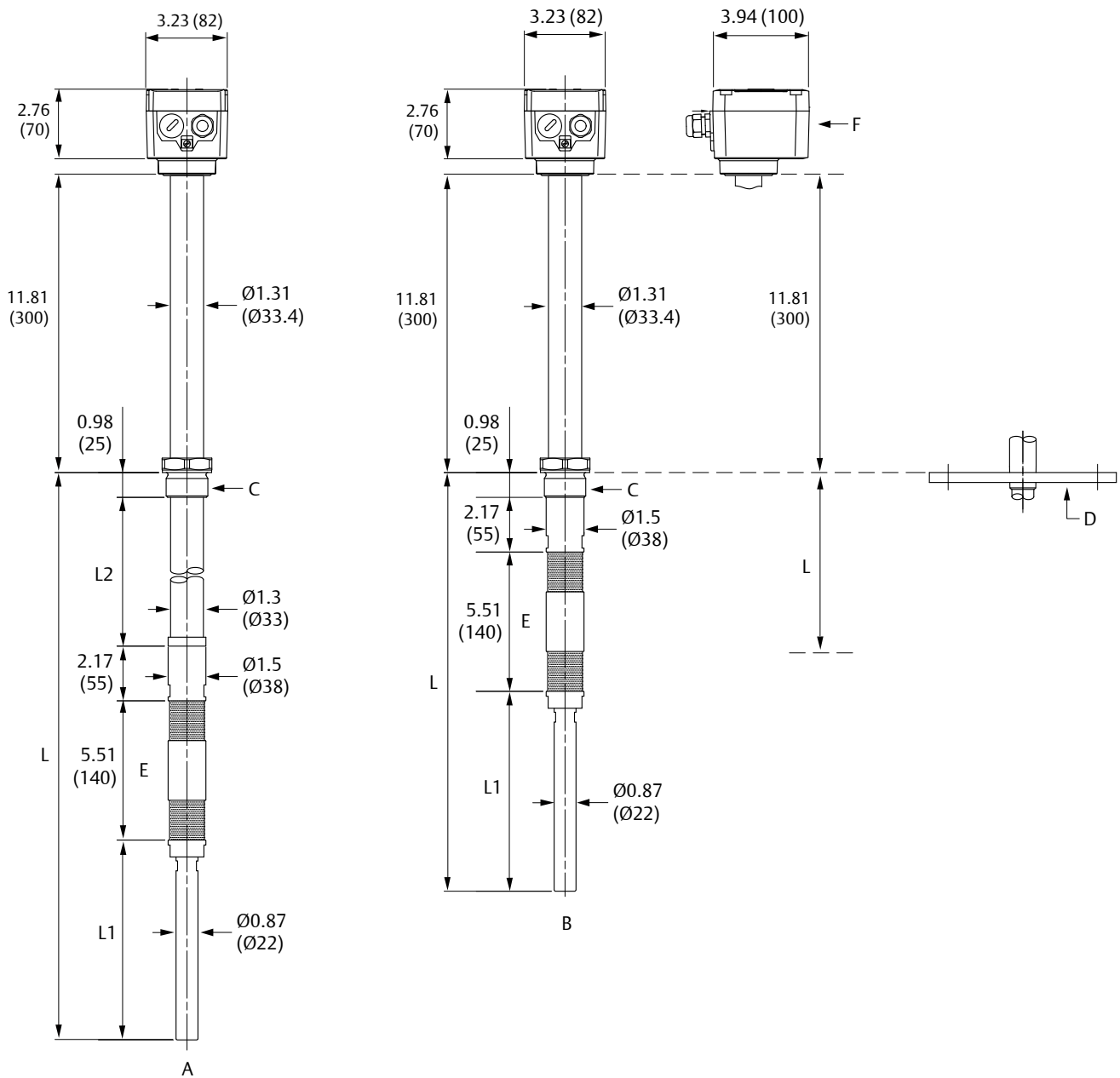

- A. Rod version, inactive extension
- B. Rod version, shortest length
- C. G1½-in., G1¼-in., 1½-in. NPT or 1¼-in. NPT threaded process connection
- D. Flanged process connections - various sizes
- E. Active shield
- F. Aluminum housing with M20 or ½-in. conduit/cable entries

Dimensions are in inches (millimeters). See Table 11 for L, L1, and L2 dimensions.

Table 11: Dimensions L1 and L2 for Rosemount 2555 with Thermal Profile code E

L1: Active probe (standard length)	L1: Active probe (customer length)		L2: Inactive extension length	
	Minimum	Maximum	Minimum	Maximum
3.94 in. (100 mm)	3.94 in. (100 mm)	39.7 in. (1000 mm)	3.94 in. (100 mm)	90.55 in. (2300 mm) - L1
7.87 in. (200 mm)				
11.81 in. (300 mm)				

Note

Length L = L1 + L2 + 8.66-in. (220 mm)

Minimum L length is 12.6-in. (320 mm)

Maximum L length is 99.2-in. (2520 mm)

Inactive extension: the active probe shall have at least 1.97 in. (50 mm) distance to the silo wall.

Maximum process temperature for Ex-approved versions is limited to 445 °C.

Figure 6: Rosemount 2555 Capacitance Probe Level Switch (Thermal Profile code V)

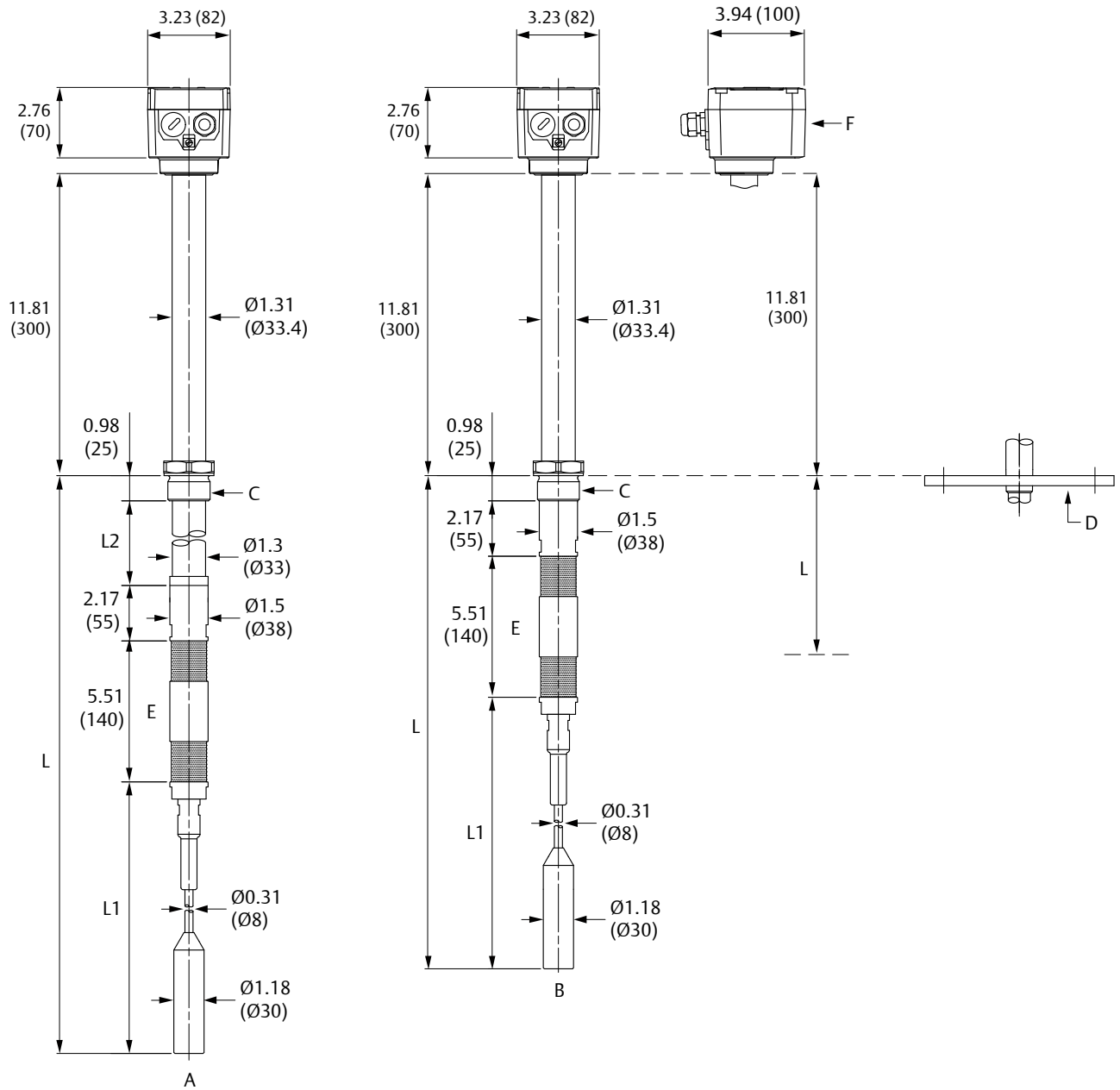

- A. Rope version, inactive extension
- B. Rope version, shortest length
- C. G1 1/2-in., G1 1/4-in., 1 1/2-in. NPT or 1 1/4-in. NPT threaded process connection
- D. Flanged process connections - various sizes
- E. Aluminum housing with M20 or 1/2-in. conduit/cable entries

Dimensions are in inches (millimeters). See Table 12 for L, L1, and L2 dimensions.

Table 12: Dimensions L1 and L2 for Rosemount 2555 with Thermal Profile code V

L1: Active probe (customer length)		L2: Inactive extension length	
Minimum	Maximum	Minimum	Maximum
13.78 in. (350 mm)	787.4 in. (20000 mm)	3.94 in. (100 mm)	70.87 in. (1800 mm)

Note

Length L = L1 + L2 + 8.66-in. (220 mm)

Minimum L length is 22.4-in. (570 mm)

Maximum L length is 886.9-in. (22020 mm)

Inactive extension: the active probe shall have at least 1.97 in. (50 mm) distance to the silo wall.

Maximum process temperature for Ex-approved versions is limited to 445 °C.

Selecting active probe length

The correct selection of an active probe length (L1) is necessary to get a satisfactory change of capacitance between an uncovered and covered probe (see recommendations in Table 13). If these recommendations are observed, the standard sensitivity of 2 pF can be achieved in most cases.

Figure 7: Level Switch Switchpoint

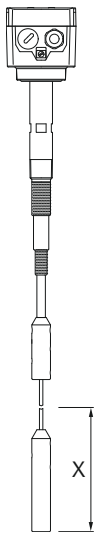

Table 13: Active Probe Length Recommendations

DK	Length L1 (horizontal mounting) ⁽¹⁾	Switchpoint X ⁽²⁾
<1.5	n.a.	n.a.
≥1.6	≥11.8 in. (300 mm)	≤11.8 in. (300 mm)
≥1.8	≥7.9 in. (200 mm)	≤7.9 in. (200 mm)
≥2.2	≥3.9 in. (100 mm)	≤3.9 in. (100 mm)
≥10	≥2.0 in. (50 mm)	≤2.0 in. (50 mm)

(1) With stated L1 the unit works with factory set sensitivity (2 pF).

(2) The table states the switchpoint with factory set sensitivity (2 pF).

Global Headquarters

Emerson Automation Solutions
6021 Innovation Blvd.
Shakopee, MN 55379, USA

📞 +1 800 999 9307 or +1 952 906 8888
☎ +1 952 204 8889
✉ RFQ.RMD-RCC@Emerson.com

North America Regional Office

Emerson Automation Solutions
8200 Market Blvd.
Chanhassen, MN 55317, USA

📞 +1 800 999 9307 or +1 952 906 8888
☎ +1 952 204 8889
✉ RMT-NA.RCCRFQ@Emerson.com

Latin America Regional Office

Emerson Automation Solutions
1300 Concord Terrace, Suite 400
Sunrise, FL 33323, USA

📞 +1 954 846 5030
☎ +1 954 846 5121
✉ RFQ.RMD-RCC@Emerson.com

Europe Regional Office

Emerson Automation Solutions Europe
GmbH
Neuhofstrasse 19a P.O. Box 1046
CH 6340 Baar
Switzerland

📞 +41 (0) 41 768 6111
☎ +41 (0) 41 768 6300
✉ RFQ.RMD-RCC@Emerson.com

Asia Pacific Regional Office

Emerson Automation Solutions
1 Pandan Crescent
Singapore 128461

📞 +65 6777 8211
☎ +65 6777 0947
✉ Enquiries@AP.Emerson.com

Middle East and Africa Regional Office

Emerson Automation Solutions
Emerson FZE P.O. Box 17033
Jebel Ali Free Zone - South 2
Dubai, United Arab Emirates

📞 +971 4 8118100
☎ +971 4 8865465
✉ RFQ.RMTMEA@Emerson.com

 [Linkedin.com/company/Emerson-Automation-Solutions](https://www.linkedin.com/company/Emerson-Automation-Solutions)

 [Twitter.com/Rosemount_News](https://twitter.com/Rosemount_News)

 [Facebook.com/Rosemount](https://www.facebook.com/Rosemount)

 [Youtube.com/user/RosemountMeasurement](https://www.youtube.com/user/RosemountMeasurement)

©2020 Emerson. All rights reserved.

Emerson Terms and Conditions of Sale are available upon request. The Emerson logo is a trademark and service mark of Emerson Electric Co. Rosemount is a mark of one of the Emerson family of companies. All other marks are the property of their respective owners.