

FLUKE®

287/289
True-rms Digital Multimeters

Users Manual

June 2007, Rev. 2, 3/09

© 2007, 2008 Fluke Corporation. All rights reserved. Specifications subject to change without notice.
All product names are trademarks of their respective companies.

Lifetime Limited Warranty

Each Fluke 20, 70, 80, 170, 180 and 280 Series DMM will be free from defects in material and workmanship for its lifetime. As used herein, "lifetime" is defined as seven years after Fluke discontinues manufacturing the product, but the warranty period shall be at least ten years from the date of purchase. This warranty does not cover fuses, disposable batteries, damage from neglect, misuse, contamination, alteration, accident or abnormal conditions of operation or handling, including failures caused by use outside of the product's specifications, or normal wear and tear of mechanical components. This warranty covers the original purchaser only and is not transferable.

For ten years from the date of purchase, this warranty also covers the LCD. Thereafter, for the lifetime of the DMM, Fluke will replace the LCD for a fee based on then current component acquisition costs.

To establish original ownership and prove date of purchase, please complete and return the registration card accompanying the product, or register your product on <http://www.fluke.com>. Fluke will, at its option, repair at no charge, replace or refund the purchase price of a defective product purchased through a Fluke authorized sales outlet and at the applicable international price. Fluke reserves the right to charge for importation costs of repair/replacement parts if the product purchased in one country is sent for repair elsewhere.

If the product is defective, contact your nearest Fluke authorized service center to obtain return authorization information, then send the product to that service center, with a description of the difficulty, postage and insurance prepaid (FOB Destination). Fluke assumes no risk for damage in transit. Fluke will pay return transportation for product repaired or replaced in-warranty. Before making any non-warranty repair, Fluke will estimate cost and obtain authorization, then invoice you for repair and return transportation.

THIS WARRANTY IS YOUR ONLY REMEDY. NO OTHER WARRANTIES, SUCH AS FITNESS FOR A PARTICULAR PURPOSE, ARE EXPRESSED OR IMPLIED. FLUKE SHALL NOT BE LIABLE FOR ANY SPECIAL, INDIRECT, INCIDENTAL OR CONSEQUENTIAL DAMAGES OR LOSSES, INCLUDING LOSS OF DATA, ARISING FROM ANY CAUSE OR THEORY. AUTHORIZED RESELLERS ARE NOT AUTHORIZED TO EXTEND ANY DIFFERENT WARRANTY ON FLUKE'S BEHALF. Since some states do not allow the exclusion or limitation of an implied warranty or of incidental or consequential damages, this limitation of liability may not apply to you. If any provision of this warranty is held invalid or unenforceable by a court or other decision-maker of competent jurisdiction, such holding will not affect the validity or enforceability of any other provision.

Fluke Corporation
P.O. Box 9090
Everett, WA 98206-9090
U.S.A.

Fluke Europe B.V.
P.O. Box 1186
5602 BD Eindhoven
The Netherlands

Table of Contents

Title	Page
Lifetime Limited Warranty.....	ii
Introduction	1
Contacting Fluke	1
Safety Information	1
Hazardous Voltage.....	3
Symbols	4
Features	5
Understanding the Push Buttons	5
Using Auto Repeat	6
Understanding the Display	7
Bar Graph	8
Status Bar Elements	8
Page Area.....	9
Softkey Labels	9
Adjusting Display Contrast.....	9
Understanding the Rotary Switch	10
Using the Input Terminals.....	11
Controlling Meter Power.....	12

Powering the Meter On and Off Manually	12
Battery Level Indicator	12
Automatic Power-Off	12
Battery Saver Mode	12
Controlling the Backlight	13
Selecting the Range	13
Understanding Function Menus	13
Input Alert™ Feature.....	15
Using the Info Button	15
Hold and AutoHold Mode.....	15
Measuring Crest Factor	16
Capturing Minimum and Maximum Values	16
Capturing Peak Values	18
Low Pass Filter (Model 289 only).....	20
Making Relative Measurements.....	21
Making Measurements.....	22
Measuring AC Voltage	22
Using LoZ for Voltage Measurements (Model 289 only)	23
Making dB Measurements	23
Measuring DC Voltage	25
Measuring AC and DC Signals	26
Measuring Temperature.....	28
Using the 50Ω Function (Model 289 Only)	31
Testing for Continuity	31
Using Conductance for High Resistance Tests.....	34
Measuring Capacitance	35
Testing Diodes.....	36
Measuring Current	38

Measuring Frequency	42
Measuring Duty cycle	43
Measuring Pulse Width	45
Changing Meter Setup Options	47
Resetting Meter Setup Options	47
Setting Display Contrast	47
Setting the Meter's Language	47
Setting Date and Time	48
Setting Backlight and Auto Off Timeouts	48
Setting a Custom dBm Reference	48
Disabling and Enabling the Beeper	48
Enabling and Disabling the Smoothing Mode	49
Using Other Setup Options	49
Using Memory	49
Storing Individual Measurement Data	49
Naming Saved Data	49
Viewing Memory Data	50
Viewing Snapshot and Summary Data	50
Viewing Trend Data	50
Zooming in on Trend Data	51
Deleting Stored Measurement Data	51
Recording Measurement Data	52
Setting up a Recording Session	53
Setting the Event Threshold Value	54
Starting a Recording Session	54
Stopping a Recording Session	54
Using Communications	55
Error Messages	56

Maintenance	57
General Maintenance	57
Testing the Fuses.....	57
Replacing the Batteries	59
Replacing the Fuses	59
Test Lead Storage.....	59
In Case of Difficulty	61
Service and Parts	62
General Specifications	66
Detailed Specifications.....	67
AC Voltage Specifications	68
AC Current Specifications	69
DC Voltage Specification	70
DC Current Specifications	71
Resistance Specifications	72
Temperature Specifications	72
Capacitance and Diode Test Specifications	73
Frequency Counter Specifications	74
Frequency Counter Sensitivity	75
MIN MAX, Recording, and Peak Specifications	76
Input Characteristics	77
Burden Voltage (A, mA, μ A).....	78

List of Tables

Table	Title	Page
1.	Symbols.....	4
2.	Push Buttons.....	5
3.	Display Features.....	7
4.	Rotary Switch Positions.....	10
5.	Input Terminals.....	11
6.	Battery Level Indicator.....	12
7.	Trend Data Display.....	51
8.	Recording Display.....	53
9.	Stopped Recording Display.....	55
10.	Error Messages.....	56
11.	Replacement Parts.....	62
12.	Accessories.....	65

List of Figures

Figure	Title	Page
1.	Push Buttons	5
2.	Display Features	7
3.	Rotary Switch	10
4.	Input Terminals.....	11
5.	Function Menu.....	14
6.	MIN MAX Record Display.....	17
7.	Peak Record Display.....	18
8.	Low Pass Filter.....	20
9.	Relative Mode Functions.....	21
10.	AC Voltage Measurements.....	22
11.	dBm Display.....	23
12.	DC Voltage Measurements.....	25
13.	AC and DC Display.....	26
14.	Temperature Measurement.....	28
15.	Resistance Measurement.....	30
16.	Continuity Indicator.....	31
17.	Continuity Testing.....	32

18.	Conductance Measurement	34
19.	Capacitance Measurement	35
20.	Diode Testing.....	37
21.	Current Measurement Setup.....	40
22.	Current Measurement Circuit Connection	41
23.	Functions Allowing Frequency Measurement	42
24.	Frequency Display	43
25.	Duty Cycle Measurements	44
26.	Duty Cycle Display	45
27.	Pulse Width Measurements	46
28.	Testing the Current Fuses.....	58
29.	Test Lead Storage	59
30.	Replacing Batteries and Fuses	60
31.	Replaceable Parts.....	64

Introduction

Warning

Read “Safety Information” before using this Meter.

The descriptions and instructions in this manual apply to the model 289 and model 287 True-rms Digital Multimeters (hereafter referred to as the Meter). The model 289 appears in all illustrations.

Contacting Fluke

To contact Fluke, call:

USA: 1-888-993-5853

Canada : 1-800-363-5853

Europe : +31 402-675-200

Japan: +81-3-3434-0181

Singapore : +65-738-5655

Anywhere in the world: +1-425-446-5500

Visit Fluke’s web site at: www.fluke.com

Register your Meter at: <http://register.fluke.com>

To view, print, or download the latest manual supplement, visit <http://us.fluke.com/usen/support/manuals>.

Safety Information

The Meter complies with:

- ANSI/ISA 82.02.01 (61010-1) 2004
- UL 61010B (2003)
- CAN/CSA-C22.2 No. 61010-1-04
- IEC/EN 61010-1 2nd Edition Pollution Degree 2
- EMC EN 61326-1
- Measurement Category III, 1000V, Pollution Degree 2
- Measurement Category IV, 600 V, Pollution Degree 2

In this manual, a **Warning** identifies hazardous conditions and actions that could cause bodily harm or death. A **Caution** identifies conditions and actions that could damage the Meter, the equipment under test, or cause permanent loss of data.

Warning

To avoid possible electric shock or personal injury, follow these guidelines:

- **Use this Meter only as specified in this manual or the protection provided by the Meter might be impaired.**
- **Do not use the Meter if it is damaged. Before you use the Meter, inspect the case. Look for cracks or missing plastic. Pay particular attention to the insulation surrounding the connectors.**

- Make sure the battery door is closed and latched before operating the Meter.
- Remove test leads from the Meter before opening the battery door.
- Inspect the test leads for damaged insulation or exposed metal. Check the test leads for continuity. Replace damaged test leads before you use the Meter.
- Do not apply more than the rated voltage, as marked on the Meter, between the terminals or between any terminal and earth ground.
- Never operate the Meter with the cover removed or the case open.
- Use caution when working with voltages above 30 V ac rms, 42 V ac peak, or 60 V dc. These voltages pose a shock hazard.
- Use only the replacement fuses specified by the manual.
- Use the proper terminals, function, and range for measurements.
- Avoid working alone.
- When measuring current, turn off circuit power before connecting the Meter in the circuit. Remember to place the Meter in series with the circuit.
- When making electrical connections, connect the common test lead before connecting the live test lead; when disconnecting, disconnect the live test lead before disconnecting the common test lead.
- Do not use the Meter if it operates abnormally. Protection may be impaired. When in doubt, have the Meter serviced.
- Do not operate the Meter around explosive gas, vapor, or dust.
- Use only 1.5 V AA batteries, properly installed in the Meter case, to power the Meter.
- When servicing the Meter, use only specified replacement parts.
- When using probes, keep fingers behind the finger guards on the probes.
- Do not use the Low Pass Filter option to verify the presence of hazardous voltages. Voltages greater than what is indicated may be present. First, make a voltage measurement without the filter to detect the possible presence of hazardous voltage. Then select the filter function.
- Only use test leads that have the same voltage, category, and amperage ratings as the meter and that have been approved by a safety agency.

- Use proper protective equipment, as required by local or national authorities when working in hazardous areas.
- Comply with local and national safety requirements when working in hazardous locations.

⚠ Caution

To avoid possible damage to the Meter or to the equipment under test, follow these guidelines:

- Disconnect circuit power and discharge all high-voltage capacitors before testing resistance, continuity, diodes, or capacitance.
- Use the proper terminals, function, and range for all measurements.

- Do not remove batteries while the Meter is turned on or a signal is applied to the Meter's input jacks.
- Before measuring current, check the Meter's fuses. (See "Testing the Fuses" in the Users Manual on the accompanying CD.)
- Do not use the LoZ mode to measure voltages in circuits that could be damaged by this mode's low impedance ($\approx 3 \text{ k}\Omega$). (Model 289 only)











Hazardous Voltage

To alert you to the presence of a potentially hazardous voltage, when the Meter detects a voltage $\geq 30 \text{ V}$ or a voltage overload (OL), the ⚡ symbol is displayed.

Symbols

Table 1 lists and describes the symbols used on the Meter and in this manual.

Table 1. Symbols

Symbol	Description	Symbol	Description
~	AC (Alternating Current or Voltage)		Fuse
---	DC (Direct Current or Voltage)		Double Insulated
	Hazardous voltage		Important Information; refer to manual
	Battery (Low battery when shown on the display)		Earth ground
)))	Continuity test or continuity beeper tone		Conforms to relevant Canadian and US standards
CE	Conforms to European Union directives		Conforms to relevant Australian standards
	Underwriters Laboratory listed product		Inspected and licensed by TÜV Product Services
CAT III	IEC Measurement Category III – CAT III equipment is designed to protect against transients in equipment in fixed equipment installations, such as distribution panels, feeders and short branch circuits, and lighting systems in large buildings.	CAT IV	IEC Measurement Category IV – CAT IV equipment is designed to protect against transients from the primary supply level, such as an electricity meter or an overhead or underground utility service.
	Do not dispose of this product as unsorted municipal waste. Go to Fluke's website for recycling information.		

Using Auto Repeat

For some menu selections, holding down a softkey or cursor button will continuously change (or advance) a selection until the button is released. Normally, each press of a button causes the selection to change once. During some selections, the selections will change faster if the button is held for two or more seconds. This is helpful when scrolling through a list of selections, such as a list of stored measurements.

Understanding the Display

Display features shown in Figure 2 are described in Table 3 and the following sections.

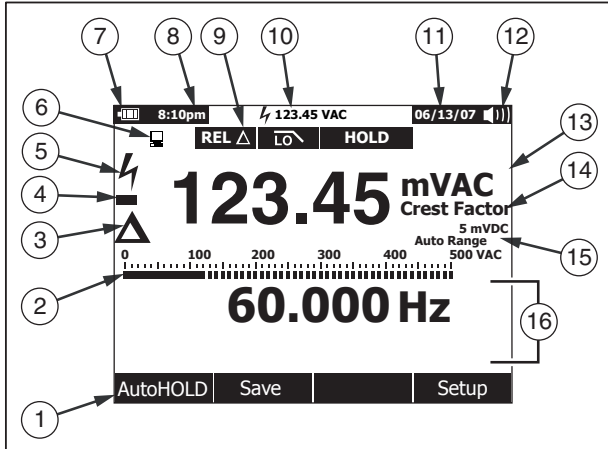

Figure 2. Display Features

est01.eps

Table 3. Display Features

Item	Function	Indication
①	Softkey labels	Indicates the function of the button just below the displayed label.
②	Bar graph	Analog display of the input signal (See the "Bar Graph" section for more information).
③	Relative	Indicates the displayed value is relative to a reference value.
④	Minus sign	Indicates a negative reading.
⑤	Lightning bolt	Indicates hazardous voltage present at the Meter's input.
⑥	Remote communication	Indicates activity over the communication link.
⑦	Battery level	Indicates the charge level of the six AA batteries.
⑧	Time	Indicates the time set in the internal clock.
⑨	Mode annunciators	Indicates the Meter's mode.

Table 3. Display Features (cont.)

Item	Function	Indication
⑩	Mini-measurement	Displays the lightning bolt (when necessary) and the input value when the primary and secondary displays are covered by a menu or pop-up message.
⑪	Date	Indicates the date set in the internal clock.
⑫	Beeper	Indicates the Meter's beeper is enabled (not associated with the continuity beeper).
⑬	Units	Indicates the units of measure.
⑭	Auxiliary Units	Indicates unitless measurements like Crest Factor.
⑮	Range indicator	Indicates the range the Meter is in and the ranging mode (auto or manual).
⑯	Secondary display	Displays secondary measurement information about the input signal.

Bar Graph

The analog bar graph functions like the needle on an analog meter, but without the overshoot. The bar graph updates 30 times per second. Because the graph updates faster than the digital display, it is useful for making peak and null adjustments and observing rapidly changing inputs. For frequency, duty cycle, pulse width, dBm, and crest factor functions, the bar graph represents the amplitude of the input signal (volts or amps) and not the value in the primary display. The bar graph is not shown for capacitance, temperature, LoZ, AC+DC, AC over DC, peak, or min max functions.

For dc voltage, dc current, and all relative percent modes, a zero-centered bar graph is displayed. For dc voltage and current, the bar graph range is the maximum of the selected range. For relative percent mode, the bar graph goes to $\pm 10\%$.

The number of lit segments indicates the measured value and is relative to the full-scale value of the selected range. In the 50 Vac range, for example, the major divisions on the scale represent 0, 5, 10, 15, 20, 25, 30, 35, 40, 45, and 50 Vac. An input of 25 Vac turns on segments up to the middle of the scale.

For off-scale values, ► appears to the right of the normal bar graph. For the zero-center bar graph, a ◀ appears at the left end of the bar graph for negative off-scale values and ► appears on the right end for positive off-scale values.

Status Bar Elements

The status bar at the top of the Meter's display contains indicators for battery level, time of day, mini-measurement display, present date, and beeper on/off icon.

The mini-measurement display shows the measurement value of the primary function, if it is not already shown in the page area of the display. For example, when the display is frozen for a HOLD, the mini-measurement display continues to show the input signal (Live) measurement and a mini ⚡ . In addition, the mini-measurement display will flash, if ⚡ (for inputs above 30 volts) would normally appear in the primary display but is obscured. To warn of the possibility of blowing a current fuse, the mini-measurement display also flashes when current measurements exceed the maximum continuous current levels (see specifications).

Page Area

The page area of the display is where the main meter content is displayed. The primary display (upper half of the page area) is where the most important value of the selected function is shown. The secondary display contains the bar graph and values that may be measured in addition to the primary function value. For example, with frequency measurement selected in Vac, the frequency value will appear in the primary display with the ac voltage value in the secondary display.

Softkey Labels

Labels for the four function softkeys (F1 through F4) appear in the bottom row of the display. These labels will change based on the function and/or menu selection.

Adjusting Display Contrast

When not selecting items on a menu or inputting data, pressing ☺ increases display contrast and pressing ☹ decreases it.

Using the Input Terminals

All functions except current use the $\text{V}\Omega$ and **COM** input terminals. The two current input terminals (A and mA/ μ A) are used as follows:

Current from 0 to 400 mA, use the mA/ μ A and **COM** terminals.

Current between 0 and 10 A use the **A** and **COM** terminals.

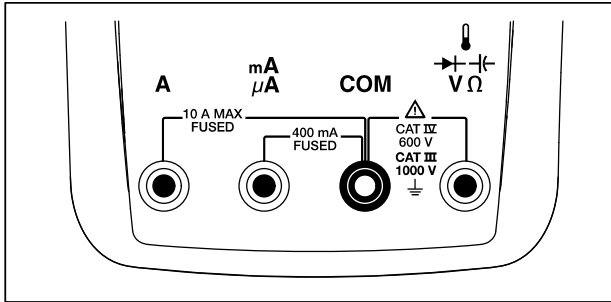

est04.emf

Figure 4. Input Terminals



Table 5. Input Terminals

Terminal	Description
A	Input for 0 A to 10.00 A current (20VA overload for 30 seconds on, 10 minutes off), frequency, and duty-cycle measurements.
mA μA	Input for 0 A to 400 mA current measurements, frequency, and duty cycle.
COM	Return terminal for all measurements.
$\text{V}\Omega$	Input for voltage, continuity, resistance, diode test, conductance, capacitance, frequency, temperature, period, and duty-cycle measurements.

Controlling Meter Power

The Meter is powered by six AA batteries and controlled through a front panel power switch and internal circuits designed to help conserve battery power. The following sections describe several techniques for controlling Meter power.

Powering the Meter On and Off Manually

With the Meter off, press  to turn on the Meter. Pressing  while the Meter is on causes it to turn off.





Note

Collected data is retained when the Meter is turned off while in record, MIN MAX record, or Peak record modes. When the Meter is next turned on, the display shows the collected data in stopped mode. Pressing the softkey labeled Save will save the data.

Battery Level Indicator

The battery level indicator in the upper left-hand corner of the display indicates the relative condition of the batteries. Table 6 describes the various battery levels the indicator represents.

Table 6. Battery Level Indicator

Indication	Battery Capacity
	Full capacity
	¾ capacity
	½ capacity
	¼ capacity
 ^[1]	Almost empty (less than one day)

[1] When critically low, a “Replace batteries” pop-up message appears 15 seconds before the Meter shuts down.

The Meter will display a “Batteries low” message whenever the battery level will not support a selected function.

Automatic Power-Off

The Meter automatically turns off if the rotary switch is not moved or a button is not pressed for 15 minutes (default). Pressing  will turn the Meter back on after it is powered off automatically. To change the timeout period or completely disable automatic power-off, refer to “Setting Backlight and Auto Off Timeouts” later in this manual.

Battery Saver Mode

If Auto off is enabled (set to a time period), and MIN MAX record, Peak record, Recording, or AutoHold is enabled, the Meter will enter a battery-saver mode if a push-button is not pressed or the rotary switch is not moved for a set period of time. For the

recording mode, the time period is five minutes. For MIN MAX, Peak and AutoHold modes, the time period is the same time the Auto Off feature is set for. See the “Setting Backlight and Auto Off Timeouts” section later in this manual. Battery saver mode conserves battery power by shutting down circuits not necessary for the selected function, including the display. However, the LED surrounding the power button (Ⓢ) will continue to flash to indicate the Meter is still collecting data.

The Meter “wakes up” from battery-save mode under the following conditions:

- A button is pressed
- The rotary knob is moved
- A lead is removed or inserted into a current input jack.
- The Meter changes range
- IR Communications begin

These conditions only awaken the Meter and does not change the Meter’s function or mode of operation.

Controlling the Backlight

If viewing the display becomes difficult in low-light conditions, press Ⓢ to activate the LCD backlight. The backlight button cycles the backlight through three states: low, high, and off. The Meter displays a message if the battery level will not support the backlight operation.

To conserve battery life, a user-adjustable timeout controls how long the backlight stays on. The default timeout is 5 minutes. To change the timeout, refer to “Setting Backlight and Auto Off Timeouts” later in this manual.

Selecting the Range

The Meter’s selected range is always displayed above the right-hand end of the bar graph, as the range indicator. Pressing **RANGE** switches the Meter between manual and autoranging. It also cycles through the Meter ranges when manual ranging is enabled.

Note

*You cannot use **RANGE** in conductance, diode test, LoZ, Low Ohms, and temperature functions. These functions all use a fixed range.*

In autorange, the Meter selects the lowest range to display the highest available precision (resolution) for the input signal. If Manual range is already enabled, press and hold **RANGE** for one second to enter the autoranging mode.

If autorange is enabled, press **RANGE** to enter manual ranging. Each additional press of **RANGE** sets the Meter to the next higher range, unless it is already in the highest range, at which point the range switches to the lowest range.

Understanding Function Menus

Each primary measurement function (rotary switch position) has a number of optional sub-functions or modes accessed by pressing the softkey labeled **Menu** (F1). A typical menu is shown in Figure 5.

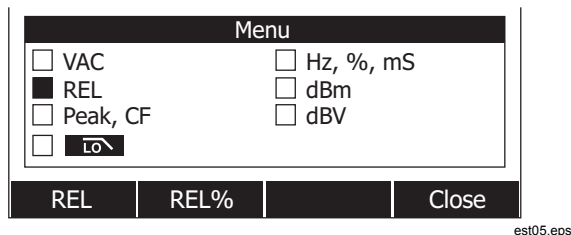

Figure 5. Function Menu

Menu selection is indicated by the filled-in black square (hereafter the menu selector) to the left of a menu item. Use the four front-panel cursor buttons (⏪ ⏩ ⏴ ⏵) to position the menu selector next to a menu item. As the menu selector moves between menu items, the four softkeys and their labels change to reflect the available functions and/or modes available for the selection menu item.

The example menu in Figure 5 shows the REL (Relative) function as the current selection. The function selected when the menu opens is the function selected the last time the menu was used. To get to the Hz menu item from the REL item, press ⏩ once, followed by one press of ⏴. As the menu selector moves between the menu items, the softkey labels change to indicate each softkey's function. Once the desired function or mode appears in one of the softkey labels, press the appropriate softkey to activate it. The pop-up menu closes and the display changes to reflect the selection just made. Pressing the softkey labeled **Close** closes the pop-up menu, leaving the Meter in the state it was in before pressing the **Menu** softkey.



In most cases, the softkeys revealed by the menu selection act like toggles. The example menu shown in Figure 5 shows **REL**, **REL%**, and **Close** softkeys. In this example, the Meter is not in the relative mode, so pressing the softkey labeled **REL** would activate, or toggle, the relative mode. If, on the other hand the Meter is already in the relative mode, pressing the same softkey would disable the relative function.

In some cases, pressing a function that can not be used with other functions appearing in the menu turns off the previously selected function. For example, in Figure 5, if the Meter is already in the relative function, pressing **REL%** causes the Meter to turn off relative and display relative percent.

In cases where multiple modes have been selected, selecting the first (top-left) menu item always turns off all other functions and modes, and returns the Meter to the primary function selected by the rotary switch. For example, assume that the Meter is setup for frequency (Hz) and is displaying in relative mode as selected through the menu in Figure 5. Moving the menu selector to the menu item labeled **VAC** and pressing the softkey labeled **VAC**, clears both frequency and relative selections, leaving the Meter in volts ac only.

Menu selections are remembered for each rotary switch position. For example, selecting **REL** for the volts ac position causes **REL** to be selected the next time the menu is opened in volts ac, even though in the interim, **Hz,%ms** was selected from a similar menu for the millivolts ac function.

Up to two columns of four items each are displayed at any one time. If more than eight menu items are available for a primary function, **▶** appears in the lower right-hand corner of the page area of the display, indicating more menu items are available. With the menu selector on one of the items in the left column,

press  to scroll the screen horizontally and reveal the off-screen menu items. Conversely, with the menu selector on an item in the right-hand column, press  to reveal the off-screen menu items.

Input Alert™ Feature

Warning



To avoid circuit damage and possibly blowing the Meter's current fuse, do not place the probes across (in parallel with) a powered circuit when a lead is plugged into a current terminal. This causes a short circuit because the resistance through the Meter's current terminals is very low.

If a test lead is plugged into the mA/μA or A terminal, but the rotary switch is not set to the correct current position, the beeper warns you by making a chirping sound and displays "Leads connected incorrectly". This warning is intended to stop you from attempting to measure voltage, continuity, resistance, capacitance, or diode values when the leads are plugged into a current terminal.

Using the Info Button



While operating the Meter, more information about a selected function, a front-panel button, or a menu item may be necessary. Press  to open an information window that lists topics covering the functions and modifiers that are available at the time the button is pressed. Each topic provides a brief explanation on a Meter function or feature.



The information revealed through  is not meant to replace the more detailed information found in this manual. Function and feature explanations are brief and only meant to refresh a person's memory.

The number of information topics displayed at any one time may exceed the display area. Use the softkeys labeled **Next** and **Prev** to move from topic to topic. Use the softkey labeled **More** or  and  to scroll through the information a full screen at a time.

Pressing the softkey labeled **Close**, or  will close the information window.

Hold and AutoHold Mode

To freeze the display for any function, press . Only the mini-measurement display and hazardous voltage icon () continue to indicate the actual input. The battery level indicator is also active. The Meter's softkeys are relabeled for saving the frozen reading or activating the AutoHold mode.

If  is pressed while MIN MAX record, peak record, or a recording session is in progress, the display freezes but the data acquisition continues in the background. Pressing  again updates the display to reflect data that was acquired during the hold.

Pressing the softkey labeled **AutoHOLD** activates AutoHold if the Meter is not in the Peak, MIN MAX, or Record modes. AutoHold operation monitors the input signal and updates the display and, if enabled, sounds the beeper, whenever a new stable measurement is detected. A stable measurement is one that does not vary more than a selected adjustable percentage (AutoHold threshold) for at least one second. The Meter filters

out open lead conditions so the Meter leads can be moved between test points without triggering a display update.

Note

For temperature measurements, the AutoHold threshold is a percent of 100 degrees. The default AutoHold threshold is 4% of 100 degrees, or 4 degrees Celsius or Fahrenheit.

Pressing **⏸** while in AutoHold mode, forces the Meter's display to update with the present measurement, just as if a stable measurement had been detected.

To set the AutoHOLD Threshold Value, press the softkey labeled **Setup** to access the setup menu. Using the cursor buttons, move the menu selector next to the menu item labeled **Recording** and press the softkey labeled **Recording** to open the recording setup screen. Using the cursor buttons, move the menu selector next to the menu item labeled **Event Threshold for AutoHOLD** and then press the softkey labeled **Edit**. Press **⬅** or **➡** to scroll through the AutoHold threshold values. With the desired value selected, press the softkey labeled **Close**.

Measuring Crest Factor

Crest factor is a measure of signal distortion and is calculated as a signal's peak value over its rms value. This is an important measurement when looking at power quality issues.

The Meter's crest factor function is only available for the ac measurements: Vac, mVac, Aac, mAac, and μ Aac. With the Meter in one of the ac measurement functions, press the softkey labeled **Menu**. Next, move the menu selector next to the menu item labeled **Peak,CF** and press the softkey labeled **CF**. The

crest factor value is displayed in the primary display while the ac measurement appears in the secondary display. Frequency, duty cycle, and pulse width are not allowed during crest factor measurements.

Capturing Minimum and Maximum Values

The MIN MAX Record mode captures minimum, average, and maximum input values. When the input goes below the recorded minimum value or above the recorded maximum value, the Meter beeps and records the new value. The Meter stores the elapsed time since the recording session was started at the same time. The MIN MAX mode also calculates an average of all readings taken since the MIN MAX mode was activated.

This mode is for capturing intermittent readings, recording minimum and maximum readings unattended, or recording readings while equipment operation precludes watching the Meter. The MIN MAX mode is best for recording power supply surges, inrush currents, and finding intermittent failures.

Response time is the length of time an input must stay at a new value to be captured as a possible new minimum or maximum value. The Meter has a 100 millisecond MIN MAX response time. For example, a surge lasting 100 milliseconds would be captured but one lasting only 50 milliseconds may not be captured at its actual peak value. See the MIN MAX specification for more information.

The true average value displayed is the arithmetic mean of all readings taken since the start of recording (overloads are discarded). The average reading is useful for smoothing out unstable inputs, calculating power consumption, or estimating the percentage of time a circuit is active.

Note

For input signals that are noisy or change rapidly, turn on the Smoothing mode to display a steadier reading. See the “Enabling and Disabling the Smoothing Mode” section later in this manual.

To extend battery life during MIN MAX recording, the Meter will enter a battery saver mode. See the “Setting Backlight and Auto Off Timeouts” section for more information on the battery saver mode.

To activate the MIN MAX mode, press **MIN MAX**. As shown in Figure 6, the Meter displays **MIN MAX** at the top of the measurement page, and the MIN MAX start date and time along the bottom of the page. In addition, the recorded maximum, average, and minimum values appear in the secondary display with their respective elapsed times.

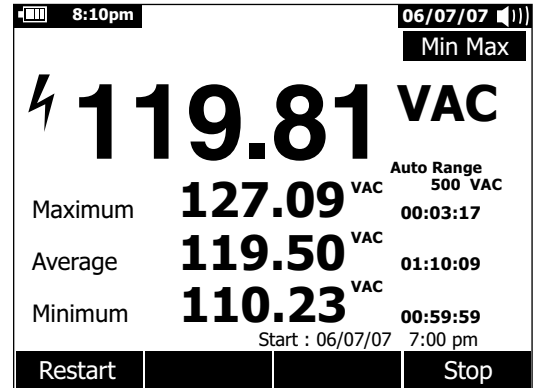

est42.eps

Figure 6. MIN MAX Record Display

To stop a MIN MAX recording session, press **MIN MAX** or the softkey labeled **Stop**. The summary information in the display freezes, and the softkeys change function to allow saving the collected data. Pressing **MIN MAX** again or the softkey labeled **Close** exits the MIN MAX record session without saving the collected data.

Note

Turning the rotary switch before saving the MIN MAX recording data will cause all the accumulated data to be lost.

To save the MIN MAX screen data, the MIN MAX session must be ended by pressing the softkey labeled **Stop**. Next, press the softkey labeled **Save**. A dialog box opens where the default saved name can be selected or another name assigned. Press

the softkey labeled **Save** to store the MIN MAX screen data. MIN MAX can not be continued at this point. Press the softkey labeled **Close** to exit the MIN MAX mode.

Pressing the softkey labeled **Restart** while MIN MAX is running stops the MIN MAX session, discards all MIN MAX data, and immediately starts a new MIN MAX recording session.

Capturing Peak Values

Peak record is almost the same as MIN MAX record explained earlier in this manual. The significant difference between the two recording functions is the shorter response time for peak recording: 250 μ s. With this short response time, the actual peak values of a sinusoidal signal are measurable. Transients are more accurately measured using the peak record feature.

To activate the peak mode, press the softkey labeled **Menu**. Move the menu selector next to the menu item labeled **Peak,CF** or **Peak**. Press the softkey labeled **Peak** to start the peak recording session.

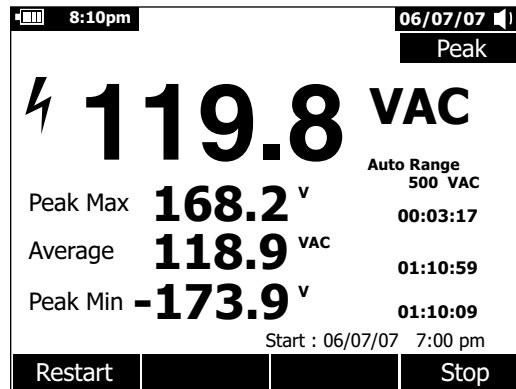

est43.eps

Figure 7. Peak Record Display

As shown in Figure 7, the primary display shows the “live” measurement present on the Meter’s inputs. In the secondary area of the display, the maximum and minimum peak values as well as the average value are shown along with their respective time stamps. The time stamp next to the average value indicates the elapsed time of the peak recording session. The peak recording session start time is shown along the bottom of the page area of the display.

When the peak value of the input signal goes below the recorded minimum value or above the recorded maximum value, the Meter beeps and records the new value. At the same time, the elapsed time since the peak recording session was started is stored as the recorded value’s time stamp.

Pressing the softkey labeled **Stop** ends the peak recording session. The summary information in the display freezes and the softkeys change function to allow saving the collected data. Pressing the softkey labeled **Close** exits the peak recording session without saving the collected data.

Note

Turning the rotary switch before saving the peak recording data will cause all the accumulated data to be lost.

To save peak screen data, the peak capture session must be ended by pressing the softkey labeled **Stop**. Next press the softkey labeled **Save**. A dialog box opens where the default saved name can be selected or another name assigned. Press the softkey labeled **Save** to store the Peak screen data. Peak capture can not be continued at this point. Press the softkey labeled **Close** to exit the Peak capture mode.

Pressing the softkey labeled **Restart** while the peak recording session is running stops the session, discards all peak recorded data, and immediately starts a new peak record session.

When viewing saved records, snapshot peak records look the same as a stopped peak records. Therefore, use the elapsed time (average value time stamp) to identify one record from another.

To extend battery life during peak record, the Meter enters a battery-saver mode after a period of time set for the Auto Off feature. See the "Setting Backlight and Auto Off Timeouts" section for more information on the battery saver mode.

Low Pass Filter (Model 289 only)

The Meter is equipped with an ac low pass filter. When measuring ac voltage, or Vac frequency, press the softkey labeled **Menu** to open the function menu, and move the menu selector to the **Lo** item. Next, press the softkey labeled **Lo** to toggle the low pass filter mode on (**Lo** displayed) and off.

⚠⚠ Warning

To avoid possible electric shock or personal injury, do not use the Low Pass Filter option to verify the presence of hazardous voltages. Voltages greater than what is indicated may be present. First, make a voltage measurement without the filter to detect the possible presence of hazardous voltage. Then select the filter function.

The Meter continues measuring in the chosen ac mode, but now the signal passes through a filter that blocks unwanted voltages above 1 kHz, as shown in Figure 8. The low pass filter can improve measurement performance on composite sine waves that are typically generated by inverters and variable frequency motor drives.

Note

*In Low Pass Mode, the Meter goes to manual mode. Select ranges by pressing **RANGE**. Autoranging is not available when the Low Pass Filter is enabled.*

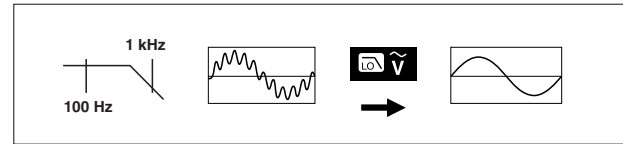

aom11f.eps

Figure 8. Low Pass Filter

Making Relative Measurements

The Meter displays calculated values that are based on a stored reference value when set to relative and relative percent mode. Figure 9 shows the functions for which the two relative modes are available. In addition, the two relative modes are available in frequency, duty cycle, pulse width, crest factor, and dB.

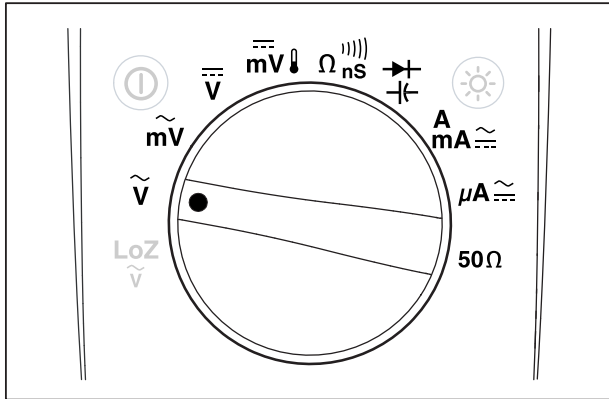

est29.eps

Figure 9. Relative Mode Functions

To activate the relative or relative percent modes while in one of the functions shown in Figure 9, press the softkey labeled **Menu**. Move the menu selector to the menu item labeled **REL**. Next, press either the softkey labeled **REL** or **REL%**. The measurement value at the time that either Rel or Rel % is enabled, is stored as the reference value and displayed in the

secondary display. The present or “Live” measurement moves to the secondary display and the primary display indicates the difference between the present measurement and the reference value in measurement units for REL and as a percentage for REL %.

When relative percent is enabled, the bar graph is a zero-centered bar graph that indicates the percentage difference. The bar graph’s range is limited to $\pm 10\%$, but the display goes to $\pm 999.9\%$ or more, the display indicates **OL**. When the reference value is 0, the Meter displays **OL**.

With the exception of dB measurements, ranging is set to manual and can not be changed. Both auto and manual ranging is possible when making relative dB measurements.

When relative is enabled during dBm or dBV measurements, the displayed units change to dB.

In relative or relative percent mode, the softkey label for F3 indicates **REL** or **REL%**, depending on which of the two modes is not presently selected. The F3 button acts as a toggle, switching the Meter between the two modes. Moving the rotary switch between V and mV while in relative dBm or dBv mode does not disable the dB measurement. This allows continuous measurements over a wide range of input voltage.

Making Measurements

The following sections describe how to take measurements with the Meter.

Measuring AC Voltage

The Meter displays ac voltage measurements as rms (root mean square) readings. The rms value is the equivalent dc voltage that would produce the same amount of heat in a resistance as the measured voltage. True-rms readings are accurate for sine waves and other wave forms (with no dc offset) such as square waves, triangle waves, and staircase waves. For ac with dc offset, refer to the "Measuring AC and DC Signals" section later in this manual.

Rotate the Meter's rotary switch to \tilde{V} or $m\tilde{V}$ and set up the Meter to measure ac volts as shown in Figure 10.

The Meter's ac volts function offers a number of modes to provide more details about an ac signal. Pressing the softkey labeled **Menu** opens a menu of items that can be used to modify the basic ac voltage measurement. Refer to the appropriate section in this manual to learn more about each menu item.

To clear all modes and return to the basic volts ac measurement, press the softkey labeled **Menu**. Move the menu selector to the item labeled **VAC**. Press the softkey labeled **VAC** to clear all functions and modes.

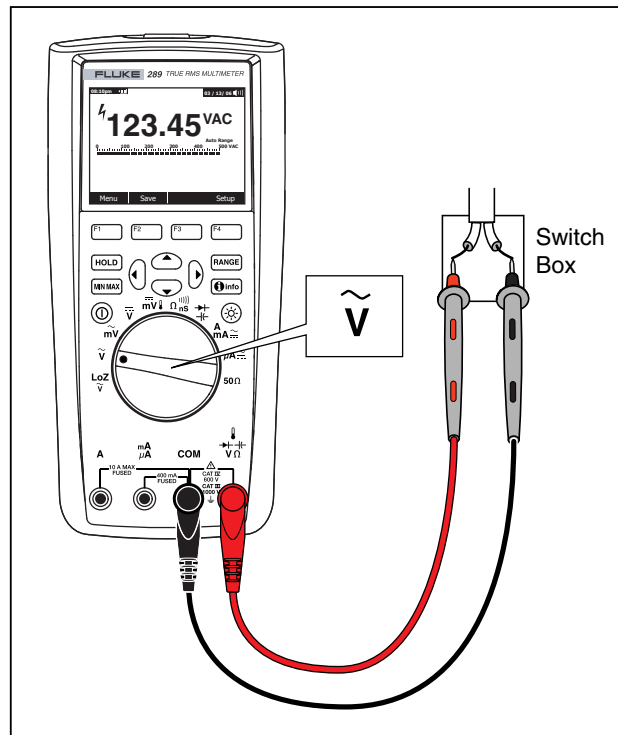

Figure 10. AC Voltage Measurements

est07.eps

Using LoZ for Voltage Measurements (Model 289 only)

⚠ Caution

Do not use the LoZ mode to measure voltages in circuits that could be damaged by this mode's low impedance ($\approx 3 \text{ k}\Omega$).

To eliminate ghost voltages, the Meter's LoZ function presents a low impedance across the leads to obtain a more accurate measurement.

To make a LoZ measurement, set the rotary switch to LoZ . The Meter displays the ac voltage in the primary display and the dc voltage in the secondary display. During LoZ measurements, the Meter's range is set to 1000 volts in the manual ranging mode.

In LoZ, both **RANGE** and **MIN/MAX** are disabled. There are no additional modes for this function and the softkey labeled **Menu** is therefore disabled as well.

Making dB Measurements

The Meter is capable of displaying voltage as a dB value, either relative to 1 milliwatt (dBm), a reference voltage of 1 volt (dBV) or a user-selectable reference value. See the "Setting a Custom dBm Reference" section later in this manual.

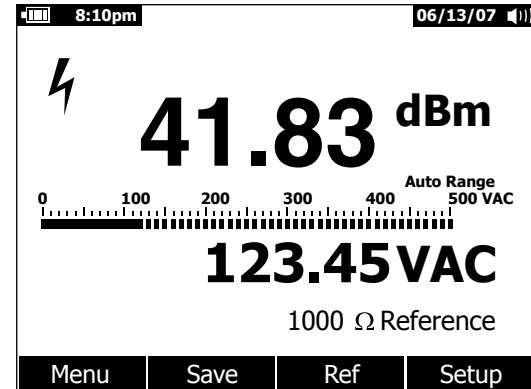

Figure 11. dBm Display

est08.eps

To set the Meter to display values in dBm, set the rotary switch to \tilde{V} or \tilde{mV} and press the softkey labeled **Menu**. Move the menu selector to the menu item labeled **dBm**. Press the softkey labeled **dBm**. The **dBm, Hz** menu selection replaces the secondary display (123.45 VAC in Figure 11) with the frequency measurement. All voltage measurements are displayed as a dBm value, as shown in Figure 11.

A dBm measurement must use a reference impedance (resistance) to calculate a dB value based on 1 milliwatt. When set to 600Ω (default), the reference impedance is not displayed during a dBm measurement. When set to something other than 600Ω , the reference impedance is displayed just above the softkey labels.

To select another reference value, press the softkey labeled **Ref** to display a message box with the current reference value. Pressing \uparrow or \downarrow , scrolls through the nine predefined references: 4, 8, 16, 25, 32, 50, 75, 600, and 1000. Set the reference by pressing the softkey labeled **OK**. To add a custom reference impedance, see the "Setting a Custom dBm Reference" section later in this manual.

A dBV measurement uses a 1 volt reference voltage to compare the present measurement against. The difference between the two ac signals is displayed as a dBV value. The reference impedance setting is not part of a dBV measurement.

To make a dBV measurement, position the rotary switch to \tilde{V} or \tilde{mV} and place the Meter leads on the voltage to be measured. Next, press the softkey labeled **Menu**. Move the menu selector to the menu item labeled **dBV** and press the softkey labeled **dBV**. The Meter displays the voltage in dBV.

To exit the dBV or dBm function, press the softkey labeled **Menu** followed by the softkey labeled **dBV** or **dBm**, respectively. Selecting one of the other modifiers such as **ms**, **%**, or **CF** also cancels dBV or dBm.

Measuring DC Voltage

The Meter displays dc volts values as well as their polarity. The bar graph for dc voltage measurements is a zero-centered bar graph. Positive dc voltages cause the bar graph to fill to the right of center while negative dc voltages fill left of center.

To measure a dc voltage with the Meter, rotate the rotary switch to the $\overline{\text{V}}$ or $\overline{\text{mV}}$ position as shown in Figure 12.

The Meter's dc volts function offers a number of modes to provide more details about a dc signal. Pressing the softkey labeled **Menu** opens a menu of items that can be used to modify the basic dc voltage measurement. Refer to the appropriate section in this manual to learn more about each menu item.

To clear all modes and return to the basic volts dc measurement, press the softkey labeled **Menu**. Move the menu selector to the item labeled **VDC**. Press the softkey labeled **VDC** to clear all functions and modes.

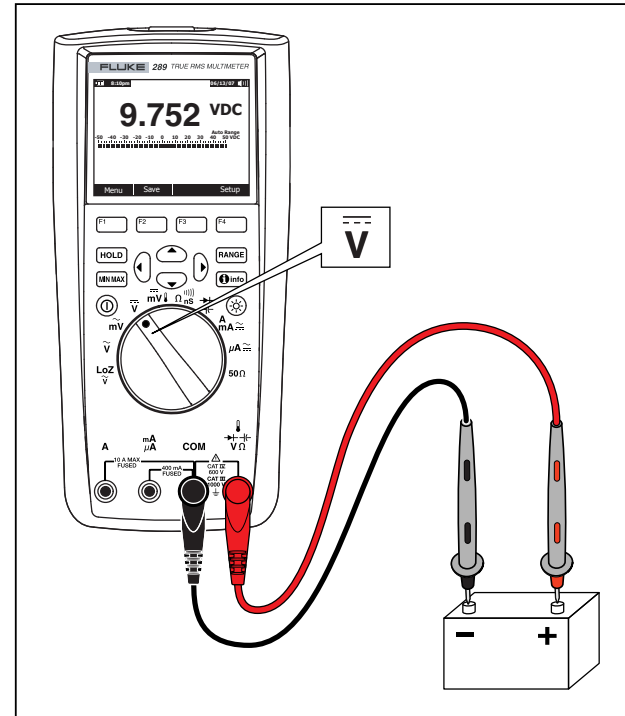

Figure 12. DC Voltage Measurements

est09.eps

Measuring AC and DC Signals

The Meter is capable of displaying both ac and dc signal components (voltage or current) as two separate readings or one AC+DC (rms) value combined. As shown in Figure 13, the Meter displays ac and dc combinations three ways: ac displayed over dc (AC,DC), dc displayed over ac (DC,AC), and ac combined with dc (AC+DC). Select one of these three displays using the Function and Mode menu.

With the rotary switch set to \bar{v} , \bar{mV} , \bar{mA} , or μA , press the softkey labeled **Menu**. Move the menu selector to the menu item labeled **AC+DC**. At this point, three different softkey labels

indicate **AC+DC** (F1), **AC,DC** (F2), and **DC,AC** (F3). Press the softkey that presents these two signals as needed.

While in any of the three AC+DC modes, peak measurements, frequency, duty cycle, and period measurements are not allowed. In addition to these modes, MIN MAX, relative, and relative % are not allowed in AC,DC or DC,AC modes.

Note

The bar graph is not displayed while the Meter is in any of the three AC+DC modes.

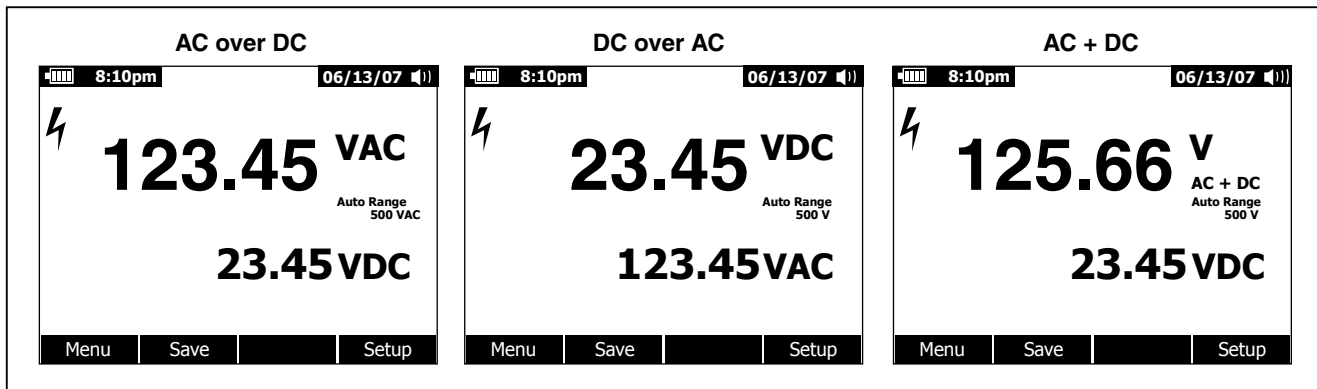

Figure 13. AC and DC Display

est30.eps

Both manual and autoranging is available when using the ac+dc modes. The same range is used for both ac and dc signals.

However, while in autorange, up-ranging occurs when either the ac or dc signal exceeds the present range. Down-ranging occurs

only when both the ac and dc signals drop below 10% of the present range. For AC+DC, ranging is controlled by the underlying values of the ac and dc signals and not by the sum of the AC+DC calculation.

To exit the AC+DC mode, press the softkey labeled **Menu** and select the default mode for the selected function. For dc volts and dc millivolts functions, move the menu selector to **VDC** and press the softkey labeled **VDC**. For the current functions, move the menu selector to the **AC,DC** menu item and press either the **AC** or **DC** softkey.

Measuring Temperature

⚠ ⚠ Warning

To avoid the potential for fire or electric shock, do not connect the thermocouple to electrically live circuits.

The Meter uses an 80BK-A Integrated DMM Temperature Probe or other type-K temperature probe for measuring temperature. To measure temperature, set up the Meter as shown in Figure 14. Press the softkey labeled **Menu** and move the menu selector to the menu item labeled **Temp**. Press the softkey labeled **F** for temperature in Fahrenheit or **C** for Celsius.

Note

A Meter classified as "SI" will not have an **F** selection.

The primary display normally shows temperature or the message "Open Thermocouple". The open thermocouple message may be due to a broken (open) probe or because no probe is installed into the input jacks of the Meter. Shorting the $\text{V}\Omega$ terminal to the **COM** terminal will display the temperature at the Meter terminals.

Note

RANGE is disabled when the Meter is in the Temperature function.

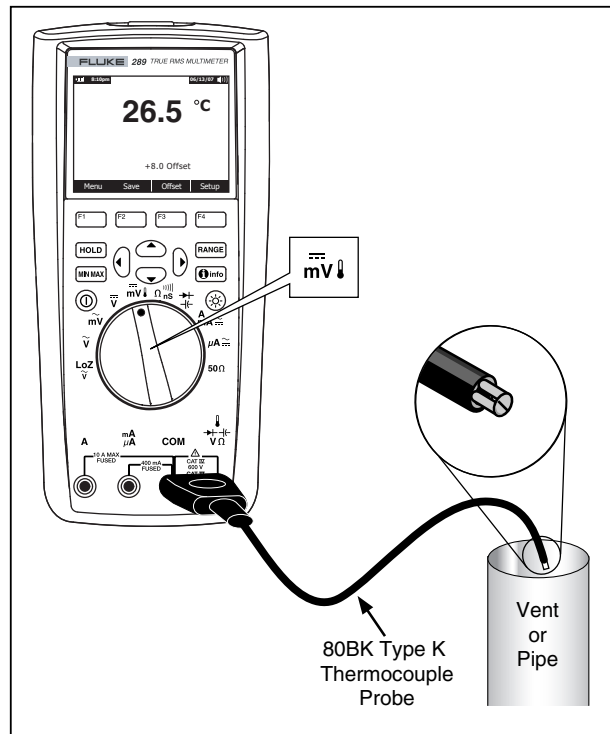

Figure 14. Temperature Measurement

est17.eps

To input a temperature offset value, press the softkey labeled **Offset** to open a message box with the present offset value. Use **▶** and **◀** to position the cursor over one of the digits or the polarity sign. Use **↶** and **↷** to scroll through the numbers for each digit in the offset or switch between a + or – offset. With the desired value displayed, press the softkey labeled **OK** to set the temperature offset. When set to something other than 0.0, the offset value is shown in the secondary display.

Measuring Resistance

⚠ Caution

To avoid possible damage to the meter or to the equipment under test, disconnect circuit power and discharge all high-voltage capacitors before measuring resistance.

The Meter measures resistance (opposition to current flow) in ohms (Ω). This is accomplished by sending a small current out through the test leads to the circuit under test.

To measure resistance, set the Meter's rotary switch to Ω  and set up the Meter as shown in Figure 15.

Keep the following in mind when measuring resistance.

Because the meter's test current flows through all possible paths between the probe tips, the measured value of a resistor in a circuit is often different from the resistor's rated value.

The test leads can add 0.1 Ω to 0.2 Ω of error to resistance measurements. To test the leads, touch the probe tips together and read the resistance of the leads. To remove lead resistance from the measurement, hold the test lead tips together and press the softkey labeled **Menu**. Next, move the menu selector to the menu item labeled **REL** and press the softkey labeled **REL**. Now all future displayed readings indicate the resistance at the probe tips.

The Meter's resistance function includes modes to help with resistance measurements. Pressing the softkey labeled **Menu** opens a menu of items that can be used to modify the basic resistance measurement. Refer to the appropriate section in this manual to learn more about each menu item.

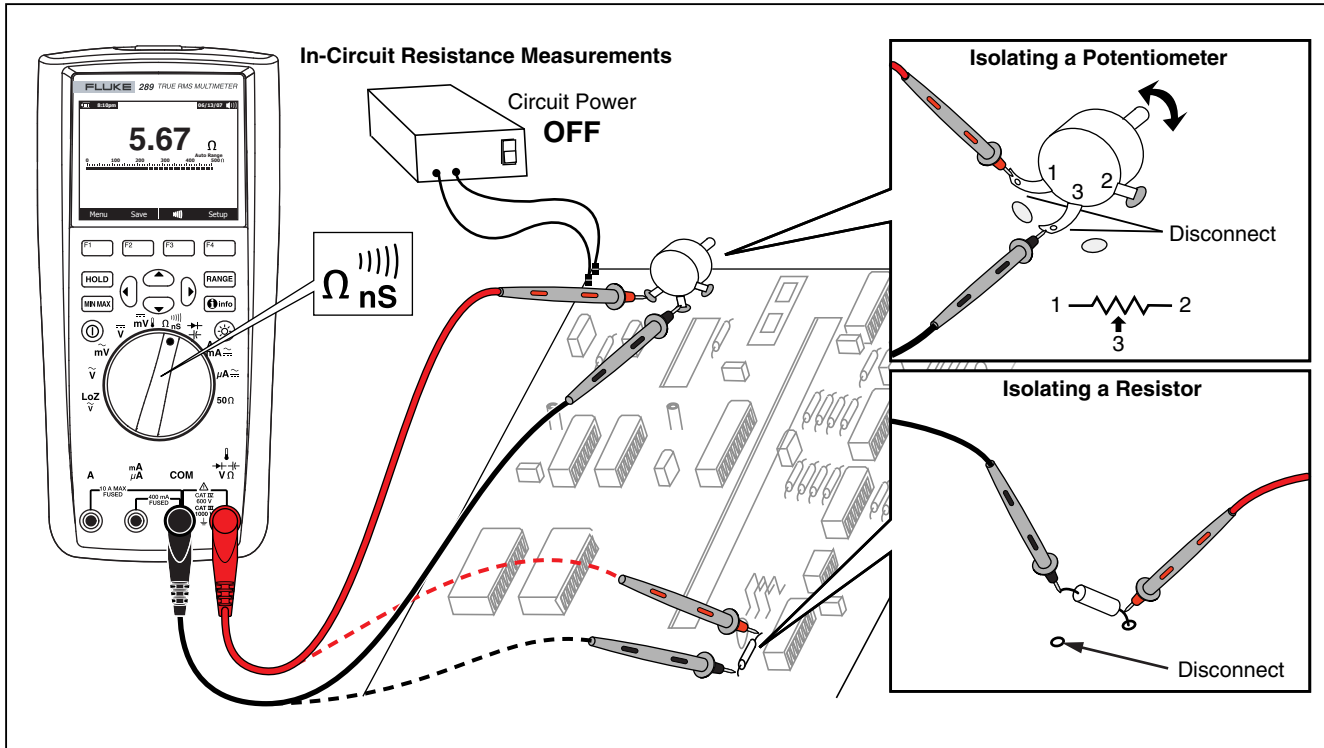

Figure 15. Resistance Measurement

est11.eps

Using the 50Ω Function (Model 289 Only)

⚠ Caution

To avoid damaging the circuit under test, be aware the Meter sources current up to 10 mA at an open circuit voltage up to 20 volts.

To measure low resistances with the Meter, position the rotary switch to 50Ω. This function has a single range and **RANGE** is therefore disabled when the Meter is in the 50Ω function.

Only the relative and relative percent functions work with the 50Ω function. Press the softkey labeled **Menu** to access these two functions.

Testing for Continuity

⚠ Caution

To avoid possible damage to the meter or to the equipment under test, disconnect circuit power and discharge all high-voltage capacitors before testing continuity.

Continuity is the presence of a complete path for current flow. The continuity function detects intermittent opens and shorts lasting as short as 1 ms. The Meter uses three indicators for the absence and presence of continuity: a resistance reading, an open/short indicator, and a beeper.

The resistance reading is simply an ohms function measurement. However, for continuity transitions that are very short, the slow

measurement response of the Meter will not appear in the digital display. Therefore, the continuity function uses a graphical indicator for the presence or absence of continuity. Figure 16 shows the short and open continuity indication.

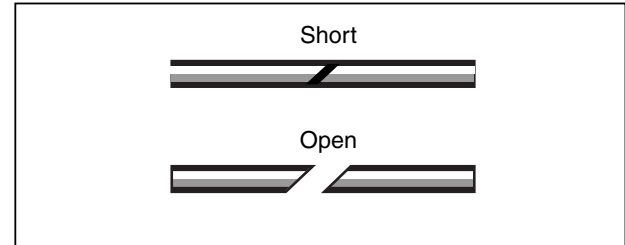

est36.eps

Figure 16. Continuity Indicator

To perform a continuity test, position the rotary switch to Ω_{ns} and set up the Meter as shown in Figure 17. Press the softkey labeled **|||**. In continuity, a short means a measured value less than 8 % of full scale for the 500 Ω range and less than 4 % for other resistance ranges.

Note

The Meter operates in manual range only while the continuity function is selected.

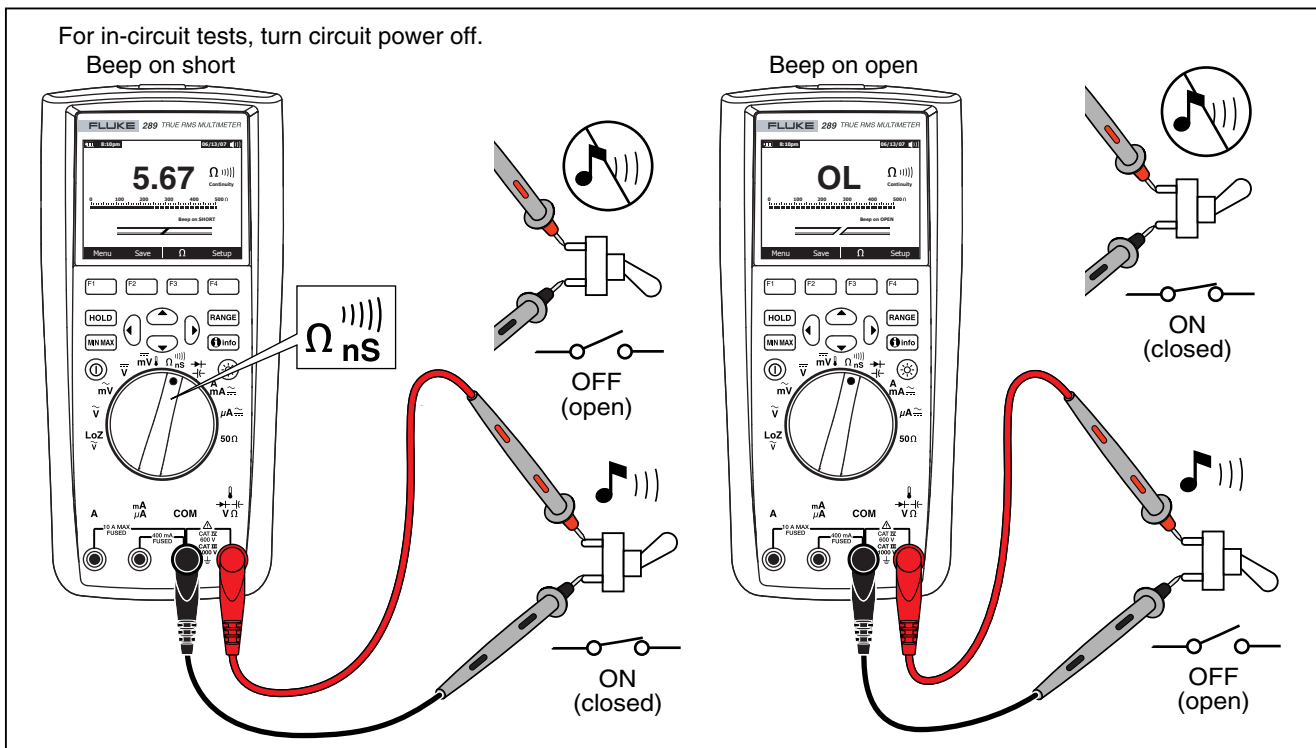



Figure 17. Continuity Testing

est13.eps

To change whether the beeper sounds on shorts or opens, press the softkey labeled **Menu**. Move the menu selector to the menu item labeled **Beeper** and press the softkey labeled **Short/O....**. This beeper selection, Beep on Short or Beep on Open, is displayed just above the continuity indicator. The continuity beeper is always enabled when continuity mode is first entered.

To enable or disable the beeper for continuity, press the softkey labeled **Menu**. Move the menu selector to the menu item labeled **Beeper** and press the softkey labeled **Beeper**. The status of the continuity beeper is displayed to the right of the resistance reading with  when enabled and  when disabled. This setting is independent of the Meter's beeper enable/disable setting in the setup menu.

Toggle between the continuity and ohms functions by pressing softkey F3, which is always labeled with the alternate function.

Using Conductance for High Resistance Tests

Conductance, the inverse of resistance, is the ability of a circuit to pass current. High values of conductance correspond to low values of resistance.

The unit of conductance is the Siemens (S). The meter's 50 nS range measures conductance in nanosiemens (1 nS = 0.000000001 Siemens). Because such small amounts of conductance correspond to extremely high resistance, the nS range is used to measure the resistance of components up to 100,000 M Ω , or 100,000,000,000 Ω (1 nS = 1,000 M Ω).

To measure conductance, position the rotary switch to Ω nS and set up the Meter as shown in Figure 18. Move the menu selector to the menu item labeled **Ohms, nS, Ω nS** and press the softkey labeled **nS**.

There is normally a residual conductance reading with the test leads open. To ensure accurate readings, press the softkey labeled **Menu**. Move the menu selector to the menu item labeled **REL** and press the softkey labeled **REL** to subtract the residual value with the test leads open.

Note

RANGE is disabled when the Meter is measuring conductance.

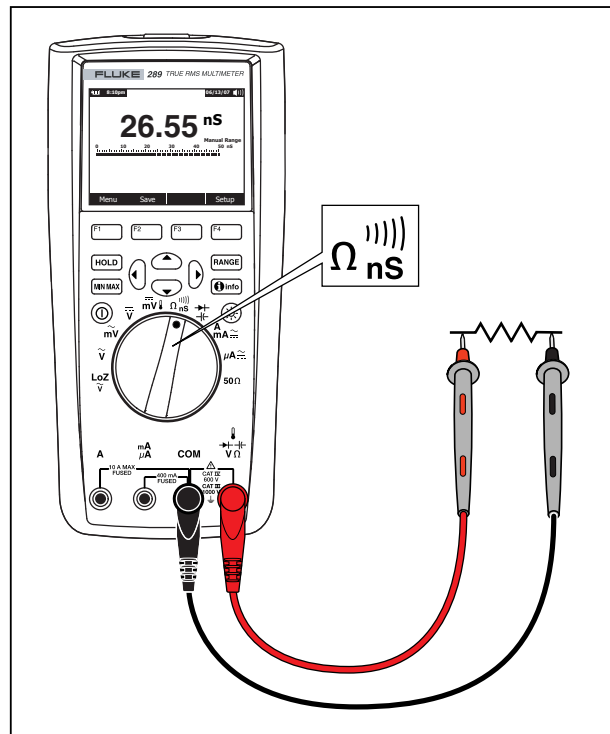

Figure 18. Conductance Measurement

est14.eps

Measuring Capacitance

⚠ Caution

To avoid possible damage to the meter or to the equipment under test, disconnect circuit power and discharge all high-voltage capacitors before measuring capacitance. Use the dc voltage function to confirm that the capacitor is discharged.

Capacitance is the ability of a component to store an electrical charge. The unit of capacitance is the farad (F). Most capacitors are in the nanofarad (nF) to microfarad (μF) range.

The Meter measures capacitance by charging the capacitor with a known current for a known period of time, measuring the resulting voltage, and then calculating the capacitance.

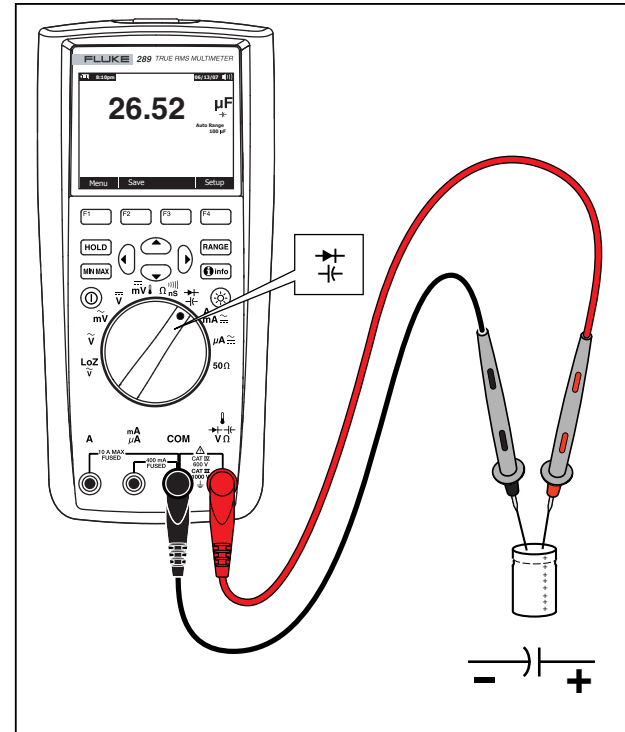

Figure 19. Capacitance Measurement

est15.eps

To measure capacitance, position the rotary switch to F and set up the Meter as shown in Figure 19. If the display doesn't already indicate the Meter is measuring capacitance, press the softkey labeled **Menu**. Next, move the menu selector to the menu item labeled **Diode,Cap** and press the softkey labeled **Cap**.

Note

*To improve measurement accuracy of small value capacitors, press **Menu** and move the menu selector to the menu item labeled **REL**. With the test leads open, press the softkey labeled **REL** to subtract the residual capacitance of the Meter and leads.*

Testing Diodes

⚠ Caution

To avoid possible damage to the meter or to the equipment under test, disconnect circuit power and discharge all high-voltage capacitors before testing diodes.

Use the diode test to check diodes, transistors, silicon controlled rectifiers (SCRs), and other semiconductor devices. The test

sends a current through a semiconductor junction, and then measures the junction's voltage drop. A typical junction drops 0.5 V to 0.8 V.

To test a diode out of a circuit, position the rotary switch to F and set up the meter as shown in Figure 20. If the display doesn't already indicate the Meter is in the Diode Test function, press the softkey labeled **Menu**. Next, move the menu selector to the menu item labeled **Diode,Cap** and press the softkey labeled **Diode**.

If the beeper is enabled during diode test, it will beep briefly for a normal junction and sound continuously for a shorted junction, below 0.1 V. See the "Disabling and Enabling the Beeper" section to disable the beeper.

In a circuit, a similar diode should still indicate a forward-bias reading of 0.5 V to 0.8 V; however, the reading can vary depending on the resistance of other pathways between the probe tips.

Note

RANGE and **MIN MAX** are disabled when the Meter is setup for diode test.

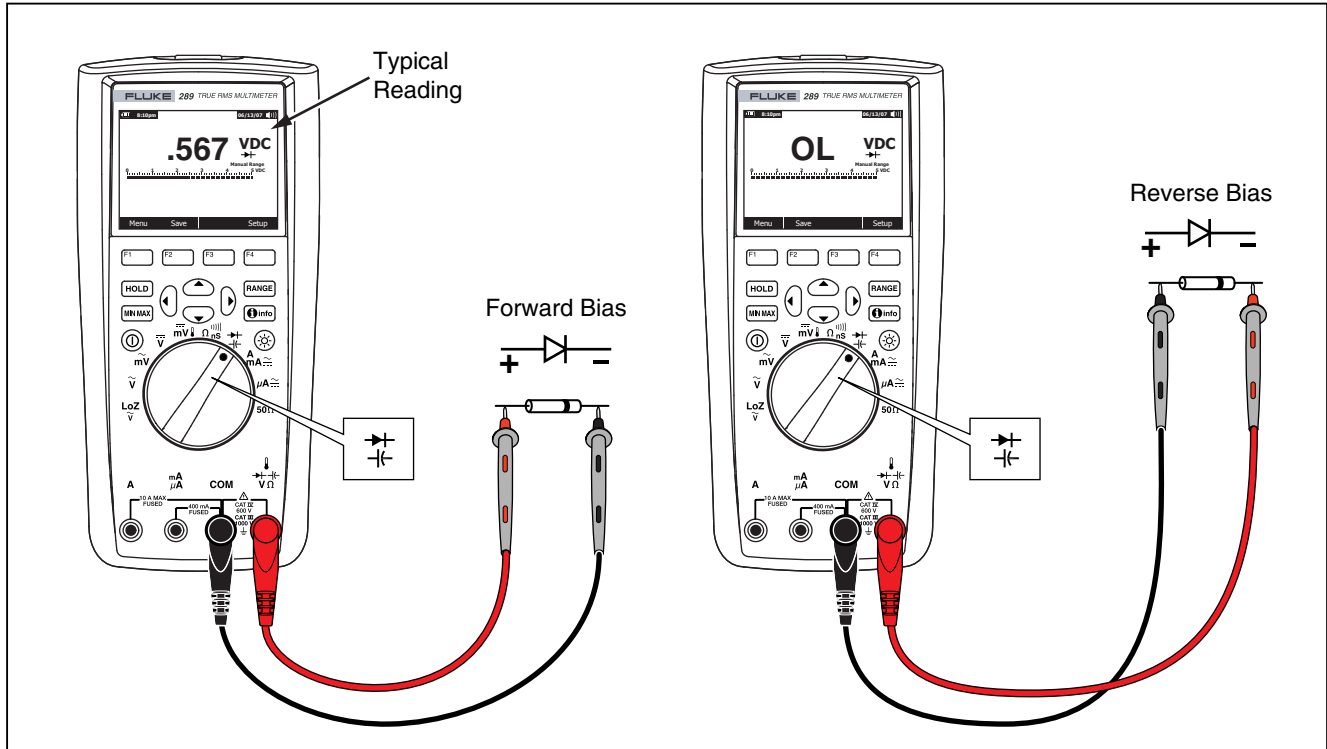

Figure 20. Diode Testing

est16.eps

Measuring Current

Warning

To avoid damage to the Meter and possible injury, never attempt an in-circuit current measurement where the open-circuit potential to earth is greater than 1000 V.

Caution

To avoid possible damage to the Meter or to the equipment under test, check the meter's fuses before measuring current. See the Maintenance section later in this manual. Use the proper terminals, function, and range for your measurement. Never place the probes across (in parallel with) any circuit or component when the leads are plugged into the current terminals.

Current is the flow of electrons through a conductor. To measure current, you must open the circuit under test, then place the meter in series with the circuit.

Note

When measuring current, the display will flash when the input current exceeds 10 amps for the A terminal and 400 mA for the mA/μA terminal. This is a warning that current is approaching the fuse's current limit.

To measure ac or dc current, proceed as follows:

1. Turn off power to the circuit. Discharge all high-voltage capacitors.

2. Insert the black lead into the **COM** terminal. Insert the red lead in an input appropriate for the measurement range.

Note

To avoid blowing the Meter's 440 mA fuse, use the mA/μA terminal only if you are sure the current is less than 400 mA.

3. If you are using the A terminal, set the rotary switch to $\overset{\text{A}}{\text{mA}} \approx$. If you are using the mA/μA terminal, set the rotary switch to $\overset{\mu\text{A}}{\text{mA}} \approx$ for currents below 5000 μA (5 mA), or $\overset{\text{A}}{\text{mA}} \approx$ for currents above 5000 μA. See Figure 21 for test lead connections and function selection. Refer to the "Input Alert Feature" section for information on the alerts the Meter uses when leads are not used correctly for current measurements.
4. As shown in Figure 22, open the circuit path to be tested. Touch the red probe to the more positive side of the break; touch the black probe to the more negative side of the break. Reversing the leads will produce a negative reading, but will not damage the meter.
5. Turn on power to the circuit; then read the display. Be sure to note the measurement unit given at the right side of the display (μA, mA, or A).
6. Turn off power to the circuit and discharge all high-voltage capacitors. Remove the Meter and restore the circuit to normal operation.

Note

While in a current measurement function, the Meter will stay in the selected AC or DC current measurement mode when switching between $\overset{\text{A}}{\text{mA}}$ and $\overset{\text{mA}}{\mu\text{A}}$. Whenever switched to one of the current measurement functions, the Meter will default to the last current type selected (AC or DC).

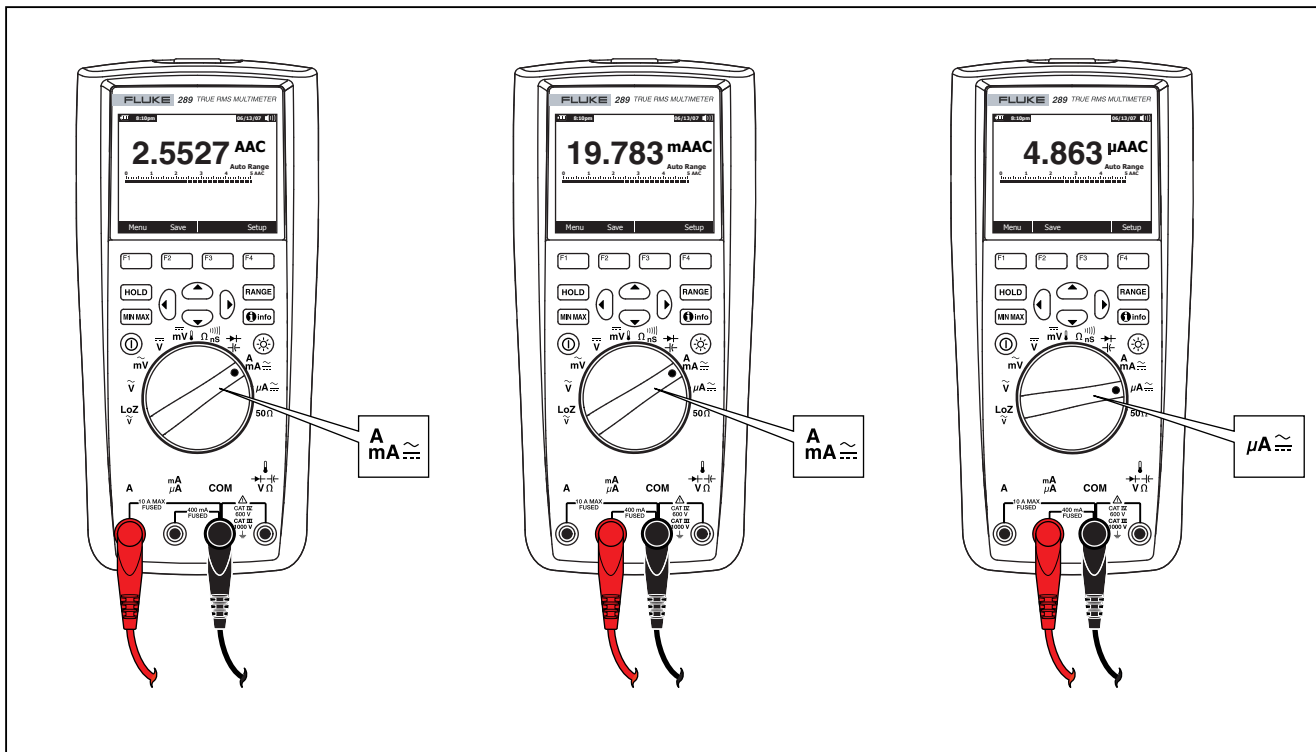

Figure 21. Current Measurement Setup

est18.eps

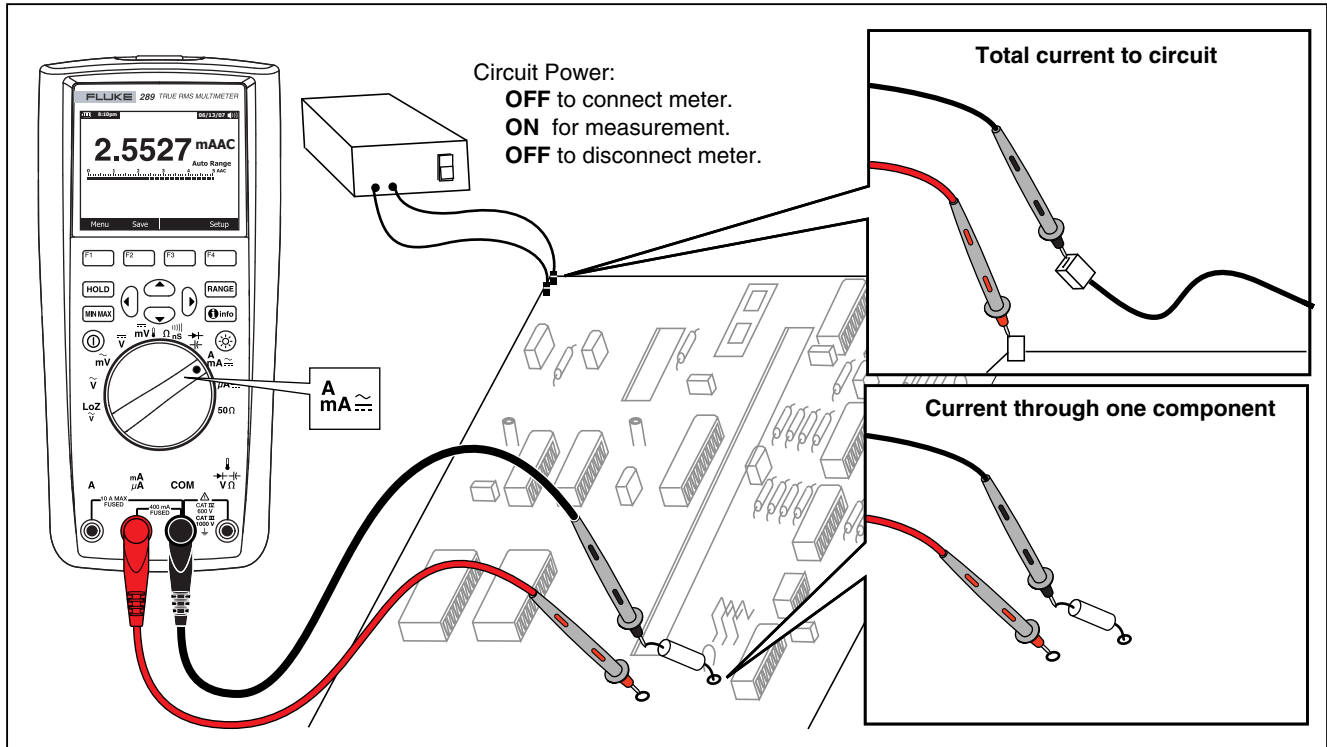

Figure 22. Current Measurement Circuit Connection

est19.eps

⚠ Caution

Placing the probes across (in parallel with) a powered circuit when a lead is plugged into a current terminal can damage the circuit you are testing and blow the Meter's fuse. This can happen because the resistance through the Meter's current terminals is very low, so the Meter acts like a short circuit.

The following are tips for current measurements:

A current meter drops a small voltage across itself, which might affect circuit operation. You can calculate this burden voltage using the values listed in the specifications under Burden Voltage (A, mA, μ A).

The Meter's current functions have a number of modes which provide more details about a current signal. Pressing the softkey labeled **Menu** opens a menu of items that can be used to modify the basic current measurement. Refer to the appropriate section in this manual to learn more about each menu item.

To clear all modes and return to the basic ac or dc current measurement, press the softkey labeled **Menu**. Move the menu selector to the item labeled **AC,DC**. Press the softkey labeled **AC** to clear all functions and modes and make basic ac current measurements, or **DC** for basic dc current measurements.

Measuring Frequency

Frequency is the number of cycles a signal completes each second. The meter measures the frequency of a voltage or current signal by counting the number of times the signal crosses a threshold level within a specified period of time.

Figure 23 highlights the functions that allow frequency measurements.

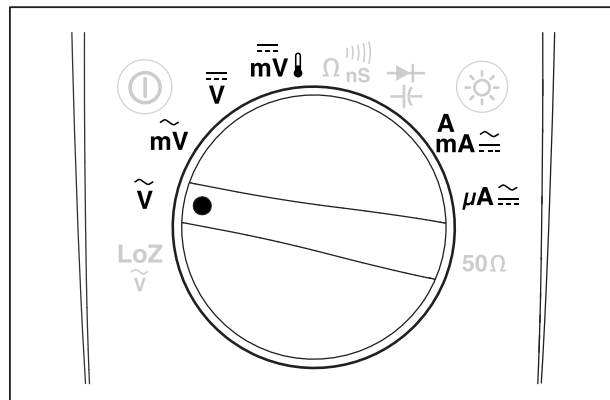

est21.eps

Figure 23. Functions Allowing Frequency Measurement

The Meter autoranges to one of five frequency ranges: 99.999 Hz, 999.99 Hz, 9.9999 kHz, 99.999 kHz, and 999.99 kHz. Figure 24 shows a typical frequency display. Pressing **RANGE** controls the input range of the primary function (volts or amps) and not the frequency range.

To measure frequency, rotate the switch to one of the primary functions allowing frequency measurements highlighted in Figure 23. Press the softkey labeled **Menu** and move the menu

selector to the menu item labeled **Hz,%ms**. Next press the softkey labeled **Hz**.

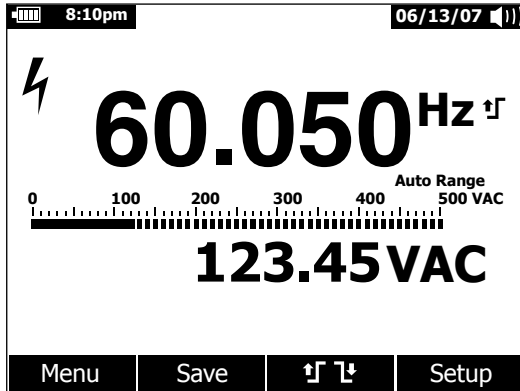

est22.eps

Figure 24. Frequency Display

As shown in Figure 24, the frequency of the input signal is displayed in the primary display. The volts or amps value of the signal is shown in the secondary display. The bar graph does not indicate frequency but indicates the volts or amps value of the input signal.

Selection between a rising trigger \uparrow or falling trigger \downarrow edge is performed by pressing the softkey labeled \uparrow \downarrow . This softkey toggles the trigger setting between the two selections.

The following are tips for frequency measurements:

If a reading shows as 0 Hz or is unstable, the input signal may be below or near the trigger level. You can usually correct these problems by manually selecting a lower input range, which increases the sensitivity of the meter.

If a reading seems to be a multiple of what you expect, the input signal may be distorted. Distortion can cause multiple triggerings of the frequency counter. Selecting a higher voltage range might solve this problem by decreasing the sensitivity of the meter. In general, the lowest frequency displayed is the correct one.

Measuring Duty cycle

Duty cycle (or duty factor) is the percentage of time a signal is above or below a trigger level during one cycle, as shown in Figure 25.

The duty-cycle mode is optimized for measuring the on or off time of logic and switching signals. Systems such as electronic fuel injection systems and switching power supplies are controlled by pulses of varying width, which can be checked by measuring duty cycle.

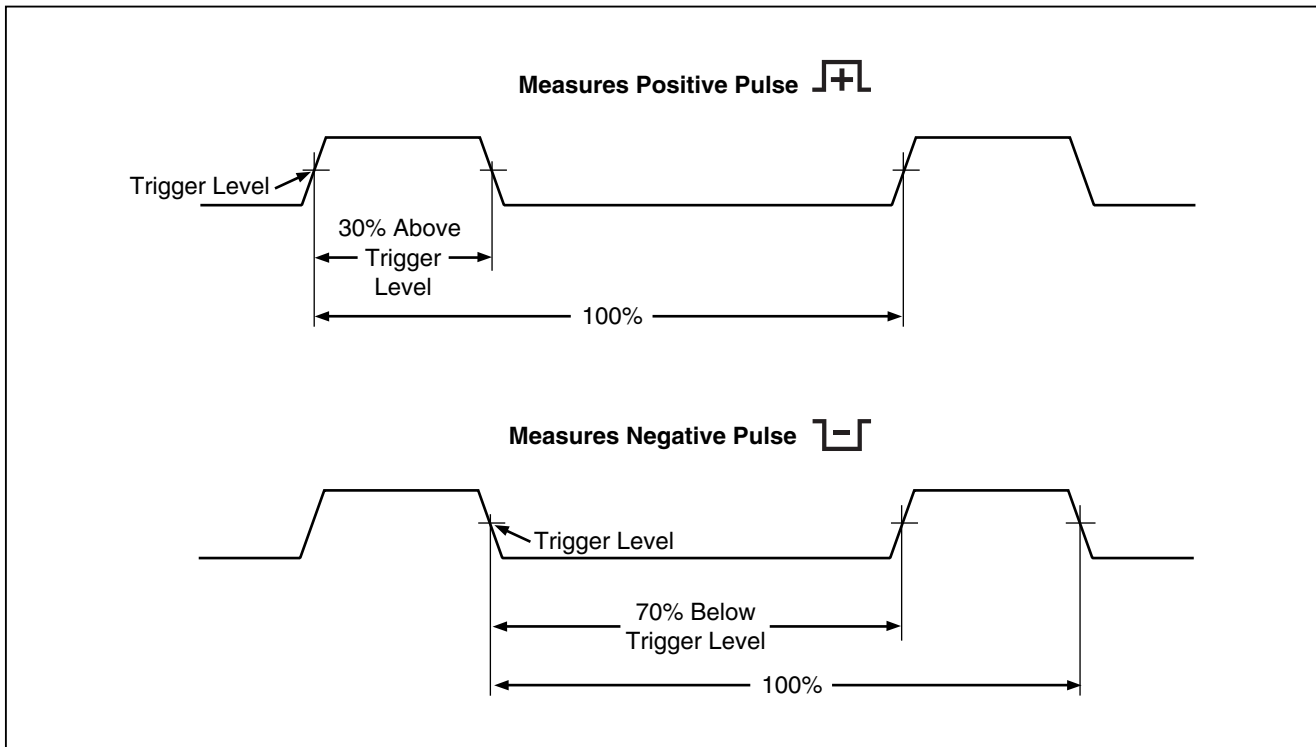

est28.eps

Figure 25. Duty Cycle Measurements

To measure duty cycle, position the rotary switch on one of the functions allowing frequency measurements shown in Figure 23. Press the softkey labeled **Menu** and move the menu selector to the menu item labeled **Hz,%ms**. Next press the softkey labeled **%**.

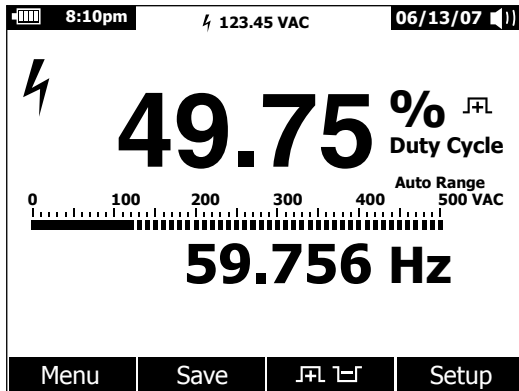

est24.eps

Figure 26. Duty Cycle Display

As shown in Figure 26, the duty cycle percentage is shown in the primary display while the signal frequency appears in the secondary display. The mini-measurement display indicates the

volts or amps value of the input signal. The bar graph tracks the volts or amps value of the signal and not the duty cycle value.

The pulse polarity is displayed to the right of the duty cycle value. ⏏ indicates a positive pulse and ⏏ indicates a negative pulse. To change the polarity being measured, press the softkey labeled ⏏ ⏏ . The polarity indicator changes to the opposite polarity.

For 5 V logic signals, use the 5 V dc range. For 12 V switching signals in automobiles, use the 50 V dc range. For sine waves, use the lowest ac or dc range that does not result in multiple triggering. A manually-selected lower input range will often measure better than the AUTO-selected input range.

Measuring Pulse Width

The pulse width function measures the amount of time a signal is high or low, as shown in Figure 27. The measured waveform must be periodic; its pattern must repeat at equal time intervals.

The meter measures pulse width from 0.025 ms to 1250.0 ms ranges.



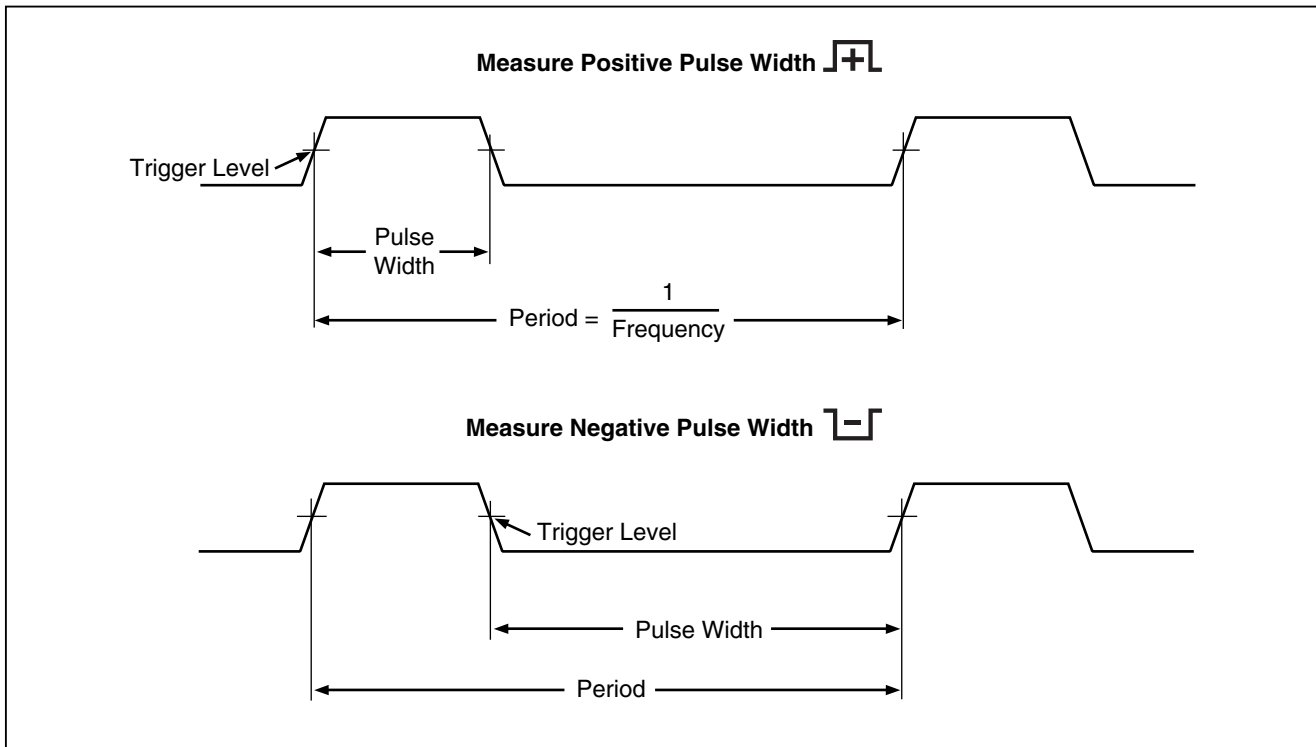

To measure pulse width, position the rotary switch to one of the functions allowing frequency measurements shown in Figure 23. Press the softkey labeled **Menu** and move the menu selector to the menu item labeled **Hz,%ms**. Next, press the softkey labeled **ms**.



est27.eps

Figure 27. Pulse Width Measurements

The primary display indicates the input signals pulse width in milliseconds. The frequency of the signal is displayed in the secondary display. The mini-measurement display indicates the volts or amps value of the input signal. The bar graph tracks the volts or amps value of the signal and not the pulse width value.

The pulse width polarity is displayed to the right of the duty cycle value.  indicates a positive pulse width and  indicates a negative pulse. To change the polarity, press the softkey labeled  . The polarity indicator changes to the opposite polarity.

Changing Meter Setup Options

The Meter has a number of preset features such as date and time formats, backlight and battery save mode timeouts, and the displayed language. These variables are referred to as Meter setup options. Many setup options affect general Meter operations and are active in all functions. Others are limited to one function or group of functions.

Access to the setup options is always available through the softkey labeled **Setup**. Information about the Meter, such as serial number, model, for example, is also accessed through the setup menu.

Resetting Meter Setup Options

The Meter's setup options can be reset to default values through the setup menu. Open the setup menu by pressing the softkey labeled **Setup**. Position the menu selector next to the menu item labeled **Reset** and press the softkey labeled **Setup**. A message will appear asking to confirm the reset action. Press the softkey labeled **OK** to perform the reset.



Note

A setup reset also resets the temperature offset and dBm reference to their default value.



In addition to resetting the setup variables, pressing the softkey labeled **Meter** will also clear all saved measurement screens, MIN MAX screens, peak screens, and recording records. The Meter's clock is reset to a default value as well.

Setting Display Contrast

Meter display contrast can be adjusted through the Meter's setup menu. Open the setup menu by pressing the softkey labeled **Setup** and position the menu selector next to the menu item labeled **Contrast**. Pressing the softkey labeled **+** (F1) increases display contrast, while the softkey labeled **-** (F2) decreases contrast.

Contrast can also be set through the  and  buttons when not being used to move between menu selections.

Setting the Meter's Language

The Meter comes from the factory with the display language set to English. To select another language, open the setup menu by pressing the softkey labeled **Setup**. Move the menu selector next to the menu item labeled **Display**. Next, press the softkey labeled **Format** (F2) to open the format menu. If not already selected, move the menu selector to the left of the menu item labeled **Language** and press the softkey labeled **Edit**. The currently selected language becomes highlighted and  appears to the right of the language. Use  and  to scroll through the available languages, then press the softkey labeled **OK** to set the Meter's display language. Press the softkey labeled **Close** to return to normal Meter operation.

Setting Date and Time

The Meter's internal clock is used in the display and for time-stamping recorded measurements. To change the date and time as well as the display format, press the softkey labeled **Setup**. Position the menu selector next to the menu item labeled **Display**. To set the date and time, press the softkey labeled **Date/Time** to open the date/time menu. Next, position the menu selector next to either the **Set Date** item or **Set Time** item and press the softkey labeled **Edit**. Using \leftarrow and \rightarrow , position the cursor on the date or time element to adjust. Use \uparrow and \downarrow to change the selected date or time element value. Press **OK** to complete the action.

Setting Backlight and Auto Off Timeouts

The Meter's backlight and auto off features use timers to determine when to turn off the backlight, when to automatically turn the Meter off or enable the battery saver mode. To set these timeouts, press the softkey labeled **Setup** and position the menu selector next to the menu item labeled **Instrument**. Position the menu selector next to the menu item labeled **Auto Backlight Timeout** or **Auto Power Off** and then press the softkey labeled **Edit**. Use \uparrow and \downarrow to adjust the time to one of the preset values. Press **OFF** to disable the timeout feature. Press the softkey labeled **OK** to set the selected time. Press the softkey labeled **Close** to return to normal Meter operation.

The battery-saver mode is used when the Meter is performing a recording session or during MIN MAX, Peak record and AutoHold. The battery-saver mode powers down circuits that are not involved in the operation of these recording sessions, including the display. For the record mode, the timeout period is set to five minutes and is enabled only when the Auto Power Off

timeout is set to a value other than Off. For MIN MAX, Peak, and AutoHold, the timeout is the time period set for Auto Off.

Setting a Custom dBm Reference

To add a custom dBm reference value, press the softkey labeled **Setup** and position the menu selector next to the menu item labeled **Instrument**. Next press the softkey labeled **Instrument** and position the menu selector next to the menu item labeled **dBm Reference**. Next, press the softkey labeled **Edit**. Use \leftarrow and \rightarrow to position the cursor on a specific digit. Press \uparrow and \downarrow to increment or decrement the digit. With the desired reference displayed, press the softkey labeled **OK** to add this value to the dBm reference list. Only one custom value is allowed. Press the softkey labeled **Close** to return to normal Meter operation.

Disabling and Enabling the Beeper

The Meter's beeper alerts users to the presence of messages, operator errors such as incorrect lead connections for the selected function, and newly sensed values for MIN MAX and Peak recording. Although the beeper is also used for the continuity function, controlling the beeper for that function is not done through this setup option. See the "Testing for Continuity" section for information on the continuity beeper.

To enable or disable the Meter's beeper, press the softkey labeled **Setup** and position the menu selector next to the menu item labeled **Instrument**. Next press the softkey labeled **Instrument** and position the menu selector next to the menu item labeled **Beeper**. Press the softkey labeled **Edit** to move the cursor to the on or off selection. Use \uparrow and \downarrow to switch the beeper on or off. The status of the beeper is indicated in the display's status bar (see item 12 in Figure 2).

Enabling and Disabling the Smoothing Mode

When an AC input signal is noisy or changes rapidly, the smoothing mode may display a steadier reading. To enable or disable the smoothing mode, press the softkey labeled **Setup** and position the menu selector next to the menu labeled **Instrument**. Next press the softkey labeled **Instrument** and position the menu selector next to the menu item labeled **Smoothing**. Press the softkey labeled **Edit** to move the cursor to the on or off selection. Use \leftarrow and \rightarrow to switch the smoothing mode on or off.

Using Other Setup Options

Additional setup options hold information about the Meter as well as some general Meter functions. The **Meter Info** selection lists the serial number, model number, firmware version, calibration date, and calibration counter. Operator name, company name, site name, and contact information are also displayed when this information has been loaded into the Meter from FlukeView® Forms software.

The **Calibration** selection allows a qualified calibration technician to enter a password that allows the Meter to be calibrated. See the *287/289 Calibration Information* document to calibrate the Meter.

The **Secure Erase** option allows user-accessible memory to be erased as required by Homeland Security regulations. Meter calibration is not lost when this low-level erase is performed.

As new Meter features are created, the latest version of software can be downloaded to the Meter from Fluke's support web page using the **Software Update** option.

Using Memory

The Meter has memory for storing individual measurements, measurements collected over a specified duration, and measurement events.

All stored data can be viewed on the Meter or downloaded to a PC through the Meter's infrared (IR) communication link using FlukeView™ Forms. See the "Using Communications" section for more information on communicating with a PC through FlukeView Forms software.

Storing Individual Measurement Data

For all measurement functions, a snapshot of the screen data is saved by pressing the softkey labeled **Save**. Except for the mini-measurement in the status bar, the display freezes and the Save menu appears. Two choices allow either saving the data under a previously selected name or choosing another name by pressing the softkey labeled **+Name**. See the "Naming Saved Data" section later in this manual. The displayed data is stored along with the date and time of day the save was performed.

For MIN MAX and Peak, the displayed summary data can be stored at any time by pressing the softkey labeled **Save**, thus preserving a snapshot of the session at that moment.

Naming Saved Data

The Meter has a list of eight preset names under which measurement data is saved. Multiple records can be saved using the same name. For example, one preset name is Save. The first time a save operation is performed with that name, Save-1 is used to name the record in memory. The next time the Save name is used, the number increments to 2 and the record is

saved under the name of Save-2. The auto-incrementing number can be reset to 1 by positioning the menu selector next to the save name and then pressing the softkey labeled **Reset #**.

To save a screen shot, a recording session, or MIN MAX or Peak record session, press the softkey labeled **Save**. To select the name from the preset list, press **+Name**. To save to the same name as before but with the next number, press the softkey labeled **Save**. This second method makes it easy to save a series of measurements simply by pressing the **Save** softkey twice for each save operation.

When selecting the name for a save operation, position the menu selector next to the desired name using the cursor buttons. Next press the softkey labeled **Save**.

Viewing Memory Data

Viewing data stored in the Meter's memory is performed through the save menu. Press the softkey labeled **Save**. Position the menu selector next to the menu item labeled **View Memory** and press the softkey labeled **View**.

Note

To view data stored in memory, the Meter must not be recording or performing a MIN MAX or peak record session.

The Meter separates stored data into four different categories: Measurement, MIN MAX, Peak, and Recording. Use the cursor buttons to position the menu selector next to the desired saved data category and then press the softkey labeled **View**. The Meter displays the last record saved for the selected data category.

If there are previously stored records, press the softkey labeled **Prev** or \leftarrow to page back through previously stored records. Press the softkey labeled **Next** or \rightarrow to page in the other direction. Press **Close** to return to normal Meter operation.

Viewing Snapshot and Summary Data

After selecting the MIN MAX, Peak, or Measurement category described in the Viewing Memory Data section above, pressing **View** only displays the information stored at the time a Save was performed. The display is reconstructed from this data when viewed.

Viewing Trend Data

For the Recording category, the interval and event data stored during a recording session are viewed on the Meter through a trend-plot view, similar to a strip-chart recorder. See the "Recording Measurement Data" section later in this manual for an explanation of interval and event data.

After selecting the recording category described in the Viewing Memory Data section above and pressing **View**, the recording session's summary screen is displayed (See Table 9). Press the softkey labeled **Trend** to display the recorded data in a trend-plot view. Table 7 shows the trend view along with a description of each of its components.

To look at data stored in the individual records that make up the trend, move the cursor to any point along the plot by pressing \leftarrow or \rightarrow . The value and timestamp of the minimum, maximum, and end-of-record values of the selected record are displayed at the bottom of the cursor. All data contained in a record can only be viewed on a PC running FlukeView Forms.

Note

X-axis time labels are shown in elapsed time while the timestamp shown under the cursor is an absolute time

Table 7. Trend Data Display

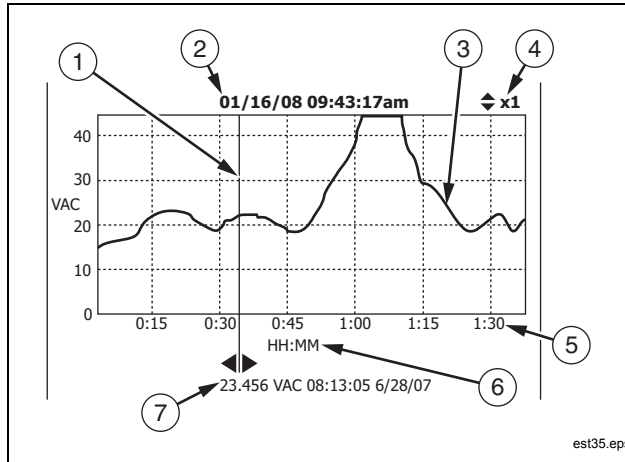

Item	Description
①	Cursor
②	Start date and time
③	Trend line
④	Zoom level.

⑤	Elapsed time. Units in hours and minutes, or minutes and seconds.
⑥	Time scale legend (HH:MM or MM:SS)
⑦	Measured value and timestamp of selected record.

Zooming in on Trend Data

While viewing trend data, pressing \odot or \ominus zooms in or out respectively on the data around the cursor. Each press of \odot reduces the x-axis time period by one half to reveal more details. Each press of \ominus doubles the time period until all the recorded data is displayed. The zoom level is displayed in the upper-right hand corner of the display. X1 indicates the trend of the complete recording period is displayed. X2 is one-half the recording time. X3 is one-fourth the recording time. This magnification can continue until the x-axis time period is one second.

Deleting Stored Measurement Data

Deleting data stored in the Meter's memory is performed through the save menu. Use the softkey labeled **Save**. Use the softkey labeled **Prev** and **Next** to select an item for deletion.

The Meter separates stored data into four different categories: Measurement, MIN MAX, Peak, and Recording. Use the cursor buttons to position the menu selector next to a saved data category and then press the softkey labeled **View** to view the item.

Pressing the softkey labeled **Delete All** will delete all stored data under the selected saved data category. Or press the softkey labeled **View**. After accepting a confirmation message, use the

softkeys labeled **Prev** and **Next** to select an item for deletion. Next, press the softkey labeled **Delete**. A message asking to confirm the deletion will appear before anything is deleted from memory.

Recording Measurement Data

The Meter's record feature collects measurement information over a user-specified duration. This collection of information is called a recording session. A recording session is made up of one or more measurement records. Each record contains measurement summary information covering the duration of the record.

Each record contains the minimum, maximum, and average value detected over the record's duration. In addition to measurement values, time stamps are also captured and saved with each record. The time stamps consist of the record start time, the time the maximum value was detected, the time the minimum value was detected, and the record end time.

Some of a records data can be viewed through the Meter's Viewing Trend Data function. Viewing all the data that makes up a record can only be viewed on a PC running FlukeView Forms software.

There are two measurement record types that are captured during a recording session: interval and event. An interval record covers a user-specified interval. An event record has a duration determined by the activity of the measured signal and can interrupt an interval record. Even if an interval record is interrupted, a record will end and a new interval record will begin when the scheduled interval time expires.

Event records are triggered by the measured signal varying more than an adjustable percentage of the value measured at the start of the record. This adjustable percent is called the Event Threshold for recording. In addition to the values and time stamps mentioned above, an event record also stores whether the signal was stable or unstable during the event record duration. To be classified as stable, the measured signal's value must stay within the selected percentage of the start value for at least one second. Measured signals that exceed the percentage threshold in less than one second are classified as unstable. See the "Setting the Event Threshold Value" section later in this manual.

Note

For temperature measurements, the AutoHold threshold is a percent of 100 degrees. The default AutoHold threshold is 4% of 100 degrees, or 4 degrees Celsius or Fahrenheit.

A record ends when one of the following occurs:

- The start of a new interval record.
- A range overload, causing the Meter to change range.
- A non-ranging overload, when in manual range or the highest range.
- The measured value changes more than 4 % of the measured value at the start of the record.
- The recording session terminates.

A recording session termination can be caused by one of the following:

- Recording session duration expiring.
- Manually stopping the recording session.

Setting up a Recording Session

Before starting a recording session, setup the Meter for the measurements to be recorded. If needed, change the event threshold value (see the “Setting the Event Threshold Value section later in this manual). Press the softkey labeled **Save** to open the save menu. Using the cursor buttons, move the menu selector next to the menu item labeled **Record** and press the softkey labeled **Record** to open the configuration display.

There are two variables in setting up a recording session: Recording session duration, and sample interval duration. Both variables affect the recording length and number of intervals recorded. These two variables may interact, in that setting one variable may adjust the other variable to fit the recording session within the available memory. The percentage of memory available at the beginning of a recording session is displayed below the duration and sample interval settings. Option values can be adjusted as follows:

The sample interval can be set from one second to 99 minutes and 59 seconds. Recording session duration can be set from one minute to 99 days 23 hours 59 minutes.

Table 8. Recording Display

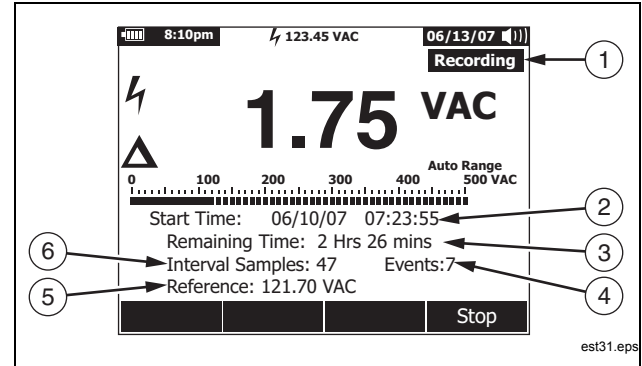

Item	Description
①	Recording session in progress icon.
②	Time and date when recording session started.
③	Time remaining until recording session stops.
④	Total number of event records recorded so far.
⑤	Reference value for relative measurements.
⑥	Total number of interval records recorded so far.

The Meter allocates memory in such a way as to guarantee capturing all of the user-specified sample intervals. Event records will also be captured until the Meter detects the allocated memory has been used up. At this point, events are not recorded, but the event counter continues to advance to indicate the total number of events that occurred. A plus (+) sign appears after the event count to indicate this condition.

Note

The maximum number of recorded sample intervals is 10,000. The maximum number of recorded events is 15,000 minus the number of sample intervals. These maximum numbers are proportionally decreased when the available memory is low.

To change either of the two recording variables, use the cursor buttons to position the menu selector next to the desired menu item and press the softkey labeled **Edit**. Use \leftarrow \rightarrow \uparrow and \downarrow to move between and set each digit of the selected variable.

If the battery level is anything but full, a message appears at the bottom of the record menu reminding you of the battery level before you start the recording session.

Setting the Event Threshold Value

Press the softkey labeled **Setup** to access the setup menu. Using the cursor buttons, move the menu selector next to the menu item labeled **Recording** and press the softkey labeled **Recording** to open the recording setup screen. Using the cursor buttons, move the menu selector next to the menu item labeled **Event Threshold for Recording** and then press the softkey labeled **Edit**. Press \uparrow or \downarrow to scroll through the event threshold

values. With the desired value selected, press the softkey labeled **Close**.

Starting a Recording Session

Once the variables are set, press the softkey labeled **Start**, at which point **Recording** appears in the display and the green LED surrounding the power button (Ⓢ) flashes. Table 8 shows the recording display and describes the information displayed.

The Menu, Setup, Reference, and Temperature Offset softkey functions are not available while the Meter is recording. This ensures that measurements within a recording session are consistent.

To extend battery life while recording, the Meter may enter a battery-saver mode five minutes after a push-button is pressed or IR communications activity ends. If the Auto Power-Off timeout is set to never, the battery-saver mode is disabled.

Stopping a Recording Session

The recording session will continue until the allocated memory is used, the batteries expire, the rotary switch is moved, a probe is inserted or removed from the A or mA/ μ A jacks, or the session is terminated by pressing the softkey labeled **Stop**.

Table 9 shows the display and describes the displayed information after stopping a recording session.

After stopping a recording session, choose to save the recording session, view the trend data (see the “Viewing Trend Data” section), or close the recording session. If the session wasn’t saved before pressing the **Close** softkey, the data is lost.

Table 9. Stopped Recording Display

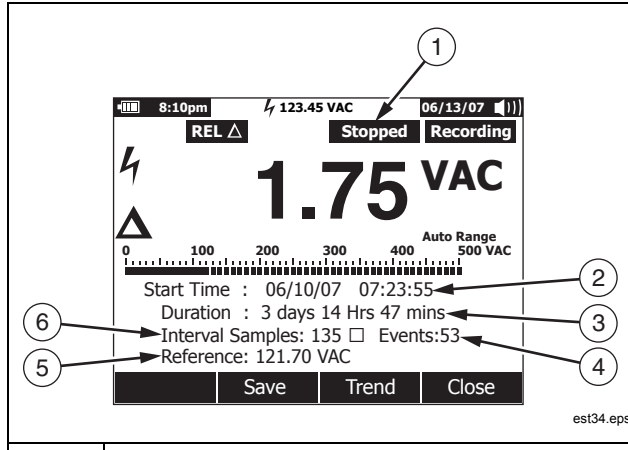

Item	Description
①	Stopped Icon indicating the recording session is stopped.
②	Time and date when the recording began.
③	Length (duration) of time recording session was in progress.
④	Number of event records detected.
⑤	Reference value for relative measurements.
⑥	Number of interval records detected.

Using Communications

You can use the IR communication link and *FlukeView Forms* software to transfer the contents of a meter's memory to a PC.

When using a PC-to-meter IR (infrared) communication link, refer to the *FlukeView Forms Installation Guide* or the on-line help.

Note

The Meter will log in real-time mode to a connected computer running FlukeView Forms. In addition, the Meter allows the user to log to internal memory and connect to the computer later for download.

FlukeView Forms allows you to place the data into standard (default) or customized forms. The forms display the data in table and graph form, as well as show user comments. You can use these forms to satisfy ISO-9000 and other documentation requirements.

Error Messages

Table 10 list some of the error messages the Meter may display and the conditions that may be causing the error.

Table 10. Error Messages

Message	Conditions
Leads connected incorrectly.	Lead in A or mA/ μ A jack but rotary switch not in corresponding A/mA or μ A position. Leads in both A and mA/ μ A jacks. Rotary switch set to measure current but no lead in either A or mA/ μ A jack.
Open Thermocouple	Thermocouple wire is open or thermocouple junction is corroded. No Thermocouple connected to the Meter's input.
Batteries low – function unavailable.	The function selected requires a higher battery level to operate within specifications.
Error: Date and Time need to be reset.	Batteries were left out too long and the Meter's date and time were lost.
Not enough memory for operation.	When starting a recording session or saving screen data, the Meter does not have enough memory to store the information.
Batteries critically low, replace now.	Battery is too low to make measurements within stated specifications. The Meter will turn off within 15 seconds after this message appears to preserve the Meter's date and time.

Maintenance

Warning

To avoid electrical shock or personal injury, repairs or servicing not covered in this manual should be performed only by qualified personnel as described in the 287/289 Service Information.

General Maintenance

Periodically wipe the case with a damp cloth and mild detergent. Do not use abrasives, isopropyl alcohol, or solvents.

Dirt or moisture in the terminals can affect readings and can falsely activate the Input Alert feature. Clean the terminals as follows:

1. Turn the Meter off and remove all test leads.
2. Shake out any dirt that may be in the terminals.
3. Soak a clean swab with mild detergent and water. Work the swab around in each terminal. Dry each terminal using canned air to force the water and detergent out of the terminals.

Testing the Fuses

As shown in Figure 28, with the Meter in the Ω_{ns} function, insert a test lead into the Ω jack and place the probe tip on the other end of the test lead against the metal of the current input jack. If the “Leads Connected Incorrectly” message appears, the probe tip has been inserted too far into the amps input jack. Back the lead out a bit until the message disappears and either OL or a resistance reading appears in the Meter’s display. The resistance value should be between 0.00 and 0.50 Ω for the A jack and 10.00 \pm 0.05 k Ω for the mA jack.

Warning

To avoid electrical shock or personal injury, remove the test leads and any input signals before replacing the battery or fuses. To prevent damage or injury, install *only* Fluke specified replacement fuses with the amperage, voltage, and speed ratings shown in Table 11.

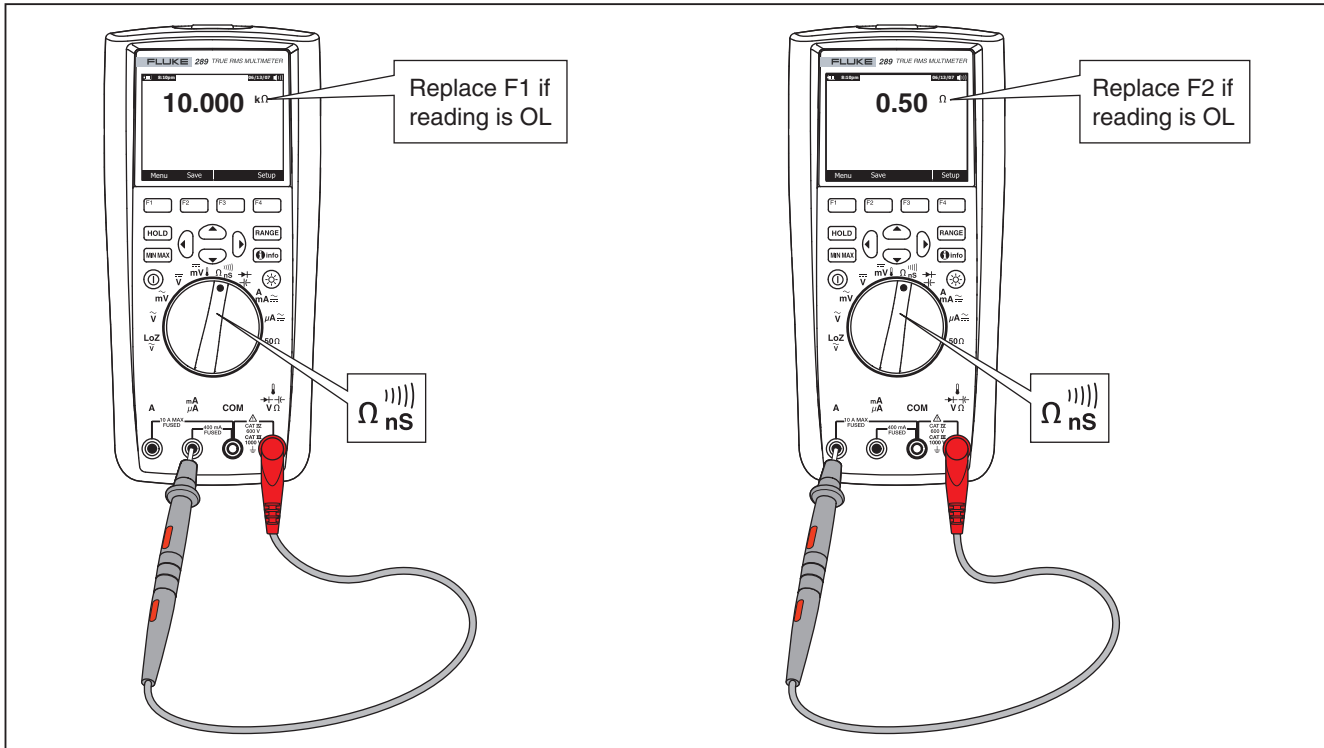

Figure 28. Testing the Current Fuses

est33.eps

Replacing the Batteries

Refer to Figure 30 and replace the batteries as follows:

1. Turn the Meter off and remove the test leads from the terminals.
2. Remove the battery door assembly by using a standard-blade screwdriver to turn the battery door screw one-half turn counterclockwise.
3. Replace the batteries with 1.5 volt AA batteries (NEDA 15A IEC LR6). Observe proper polarity.
4. Reinstall the battery door assembly and secure it by turning the screw one-half turn clockwise.

Replacing the Fuses

Referring to Figure 30, examine or replace the Meter's fuses as follows:

1. Turn the Meter off and remove the test leads from the terminals.
2. Remove the battery door assembly by using a standard-blade screwdriver to turn the battery door screw one-half turn counterclockwise.
3. Remove the fuse by gently prying one end loose, then sliding the fuse out of its bracket.
4. Install *only* Fluke specified replacement fuses with the amperage, voltage, and interrupt ratings shown in Table 11.
5. Reinstall the battery door assembly and secure it by turning the screw one-half turn clockwise.

Test Lead Storage

Figure 29 shows the proper method for storing the test leads with the Meter.

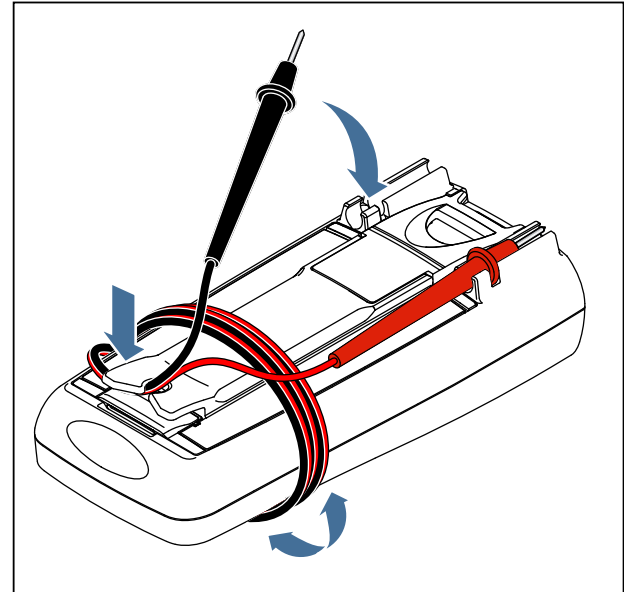

Figure 29. Test Lead Storage

est41.eps

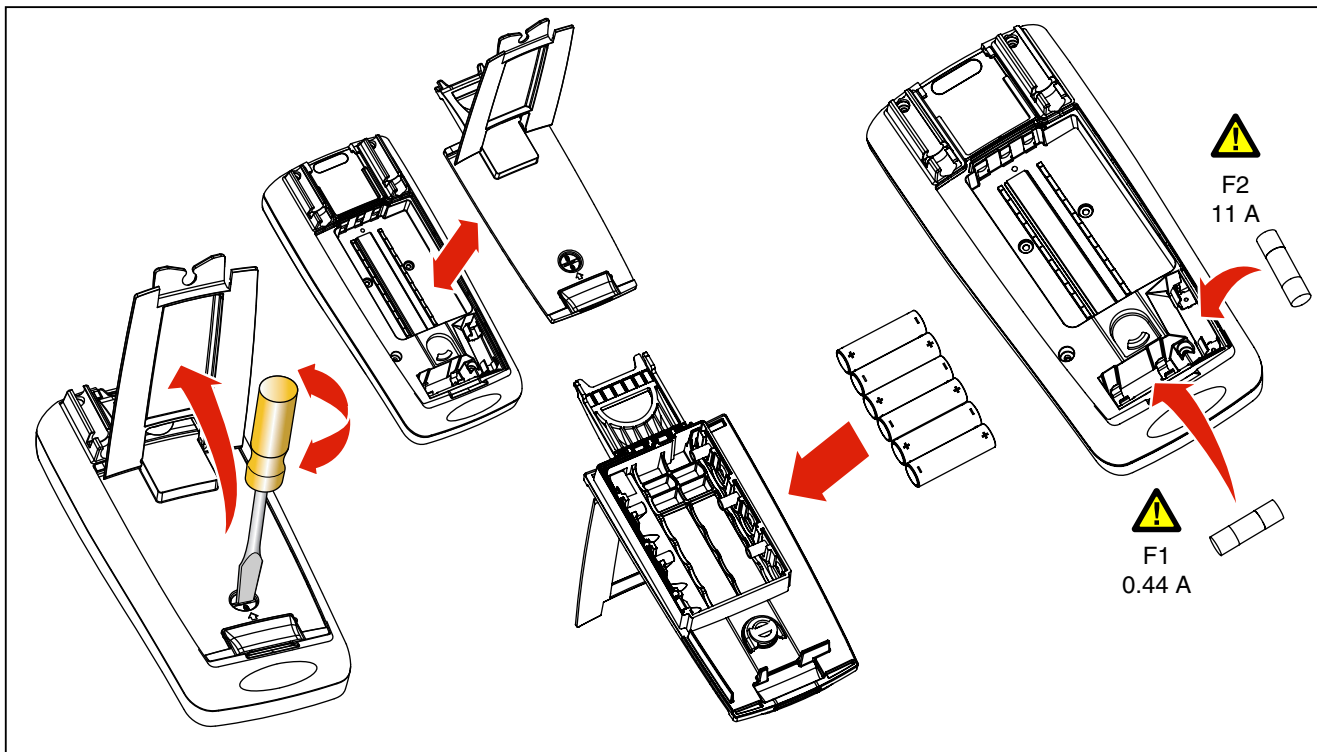

Figure 30. Replacing Batteries and Fuses

est32.eps

In Case of Difficulty

If the Meter does not seem to work properly:

1. Check that all batteries are installed with the correct polarity.
2. Examine the case for damage. If damage is detected, contact Fluke. See the "Contacting Fluke" section earlier in this manual.
3. Check and replace (as needed) the batteries, fuses, and test leads.
4. Review this manual to verify correct operation.
5. If the Meter still does not work, pack it securely and forward it, postage paid, to the location provided by the appropriate Fluke contact. Include a description of the problem. Fluke assumes no responsibility for damage in transit.

A Meter under warranty will be repaired or replaced (at Fluke's option) and returned at no charge. See the registration card for warranty terms.

Service and Parts

Replacement parts and accessories are shown in Tables 11 and 12 and Figure 31. To order parts and accessories, refer to the “Contacting Fluke” section.

Table 11. Replacement Parts

Item	Description	Qty.	Fluke Part/Model Number	
1	Knob	1	2798434	
2	Skin	1	2798418 (289) 2798429 (287)	
3	Keypad	1	2578234	
4	O-Ring	1	2740185	
5	Case Top	1	2578178	
6	Screw, Phillips	5	2743764	
7	Mask, LCD	1	2760673 (289) 2798407 (287)	
8	LCD Module	1	2734828	
9	Shock Absorber	3	2793516	
10	Spring Detent	1	2723772	
11	RSOB Housing, Upper	1	2578283	
12	Shield	Upper	1	2578252
		Lower	1	2578265

Table 11. Replacement Parts (cont.)

Item	Description	Qty.	Fluke Part/Model Number
13	RSOB Housing, Lower	1	2578290
14	Case Bottom	1	2578184
15	Shock Absorber, Battery Compartment	1	2793525
16	Battery Contact, Negative	2	2578375
17	Battery Contact, Positive	1	2578353
18	⚠ Fuse (F1), 0.440 A, 1000 V, FAST, Interrupt rating 10 kA	1	943121
19	⚠ Fuse (F2), 11 A, 1000 V, FAST, Interrupt rating 20 kA	1	803293
20	Battery, 1.5 V NEDA 15C/15F or IEC R6S	6	376756
21	Battery Door Assembly (includes tilt bail)	1	2824477
22	Screw, Phillips	7	853668
23	TL71 Right-Angle Test Lead Set	1	TL71
24	Alligator Clips, one black and one red	2	1670652 (Black) 1670641 (Red)
25	Manual, Manual Pack, Fluke 287/289	1	2748851
26	287/289 Users Manual CD ^[1]	1	2748872

⚠ To ensure safety, use exact replacement only.

[1] The Users and Getting Started manuals are available through www.Fluke.com. Click on **Support** and then **Product Manuals**.

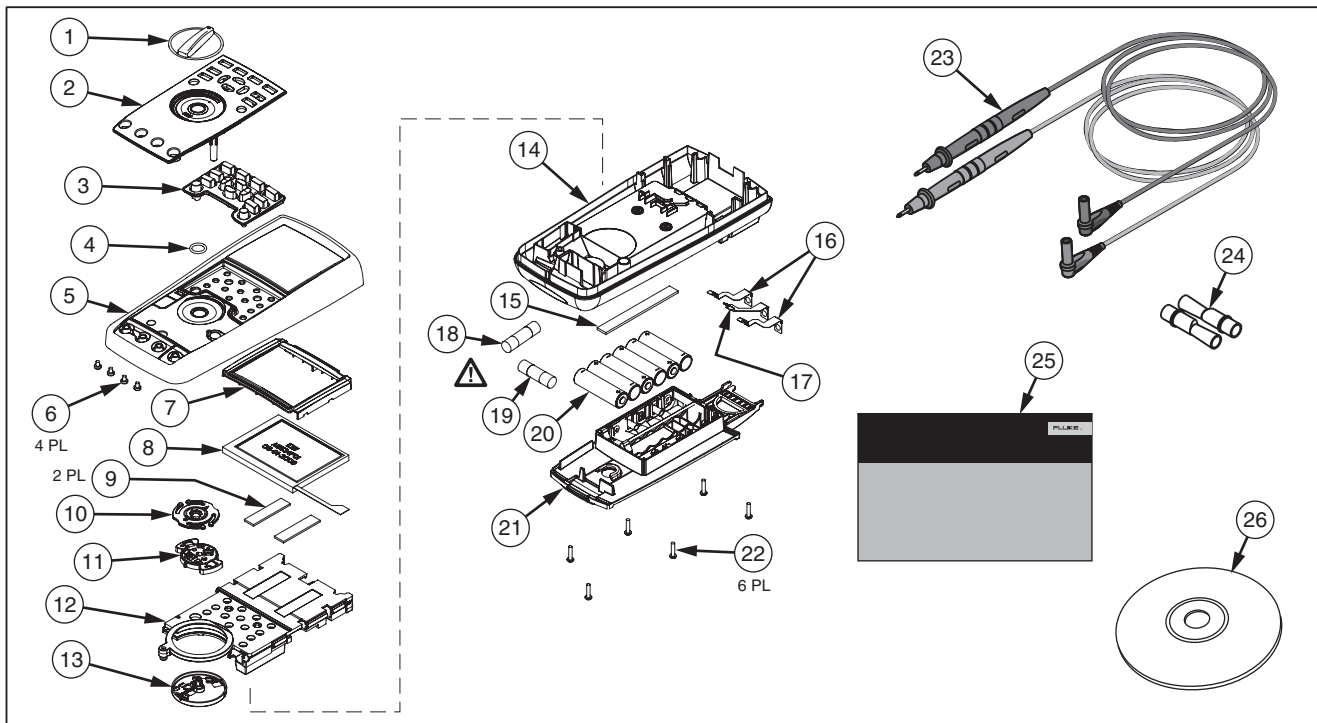

Figure 31. Replaceable Parts

est40.eps

Table 12. Accessories

Item	Description
AC72	Alligator Clips for use with TL75 test lead set
AC220	Safety Grip, Wide-Jaw Alligator Clips
80BK-A	80BK-A Integrated DMM Temperature Probe
TPAK	ToolPak Magnetic Hanger
C25	Carrying Case, Soft
TL76	4 mm Diameter Test Leads
TL220	Industrial Test Lead Set
TL224	Test Lead Set, Heat-Resistant Silicone
TP1	Test Probes, Flat Blade, Slim Reach
TP4	Test Probes, 4 mm diameter, Slim Reach
Fluke accessories are available from an authorized Fluke distributor.	

General Specifications

Maximum voltage between any Terminal and Earth Ground: 1000 V

⚠ **Fuse Protection for mA or μ A inputs** 0.44 A (44/100 A, 440 mA), 1000 V FAST Fuse, Fluke specified part only

⚠ **Fuse Protection for A input**..... 11 A, 1000 V FAST Fuse, Fluke specified part only

Battery Type 6 AA Alkaline batteries, NEDA 15A IEC LR6

Battery Life 100 hours minimum. 200 hours in Logging mode

Temperature

Operating -20 °C to 55 °C

Storage..... -40 °C to 60 °C

Relative Humidity 0 % to 90 % (0 °C to 37 °C), 0 % to 65 % (37 °C to 45 °C), 0 % to 45 % (45 °C to 55 °C)

Altitude

Operating 3,000 m

Storage..... 10,000 m

Temperature Coefficient..... 0.05 X (specified accuracy) /°C (<18 °C or >28 °C)

Vibration..... Random Vibration per MIL-PRF-28800F Class 2

Shock 1 meter drop per IEC/EN 61010-1 2nd Edition

Size (HxWxL) 8.75 in x 4.03 in x 2.38 in (22.2 cm x 10.2 cm x 6.0 cm)

Weight 28.0 oz (871 g)

Safety Standards

US ANSI..... Complies with ANSI/ISA 82.02.01 (61010-1) 2004

CSA..... CAN/CSA-C22.2 No 61010-1-04 to 1000 V Measurement Category III and 600 V
Measurement Category IV, Pollution Degree 2

UL..... UL 61010 (2003)



CE European..... IEC/EN 61010-1 2nd Edition Pollution Degree 2

Electromagnetic Compatibility Standards (EMC)

European EMC.....EN61326-1

Australian EMC  N10140

US FCC.....FCC CFR47: Part 15 CLASS A

CertificationsUL, CE, CSA, , (N10140),  

Detailed Specifications

Accuracy:

Accuracy is specified for a period of one year after calibration, at 18 °C to 28 °C (64 °F to 82 °F), with relative humidity to 90 %. Accuracy specifications are given as: ±([% of reading] + [number of least significant digits]). Accuracy specification assumes ambient temperature stable at ±1 °C. For ambient temperature changes of ±5 °C, rated accuracy applies after 2 hours. To obtain full accuracy in DC mV, Temperature, Ohms and Lo (50) Ohms, let the meter stabilize 20 minutes after using LoZ.

True-rms:

AC mV, AC V, AC μA, AC mA, and AC A specifications are ac-coupled, true rms, and are specified from 2 % of range to 100 % of range, except 10 A range is specified from 10 % to 100 % of range.

Crest Factor:

Accuracy is specified with AC crest factor ≤ 3.0 at full-scale, increasing linearly to 5.0 at half-scale, except the 1000 V range, where it is 1.5 at full scale, increasing linearly to 3.0 at half-scale and 500 mV and 5000 μA, where it is ≤3.0 at 80 % of full scale, increasing linearly to 5.0 at half-scale. For non-sinusoidal waveforms add ±(0.3 % of range and 0.1 % of reading).

AC Floor:

When the input leads are shorted together in the ac functions, the Meter may display a residual reading up to 200 counts. A 200 count residual reading will cause only a 20 count change for readings at 2 % of range. Using REL to offset this reading may produce a much larger constant error in later measurements.

AC+DC:

AC+DC is defined as $\sqrt{ac^2 + dc^2}$

AC Voltage Specifications

Function	Range	Resolution	Accuracy				
			20 to 45 Hz	45 to 65 Hz	65 Hz to 10 kHz	10 to 20 kHz	20 to 100 kHz
AC mV	50 mV ^[1]	0.001 mV	1.5 % + 60	0.3 % + 25	0.4 % + 25	0.7 % + 40	3.5 % + 40 ^[5]
	500 mV	0.01 mV	1.5 % + 60	0.3 % + 25	0.4 % + 25	0.7 % + 40	3.5 % + 40
AC V	5 V ^[1]	0.0001 V	1.5 % + 60	0.3 % + 25	0.6 % + 25	1.5 % + 40	3.5 % + 40 ^[5]
	50 V ^[1]	0.001 V	1.5 % + 60	0.3 % + 25	0.4 % + 25	0.7 % + 40	3.5 % + 40
	500 V ^[1]	0.01 V	1.5 % + 60	0.3 % + 25	0.4 % + 25	Not Spec'd	Not Spec'd
	1000 V	0.1 V	1.5 % + 60	0.3 % + 25	0.4 % + 25	Not Spec'd	Not Spec'd
dBV	-70 to -62 dB ^[3]	0.01 dB	3 dB	1.5 dB	2 dB	2 dB	3 dB
	-62 to -52 dB ^[3]	0.01 dB	1.5 dB	1.0 dB	1 dB	1 dB	2 dB
	-52 to -6 dB ^[3]	0.01 dB	0.2 dB	0.1 dB	0.1 dB	0.2 dB	0.8 dB
	-6 to +34 dB ^[3]	0.01 dB	0.2 dB	0.1 dB	0.1 dB	0.2 dB	0.8 dB
	34 to 60 dB ^[3]	0.01 dB	0.2 dB	0.1 dB	0.1 dB	Not Spec'd	Not Spec'd
Low pass filter ^[4]			2 % + 80	2 % + 40	2 % + 10 -6 % -60 ^[2]	Not Spec'd	Not Spec'd
LoZ ^[4] V	1000 V	0.1 V	2 % + 80	2 % + 40	2 % + 40 ^[6]	Not Spec'd	Not Spec'd

[1] Below 5 % of range, add 20 counts.

[2] Specification increases linearly from -2 % at 200 Hz to -6 % at 440 Hz. Range is limited to 440 Hz.

[3] dBm (600 Ω) is specified by adding +2.2 dB to the dBV range values.

[4] 289 only.

[5] Add 2.5 % above 65 kHz.

[6] Range is limited to 440 Hz.

See Detailed Specifications introduction for additional information.

AC Current Specifications

Function	Range	Resolution	Accuracy			
			20 to 45 Hz	45 to 1 kHz	1 to 20 kHz	20 to 100 kHz ^[4]
AC μ A ^[3]	500 μ A	0.01 μ A	1 % + 20	0.6 % + 20	0.6 % + 20	5 % + 40
	5000 μ A	0.1 μ A	1 % + 5	0.6 % + 5	0.6 % + 10	5 % + 40
AC mA ^[3]	50 mA	0.001 mA	1 % + 20	0.6 % + 20	0.6 % + 20	5 % + 40
	400 mA	0.01 mA	1 % + 5	0.6 % + 5	1.5 % + 10	5 % + 40
AC A ^[2]	5 A	0.0001 A	1.5 % + 20	0.8 % + 20	3 % + 40 ^[4]	Not Spec'd
	10 A ^[1]	0.001 A	1.5 % + 5	0.8 % + 5	3 % + 10 ^[4]	Not Spec'd

[1] 10 A range (10 % to 100 % of range).
 [2] 20 A for 30 seconds on, 10 minutes off. >10 A not specified.
 [3] 400 mA continuous; 550 mA for 2 minutes on, 1 minute off.
 [4] Verified by design and type tests.
 See Detailed Specifications introduction for additional information.

DC Voltage Specification

Function	Range	Resolution	Accuracy						
			DC ^[2]	AC over DC, DC over AC, AC + DC ^[2]					
				20 to 45 Hz	45 Hz to 1 kHz	1 to 20 kHz	20 to 35 kHz		
DC mV	50 mV ^[3]	0.001 mV	0.05 % + 20 ^[4]	2 % + 80	0.5 % + 80	1.5 % + 40	5 % + 40		
	500 mV	0.01 mV	0.025 % + 2 ^[5]			1.5 % + 40	5 % + 40		
DC V ^[1]	5 V	0.0001 V	0.025 % + 2			1.5 % + 40	5 % + 40		
	50 V	0.001 V	0.025 % + 2						
	500 V	0.01 V	0.03 % + 2					Not Spec'd	Not Spec'd
	1000 V	0.1 V	0.03 % + 2					Not Spec'd	Not Spec'd
LoZ ^[1] V	1000 V	0.1 V	1 % + 20	Not Spec'd	Not Spec'd	Not Spec'd	Not Spec'd		

[1] Add 20 counts in dual display ac over dc, dc over ac or ac+dc.
[2] AC+DC ranges are specified from 2 % to 140 % of range, except 1000 V is specified from 2 % to 100 % of range.
[3] When using the relative mode (REL Δ) to compensate for offsets.
[4] Add 4 counts/10 mV AC in dual display ac over dc, dc over ac or ac + dc
[5] Add 10 counts/100 mV AC in dual display ac over dc, dc over ac or ac + dc.

DC Current Specifications

Function	Range	Resolution	Accuracy				
			DC ^{[1][3]}	AC over DC, DC over AC, AC + DC ^[1]			
				20 to 45 Hz	45 Hz to 1 kHz	1 to 20 kHz	20 to 100 kHz ^[5]
DC μ A ^[4]	500 μ A	0.01 μ A	0.075 % + 20	1 % + 20	0.6 % + 20	0.6 % + 20	5 % + 40
	5000 μ A	0.1 μ A	0.075 % + 2	1 % + 5	0.6 % + 5	0.6 % + 10	5 % + 40
DC mA ^[4]	50 mA	0.001 mA	0.05 % + 10 ^[6]	1 % + 20	0.6 % + 20	0.6 % + 20	5 % + 40
	400 mA	0.01 mA	0.15 % + 2	1 % + 5	0.6 % + 5	1.5 % + 10	5 % + 40
DC A ^[2]	5 A	0.0001 A	0.3 % + 10	1.5 % + 20	0.8 % + 20	3 % + 40 ^[5]	Not Spec'd
	10 A	0.001 A	0.3 % + 2	1.5 % + 10	0.8 % + 10	3 % + 10 ^[5]	Not Spec'd

[1] AC+DC ranges are specified from 2 % to 140 % of range.
 [2] 20 A for 30 seconds on, 10 minutes off. >10 A not specified.
 [3] Add 20 counts in dual display ac over dc, dc over ac or ac+dc.
 [4] 400 mA continuous; 550 mA for 2 minutes on, 1 minute off.
 [5] Verified by design and type tests.
 [6] Temperature coefficient: 0.1 X (specified accuracy)/ °C (<18 °C or > 28 °C)

Resistance Specifications

Function	Range	Resolution	Accuracy
Resistance	50 Ω ^{[1][3]}	0.001 Ω	0.15 % + 20
	500 Ω ^[1]	0.01 Ω	0.05 % + 10
	5 k Ω ^[1]	0.0001 k Ω	0.05 % + 2
	50 k Ω ^[1]	0.001 k Ω	0.05 % + 2
	500 k Ω	0.01 k Ω	0.05 % + 2
	5 M Ω	0.0001 M Ω	0.15 % + 4
	30 M Ω	0.001 M Ω	1.5 % + 4
	50 M Ω	0.01 M Ω	1.5 % + 4
	50 M Ω up to 100 M Ω	0.1 M Ω	3.0 % + 2
	100 M Ω up to 500 M Ω	0.1 M Ω	8 % + 2
Conductance	50 nS ^[2]	0.01 nS	1 % + 10

[1] When using the relative mode (REL \blacktriangle) to compensate for offsets.
 [2] Add 20 counts above 33 nS in 50 nS range.
 [3] 289 only.

Temperature Specifications

Temperature	Resolution	Accuracy ^[1,2]
-200 °C to +1350 °C	0.1 °C	1 % + 10
-328 °F to +2462 °F	0.1 °F	1 % + 18

[1] Does not include error of the thermocouple probe.
 [2] Accuracy specification assumes ambient temperature stable to ± 1 °C. For ambient temperature changes of ± 5 °C, rated accuracy applies after 2 hours.

Capacitance and Diode Test Specifications

Function	Range	Resolution	Accuracy
Capacitance	1 nF ^[1]	0.001 nF	1 % + 5
	10 nF ^[1]	0.01 nF	1 % + 5
	100 nF ^[1]	0.1 nF	1 % + 5
	1 μF	0.001 μF	1 % + 5
	10 μF	0.01 μF	1 % + 5
	100 μF	0.1 μF	1 % + 5
	1000 μF	1 μF	1 % + 5
	10 mF	0.01 mF	1 % + 5
	100 mF	0.1 mF	2 % + 20
Diode Test	3.1 V	0.0001 V	1 % + 20

[1] With a film capacitor or better, using relative mode (REL Δ) to zero residual.

Frequency Counter Specifications

Function	Range	Resolution	Accuracy
Frequency (0.5 Hz to 999.99 kHz, pulse width >0.5 μ s)	99.999 Hz	0.001 Hz	0.02 % + 5
	999.99 Hz	0.01 Hz	0.005 % + 5
	9.9999 kHz	0.0001 kHz	0.005 % + 5
	99.999 kHz	0.001 kHz	0.005 % + 5
	999.99 kHz	0.01 kHz	0.005 % + 5
Duty Cycle ^{[1][2]}	1.00 % to 99.00 %	0.01 %	0.2 % per kHz + 0.1 %
Pulse Width ^{[1][2]}	0.1000 ms	0.0001 ms	0.002 ms + 3 counts
	1.000 ms	0.001 ms	0.002 ms + 3 counts
	10.00 ms	0.01 ms	0.002 ms + 3 counts
	1999.9 ms	0.1 ms	0.002 ms + 3 counts
<p>[1] For rise times <1 μs. Signals centered around trigger levels.</p> <p>[2] 0.5 to 200 kHz, pulse width >2 μs. Pulse width range is determined by the frequency of the signal.</p>			

Frequency Counter Sensitivity

Input Range	Approximate Voltage Sensitivity (rms sine wave) ^[1]	AC Bandwidth ^[2]	Approximate DC Trigger Levels	DC Bandwidth ^[2]
	15 Hz to 100 kHz			
50 mV	5 mV	1 MHz	5 mV & 20 mV	600 kHz
500 mV	25 mV	1 MHz	20 mV & 60 mV	1 MHz
5 V	0.25 V	700 kHz	1.4 V & 2.0 V	80 kHz
50 V	2.5 V	1 MHz	0.5 V & 6.5 V	1 MHz
500 V	25 V	300 kHz	5 V & 40 V	300 kHz
1000 V	50 V	300 kHz	5 V & 100 V	300 kHz
Input Range	Approximate Current Sensitivity (rms sine wave)	AC Bandwidth	Approximate DC Trigger Levels	DC Bandwidth
	15 Hz to 10 kHz			
500 μ A	25 μ A	100 kHz	NA	NA
5000 μ A	250 μ A	100 kHz		
50 mA	2.5 mA	100 kHz		
400 mA	25 mA	100 kHz		
5 A	0.25 A	100 kHz		
10 A	1.0 A	100 kHz		
<p>[1] Maximum input = 10 x range (1000 V maximum, 2×10^7 V-Hz product maximum). Noise at low frequencies and amplitudes may affect accuracy.</p> <p>[2] Typical frequency bandwidth with full scale (or maximum 2×10^7 V-Hz product) rms sine wave.</p>				

MIN MAX, Recording, and Peak Specifications

Function	Nominal Response	Accuracy
MIN MAX, Recording	200 ms to 80% (dc function)	Specified accuracy ± 12 counts for changes > 425 ms in duration in manual range.
	350 ms to 80 % (ac function)	Specified Accuracy ± 40 counts for changes > 1.5 s in duration in manual range.
Peak	250 μ S (peak) ^[1]	Specified accuracy ± 100 counts ^[2] up to 5,000 count (full range) reading. For higher peak reading (to 12,000 counts), specified accuracy ± 2 % ^[3] of reading.
Crest Factor	350 ms to 80 %	For periodic waveforms from 50 to 440 Hz $\pm (4 \% + 1 \text{ count})$.
<p>[1] For repetitive peaks; 2.5 ms for single events. Peak not specified for 500 μA DC, 50 mA DC, 5 A DC.</p> <p>[2] 200 counts in 500 mV AC, 500 μA AC, 50 mA AC, 5 A AC.</p> <p>[3] 3 % in 500 mV AC, 500 μA AC, 50 mA AC, 5 A AC.</p>		

Input Characteristics

Function	Overload Protection ^[1]	Input Impedance	Common Mode Rejection Ratio (1 k Ω unbalance)		Normal Mode Rejection						
\bar{V}	1000 V	10 M Ω <100 pF	>120 dB at dc, 50 Hz or 60 Hz		>60 dB at 50 Hz or 60 Hz						
\overline{mV}	1000 V ^[2]	10 M Ω <100 pF	>120 dB at dc, 50 Hz or 60 Hz		>60 dB at 50 Hz or 60 Hz						
\tilde{V}	1000 V	10 M Ω <100 pF (ac-coupled)	>60 dB, dc to 60 Hz								
$\overset{LoZ}{\tilde{V}}$	1000 V	3.2 k Ω <100 pF (ac-coupled)	Not specified		Not specified						
Function	Overload Protection ^[1]	Open Circuit Test Voltage	Full Scale Voltage		Typical Short Circuit Current						
			To 500 k Ω	≥ 5 M Ω or 50 nS	500 Ω	5 k Ω	50 k Ω	500 k Ω	5 M Ω	50 M Ω	500 M Ω
Ω	1000 V ^[2]	5 V dc	550 mV	<5 V	1 mA	100 μ A	10 μ A	1 μ A	0.3 μ A	0.3 μ A	0.3 μ A
50Ω	1000 V ^[2]	20 V decreasing to 2.5 V	500 mV		10 mA						
\rightarrow	1000 V ^[2]	5 V dc	3.1 V dc		1 mA						
<p>[1] Input is limited to the product of a V rms sinewave times frequency of 2×10^7 V-Hz.</p> <p>[2] For circuits <0.5 A short circuit. 660V for high energy circuits.</p>											

Burden Voltage (A, mA, μ A)

Function	Range	Burden Voltage
mA, μ A	500 μ A	102 μ V/ μ A
	5000 μ A	102 μ V/ μ A
	50.000 mA	1.8 mV/mA
	400.00 mA	1.8 mV/mA
A	5.0000 A	0.04 V/A
	10.000 A	0.04 V/A