

# Rosemount™ 702 Wireless Discrete Transmitter



## About this guide

This manual supplement provides information on installing, operating, and maintaining the Rosemount 702 Wireless Discrete Transmitter for plunger arrival detection. The table below lists the variants of the Rosemount 702 transmitter; refer to the table if looking for documentation on variants. Refer to the Rosemount 702 [Reference Manual](#) for more instruction. This guide and the manual are available electronically on [Emerson.com/Rosemount](http://Emerson.com/Rosemount)

| Model number  | Functionality   | Manual   |
|---------------|---|--|
| 702DX22/32/42 | Two channel discrete I/O  | <a href="#">Rosemount 702 Wireless Discrete Transmitter Reference Manual</a> |
| 702DX61       | One channel for Tyco TraceTek liquid hydrocarbon leak detection | <a href="#">Rosemount 702 Wireless Discrete Transmitter Reference Manual</a> |
| 702DX52       | Discrete Transmitter for Plunger Arrival Detection              | Rosemount 702 Wireless Discrete Transmitter Reference Manual Supplement      |

### Product description

The Rosemount 702 for plunger arrival detection is designed to work with the ETC Cyclops plunger arrival sensor (ET-11000). The transmitter provides power to the plunger arrival sensor, reads and communicates the sensor state via wirelessHART. Features of the Rosemount 702 Transmitter include:

- Simple and easy installation practices currently being used for robust installations
- Flexibility to meet your most demanding applications
- Sensor state latching for host system compatibility
- Provides power to external plunger arrival sensor
- The integral LCD display conveniently displays the latched plunger sensor state, power output state, and diagnostics of the transmitter

**Figure A-: Rosemount 702 Transmitter for Plunger Arrival**

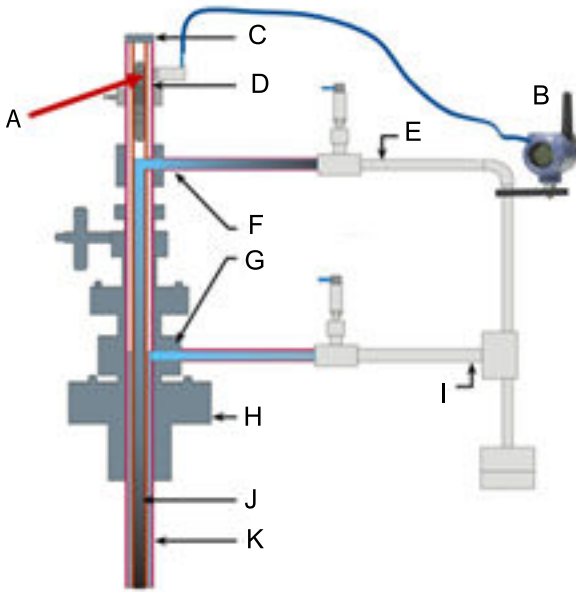

|   |                                      |   |                             |
|---|--------------------------------------|---|-----------------------------|
| A | Plunger Arrival Sensor (ETC Cyclops) | G | Lower Lubricator Outlet     |
| B | 702 Plunger Arrival                  | H | Well Casing                 |
| C | Lubricator                           | I | Production gas              |
| D | Plunger                              | J | Well casing/production tube |
| E | Wastewater                           | K | Well casing                 |
| F | Upper Lubricator Outlet              |   |                             |

**Contents**

|                                    |    |  |    |
|------------------------------------|----|--|----|
| Wireless considerations .....      | 4  | Verify operation .....   | 16 |
| Physical installation .....        | 7  | Reference information: wiring switch inputs, output circuits, and leak sensors ..... | 20 |
| Device network configuration ..... | 14 | Safety shower and eye wash monitoring .....  | 39 |
|                                    |    | Product Certifications .....   | 42 |

# 1 Wireless considerations

## 1.1 Power up sequence

The Smart Wireless Gateway should be installed and functioning properly before any wireless field devices are powered. Install the Black Power Module, SmartPower™ Solutions model number 701PBKKF (part number 00753-9220-0001) into the Rosemount 702 Transmitter to power the device. Wireless devices should be powered up in order of proximity from the Gateway, beginning with the closest device, then working outward from the Gateway. This results in a simpler and faster network installation. Enable Active Advertising on the Gateway to ensure new devices are able to join the network faster. For more information see the Emerson™ Wireless 1420 Gateway [Reference Manual](#).

## 1.2 Antenna position

The antenna should be positioned vertically, either straight up or straight down, and it should be approximately 3 ft. (1 m) from any large structure, building, or conductive surface to allow for clear communication to other devices.

---

**Figure 1-1: Antenna Position**

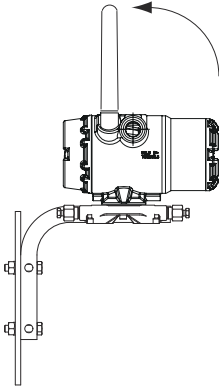

### 1.3 Conduit entry

Upon installation, ensure each conduit entry is either sealed with a conduit plug using approved thread sealant, or has an installed conduit fitting or cable gland with appropriate threaded sealant. Note the conduit entries on the Rosemount 702 Transmitter are threaded 1/2-14 NPT.

**Figure 1-2: Conduit Entry**

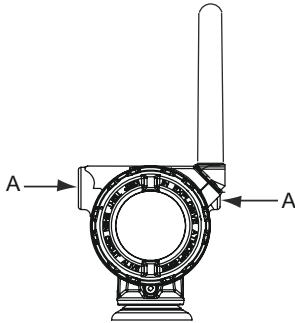

A. Conduit entry

### 1.4 Field Communicator connections

The power module needs to be installed before the Field Communicator can interface with the Rosemount 702 Transmitter. This transmitter uses the Black Power Module; Order model number 701PBKKF or part number 00753-9220-0001.

---

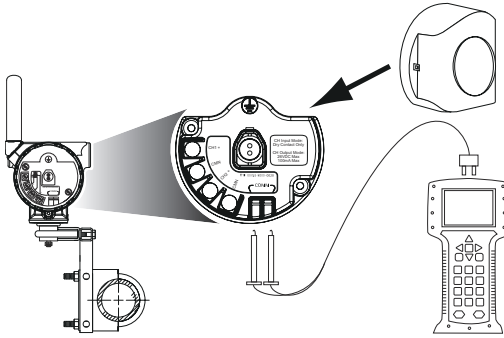
**Figure 1-3: Connection Diagram**

---

The Rosemount 702 Transmitter and all other wireless devices should not be set up until after the Smart Wireless Gateway has been installed and is functioning properly.

## 2 Physical installation

The Rosemount 702 Transmitter can be installed in one of two configurations:

- Direct mount, where the switch is connected directly to the Rosemount 702 Transmitter housing's conduit entry.
- Remote mount, where the switch is mounted separate from the Rosemount 702 Transmitter housing, then connected to the Rosemount 702 Transmitter via conduit.

Select the installation sequence that corresponds to the mounting configuration.

### 2.1 Direct mount

---

#### Note

Direct mount installation should not be employed when using tubing and connectors such as Swagelok® fittings.

---

**Figure 2-1: Direct Mount**

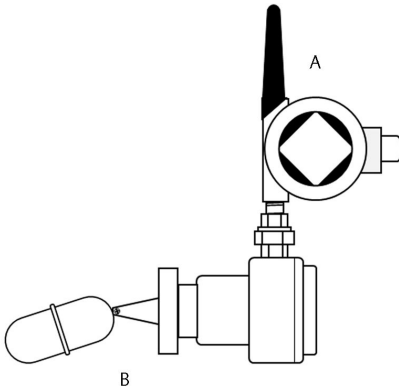

- A. Rosemount 702 Transmitter  
B. Float switch
-

## Procedure

1. Install the switch according to standard installation practices making sure to use thread sealant on all connections.
2. Attach the Rosemount 702 Transmitter housing to the switch using the threaded conduit entry.
3. Attach the switch wiring to the terminals as indicated on the wiring diagram (see [Chapter 5](#)).
4. Connect the Black Power Module.

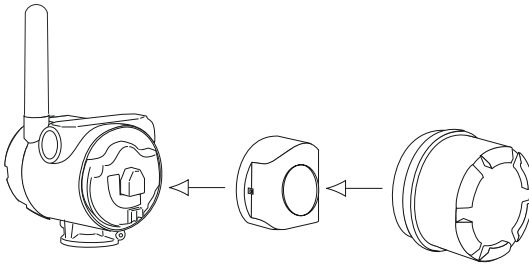



---

## Note

Wireless devices should be powered up in order of proximity from the Smart Wireless Gateway, beginning with the closest device to the Gateway. This will result in a simpler and faster network installation.

---

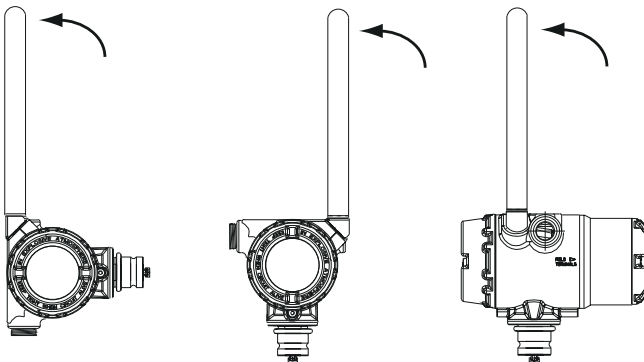
5. Close the housing cover and tighten to safety specification. Always ensure a proper seal so the metal touches metal, but do not over tighten.
6. Position antenna vertically, either straight up or straight down. The antenna should be approximately 3 ft. (0.91 m) from any large structures or buildings, to allow clear communication to other devices.



## 2.2 Remote mount

**Figure 2-2: Remote Mount**

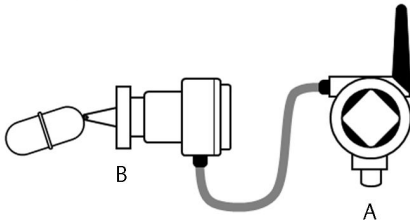

- A. *Rosemount 702 Transmitter*
- B. *Float switch*

### Procedure

1. Install the switch according to standard installation practices making sure to use thread sealant on all connections.
2. Run wiring (and conduit if necessary) from the switch to the Rosemount 702 Transmitter.
3. Pull the wiring through the threaded conduit entry of the Rosemount 702 Transmitter.
4. Attach the switch wiring to the terminals as indicated on the wiring diagram (see [Chapter 5](#)).
5. Connect the black power module.

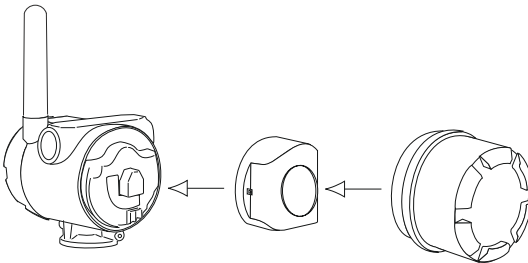

---

**Note**

Wireless devices should be powered up in order of proximity from the Smart Wireless Gateway, beginning with the closest device to the gateway. This will result in a simpler and faster network installation.

---

6. Close the housing cover and tighten to safety specification. Always ensure a proper seal so the metal touches metal, but do not over tighten.
7. Position antenna vertically, either straight up or straight down. The antenna should be approximately 3 ft. (0.91 m) from any large structures or buildings, to allow clear communication to other devices.

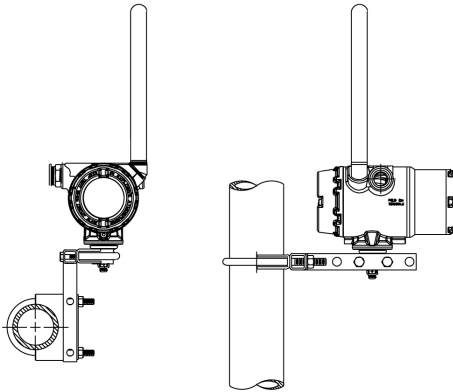

## 2.3 High gain, remote antenna (optional)

The high gain, remote antenna options provide flexibility for mounting the Rosemount 702 Transmitter based on wireless connectivity, lightning protection, and current work practices.

---

**Figure 2-3: Rosemount 702 Transmitter with High Gain, Remote Antenna**

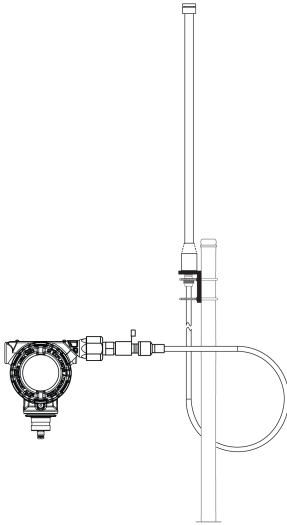

---

### 2.3.1 Install the high gain, remote antenna (WN option)

#### **Prerequisites**

Find a location where the remote antenna has optimal wireless performance. Ideally this will be 15–25 ft. (4.6–7.6 m) above the ground or 6 ft. (2 m) above obstructions or major infrastructure.

**⚠ WARNING!**

When installing remote mount antennas for the Rosemount 702 Transmitter, always use established safety procedures to avoid falling or contact with high-power electrical lines.

Install remote antenna components for the Rosemount 702 Transmitter in compliance with local and national electrical codes and use best practices for lightning protection.

Before installing, consult with the local area electrical inspector, electrical officer, and work area supervisor.

The Rosemount 702 Transmitter remote antenna option is specifically engineered to provide installation flexibility while optimizing wireless performance and local spectrum approvals. To maintain wireless performance and avoid non-compliance with spectrum regulations, do not change the length of cable or the antenna type.

If the supplied remote mount antenna kit is not installed per these instructions, Emerson is not responsible for wireless performance or non-compliance with spectrum regulations.

---

**Procedure**

1. Mount the antenna on a 1.5 to 2-in. pipe mast using the supplied mounting equipment.
2. Connect the lightning arrester directly to the top of the Rosemount 702 Transmitter.
3. Install the grounding lug, lock washer, and nut on top of lightning arrester.
4. Connect the antenna to the lightning arrester using the supplied LMR-400 coaxial cable ensuring the drip loop is not closer than 1 ft. (0.3 m) from the lightning arrester.
5. Use the coaxial sealant to seal each connection between the wireless field device, lightning arrester, cable, and antenna.

---

**Note**

The remote mount antenna kit includes coaxial sealant for weatherproofing the cable connections for the lightning arrester, antenna, and Rosemount 702 Transmitter. Coaxial sealant must be applied to guarantee performance of the wireless field network. See [Figure 2-4](#) for details on how to apply coaxial sealant.

---

---

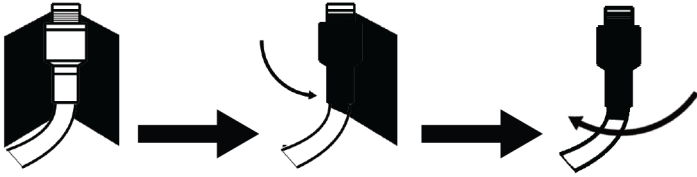
**Figure 2-4: Applying Coaxial Sealant to Cable Connections**

6. Ensure the mounting mast and lightning arrestor are grounded according to local/national electrical code.

Any spare lengths of coaxial cable should be placed in 12-in. (0.3 m) coils.

### 3 Device network configuration

In order to communicate with the Smart Wireless Gateway, and ultimately the host system, the transmitter must be configured to communicate with the wireless network. This step is the wireless equivalent of connecting wires from a transmitter to the information system. Using a Field Communicator or AMS Wireless Configurator, enter the Network ID and Join Key so they match the Network ID and Join Key of the Gateway and other devices in the network. If the Network ID and Join Key do not match that of the Gateway, the Rosemount 702 Transmitter will not communicate with the network. The Network ID and Join Key may be obtained from the Smart Wireless Gateway on the **Setup Network Settings** page on the web interface, shown in [Figure 3-1](#).

**Figure 3-1: Gateway Network Settings**

The screenshot displays the 'Network Settings' configuration page. The left sidebar shows a tree view of system settings, with 'Network' selected. The main panel contains the following configuration options:

- Network name:** myNet
- Network ID:** 5485
- Security mode:**  Common join key  Access control list
- Join key:** 44555354 | 4e495457 | 4f524b53 | E24434b
- Show join key:**  Yes  No
- Generate random join key:**
- Rotate network key?:**  Yes  No
- Key rotation period (days):** 3
- Change network key now?:**  Yes  No

A  button is located at the bottom of the configuration area.

#### 3.1 AMS Wireless Configurator

1. Right click on the Rosemount 702 Transmitter.
2. Select **Configure**.
3. When the menu opens, select **Join Device to Network**.
4. Follow the method to enter the Network ID and Join Key.

## 3.2 Field Communicator

The Network ID and Join Key may be changed in the wireless device by using the following Fast Key sequence. Set both Network ID and Join Key.

| Function       | Fast Key sequence | Menu items                         |
|----------------|-------------------|------------------------------------|
| Wireless setup | 2,2,1             | Network ID, Join Device to Network |

## 4 Verify operation

There are four ways to verify operation: using the optional local display (LCD), using the Field Communicator, using the Smart Wireless Gateway's integrated web interface, or by using AMS Suite Wireless Configurator. If the Rosemount 702 Transmitter was configured with the Network ID and Join Key, and sufficient time has passed, the transmitter will be connected to the network.

### 4.1 Local display



#### 4.1.1 Start-up sequence

When the Rosemount 702 Transmitter is first powered up, the LCD display will display a sequence of screens: All Segments On, Device Identification, Device Tag, and then the user chosen variables of the periodic display.

During steady state operation, the LCD display gives a periodic display of user chosen variables at the configured wireless update rate. These variables can be selected from a list of six:

- Channel 1 State
- Channel 1 Count
- Channel 2 State
- Channel 2 Count
- Electronics Temperature
- Supply Voltage

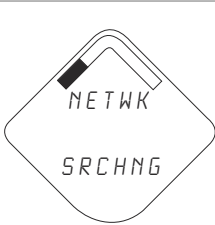
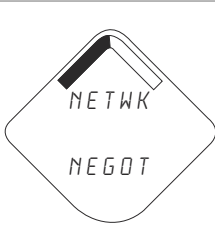
Refer to the Rosemount 702 [Reference Manual](#) for error codes and other LCD display messages. The chevron-shaped status bar at the top of the screen indicates the progress of the network join process. When the status bar is filled, the device is successfully connected to the wireless network.

| Searching for network   | Joining network   | Connected with limited bandwidth  | Connected  |
|---|---|---|--|
|  |  |  |  |

## 4.2 Field Communicator

For HART® Wireless transmitter communication, a Rosemount 702 Transmitter DD is required. To obtain the latest DD, visit the Emerson Easy Upgrade site at: [Emerson.com/Device-Install-Kits](http://Emerson.com/Device-Install-Kits).

| Function       | Key sequence | Menu items  |
|----------------|--------------|---|
| Communications | 3, 3         | Join Status, Wireless Mode, Join Mode, Number of Available Neighbors, Number of Advertisements Heard, Number of Join Attempts |

## 4.3 Smart Wireless Gateway

In the Gateway's integrated web server, navigate to the *Explorer* page. This page shows whether the device has joined the network and is communicating properly.

---

### Note

It may take several minutes for the device to join the network.

---

### Note

If the device joins the network and immediately has an alarm present, it is likely caused by the sensor configuration. Check the sensor wiring (see [Figure 5-1](#)) and the sensor configuration (see [Table 5-6](#)).

---

Figure 4-1: Smart Wireless Gateway Explorer Page



The screenshot shows a web interface titled "Explorer" with a user name "admin". On the left is a navigation menu with options: 192.168.1.10, Diagnostics, Monitor, myNet, and Setup. The main area contains a table with the following data:

| HART Tag          | HART status | Last update       | PV               | SV          | TV          | QV          | Burst rate |
|-------------------|-------------|-------------------|------------------|-------------|-------------|-------------|------------|
| 2160_Level        | ●           | 04/20/11 18:09:53 | 0.000            | 1394.483 Hz | 23.000 DegC | 7.502 V     | 8          |
| 3051S_Pressure    | ●           | 04/20/11 18:09:35 | -0.027 InH2O 68F | 22.750 DegC | 22.750 DegC | 7.115 V     | 8          |
| 6081_Conductivity | ●           | 04/20/11 18:09:42 | 9.795 pH         | 23.322 DegC |             | 7.283 V     | 16         |
| 6081_pH           | ●           | 04/20/11 18:09:50 | 9.803 pH         | 22.822 DegC | -165.000 mV | 7.287 V     | 16         |
| 648_Temperature   | ●           | 04/20/11 18:09:55 | 22.859 DegC      | NaN DegC    | 22.500 DegC | 7.116 V     | 8          |
| 4320_Position     | ●           | 04/20/11 18:09:57 | 1.000 %          | 1.000       | 0.000       | 23.000 DegC | 4          |
| 702_Discrete      | ●           | 04/20/11 18:09:53 | 1.000            | 0.000       | 23.250 DegC | 7.063 V     | 8          |
| 848_Temperature   | ●           | 04/20/11 18:09:35 | 22.850 DegC      | 22.822 DegC | 22.822 DegC | 24.861 DegC | 32         |
| 9420_Vibration    | ●           | 04/20/11 17:25:22 | 0.023 in/s       | 0.022 g/s   | 2.501 V     | 7.143 V     | 01:00:00   |
| 248_Temperature   | ●           | 04/20/11 18:09:55 | 22.959 DegC      | NaN DegC    | 22.550 DegC | 7.116 V     | 16         |
| 708_Acoustic      | ●           | 04/20/11 18:09:54 | 6.378 Counts     | 24.559 DegC | 22.550 DegC | 3.391 V     | 16         |

## 4.4 AMS Wireless Configurator

When the device has joined the network, it will appear in AMS Wireless Configurator as illustrated below.

Figure 4-2: AMS Wireless Configurator, Device Explorer Screen

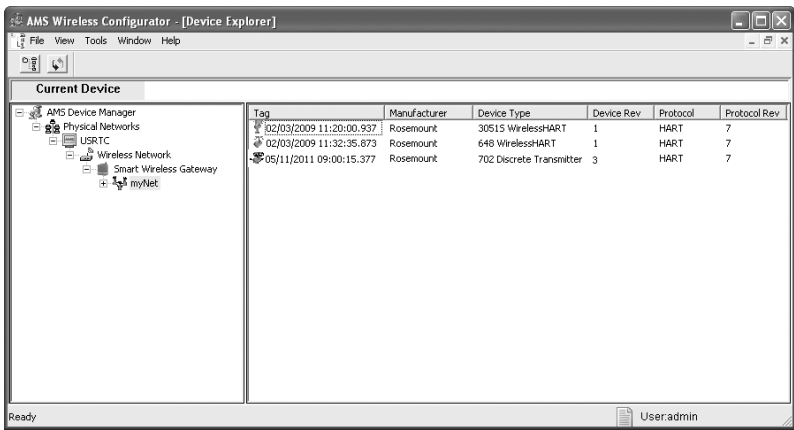

The screenshot shows the "AMS Wireless Configurator - [Device Explorer]" window. The left pane shows a tree view with "AMS Device Manager" expanded to "Physical Networks" > "USRTC" > "Wireless Network" > "Smart Wireless Gateway" > "myNet". The right pane shows a table of devices:

| Tag                     | Manufacturer | Device Type              | Device Rev | Protocol | Protocol Rev |
|-------------------------|--------------|--------------------------|------------|----------|--------------|
| 02/03/2009 11:20:00.937 | Rosemount    | 3051S WirelessHART       | 1          | HART     | 7            |
| 02/03/2009 11:32:35.873 | Rosemount    | 648 WirelessHART         | 1          | HART     | 7            |
| 05/11/2011 09:00:15.377 | Rosemount    | 702 Discrete Transmitter | 3          | HART     | 7            |

At the bottom of the window, it says "Ready" and "User:admin".

## 4.5 Troubleshooting

If the device is not joined to the network after power up, verify the correct configuration of the Network ID and Join Key, and that Active Advertising has been enabled on the Smart Wireless Gateway. The Network ID and Join Key in the device must match the Network ID and Join Key of the Gateway.

### Procedure

1. From the Gateway's integrated web interface, select **Setup Network Settings** to obtain the Network ID and Join Key (see [Figure 4-3](#)).

**Figure 4-3: Gateway Network Settings**

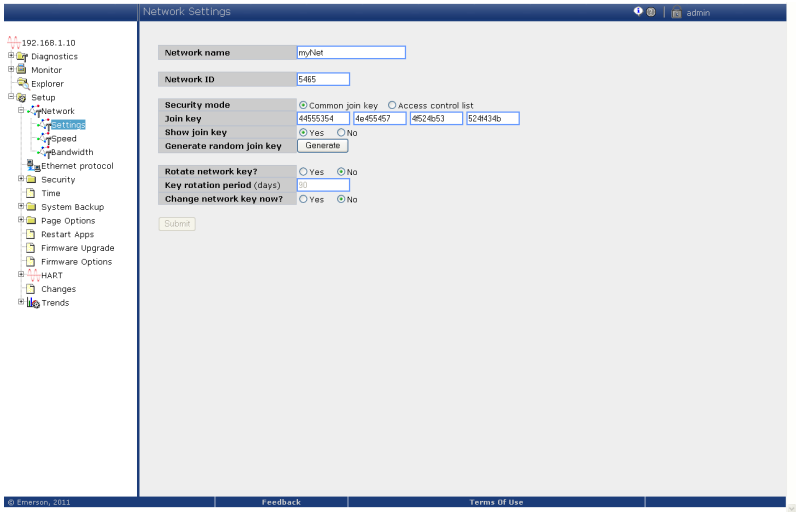

2. To change the Network ID and Join Key in the wireless device, use a Field Communicator and enter the following Fast Key sequence.

| Function | Fast Key sequence | Menu items             |
|----------|-------------------|------------------------|
| Wireless | 2, 1, 1           | Join Device to Network |

3. Follow the on screen prompts.

## 5 Reference information: wiring switch inputs, output circuits, and leak sensors

### 5.1 Dry contact switch inputs

The Rosemount 702 Transmitter has a pair of screw terminals for each of two channels, and a pair of communication terminals. These terminals are labeled as follows:

|       |                      |
|-------|----------------------|
| CH1+: | Channel one positive |
| CMN:  | Common               |
| CH2+: | Channel two positive |
| CMN:  | Common               |
| COMM: | Communication        |

**Figure 5-1: Rosemount 702 Transmitter Terminal**

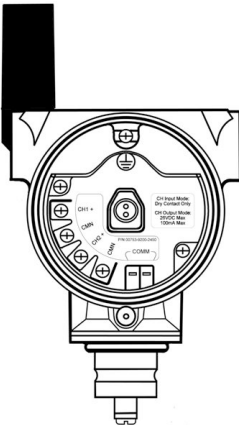

### 5.2 Wireless output specifications

#### 5.2.1 Dual input

The Rosemount 702 Transmitter will accept the input from one or two single pole single throw switches on inputs CH1 and CH2. The wireless output of the transmitter will be both a primary variable (PV) and a secondary variable

(SV). The PV is determined by the CH1 input. The SV is determined by the CH2 input. A closed switch drives a TRUE output. An Open switch drives a FALSE output.

**Note**

Any dry contact input may optionally be inverted by the device, so change the discrete logic state. This is useful, for instance, if a normally open switch is used to replace a normally closed switch.

**Figure 5-2: Single and Dual Input**

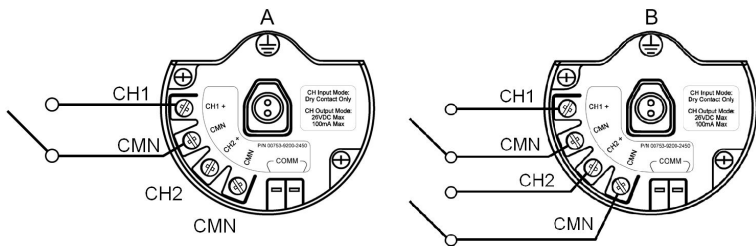

- A. Single Input
- B. Dual Input

**Table 5-1: Single or Dual Input**

| Switch input | Wireless output | Switch input | Wireless output |
|--------------|-----------------|--------------|-----------------|
| <b>CH1</b>   | <b>PV</b>       | <b>CH2</b>   | <b>SV</b>       |
| Closed       | TRUE (1.0)      | Closed       | TRUE (1.0)      |
| Open         | FALSE (0.0)     | Open         | FALSE (0.0)     |

**5.2.2 Dual input, limit contact logic**

When configured for Limit Contact Logic, the Rosemount 702 Transmitter will accept the input from two single pole single throw switch on inputs CH1 and CH2, and will use limit contact logic for the determination of the wireless outputs.

**Figure 5-3: Dual Input, Limit Contacts**

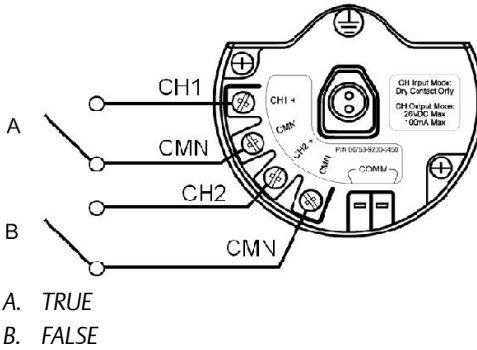

**Table 5-2: Dual Input, Limit Contact Logic**

| Switch input |        | Wireless output |              |
|--------------|--------|-----------------|--------------|
| CH1          | CH2    | PV              | SV           |
| Open         | Open   | TRAVEL (0.5)    | TRAVEL (0.5) |
| Open         | Closed | FALSE (0.0)     | FALSE (0.0)  |
| Closed       | Open   | TRUE (1.0)      | TRUE (1.0)   |
| Closed       | Closed | FAULT(NaN)      | FAULT(NaN)   |

### 5.2.3 Dual input, opposing contact logic

When configured for Opposing Contact Logic, the Rosemount 702 Transmitter will accept the input from a double pole single throw switch on inputs CH1 and CH2, and will use opposing contact logic for the determination of the wireless outputs.

**Figure 5-4: Dual Input, Opposing Contact**

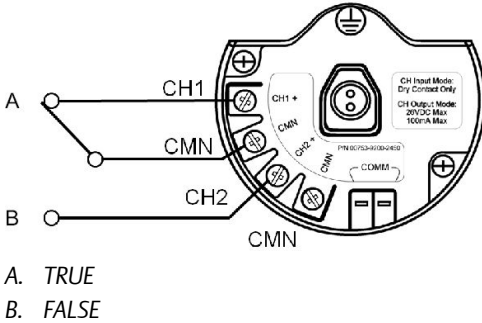

**Table 5-3: Dual input, Opposing Contact Logic**

| Switch inputs |        | Wireless outputs |             |
|---------------|--------|------------------|-------------|
| CH1           | CH2    | PV               | SV          |
| Open          | Open   | FAULT(NaN)       | FAULT(NaN)  |
| Open          | Closed | FALSE (0.0)      | FALSE (0.0) |
| Closed        | Open   | TRUE (1.0)       | TRUE (1.0)  |
| Closed        | Closed | FAULT(NaN)       | FAULT(NaN)  |

### 5.3 Momentary discrete inputs, measurement option code 32 and 42

The Rosemount 702 Transmitter is capable of detecting momentary discrete inputs of 10 milliseconds or more in duration, regardless of the wireless update rate. At each wireless update, the device reports current discrete input state along with an accumulating count of close-open cycles for each input channel.

**Figure 5-5: Momentary Inputs and Accumulating Count**

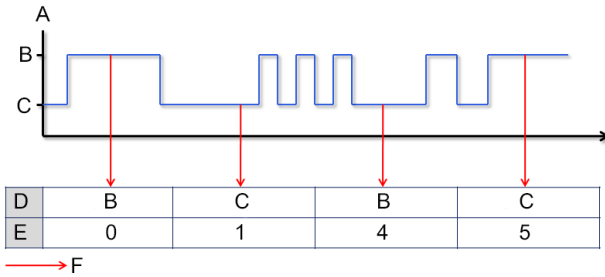

- A. Input Switch State
- B. Closed
- C. Open
- D. State
- E. Count
- F. Wireless Updates

**Figure 5-6: Reporting of Current Discrete State and Count in AMS Device Manager**

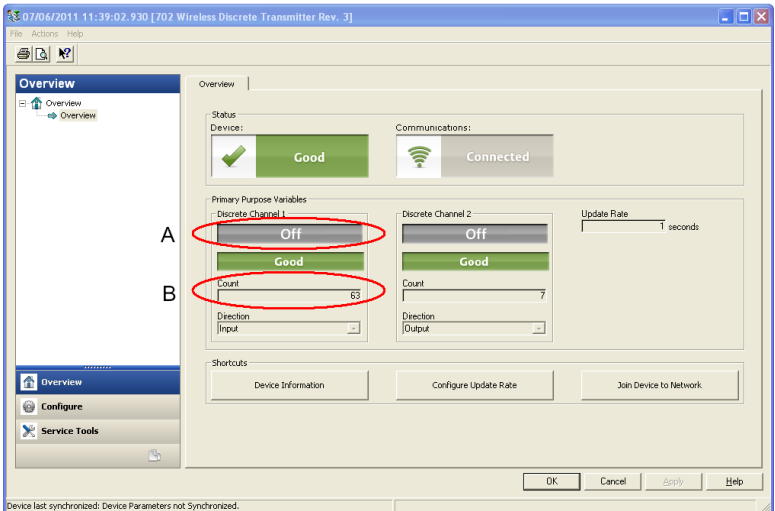

- A. Current State
- B. Count

### 5.3.1 Setting variable reporting

The Rosemount 702 Transmitter has two choices for variable reporting: Classic - Discrete State Only, or Enhanced – Discrete State and Count.

1. In AMS Device Manager, select **Configure > Manual Setup > HART**.
2. Set Variable Reporting as desired.

| Option                               | Description  |
|--------------------------------------|--|
| Classic - Discrete State Only        | The Rosemount 702 Transmitter will report variables exactly like the previous version of the device (measurement option code 22).        |
| Enhanced – Discrete State with Count | The Rosemount 702 Transmitter will provide both current state of the discrete channels, and a count of the discrete state change cycles. |

Table 5-4 shows the variable mapping for both cases.

**Table 5-4: Variable Mapping**

| Variable reporting                   | PV        | SV        | TV                      | QV             |
|--------------------------------------|-----------|-----------|-------------------------|----------------|
| Classic – Discrete State Only        | CH1 State | CH2 State | Electronics temperature | Supply voltage |
| Enhanced – Discrete State with Count | CH1 State | CH2 State | CH1 Count               | CH2 Count      |

## 5.4 Discrete output circuits, measurement option code 42

The Rosemount 702 Transmitter has two channels that can each be configured for discrete input or output. Inputs must be dry contact switch inputs and these were described in a preceding section of this document. Outputs are a simple switch closure to activate an output circuit. The Rosemount 702 Transmitter output does not provide any voltage or current, the output circuit must have power of its own. The Rosemount 702 Transmitter output has maximum switch capacity per channel of 26 volts DC and 100 milliamps.

**Note**

It is very important that the polarity of the output circuit is as shown in the wiring diagrams, with the positive (+) side of the circuit wired to the + terminal of each channel, and the negative (-) side of the circuit wired to the CMN terminal. If the output circuit is wired backwards it will remain active (switch closed) regardless of the state of the output channel.

## 5.5 Discrete output switch functionality

The discrete output of the Rosemount 702 Transmitter is driven by the host control system, through the Smart Wireless Gateway, and out to the Rosemount 702 Transmitter. The time required for this wireless communication from the Gateway to the Rosemount 702 Transmitter is dependent on many factors, including the size and topology of the network and the total amount of downstream traffic on the wireless network. For a network that is constructed to our best practices, typical delays in communication of a discrete output from the Gateway to the Rosemount 702 Transmitter are 15 seconds or less. Remember that this delay is only part of the latency that will be observed in a control loop.

---

### Note

The output switch functionality of the Rosemount 702 Transmitter requires that the network is managed by a version 4 Smart Wireless Gateway, with v4.3 or greater firmware installed.

---

**Figure 5-7: Output Circuit Wiring**

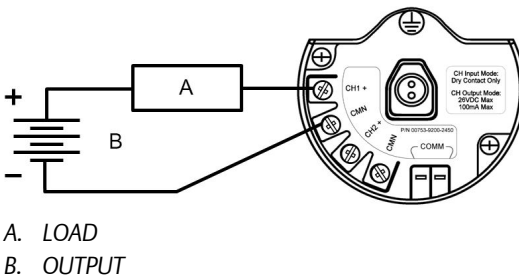

**Figure 5-8: Possible Configurations for Both Channel 1 and Channel 2**

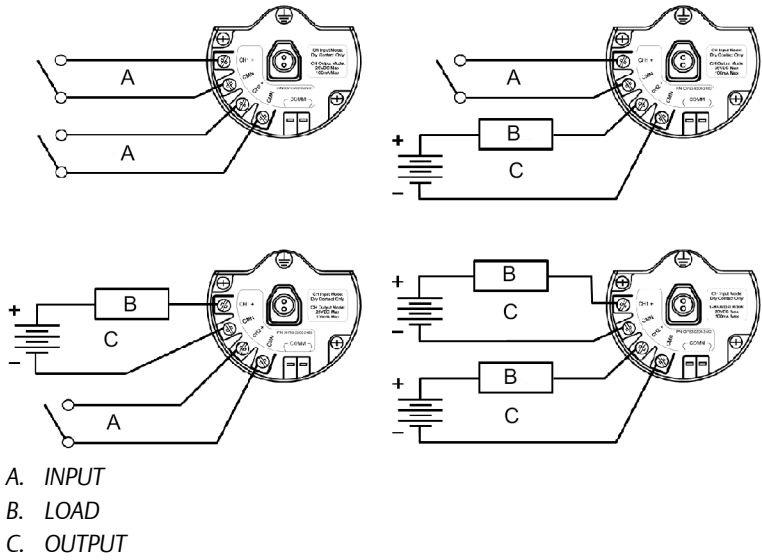

## 5.6 Special considerations for dual output circuits

If both channels are connected to output circuits, it is very important that the CMN terminal of each circuit be at the same voltage. Employing a common ground for both output circuits is one way to ensure that both circuits have CMN terminals at the same voltage.

**Figure 5-9: Dual Output Circuits with a Common Ground**

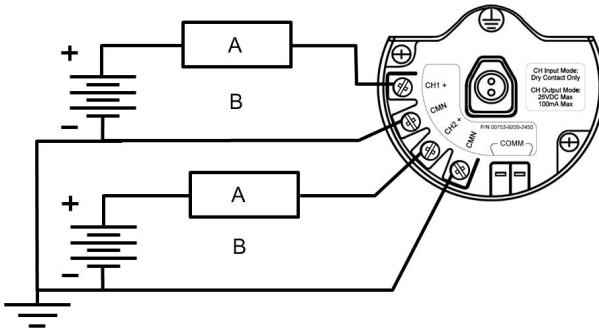

- A. LOAD
- B. OUTPUT

If two output circuits are connected to a single Rosemount 702 Transmitter with a single power supply, both CH + and CMN terminals must be connected to each output circuit. The negative power supply wires must be at the same voltage and connected to both CMN terminals.

**Figure 5-10: Dual Output Circuits with One Power Supply**

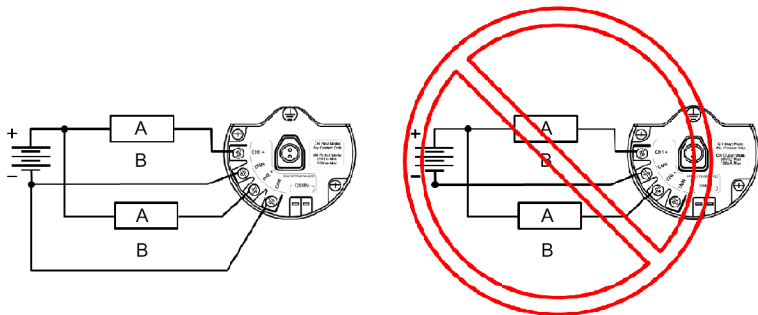

- A. LOAD
- B. OUTPUT

## 5.7 Switching greater currents or voltages

It is important to note that the maximum output switching capacity is 26 volts DC and 100 milliamps. If a greater voltage or current is to be switched, an interposing relay circuit can be used. *Figure 5-11* shows an example of a circuit to switch higher currents or voltages.

**Figure 5-11: Wiring an Interposing Relay to Switch Greater Currents or Voltages**

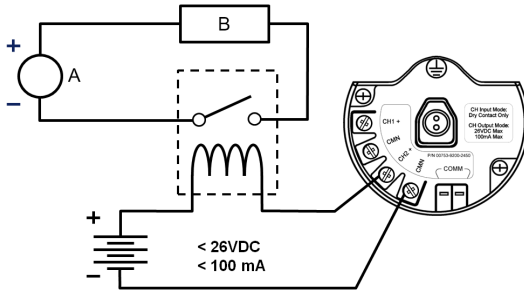

- A. Power Supply
- B. LOAD

## 5.8 Plunger arrival detection

### 5.8.1 Terminal block connections

The plunger arrival detection configuration for measurement option code 52 is intended for use with the ETC Cyclops Plunger Arrival Sensor.

**Figure 5-12: Plunger Arrival Terminal Diagram**

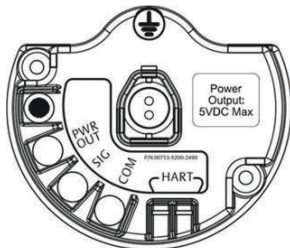

The wiring connections to the ETC Cyclops sensor are made according to Figure 5-13, where 1 connects to 3, 2 connects to 2, and 3 connects to 1 between the transmitter and the sensor.

**Figure 5-13: Wiring Configuration**

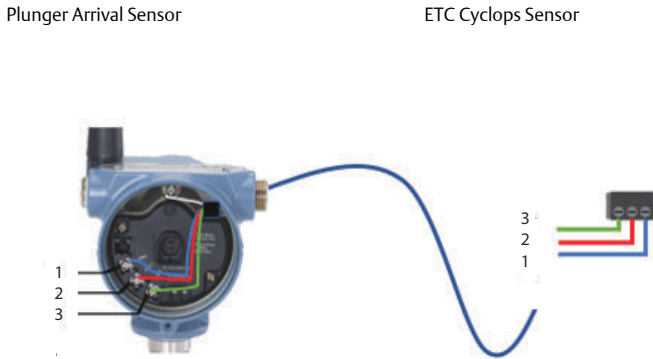

**Rosemount 702 Transmitter**

1. PWR OUT
2. SIG
3. COM

**ETC Cyclops Sensor**

1. COM
2. SIG
3. PWR

For mounting and maintenance of the ETC Cyclops Sensor, refer to the ETC Cyclops Plunger Arrival Sensor [Manual](#).

### 5.8.2 Latching feature

The Rosemount 702 has a latching feature that, when enabled, allows detection of momentary state changes to be held for a configurable latch period. The latching feature can be configured to detect either high or low state changes. By default, the Plunger state (channel 1) is enabled to latch high state changes for a period of one minute.

The following are some examples to demonstrate how the latching time works.

**Note**

Hold time is set to four seconds for illustration in the following examples.

Short events (less than latch hold time) of the measured value will be latched to the reported value for the duration of latch hold time.

**Figure 5-14: Latch Time Short Events**

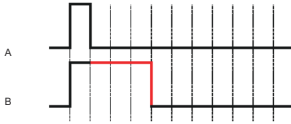

- A. *Measured*
- B. *Reported*

The start of the latch hold timer begins when the measured signal first transitions to active state.

**Figure 5-15: Latch Hold Time Start**



- A. *Measured*
- B. *Reported*

The latch only applies to transitions into the active state. As soon as the reported value is no longer latched, the device is armed for the next event.

**Figure 5-16: Latch Applies to Transitions to Active State**

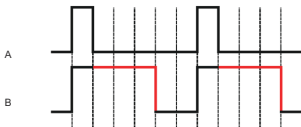

- A. *Measured*
- B. *Reported*

If the measured value goes inactive and active again before the initial latch hold timer expires, the latch hold timer will restart from the beginning of the most recent event.

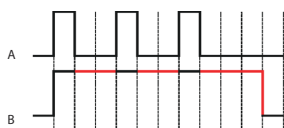
**Figure 5-17: Latch Hold Timer Restarts**

A. *Measured*

B. *Reported*

### 5.8.3 Latching warnings

#### **⚠ WARNING!**

When state latching is enabled, the discrete variable reported to the system will represent the latched value which may not be the actual state value measured by the Rosemount 702 Transmitter

#### **⚠ WARNING!**

Ensure that the state latch time value is long enough for the value to be reported throughout the entire system to guarantee the state transition is not missed. After configuring discrete latching function, check for proper operation at the system level to ensure the desired state transitions are captured as desired.

### 5.8.4 System Verification

After installation of the 702DX52 for plunger arrival one must verify functionality.

- **Verify the sensor:** To do so, pass a ferrous object (ex. Wrench) past the cyclops sensor to simulate an arrival. Verify via the LCD screen and/or field communicator that channel 1 indicates a state change. If a state change is seen, sensor wiring is correct; if nothing is seen, please go back through the installation steps and confirm that everything has been done accordingly.
- **Verify System integration:** It is important to verify the latch time is configured correctly. The default latch period is set to one minute. Verify the host system can detect the arrival event by moving a ferrous metal object (ex. Wrench) past the arrival sensor. The signal should be passed from the device, through the Wireless Gateway and detected at the final host application (ex. PLC, Modbus/OPC, etc.). If nothing is seen, confirm the latch time is appropriate considering the full system scan cycle.

## 5.9 Leak sensors, liquid hydrocarbon detection, measurement option code 61

### 5.9.1 Terminal block connections

The Liquid Hydrocarbon Detection configuration is intended for use with the Tyco® TraceTek® Fast Fuel Sensor, or TraceTek sensing cable.

**Figure 5-18: Fuel Sensor Terminal**

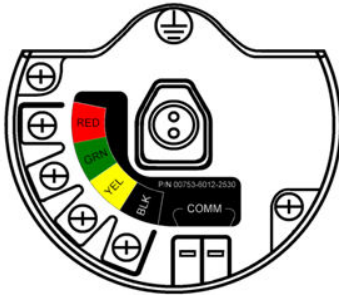

**Figure 5-19: Fuel Sensor Connection**

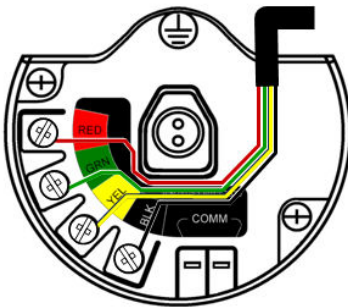

### 5.9.2 Connecting to the fast fuel sensor and TraceTek sensing cable

The connections to the Fast Fuel Sensor TraceTek sensing cable are made by matching the appropriately colored wires to the matching colored termination lugs.

**Note**

All part numbers associated with the fuel sensor cable wiring refer to products sold by Tyco Thermo Controls, LLC.

The Rosemount 702 Wireless Discrete Transmitter can support up to 3 Fast Fuel sensors. These Fast Fuel sensors are connected using TraceTek Modular Leader Cable (TT-MLC-MC-BLK), optional modular jumper cables (TT-MJC-xx-MC-BLK) and branching connectors (TT-ZBC-MC-BLK) as suggested in [Figure 5-20](#).

**Figure 5-20: Fuel Sensor Wiring**

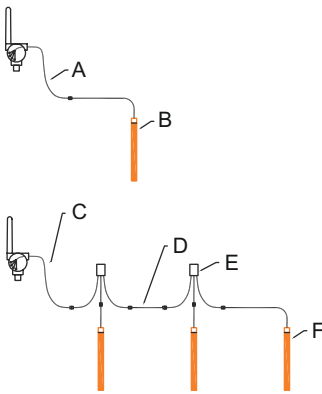

- A. TT-MLC-MC-BLK (Leader cable)
- B. TT-FFS-100 or TT-FFS-250 (Fast fuel sensor probe)
- C. TT-MLC-MC-BLK (Leader cable)
- D. TT-MJC-xx-MC-BLK (Optional jumper cable)
- E. TT-ZBC-xx-MC-BLK (Branch connector)
- F. TT-FFS-100 or TT-FFS-250 (Fast fuel sensor probe)

The Rosemount 702 Wireless Discrete Transmitter can support up to 500 feet of TraceTek hydrocarbon or solvent sensor cable (TT5000 or TT5001 series). The total amount of sensor cable connected to a single Rosemount 702 Transmitter is not to exceed 500 ft. (150 m). However leader cable, jumper cables (if used) and branch connectors are not included in the 500 foot limit. See [Figure 5-21](#) for typical configurations.

**Figure 5-21: Fuel Sensor Cable Wiring**

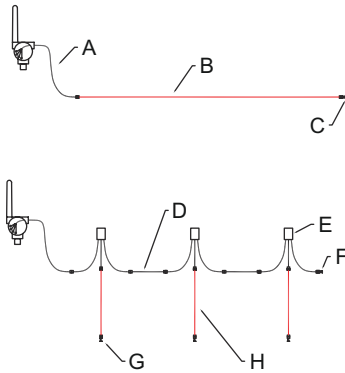

- A. TT-MLC-MC-BLK (Leader Cable)
- B. TT5000/TT5001 Sensor cable (up to 500 ft.)
- C. TT-MET-MC (End termination)
- D. TT-MJC-xx-MC-BLK (Optional jumper cable)
- E. TT-ZBC-xx-MC-BLK (Branch connector)
- F. TT-MET-MC (End termination)
- G. TT-MET-MC (End termination)
- H. Up to 500-ft. TT5000 or TT5001 sensor cable (Total per 702)

Important notes regarding the use of Tyco TraceTek Fast Fuel Sensor and TraceTek sensing cable:

- Tyco TraceTek sensors must be installed as per manufacturer recommendations.
- Do not run the Rosemount 702 Transmitter for long periods (more than two weeks) with a Tyco fuel sensor in the leak state as this will more rapidly deplete the power module.

### 5.9.3 Liquid hydrocarbon detection interface, for Modbus® mapping

Table 5-5 describes use of the Rosemount 702 Transmitter for hydrocarbon detection in other communications protocols such as Modbus or OPC. It is imperative that both PV and SV be mapped to the host system so as to make a good interpretation of the condition and status of the leak detector.

**Table 5-5: Liquid Hydrocarbon Detection Interface, for Modbus Mapping**

| PV  | SV         | Description/interpretation                                 |
|-----|------------|--|
| 1.0 | 1.0        | Normal condition, no leak detected, sensor status good     |
| 0.0 | 1.0 or 0.0 | Leak detected, sensor status good                          |
| 1.0 | 0.0        | Sensor Not Connected, Assume Leak, take appropriate action |

**NOTICE**

It is imperative that both PV and SV be mapped to the host system so the diagnostic information on the sensor status is captured.

In addition, system considerations must be observed to ensure that the device is still connected to the wireless network and reporting values. On an Emerson Smart Wireless Gateway, this can be done by referring to the parameter: PV\_HEALTHY. PV\_HEALTHY has a “True” state when the device is on the network and its updates are current, not late or stale, and the device is functioning properly. A “False” state of PV\_HEALTHY means the device is either off the network, the data updates are not current, or that there is a malfunction of the device (such as an electronics failure). In the case of a “False” state of PV\_HEALTHY, it is recommended to assume the device is not connected to the network and take appropriate action.

**Mapping the PV, SV, and PV\_HEALTHY variables and parameter**

Below is the Gateway screen where the PV, SV, and PV\_HEALTHY variables and parameter can be mapped.

Figure 5-22: Smart Wireless Gateway Modbus Register Map

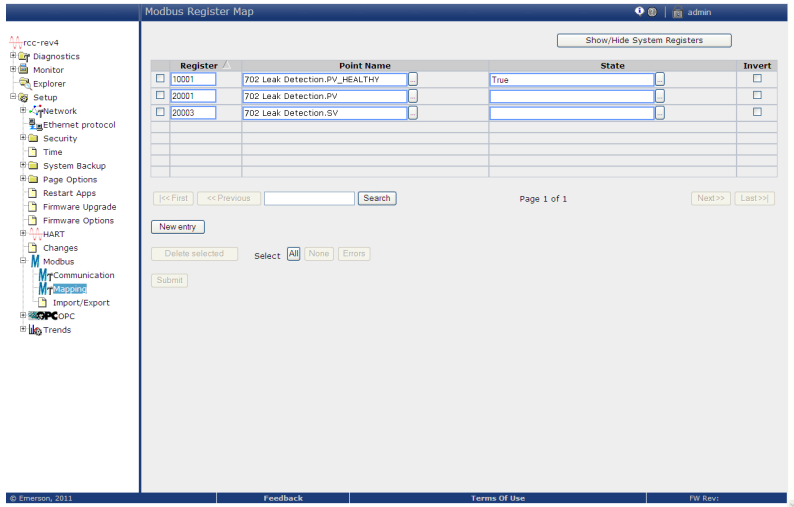

The Fast Fuel Sensor Diagnostics will propagate via the SV variable. This additional information will provide additional sensor Status information while using the TraceTek Fast Fuel Sensor.

**WARNING!**

If a device is not present on the wireless network, appropriate action must be taken by the host system.

### 5.10 Field Communicator use

**Note**

In order to communicate with a Field Communicator, power the Rosemount 702 Transmitter by connecting the power module.

Table 5-6: Rosemount 702 Transmitter Fast Key Sequence

| Function           | Fast Key sequence | Menu items   |
|--------------------|-------------------|--|
| Device information | 2, 2, 4, 3        | Manufacturer Model, Final Assembly Number, Universal, Field Device, Software, Hardware, Descriptor, Message, Date, Model Number I, II, III, SI Unit Restriction, Country |

**Table 5-6: Rosemount 702 Transmitter Fast Key Sequence (continued)**

| Function           | Fast Key sequence | Menu items   |
|--------------------|-------------------|--|
| Guided setup       | 2, 1              | Join Device to Network, Configure Update Rate, Configure Sensor, Calibrate Sensor, Configure Display, Configure Process Alarms |
| Manual setup       | 2, 2              | Wireless, Process Sensor, Percent of Range, Device Temperatures, Device Information, Device Display, Other                     |
| Wireless           | 2, 2, 1           | Network ID, Join Device to Network, Configure Update Rate, Configure Broadcast Power Level, Power Mode, Power Source           |
| Sensor calibration | 3, 4, 1           | Output configuration, input configuration  |

**Figure 5-23: Field Communicator Connections**

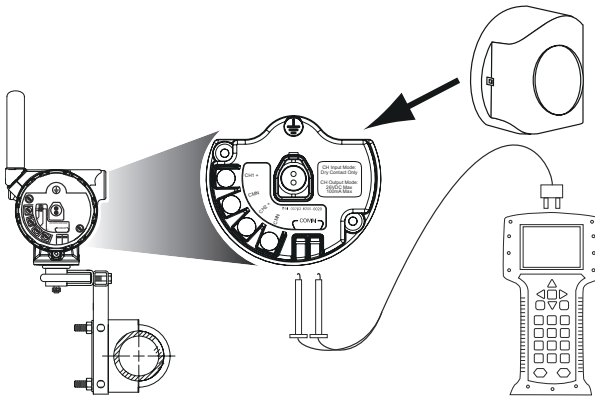

## 6 Safety shower and eye wash monitoring

The Rosemount 702 Transmitter can be used to monitor safety showers and eye wash stations by using switch kits provided by TopWorx™, an Emerson company. These kits are ordered as a part of the Rosemount 702 model code, or separately as an accessory kit, and are available for both insulated and un-insulated pipes. These kits contain the switches, brackets and cables that are necessary to install the Rosemount 702 to monitor both the safety shower and the eye wash in a single station. Because each has two input channels, one Rosemount 702 Transmitter can be used to monitor both a safety shower and an eye wash.

Each Safety Shower Monitoring kit contains:

- Two TopWorx GO™ Switch magnetic proximity switches
- Two cables, one six foot and one twelve foot
- Two black polymer cable glands
- Mounting kit for safety shower and eye wash

### Safety shower monitoring

When the shower valve is activated (valve open) by pulling down on the handle, the TopWorx switch is activated (closed switch) and the Rosemount 702 Transmitter senses that switch closure. This switch state is then transmitted by the Rosemount 702 Transmitter to the Gateway, which then sends that information to the control host or alert system. When the shower valve is closed, the switch remains in the activated state until it is reset by a technician. The switch can be re-set only by placing a ferrous metal object on the far side of the sensing area of the switch.

---

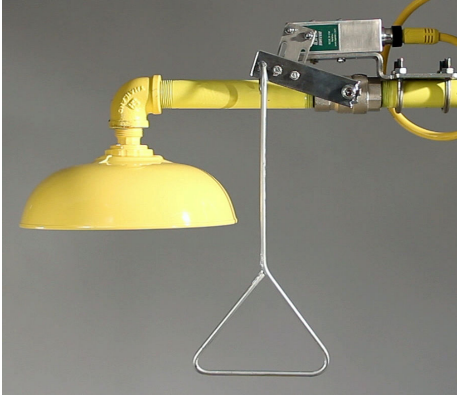
**Figure 6-1: TopWorx Switch Installed on a Safety Shower**

---

### Eye wash monitoring

When the eye wash valve is activated (valve open) by pushing down on the hand paddle, the TopWorx switch is activated (closed switch) and the Rosemount 702 Transmitter senses that switch closure. This switch state is then transmitted by the Rosemount 702 Transmitter to the Gateway, which then sends that information to the control host or alert system. When the eye wash valve is closed, the switch remains in the activated state until it is reset by a technician. The switch can be re-set only by placing a ferrous metal object on the far side of the sensing area of the switch.

**Figure 6-2: TopWorx Switch Installed on an Eye Wash Station**



## 7 Product Certifications

Rev 1.0

### 7.1 European directive information

A copy of the EU Declaration of Conformity can be found at the end of the Quick Start Guide. The most recent revision of the EU Declaration of Conformity can be found at [Emerson.com/Rosemount](http://Emerson.com/Rosemount).

### 7.2 Telecommunication compliance

All wireless devices require certification to ensure that they adhere to regulations regarding the use of the RF spectrum. Nearly every country requires this type of product certification. Emerson is working with governmental agencies around the world to supply fully compliant products and remove the risk of violating country directives or laws governing wireless device usage.

### 7.3 FCC and IC

This device complies with Part 15 of the FCC Rules. Operation is subject to the following conditions: This device may not cause harmful interference. This device must accept any interference received, including interference that may cause undesired operation. This device must be installed to ensure a minimum antenna separation distance of 20 cm from all persons.

### 7.4 Ordinary location certification

As standard, the transmitter has been examined and tested to determine that the design meets the basic electrical, mechanical, and fire protection requirements by a nationally recognized test laboratory (NRTL) as accredited by the Federal Occupational Safety and Health Administration (OSHA).

### 7.5 Installing equipment in North America

The US National Electrical Code® (NEC) and the Canadian Electrical Code (CEC) permit the use of Division marked equipment in Zones and Zone marked equipment in Divisions. The markings must be suitable for the area classification, gas, and temperature class. This information is clearly defined in the respective codes.

### 7.6 USA

#### 7.6.1 15 U.S.A. Intrinsically Safe (IS) and Non-incendive

**Certificate:** [CSA] 1143113

**Standards:** Class 3600 - 2011, Class 3610 - 2010, Class 3611 - 2004, Class 3810 - 2005, UL 50E (11th Edition), UL 61010-1 (3rd Edition), ANSI/ISA-60079-0 (12.00.01) - 2013, ANSI/ISA 60079-11 (12.02.01): 2014, ANSI/IEC 60529-2004

**Markings:** IS CL I, DIV 1, GP, A, B, C, D; CL II, DIV 1, GP E, F, G; Class III; Class 1, Zone 0 AEx ia IIC Ga T4; NI CL I, DIV 2, GP A, B, C, D T4; T4(-50 °C ≤ T<sub>a</sub> ≤ +70 °C) when installed per Rosemount drawing 00702-1020; Type 4X/IP66/67

**Special Conditions for Safe Use (X):**

1. The Rosemount 702 Transmitter housing contains aluminum and is considered a potential risk of ignition by impact or friction. Care must be taken into account during installation and use to prevent impact and friction.
2. The surface resistivity of the polymeric antenna is greater than 1GΩ. To avoid electrostatic charge build-up, it must not be rubbed or cleaned with solvents or a dry cloth.
3. The model 702 may only be used with either the 701PBKKF Rosemount Smartpower Black Power Module or the Computational Systems, Inc. (CSI) MHM-89004.

| Sensor terminal parameters (option code 32) | Fuel sensor terminal parameters (option code 61) |
|---|--|
| U <sub>0</sub> = 6.6 V                      | U <sub>0</sub> = 7.8 V                           |
| I <sub>0</sub> = 13.37 mA                   | I <sub>0</sub> = 92 mA                           |
| P <sub>0</sub> = 21.77 mW                   | P <sub>0</sub> = 180 mW                          |
| C <sub>0</sub> = 21.78 μF                   | C <sub>0</sub> = 9.2 μF                          |
| L <sub>0</sub> = 198 mH                     | L <sub>0</sub> = 4.2 mH                          |

7.6.2 N5 U.S.A. Nonincendive

**Certificate:** [CSA] 1143113

**Standards:** Class 3600 - 2011, Class 3611 - 2004, Class 3810 - 2005, UL 50E (11th Edition), UL 61010-1 (3rd Edition), ANSI/IEC 60529-2004

**Markings:** NI CL I, DIV 2, GP A, B, C, D T4; T4(-50 °C ≤ T<sub>a</sub> ≤ +70 °C) Type 4X/IP66/67

**Special Conditions for Safe Use (X):**

1. The model 702 may only be used with either the 701PBKKF Rosemount Smartpower Black Power Module or the Computational Systems, Inc. (CSI) MHM-89004.

## 7.7 Canada

### 7.7.1 I6 Canada Intrinsically Safe

**Certificate:** [CSA] 1143113

**Standards:** CAN/CSA C22.2 No. 0-10, CSA Std. C22.2 No. 94-M1991 (R2011), CAN/CSA Std C22.2 60079-0-11, CAN/CSA 60079-11-14, CSA Std C22.2 No. 60529:05, CAN/CSA-C22.2 No. 61010-1-12

**Markings:** Intrinsically Safe Class I, Division 1; Groups A, B, C, and D, T4; suitable for Class 1, Zone 0, IIC, T4; when connected per Rosemount drawing 00702-1020; Type 4X

#### Special Conditions for Safe Use (X):

1. The Rosemount 702 Transmitter housing contains aluminum and is considered a potential risk of ignition by impact or friction. Care must be taken into account during installation and use to prevent impact and friction.
2. The surface resistivity of the polymeric antenna is greater than 1GΩ. To avoid electrostatic charge build-up, it must not be rubbed or cleaned with solvents or a dry cloth.
3. The model 702 may only be used with either the 701PBKFF Rosemount Smartpower Black Power Module or the Computational Systems, Inc. (CSI) MHM-89004.

### 7.7.2 N6 Canada Class I Division 2

**Certificate:** [CSA] 1143113

**Standards:** CAN/CSA C22.2 No. 0-10, CAN/CSA C22.2 No. 94-M91, CSA C22.2 No. 213-M1987, CSA Std C22.2 No. 60529:05

**Markings:** Suitable for Class 1, Division 2, Groups A, B, C, and D, T4; Cl. I, Zone 2, IIC, T4

#### Special Condition for Safe Use (X):

1. The model 702 may only be used with either the 701PBKFF Rosemount Smartpower Black Power Module or the Computational Systems, Inc. (CSI) MHM-89004.

## 7.8 Europe

### 7.8.1 I1 ATEX Intrinsic Safety

**Certificate:** Baseefa07ATEX0239X

**Standards:** IEC 60079-0: 2011, IEC 60079-11: 2012

**Markings:**  II 1 G Ex ia IIC T4 Ga, T4(-60 °C ≤ T<sub>a</sub> ≤ +70 °C) Ex ia IIC T4 Ga, T4(-60 °C ≤ T<sub>a</sub> ≤ +40 °C)

For use with Rosemount SmartPower power module part number 753-9220-0001, or for use with Emerson SmartPower option 701PBKKF.

| Sensor terminal parameters (option code 32) | Fuel sensor terminal parameters (option code 61) |
|---|--|
| U <sub>O</sub> = 6.51 V                     | U <sub>O</sub> = 7.8 V                           |
| I <sub>O</sub> = 13.37 mA                   | I <sub>O</sub> = 92 mA                           |
| P <sub>O</sub> = 21.76 mW                   | P <sub>O</sub> = 180 mW                          |
| C <sub>i</sub> = 0.216 μF                   | C <sub>i</sub> = 10 nF                           |
| C <sub>O IIC</sub> = 21.78 μF               | C <sub>O IIC</sub> = 9.2 μF                      |
| C <sub>O IIB</sub> = 549.78 μF              | C <sub>O IIB</sub> = 129 μF                      |
| C <sub>O IIA</sub> = 1000 μF                | C <sub>O IIA</sub> = 1000 μF                     |
| L <sub>i</sub> = 0                          | L <sub>i</sub> = 0                               |
| L <sub>O IIC</sub> = 200 mH                 | L <sub>O IIC</sub> = 4.2 mH                      |
| L <sub>O IIB</sub> = 800 mH                 | L <sub>O IIB</sub> = 16.8 mH                     |
| L <sub>O IIA</sub> = 1000 mH                | L <sub>O IIA</sub> = 33.6 mH                     |

**Special Conditions for Safe Use (X):**

1. The surface resistivity of the antenna is greater than 1 GΩ. To avoid electrostatic charge build-up, it must not be rubbed or cleaned with solvents or a dry cloth.

**7.8.2 IU ATEX Intrinsic Safety for Zone 2**

**Certificate:** Baseefa12ATEX0122X  
**Standards:** IEC 60079-0: 2011, IEC 60079-11: 2012  
**Markings:**  II 1 G Ex ia IIC T4 Ga, T4(-60 °C ≤ T<sub>a</sub> ≤ +70 °C)  
 Ex ia IIC T5 Gc, T5(-60 °C ≤ T<sub>a</sub> ≤ +40 °C)

| Sensor terminal parameters (input) | Switch terminal parameters (output) |
|------------------------------------|-------------------------------------|
| U <sub>O</sub> = 6.6 V             | U <sub>i</sub> = 26 V               |
| I <sub>O</sub> = 13.4 mA           | I <sub>i</sub> = 100 mA             |
| P <sub>O</sub> = 21.8 mW           | P <sub>j</sub> = 0.65 W             |
| C <sub>O</sub> = 10.9 μF           | N/A                                 |
| L <sub>O</sub> = 25 μH             | N/A                                 |

**Special Conditions for Safe Use (X):**

1. The surface resistivity of the antenna is greater than 1 GΩ. To avoid electrostatic charge build-up, it must not be rubbed or cleaned with solvents or dry cloth.
2. The Rosemount 701PB Power Module may be replaced in a hazardous area. The power module has surface resistivity greater than 1 GΩ and must be properly installed in the wireless device enclosure. Care must be taken during transportation to and from the point of installation to prevent electrostatic charge build-up.

## 7.9 International

### 7.9.1 I7 IECEx Intrinsic Safety

**Certificate:** IECEx BAS 07.0082X**Standards:** IEC 60079-0: 2011, IEC 60079-11: 2011**Markings:** Ex ia IIC T4 Ga, T4(-40 °C ≤ T<sub>a</sub> ≤ +70 °C); Ex ia IIC T5 Ga, T5(-40 °C ≤ T<sub>a</sub> ≤ +40 °C)

| Sensor terminal parameters (option code 32) | Fuel sensor terminal parameters (option code 61) |
|---|--|
| U <sub>O</sub> = 6.51 V                     | U <sub>O</sub> = 7.8 V                           |
| I <sub>O</sub> = 13.37 mA                   | I <sub>O</sub> = 92 mA                           |
| P <sub>O</sub> = 21.76 mW                   | P <sub>O</sub> = 180 mW                          |
| C <sub>i</sub> = 0.216 μF                   | C <sub>i</sub> = 10 nF                           |
| C <sub>O IIC</sub> = 21.78 μF               | C <sub>O IIC</sub> = 9.2 μF                      |
| C <sub>O IIB</sub> = 549.78 μF              | C <sub>O IIB</sub> = 129 μF                      |
| C <sub>O IIA</sub> = 1000 μF                | C <sub>O IIA</sub> = 1000 μF                     |
| L <sub>i</sub> = 0                          | L <sub>i</sub> = 0                               |
| L <sub>O IIC</sub> = 200 mH                 | L <sub>O IIC</sub> = 4.2 mH                      |
| L <sub>O IIB</sub> = 800 mH                 | L <sub>O IIB</sub> = 16.8 mH                     |
| L <sub>O IIA</sub> = 1000 mH                | L <sub>O IIA</sub> = 33.6 mH                     |

**Special Conditions for Safe Use (X):**

1. The surface resistivity of the antenna is greater than 1 GΩ. To avoid electrostatic charge build-up, it must not be rubbed or cleaned with solvents or dry cloth.
2. The Rosemount 701PBKFF Power Module may be replaced in a hazardous area. The power modules have a surface resistivity greater than 1GΩ and must be properly installed I the wireless device enclosure. Care must be taken during transportation to and from the point of installation to prevent electrostatic charge build-up.

- The Rosemount 702 enclosure may be made of aluminum alloy and given a protective polyurethane paint finish; however, care should be taken to protect it from impact or abrasion if located in a Zone 0 area.

### 7.9.2 IY IECEx Intrinsic Safety for Zone 2

**Certificate:** IECEx BAS 12.0082X

**Standards:** IEC 60079-0: 2011, IEC 60079-11: 2011

**Markings:** Ex nA IIC T4 Gc, T4(-40 °C ≤ T<sub>a</sub> ≤ +70 °C); Ex nA IIC T5 Gc, T5(-40 °C ≤ T<sub>a</sub> ≤ +40 °C)

| Sensor terminal parameters (input) | Switch terminal parameters (output) |
|------------------------------------|-------------------------------------|
| U <sub>0</sub> = 6.6 V             | U <sub>i</sub> = 26 V               |
| I <sub>0</sub> = 13.4 mA           | I <sub>i</sub> = 100 mA             |
| P <sub>0</sub> = 21.8 mW           | P <sub>i</sub> = 0.65 W             |
| C <sub>0</sub> = 10.9 μF           | N/A                                 |
| L <sub>0</sub> = 25 μH             | N/A                                 |

#### Special Conditions for Safe Use (X):

- The surface resistivity of the antenna is greater than 1 GΩ. To avoid electrostatic charge build-up, it must not be rubbed or cleaned with solvents or dry cloth.
- The Rosemount 701PBKKF Power Module may be replaced in a hazardous area. The power modules have a surface resistivity greater than 1 GΩ and must be properly installed in the wireless device enclosure. Care must be taken during transportation to and from the point of installation to prevent electrostatic charge build-up.
- The Rosemount 702 enclosure may be made of aluminum alloy and given a protective polyurethane paint finish; however, care should be taken to protect it from impact or abrasion if located in a Zone 0 area.

## 7.10 China

### 7.10.1 I3 China Intrinsic Safety

**Certificate:** GYJ13.1238X

**Standards:** GB3836.1-2010, GB3836.4-2010, GB3836.20-2010

**Markings:** (option 32, 61): Ex ia IIC T4/T5 Ga, T4(-60 ≤ T<sub>a</sub> ≤ 70 °C)/T5(-60 ≤ T<sub>a</sub> ≤ 40 °C)  
 (option 32, 42): Ex ic IIC T4/T5 Gc, T4(-60 ≤ T<sub>a</sub> ≤ 70 °C)/T5(-60 ≤ T<sub>a</sub> ≤ 40 °C)

| Sensor terminal parameters<br>(option code 32) | Terminal parameters (option code 42) |                       | Fuel sensor terminal parameters (option code 61) |
|--|--------------------------------------|-----------------------|--|
|  | Sensor                               | Switch                |  |
| $U_O = 6.6\text{ V}$                           | $U_O = 6.6\text{ V}$                 | $U_i = 26\text{ V}$   | $U_O = 7.8\text{ V}$                             |
| $I_O = 13.4\text{ mA}$                         | $I_O = 13.4\text{ mA}$               | $I_i = 100\text{ mA}$ | $I_O = 92\text{ mA}$                             |
| $P_O = 21.8\text{ mW}$                         | $P_O = 21.8\text{ mW}$               | $P_i = 650\text{ mW}$ | $P_O = 180\text{ mW}$                            |
| $C_{O\text{ IIC}} = 21.78\text{ }\mu\text{F}$  | $C_O = 10.9\text{ }\mu\text{F}$      | N/A                   | $C_O = 9.29\text{ }\mu\text{F}$                  |
| $C_{O\text{ IIB}} = 499.78\text{ }\mu\text{F}$ | N/A                                  | N/A                   | N/A  |
| $C_{O\text{ IIA}} = 1000\text{ }\mu\text{F}$   | N/A                                  | N/A                   | N/A  |
| $L_{O\text{ IIC}} = 200\text{ mH}$             | $L_O = 0.025\text{ mH}$              | N/A                   | $L_O = 2\text{ mH}$                              |
| $L_{O\text{ IIB}} = 800\text{ mH}$             | N/A                                  | N/A                   | N/A  |
| $L_{O\text{ IIA}} = 1000\text{ mH}$            | N/A                                  | N/A                   | N/A  |

### Special Conditions for Safe Use (X):

1. See certificate for special conditions.

## 7.11 Japan

### 7.11.1 I4 TIS Intrinsic Safety

**Certificates:** TC20411 (Option 32), TC20412 (Option 61)

**Markings:** Ex ia IIC T4 X (-20 ≤ T<sub>a</sub> ≤ +60 °C)

## 7.12 EAC – Belarus, Kazakhstan, Russia

### 7.12.1 IM Technical Regulation Customs Union (EAC) Intrinsic Safety

**Certificate:** RU C-US.Gb05.B.00578

**Markings:** (option 32, 61): 0Ex ia IIC T4/T5 X, T4(-60 °C ≤ T<sub>a</sub> ≤ +70 °C)/  
T5(-60 °C ≤ T<sub>a</sub> ≤ +40 °C)

(option 32, 42): 2Ex ic IIC T4/T5 X, T4(-60 °C ≤ T<sub>a</sub> ≤ +70 °C)/  
T5(-60 °C ≤ T<sub>a</sub> ≤ +40 °C)

| Sensor terminal parameters<br>(option code 32) | Terminal parameters (option code 42)      |                            | Fuel sensor terminal parameters (option code 61) |
|--|---|----------------------------|--|
|  | Sensor                                    | Switch                     |  |
| $U_O = 6.6\text{ B}$                           | $U_O = 6.6\text{ B}$                      | $U_i, B = 26\text{ B}$     | $U_O = 7.8\text{ B}$                             |
| $I_O = 13.4\text{ MA}$                         | $I_O = 13.4\text{ MA}$                    | $I_i, MA = 100\text{ MA}$  | $I_O = 92\text{ MA}$                             |
| $P_O = 21.8\text{ MBT}$                        | $P_O = 21.8\text{ MBT}$                   | $P_i, BT = 650\text{ MBT}$ | $P_O = 180\text{ MBT}$                           |
| $C_i = 216\text{ H}\Phi$                       | $C_i = 216\text{ H}\Phi$                  | N/A                        | $C_i = 10\text{ H}\Phi$                          |
| $C_{O\text{ IIC}} = 23.78\text{ мк}\Phi$       | $C_{O\text{ IIC}} = 23.78\text{ мк}\Phi$  | N/A                        | N/A  |
| $C_{O\text{ IIB}} = 549.78\text{ мк}\Phi$      | $C_{O\text{ IIB}} = 549.78\text{ мк}\Phi$ | N/A                        | N/A  |

| Sensor terminal parameters (option code 32) | Terminal parameters (option code 42) |           | Fuel sensor terminal parameters (option code 61) |
|---|--------------------------------------|-----------|--|
|   | Sensor                               | Switch    |  |
| $C_{O\ II A} = 1000 \text{ мкФ}$            | $CO\ II A = 1000 \text{ мкФ}$        | N/A       | N/A  |
| $L_i = 0$                                   | $L_i = 0$                            | $L_i = 0$ | $L_i = 0$  |
| $L_{O\ II C} = 200 \text{ МГН}$             | $L_{O\ II C} = 200 \text{ МГН}$      | N/A       | N/A  |
| $L_{O\ II B} = 800 \text{ МГН}$             | $L_{O\ II B} = 800 \text{ МГН}$      | N/A       | N/A  |
| $L_{O\ II A} = 1000 \text{ МГН}$            | $L_{O\ II A} = 1000 \text{ МГН}$     | N/A       | N/A  |

**Special Conditions for Safe Use (X):**



1. See certificate for special conditions.

### 7.13 Combinations

**KQ**      Combination of I1, I5, and I6

# 7.14 EU Declaration of Conformity

Figure 7-1: EU Declaration of Conformity

|   |                                     |   |
|---|-------------------------------------|---|
|  <b>EMERSON</b>  | <b>EU Declaration of Conformity</b> |  |
| No: RMD 1066 Rev. N   |                                     |   |
| We,   |                                     |   |
| <b>Rosemount, Inc.</b><br><b>8200 Market Boulevard</b><br><b>Chanhasen, MN 55317-9685</b><br><b>USA</b>   |                                     |   |
| declare under our sole responsibility that the product,   |                                     |   |
| <b>Rosemount 702 Wireless Discrete Transmitter</b>  |                                     |   |
| manufactured by,  |                                     |   |
| <b>Rosemount, Inc.</b><br><b>8200 Market Boulevard</b><br><b>Chanhasen, MN 55317-9685</b><br><b>USA</b>   |                                     |   |
| to which this declaration relates, is in conformity with the provisions of the European Union Directives, including the latest amendments, as shown in the attached schedule.                       |                                     |   |
| Assumption of conformity is based on the application of the harmonized standards and, when applicable or required, a European Union notified body certification, as shown in the attached schedule. |                                     |   |
|    | Vice President of Global Quality    |   |
| (signature)   | (function)                          |   |
| Chris LaPoint   | May 24, 2017                        |   |
| (name)  | (date of issue)                     |   |
| Page 1 of 3   |                                     |   |



# EU Declaration of Conformity



No: RMD 1066 Rev. N

## EMC Directive (2014/30/EU)

Harmonized Standards:  
EN 61326-1: 2013  
EN 61326-2-3: 2013

## Radio Equipment Directive (RED) (2014/53/EU)

Harmonized Standards:  
EN 300 328 V2.1.1  
EN 301 489-1 V2.2.0  
EN 301 489-17: V3.2.0  
EN 61010-1: 2010  
EN 62479: 2010

## ATEX Directive (2014/34/EU)

### Rosemount 702 Wireless Discrete Transmitter (Options 22, 32, and 61)

**Baseefa07ATEX0239X – Intrinsic Safety**  
Equipment Group II, Category 1 G  
Ex ia IIC T4/T5 Ga  
Ex ia I Ma  
Harmonized Standards:  
EN 60079-0:2012  
EN 60079-11:2012

### Rosemount 702 Wireless Discrete Transmitter (Options 32 and 42)

**Baseefa12ATEX0122X – Intrinsic Safety**  
Equipment Group II, Category 3 G  
Ex ic IIC T4/T5 Gc  
Harmonized Standards:  
EN 60079-0: 2012  
EN 60079-11: 2012



# EU Declaration of Conformity

No: RMD 1066 Rev. N



## ATEX Notified Body

**SGS Baseefa Limited** [Notified Body Number: 1180]  
Rockhead Business Park,  
Staden Lane  
Buxton, Derbyshire  
SK179RZ United Kingdom

## ATEX Notified Body for Quality Assurance

**SGS Baseefa Limited** [Notified Body Number: 1180]  
Rockhead Business Park,  
Staden Lane  
Buxton, Derbyshire  
SK179RZ United Kingdom

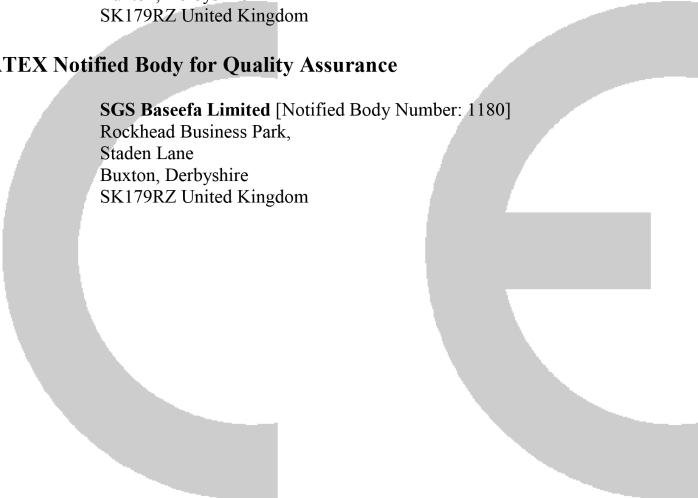

# 7.15 China RoHS

含有China RoHS管控物质超过最大浓度限值的部件型号列表 Rosemount 702  
List of Rosemount 702 Parts with China RoHS Concentration above MCVs

| 部件名称<br>Part Name               | 有害物质 / Hazardous Substances |                      |                      |  |  |  |
|---------------------------------|-----------------------------|----------------------|----------------------|--|--|--|
|                                 | 铅<br>Lead<br>(Pb)           | 汞<br>Mercury<br>(Hg) | 镉<br>Cadmium<br>(Cd) | 六价铬<br>Hexavalent<br>Chromium<br>(Cr +6) | 多溴联苯<br>Polybrominated<br>biphenyls<br>(PBB) | 多溴联苯醚<br>Polybrominated<br>diphenyl ethers<br>(PBDE) |
| 电子组件<br>Electronics<br>Assembly | X                           | O                    | O                    | O  | O  | O  |
| 壳体组件<br>Housing<br>Assembly     | X                           | O                    | O                    | X  | O  | O  |

本表格系依据SJ/T11364的规定而制作。

This table is proposed in accordance with the provision of SJ/T11364.

O: 意为该部件的所有均质材料中该有害物质的含量均低于GB/T 26572所规定的限量要求。

O: Indicate that said hazardous substance in all of the homogeneous materials for this part is below the limit requirement of GB/T 26572.

X: 意为在该部件所使用的的所有均质材料里，至少有一类均质材料中该有害物质的含量高于GB/T 26572所规定的限量要求。

X: Indicate that said hazardous substance contained in at least one of the homogeneous materials used for this part is above the limit requirement of GB/T 26572.







**Quick Start Guide**  
**00825-0400-4702, rev. GE**  
**April 2018**

#### **Global Headquarters**

Emerson Automation Solutions  
6021 Innovation Blvd  
Shakopee, MN 55379 USA  
+1 800 999 9307 or +1 952 906 8888  
+1 952 949 7001  
RFQ.RMD-RCC@Emerson.com

#### **Latin America Regional Office**

Emerson Automation Solutions  
Sunrise, FL 33323, USA  
T +1 954 846 5030  
+1 954 846 5121  
RFQ.RMD-RCC@Emerson.com

#### **Middle East and Africa Regional Office**

Emerson Automation Solutions  
Emerson FZE P.O. Box 17033  
Jebel Ali Free Zone - South 2  
Dubai, United Arab Emirates  
+971 4 81 18100  
+971 4 8865465  
RFQ.RMTMEA@Emerson.com

#### **North America Regional Office**

Emerson Automation Solutions  
8200 Market Blvd.  
Chanhassen, MN 55317, USA  
+1 800 999 9307 or +1 952 906 8888  
+1 952 949 7001  
RMT-NA.RCCRF@Emerson.com

#### **Europe Regional Office**

Emerson Automation Solutions Europe GmbH  
Neuhofstrasse 19a P.O. Box 1046  
CH 6340 Baar  
Switzerland  
T +41 (0) 41 768 6111  
+41 (0) 41 768 6300  
RFQ.RMD-RCC@Emerson.com

©2018 Emerson. All rights reserved.

Emerson Terms and Conditions of Sale are available upon request. The Emerson logo is a trademark and service mark of Emerson Electric Co. Rosemount is mark of one of the Emerson family of companies. All other marks are the property of their respective owners.