

User's Manual

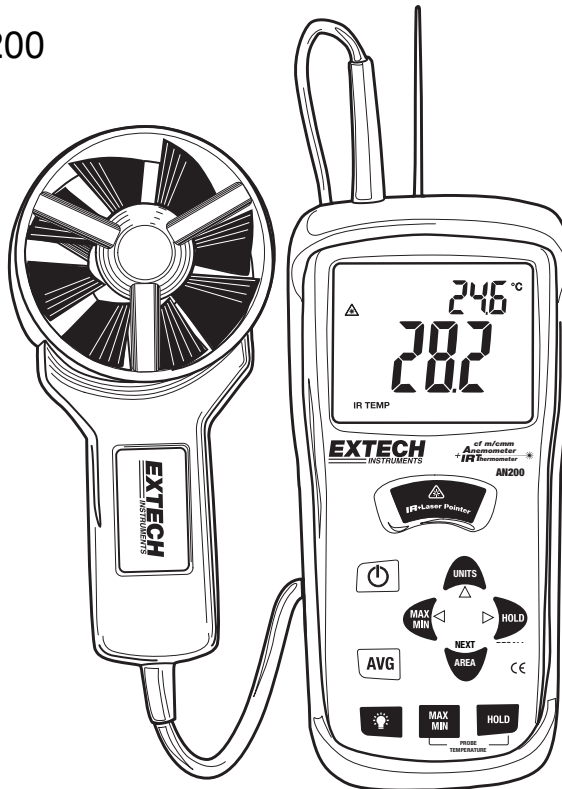

## CFM/CMM Thermo Anemometer + InfraRed Thermometer

Model AN200



## ***Introduction***

---

Congratulations on your purchase of the Extech AN200 CFM/CMM Thermo Anemometer with InfraRed Thermometer. This instrument measures Air Velocity, Air Flow (volume), Air Temperature (with probe) and Surface Temperature (with the InfraRed function). The large, easy-to-read backlit LCD includes primary and secondary displays plus numerous status indicators. The InfraRed feature includes a laser pointer for convenient targeting. In addition, the meter can store 16 area setting dimension for easy recall. This meter is shipped fully tested and calibrated and with proper use will provide years of reliable service.

## ***Safety***

---

- Use extreme caution when the laser pointer beam is on
- Do not point the beam toward anyone's eye or allow the beam to strike the eye from a reflective surface
- Do not use the laser near explosive gases or in other potentially explosive areas



## Specifications

<b>Air Velocity</b>	<b>Range</b>	<b>Resolution</b>	<b>Accuracy</b>
m/s (meters per sec)	0.40 - 30.00 m/s	0.01 m/s	± (3%rdg + 0.20 m/s)
km/h (kilometers/hour)	1.4 - 108.0 km/h	0.1 km/h	± (3%rdg + 0.8 km/hr)
ft/min (feet per minute)	80 – 5900 ft/min	1 ft/min	± (3%rdg + 40 ft/m)
mph (miles per hour)	0.9 – 67.0 mph	0.1 mph	± (3%rdg + 0.4 MPH)
knots (nautical MPH)	0.8 to 58.0 knots	0.1 knots	± (3%rdg + 0.4 knots)
<b>Air Flow</b>	<b>Range</b>	<b>Resolution</b>	<b>Area</b>
CMM (cubic meters/min)	0-999999 m <sup>3</sup> /min	.1	0 to 999.9m <sup>2</sup>
CFM (cubic ft/min)	0-999999 ft <sup>3</sup> /min	.1	0 to 999.9ft <sup>2</sup>
<b>Air Temperature</b>	<b>Range</b>	<b>Resolution</b>	<b>Accuracy</b>
	14 - 140°F (-10 - 60°C)	0.1°F/C	4.0°F (2.0°C)
<b>InfraRed Temperature</b>	<b>Range</b>	<b>Resolution</b>	<b>Accuracy</b>
	-58 to -4°F (-50 to -20°C)	0.1°F/C	±9.0°F (5.0°C)
	-4 to 500°F (-20 to 260°C)	1°F/C	±2% reading or ±4°F (2°C) whichever is greater

<b>Circuit</b>	Custom LSI microprocessor circuit
<b>Display</b>	Dual function 0.5" (13 mm) 4-digit LCD
<b>Sampling rate</b>	1 reading per second approx.
<b>Sensors</b>	Air velocity/flow sensor: Conventional angled vane arms with low-friction ball bearing. Temperature sensors: NTC-type precision thermistor and InfraRed
<b>IR Spectral response</b>	6 to 14µm
<b>IR Emissivity</b>	0.95 fixed
<b>IR distance ratio</b>	8:1
<b>IR sampling rate</b>	2.5 readings per second approx.
<b>Automatic Power off</b>	Auto shut off after 20 minutes to preserve battery life
<b>Operating Temperature</b>	32°F to 122°F (0°C to 50°C)
<b>Storage Temperature</b>	14 to 140°F (-10 to 60°C)
<b>Operating Humidity</b>	<80% RH
<b>Storage Humidity</b>	<80% RH
<b>Operating Altitude</b>	2000 meters (7000ft) maximum
<b>Battery</b>	One 9 volt (NEDA 1604) battery
<b>Battery life</b>	80 hours approx. (if Backlight and Laser are used continuously the battery life is reduced to 2 to 3 hours approx.)
<b>Battery current</b>	8.3 mA DC approx.
<b>Weight</b>	1.6 lbs. (725g) including battery & probe
<b>Dimensions</b>	Main instrument: 7.0 x 2.9 x 1.2" (178 x 74 x 33mm) Sensor Head: 2.75" (70mm) Diameter

## Meter Description

---

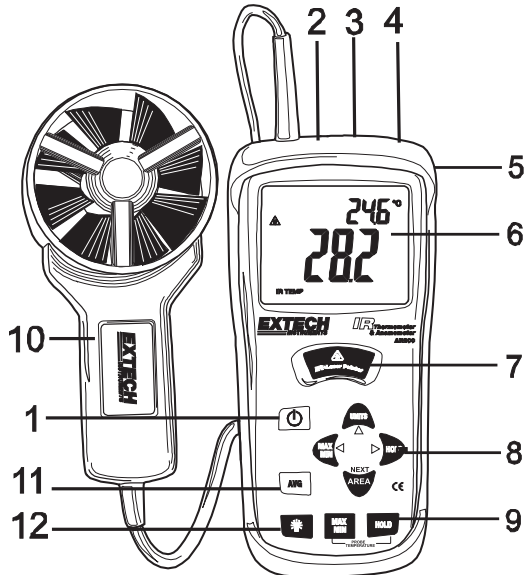

1. Power ON/OFF button
2. Probe input jack
3. Laser pointer
4. IR Sensor
5. Rubber holster
6. LCD Display
7. IR thermometer measurement button
8. Airflow buttons (4)
9. Air Temperature function buttons (2)
10. Vane
11. Airflow Average button
12. Backlight button

Note: The battery compartment, tilt stand and tripod mount are located on the rear of the instrument



## Keypad



---

-  Press to turn the meter ON or OFF
- **IR + Laser Pointer** Press and hold to measure.
- **MAX/MIN** Record and store the highest and lowest airflow or velocity readings.
  - ◀ (LEFT) also serves as change decimal point button in AREA mode
- **UNITS** Press to select the mode of operation. In FLOW mode, the meter displays air *volume*. In VELOCITY mode, the meter displays air *speed*.
  - ▲ (UP) also serves as increase number button in AREA mode.
- **HOLD** Press to freeze the displayed reading. Press again to unlock display.
  - ▶ (RIGHT) also serves as change digit button in AREA mode.
- **AREA** Press and hold to manually enter the area of a duct in CFM or CMM mode. Press and hold to scroll thru memory locations. This button also clears memory in the Averaging mode.
-  Press to turn the backlight on/off. Hold to disable Auto Power Off.
- **MAX/MIN (Temperature)** Press to record and store the highest, lowest readings for air temperature.
- **HOLD (Temperature)** Press to freeze the displayed temperature reading. Press again to unlock the display.
- **AVG** Press and hold to enter averaging mode. Averages up to 20 readings.

## Display Layout

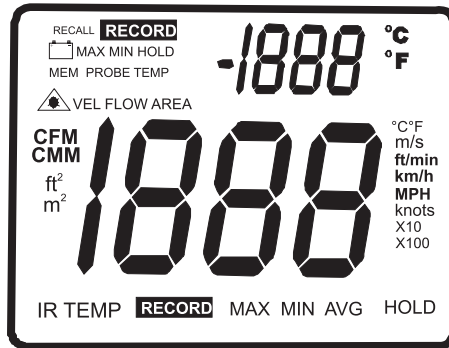
---



- **MAX** (top of LCD): Max Hold function engaged for the Air Temperature function
- **HOLD** (top of LCD): Data Hold function engaged for the Air Temperature function
- **PROBE TEMP**: Reminder that the top LCD digits represent Air (Vane) Temperature
-  : Indicates that the laser pointer is on.
- **IR TEMP**: Indicates that the larger LCD digits represent IR temperature measurement
- **VEL**: indicates that meter is in air velocity mode
- **FLOW**: indicates that meter is in air flow mode
- **MAX** (bottom of LCD): Max Hold for the IR Temperature and RH function
- **HOLD** (bottom of LCD): Data Hold for the IR Temperature function and RH function
- **°C / °F**: Temperature units of measure
- **CFM/CMM**: airflow units of measure
- **Ft<sup>2</sup>, m<sup>2</sup>**: units for area dimensions
- **m/s, ft/min, km/h, MPH, knots**: air velocity units of measure
- **X10, X100**: multipliers for air flow readings
- **AVG**: air averaging mode
- **RECORD**: indicates that min/max function is running (top for temp, bottom for air)
- Large LCD digits at center of display for Relative Humidity and IR Temperature
- Smaller LCD digits at top, right of display for Probe Temperature
-  Low battery indicator

# Operation

---

## Connecting the Vane

1. The vane plug is inserted in the meter's sensor jack at the top of the meter. The plug and jack are keyed so that the plug can only fit in the jack one way.
2. Turn the plug carefully until it lines up with the jack and then firmly push the plug in place. Do not apply undue force or try to twist the plug side-to-side.
3. If the vane is not connected to the meter or if the sensor is defective, the LCD display will indicate dashed lines in place of an air velocity reading.

## Air Velocity Measurements

1. Turn on the meter using the  ON/OFF button.
2. Press **UNITS** button to select the desired unit of measure. **NOTE:** At power up the meter will display the last unit of measure previously entered.
3. Place the sensor in the air stream. Ensure that the air enters the vane as indicated by the arrow sticker placed inside the vane. Refer to the diagram.
4. View the air velocity and temperature readings on the LCD Display. The large main LCD display shows the Air Velocity reading. The upper right LCD sub-display shows the temperature reading.

Side view of Vane

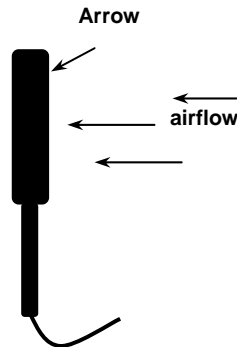

## Air Velocity Measurements (Up to 20 Point averaging)

1. To enter 20 Point Averaging Mode, press and hold the **AVG** button until it beeps twice. The **AVG** icon will be displayed.
2. Take a measurement and press the **AVG** button. A single beep will sound and the **HOLD** icon will appear in the display.
3. The average reading will be displayed and number of readings measured will appear in the upper right hand corner of the display. After 5 seconds, the display will return to the current reading.
4. Repeat steps 2 - 3 until all desired points have been measured.
5. To return to standard velocity measuring mode press and hold **AVG** button until meter beeps twice.

**Note:** In the standard velocity measuring mode, press the **AVG** button once to recall the previous average. The average will be cleared when you enter the Averaging Mode again.

### Air Flow Measurements (CMM / CFM)

1. Turn on the meter using the  ON/OFF button
2. Press the **UNITS** button to select the desired air flow units: CMM (cubic meters per minute) or CFM (cubic feet per minute). **NOTE:** At power up the meter will display the last unit of measure previously entered.
3. To begin entering the area in m<sup>2</sup> or ft<sup>2</sup>, press and hold the **AREA** button until it beeps twice. The leftmost digit of the bottom display will begin to flash.
4. Use the **▲** (UP) button to change the flashing digit  
Use the **◀** (LEFT) button to move the decimal  
Use **▶** (RIGHT) button to select the other digits.  
After all of the digits are entered, press and hold the **AREA** button (until meter beeps twice) to save the area into memory and return to CFM or CMM measuring mode.
5. Place the sensor in the air stream. Ensure that the air enters the vane as indicated by the arrow sticker placed inside the vane. Refer to the diagram. The large main LCD display shows the Air Velocity reading. The upper right LCD sub-display shows the temperature reading.

Side view of Vane

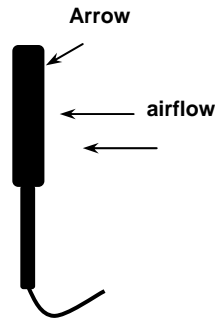

The meter has 16 memory locations (8 for CFM and 8 for CMM) that can be used to store commonly used area sizes that you can recall at anytime.

1. Press the **AREA** button until meter beeps twice. A memory location number will appear in the top right of the display indicating the memory location.
2. Push the **AREA** button to scroll thru and select the desired location. Once you have selected the desired memory location enter your dimension  
Use the **▲** (UP) button to change the flashing digit  
Use the **◀** (LEFT) button to move the decimal  
Use **▶** (RIGHT) button to select the other digits. After all of the digits are entered, press and hold the **AREA** button (until it beeps twice) to save the area into memory and return to CFM or CMM measuring mode.

To select and use a previously stored dimension, press and hold the **AREA** button until it beeps twice.

Press **AREA** to scroll thru the 8 memory locations. Press and hold the **AREA** button until it beeps twice to return to the CFM or CMM measuring mode.

### Air Flow Measurements (Up to 20 Point averaging)

1. To enter 20 Point Averaging Mode, press and hold the **AVG** button until it beeps twice. The **AVG** icon will be displayed.
2. Take a measurement and press the **AVG** button. A single beep will sound and the **HOLD** icon will appear in the display.
3. The average reading will be displayed and number of readings measured will appear in the upper right hand corner of the display. After 5 seconds, the display will return to the current reading. (IMPORTANT: Please note that the average readings are only held for 5 seconds and cannot be recalled.)
4. Repeat steps 2 - 3 until all desired points have been measured.
5. Press the **AREA** button to clear the multipoint averaging memory.
6. To return to standard airflow measuring mode press and hold **AVG** button until meter beeps twice.

### **Data Hold (Air Velocity/Air Flow)**

1. While taking measurements, press the **HOLD** button to freeze the air velocity/air flow reading for later viewing.
2. The **HOLD** indicator will appear in the bottom of the LCD display.
3. Press **HOLD** again to return to normal operation.

### **MAX/MIN/AVG Record (Air Velocity/Air Flow)**

This allows the user to record and view the highest (MAX), lowest (MIN) and average (AVG) readings.

1. Press the button **MAX/MIN** button. The **AVG** indicator and **RECORD** indicator along with the average reading will appear on the LCD display and the meter will begin keeping track of the MAX, MIN and Average values.
2. Press the **MAX/MIN** button again. The **MAX** indicator will appear on the display and display the Max reading.
3. Press the **MAX/MIN** button again to view the minimum reading. The **MIN** indicator along with the minimum reading will appear on the LCD display and display the Min reading.
4. Press the **MAX/MIN** button again to display current readings. **NOTE:** the meter will keep recording MAX/MIN/AVG readings.
5. To clear and stop MAX/MIN/AVG recording and return to normal operation, press the **AREA** button once when displaying the current reading.

## Temperature Units

1. Remove the meter's rubber protective jacket and select the desired temperature units using the °F/°C slide switch located in the battery compartment.
2. Replace the protective jacket and connect the sensor to the sensor input jack on top of the meter.

## Data Hold (Air Temperature)

1. While taking measurements, press the **PROBE TEMPERATURE HOLD** button to freeze the air temperature reading.
2. The HOLD indicator will appear in the bottom of the LCD display.
3. Press **PROBE TEMPERATURE HOLD** again to return to normal operation.

## Max/Min Record (Air Temperature)

This allows the user to record and view the highest (MAX), lowest (MIN) air temperature readings.

1. Press the TEMPERATURE MAX/MIN button once. The **MAX** indicator will appear on the display and the meter will begin keeping track of the MAX/MIN air temperature values.
2. Press the button again to view the minimum reading. The **MIN** indicator along with the minimum air temperature reading will appear on the LCD display.
3. Press the button again to return to normal operation.

## Automatic Power OFF

To conserve battery life, the meter automatically turns off after 20 minutes. To override this feature:

1. Turn the meter OFF.
2. Press and hold the  (Backlight) key while turning the meter ON.
3. "dis APO" will appear in the display. The AUTO POWER OFF feature will now be disabled.
4. Note that AUTO POWER OFF is re-enabled each time the meter is turned on.
5. Also note that AUTO POWER OFF is disabled in CFM/CMM mode.

## InfraRed (Non-Contact) Temperature Measurements

1. The IR sensor is located at the top of the meter.
2. Point the sensor toward the surface to be measured.
3. Press and hold the red IR button to begin measuring the surface temperature of a desired target. IR TEMP and  will appear on the display. The laser pointer will switch on to help aim the meter.
4. The measured IR surface temperature will appear at the center of the LCD (larger digits). The temperature displayed is the temperature of the area within the spot.
5. When the red IR button is released, the laser pointer will switch off and the reading will freeze (data hold) on the display for approximately 3 seconds.
6. Note that the vane (Air Temperature) continues to monitor temperature during IR tests and its temperature is displayed on the top of the LCD (smaller digits).
7. After approximately 3 seconds the meter defaults to the Air Flow and Air Temperature display.

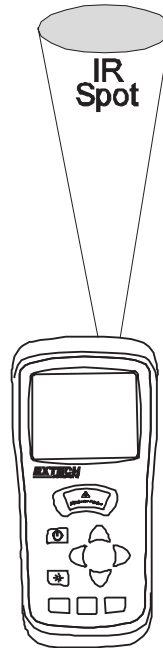

**WARNING: Do not directly view or direct the laser pointer at an eye.** Low power visible lasers do not normally present a hazard, but may present some potential for hazard if viewed directly for extended periods of time.



## Battery Replacement

When  appears on the LCD, the 9V battery must be replaced.

1. Disconnect the vane.
2. Remove the meter's rubber protective jacket
3. Use a Phillips screwdriver to open the rear battery compartment
4. Replace the 9V battery
5. Close the battery compartment and replace the meter's protective jacket

## InfraRed Measurement Considerations

- When taking IR measurements the meter automatically compensates for ambient temperature changes. Note that it may take up to 30 minutes to adjust to extremely wide ambient changes.
- Low temperature measurements quickly followed by high temperature measurements may require several minutes to stabilize as a result of the IR sensor cooling process.
- If the surface of the object under test is covered with frost, oil, grime, etc., clean before taking measurements.
- If an object's surface is highly reflective apply masking tape or flat black paint before measuring.
- Steam, dust, smoke, etc. can obstruct measurements.
- To find a hot spot, aim the meter outside the area of interest then scan across (in an up and down motion) until the hot spot is located.

### IR Theory

IR thermometers measure the surface temperature of an object. The meter's optics sense emitted, reflected, & transmitted energy that is collected and focused onto the meter's detector. The meter's circuitry translates this information into an LCD reading.

### IR Field of View

Ensure that the desired target is larger than the spot size as shown in the diagram below. As the distance from an object increases, the spot size of the area measured by the meter becomes larger. The meter's field of view ratio is 8:1, meaning that if the meter is 8 inches from the target, the diameter (spot) of the object under test must be at least 1 inch. Other distances are shown below in the field of view diagram.

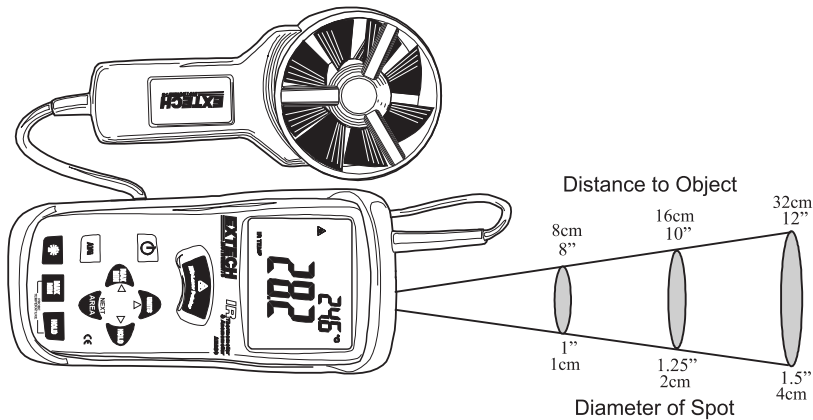

### Emissivity

Most organic materials and painted or oxidized surfaces have an emissivity of 0.95. Inaccurate readings will result when measuring shiny or polished surfaces. To compensate, cover the surface under test with masking tape or flat black paint. Allow time for the tape to reach the same temperature as the material underneath then measure the temperature of the tape or the painted surface.

### Thermal Emissivity Table for Common Materials

Material	Emissivity	Material	Emissivity
Asphalt	0.90 to 0.98	Cloth (black)	0.98
Concrete	0.94	Human skin	0.98
Cement	0.96	Leather	0.75 to 0.80
Sand	0.90	Charcoal (powder)	0.96
Earth	0.92 to 0.96	Lacquer	0.80 to 0.95
Water	0.67	Lacquer (matt)	0.97
Ice	0.96 to 0.98	Rubber (black)	0.94
Snow	0.83	Plastic	0.85 to 0.95
Glass	0.85 to 1.00	Timber	0.90
Ceramic	0.90 to 0.94	Paper	0.70 to 0.94
Marble	0.94	Chromium oxides	0.81
Plaster	0.80 to 0.90	Copper Oxides	0.78
Mortar	0.89 to 0.91	Iron Oxides	0.78 to 0.82
Brick	0.93 to 0.96	Textiles	0.90

## Useful Equations and Conversions

---

### Area equation for rectangular or square ducts



Width (W)

Height (H)

$$\text{Area (A)} = \text{Width (W)} \times \text{Height (H)}$$

### Area equation for circular ducts

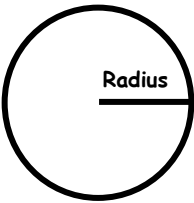

Radius

$$\text{Area (A)} = \pi \times r^2$$

Where  $\pi = 3.14$  and  $r^2 = \text{radius} \times \text{radius}$

### Cubic equations

$$\begin{aligned} \text{CFM (ft}^3/\text{min)} &= \text{Air Velocity (ft/min)} \times \text{Area (ft}^2\text{)} \\ \text{CMM (m}^3/\text{min)} &= \text{Air Velocity (m/sec)} \times \text{Area (m}^2\text{)} \times 60 \end{aligned}$$

**NOTE:** Measurements made in *inches* must be converted to *feet* or *meters* before using the above formulae.

### Unit of Measure Conversion Table

	m/s	ft/min	knots	km/h	MPH
1 m/s	1	196.87	1.944	3.6	2.24
1 ft/min	0.00508	1	0.00987	0.01829	0.01138
1 knot	0.5144	101.27	1	1.8519	1.1523
1 km/h	0.2778	54.69	0.54	1	0.6222
1 MPH	0.4464	87.89	0.8679	1.6071	1

## Warranty

---

**EXTECH INSTRUMENTS CORPORATION** warrants this instrument to be free of defects in parts and workmanship for **one year** from date of shipment (a six month limited warranty applies to sensors and cables). If it should become necessary to return the instrument for service during or beyond the warranty period, contact the Customer Service Department at (781) 890-7440 ext. 210 for authorization or visit our website [www.extech.com](http://www.extech.com) for contact information. A Return Authorization (RA) number must be issued before any product is returned to Extech. The sender is responsible for shipping charges, freight, insurance and proper packaging to prevent damage in transit. This warranty does not apply to defects resulting from action of the user such as misuse, improper wiring, operation outside of specification, improper maintenance or repair, or unauthorized modification. Extech specifically disclaims any implied warranties or merchantability or fitness for a specific purpose and will not be liable for any direct, indirect, incidental or consequential damages. Extech's total liability is limited to repair or replacement of the product. The warranty set forth above is inclusive and no other warranty, whether written or oral, is expressed or implied.

## Calibration and Repair Services

---

Extech offers repair and calibration services for the products we sell. Extech also provides NIST certification for most products. Call the Customer Service Department for information on calibration services available for this product. Extech recommends that annual calibrations be performed to verify meter performance and accuracy.



### Support line (781) 890-7440

Technical support: Extension 200; E-mail: [support@extech.com](mailto:support@extech.com)

Repair & Returns: Extension 210; E-mail: [repair@extech.com](mailto:repair@extech.com)

### Product specifications subject to change without notice

For the latest version of this User's Guide, Software updates, and other up-to-the-minute product information, visit our website: [www.extech.com](http://www.extech.com)  
Extech Instruments Corporation, 285 Bear Hill Rd., Waltham, MA 02451

### Copyright © 2006 Extech Instruments Corporation

All rights reserved including the right of reproduction in whole or in part in any form.