

# DIN-Rail Mount SMPS



## SPB-A Series PRODUCT MANUAL

For your safety, read and follow the considerations written in the instruction manual, other manuals and Autonics website.

The specifications, dimensions, etc. are subject to change without notice for product improvement. Some models may be discontinued without notice.

### Major Features

- Various lineups for diverse applications (15 W ~ 480 W)
- Compact size for maximum space efficiency
- Improved power factor with PFC circuit
- Outstanding environmental resistance
  - : overcurrent / overvoltage protection and overheating prevention, wide temperature range
- Low output voltage indicator (red LED), output indicator (green LED)
- Simple and easy installation

### Safety Considerations

- Observe all 'Safety Considerations' for safe and proper operation to avoid hazards.
- ⚠ symbol indicates caution due to special circumstances in which hazards may occur.

**⚠ Warning** Failure to follow instructions may result in serious injury or death.

- 01. Fail-safe device must be installed when using the unit with machinery that may cause serious injury or substantial economic loss. (e.g. nuclear power control, medical equipment, ships, vehicles, railways, aircraft, combustion apparatus, safety equipment, crime / disaster prevention devices, etc.)**  
Failure to follow this instruction may result in personal injury, economic loss or fire.
- 02. Do not use the unit in the place where flammable / explosive / corrosive gas, high humidity, direct sunlight, radiant heat, vibration, impact, or salinity may be present.**  
Failure to follow this instruction may result in explosion or fire.
- 03. Connect the ground completely to the PE terminal.**  
Failure to follow this instruction may result in electric shock or malfunction.
- 04. Do not connect, repair, or inspect the unit while connected to a power source.**  
Failure to follow this instruction may result in fire or electric shock.
- 05. Check 'Wiring Diagram' before wiring.**  
Failure to follow this instruction may result in fire, electric shock or product damage.
- 06. Do not disassemble or modify the unit.**  
Failure to follow this instruction may result in fire, electric shock or product damage.

**⚠ Caution** Failure to follow instructions may result in injury or product damage.

- 01. When connecting the terminal, tighten the terminal screw with a tightening torque of 0.3 to 0.5 N m.**  
Failure to follow this instruction may result in fire or malfunction due to contact failure.
- 02. Use the unit within the rated specifications.**  
Failure to follow this instruction may result in fire, product damage or shortening the life cycle of the product.
- 03. Use the device within the output derating curve by ambient temperature.**  
Failure to follow this instruction may result in product damage or shortening the life cycle of the product.
- 04. Use dry cloth to clean the unit, and do not use water or organic solvent.**  
Failure to follow this instruction may result in fire or electric shock.
- 05. Keep the product away from metal chip, dust, and wire residue which flow into the unit.**  
Failure to follow this instruction may result in fire or product damage.
- 06. Do not touch the product during operation or for a certain period of time after stopping.**  
Failure to follow this instruction may result in burns.
- 07. Upon occurrence of an error, disconnect the power source.**  
Failure to follow this instruction may result in fire or product damage.
- 08. Insert the twisted pair cable completely into the terminal block.**  
Failure to follow this instruction may result in fire or product damage.
- 09. Do not use the inverter output as a voltage input.**  
Failure to follow this instruction may result in fire due to rapid switching.
- 10. Do not use the device in conditions where inrush current or overload occurs frequently.**  
If short circuit or overcurrent condition is continued, it may result in fire or product damage.
- 11. Use an external diode when using it to operate a motor, etc.**  
If the voltage output exceeds the rated output voltage range, it may result in malfunction or product damage.
- 12. Use an external diode for serial/parallel operation.**  
Failure to follow this instruction may result in fire or product damage due to the reverse voltage generated inside the SMPS when the load is short-circuited.
- 13. In case of serial/parallel operation, make sure that the current over the rated current does not flow to the SMPS.**  
Failure to follow this instruction may result in product damage.

### Cautions during Use

- Follow instructions in 'Cautions during Use'. Otherwise, it may cause unexpected accidents.
- In the case of models with power of 120 / 240 / 480 W, noise may occur when power is input until the internal circuit stabilizes.
- When connecting the output terminal, cable length should be less than 30 m.
- If large current flows, use multiple terminal blocks.
- Do not use more than two output voltages in parallel and series connection.
- Install the device in a well-ventilated area. Install a cooling fan additionally in a poorly ventilated environment.

- There is a noise filter inside the device, but in an environment where a lot of noise occurs, install an additional noise filter outside.
- Install the device perpendicular to the ground.  
It may cause deterioration or damage to internal parts, and may affect specifications.
- If the device used at frequent inrush currents or overloads at the load end environments, internal parts may deteriorate or be damaged.
- Short-circuit or over-current conditions must not continue during operation. Internal parts may deteriorate or break.
- Do not turn the output voltage adjustment adjuster (V.Adjust) with excessive force. It may result in damage.
- Do not use near the equipment which generates strong magnetic force or high frequency noise.
- This unit may be used in the following environments.
  - Indoors (in the environment condition rated in 'Specifications')
  - Altitude max. 2,000m
  - Pollution degree 2
  - Installation category II

## Ordering Information

This is only for reference, the actual product does not support all combinations. For selecting the specified model, follow the Autonics website.

**SPB - A ① - ②**

### ① Power

Number: Power (unit: W)

### ② Output voltage

Number: Output voltage (unit: VDC=)

## Product Components

- Product × 1
- Instruction manual × 1

## Sold Separately

- Bracket: BK-SPB-F01 (SPB-A015 / 030 / 060-□)  
BK-SPB-F02 (SPB-A120 / 240 / 480-□)

## Dimensions

- Unit: mm, For the detailed drawings, follow the Autonics website.

### ■ SPB-A015-□

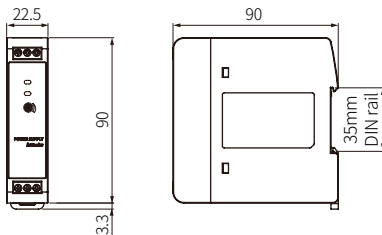

### ■ SPB-A030 / 060-□

- This is based on SPB-A060 model.

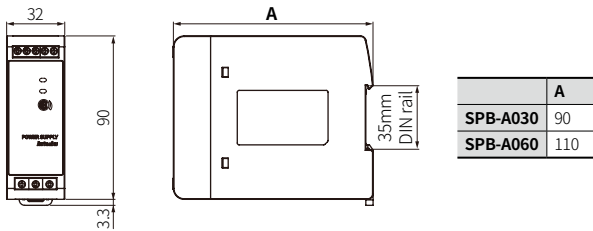

### ■ SPB-A120 / 240-□

- This is based on SPB-A120 model.

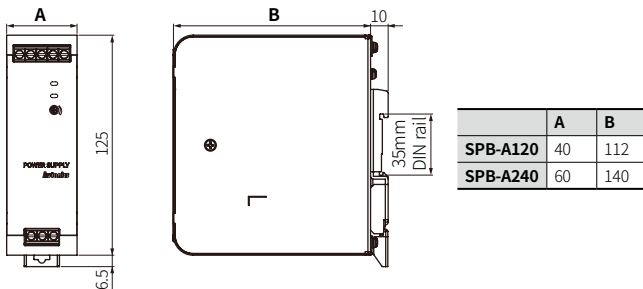

### ■ SPB-A480-□

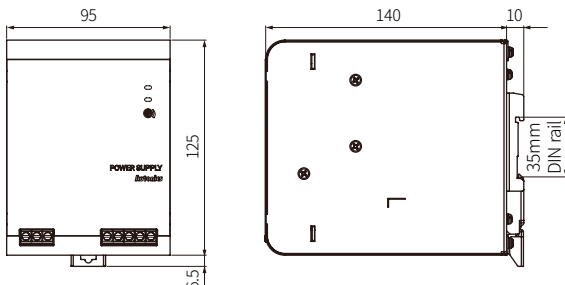

## Unit Descriptions



### 1. Output indicator (DC OK, green)

- Turns ON during normal operation after power input.
- Flashes when overcurrent protection function operates.

### 2. Output low voltage indicator (DC Low, red)

- Turns ON when output voltage is lower than reference value.

Output voltage [VDC=]	5	12	24	48
Output low voltage indicate [VDC=]	4.2 (± 10%)	9.6 (± 10%)	20.0 (± 10%)	43.0 (± 10%)

### 3. Output voltage adjuster (V.Adjust)

- Adjust this volume within voltage variable range. It is not guaranteed when using outside the variable range.

## Connection

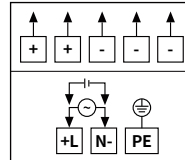

Mark	Function
+	Output power (+)
-	Output power (-)
+L, N-	Input power
⊕	Protective Earth (PE)

Model	Wire specification			Terminal	Torque
	Output	Input	PE		
SPB-A015-05 <sup>01)</sup>	AWG 20 to 12				0.3 to 0.5 N m
SPB-A015-12 <sup>01)</sup>	AWG 22 to 12	AWG 24 to 12		M2.5	
SPB-A015-24 <sup>01)</sup>	AWG 24 to 12				
SPB-A030-05	AWG 18 to 12				
SPB-A030-12	AWG 20 to 12	AWG 24 to 12	AWG 14 to 12	M2.5	
SPB-A030-24	AWG 22 to 12				
SPB-A060-12	AWG 18 to 12				
SPB-A060-24	AWG 20 to 12	AWG 22 to 12			
SPB-A120-12	AWG 14 to 10				
SPB-A120-24	AWG 18 to 10	AWG 22 to 10			
SPB-A240-12	AWG 12 to 10				
SPB-A240-24	AWG 14 to 10	AWG 20 to 10	AWG 14 to 10	M3	
SPB-A240-48	AWG 18 to 10				
SPB-A480-24	AWG 12 to 10				
SPB-A480-48	AWG 14 to 10	AWG 16 to 10			

01) There are one + terminal and two - terminals.  
The rated current is 10 A per output terminal. If the rated current is exceeded, use multiple terminals at the same time.

## Mounting

- It can be mounted on a 35 mm DIN rail conforming to EN 60715 standards.
- Depending on the installation environment, screw installation is available using the bracket (sold separately).

### ■ Mounting with DIN Rail

Put the product on DIN rail and press it to the direction ①.

### ■ Removing with DIN Rail

Push the latch to the direction ① with a tool and pull the bottom of the device in the direction ②. Left it in direction ③.

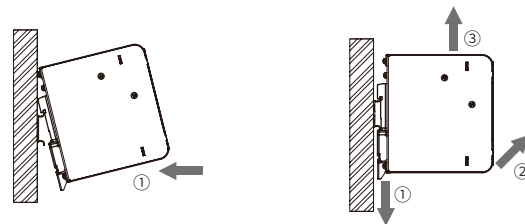

## Cautions during Installation

### High Temperature Caution

While supplying power to the load or right after turning off the power of the load, do not touch the body. Failure to follow this instruction may result in a burn due to the high temperature.

### ■ Mount space

- When installing adjacently to multiple SMPS or heating devices, keep space between power controllers for heat radiation.  
Horizontal: ≥ 20 mm,  
Vertical: ≥ 40 mm

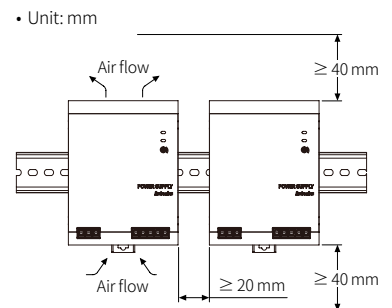

## Specifications

<b>Indicator</b>	Output indicator (green), output low voltage indicator (red)
<b>Over-current protection</b>	≥ 121 %
<b>Over-voltage protection</b> <sup>(01)</sup>	≈ 130 %
<b>Output short-circuit protection</b>	Built-in
<b>Overheat protection</b>	Built-in
<b>Parallel operation</b> <sup>(02)</sup>	Available
<b>Insulation resistance</b>	Among all input terminals, all output terminals and PE : ≥ 100 MΩ (500 VDC= megger)
<b>Dielectric strength</b>	Among all input terminals and all output terminals: 3 kVAC~, Cutoff current = 20 mA Among all input terminals and PE: 2 kVAC~, Cutoff current = 20 mA Among all output terminals and PE: 1 kVAC~, Cutoff current = 20 mA
<b>Vibration</b> <sup>(03)</sup>	10 to 55 Hz, 0.75 mm double amplitude, in each X, Y, Z direction for 2 hours
<b>Shock</b>	150 m/s <sup>2</sup> (≈ 15 G) in each X, Y, Z direction for 3 times
<b>EMS</b>	Conforms to EN61000-6-2
<b>EMI</b>	Conforms to EN61000-6-4
<b>Ambient temperature</b> <sup>(04)</sup>	-20 to 70 °C, storage: -25 to 80 °C (no freezing or condensation)
<b>Ambient humidity</b>	20 to 90 %RH, storage: 20 to 90 %RH (no freezing or condensation)
<b>Life expectancy</b> <sup>(05)</sup>	10 years
<b>Protection structure</b>	IP20 (IEC standard)
<b>Certification</b> <sup>(06)</sup>	CE, RoHS, REACH, etc.

- 01) To reset the overvoltage protection, shut off input power for at least 5 minutes and then restart.  
 02) For more information, refer the product manuals.  
 03) Applies when the device is installed vertically to the ground. For non-vertical installation, secure the product to withstand vibration and shock.  
 04) UL approved ambient temperature 40 °C, refer to the 'Derating Curve'.  
 05) If complying with the followings, the rated voltage input, ambient temperature ≤ 40 °C, average load factor ≤ 50 %, 'Mounting' and 'Cautions during Installation'.  
 06) It is for 100 - 240 VAC~ / VDC= power input only.

Model	SPB-A015-05	SPB-A015-12	SPB-A015-24	SPB-A030-05	SPB-A030-12	SPB-A030-24
<b>Input</b>	100 - 240 VAC~ / 90 - 350 VDC= (allowable voltage: 85 - 264 VAC~)					
Current <sup>(02)</sup> (Typical)	115 VAC~ 0.32 A	230 VAC~ 0.21 A	0.29 A	0.31 A	0.54 A	0.57 A
Frequency	50 / 60 Hz (allowable frequency: 47 - 63 Hz)					
Efficiency <sup>(02)</sup> (Typical)	115 VAC~ 0.72	230 VAC~ 0.70	0.78	0.74	0.75	0.73
Power factor <sup>(02)</sup> (Typical)	115 VAC~ 0.56	230 VAC~ 0.44	0.56	0.47	0.57	0.45
Power factor correction circuit (PFC)	Not available					
Inrush current <sup>(03)</sup> (Typical)	115 VAC~ 16 A	230 VAC~ 32 A				
Leakage current (Typical)	115 VAC~ 0.21 mA	230 VAC~ 0.28 mA	0.16 mA		0.25 mA	
<b>Output</b>	5 VDC=, 12 VDC=, 24 VDC=, 5 VDC=, 12 VDC=, 24 VDC=					
Current	3 A	1.2 A	0.65 A	5 A	2.5 A	1.3 A
Power	15 W	14.4 W	15.6 W	25 W	30 W	31.2 W
Power boost <sup>(04)</sup>	120 % of rated current					
Voltage adjustment range	-10 to 15 % (with VAdjust)					
Ripple <sup>(02,05)</sup>	260 mV <sub>p-p</sub>	150 mV <sub>p-p</sub>	170 mV <sub>p-p</sub>	120 mV <sub>p-p</sub>	120 mV <sub>p-p</sub>	150 mV <sub>p-p</sub>
Input variation <sup>(06)</sup>	≤ 0.5 %					
Load variation <sup>(07)</sup>	≤ 3.0 %	≤ 2.0 %	≤ 1.5 %	≤ 3.0 %	≤ 2.0 %	≤ 1.5 %
Temperature variation	≤ 0.05 % / °C					
Start-up time <sup>(02)</sup> (Typical)	115 VAC~ 720 ms	230 VAC~ 330 ms	810 ms	820 ms	580 ms	650 ms
Hold time <sup>(02)</sup> (Typical)	115 VAC~ 32 ms	230 VAC~ 136 ms	33 ms	33 ms	33 ms	29 ms
Output low voltage indicate	4.2 V (± 10 %)	9.6 V (± 10 %)	20.0 V (± 10 %)	4.2 V (± 10 %)	9.6 V (± 10 %)	20.0 V (± 10 %)
Unit weight (Package)	≈ 135 g (≈ 230 g)		≈ 170 g (≈ 265 g)			

Model	SPB-A060-12	SPB-A060-24	SPB-A120-12	SPB-A120-24
<b>Input</b>	100 - 240 VAC~ / 90 - 350 VDC= (allowable voltage: 85 - 264 VAC~)			
Current <sup>(02)</sup> (Typical)	115 VAC~ 1.05 A	230 VAC~ 0.6 A	1.1 A	1.3 A
Frequency	50 / 60 Hz (allowable frequency: 47 - 63 Hz)			
Efficiency <sup>(02)</sup> (Typical)	115 VAC~ 0.81	230 VAC~ 0.82	0.85	0.87
Power factor <sup>(02)</sup> (Typical)	115 VAC~ 0.54	230 VAC~ 0.46	0.54	0.46
Power factor correction circuit (PFC)	Not available			
Inrush current <sup>(03)</sup> (Typical)	115 VAC~ 16 A	230 VAC~ 32 A		
Leakage current (Typical)	115 VAC~ 0.16 mA	230 VAC~ 0.3 mA	0.3 mA	
<b>Output</b>	12 VDC=, 24 VDC=, 12 VDC=, 24 VDC=			
Current	4.5 A	2.5 A	10 A	5 A
Power	54 W	60 W	120 W	
Power boost <sup>(04)</sup>	120 % of rated current			
Voltage adjustment range	-10 to 15 % (with VAdjust)			
Ripple <sup>(02,05)</sup>	460 mV <sub>p-p</sub>	110 mV <sub>p-p</sub>	470 mV <sub>p-p</sub>	310 mV <sub>p-p</sub>
Input variation <sup>(06)</sup>	≤ 0.5 %			
Load variation <sup>(07)</sup>	≤ 2.0 %	≤ 1.5 %	≤ 2.0 %	≤ 1.5 %
Temperature variation	≤ 0.05 % / °C			
Start-up time <sup>(02)</sup> (Typical)	115 VAC~ 635 ms	230 VAC~ 655 ms	830 ms	740 ms
Hold time <sup>(02)</sup> (Typical)	115 VAC~ 23 ms	230 VAC~ 106 ms	22 ms	32 ms
Output low voltage indicate	9.6 V (± 10 %)	20.0 V (± 10 %)	9.6 V (± 10 %)	20.0 V (± 10 %)
Unit weight (Package)	≈ 230 g (≈ 325 g)		≈ 565 g (≈ 725 g)	

Model	SPB-A240-12	SPB-A240-24	SPB-A240-48	SPB-A480-24	SPB-A480-48
<b>Input</b>	100 - 240 VAC~ / 90 - 350 VDC= (allowable voltage: 85 - 264 VAC~)				
Current <sup>(02)</sup> (Typical)	115 VAC~ 2.5 A	230 VAC~ 1.3 A	0.89		0.90
Frequency	50 / 60 Hz (allowable frequency: 47 - 63 Hz)				
Efficiency <sup>(02)</sup> (Typical)	115 VAC~ 0.86	230 VAC~ 0.89	0.89	0.90	0.88
Power factor <sup>(02)</sup> (Typical)	115 VAC~ 0.99	230 VAC~ 0.9	0.92		0.91
Power factor correction circuit (PFC)	Available				
Inrush current <sup>(03)</sup> (Typical)	115 VAC~ 16 A	230 VAC~ 32 A	40 A		55 A
Leakage current (Typical)	115 VAC~ 0.14 mA	230 VAC~ 0.25 mA	0.13 mA		0.24 mA
<b>Output</b>	12 VDC=, 24 VDC=, 48 VDC=, 24 VDC=, 48 VDC=				
Current	20 A	10 A	5 A	20 A	10 A
Power	240 W				
Power boost <sup>(04)</sup>	120 % of rated current				
Voltage adjustment range	-10 to 15 % (with VAdjust)				
Ripple <sup>(02,05)</sup>	430 mV <sub>p-p</sub>	300 mV <sub>p-p</sub>	360 mV <sub>p-p</sub>	270 mV <sub>p-p</sub>	320 mV <sub>p-p</sub>
Input variation <sup>(06)</sup>	≤ 0.5 %				
Load variation <sup>(07)</sup>	≤ 2.0 %	≤ 1.5 %	≤ 1.5 %		≤ 1.5 %
Temperature variation	≤ 0.05 % / °C				
Start-up time <sup>(02)</sup> (Typical)	115 VAC~ 290 ms	230 VAC~ 250 ms	310 ms	290 ms	290 ms
Hold time <sup>(02)</sup> (Typical)	115 VAC~ 36 ms	230 VAC~ 39 ms	40 ms	36 ms	31 ms
Output low voltage indicate	9.6 V (± 10 %)	20.0 V (± 10 %)	20.0 V (± 10 %)	43.0 V (± 10 %)	43.0 V (± 10 %)
Unit weight (Package)	≈ 850 g (≈ 1,050 g)				≈ 1,350 g (≈ 1,570 g)

- 01) For DC voltage input, install a external fuse to ensure safety.

Model	Fuse specification
SPB-A015 / 030-□	≥ 350 VDC=, 4 A
SPB-A060 / 120-□	≥ 350 VDC=, 6 A
SPB-A240 / 480-□	≥ 350 VDC=, 12 A

- 02) Based on 100 % load  
 03) When cold start operation at 25 °C.  
 04) For more information, refer the product manuals.  
 05) Based on 20 MHz (Typ).  
 Data measured by connecting capacitors of 22 μF (Aluminum electrolytic capacitor) and 0.1 μF (Film capacitor) to 150 mm from the output terminal. Ripple specifications change when operating in Burst mode.  
 06) Based on 85 - 264 VAC~ input, 100 % load  
 07) Based on 0 to 100 % load

## Derating Curve

- Based on AC voltage input.
- The product may be damaged if used at a higher load factor than the rated load factor by the ambient temperature and the AC input voltage.

### Derating curve by ambient temperature

- SPB-A015 / 030 / 060 / 240-□

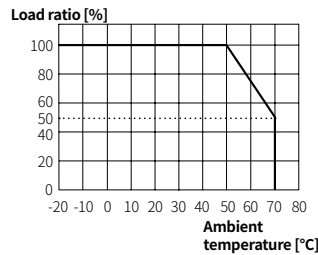

- SPB-A120 / 480-□

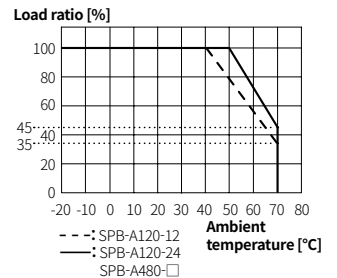

- In case of DC voltage input, The load factor is calculated by multiplying the load factor by the following coefficient when AC voltage is input.

Model	Coefficient	Example (70 °C)
SPB-A015-□	1.0	50 % × 1.0
SPB-A030	0.9	50 % × 0.9
SPB-A060-□	0.8	50 % × 0.8

Model	Coefficient	Example (70 °C)
SPB-A120-12	0.9	35 % × 0.9
SPB-A120-24	0.9	45 % × 0.9
SPB-A480-□	0.8	45 % × 0.8

### Derating curve by input voltage

- SPB-A015 / 030 / 060 / 120 / 240-□

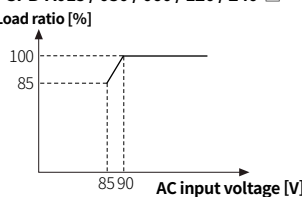

When the input voltage is 90 VAC~ or less, the load ratio is reduced to 3 % / V.

- SPB-A480-□

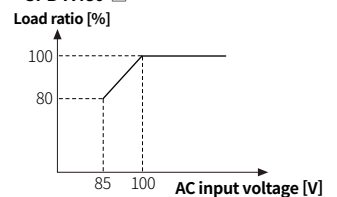

When the input voltage is 100 VAC~ or less, the load ratio is reduced to 1.34 % / V.

## Sold Separately: Bracket

• Unit: mm, For the detailed drawings, follow the Autonics website.

### ■ BK-SPB-F01 (SPB-A015 / 030 / 060-□)

• Fix the bracket to the wall with Ø 4.5 mm screw.

The device and bracket are fixed in the same way as the DIN rail installation.

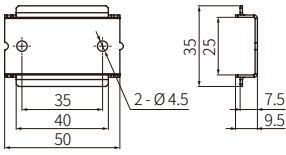
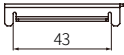

### ■ BK-SPB-F02 (SPB-A120 / 240 / 480-□)

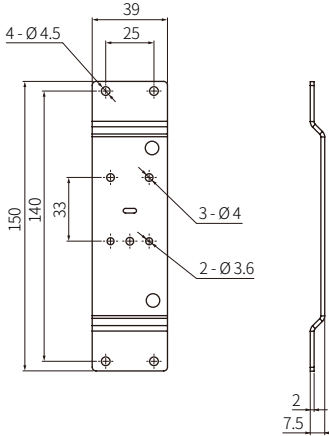

## Block Diagram

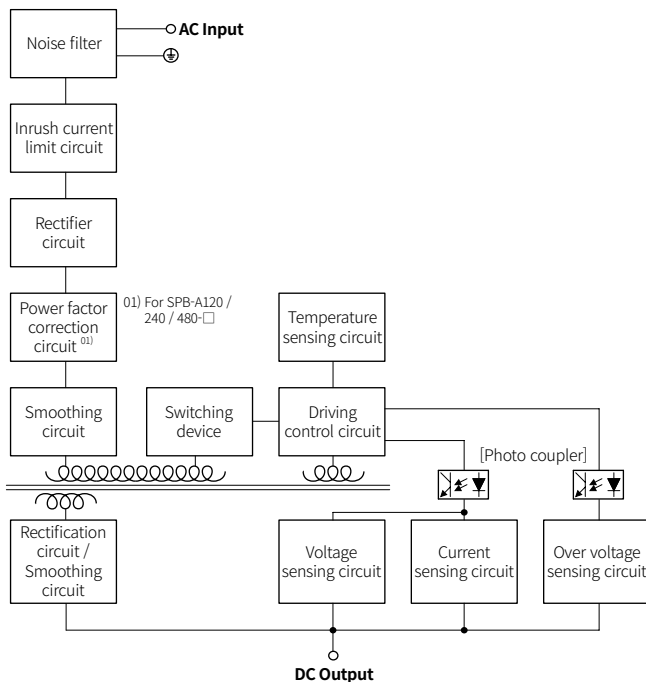

## Feature Data of Over-voltage Protection

If excessive voltage of about 130% or more of the rated voltage is output, the output is cut off to protect the connected load.

When the output is disconnected, apply the power after waiting at least 5 minutes.

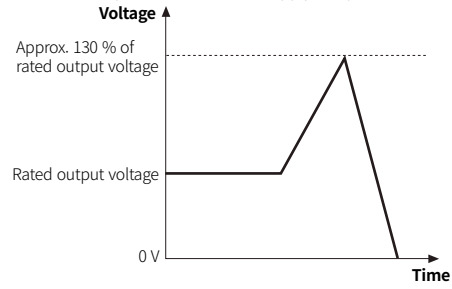

## Feature Data of Over-current Protection

When the overcurrent exceeding 121% of the rated current is flowed, the over-current protection circuit is operated to protect the product by reducing output voltage. The protection circuit is released automatically when the load current is under the rated current.

• It is for the rated input voltage 100 - 240 VAC~.

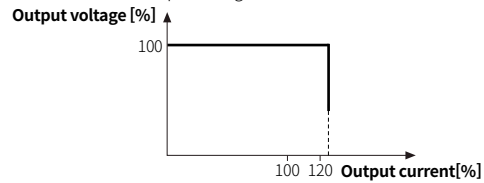

## Overheat Protection

The output voltage is cut off when the device's internal temperature reaches approximately 140 °C due to overheating.

If the product does not operate normally due to the overheat protection function, cool the product sufficiently and reapply the power.

## Power Boost

If the environment that satisfies the conditions below, current greater than the rated current is temporarily and repeatedly output.

Adjust the load of the boost load current according to the ambient temperature and installation conditions.

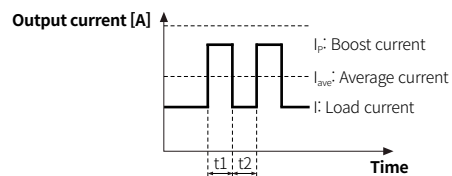

Condition	Description
$t1 \leq 10 \text{ sec}$	The boost current should not last more than 10 seconds.
$\text{Duty} = \frac{t1}{t1 + t2} \times 100 \% \leq 30 \%$	The duty cycle must not exceed the boost current condition.
$I_p \leq \text{Rated boost current}$	The boost current must not exceed the rated boost current.
$I_{\text{ave}} \leq \text{Rated current}$	The average current in one cycle of boost current must not exceed the rated current.

01) Rated boost current = 120% of the rated current

## Inrush Current

Inrush current is the current that flows instantaneously when the power supply voltage is input.

A thermistor is used in the inrush current limiting circuit.

When the power is repeatedly turned on and off, use it at a sufficient interval so that the heat of the SMPS can be cooled down.

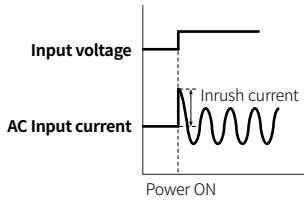

## Start-up / Hold Time

- Start-up time: Time taken to reach 90 % of the rated voltage
- Hold time: Time to keep the output above 96.5 % after power input is stopped

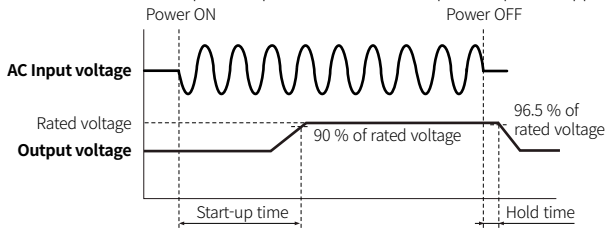

## Serial / Parallel Operation

### Serial operation

During serial operation, the output current must be lower than the rated current of the SMPS with the lowest rated current among serial connected SMPS.



### Parallel operation

The same model must be used for parallel operation. Up to 2 SMPS can be used.

In parallel operation, keep the difference between the output voltages of the two SMPS within 25 mVDC.

In parallel operation, EMI, inrush current, etc. are not the same as product specifications.

In order to balance the current, the length and thickness of the wiring connected between the SMPS and the load must be the same.

