

Technical Information

Proline Cubemass C 100

Coriolis flowmeter



Ultra compact for smallest quantities and an ultra-compact transmitter

Application

- Measuring principle operates independently of physical fluid properties such as viscosity or density
- Accurate measurement of smallest quantities of liquids and gases; ideal for skid integration

Device properties

- Nominal diameter: DN 1 to 6 ($\frac{1}{24}$ to $\frac{1}{4}$ ")
- Process pressure up to 400 bar (5 800 psi)
- Medium temperature up to +205 °C (+401 °F)
- Robust, ultra-compact transmitter housing
- Highest degree of protection: IP69K
- Pre-configured plug connector

Your benefits

- Reduced Installation cost – compact single-tube design
- Fewer process measuring points – multivariable measurement (flow, density, temperature)
- Space-saving installation – no inlet/outlet run needs
- Space-saving transmitter – full functionality on smallest footprint
- Time-saving local operation without additional software and hardware – integrated web server
- Integrated verification – Heartbeat Technology™

Table of contents







Document information	4	Degree of protection	45
Symbols used	4	Vibration resistance	45
Function and system design	5	Shock resistance	45
Measuring principle	5	Shock resistance	45
Measuring system	5	Interior cleaning	45
Equipment architecture	7	Electromagnetic compatibility (EMC)	45
Safety	7	Process	46
Input	8	Medium temperature range	46
Measured variable	8	Density	46
Measuring range	8	Pressure-temperature ratings	46
Operable flow range	8	Secondary containment pressure rating	47
Input signal	9	Rupture disk	48
Output	9	Flow limit	48
Output signal	9	Pressure loss	48
Signal on alarm	11	System pressure	48
Ex connection data	12	Thermal insulation	49
Low flow cut off	13	Heating	49
Galvanic isolation	13	Vibrations	50
Protocol-specific data	13	Mechanical construction	51
Power supply	19	Dimensions in SI units	51
Terminal assignment	19	Dimensions in US units	57
Pin assignment, device plug	25	Weight	63
Supply voltage	27	Materials	63
Power consumption	27	Process connections	65
Current consumption	28	Surface roughness	65
Power supply failure	28	Operability	65
Electrical connection	29	Operating concept	65
Potential equalization	33	Local display	66
Terminals	33	Remote operation	66
Cable entries	34	Service interface	67
Cable specification	34	Certificates and approvals	69
Performance characteristics	35	CE mark	69
Reference operating conditions	35	C-Tick symbol	69
Maximum measured error	35	Ex approval	70
Repeatability	37	HART certification	70
Response time	37	Certification PROFIBUS	70
Influence of ambient temperature	37	EtherNet/IP certification	70
Influence of medium temperature	37	Modbus RS485 certification	70
Influence of medium pressure	38	Other standards and guidelines	71
Design fundamentals	38	Ordering information	71
Installation	39	Application packages	71
Mounting location	39	Heartbeat Technology	72
Orientation	40	Concentration	72
Inlet and outlet runs	40	Accessories	72
Special mounting instructions	41	Communication-specific accessories	72
Mounting Safety Barrier Promass 100	42	Service-specific accessories	73
Environment	43	System components	74
Ambient temperature range	43		
Storage temperature	45		
Climate class	45		

Supplementary documentation	74
Standard documentation	74
Supplementary device-dependent documentation	74
Registered trademarks	75









Document information

Symbols used





Electrical symbols

Symbol	Meaning	Symbol	Meaning
	Direct current		Alternating current
	Direct current and alternating current		Ground connection A grounded terminal which, as far as the operator is concerned, is grounded via a grounding system.
	Protective ground connection A terminal which must be connected to ground prior to establishing any other connections.		Equipotential connection A connection that has to be connected to the plant grounding system: This may be a potential equalization line or a star grounding system depending on national or company codes of practice.

Symbols for certain types of information

Symbol	Meaning
	Permitted Procedures, processes or actions that are permitted.
	Preferred Procedures, processes or actions that are preferred.
	Forbidden Procedures, processes or actions that are forbidden.
	Tip Indicates additional information.
	Reference to documentation
	Reference to page
	Reference to graphic
	Visual inspection

Symbols in graphics

Symbol	Meaning	Symbol	Meaning
1, 2, 3,...	Item numbers		Series of steps
A, B, C, ...	Views	A-A, B-B, C-C, ...	Sections
	Hazardous area		Safe area (non-hazardous area)
	Flow direction		

Function and system design

Measuring principle

The measuring principle is based on the controlled generation of Coriolis forces. These forces are always present in a system when both translational and rotational movements are superimposed.

$$F_c = 2 \cdot \Delta m (v \cdot \omega)$$

F_c = Coriolis force

Δm = moving mass

ω = rotational velocity

v = radial velocity in rotating or oscillating system

The amplitude of the Coriolis force depends on the moving mass Δm , its velocity v in the system and thus on the mass flow. Instead of a constant rotational velocity ω , the sensor uses oscillation.

In the sensor, an oscillation is produced in the measuring tube. The Coriolis forces produced at the measuring tube loop cause a phase shift in the tube oscillations (see illustration):

- If there is zero flow (i.e. when the fluid stands still), the oscillation measured at points A and B has the same phase (no phase difference).
- Mass flow causes deceleration of the oscillation at the inlet of the tubes (2) and acceleration at the outlet (3).

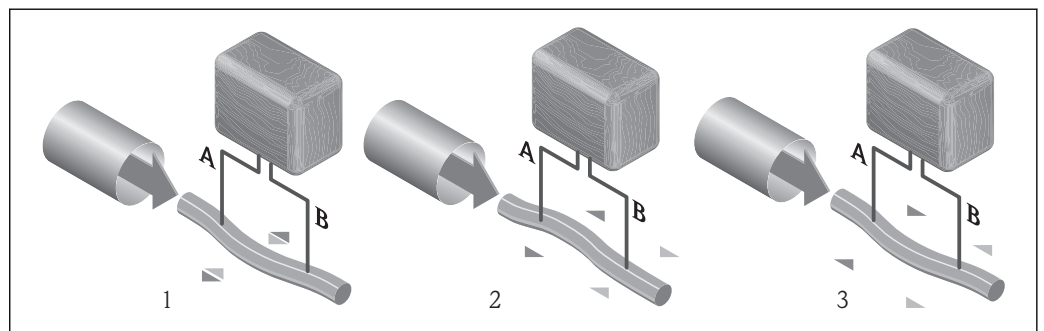

A0016772

The phase difference (A-B) increases with increasing mass flow. Electrodynamical sensors register the tube oscillations at the inlet and outlet. System balance is created by exciting an eccentrically arranged swinging mass to antiphase oscillation. The measuring principle operates independently of temperature, pressure, viscosity, conductivity and flow profile.

Density measurement

The measuring tube is continuously excited at its resonance frequency. A change in the mass and thus the density of the oscillating system (comprising measuring tube and fluid) results in a corresponding, automatic adjustment in the oscillation frequency. Resonance frequency is thus a function of medium density. The microprocessor utilizes this relationship to obtain a density signal.

Volume measurement

Together with the measured mass flow, this is used to calculate the volume flow.

Temperature measurement

The temperature of the measuring tube is determined in order to calculate the compensation factor due to temperature effects. This signal corresponds to the process temperature and is also available as an output signal.

Measuring system

The device consists of a transmitter and a sensor. If a device with Modbus RS485 intrinsically safe is ordered, the Safety Barrier Promass 100 is part of the scope of supply and must be implemented to operate the device.

The device is available as a compact version:

The transmitter and sensor form a mechanical unit.

Transmitter

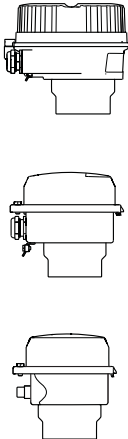
<p>Cubemass 100</p>  <p>A0016693</p> <p>A0016694</p> <p>A0016695</p>	<p>Device versions and materials:</p> <ul style="list-style-type: none"> ■ Compact, aluminum coated: Aluminum, AlSi10Mg, coated ■ Compact, hygienic, stainless: Hygienic version, stainless steel 1.4301 (304) ■ Ultra-compact, hygienic, stainless: Hygienic version, stainless steel 1.4301 (304) <p>Configuration:</p> <ul style="list-style-type: none"> ■ Via operating tools (e.g. FieldCare) ■ Additionally for device version with local display: Via Web browser (e.g. Microsoft Internet Explorer) ■ Also for device version with 4-20 mA HART, pulse/frequency/switch output: Via Web browser (e.g. Microsoft Internet Explorer) ■ Also for device version with EtherNet/IP output: <ul style="list-style-type: none"> - Via Web browser (e.g. Microsoft Internet Explorer) - Via Add-on Profile Level 3 for automation system from Rockwell Automation - Via Electronic Data Sheet (EDS)
--	---

Sensor

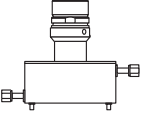
<p>Cubemass C</p>  <p>A0019546</p>	<p>The ultra compact single-tube system for minimum flow rates and high pressure</p> <ul style="list-style-type: none"> ■ Simultaneous measurement of flow, volume flow, density and temperature (multivariable) ■ Immune to process influences ■ Nominal diameter range: DN 1 to 6 ($\frac{1}{24}$ to $\frac{1}{4}$") ■ Materials: <ul style="list-style-type: none"> - Sensor: stainless steel, 1.4301 (304) - Measuring tube: stainless steel, 1.4539 (904L) - Process connections: stainless steel, 1.4404 (316/316L); 1.4539 (904L)
---	---

Safety Barrier Promass 100

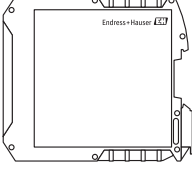
 <p>A0016763</p>	<ul style="list-style-type: none"> ■ Dual-channel safety barrier for installation in non-hazardous locations or zone 2/div. 2: <ul style="list-style-type: none"> - Channel 1: DC 24 V power supply - Channel 2: Modbus RS485 ■ In addition to current, voltage and power limitation, it offers galvanic isolation of circuits for explosion protection. ■ Easy top-hat rail mounting (DIN 35 mm) for installation in control cabinets
---	--

Equipment architecture

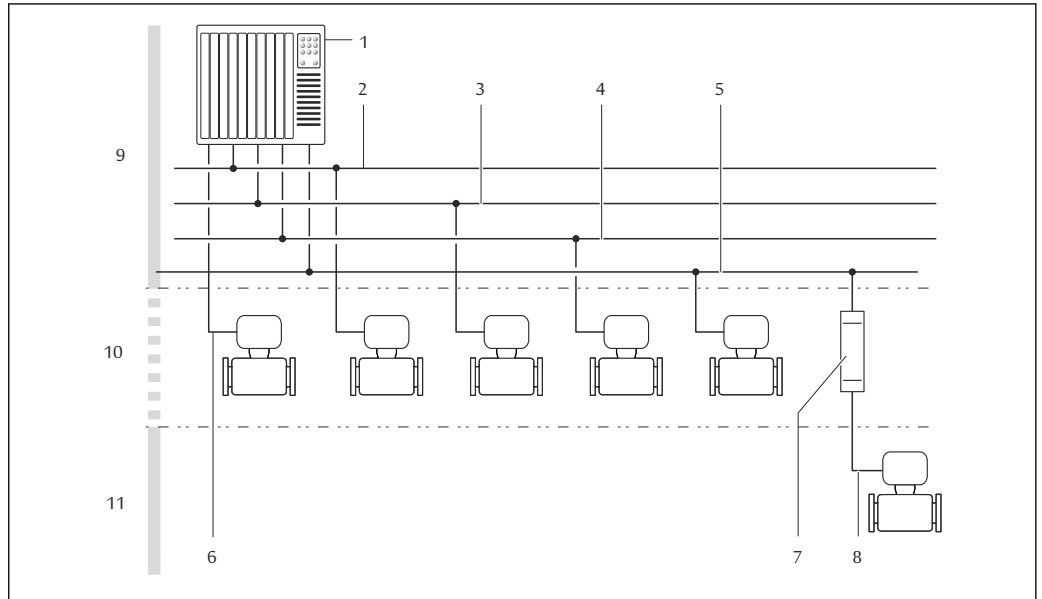

A0016779

1 Possibilities for integrating measuring devices into a system

- 1 Automation system (e.g. PLC)
- 2 EtherNet/IP
- 3 PROFIBUS DP
- 4 Modbus RS485
- 5 4-20 mA HART, pulse/frequency/switch output
- 6 Safety Barrier Promass 100
- 7 Modbus RS485 intrinsically safe
- 8 Non-hazardous area
- 9 Non-hazardous area and Zone 2/Div. 2
- 10 Intrinsically safe area and Zone 1/Div. 1

Safety

IT security

We only provide a warranty if the device is installed and used as described in the Operating Instructions. The device is equipped with security mechanisms to protect it against any inadvertent changes to the device settings.

IT security measures in line with operators' security standards and designed to provide additional protection for the device and device data transfer must be implemented by the operators themselves.

Input

Measured variable

Direct measured variables

- Mass flow
- Density
- Temperature

Calculated measured variables

- Volume flow
- Corrected volume flow
- Reference density

Measuring range

Measuring ranges for liquids

DN		Measuring range full scale values $\dot{m}_{\min(F)}$ to $\dot{m}_{\max(F)}$	
[mm]	[in]	[kg/h]	[lb/min]
1	$\frac{1}{24}$	0 to 20	0 to 0.735
2	$\frac{1}{12}$	0 to 100	0 to 3.675
4	$\frac{1}{8}$	0 to 450	0 to 16.54
6	$\frac{1}{4}$	0 to 1000	0 to 36.75



Measuring ranges for gases

The full scale values depend on the density of the gas and can be calculated with the formula below:

$$\dot{m}_{\max(G)} = \dot{m}_{\max(F)} \cdot \rho_G \cdot X$$

$\dot{m}_{\max(G)}$	Maximum full scale value for gas [kg/h]
$\dot{m}_{\max(F)}$	Maximum full scale value for liquid [kg/h]
$\dot{m}_{\max(G)} < \dot{m}_{\max(F)}$	$\dot{m}_{\max(G)}$ can never be greater than $\dot{m}_{\max(F)}$
ρ_G	Gas density in [kg/m ³] at operating conditions

DN		x
[mm]	[in]	[kg/m ³]
1	$\frac{1}{24}$	32
2	$\frac{1}{12}$	32
4	$\frac{1}{8}$	32
6	$\frac{1}{4}$	32

 To calculate the measuring range, use the *Applicator* sizing tool →  73

Recommended measuring range

"Flow limit" section →  48

Operable flow range

Over 1000 : 1.

Flow rates above the preset full scale value are not overridden by the electronics unit, with the result that the totalizer values are registered correctly.

Input signal

External measured values

To increase the accuracy of certain measured variables or to calculate the corrected volume flow for gases, the automation system can continuously write different measured values to the measuring device:

- Operating pressure to increase accuracy (Endress+Hauser recommends the use of a pressure measuring device for absolute pressure, e.g. Cerabar M or Cerabar S)
- Medium temperature to increase accuracy (e.g. iTEMP)
- Reference density for calculating the corrected volume flow for gases

 Various pressure transmitters and temperature measuring devices can be ordered from Endress +Hauser: see "Accessories" section →  74

It is recommended to read in external measured values to calculate the following measured variables:

- Mass flow
- Corrected volume flow

HART protocol

The measured values are written from the automation system to the measuring device via the HART protocol. The pressure transmitter must support the following protocol-specific functions:

- HART protocol
- Burst mode

Digital communication

The measured values can be written from the automation system to the measuring via:

- PROFIBUS DP
- Modbus RS485
- EtherNet/IP

Output



Output signal

Current output

Current output	4-20 mA HART (active)
Maximum output values	<ul style="list-style-type: none"> ▪ DC 24 V (no flow) ▪ 22.5 mA
Load	0 to 700 Ω
Resolution	0.38 µA
Damping	Adjustable: 0.07 to 999 s
Assignable measured variables	<ul style="list-style-type: none"> ▪ Mass flow ▪ Volume flow ▪ Corrected volume flow ▪ Density ▪ Reference density ▪ Temperature <p> The range of options increases if the measuring device has one or more application packages.</p>

Pulse/frequency/switch output

Function	Can be set to pulse, frequency or switch output
Version	Passive, open collector
Maximum input values	<ul style="list-style-type: none"> ▪ DC 30 V ▪ 25 mA
Voltage drop	For 25 mA: ≤ DC 2 V
Pulse output	

Pulse width	Adjustable: 0.05 to 2 000 ms
Maximum pulse rate	10 000 Impulse/s
Pulse value	Adjustable
Assignable measured variables	<ul style="list-style-type: none"> ▪ Mass flow ▪ Volume flow ▪ Corrected volume flow
Frequency output	
Output frequency	Adjustable: 0 to 10 000 Hz
Damping	Adjustable: 0 to 999 s
Pulse/pause ratio	1:1
Assignable measured variables	<ul style="list-style-type: none"> ▪ Mass flow ▪ Volume flow ▪ Corrected volume flow ▪ Density ▪ Reference density ▪ Temperature <p> The range of options increases if the measuring device has one or more application packages.</p>
Switch output	
Switching behavior	Binary, conductive or non-conductive
Switching delay	Adjustable: 0 to 100 s
Number of switching cycles	Unlimited
Assignable functions	<ul style="list-style-type: none"> ▪ Off ▪ On ▪ Diagnostic behavior ▪ Limit value <ul style="list-style-type: none"> - Mass flow - Volume flow - Corrected volume flow - Density - Reference density - Temperature - Totalizer 1-3 ▪ Flow direction monitoring ▪ Status <ul style="list-style-type: none"> - Partially filled pipe detection - Low flow cut off <p> The range of options increases if the measuring device has one or more application packages.</p>

PROFIBUS DP

Signal encoding	NRZ code
Data transfer	9.6 kBaud...12 MBaud

Modbus RS485

Physical interface	In accordance with EIA/TIA-485-A standard
Terminating resistor	<ul style="list-style-type: none"> ▪ For device version used in non-hazardous areas or Zone 2/Div. 2: integrated and can be activated via DIP switches on the transmitter electronics module ▪ For device version used in intrinsically safe areas: integrated and can be activated via DIP switches on the Safety Barrier Promass 100

EtherNet/IP

Standards	In accordance with IEEE 802.3
------------------	-------------------------------

Signal on alarm

Depending on the interface, failure information is displayed as follows:

Current output

4-20 mA

Failure mode	Choose from: <ul style="list-style-type: none"> ▪ 4 to 20 mA in accordance with NAMUR recommendation NE 43 ▪ 4 to 20 mA in accordance with US ▪ Min. value: 3.59 mA ▪ Max. value: 22.5 mA ▪ Freely definable value between: 3.59 to 22.5 mA ▪ Actual value ▪ Last valid value
---------------------	--

HART

Device diagnostics	Device condition can be read out via HART Command 48
---------------------------	--

Pulse/frequency/switch output

Pulse output	
Failure mode	Choose from: <ul style="list-style-type: none"> ▪ Actual value ▪ No pulses
Frequency output	
Failure mode	Choose from: <ul style="list-style-type: none"> ▪ Actual value ▪ 0 Hz ▪ Defined value: 0 to 12 500 Hz
Switch output	
Failure mode	Choose from: <ul style="list-style-type: none"> ▪ Current status ▪ Open ▪ Closed

PROFIBUS DP

Status and alarm messages	Diagnostics in accordance with PROFIBUS PA Profile 3.02
----------------------------------	---

Modbus RS485

Failure mode	Choose from: <ul style="list-style-type: none"> ▪ NaN value instead of current value ▪ Last valid value
---------------------	---

EtherNet/IP

Device diagnostics	Device condition can be read out in Input Assembly
---------------------------	--

Local display



Plain text display	With information on cause and remedial measures
Backlight	Red backlighting indicates a device error.

 Status signal as per NAMUR recommendation NE 107

Operating tool

- Via digital communication:
 - HART protocol
 - PROFIBUS DP
 - Modbus RS485
 - EtherNet/IP
- Via service interface
- Via Web server

Plain text display	With information on cause and remedial measures
---------------------------	---

 Additional information on remote operation →  66

Web browser

Plain text display	With information on cause and remedial measures
---------------------------	---

Light emitting diodes (LED)

Status information	Status indicated by various light emitting diodes The following information is displayed depending on the device version: <ul style="list-style-type: none"> ▪ Supply voltage active ▪ Data transmission active ▪ Device alarm/error has occurred ▪ EtherNet/IP network available ▪ EtherNet/IP connection established
---------------------------	--

Ex connection data

These values only apply for the following device version:
 Order code for "Output", option M "Modbus RS485", for use in intrinsically safe areas

Safety Barrier Promass 100*Safety-related values*

Terminal numbers			
Supply voltage		Signal transmission	
2 (L-)	1 (L+)	26 (A)	27 (B)
$U_{nom} = DC\ 24\ V$ $U_{max} = AC\ 260\ V$		$U_{nom} = DC\ 5\ V$ $U_{max} = AC\ 260\ V$	

Intrinsically safe values

Terminal numbers			
Supply voltage		Signal transmission	
20 (L-)	10 (L+)	62 (A)	72 (B)
$U_o = 16.24 \text{ V}$ $I_o = 623 \text{ mA}$ $P_o = 2.45 \text{ W}$ With IIC ¹⁾ : $L_o = 92.8 \text{ } \mu\text{H}$, $C_o = 0.433 \text{ } \mu\text{F}$, $L_o/R_o = 14.6 \text{ } \mu\text{H}/\Omega$			
 For an overview and for information on the interdependencies between the gas group - sensor - nominal diameter, see the "Safety Instructions" (XA) document for the measuring device			

1) The gas group depends on the sensor and nominal diameter.

Transmitter

Intrinsically safe values

Order code for "Approval"	Terminal numbers			
	Supply voltage		Signal transmission	
	20 (L-)	10 (L+)	62 (A)	72 (B)
<ul style="list-style-type: none"> ▪ Option BM: ATEX II2G + IECEx Z1 Ex ia, II2D Ex tb ▪ Option BO: ATEX II1/2G + IECEx Z0/Z1 Ex ia, II2D ▪ Option BQ: ATEX II1/2G + IECEx Z0/Z1 Ex ia ▪ Option BU: ATEX II2G + IECEx Z1 Ex ia ▪ Option C2: CSA C/US IS Cl. I, II, III Div. 1 ▪ Option 85: ATEX II2G + IECEx Z1 Ex ia + CSA C/US IS Cl. I, II, III Div. 1 	$U_i = 16.24 \text{ V}$ $I_i = 623 \text{ mA}$ $P_i = 2.45 \text{ W}$ $L_i = 0 \text{ } \mu\text{H}$ $C_i = 6 \text{ nF}$			
 For an overview and for information on the interdependencies between the gas group - sensor - nominal diameter, see the "Safety Instructions" (XA) document for the measuring device				

Low flow cut off The switch points for low flow cut off are user-selectable.

Galvanic isolation The following connections are galvanically isolated from each other:

- Outputs
- Power supply

Protocol-specific data HART

Manufacturer ID	0x11
Device type ID	0x4A
HART protocol revision	7
Device description files (DTM, DD)	Information and files under: www.endress.com
HART load	Min. 250 Ω

Dynamic variables	<p>Read out the dynamic variables: HART command 3 The measured variables can be freely assigned to the dynamic variables.</p> <p>Measured variables for PV (primary dynamic variable)</p> <ul style="list-style-type: none"> ▪ Mass flow ▪ Volume flow ▪ Corrected volume flow ▪ Density ▪ Reference density ▪ Temperature <p>Measured variables for SV, TV, QV (secondary, tertiary and quaternary dynamic variable)</p> <ul style="list-style-type: none"> ▪ Mass flow ▪ Volume flow ▪ Corrected volume flow ▪ Density ▪ Reference density ▪ Temperature ▪ Totalizer 1 ▪ Totalizer 2 ▪ Totalizer 3 <p> The range of options increases if the measuring device has one or more application packages.</p> <p>Heartbeat Technology Application Package Additional measured variables are available with the Heartbeat Technology application package:</p> <ul style="list-style-type: none"> ▪ Carrier pipe temperature ▪ Oscillation amplitude 0
Device variables	<p>Read out the device variables: HART command 9 The device variables are permanently assigned.</p> <p>A maximum of 8 device variables can be transmitted:</p> <ul style="list-style-type: none"> ▪ 0 = mass flow ▪ 1 = volume flow ▪ 2 = corrected volume flow ▪ 3 = density ▪ 4 = reference density ▪ 5 = temperature ▪ 6 = totalizer 1 ▪ 7 = totalizer 2 ▪ 8 = totalizer 3 ▪ 13 = target mass flow ▪ 14 = carrier mass flow ▪ 15 = concentration

PROFIBUS DP

Manufacturer ID	0x11
Ident number	0x1561
Profile version	3.02
Device description files (GSD, DTM, DD)	<p>Information and files under:</p> <ul style="list-style-type: none"> ▪ www.endress.com On the product page for the device: Documents/Software → Device drivers ▪ www.profibus.org

<p>Output values (from measuring device to automation system)</p>	<p>Analog input 1 to 8</p> <ul style="list-style-type: none"> ▪ Mass flow ▪ Volume flow ▪ Corrected volume flow ▪ Target mass flow ▪ Carrier mass flow ▪ Density ▪ Reference density ▪ Concentration ▪ Temperature ▪ Carrier pipe temperature ▪ Electronic temperature ▪ Oscillation frequency ▪ Oscillation amplitude ▪ Frequency fluctuation ▪ Oscillation damping ▪ Tube damping fluctuation ▪ Signal asymmetry ▪ Exciter current <p>Digital input 1 to 2</p> <ul style="list-style-type: none"> ▪ Partially filled pipe detection ▪ Low flow cut off <p>Totalizer 1 to 3</p> <ul style="list-style-type: none"> ▪ Mass flow ▪ Volume flow ▪ Corrected volume flow
<p>Input values (from automation system to measuring device)</p>	<p>Analog output 1 to 3 (fixed assignment)</p> <ul style="list-style-type: none"> ▪ Pressure ▪ Temperature ▪ Reference density <p>Digital output 1 to 3 (fixed assignment)</p> <ul style="list-style-type: none"> ▪ Digital output 1: switch positive zero return on/off ▪ Digital output 2: perform zero point adjustment ▪ Digital output 3: switch switch output on/off <p>Totalizer 1 to 3</p> <ul style="list-style-type: none"> ▪ Totalize ▪ Reset and hold ▪ Preset and hold ▪ Stop ▪ Operating mode configuration: <ul style="list-style-type: none"> – Net flow total – Forward flow total – Reverse flow total
<p>Supported functions</p>	<ul style="list-style-type: none"> ▪ Identification & Maintenance Simplest device identification on the part of the control system and nameplate ▪ PROFIBUS upload/download Reading and writing parameters is up to ten times faster with PROFIBUS upload/download ▪ Condensed status Simplest and self-explanatory diagnostic information by categorizing diagnostic messages that occur
<p>Configuration of the device address</p>	<ul style="list-style-type: none"> ▪ DIP switches on the I/O electronics module ▪ Via operating tools (e.g. FieldCare)

Modbus RS485

<p>Protocol</p>	<p>Modbus Applications Protocol Specification V1.1</p>
<p>Device type</p>	<p>Slave</p>
<p>Slave address range</p>	<p>1 to 247</p>
<p>Broadcast address range</p>	<p>0</p>

Function codes	<ul style="list-style-type: none"> ▪ 03: Read holding register ▪ 04: Read input register ▪ 06: Write single registers ▪ 08: Diagnostics ▪ 16: Write multiple registers ▪ 23: Read/write multiple registers
Broadcast messages	Supported by the following function codes: <ul style="list-style-type: none"> ▪ 06: Write single registers ▪ 16: Write multiple registers ▪ 23: Read/write multiple registers
Supported baud rate	<ul style="list-style-type: none"> ▪ 1 200 BAUD ▪ 2 400 BAUD ▪ 4 800 BAUD ▪ 9 600 BAUD ▪ 19 200 BAUD ▪ 38 400 BAUD ▪ 57 600 BAUD ▪ 115 200 BAUD
Data transfer mode	<ul style="list-style-type: none"> ▪ ASCII ▪ RTU
Data access	Each device parameter can be accessed via Modbus RS485.  For Modbus register information

EtherNet/IP

Protocol	<ul style="list-style-type: none"> ▪ The CIP Networks Library Volume 1: Common Industrial Protocol ▪ The CIP Networks Library Volume 2: EtherNet/IP Adaptation of CIP
Communication type	<ul style="list-style-type: none"> ▪ 10Base-T ▪ 100Base-TX
Device profile	Generic device (product type: 0x2B)
Manufacturer ID	0x49E
Device type ID	0x104A
Baud rates	Automatic ¹⁰ / ₁₀₀ Mbit with half-duplex and full-duplex detection
Polarity	Auto-polarity for automatic correction of crossed TxD and RxD pairs
Supported CIP connections	Max. 3 connections
Explicit connections	Max. 6 connections
I/O connections	Max. 6 connections (scanner)
Configuration options for measuring device	<ul style="list-style-type: none"> ▪ DIP switches on the electronics module for IP addressing ▪ Manufacturer-specific software (FieldCare) ▪ Add-on Profile Level 3 for Rockwell Automation control systems ▪ Web browser ▪ Electronic Data Sheet (EDS) integrated in the measuring device
Configuration of the EtherNet interface	<ul style="list-style-type: none"> ▪ Speed: 10 MBit, 100 MBit, auto (factory setting) ▪ Duplex: half-duplex, full-duplex, auto (factory setting)
Configuration of the device address	<ul style="list-style-type: none"> ▪ DIP switches on the electronics module for IP addressing (last octet) ▪ DHCP ▪ Manufacturer-specific software (FieldCare) ▪ Add-on Profile Level 3 for Rockwell Automation control systems ▪ Web browser ▪ EtherNet/IP tools, e.g. RSLinx (Rockwell Automation)
Device Level Ring (DLR)	No

Fix Input			
RPI	5 ms to 10 s (factory setting: 20 ms)		
Exclusive Owner Multicast		Instance	Size [byte]
	Instance configuration:	0x68	398
	O → T configuration:	0x66	64
	T → O configuration:	0x64	44
Exclusive Owner Multicast		Instance	Size [byte]
	Instance configuration:	0x69	-
	O → T configuration:	0x66	64
	T → O configuration:	0x64	44
Input only Multicast		Instance	Size [byte]
	Instance configuration:	0x68	398
	O → T configuration:	0xC7	-
	T → O configuration:	0x64	44
Input only Multicast		Instance	Size [byte]
	Instance configuration:	0x69	-
	O → T configuration:	0xC7	-
	T → O configuration:	0x64	44
Input Assembly	<ul style="list-style-type: none"> ■ Current device diagnostics ■ Mass flow ■ Volume flow ■ Corrected volume flow ■ Density ■ Reference density ■ Temperature ■ Totalizer 1 ■ Totalizer 2 ■ Totalizer 3 		
Configurable Input			
RPI	5 ms to 10 s (factory setting: 20 ms)		
Exclusive Owner Multicast		Instance	Size [byte]
	Instance configuration:	0x68	398
	O → T configuration:	0x66	64
	T → O configuration:	0x65	88
Exclusive Owner Multicast		Instance	Size [byte]
	Instance configuration:	0x69	-
	O → T configuration:	0x66	64
	T → O configuration:	0x65	88
Input only Multicast		Instance	Size [byte]
	Instance configuration:	0x68	398
	O → T configuration:	0xC7	-
	T → O configuration:	0x65	88
Input only Multicast		Instance	Size [byte]
	Instance configuration:	0x69	-
	O → T configuration:	0xC7	-
	T → O configuration:	0x65	88

Configurable Input Assembly	<ul style="list-style-type: none"> ▪ Current device diagnostics ▪ Mass flow ▪ Volume flow ▪ Corrected volume flow ▪ Density ▪ Reference density ▪ Temperature ▪ Totalizer 1 ▪ Totalizer 2 ▪ Totalizer 3 <p> The range of options increases if the measuring device has one or more application packages.</p>
Fix Output	
Output Assembly	<ul style="list-style-type: none"> ▪ Activation of reset totalizers 1-3 ▪ Activation of pressure compensation ▪ Activation of reference density compensation ▪ Activation of temperature compensation ▪ Reset totalizers 1-3 ▪ External pressure value ▪ Pressure unit ▪ External reference density ▪ Reference density unit ▪ External temperature ▪ Temperature unit
Configuration	
Configuration Assembly	<p>Only the most common configurations are listed below.</p> <ul style="list-style-type: none"> ▪ Software write protection ▪ Mass flow unit ▪ Mass unit ▪ Volume flow unit ▪ Volume unit ▪ Corrected volume flow unit ▪ Corrected volume unit ▪ Density unit ▪ Reference density unit ▪ Temperature unit ▪ Pressure unit ▪ Length ▪ Totalizer 1-3: <ul style="list-style-type: none"> - Assignment - Unit - Measuring mode - Failsafe mode ▪ Alarm delay

Power supply

Terminal assignment

Overview: housing version and connection versions

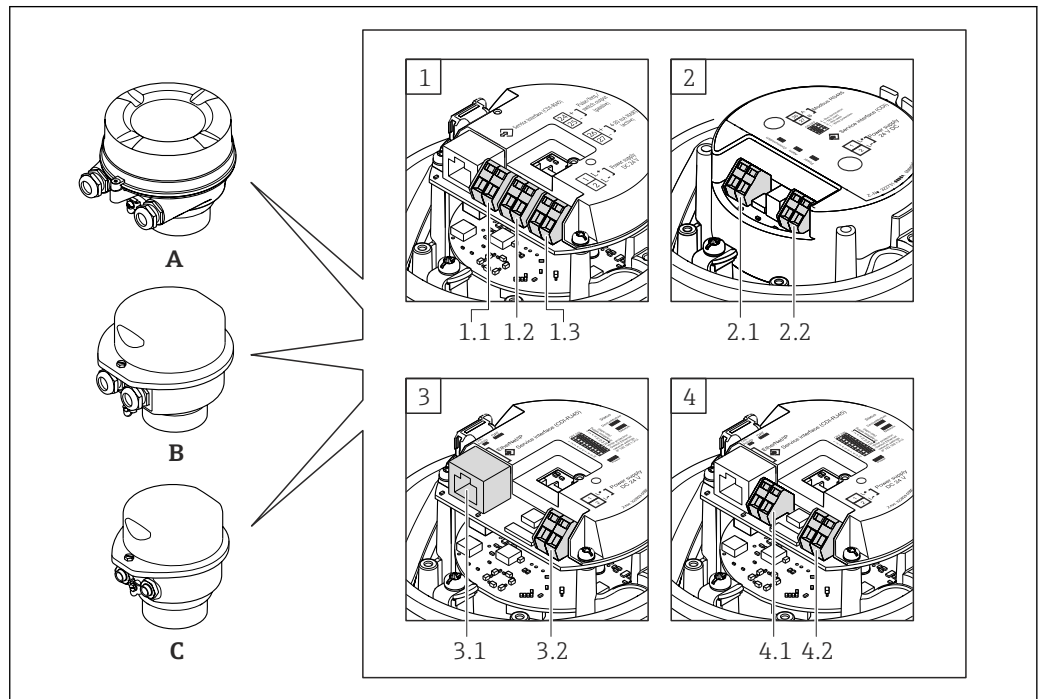

A0016770

- A Housing version: compact, aluminum coated
- B Housing version: compact, hygienic, stainless
- C Housing version: ultra-compact, hygienic, stainless
- 1 Connection version: 4-20 mA HART, pulse/frequency/switch output
 - 1.1 Signal transmission: pulse/frequency/switch output
 - 1.2 Signal transmission: 4-20 mA HART
 - 1.3 Supply voltage
- 2 Connection version: Modbus RS485
 - 2.1 Signal transmission
 - 2.2 Supply voltage
- 3 Connection versions: EtherNet/IP and PROFINET
 - 3.1 Signal transmission
 - 3.2 Supply voltage
- 4 Connection version: PROFIBUS DP
 - 4.1 Signal transmission
 - 4.2 Supply voltage

Transmitter

Connection version 4-20 mA HART with pulse/frequency/switch output

Order code for "Output", option **B**

Depending on the housing version, the transmitters can be ordered with terminals or device plugs.

Order code for "Housing"	Connection methods available		Possible options for order code "Electrical connection"
	Outputs	Power supply	
Options A, B	Terminals	Terminals	<ul style="list-style-type: none"> ▪ Option A: coupling M20x1 ▪ Option B: thread M20x1 ▪ Option C: thread G ½" ▪ Option D: thread NPT ½"
Options A, B	Device plugs → ☞ 25	Terminals	<ul style="list-style-type: none"> ▪ Option L: plug M12x1 + thread NPT ½" ▪ Option N: plug M12x1 + coupling M20 ▪ Option P: plug M12x1 + thread G ½" ▪ Option U: plug M12x1 + thread M20
Options A, B, C	Device plugs → ☞ 25	Device plugs → ☞ 25	Option Q : 2 x plug M12x1
Order code for "Housing": <ul style="list-style-type: none"> ▪ Option A: compact, coated aluminum ▪ Option B: compact, hygienic, stainless ▪ Option C: ultra-compact, hygienic, stainless 			

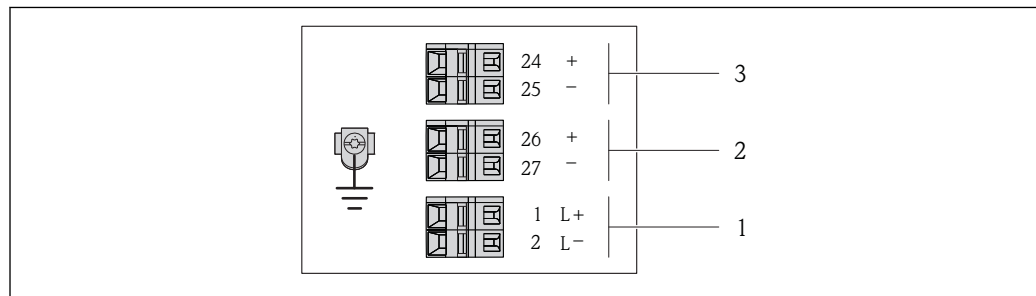

A001688B

☞ 2 Terminal assignment 4-20 mA HART with pulse/frequency/switch output

- 1 Power supply: DC 24 V
- 2 Output 1: 4-20 mA HART (active)
- 3 Output 2: pulse/frequency/switch output (passive)



Order code for "Output"	Terminal number					
	Power supply		Output 1		Output 2	
	2 (L-)	1 (L+)	27 (-)	26 (+)	25 (-)	24 (+)
Option B	DC 24 V		4-20 mA HART (active)		Pulse/frequency/switch output (passive)	
Order code for "Output": Option B : 4-20 mA HART with pulse/frequency/switch output						

PROFIBUS DP connection version

 For use in the non-hazardous area and Zone 2/Div. 2.

Order code for "Output", option **L**

Depending on the housing version, the transmitters can be ordered with terminals or device plugs.

Order code for "Housing"	Connection methods available		Possible options for order code "Electrical connection"
	Output	Power supply	
Options A, B	Terminals	Terminals	<ul style="list-style-type: none"> ▪ Option A: coupling M20x1 ▪ Option B: thread M20x1 ▪ Option C: thread G ½" ▪ Option D: thread NPT ½"
Options A, B	Device plugs →  25	Terminals	<ul style="list-style-type: none"> ▪ Option L: plug M12x1 + thread NPT ½" ▪ Option N: plug M12x1 + coupling M20 ▪ Option P: plug M12x1 + thread G ½" ▪ Option U: plug M12x1 + thread M20
Options A, B, C	Device plugs →  25	Device plugs →  25	Option Q : 2 x plug M12x1
Order code for "Housing": <ul style="list-style-type: none"> ▪ Option A: compact, coated aluminum ▪ Option B: compact, hygienic, stainless ▪ Option C: ultra-compact, hygienic, stainless 			

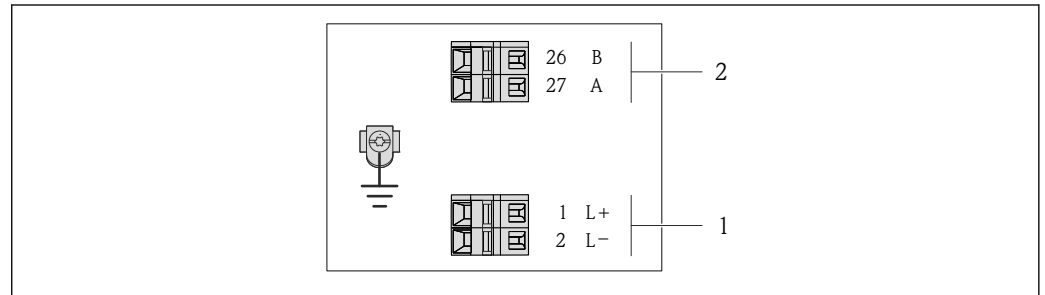

A0022716

 3 PROFIBUS DP terminal assignment

- 1 Power supply: DC 24 V
- 2 PROFIBUS DP



Order code for "Output"	Terminal number			
	Power supply		Output	
	2 (L-)	1 (L+)	26 (RxD/TxD-P)	27 (RxD/TxD-N)
Option L	DC 24 V		B	A
Order code for "Output": Option L : PROFIBUS DP, for use in non-hazardous areas and Zone 2/div. 2				

Modbus RS485 connection version

 For use in the non-hazardous area and Zone 2/Div. 2.

Order code for "Output", option **M**

Depending on the housing version, the transmitters can be ordered with terminals or device plugs.

Order code for "Housing"	Connection methods available		Possible options for order code "Electrical connection"
	Output	Power supply	
Options A, B	Terminals	Terminals	<ul style="list-style-type: none"> ▪ Option A: coupling M20x1 ▪ Option B: thread M20x1 ▪ Option C: thread G ½" ▪ Option D: thread NPT ½"
Options A, B	Device plugs →  25	Terminals	<ul style="list-style-type: none"> ▪ Option L: plug M12x1 + thread NPT ½" ▪ Option N: plug M12x1 + coupling M20 ▪ Option P: plug M12x1 + thread G ½" ▪ Option U: plug M12x1 + thread M20
Options A, B, C	Device plugs →  25	Device plugs →  25	Option Q: 2 x plug M12x1
Order code for "Housing": <ul style="list-style-type: none"> ▪ Option A: compact, coated aluminum ▪ Option B: compact, hygienic, stainless ▪ Option C ultra-compact, hygienic, stainless 			

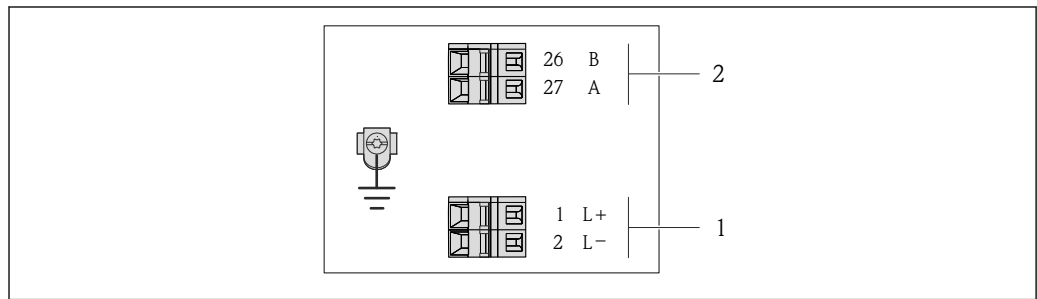

A0019528

 4 Modbus RS485 terminal assignment, connection version for use in non-hazardous areas and Zone 2/Div. 2

- 1 Power supply: DC 24 V
- 2 Modbus RS485

Order code for "Output"	Terminal number			
	Power supply		Output	
	2 (L-)	1 (L+)	27 (B)	26 (A)
Option M	DC 24 V		Modbus RS485	
Order code for "Output": Option M Modbus RS485, for use in non-hazardous areas and Zone 2/Div. 2				

Modbus RS485 connection version

 For use in the intrinsically safe area. Connection via Safety Barrier Promass 100.

Order code for "Output", option **M**

Depending on the housing version, the transmitters can be ordered with terminals or device plugs.

Order code for "Housing"	Connection methods available		Possible options for order code "Electrical connection"
	Output	Power supply	
Options A, B	Terminals	Terminals	<ul style="list-style-type: none"> ▪ Option A: coupling M20x1 ▪ Option B: thread M20x1 ▪ Option C: thread G ½" ▪ Option D: thread NPT ½"
A, B, C	Device plugs →  25		Option I: plug M12x1
Order code for "Housing": <ul style="list-style-type: none"> ▪ Option A: compact, coated aluminum ▪ Option B: compact, hygienic, stainless ▪ Option C: ultra-compact, hygienic, stainless 			

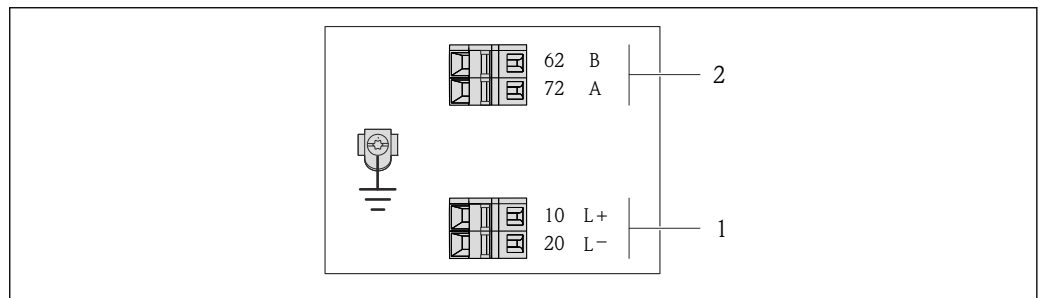

A0017053

 5 *Modbus RS485 terminal assignment, connection version for use in intrinsically safe areas (connection via Safety Barrier Promass 100)*

1 *Intrinsically safe power supply*

2 *Modbus RS485*

Order code for "Output"	20 (L-)	10 (L+)	72 (B)	62 (A)
Option M	Intrinsically safe supply voltage		Modbus RS485 intrinsically safe	
Order code for "Output": Option M : Modbus RS485, for use in intrinsically safe areas (connection via Safety Barrier Promass 100)				

EtherNet/IP connection version

Order code for "Output", option **N**

Depending on the housing version, the transmitters can be ordered with terminals or device plugs.

Order code for "Housing"	Connection methods available		Possible options for order code "Electrical connection"
	Output	Power supply	
Options A, B	Device plugs → 25	Terminals	<ul style="list-style-type: none"> ▪ Option L: plug M12x1 + thread NPT ½" ▪ Option N: plug M12x1 + coupling M20 ▪ Option P: plug M12x1 + thread G ½" ▪ Option U: plug M12x1 + thread M20
Options A, B, C	Device plugs → 25	Device plugs → 25	Option Q : 2 x plug M12x1
Order code for "Housing": <ul style="list-style-type: none"> ▪ Option A: compact, coated aluminum ▪ Option B: compact, hygienic, stainless ▪ Option C: ultra-compact, hygienic, stainless 			

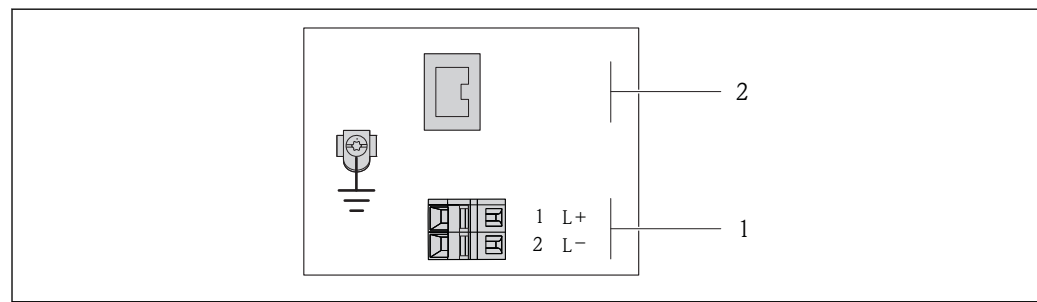

A0017054

6 EtherNet/IP terminal assignment

- 1 Power supply: DC 24 V
- 2 EtherNet/IP

Order code for "Output"	Terminal number		Output Device plug M12x1
	Power supply 2 (L-)	1 (L+)	
Option N	DC 24 V		EtherNet/IP
Order code for "Output": Option N : EtherNet/IP			

Safety Barrier Promass 100

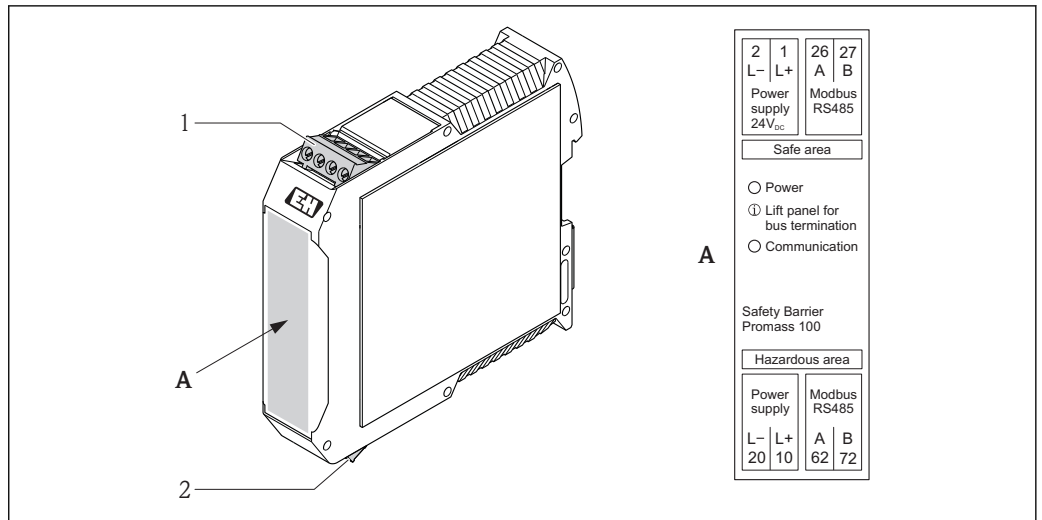

7 Safety Barrier Promass 100 with terminals

- 1 Non-hazardous area and Zone 2/Div. 2
- 2 Intrinsically safe area

A0016922

Pin assignment, device plug

- i** Order codes for the M12x1 connectors, see the "Order code for **electrical connection**" column:
 - 4-20 mA HART, pulse/frequency/switch output → 20
 - PROFIBUS DP → 21
 - Modbus RS485 → 22
 - EtherNet/IP → 24

Supply voltage

For all connection versions except MODBUS RS485 intrinsically safe (device side)

- i** Device plug MODBUS RS485 intrinsically safe with supply voltage → 26



<p style="text-align: center;">A0016809</p>	Pin	Assignment	
	1	L+	DC 24 V
	2		Not assigned
	3		Not assigned
	4	L-	DC 24 V
	5		Grounding/shielding
Coding		Plug/socket	
A		Plug	

- i** The following is recommended as a socket:
 - Binder, series 763, part no. 79 3440 35 05
 - Alternatively: Phoenix part no. 1669767 SAC-5P-M12MS
 - With the order code for "Output", option **B**: 4-20 mA HART, pulse/frequency/switch output
 - With the order code for "Output", option **N**: EtherNet/IP
 - When using the device in a hazardous location: Use a suitably certified socket.

4-20 mA HART with pulse/frequency/switch output

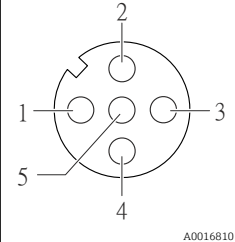
Device plug for signal transmission (device side)

	Pin	Assignment	
	1	+	4-20 mA HART (active)
	2	-	4-20 mA HART (active)
	3	+	Pulse/frequency/switch output (passive)
	4	-	Pulse/frequency/switch output (passive)
	5		Grounding/shielding
Coding		Plug/socket	
A		Socket	



-  Recommended plug: Binder, series 763, part no. 79 3439 12 05
-  When using the device in a hazardous location, use a suitably certified plug.

PROFIBUS DP

 For use in the non-hazardous area and Zone 2/Div. 2.

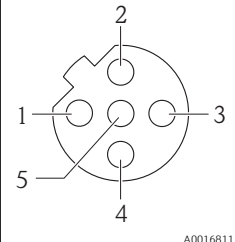
Device plug for signal transmission (device side)

	Pin	Assignment	
	1		Not assigned
	2	A	PROFIBUS DP
	3		Not assigned
	4	B	PROFIBUS DP
	5		Grounding/shielding
Coding		Plug/socket	
B		Socket	

-  Recommended plug: Binder, series 763, part no. 79 4449 20 05
-  When using the device in a hazardous location, use a suitably certified plug.

MODBUS RS485

Device plug for signal transmission with supply voltage (device side), MODBUS RS485 (intrinsically safe)

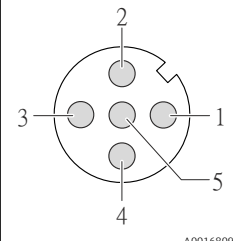
	Pin	Assignment	
	1	L+	Supply voltage, intrinsically safe
	2	A	Modbus RS485 intrinsically safe
	3	B	
	4	L-	Supply voltage, intrinsically safe
	5		Grounding/shielding
Coding		Plug/socket	
A		Plug	

-  Recommended socket: Binder, series 763, part no. 79 3439 12 05
-  When using the device in a hazardous location: Use a suitably certified socket.

Device plug for signal transmission (device side), MODBUS RS485 (not intrinsically safe)

 For use in the non-hazardous area and Zone 2/Div. 2.

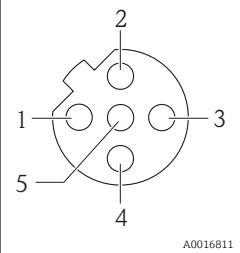
	Pin	Assignment	
	1		Not assigned
	2	A	Modbus RS485
	3		Not assigned
	4	B	Modbus RS485
	5		Grounding/shielding
Coding		Plug/socket	
B		Socket	

-  Recommended plug: Binder, series 763, part no. 79 4449 20 05
- When using the device in a hazardous location, use a suitably certified plug.

EtherNet/IP

Device plug for signal transmission (device side)

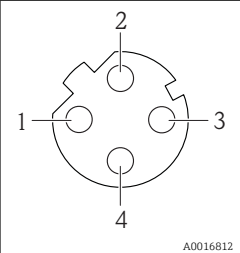
	Pin	Assignment	
	1	+	Tx
	2	+	Rx
	3	-	Tx
	4	-	Rx
	Coding		Plug/socket
D		Socket	

-  Recommended plug:
- Binder, series 763, part no. 99 3729 810 04
 - Phoenix, part no. 1543223 SACC-M12MSD-4Q
 - When using the device in a hazardous location, use a suitably certified plug.

Supply voltage

The power unit must be tested to ensure it meets safety requirements (e.g. PELV, SELV).

Transmitter

For device version with communication type:

- HART, PROFIBUS DP, EtherNet/IP: DC 20 to 30 V
- Modbus RS485, device version:
 - For use in the non-hazardous area and Zone 2/Div. 2: DC 20 to 30 V
 - For use in the intrinsically safe area: power supply via Safety Barrier Promass 100

Safety Barrier Promass 100

DC 20 to 30 V

Power consumption

Transmitter

Order code for "Output"	Maximum Power consumption
Option B : 4-20 mA HART with pulse/frequency/switch output	3.5 W
Option L : PROFIBUS DP	3.5 W
Option M Modbus RS485, for use in non-hazardous areas and Zone 2/Div. 2	3.5 W

Order code for "Output"	Maximum Power consumption
Option M : Modbus RS485, for use in intrinsically safe areas	2.45 W
Option N : EtherNet/IP	3.5 W

Safety Barrier Promass 100

Order code for "Output"	Maximum Power consumption
Option M : Modbus RS485, for use in intrinsically safe areas	4.8 W

Current consumption**Transmitter**

Order code for "Output"	Maximum Current consumption	Maximum switch-on current
Option B : 4-20mA HART, pul./freq./switch output	145 mA	18 A (< 0.125 ms)
Option L : PROFIBUS DP	145 mA	18 A (< 0.125 ms)
Option M Modbus RS485, for use in non-hazardous areas and Zone 2/Div. 2	90 mA	10 A (< 0.8 ms)
Option M : Modbus RS485, for use in intrinsically safe areas	145 mA	16 A (< 0.4 ms)
Option N : EtherNet/IP	145 mA	18 A (< 0.125 ms)

Safety Barrier Promass 100

Order code for "Output"	Maximum Current consumption	Maximum switch-on current
Option M : Modbus RS485, for use in intrinsically safe areas	230 mA	10 A (< 0.8 ms)

Power supply failure

- Totalizers stop at the last value measured.
- Depending on the device version, the configuration is retained in the device memory or in the plug-in memory (HistoROM DAT).
- Error messages (incl. total operated hours) are stored.

Electrical connection

Connecting the transmitter

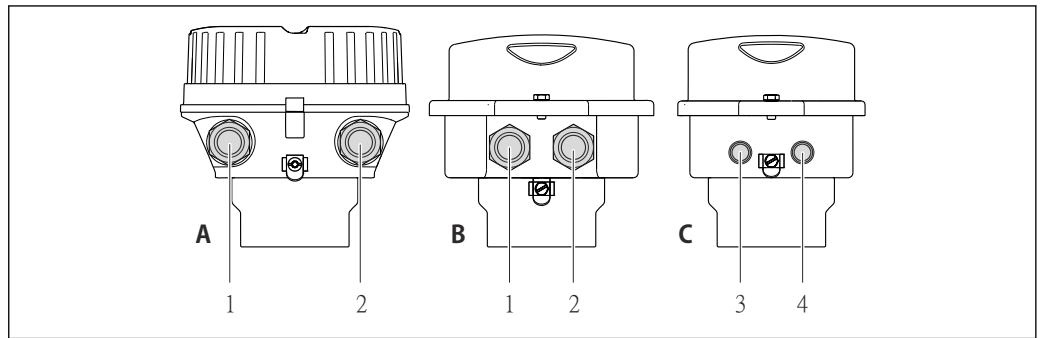

- A Housing version: compact, aluminum coated
- B Housing version: compact hygienic, stainless
- 1 Cable entry or device plug for signal transmission
- 2 Cable entry or device plug for supply voltage
- C Housing version: ultra-compact, hygienic, stainless, M12 device plug
- 3 Device plug for signal transmission
- 4 Device plug for supply voltage

- i** ■ Terminal assignment → 19
- Pin assignment, device plug → 25

i In the case of device versions with a connector, the transmitter housing does not need to be opened to connect the signal cable or power supply cable.

Connection examples

Current output 4-20 mA HART

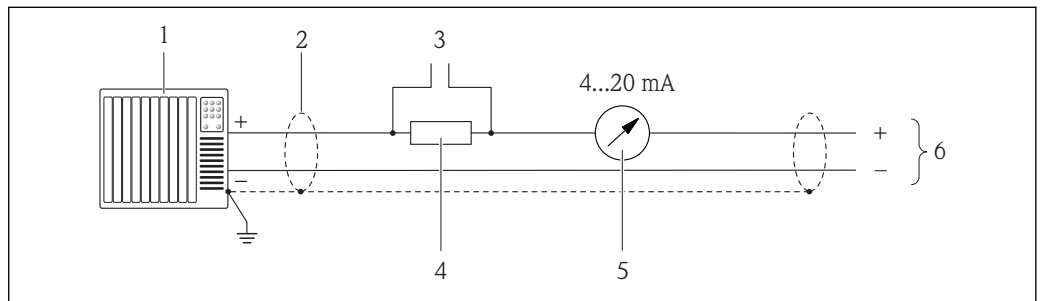

- 8** Connection example for 4-20 mA HART current output (active)
- 1 Automation system with current input (e.g. PLC)
- 2 Cable shield, observe cable specifications
- 3 Connection for HART operating devices
- 4 Resistor for HART communication ($\geq 250 \Omega$): observe maximum load
- 5 Analog display unit: observe maximum load
- 6 Transmitter

Pulse/frequency output

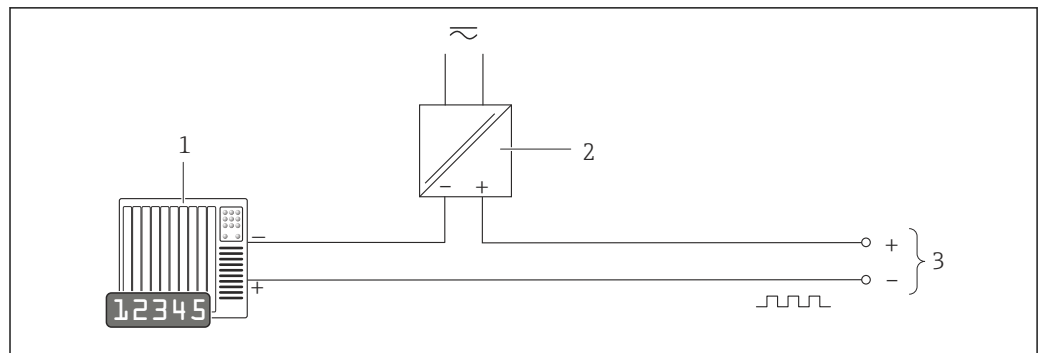

A0016801

9 Connection example for pulse/frequency output (passive)

- 1 Automation system with pulse/frequency input (e.g. PLC)
- 2 Power supply
- 3 Transmitter: observe input values → 9

Switch output

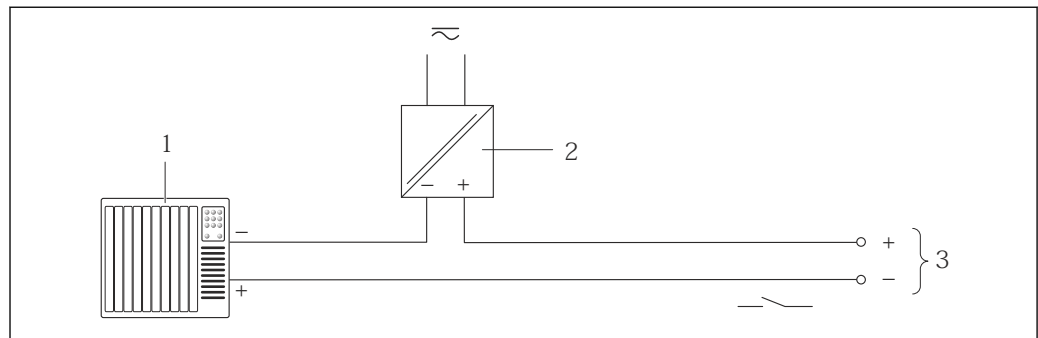

A0016802

10 Connection example for switch output (passive)

- 1 Automation system with switch input (e.g. PLC)
- 2 Power supply
- 3 Transmitter: observe input values

PROFIBUS DP

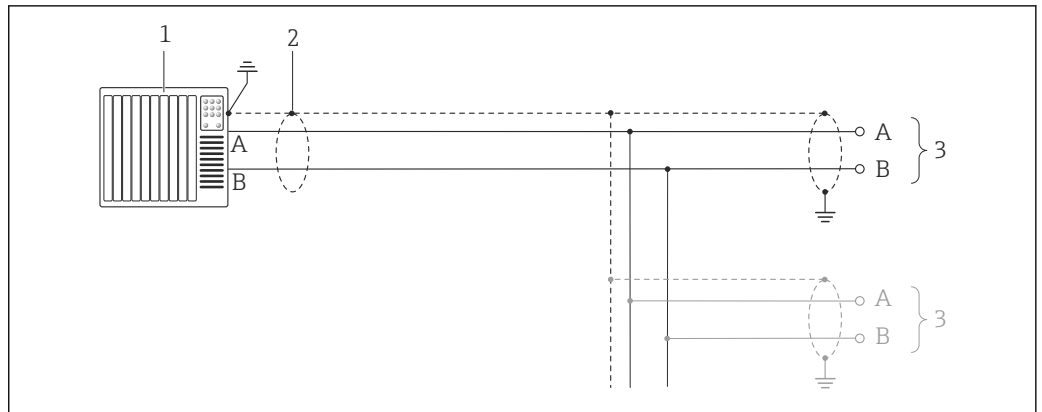

A0021429

11 Connection example for PROFIBUS DP, non-hazardous area and Zone 2/Div. 2

- 1 Control system (e.g. PLC)
- 2 Cable shield: the cable shield must be grounded at both ends to comply with EMC requirements; observe cable specifications
- 3 Transmitter

i If baud rates > 1.5 MBaud an EMC cable entry must be used and the cable shield must continue as far as the terminal wherever possible.

Modbus RS485

Modbus RS485, non-hazardous area and Zone 2/Div. 2

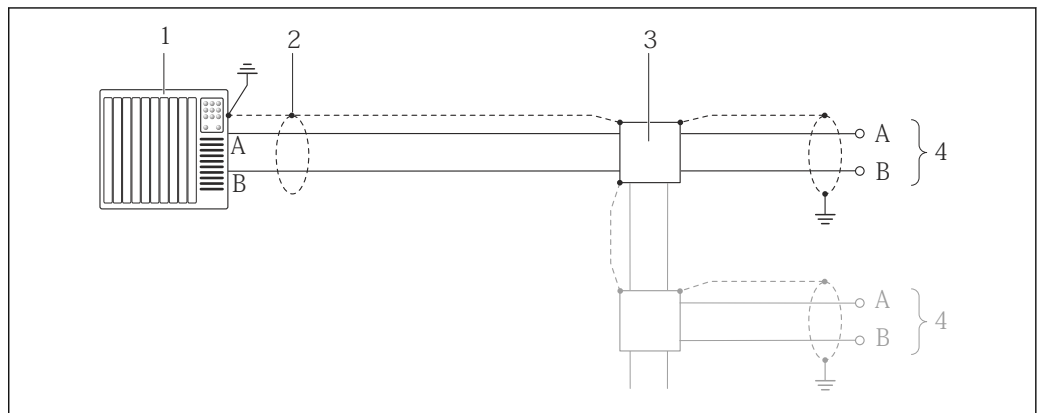

A0016803

12 Connection example for Modbus RS485, non-hazardous area and Zone 2/Div. 2

- 1 Control system (e.g. PLC)
- 2 Cable shield: the cable shield must be grounded at both ends to comply with EMC requirements; observe cable specifications
- 3 Distribution box
- 4 Transmitter

Modbus RS485 intrinsically safe

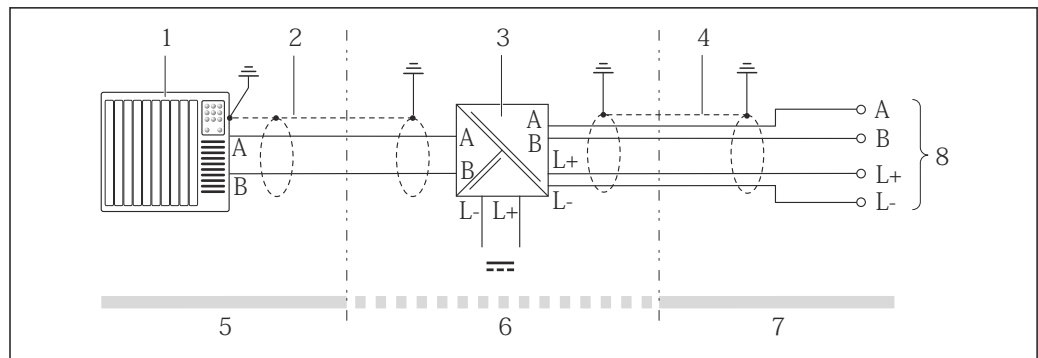

A0016804

13 Connection example for Modbus RS485 intrinsically safe

- 1 Control system (e.g. PLC)
- 2 Cable shield, observe cable specifications
- 3 Safety Barrier Promass 100
- 4 Observe cable specifications
- 5 Non-hazardous area
- 6 Non-hazardous area and Zone 2/Div. 2
- 7 Intrinsically safe area
- 8 Transmitter

EtherNet/IP

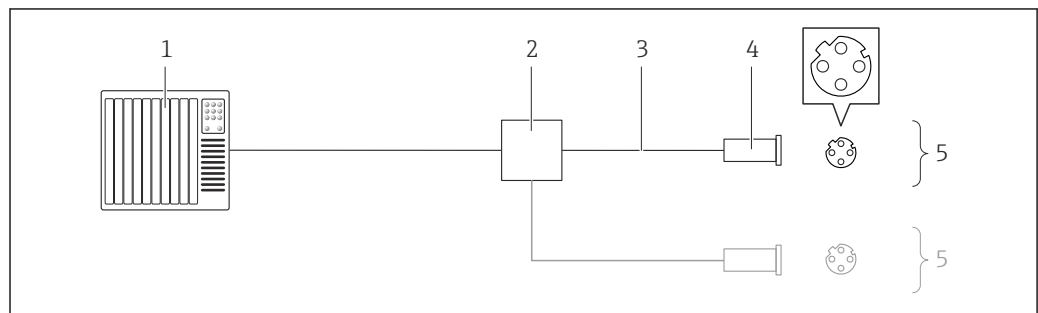

A0016805

14 Connection example for EtherNet/IP

- 1 Control system (e.g. PLC)
- 2 Ethernet switch
- 3 Observe cable specifications
- 4 Device plug
- 5 Transmitter

HART input

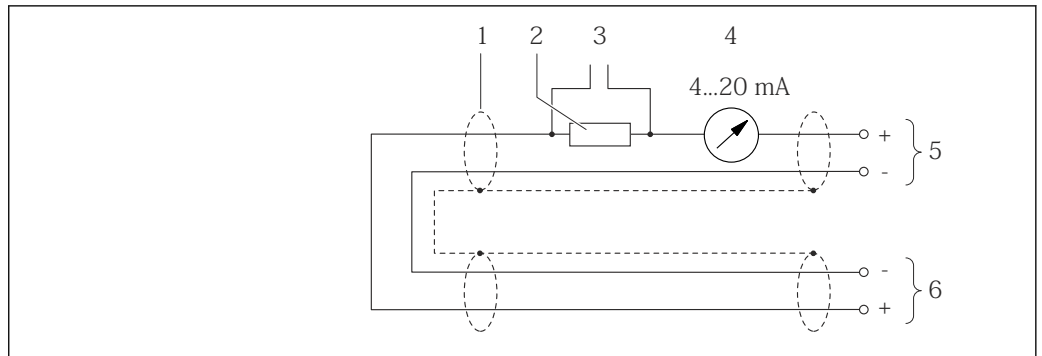

A0019828

15 Connection example for HART input (burst mode) via current output (active)

- 1 Cable shield, observe cable specifications
- 2 Resistor for HART communication ($\geq 250 \Omega$): observe maximum load
- 3 Connection for HART operating devices
- 4 Analog display unit
- 5 Transmitter
- 6 Sensor for external measured variable

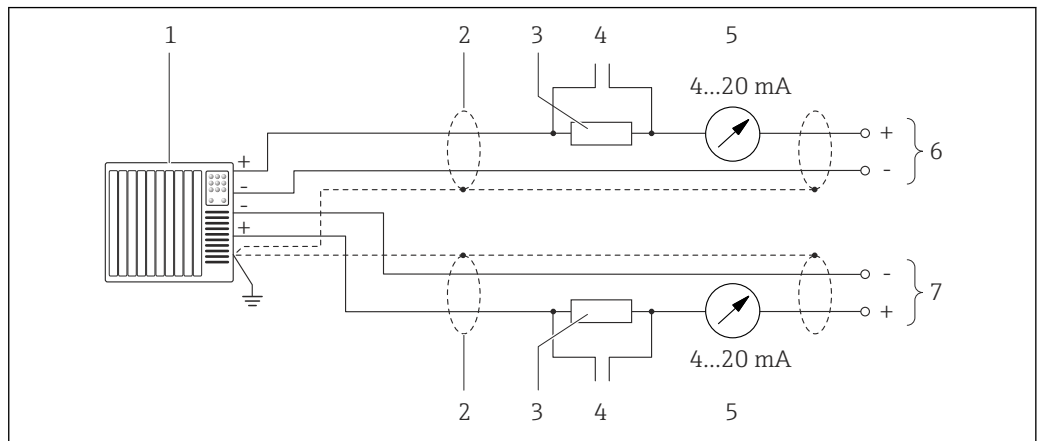

A0019830

16 Connection example for HART input (master mode) via current output (active)

- 1 Automation system with current input (e.g. PLC).
Prerequisite: automation system with HART version 6, HART commands 113 and 114 can be processed.
- 2 Cable shield, observe cable specifications
- 3 Resistor for HART communication ($\geq 250 \Omega$): observe maximum load
- 4 Connection for HART operating devices
- 5 Analog display unit
- 6 Transmitter
- 7 Sensor for external measured variable

Potential equalization

Requirements

No special measures for potential equalization are required.

 For devices intended for use in hazardous locations, please observe the guidelines in the Ex documentation (XA).

Terminals

Transmitter

Spring terminals for wire cross-sections 0.5 to 2.5 mm^2 (20 to 14 AWG)

Safety Barrier Promass 100

Plug-in screw terminals for wire cross-sections 0.5 to 2.5 mm^2 (20 to 14 AWG)

Cable entries

- Cable gland: M20 × 1.5 with cable ϕ 6 to 12 mm (0.24 to 0.47 in)
- Thread for cable entry:
 - NPT ½"
 - G ½"
 - M20

Cable specification**Permitted temperature range**

- -40 °C (-40 °F) to +80 °C (+176 °F)
- Minimum requirement: cable temperature range \geq ambient temperature +20 K

Power supply cable

Standard installation cable is sufficient.

Signal cable*Current output*

For 4-20 mA HART: Shielded cable recommended. Observe grounding concept of the plant.

Pulse/frequency/switch output

Standard installation cable is sufficient.

PROFIBUS DP

The IEC 61158 standard specifies two types of cable (A and B) for the bus line which can be used for every transmission rate. Cable type A is recommended.

Cable type	A
Characteristic impedance	135 to 165 Ω at a measuring frequency of 3 to 20 MHz
Cable capacitance	<30 pF/m
Wire cross-section	>0.34 mm ² (22 AWG)
Cable type	Twisted pairs
Loop resistance	\leq 110 Ω /km
Signal damping	Max. 9 dB over the entire length of the cable cross-section
Shield	Copper braided shielding or braided shielding with foil shield. When grounding the cable shield, observe the grounding concept of the plant.

Modbus RS485

The EIA/TIA-485 standard specifies two types of cable (A and B) for the bus line which can be used for every transmission rate. Cable type A is recommended.

Cable type	A
Characteristic impedance	135 to 165 Ω at a measuring frequency of 3 to 20 MHz
Cable capacitance	<30 pF/m
Wire cross-section	>0.34 mm ² (22 AWG)
Cable type	Twisted pairs
Loop resistance	\leq 110 Ω /km
Signal damping	Max. 9 dB over the entire length of the cable cross-section
Shield	Copper braided shielding or braided shielding with foil shield. When grounding the cable shield, observe the grounding concept of the plant.

EtherNet/IP

The standard ANSI/TIA/EIA-568-B.2 Annex specifies CAT 5 as the minimum category for a cable used for EtherNet/IP. CAT 5e and CAT 6 are recommended.



For more information on planning and installing EtherNet/IP networks, please refer to the "Media Planning and Installation Manual. EtherNet/IP" of ODVA Organization

Connecting cable between Safety Barrier Promass 100 and measuring device

Cable type	Shielded twisted-pair cable with 2x2 wires. When grounding the cable shield, observe the grounding concept of the plant.
Maximum cable resistance	2.5 Ω, one side



Comply with the maximum cable resistance specifications to ensure the operational reliability of the measuring device.

The maximum cable length for individual wire cross-sections is specified in the table below. Observe the maximum capacitance and inductance per unit length of the cable and connection values for hazardous areas .

Wire cross-section		Maximum cable length	
[mm ²]	[AWG]	[m]	[ft]
0.5	20	70	230
0.75	18	100	328
1.0	17	100	328
1.5	16	200	656
2.5	14	300	984

Performance characteristics

Reference operating conditions

- Error limits based on ISO 11631
- Water with +15 to +45 °C (+59 to +113 °F) at 2 to 6 bar (29 to 87 psi)
- Specifications as per calibration protocol
- Accuracy based on accredited calibration rigs that are traced to ISO 17025.



To obtain measured errors, use the *Applicator* sizing tool → 73

Maximum measured error

o.r. = of reading; 1 g/cm³ = 1 kg/l; T = medium temperature

Base accuracy



Design fundamentals → 38

Mass flow and volume flow (liquids)

±0.10 % o.r.

Mass flow (gases)

±0.50 % o.r.

Density (liquids)

Under reference operating conditions		Standard density calibration ¹⁾		Wide-range density specification ^{2) 3)}	
[g/cm ³]	[lbs/in ³]	[g/cm ³]	[lbs/in ³]	[g/cm ³]	[lbs/in ³]
±0.0005	±0.00097	±0.02	±0.039	±0.002	±0.0039

- 1) Valid over the entire temperature and density range
- 2) Valid range for special density calibration: 0 to 2 g/cm³, +5 to +80 °C (+41 to +176 °F)
- 3) Order code for "Application package", option EF "Special density and concentration "

Temperature

$$\pm 0.5 \text{ °C} \pm 0.005 \cdot T \text{ °C} (\pm 0.9 \text{ °F} \pm 0.003 \cdot (T - 32) \text{ °F})$$

Zero point stability

DN		Zero point stability	
[mm]	[in]	[kg/h]	[lb/min]
1	1/24	0.0008	0.00003
2	1/12	0.002	0.00007
4	1/8	0.014	0.0005
6	1/4	0.02	0.0007

Flow values

Flow values as turndown parameter depending on nominal diameter.

SI units

DN [mm]	1:1	1:10	1:20	1:50	1:100	1:500
	[kg/h]	[kg/h]	[kg/h]	[kg/h]	[kg/h]	[kg/h]
1	20	2	1	0.4	0.2	0.04
2	100	10	5	2	1	0.2
4	450	45	22.5	9	4.5	0.9
6	1000	100	50	20	10	2

US units

DN [inch]	1:1	1:10	1:20	1:50	1:100	1:500
	[lb/min]	[lb/min]	[lb/min]	[lb/min]	[lb/min]	[lb/min]
1/24	0.735	0.074	0.037	0.015	0.007	0.001
1/12	3.675	0.368	0.184	0.074	0.037	0.007
1/8	16.54	1.654	0.827	0.331	0.165	0.033
1/4	36.75	3.675	1.838	0.735	0.368	0.074

Accuracy of outputs

 In the case of analog outputs, the output accuracy must also be considered for the measured error; in contrast, this need not be considered in the case of fieldbus outputs (e.g. Modbus RS485, EtherNet/IP).

The outputs have the following base accuracy specifications.

Current output

Accuracy	Max. $\pm 5 \mu\text{A}$
-----------------	--------------------------

Pulse/frequency output

o.r. = of reading

Accuracy	Max. $\pm 50 \text{ ppm o.r.}$ (across the entire ambient temperature range)
-----------------	--

Repeatability

o.r. = of reading; $1 \text{ g/cm}^3 = 1 \text{ kg/l}$; T = medium temperature

Base repeatability

Mass flow and volume flow (liquids)

$\pm 0.05 \%$ o.r.

Mass flow (gases)

$\pm 0.25 \%$ o.r.

 Design fundamentals →  38

Density (liquids)

$\pm 0.00025 \text{ g/cm}^3$

Temperature

$\pm 0.25 \text{ }^\circ\text{C} \pm 0.0025 \cdot T \text{ }^\circ\text{C}$ ($\pm 0.45 \text{ }^\circ\text{F} \pm 0.0015 \cdot (T-32) \text{ }^\circ\text{F}$)

Response time

The response time depends on the configuration (damping).

Influence of ambient temperature

Current output

o.r. = of reading

Temperature coefficient	Max. $\pm 0.005\%$ o.r./ $^\circ\text{C}$
--------------------------------	---

Pulse/frequency output

Temperature coefficient	No additional effect. Included in accuracy.
--------------------------------	---

Influence of medium temperature

Mass flow and volume flow

When there is a difference between the temperature for zero point adjustment and the process temperature, the typical measured error of the sensor is $\pm 0.0002 \%$ of the full scale value/ $^\circ\text{C}$ ($\pm 0.0001 \%$ of the full scale value/ $^\circ\text{F}$).

Density

When there is a difference between the density calibration temperature and the process temperature, the typical measured error of the sensor is $\pm 0.00005 \text{ g/cm}^3 \text{ }^\circ\text{C}$ ($\pm 0.000025 \text{ g/cm}^3 \text{ }^\circ\text{F}$). Field density calibration is possible.

Wide-range density specification (special density calibration)

If the process temperature is outside the valid range (→  35) the measured error is $\pm 0.00005 \text{ g/cm}^3 \text{ }^\circ\text{C}$ ($\pm 0.000025 \text{ g/cm}^3 \text{ }^\circ\text{F}$)

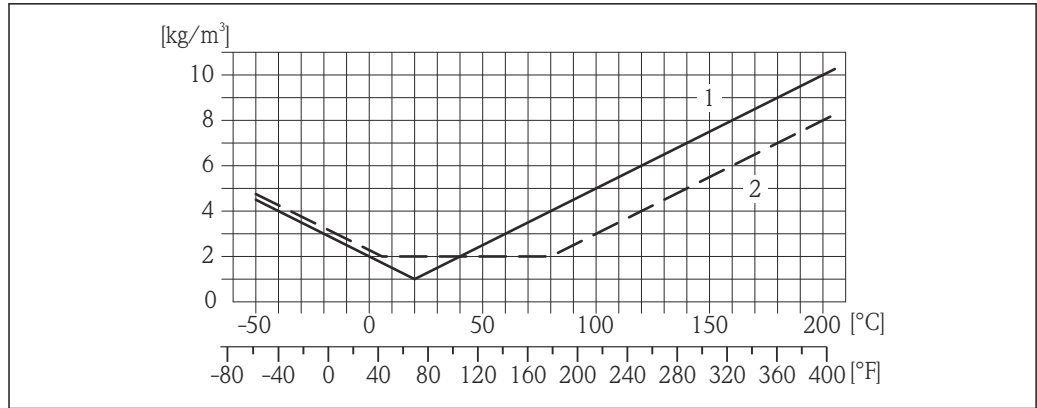

A0016617

- 1 Field density calibration, for example at +20 °C (+68 °F)
- 2 Special density calibration

Temperature

$\pm 0.005 \cdot T \text{ } ^\circ\text{C}$ ($\pm 0.005 \cdot (T - 32) \text{ } ^\circ\text{F}$)

Influence of medium pressure

The table below shows the effect on accuracy of mass flow due to a difference between calibration pressure and process pressure.

o.r. = of reading

DN		[% o.r./bar]	[% o.r./psi]
[mm]	[in]		
1	1/24	-0.001	-0.00007
2	1/12	0	0
4	1/6	-0.005	-0.0004
6	1/4	-0.003	-0.0002

Design fundamentals

o.r. = of reading, o.f.s. = of full scale value

BaseAccu = base accuracy in % o.r., BaseRepeat = base repeatability in % o.r.

MeasValue = measured value; ZeroPoint = zero point stability

Calculation of the maximum measured error as a function of the flow rate

Flow rate	Maximum measured error in % o.r.
$\geq \frac{\text{ZeroPoint}}{\text{BaseAccu}} \cdot 100$ <small>A0021332</small>	$\pm \text{BaseAccu}$ <small>A0021339</small>
$< \frac{\text{ZeroPoint}}{\text{BaseAccu}} \cdot 100$ <small>A0021333</small>	$\pm \frac{\text{ZeroPoint}}{\text{MeasValue}} \cdot 100$ <small>A0021334</small>

Calculation of the maximum repeatability as a function of the flow rate

Flow rate	Maximum repeatability in % o.r.
$\geq \frac{1/2 \cdot \text{ZeroPoint}}{\text{BaseRepeat}} \cdot 100$ <small>A0021335</small>	$\pm \text{BaseRepeat}$ <small>A0021340</small>
$< \frac{1/2 \cdot \text{ZeroPoint}}{\text{BaseRepeat}} \cdot 100$ <small>A0021336</small>	$\pm 1/2 \cdot \frac{\text{ZeroPoint}}{\text{MeasValue}} \cdot 100$ <small>A0021337</small>

Example for max. measured error

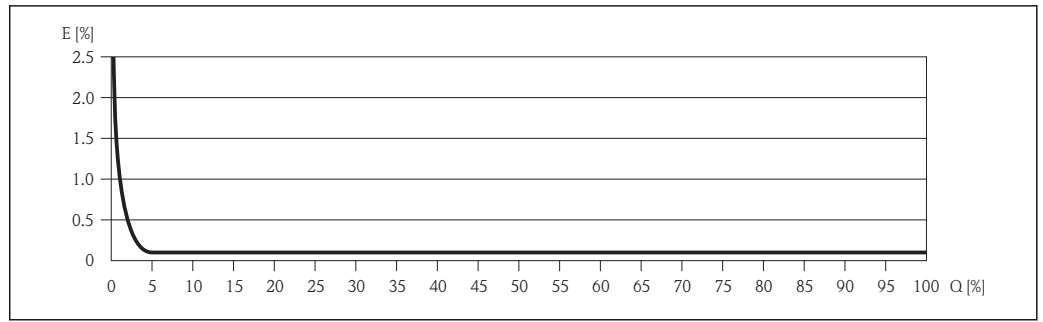

A0016709

E Error: Maximum measured error as % o.r. (example)
 Q Flow rate as %

Installation

No special measures such as supports are necessary. External forces are absorbed by the construction of the device.

Mounting location

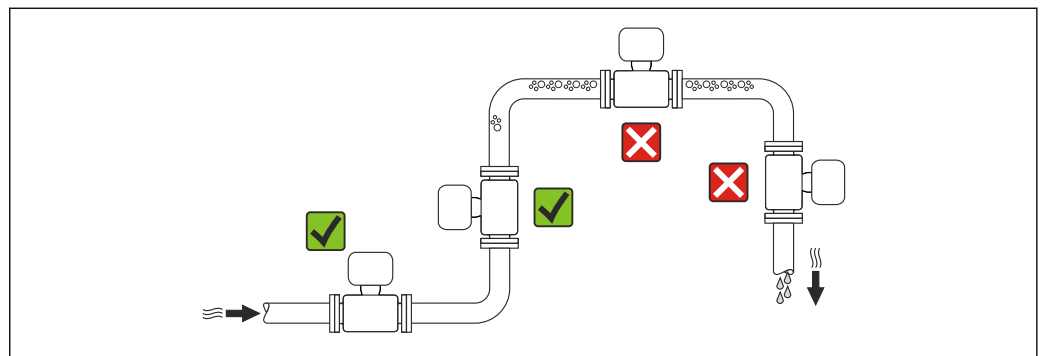

A0023344

To prevent measuring errors arising from accumulation of gas bubbles in the measuring tube, avoid the following mounting locations in the pipe:

- Highest point of a pipeline.
- Directly upstream of a free pipe outlet in a down pipe.

Installation in down pipes

However, the following installation suggestion allows for installation in an open vertical pipeline. Pipe restrictions or the use of an orifice with a smaller cross-section than the nominal diameter prevent the sensor running empty while measurement is in progress.

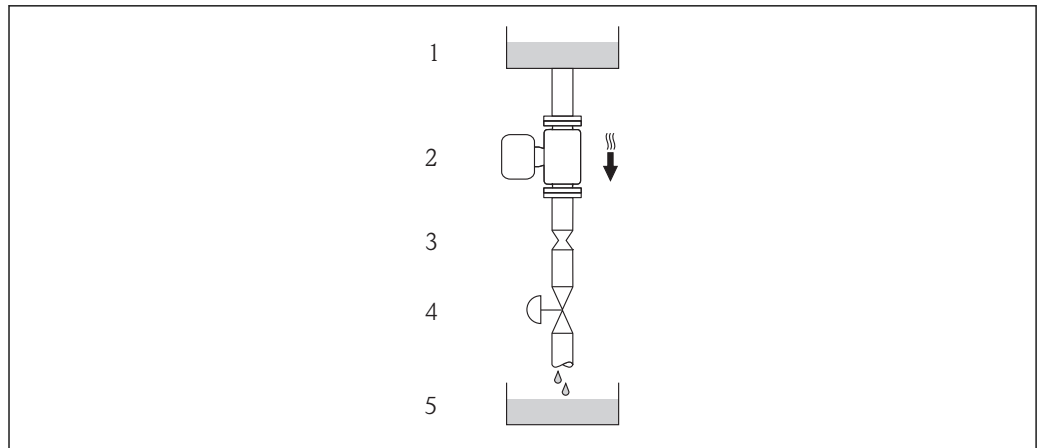

A0015596

17 Installation in a down pipe (e.g. for batching applications)

- 1 Supply tank
- 2 Sensor
- 3 Orifice plate, pipe restriction
- 4 Valve
- 5 Batching tank

DN		Ø orifice plate, pipe restriction	
[mm]	[in]	[mm]	[in]
1	1/24	0.8	0.03
2	1/12	1.5	0.06
4	1/8	3.0	0.12
6	1/4	5.0	0.20

Orientation

The direction of the arrow on the sensor nameplate helps you to install the sensor according to the flow direction (direction of medium flow through the piping).

Orientation		Recommendation
A	Vertical orientation	 A0015591
B	Horizontal orientation, transmitter head up	 A0015589
C	Horizontal orientation, transmitter head down	 A0015590
D	Horizontal orientation, transmitter head at side	 A0015592

- 1) Applications with low process temperatures may decrease the ambient temperature. To maintain the minimum ambient temperature for the transmitter, this orientation is recommended.
- 2) Applications with high process temperatures may increase the ambient temperature. To maintain the maximum ambient temperature for the transmitter, this orientation is recommended.

Inlet and outlet runs

No special precautions need to be taken for fittings which create turbulence, such as valves, elbows or T-pieces, as long as no cavitation occurs → 48.

Special mounting instructions

Rupture disk

Make sure that the function and operation of the rupture disk is not impeded through the installation of the device. The position of the rupture disk is indicated on a sticker beside it. For additional information that is relevant to the process → 48.

The existing connecting nozzles are not intended for the purpose of rinsing or pressure monitoring, but instead serve as the mounting location for the rupture disk.

In the internal thread of the rupture disk a discharge device can be screwed to drain the leaking medium in case of a failure of the rupture disk.

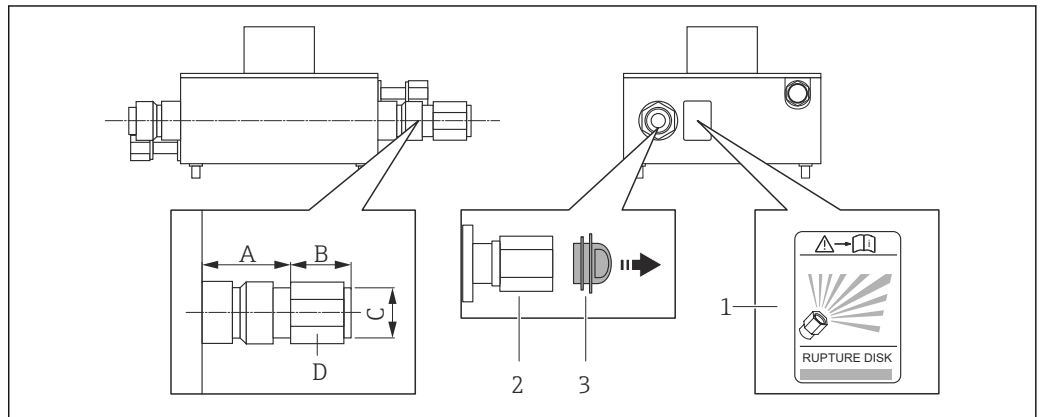

A0019637

- 1 Rupture disk label
- 2 Rupture disk with 1/2" NPT internal thread with 1" width across flat
- 3 Transport protection

DN		A		B		C	D
[mm]	[in]	[mm]	[in]	[mm]	[in]	[in]	[in]
1...6	1/24 to 1/4	33	1.3	Approx. 42	Approx. 1.65	1/2 NPT	AF 1

Wall mounting



Incorrect sensor mounting

Risk of injury if measuring tube breaks

- ▶ The sensor should never be installed in a pipe in a way that it is freely suspended
- ▶ Using the base plate, mount the sensor directly on the floor, wall or ceiling.
- ▶ Support the sensor on a securely mounted support base (e.g. angle bracket).

The following mounting versions are recommended for the installation.

Vertical

- Mounted directly on a wall using the base plate, or
- Device supported on an angle bracket mounted on the wall

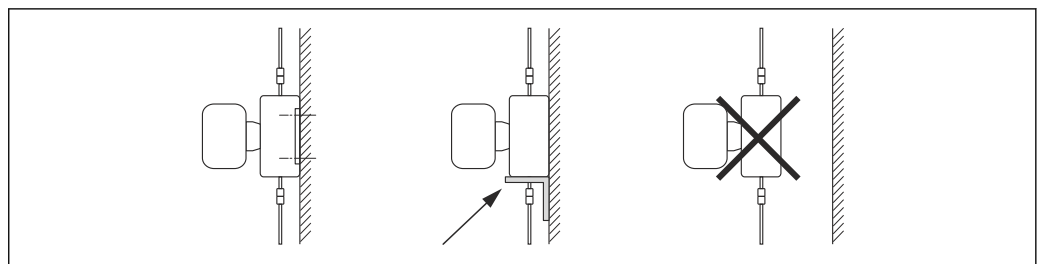

A0019631

Horizontal

Device standing on a solid support base

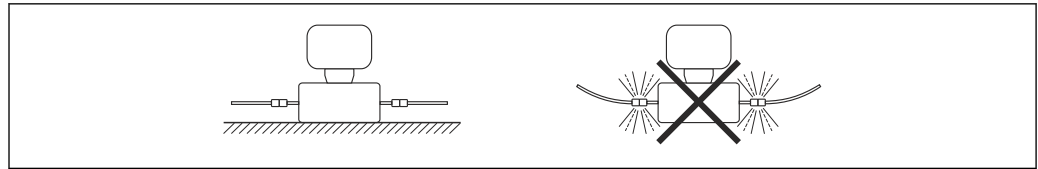

A0019632

Mounting plate

The universal mounting plate can be used to affix or place the unit on a flat surface (order code for "Accessories", option PA).

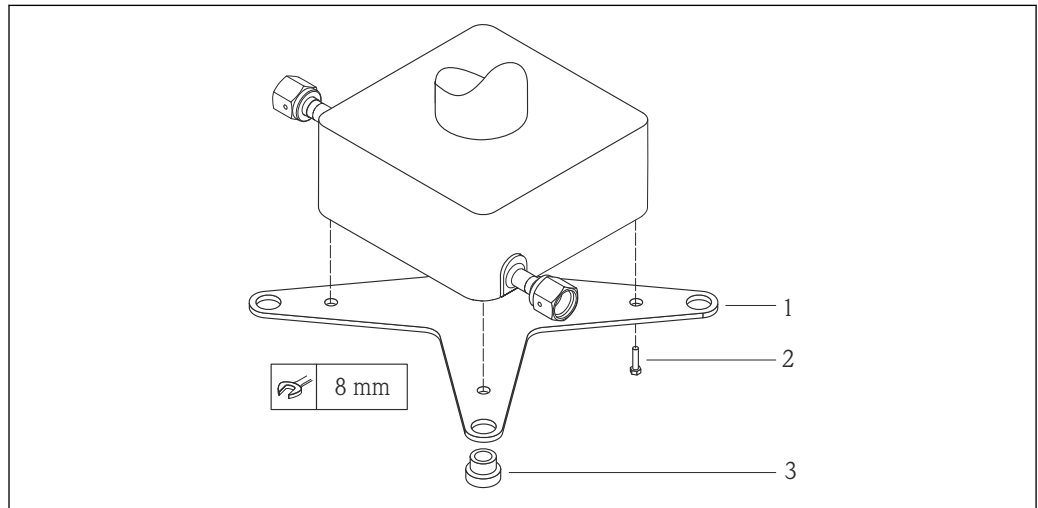

A0019768

18 Mounting kit for Cubemass mounting plate

- 1 1 x Cubemass mounting plate
- 2 4 x screw M5 x 8
- 3 4 x grommet

Zero point adjustment

All measuring devices are calibrated in accordance with state-of-the-art technology. Calibration takes place under reference conditions → 35. Therefore, a zero point adjustment in the field is generally not required.

Experience shows that zero point adjustment is advisable only in special cases:

- To achieve maximum measuring accuracy even with low flow rates
- Under extreme process or operating conditions (e.g. very high process temperatures or very high-viscosity fluids).

Mounting Safety Barrier Promass 100

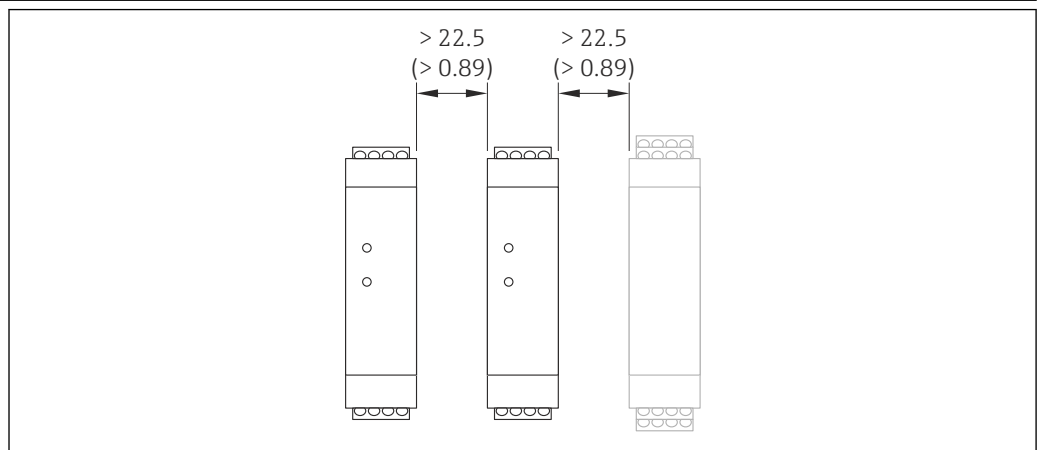

A0016894

19 Minimum distance between additional Safety Barrier Promass 100 or other modules. Engineering unit mm (in)

Environment

Ambient temperature range	Measuring device	
	Non-Ex	-40 to +60 °C (-40 to +140 °F)
	Ex na, NI version	-40 to +60 °C (-40 to +140 °F)
	Ex ia, IS version	<ul style="list-style-type: none"> ■ -40 to +60 °C (-40 to +140 °F) ■ -50 to +60 °C (-58 to +140 °F) (order code for "Test, certificate", option JM)
Readability of the local display		-20 to +60 °C (-4 to +140 °F) The readability of the display may be impaired at temperatures outside the temperature range.
Safety Barrier Promass 100		-40 to +60 °C (-40 to +140 °F)

- ▶ If operating outdoors:
Avoid direct sunlight, particularly in warm climatic regions.

 Weather protection covers can be ordered from Endress+Hauser: see "Accessories" section

Temperature tables

In the following tables, the following interdependencies between the maximum medium temperature T_m for T6 to T1 and the maximum ambient temperature T_a apply when operating the device in hazardous areas.

Ex ia, cCSA_{US} IS

SI units

Order code for "Housing"	T_a [°C]	T6 [85 °C]	T5 [100 °C]	T4 [135 °C]	T3 [200 °C]	T2 [300 °C]	T1 [450 °C]
Option A "Compact coated alu"	35	50	85	120	150 ¹⁾	150 ²⁾	150 ²⁾
Option B "Compact hygienic, stainless"	50	-	85	120	150 ¹⁾	150 ²⁾	150 ²⁾
	60	-	-	120	150 ¹⁾	150 ²⁾	150 ²⁾
Option C "Ultra-compact, hygienic, stainless"	35	50	85	120	150 ¹⁾	150 ²⁾	150 ²⁾
	45	-	85	120	150 ¹⁾	150 ²⁾	150 ²⁾
	50	-	-	120	150 ¹⁾	150 ²⁾	150 ²⁾

- 1) The following applies for specified sensors with a maximum medium temperature $T_m = 205$ °C: $T_m = 170$ °C
- 2) The following applies for specified sensors with a maximum medium temperature $T_m = 205$ °C: $T_m = 205$ °C

US units

Order code for "Housing"	T_a [°F]	T6 [185 °F]	T5 [212 °F]	T4 [275 °F]	T3 [392 °F]	T2 [572 °F]	T1 [842 °F]
Option A "Compact coated alu"	95	122	185	248	302 ¹⁾	302 ²⁾	302 ²⁾
Option B "Compact hygienic, stainless"	122	-	185	248	302 ¹⁾	302 ²⁾	302 ²⁾
	140	-	-	248	302 ¹⁾	302 ²⁾	302 ²⁾
Option C "Ultra-compact, hygienic, stainless"	95	122	185	248	302 ¹⁾	302 ²⁾	302 ²⁾
	113	-	185	248	302 ¹⁾	302 ²⁾	302 ²⁾
	122	-	-	248	302 ¹⁾	302 ²⁾	302 ²⁾

- 1) The following applies for specified sensors with a maximum medium temperature $T_m = 401$ °F: $T_m = 338$ °F
- 2) The following applies for specified sensors with a maximum medium temperature $T_m = 401$ °F: $T_m = 401$ °F

Ex nA, cCSA_{US} NI

SI units

Order code for "Housing"	T _a [°C]	T6 [85 °C]	T5 [100 °C]	T4 [135 °C]	T3 [200 °C]	T2 [300 °C]	T1 [450 °C]
Option A "Compact coated alu"	35	50	85	120	150 ¹⁾	150 ²⁾	150
Option B "Compact hygienic, stainless"	50	-	85	120	150	150	150
	60	-	-	120	150	150	150
Option C "Ultra-compact, hygienic, stainless"	50	-	85	120	150	150	150
	60	-	-	120	150	150	150

- 1) The following applies for specified sensors with a maximum medium temperature T_m = 205 °C: T_m = 170 °C
- 2) The following applies for specified sensors with a maximum medium temperature T_m = 205 °C: T_m = 205 °C

US units

Order code for "Housing"	T _a [°F]	T6 [185 °F]	T5 [212 °F]	T4 [275 °F]	T3 [392 °F]	T2 [572 °F]	T1 [842 °F]
Option A "Compact coated alu"	95	122	185	248	302 ¹⁾	302 ²⁾	302
Option B "Compact hygienic, stainless"	122	-	185	248	302	302	302
	140	-	-	248	302	302	302
Option C "Ultra-compact, hygienic, stainless"	122	-	185	248	302	302	302
	140	-	-	248	302	302	302

- 1) The following applies for specified sensors with a maximum medium temperature T_m = 401 °F: T_m = 338 °F
- 2) The following applies for specified sensors with a maximum medium temperature T_m = 401 °F: T_m = 401 °F

Explosion hazards arising from gas and dust

Determining the temperature class and surface temperature with the temperature table

- In the case of gas: Determine the temperature class as a function of the ambient temperature T_a and the medium temperature T_m.
- In the case of dust: Determine the maximum surface temperature as a function of the maximum ambient temperature T_a and the maximum medium temperature T_m.

Example

- Measured maximum ambient temperature: T_{ma} = 47 °C
- Measured maximum medium temperature: T_{mm} = 108 °C



	T _a [°C]	T6 [85 °C]	T5 [100 °C]	T4 [135 °C]	T3 [200 °C]	T2 [300 °C]	T1 [450 °C]
	35	50	85	120	140	140	140
	50	-	85	120	140	140	140
	60	-	-	120	140	140	140
	35	50	85	120	140	140	140
	45	-	85	120	140	140	140
	50	-	-	120	140	140	140

A0019758

20 Procedure for determining the maximum surface temperature

- 1. Select device (optional).

2. In the column for the maximum ambient temperature T_a select the temperature that is immediately greater than or equal to the measured maximum ambient temperature T_{ma} that is present.
 - ↳ $T_a = 50\text{ °C}$.
The row showing the maximum medium temperature is determined.
3. Select the maximum medium temperature T_m of this row, which is larger or equal to the measured maximum medium temperature T_{mm} .
 - ↳ The column with the temperature class for gas is determined: $108\text{ °C} \leq 120\text{ °C} \rightarrow T4$.
4. The maximum temperature of the temperature class determined corresponds to the maximum surface temperature for dust: $T4 = 135\text{ °C}$

Storage temperature	-40 to +80 °C (-40 to +176 °F), preferably at +20 °C (+68 °F) (standard version) -50 to +80 °C (-58 to +176 °F) (Order code for "Test, certificate", option JM)
Climate class	DIN EN 60068-2-38 (test Z/AD)
Degree of protection	<p>Transmitter and sensor</p> <ul style="list-style-type: none"> ■ As standard: IP66/67, type 4X enclosure ■ With the order code for "Sensor options", option CM: IP69K can also be ordered ■ When housing is open: IP20, type 1 enclosure ■ Display module: IP20, type 1 enclosure <p>Safety Barrier Promass 100 IP20</p>
Vibration resistance	<p>Compact version</p> <ul style="list-style-type: none"> ■ Vibration, sinusoidal according to IEC 60068-2-6 <ul style="list-style-type: none"> - 2 to 8.4 Hz, 3.5 mm peak - 8.4 to 2 000 Hz, 1 g peak ■ Vibration broad-band random, according to IEC 60068-2-64 <ul style="list-style-type: none"> - 10 to 200 Hz, 0.003 g²/Hz - 200 to 2 000 Hz, 0.001 g²/Hz - Total: 1.54 g rms
Shock resistance	<p>Compact version</p> <p>Shock, half-sine according to IEC 60068-2-27 6 ms 30 g</p>
Shock resistance	<p>Compact version</p> <p>Rough handling shocks according to IEC 60068-2-31</p>
Interior cleaning	<ul style="list-style-type: none"> ■ Cleaning in place (CIP) ■ Sterilization in place (SIP) <p>Options Oil- and grease-free version for wetted parts, without inspection certificate Order code for "Service", option HA</p>
Electromagnetic compatibility (EMC)	<ul style="list-style-type: none"> ■ Depends on the communication protocol: <ul style="list-style-type: none"> - HART, PROFIBUS DP, Modbus RS485, EtherNet/IP: As per IEC/EN 61326 and NAMUR Recommendation 21 (NE 21) - PROFINET: as per IEC/EN 61326 ■ Complies with emission limits for industry as per EN 55011 (Class A) ■ Device version with PROFIBUS DP: Complies with emission limits for industry as per EN 50170 Volume 2, IEC 61784 <p> The following applies for PROFIBUS DP: If baud rates > 1.5 MBaud, an EMC cable entry must be used and the cable shield must continue as far as the terminal wherever possible.</p> <p> For details, refer to the Declaration of Conformity.</p>

Process

Medium temperature range

Sensor
-50 to +205 °C (-58 to +401 °F)

Seals
For mounting sets with screwed-on connections:
- Viton: -15 to +200 °C (-5 to +392 °F)
- EPDM: -40 to +160 °C (-40 to +320 °F)
- Silicon: -60 to +200 °C (-76 to +392 °F)
- Kalrez: -20 to +275 °C (-4 to +527 °F)

Density 0 to 5 000 kg/m³ (0 to 312 lb/cf)

Pressure-temperature ratings The following pressure-temperature ratings refer to the entire device and not just the process connection.

Flange connection according to EN 1092-1 (DIN 2501)

Order code for "Mounting kit", option PE

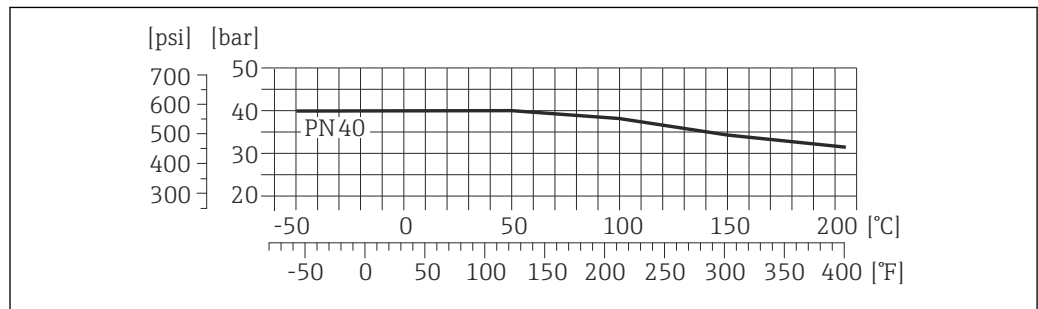

A0027771-EN

☑ 21 With flange material: 1.4539 (904L), Alloy C22; lap joint flanges (not wetted) 1.4404 (316/316L)

Flange connection according to ASME B16.5

Order code for "Mounting kit", option PF, PG

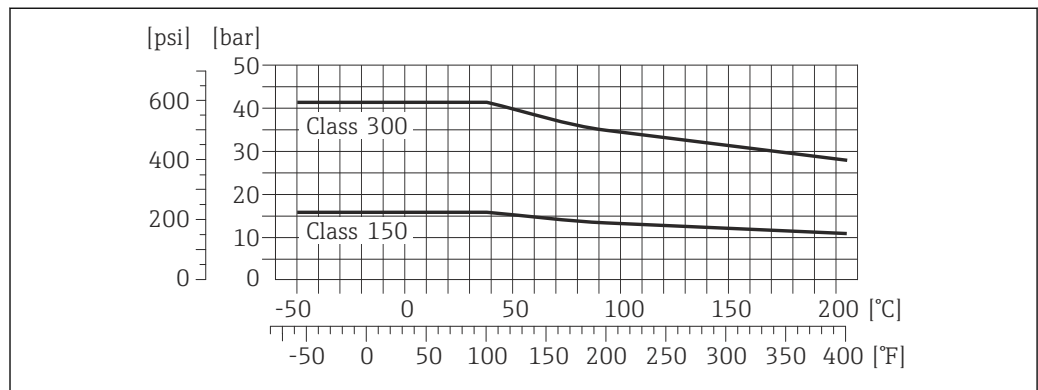

A0027771-EN

☑ 22 With flange material: 1.4539 (904L); lap joint flanges (not wetted) 1.4404 (316/316L)

Flange connection according to JIS B2220

Order code for "Mounting kit", option PH

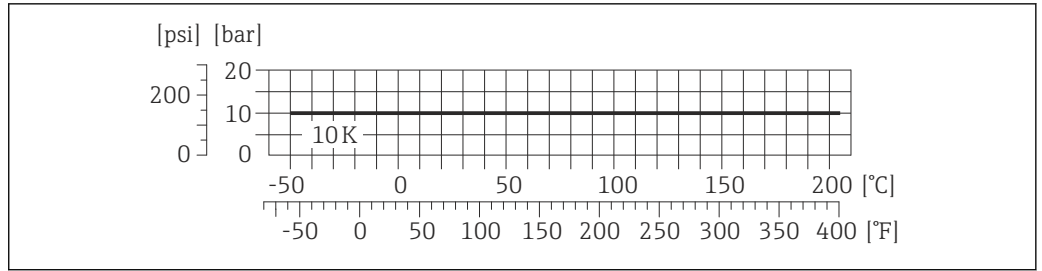

23 With flange material: 1.4539 (904L); lap joint flanges (not wetted): 1.4404 (316/316L)

Process connection 4-VCO-4, ¼ NPTF (DN 1 to 4); 8-VCO-4, ½ NPTF (DN 6)

Order code for "Mounting kit", option PC, PD

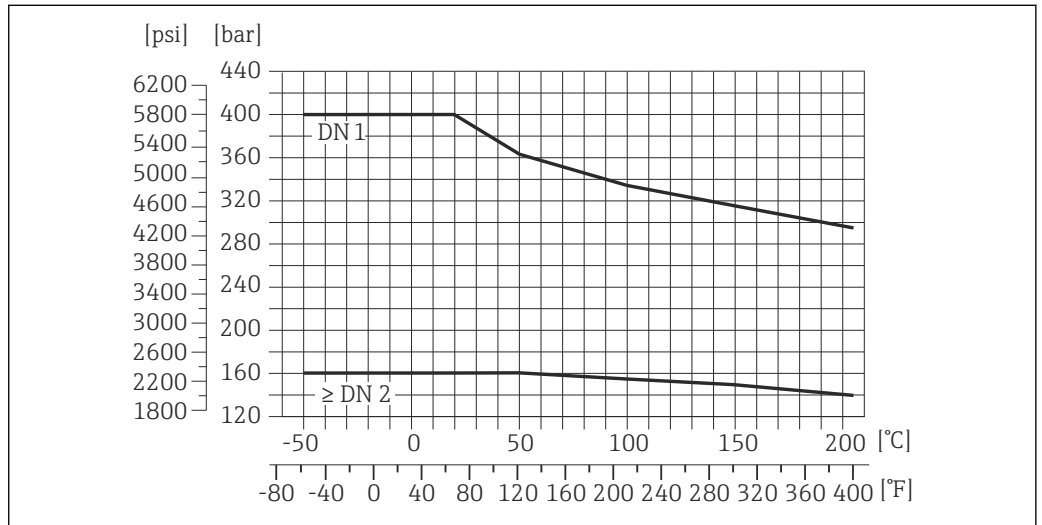

24 4-VCO-4 coupling: 1.4539 (904L); 8-VCO-4 coupling: 1.4539 (904L); NPTF threaded adapter: 1.4539 (904L)

Secondary containment pressure rating

The sensor housing is filled with dry nitrogen and protects the electronics and mechanics inside.

The following secondary containment pressure rating is only valid for a fully welded sensor housing and/or a device equipped with closed purge connections (never opened/as delivered).

DN		Secondary containment pressure rating (designed with a safety factor ≥ 4)		Secondary containment burst pressure	
[mm]	[in]	[bar]	[psi]	[bar]	[psi]
1	¼	40	580	190	2780
2	½	40	580	190	2780

DN		Secondary containment pressure rating (designed with a safety factor ≥ 4)		Secondary containment burst pressure	
[mm]	[in]	[bar]	[psi]	[bar]	[psi]
4	$\frac{1}{8}$	40	580	190	2780
6	$\frac{1}{4}$	40	580	190	2780

i If there is a risk of measuring tube failure due to process characteristics, e.g. with corrosive fluids, we recommend the use of sensors whose secondary containment is equipped with special pressure monitoring connections (order code for "Sensor option", option CH "Purge connection").

With the help of these connections, the fluid collected in the secondary containment can be bled off in the event of tube failure. This is especially important in high-pressure gas applications. These connections can also be used for gas purging (gas detection).

Do not open the purge connections unless the containment can be filled immediately with a dry, inert gas. Use only low gauge pressure to purge. Maximum pressure: 5 bar (72.5 psi).

If a device fitted with purge connections is connected to the purge system, the maximum nominal pressure is determined by the purge system itself or by the device, depending on which component has the lower nominal pressure.

If, on the other hand, the device is fitted with a rupture disk, the rupture disk is decisive for the maximum nominal pressure →  48.

Dimensions:

Rupture disk

To increase the level of safety, a device version with a rupture disk with a triggering pressure of 10 to 15 bar (145 to 217.5 psi) can be used (order code for "Sensor option", option CA "rupture disk"). Special mounting instructions: →  41

Flow limit

Select the nominal diameter by optimizing between the required flow range and permissible pressure loss.

i For an overview of the full scale values for the measuring range, see the "Measuring range" section

- The minimum recommended full scale value is approx. 1/20 of the maximum full scale value
- In most applications, 20 to 50 % of the maximum full scale value can be considered ideal
- A low full scale value must be selected for abrasive media (such as liquids with entrained solids): flow velocity < 1 m/s (< 3 ft/s).
- For gas measurement the following rules apply:
 - The flow velocity in the measuring tubes should not exceed half the sound velocity (0.5 Mach)
 - The maximum mass flow depends on the density of the gas: formula

Pressure loss

i To calculate the pressure loss, use the *Applicator* sizing tool →  73

System pressure

It is important that cavitation does not occur, or that gases entrained in the liquids do not outgas. This is prevented by means of a sufficiently high system pressure.

For this reason, the following mounting locations are recommended:

- At the lowest point in a vertical pipe
- Downstream from pumps (no danger of vacuum)

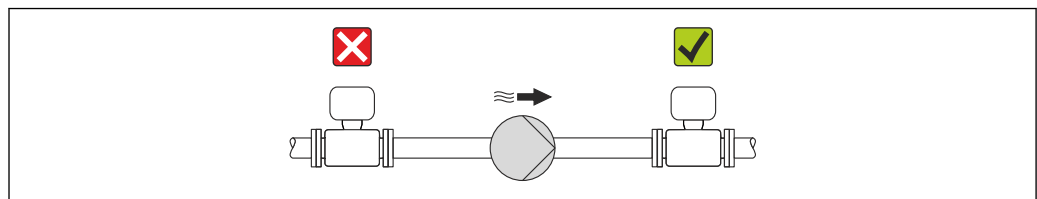

A0015594

Thermal insulation

In the case of some fluids, it is important that the heat radiated from the sensor to the transmitter is kept to a minimum. A wide range of materials can be used for the required insulation.

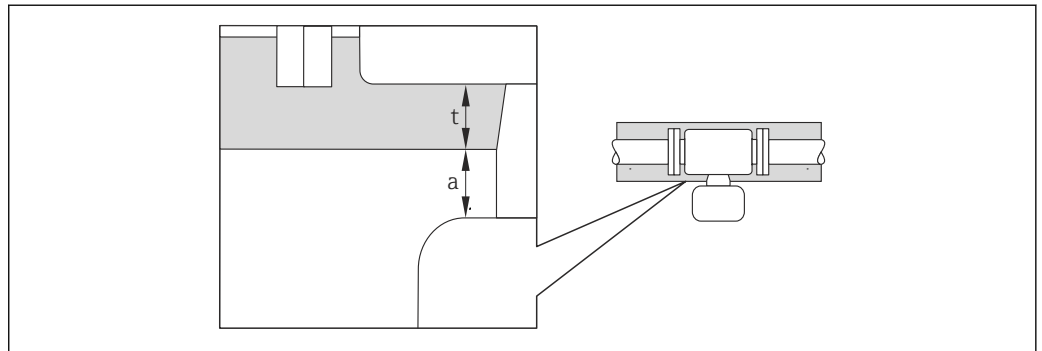

A0019919

- a* Minimum distance to insulation
- t* maximum Insulation thickness

The minimum distance between the transmitter housing and the insulation is 10 mm (0.39 in) so that the transmitter head remains completely exposed.

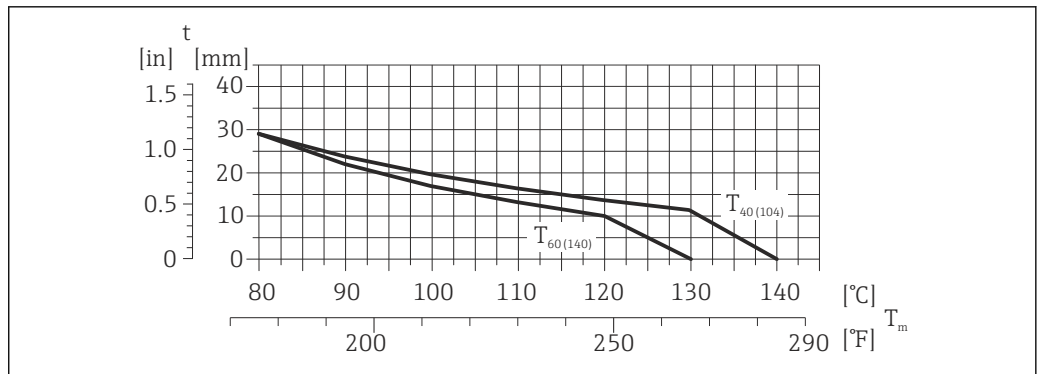

A0023173

25 Maximum recommended insulation thickness depending on the temperature of the medium and the ambient temperature

- t* Insulation thickness
- T_m Medium temperature
- $T_{40(104)}$ Maximum recommended insulation thickness at an ambient temperature of $T_a = 40^\circ\text{C}$ (104°F)
- $T_{60(140)}$ Maximum recommended insulation thickness at an ambient temperature of $T_a = 60^\circ\text{C}$ (140°F)

NOTICE

Danger of overheating with insulation

- ▶ Ensure that the temperature at the lower end of the transmitter housing does not exceed 80°C (176°F)

NOTICE

The insulation can also be thicker than the maximum recommended insulation thickness.

Prerequisite:

- ▶ Ensure that convection takes place on a sufficiently large scale at the transmitter neck.
- ▶ Ensure that a sufficiently large area of the housing support remains exposed. The uncovered part serves as a radiator and protects the electronics from overheating and excessive cooling.

Heating

Some fluids require suitable measures to avoid loss of heat at the sensor.

Heating options

- Electrical heating, e.g. with electric band heaters
- Via pipes carrying hot water or steam
- Via heating jackets

NOTICE

Danger of overheating when heating

- ▶ Ensure that the temperature at the lower end of the transmitter housing does not exceed 80 °C (176 °F).
- ▶ Ensure that convection takes place on a sufficiently large scale at the transmitter neck.
- ▶ Ensure that a sufficiently large area of the housing support remains exposed. The uncovered part serves as a radiator and protects the electronics from overheating and excessive cooling.

Vibrations

The high oscillation frequency of the measuring tubes ensures that the correct operation of the measuring system is not influenced by plant vibrations.

Mechanical construction

Dimensions in SI units

Compact version

Order code for "Housing", option A "Compact coated alu"

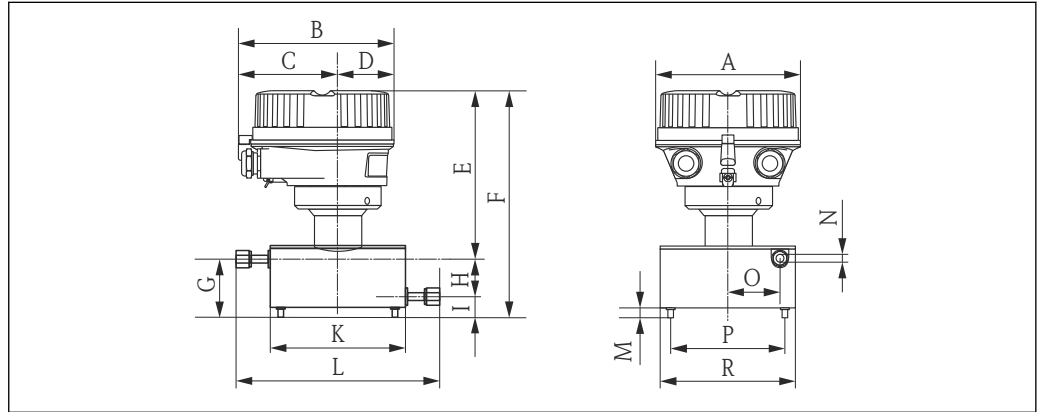

A0019431

DN [mm]	A [mm]	B [mm]	C [mm]	D [mm]	E ¹⁾ [mm]	F ¹⁾ [mm]	G [mm]	H [mm]
1	136	147.5	93.5	54	162	214	52	30
2	136	147.5	93.5	54	162	214	52	30
4	136	147.5	93.5	54	162	214	52	30
6	136	147.5	93.5	54	162	214	52	30

1) If using a display, order code for "Display; Operation", option B: values +28 mm

DN [mm]	I [mm]	K [mm]	L [mm]	M [mm]	N [mm]	O [mm]	P [mm]	R [mm]
1	22	120	175	10	1.3	40	90	120
2	22	120	175	10	2	40	90	120
4	22	120	175	10	3.9	40	90	120
6	22	120	175	10	5.35	40	90	120

Order code for "Housing", option B "Compact hygienic, stainless"

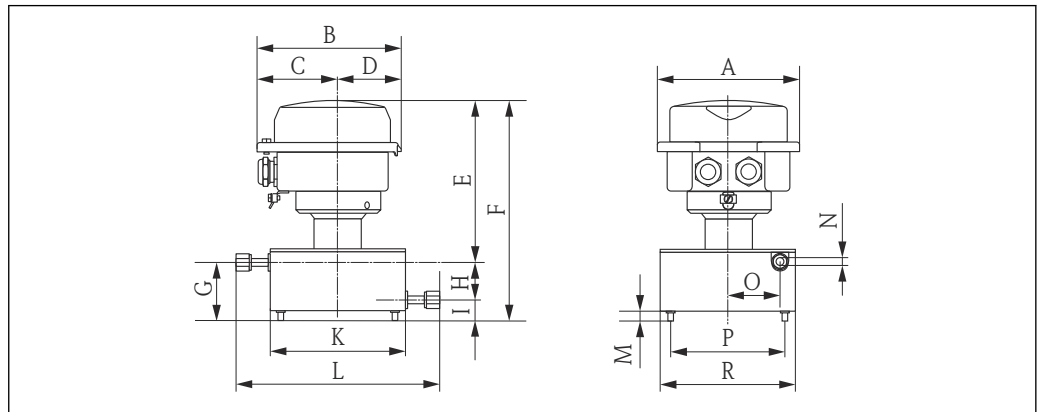

A0019432

DN [mm]	A [mm]	B [mm]	C [mm]	D [mm]	E ¹⁾ [mm]	F ¹⁾ [mm]	G [mm]	H [mm]
1	133.5	136.8	78	58.8	158	210	52	30
2	133.5	136.8	78	58.8	158	210	52	30
4	133.5	136.8	78	58.8	158	210	52	30
6	133.5	136.8	78	58.8	158	210	52	30

1) If using a display, order code for "Display; Operation", option B: values +14 mm

DN [mm]	I [mm]	K [mm]	L [mm]	M [mm]	N [mm]	O [mm]	P [mm]	R [mm]
1	22	120	175	10	1.3	40	90	120
2	22	120	175	10	2	40	90	120
4	22	120	175	10	3.9	40	90	120
6	22	120	175	10	5.35	40	90	120

Order code for "Housing", option C "Ultra-compact hygienic, stainless"

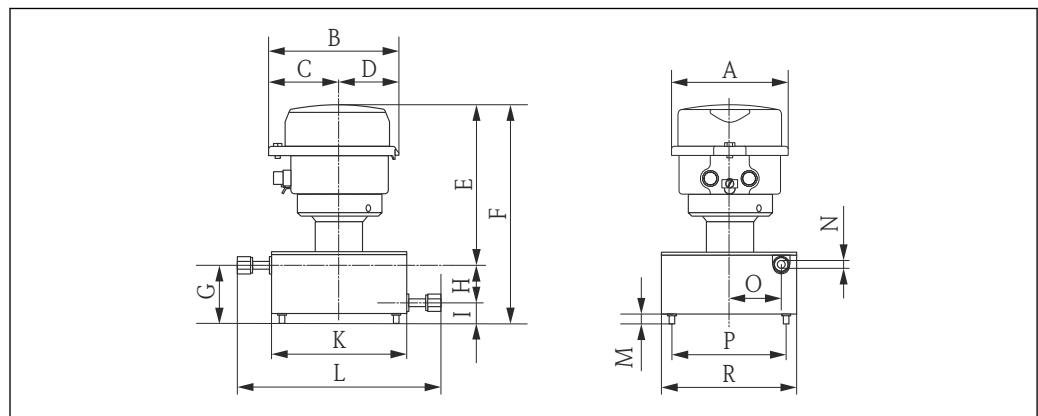

A0019433

DN [mm]	A [mm]	B [mm]	C [mm]	D [mm]	E ¹⁾ [mm]	F ¹⁾ [mm]	G [mm]	H [mm]
1	111.4	123.6	67.7	55.9	157	209	52	30
2	111.4	123.6	67.7	55.9	157	209	52	30
4	111.4	123.6	67.7	55.9	157	209	52	30
6	111.4	123.6	67.7	55.9	157	209	52	30

1) If using a display, order code for "Display; Operation", option B: values +14 mm

DN [mm]	I [mm]	K [mm]	L [mm]	M [mm]	N [mm]	O [mm]	P [mm]	R [mm]
1	22	120	175	10	1.3	40	90	120
2	22	120	175	10	2	40	90	120
4	22	120	175	10	3.9	40	90	120
6	22	120	175	10	5.35	40	90	120

Cable glands

VCO coupling

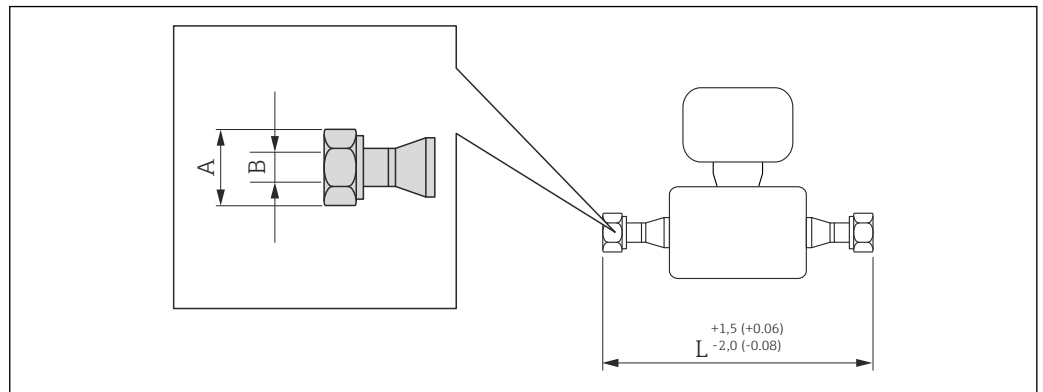

A0015624

26 Engineering unit mm (in)

4-VCO-4			
1.4539 (904L): order code for "Process connection", option HAW			
DN [mm]	A [in]	B [mm]	L [mm]
1	1 ¹ / ₁₆	12.5	175
2	1 ¹ / ₁₆	12.5	175
4	1 ¹ / ₁₆	12.5	175

8-VCO-4			
1.4404 (316/316L): order code for "Process connection", option CVS			
DN [mm]	A [in]	B [mm]	L [mm]
6	1	20	175

Adapter

Adapter, DN 15 flange to VCO

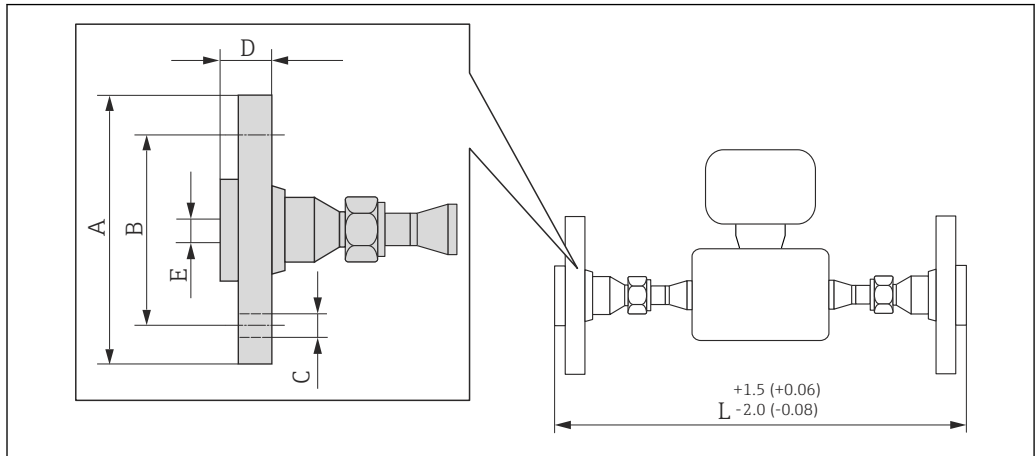

A0019725

27 Engineering unit mm (in)

Adapter, DN 15 flange according to EN 1092-1 (DIN 2501): PN 40 1.4539 (904L): order code for "Accessories", option PE						
DN [mm]	A [mm]	B [mm]	C [mm]	D [mm]	E [mm]	L [mm]
1...6	95	65	4 × Ø14	28	17.3	278

DN 1 to 4 with 4-VCO-4, DN 6 with 8-VCO-4
Lap joint flanges (not wetted) made of stainless steel 1.4404 (316/316L)
Sealing sets: order code for "Accessories enclosed", option **P1** (Viton), **P2** (EPDM), **P3** (silicone), **P4** (Kalrez)

Adapter, flange according to ASME B16.5: Class 150 1.4539 (904L): order code for "Accessories", option PF						
DN [mm]	A [mm]	B [mm]	C [mm]	D [mm]	E [mm]	L [mm]
1...6	90.0	60.3	4 × Ø15.7	17.7	15.7	278

DN 1 to 4 with 4-VCO-4, DN 6 with 8-VCO-4
Lap joint flanges (not wetted) made of stainless steel 1.4404 (316/316L)
Sealing sets: order code for "Accessories enclosed", option **P1** (Viton), **P2** (EPDM), **P3** (silicone), **P4** (Kalrez)

Adapter, flange according to ASME B16.5: Class 300 1.4539 (904L): order code for "Accessories", option PG						
DN [mm]	A [mm]	B [mm]	C [mm]	D [mm]	E [mm]	L [mm]
1...6	95.0	60.3	4 × Ø15.7	20.7	15.7	278

DN 1 to 4 with 4-VCO-4, DN 6 with 8-VCO-4
Lap joint flanges (not wetted) made of stainless steel 1.4404 (316/316L)
Sealing sets: order code for "Accessories enclosed", option **P1** (Viton), **P2** (EPDM), **P3** (silicone), **P4** (Kalrez)

Adapter, JIS B2220 flange: 10K 1.4539 (904L): order code for "Accessories", option PH						
DN [mm]	A [mm]	B [mm]	C [mm]	D [mm]	E [mm]	L [mm]
1 to 6	95	70	4 × Ø15	28	15.0	278
DN 1 to 4 with 4-VCO-4, DN 6 with 8-VCO-4 Lap joint flanges (not wetted) made of stainless steel 1.4404 (316/316L) Sealing sets: order code for "Accessories enclosed", option P1 (Viton), P2 (EPDM), P3 (silicone), P4 (Kalrez)						

Adapter, NPTF to VCO

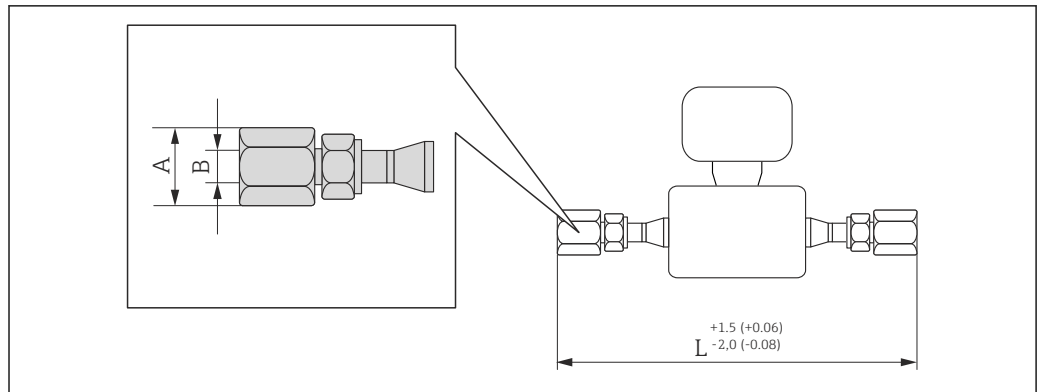

A0019724

28 Engineering unit mm (in)

Adapter, 1/4" NPTF to 4-VCO-4 1.4539 (904L): order code for "Accessories", option PC			
DN [mm]	A [in]	B [in]	L [mm]
1...4	3/4	1/4 NPT	246

Sealing sets: order code for "Accessories enclosed", option P1 (Viton), P2 (EPDM), P3 (silicone), P4 (Kalrez)

Adapter, 1/4" NPTF to 8-VCO-4 1.4539 (904L): order code for "Accessories", option PD			
DN [mm]	A [in]	B [in]	L [mm]
6	1 1/16	1/2 NPT	246

Sealing sets: order code for "Accessories enclosed", option P1 (Viton), P2 (EPDM), P3 (silicone), P4 (Kalrez)

Safety Barrier Promass 100

Top-hat rail EN 60715:

- TH 35 x 7.5
- TH 35 x 15

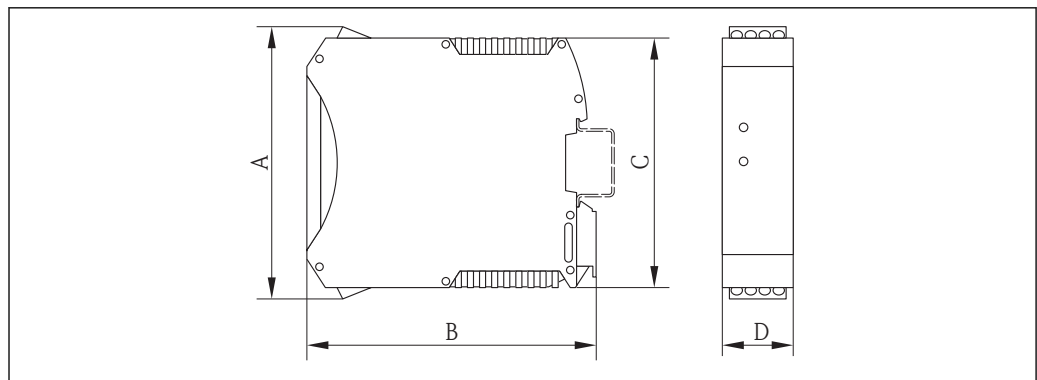

A0016777

A [mm]	B [mm]	C [mm]	D [mm]
108	114.5	99	22.5

Accessories

Purge connections / secondary containment monitoring

Order code for "Sensor options", option CH

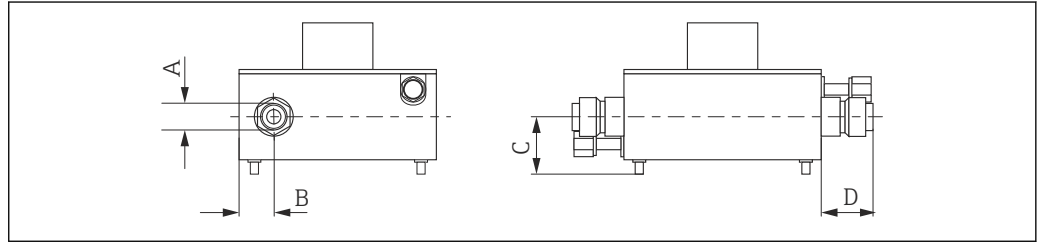

A0012335

DN	A	B	C	D
[mm]	[in]	[mm]	[mm]	[mm]
1 to 6	½ NPT	30	Approx. 37	33

Dimensions in US units

Compact version

Order code for "Housing", option A "Compact coated alu"

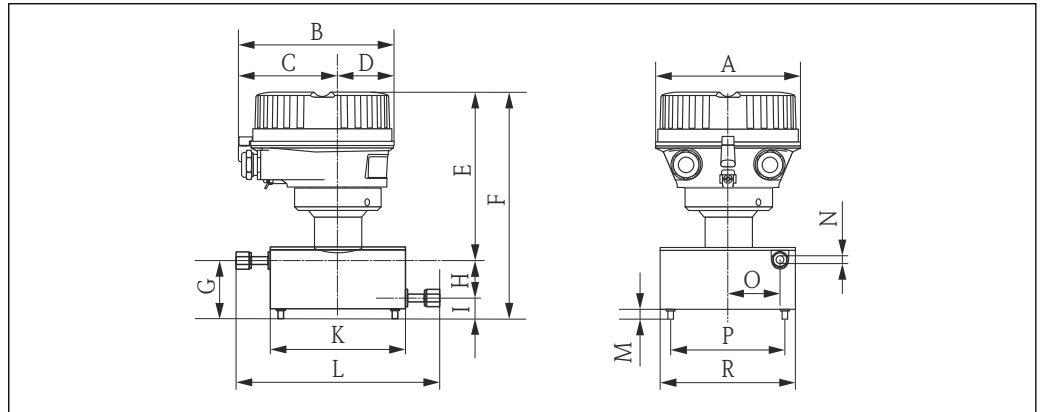

A0019431

DN	A	B	C	D	E ¹⁾	F ¹⁾	G	H
[in]	[in]	[in]	[in]	[in]	[in]	[in]	[in]	[in]
½ ₂₄	5.35	5.81	3.68	2.13	6.38	8.43	2.05	1.18
½ ₁₂	5.35	5.81	3.68	2.13	6.38	8.43	2.05	1.18
½ ₈	5.35	5.81	3.68	2.13	6.38	8.43	2.05	1.18
¼	5.35	5.81	3.68	2.13	6.38	8.43	2.05	1.18

1) If using a display, order code for "Display; Operation", option B: values +1.1 in

DN	I	K	L	M	N	O	P	R
[in]	[in]	[in]	[in]	[in]	[in]	[in]	[in]	[in]
½ ₂₄	0.87	4.72	6.89	0.39	0.051	1.57	3.54	4.72
½ ₁₂	0.87	4.72	6.89	0.39	0.08	1.57	3.54	4.72
½ ₈	0.87	4.72	6.89	0.39	0.15	1.57	3.54	4.72
¼	0.87	4.72	6.89	0.39	0.21	1.57	3.54	4.72

Order code for "Housing", option B "Compact hygienic, stainless"

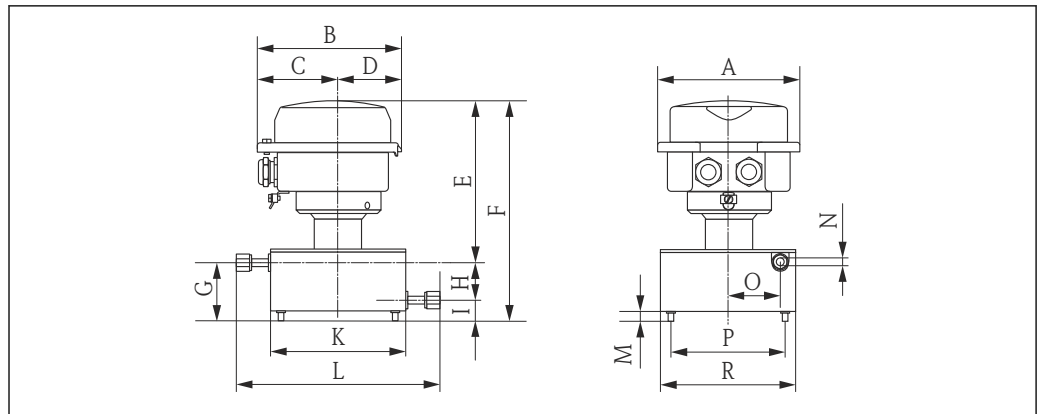

A0019432

DN [in]	A [in]	B [in]	C [in]	D [in]	E ¹⁾ [in]	F ¹⁾ [in]	G [in]	H [in]
1/24	5.26	5.39	3.07	2.31	6.22	8.27	2.05	1.18
1/12	5.26	5.39	3.07	2.31	6.22	8.27	2.05	1.18
1/8	5.26	5.39	3.07	2.31	6.22	8.27	2.05	1.18
1/4	5.26	5.39	3.07	2.31	6.22	8.27	2.05	1.18

1) If using a display, order code for "Display; Operation", option B: values +0.55 in

DN [in]	I [in]	K [in]	L [in]	M [in]	N [in]	O [in]	P [in]	R [in]
1/24	0.87	4.72	6.89	0.39	0.051	1.57	3.54	4.72
1/12	0.87	4.72	6.89	0.39	0.08	1.57	3.54	4.72
1/8	0.87	4.72	6.89	0.39	0.15	1.57	3.54	4.72
1/4	0.87	4.72	6.89	0.39	0.21	1.57	3.54	4.72

Order code for "Housing", option C "Ultra-compact hygienic, stainless"

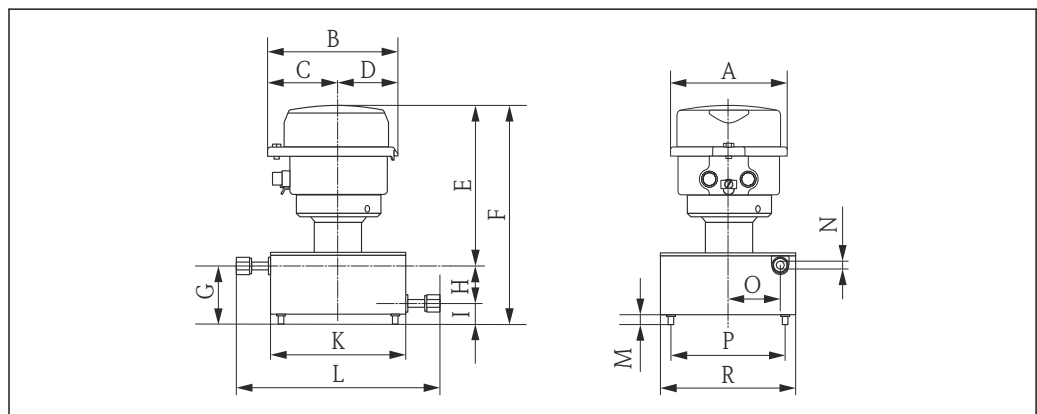

A0019433

DN	A [in]	B [in]	C [in]	D [in]	E ¹⁾ [in]	F ¹⁾ [in]	G [in]	H [in]
1/24	4.39	4.87	2.67	2.2	6.18	8.23	2.05	1.18
1/12	4.39	4.87	2.67	2.2	6.18	8.23	2.05	1.18

DN	A [in]	B [in]	C [in]	D [in]	E ¹⁾ [in]	F ¹⁾ [in]	G [in]	H [in]
$\frac{1}{8}$	4.39	4.87	2.67	2.2	6.18	8.23	2.05	1.18
$\frac{1}{4}$	4.39	4.87	2.67	2.2	6.18	8.23	2.05	1.18

1) If using a display, order code for "Display; Operation", option B: values +0.55 in

DN [in]	I [in]	K [in]	L [in]	M [in]	N [in]	O [in]	P [in]	R [in]
$\frac{1}{24}$	0.87	4.72	6.89	0.39	0.051	1.57	3.54	4.72
$\frac{1}{12}$	0.87	4.72	6.89	0.39	0.08	1.57	3.54	4.72
$\frac{1}{8}$	0.87	4.72	6.89	0.39	0.15	1.57	3.54	4.72
$\frac{1}{4}$	0.87	4.72	6.89	0.39	0.21	1.57	3.54	4.72

Cable glands

VCO coupling

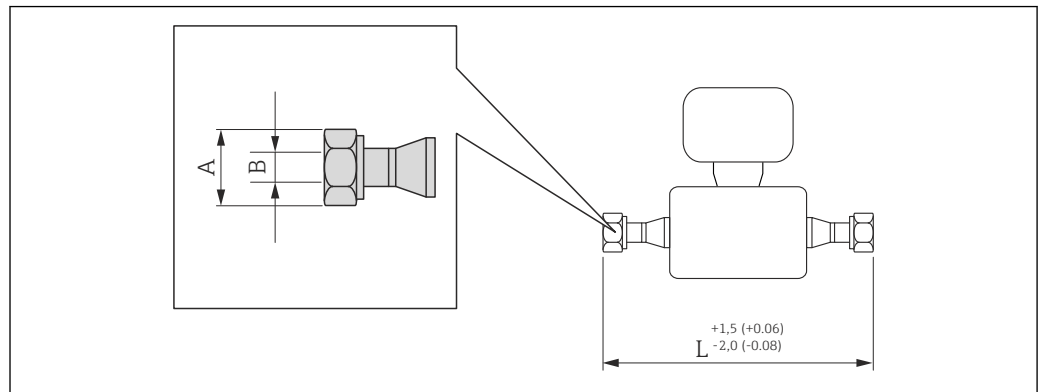

A0015624

29 Engineering unit mm (in)

4-VCO-4 1.4539 (904L): order code for "Process connection", option HAW			
DN [mm]	A [in]	B [in]	L [in]
1/24	11/16	0.49	6.89
1/12	11/16	0.49	6.89
1/8	11/16	0.49	6.89

8-VCO-4 1.4404 (316/316L): order code for "Process connection", option CVS			
DN [mm]	A [in]	B [in]	L [in]
1/4	1	0.79	6.89

Adapter

Adapter, DN 15 flange to VCO

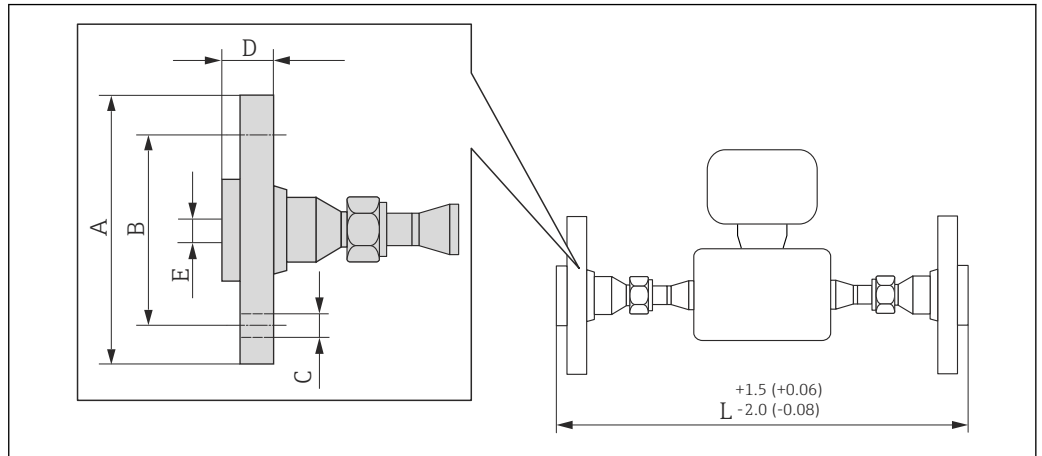

A0019725

30 Engineering unit mm (in)

Adapter, flange according to ASME B16.5: Class 150						
1.4539 (904L): order code for "Accessories", option PF						
DN [in]	A [in]	B [in]	C [in]	D [in]	E [in]	L [in]
1/24 to 1/4	3.54	2.37	4 × Ø0.62	0.7	0.62	10.94
DN 1/24 to 1/8 with 4-VCO-4, DN 1/4 with 8-VCO-4 Lap joint flanges (not wetted) made of stainless steel 1.4404 (316/316L) Sealing sets: order code for "Accessories enclosed", option P1 (Viton), P2 (EPDM), P3 (silicone), P4 (Kalrez)						

Adapter, flange according to ASME B16.5: Class 300						
1.4539 (904L): order code for "Accessories", option PG						
DN [in]	A [in]	B [in]	C [in]	D [in]	E [in]	L [in]
1/24 to 1/4	3.74	2.37	4 × Ø0.62	0.81	0.62	10.94
DN 1/24 to 1/8 with 4-VCO-4, DN 1/4 with 8-VCO-4 Lap joint flanges (not wetted) made of stainless steel 1.4404 (316/316L) Sealing sets: order code for "Accessories enclosed", option P1 (Viton), P2 (EPDM), P3 (silicone), P4 (Kalrez)						

Adapter, NPTF to VCO

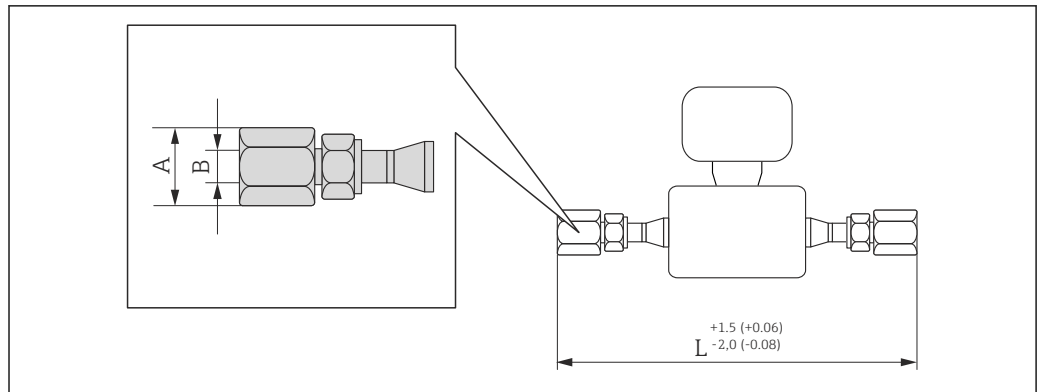

A0019724

31 Engineering unit mm (in)

Adapter, 1/4" NPTF to 4-VCO-4 1.4539 (904L): order code for "Accessories", option PC			
DN [mm]	A [in]	B [in]	L [in]
1/24 to 1/8	3/4	1/4 NPT	9.69
Sealing sets: order code for "Accessories enclosed", option P1 (Viton), P2 (EPDM), P3 (silicone), P4 (Kalrez)			

Adapter, 1/4" NPTF to 8-VCO-4 1.4539 (904L): order code for "Accessories", option PD			
DN [mm]	A [in]	B [in]	L [in]
1/4	1 1/16	1/2 NPT	9.69
Sealing sets: order code for "Accessories enclosed", option P1 (Viton), P2 (EPDM), P3 (silicone), P4 (Kalrez)			

Safety Barrier Promass 100

Top-hat rail EN 60715:

- TH 35 x 7.5
- TH 35 x 15

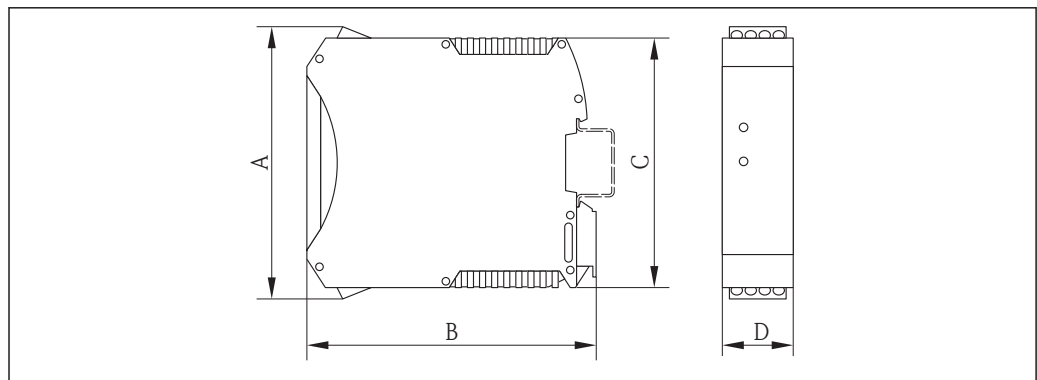

A0016777

A [in]	B [in]	C [in]	D [in]
4.25	4.51	3.9	0.89

Accessories

Purge connections / secondary containment monitoring

Order code for "Sensor options", option CH

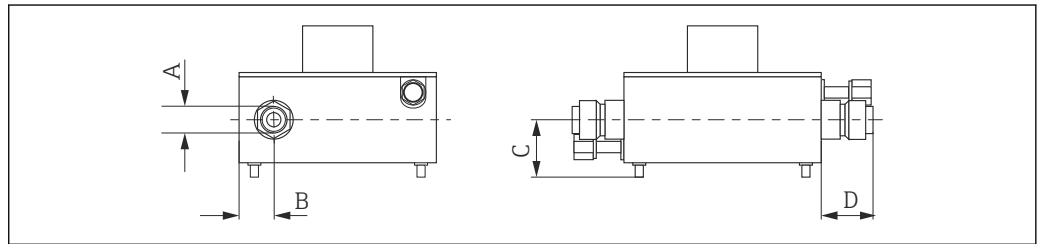

A0012335

DN	A	B	C	D
[in]	[in]	[in]	[in]	[in]
1/24 to 1/4	1/2 NPT	1.18	Approx. 1.46	1.30

Weight

Compact version

Weight in SI units

All values (weight) refer to devices with EN/DIN PN 40 flanges. Weight information in [kg].

DN [mm]	Weight [kg]
1	3.5
2	3.5
4	3.5
6	3.5

Weight in US units

All values (weight) refer to devices with EN/DIN PN 40 flanges. Weight information in [lbs].

DN [in]	Weight [lbs]
1/24	8
1/12	8
1/8	8
1/4	8

Safety Barrier Promass 100

49 g (1.73 ounce)

Materials

Transmitter housing

- Order code for "Housing", option **A** "Compact, aluminum coated": Aluminum, AlSi10Mg, coated
- Order code for "Housing", option **B** "Compact, hygienic, stainless": Hygienic version, stainless steel 1.4301 (304)
- Order code for "Housing", option **C** "Ultra-compact, hygienic, stainless": Hygienic version, stainless steel 1.4301 (304)
- Window material for optional local display (→ 66):
 - For order code for "Housing", option **A**: glass
 - For order code for "Housing", option **B** and **C**: plastic

Cable entries/cable glands

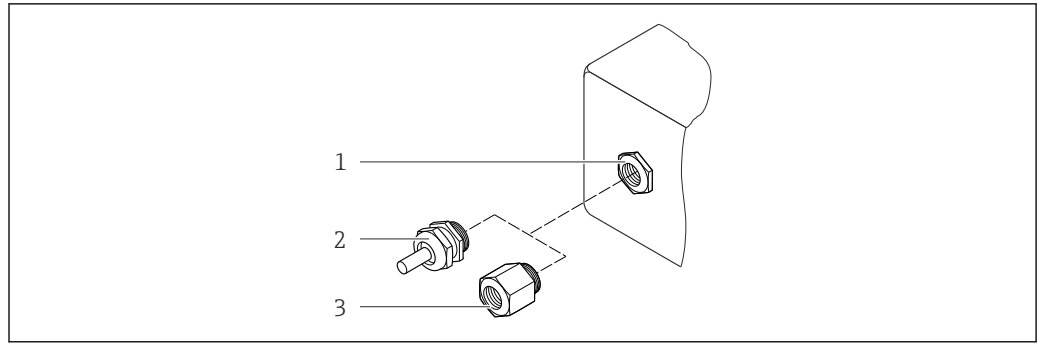

A0020640

32 Possible cable entries/cable glands

- 1 Cable entry in transmitter housing with internal thread M20 x 1.5
- 2 Cable gland M20 x 1.5
- 3 Adapter for cable entry with internal thread G 1/2" or NPT 1/2"

Order code for "Housing", option A "Compact, coated aluminum"

The various cable entries are suitable for hazardous and non-hazardous areas.

Cable entry/cable gland	Material
Cable gland M20 x 1.5	Nickel-plated brass
Adapter for cable entry with internal thread G 1/2"	
Adapter for cable entry with internal thread NPT 1/2"	

Order code for "Housing", option B "Compact, hygienic, stainless"

The various cable entries are suitable for hazardous and non-hazardous areas.

Cable entry/cable gland	Material
Cable gland M20 x 1.5	Stainless steel, 1.4404 (316L)
Adapter for cable entry with internal thread G 1/2"	
Adapter for cable entry with internal thread NPT 1/2"	

Device plug

Electrical connection	Material
Plug M12x1	<ul style="list-style-type: none"> ▪ Socket: Stainless steel, 1.4404 (316L) ▪ Contact housing: Polyamide ▪ Contacts: Gold-plated brass

Sensor housing

- Acid and alkali-resistant outer surface
- Stainless steel 1.4301 (304)

Measuring tubes

Stainless steel, 1.4539 (904L)

Process connections

VCO coupling



- 4-VCO-4 coupling: stainless steel, 1.4539 (904L)
- 8-VCO-4 coupling: stainless steel, 1.4404 (316L)

Mounting kit, flanges as per EN 1092-1 (DIN 2501), ASME B16.5, JIS B2220

- Stainless steel, 1.4539 (904L)
- Stainless steel, 316L

Mounting kit, lap joint flanges as per EN 1092-1 (DIN 2501), ASME B16.5, JIS B2220
Stainless steel, 1.4404 (316/316L)

Mounting kit, NPTF
Stainless steel, 1.4539 (904L)

 List of all available process connections →  65

Seals



Welded process connections without internal seals

Seals for mounting kit

- Viton
- EPDM
- Silicone
- Kalrez

Process connections

- Fixed flange connections:
 - EN 1092-1 (DIN 2512N) flange
 - ASME B16.5 flange
 - JIS B2220 flange
- VCO connections
 - 4-VCO-4
- Mounting kits for VCO connections
 - Flange EN 1092-1 (DIN 2501)
 - Flange ASME B16.5
 - Flange JIS B2220
 - NPT

 For information on the different materials used in the process connections →  63

Surface roughness

All data relate to parts in contact with fluid.
Not polished

Operability

Operating concept

Operator-oriented menu structure for user-specific tasks

- Commissioning
- Operation
- Diagnostics
- Expert level

Quick and safe commissioning

- Individual menus for applications
- Menu guidance with brief explanations of the individual parameter functions

Reliable operation

- Operation in the following languages:
 - Via "FieldCare" operating tool:
 - English, German, French, Spanish, Italian, Chinese, Japanese
 - Via integrated Web browser (only available for device versions with HART, PROFIBUS DP, PROFINET and EtherNet/IP):
 - English, German, French, Spanish, Italian, Dutch, Portuguese, Polish, Russian, Turkish, Chinese, Japanese, Bahasa (Indonesian), Vietnamese, Czech, Swedish, Korean
- Uniform operating philosophy applied to operating tools and Web browser
- If replacing the electronic module, transfer the device configuration via the plug-in memory (HistoROM DAT) which contains the process and measuring device data and the event logbook. No need to reconfigure.
For devices with Modbus RS485, the data recovery function is implemented without the plug-in memory (HistoROM DAT).

Efficient diagnostics increase measurement availability

- Troubleshooting measures can be called up via the operating tools and Web browser
- Diverse simulation options
- Status indicated by several light emitting diodes (LEDs) on the electronic module in the housing compartment

Local display

i A local display is only available for device versions with the following communication protocols: HART, PROFIBUS-DP, PROFINET, EtherNet/IP

The local display is only available with the following device order code:
Order code for "Display; Operation", option **B**: 4-line; lit, via communication

Display element

- 4-line liquid crystal display with 16 characters per line.
- White background lighting; switches to red in event of device errors.
- Format for displaying measured variables and status variables can be individually configured.
- Permitted ambient temperature for the display: -20 to $+60$ °C (-4 to $+140$ °F). The readability of the display may be impaired at temperatures outside the temperature range.

Remote operation**Via HART protocol**

This communication interface is available in device versions with a HART output.

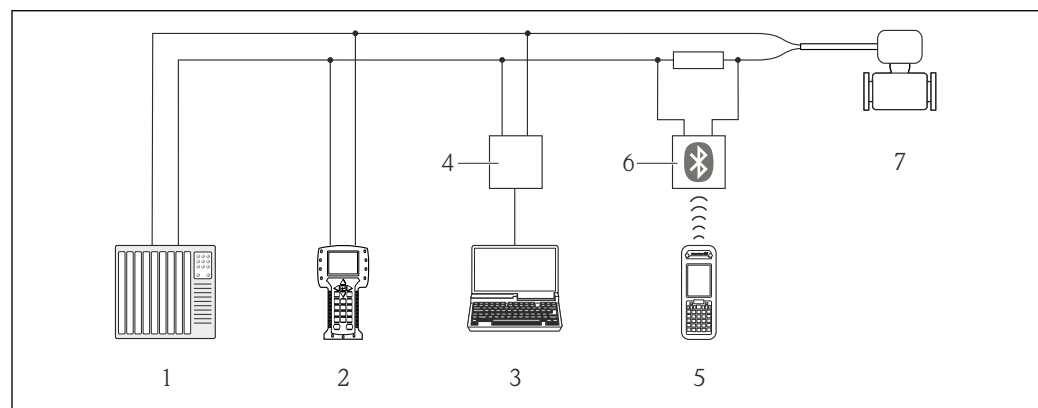

A0016948

33 Options for remote operation via HART protocol

- 1 Control system (e.g. PLC)
- 2 Field Communicator 475
- 3 Computer with operating tool (e.g. FieldCare, AMS Device Manager, SIMATIC PDM)
- 4 Commubox FXA.195 (USB)
- 5 Field Xpert SFX350 or SFX370
- 6 VIATOR Bluetooth modem with connecting cable
- 7 Transmitter

Via PROFIBUS DP network

This communication interface is available in device versions with PROFIBUS DP.

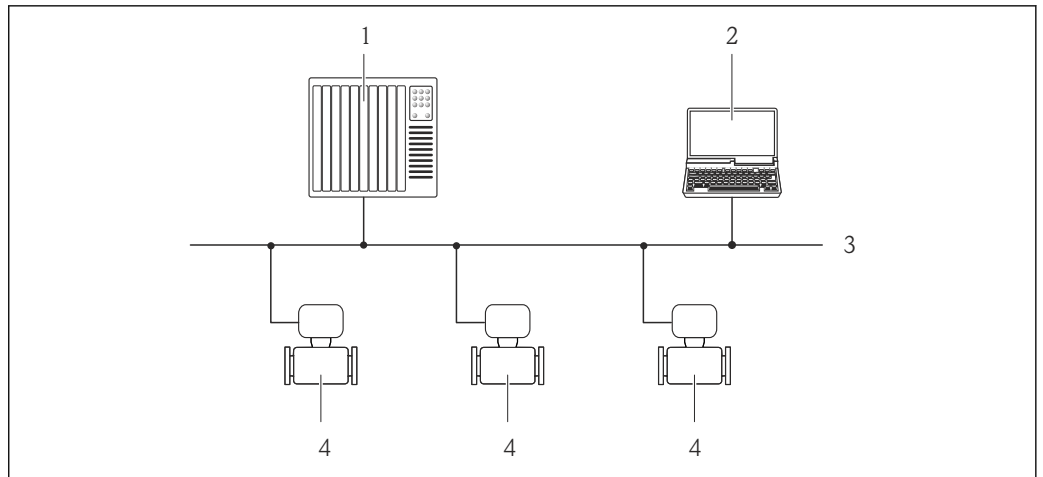

A0020903

34 Options for remote operation via PROFIBUS DP network

- 1 Automation system
- 2 Computer with PROFIBUS network card
- 3 PROFIBUS DP network
- 4 Measuring device

Via Ethernet-based fieldbus

This communication interface is available in device versions with EtherNet/IP.

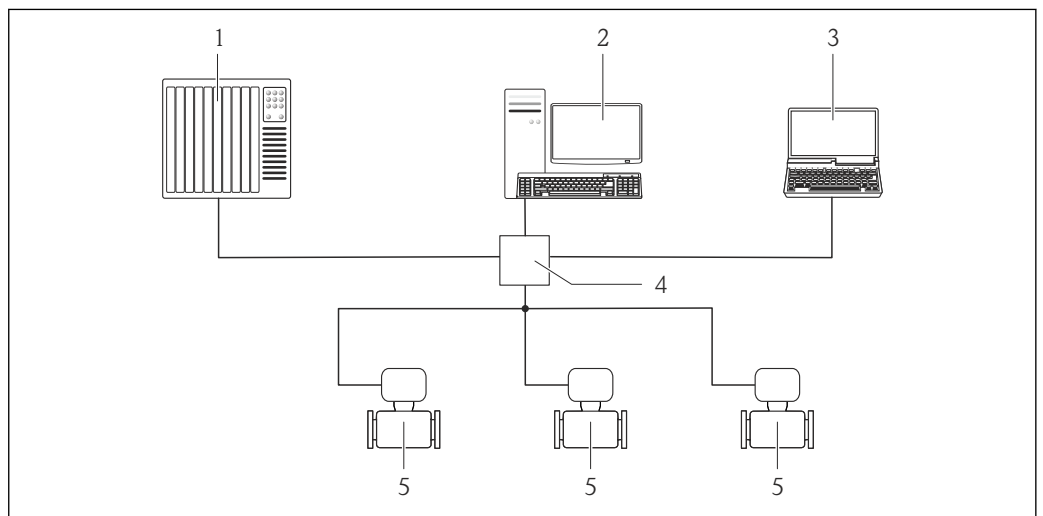

A0016961

35 Options for remote operation via Ethernet-based fieldbus

- 1 Control system, e.g. "RSLogix" (Rockwell Automation)
- 2 Workstation for measuring device operation: with Add-on Profile Level 3 for "RSLogix 5000" (Rockwell Automation) or with Electronic Data Sheet (EDS)
- 3 Computer with Web browser (e.g. Internet Explorer) for accessing the integrated device Web server or with "FieldCare" operating tool with COM DTM "CDI Communication TCP/IP"
- 4 Ethernet switch
- 5 Measuring device

Service interface

Via service interface (CDI-RJ45)

This communication interface is present in the following device version:

- Order code for "Output", option **B**: 4-20 mA HART, pulse/frequency/switch output
- Order code for "Output", option **L**: PROFIBUS DP
- Order code for "Output", option **N**: EtherNet/IP

HART

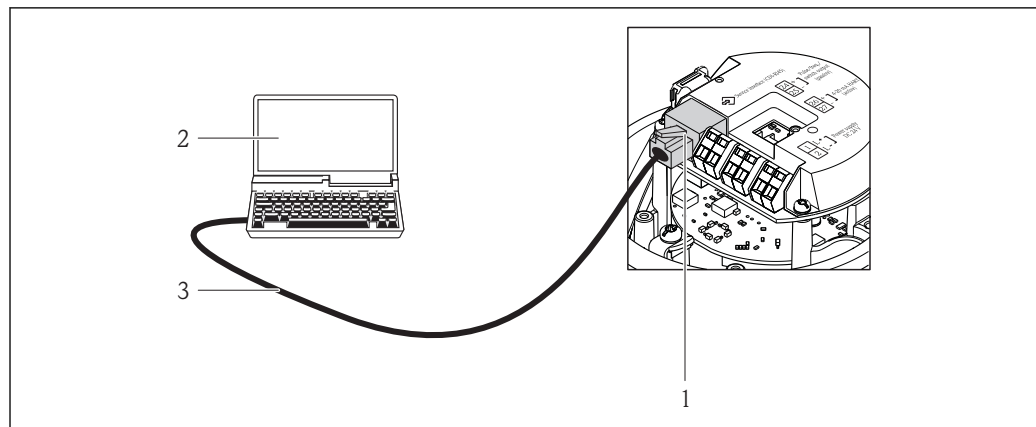

A0016926

36 Connection for the order code for "Output", option B: 4-20 mA HART, pulse/frequency/switch output

- 1 Service interface (CDI -RJ45) of the measuring device with access to the integrated Web server
- 2 Computer with Web browser (e.g. Internet Explorer) for accessing the integrated device Web server or with "FieldCare" operating tool with COM DTM "CDI Communication TCP/IP"
- 3 Standard Ethernet connecting cable with RJ45 plug

PROFIBUS DP

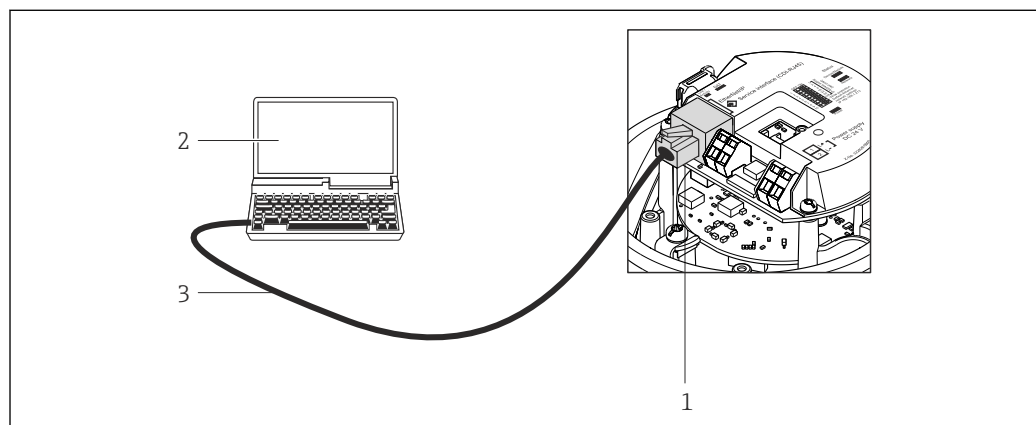

A0021270

37 Connection for order code for "Output", option L: PROFIBUS DP

- 1 Service interface (CDI -RJ45) of the measuring device with access to the integrated Web server
- 2 Computer with Web browser (e.g. Internet Explorer) for accessing the integrated device Web server or with "FieldCare" operating tool with COM DTM "CDI Communication TCP/IP"
- 3 Standard Ethernet connecting cable with RJ45 plug

EtherNet/IP

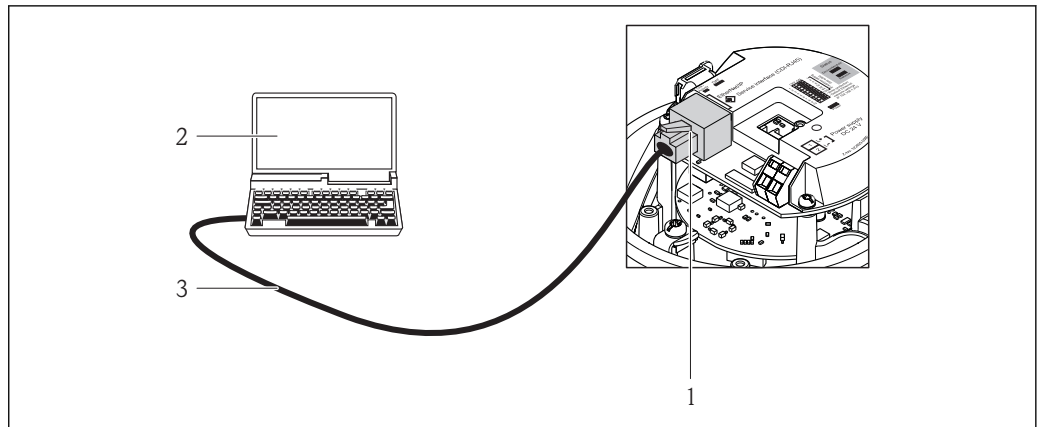

A0016940

38 Connection for order code for "Output", option N: EtherNet/IP

- 1 Service interface (CDI -RJ45) and EtherNet/IP interface of the measuring device with access to the integrated Web server
- 2 Computer with Web browser (e.g. Internet Explorer) for accessing the integrated device Web server or with "FieldCare" operating tool with COM DTM "CDI Communication TCP/IP"
- 3 Standard Ethernet connecting cable with RJ45 plug

Via service interface (CDI)

This communication interface is present in the following device version:
Order code for "Output", option **M**: Modbus RS485

Modbus RS485

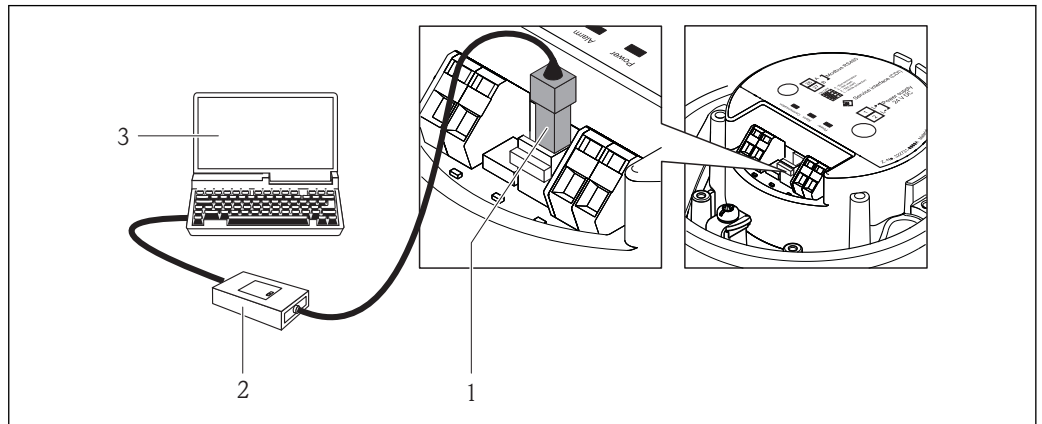

A0016925

- 1 Service interface (CDI) of the measuring device
- 2 Commubox FXA291
- 3 Computer with "FieldCare" operating tool with COM DTM "CDI Communication FXA291"

Certificates and approvals

CE mark

The measuring system is in conformity with the statutory requirements of the applicable EC Directives. These are listed in the corresponding EC Declaration of Conformity along with the standards applied.

Endress+Hauser confirms successful testing of the device by affixing to it the CE mark.

C-Tick symbol

The measuring system meets the EMC requirements of the "Australian Communications and Media Authority (ACMA)".

Ex approval

The measuring device is certified for use in hazardous areas and the relevant safety instructions are provided in the separate "Safety Instructions" (XA) document. Reference is made to this document on the nameplate.



The separate Ex documentation (XA) containing all the relevant explosion protection data is available from your Endress+Hauser sales center.

ATEX/IECEX

Currently, the following versions for use in hazardous areas are available:

Ex ia

Category (ATEX)	Type of protection
II2G, II2D	Ex ia IIC T6...T1 Gb Ex tb IIIC Txx °C Db
II2G	Ex ia IIC T6...T1 Gb

Ex nA

Category (ATEX)	Type of protection
II3G	Ex nA IIC T6...T1 Gc or Ex nA IIC T5-T1 Gc

cCSA_{US}

Currently, the following versions for use in hazardous areas are available:

IS (Ex i)

- Class I Division 1 Groups ABCD
- Class II Division 1 Groups EFG and Class III

NI (Ex nA)

Class I Division 2 Groups ABCD

HART certification**HART interface**

The measuring device is certified and registered by the FieldComm Group. The measuring system meets all the requirements of the following specifications:

- Certified according to HART 7
- The device can also be operated with certified devices of other manufacturers (interoperability)

Certification PROFIBUS**PROFIBUS interface**

The measuring device is certified and registered by the PROFIBUS User Organization (PNO). The measuring system meets all the requirements of the following specifications:

- Certified in accordance with PROFIBUS PA Profile 3.02
- The device can also be operated with certified devices of other manufacturers (interoperability)

EtherNet/IP certification

The measuring device is certified and registered by the ODVA (Open Device Vendor Association). The measuring system meets all the requirements of the following specifications:

- Certified in accordance with the ODVA Conformance Test
- EtherNet/IP Performance Test
- EtherNet/IP PlugFest compliance
- The device can also be operated with certified devices of other manufacturers (interoperability)

Modbus RS485 certification

The measuring device meets all the requirements of the MODBUS/TCP conformity test and has the "MODBUS/TCP Conformance Test Policy, Version 2.0". The measuring device has successfully passed all the test procedures carried out and is certified by the "MODBUS/TCP Conformance Test Laboratory" of the University of Michigan.

Other standards and guidelines

- EN 60529
Degrees of protection provided by enclosures (IP code)
- IEC/EN 60068-2-6
Environmental influences: Test procedure - Test Fc: vibrate (sinusoidal).
- IEC/EN 60068-2-31
Environmental influences: Test procedure - Test Ec: shocks due to rough handling, primarily for devices.
- EN 61010-1
Safety requirements for electrical equipment for measurement, control and laboratory use - general requirements
- IEC/EN 61326
Emission in accordance with Class A requirements. Electromagnetic compatibility (EMC requirements).
- NAMUR NE 21
Electromagnetic compatibility (EMC) of industrial process and laboratory control equipment
- NAMUR NE 32
Data retention in the event of a power failure in field and control instruments with microprocessors
- NAMUR NE 43
Standardization of the signal level for the breakdown information of digital transmitters with analog output signal.
- NAMUR NE 53
Software of field devices and signal-processing devices with digital electronics
- NAMUR NE 105
Specifications for integrating fieldbus devices in engineering tools for field devices
- NAMUR NE 107
Self-monitoring and diagnosis of field devices
- NAMUR NE 131
Requirements for field devices for standard applications
- NAMUR NE 132
Coriolis mass meter

Ordering information

Detailed ordering information is available from the following sources:

- In the Product Configurator on the Endress+Hauser website: www.endress.com → Select your country → Products → Select measuring technology, software or components → Select the product (picklists: measurement method, product family etc.) → Device support (right-hand column): Configure the selected product → The Product Configurator for the selected product opens.
- From your Endress+Hauser Sales Center: www.addresses.endress.com

**Product Configurator - the tool for individual product configuration**

- Up-to-the-minute configuration data
 - Depending on the device: Direct input of measuring point-specific information such as measuring range or operating language
 - Automatic verification of exclusion criteria
 - Automatic creation of the order code and its breakdown in PDF or Excel output format
 - Ability to order directly in the Endress+Hauser Online Shop

Application packages

Many different application packages are available to enhance the functionality of the device. Such packages might be needed to address safety aspects or specific application requirements.

The application packages can be ordered with the device or subsequently from Endress+Hauser. Detailed information on the order code in question is available from your local Endress+Hauser sales center or on the product page of the Endress+Hauser website: www.endress.com.



Detailed information on the application packages:

- Special Documentation for the device
- Special Documentation for the device

Heartbeat Technology

Package	Description
Heartbeat Verification +Monitoring	<p>Heartbeat Monitoring Continuously supplies data, which are characteristic of the measuring principle, to an external condition monitoring system for the purpose of preventive maintenance or process analysis. These data enable the operator to:</p> <ul style="list-style-type: none"> ■ Draw conclusions - using these data and other information - about the impact process influences (such as corrosion, abrasion, buildup etc.) have on the measuring performance over time. ■ Schedule servicing in time. ■ Monitor the process or product quality, e.g. gas pockets. <p>Heartbeat Verification Meets the requirement for traceable verification to DIN ISO 9001:2008 Chapter 7.6 a) "Control of monitoring and measuring equipment".</p> <ul style="list-style-type: none"> ■ Functional testing in the installed state without interrupting the process. ■ Traceable verification results on request, including a report. ■ Simple testing process via local operation or other operating interfaces. ■ Clear measuring point assessment (pass/fail) with high test coverage within the framework of manufacturer specifications. ■ Extension of calibration intervals according to operator's risk assessment.



Concentration





Package	Description
Concentration measurement and special density	<p>Calculation and outputting of fluid concentrations Many applications use density as a key measured value for monitoring quality or controlling processes. The device measures the density of the fluid as standard and makes this value available to the control system.</p> <p>The "Special Density" application package offers high-precision density measurement over a wide density and temperature range particularly for applications subject to varying process conditions.</p> <p>With the help of the "Concentration Measurement" application package, the measured density is used to calculate other process parameters:</p> <ul style="list-style-type: none"> ■ Temperature-compensated density (reference density). ■ Percentage mass of the individual substances in a two-phase fluid. (Concentration in %). ■ Fluid concentration is output with special units (°Brix, °Baumé, °API, etc.) for standard applications. <p>The measured values are output via the digital and analog outputs of the device.</p>

Accessories



Various accessories, which can be ordered with the device or subsequently from Endress+Hauser, are available for the device. Detailed information on the order code in question is available from your local Endress+Hauser sales center or on the product page of the Endress+Hauser website: www.endress.com.

Communication-specific accessories



Accessories	Description
Commubox FXA195 HART	For intrinsically safe HART communication with FieldCare via the USB interface.  For details, see "Technical Information" TI00404F
Commubox FXA291	Connects Endress+Hauser field devices with a CDI interface (= Endress+Hauser Common Data Interface) and the USB port of a computer or laptop.  For details, see the "Technical Information" document TI405C/07
HART Loop Converter HMX50	Is used to evaluate and convert dynamic HART process variables to analog current signals or limit values.  For details, see "Technical Information" TI00429F and Operating Instructions BA00371F

Wireless HART adapter SWA70	<p>Is used for the wireless connection of field devices. The WirelessHART adapter can be easily integrated into field devices and existing infrastructures, offers data protection and transmission safety and can be operated in parallel with other wireless networks with minimum cabling complexity.</p> <p> For details, see Operating Instructions BA00061S</p>
Fieldgate FXA320	<p>Gateway for the remote monitoring of connected 4-20 mA measuring devices via a Web browser.</p> <p> For details, see "Technical Information" TI00025S and Operating Instructions BA00053S</p>
Fieldgate FXA520	<p>Gateway for the remote diagnostics and remote configuration of connected HART measuring devices via a Web browser.</p> <p> For details, see "Technical Information" TI00025S and Operating Instructions BA00051S</p>
Field Xpert SFX350	<p>Field Xpert SFX350 is a mobile computer for commissioning and maintenance. It enables efficient device configuration and diagnostics for HART and FOUNDATION Fieldbus devices in the non-Ex area.</p> <p> For details, see Operating Instructions BA01202S</p>
Field Xpert SFX370	<p>Field Xpert SFX370 is a mobile computer for commissioning and maintenance. It enables efficient device configuration and diagnostics for HART and FOUNDATION Fieldbus devices in the non-Ex area and the Ex area.</p> <p> For details, see Operating Instructions BA01202S</p>

Service-specific accessories

Accessories	Description
Applicator	<p>Software for selecting and sizing Endress+Hauser measuring devices:</p> <ul style="list-style-type: none"> ▪ Calculation of all the necessary data for identifying the optimum flowmeter: e.g. nominal diameter, pressure loss, accuracy or process connections. ▪ Graphic illustration of the calculation results <p>Administration, documentation and access to all project-related data and parameters throughout the entire life cycle of a project.</p> <p>Applicator is available:</p> <ul style="list-style-type: none"> ▪ Via the Internet: https://wapps.endress.com/applicator ▪ On CD-ROM for local PC installation.
W@M	<p>Life cycle management for your plant W@M supports you with a wide range of software applications over the entire process: from planning and procurement, to the installation, commissioning and operation of the measuring devices. All the relevant device information, such as the device status, spare parts and device-specific documentation, is available for every device over the entire life cycle.</p> <p>The application already contains the data of your Endress+Hauser device. Endress+Hauser also takes care of maintaining and updating the data records.</p> <p>W@M is available:</p> <ul style="list-style-type: none"> ▪ Via the Internet: www.endress.com/lifecyclemanagement ▪ On CD-ROM for local PC installation.
FieldCare	<p>FDT-based plant asset management tool from Endress+Hauser. It can configure all smart field units in your system and helps you manage them. By using the status information, it is also a simple but effective way of checking their status and condition.</p> <p> For details, see Operating Instructions BA00027S and BA00059S</p>
DeviceCare	<p>Tool for connecting and configuring Endress+Hauser field devices.</p> <p> For details, see Innovation brochure IN01047S</p>
Commubox FXA291	<p>Connects Endress+Hauser field devices with a CDI interface (= Endress+Hauser Common Data Interface) and the USB port of a computer or laptop.</p> <p> For details, see "Technical Information" TI00405C</p>

System components

Accessories	Description
Memograph M graphic display recorder	The Memograph M graphic display recorder provides information on all relevant measured variables. Measured values are recorded correctly, limit values are monitored and measuring points analyzed. The data are stored in the 256 MB internal memory and also on a SD card or USB stick.  For details, see "Technical Information" TI00133R and Operating Instructions BA00247R
iTEMP	The temperature transmitters can be used in all applications and are suitable for the measurement of gases, steam and liquids. They can be used to read in the fluid temperature.  For details, see "Fields of Activity", FA00006T

Supplementary documentation

-  For an overview of the scope of the associated Technical Documentation, refer to the following:
- The *W@M Device Viewer* : Enter the serial number from the nameplate (www.endress.com/deviceviewer)
 - The *Endress+Hauser Operations App*: Enter the serial number from the nameplate or scan the 2-D matrix code (QR code) on the nameplate.

Standard documentation

Brief Operating Instructions

 Brief Operating Instructions containing the most important information for standard commissioning are supplied with the device.

Operating Instructions

Measuring device	Documentation code				
	HART	PROFIBUS DP	Modbus RS485	EtherNet/IP	PROFINET
Cubemass C 100	BA01188D	BA01247D	BA01178D	BA01183D	BA01425D

Description of device parameters

Measuring device	Documentation code				
	HART	PROFIBUS DP	Modbus RS485	EtherNet/IP	PROFINET
Cubemass 100	GP01063D	GP01064D	GP01065D	GP01066D	GP01067D

Supplementary device-dependent documentation

Safety Instructions

Content	Documentation code
ATEX/IECEX Ex i	XA01030D
ATEX/IECEX Ex nA	XA01143D
cCSAus IS	XA01142D
INMETRO Ex i	XA01221D
INMETRO Ex nA	XA01222D
NEPSI Ex i	XA01261D
NEPSI Ex nA	XA01263D

Special Documentation

Content	Documentation code
Information on the Pressure Equipment Directive	SD00142D
Modbus RS485 Register Information	SD00154D
Concentration Measurement	SD01152D
Heartbeat Technology	SD01153D

Installation Instructions

Contents	Documentation code
Installation Instructions for spare part sets	Specified for each individual accessory

Registered trademarks**HART®**

Registered trademark of the HART Communication Foundation, Austin, USA

PROFIBUS®

Registered trademark of the PROFIBUS User Organization, Karlsruhe, Germany

Modbus®

Registered trademark of SCHNEIDER AUTOMATION, INC.

EtherNet/IP™

Trademark of ODVA, Inc.

Microsoft®

Registered trademark of the Microsoft Corporation, Redmond, Washington, USA

TRI-CLAMP®

Registered trademark of Ladish & Co., Inc., Kenosha, USA

Applicator®, FieldCare®, DeviceCare®, Field Xpert™, HistoROM®, Heartbeat Technology™

Registered or registration-pending trademarks of the Endress+Hauser Group

www.addresses.endress.com
