



User Manual

IGM™ Clamp

Meter with

METERLiNK®

MODEL CM276





User Manual IGM™ Clamp Meter with METERLiNK®

Table of contents

1	Advisories	1
	1.1 Copyright.....	1
	1.2 Quality Assurance	1
	1.3 Documentation	1
	1.4 Disposal of Electronic Waste	1
2	Safety	2
	2.1 Safety Notes.....	2
	2.2 FCC Compliance	4
	2.3 Industry Canada Compliance	4
3	Introduction	5
	3.1 Product Overview	5
	3.2 Key Features	5
	3.3 Supplied Equipment	6
	3.4 Optional Accessories	6
4	Product Description	7
	4.1 Meter Front	7
	4.2 Meter Back	8
	4.3 Meter Bottom.....	9
	4.4 Function Switch Positions	9
	4.5 Control and Navigation Buttons	9
	4.6 MODE Button Operation	10
	4.7 Status Display Icons.....	10
	4.8 Measurement Display Icons	11
5	Meter Power	12
	5.1 Powering the Meter	12
	5.2 Auto Power Off (APO).....	12
	5.2.1 Device APO.....	12
	5.2.2 Worklight APO.....	13
6	Configuring the Meter	14
	6.1 Navigating the Menus	14
	6.2 Image Mode Menu.....	14
	6.2.1 Thermal MSX Alignment Distance	14
	6.2.2 Thermal MSX Activation	15
	6.2.3 Thermal Image Mode.....	15
	6.2.4 Digital Camera Mode	15
	6.3 Thermal Settings Menu	15

Table of contents

	6.3.1	color Palette.....	15
	6.3.2	Measurement Mode	16
	6.3.3	Temperature Scale	16
	6.3.4	Laser Pointer	17
	6.3.5	Emissivity.....	17
6.4		Gallery Menu	18
	6.4.1	Images and Video in the Gallery.....	18
	6.4.2	Data Log Records in the Gallery.....	18
	6.4.3	Sharing Images, Videos, and Data Logs (METERLiNK)	18
	6.4.4	Downloading Images, Videos, and Data Logs to a PC	19
6.5		Advanced Functions Menu	19
	6.5.1	VFD (Low Pass Filter)	19
	6.5.2	Maximum, Minimum, and Average Readings	19
	6.5.3	Inrush Current	20
	6.5.4	DC Current Zero	20
	6.5.5	Data Logger.....	20
6.6		Settings Menu.....	20
	6.6.1	Overview.....	20
	6.6.2	Measurement Parameters Menu	20
	6.6.3	Save Options Menu	21
	6.6.4	Device Settings	21
	6.6.5	Information Menu	23
7		Thermal Imaging	25
	7.1	Basics.....	25
	7.2	Thermal Imaging Display Description	25
	7.3	Thermal Imager Operation.....	25
	7.4	Configuring the Thermal Imager.....	26
	7.5	Image and Video Capture.....	26
		7.5.1 Overview.....	26
		7.5.2 Recording Images and Video.....	26
8		Clamp and Multimeter Operation.....	28
	8.1	Powering the Meter	28
	8.2	Auto Power OFF (APO).....	28
		8.2.1 Device APO	28

Table of contents

	8.2.2	Worklight APO.....	29
8.3		Automatic and Manual Ranges	29
8.4		Out-of-Range Alert.....	29
8.5		Display Hold Function.....	29
8.6		AC/DC Current and Frequency Measurements (Clamp)	30
	8.6.1	Clamp Measurement Considerations.....	30
	8.6.2	Taking Current Clamp Measurements.....	30
8.7		Current Measurements using an External Clamp Adaptor	32
8.8		Inrush Current Measurements	34
8.9		AC/DC Voltage and Frequency Measurements.....	35
8.10		Low Impedance (Lo Z) Voltage Measurements.....	37
8.11		Low Pass Filter (VFD) Voltage Measurements.....	38
8.12		Resistance Measurements	39
8.13		Continuity Measurements.....	41
8.14		Capacitance Measurements	43
8.15		Classic Diode Measurements.....	45
8.16		Smart Diode Test.....	47
8.17		Photovoltaic Power Measurements.....	48
	8.17.1	Photovoltaic Display Example	50
9		Data Logger Operation.....	51
10		Maximum, Minimum, and Average Readings.....	52
11		METERLiNK Mobile App.....	53
12		PC Interface.....	54
13		Maintenance.....	55
	13.1	Cleaning.....	55
	13.2	Recharging the Battery	55
	13.3	Upgrading the CM276 Firmware	55
		13.3.1 General	55
		13.3.2 Prerequisites.....	56
		13.3.3 Obtaining the Firmware Upgrade File	56
		13.3.4 Firmware Upgrade Procedure	57
	13.4	Disposal of Electronic Waste.....	58
	13.5	System Reset	58

Table of contents

14	Specifications	59
14.1	General Specifications.....	59
14.2	Meter Power.....	60
14.3	Thermal Imaging.....	60
14.4	Visual Imaging (Digital Camera).....	61
14.5	Thermal Image and Video Storage.....	61
14.6	Data Logger Memory.....	61
14.7	Wireless Connectivity.....	62
14.8	Electrical Specifications.....	62
	14.8.1 Voltage Measurements (True RMS).....	62
	14.8.2 Current Measurements (True RMS).....	63
	14.8.3 Clamp Adaptor Input.....	64
	14.8.4 Inrush Current.....	64
	14.8.5 Resistance and Continuity.....	65
	14.8.6 Capacitance.....	65
	14.8.7 Diode Testing.....	65
	14.8.8 Photovoltaic (PV) Measurements.....	65
14.9	Agency Approvals and Certifications.....	65
15	Appendices	67
15.1	Emissivity Values for Common Materials.....	67
15.2	IR Energy and Imaging Overview.....	67
16	CUSTOMER SUPPORT	69
17	Warranty	70

1 Advisories

1.1 Copyright

© 2023 FLIR Systems, Inc. All rights reserved worldwide.

No parts of the software including source code may be reproduced, transmitted, transcribed or translated into any language or computer language in any form or by any means, electronic, magnetic, optical, manual or otherwise, without the prior written permission of FLIR.

The documentation must not, in whole or part, be copied, photocopied, reproduced, translated or transmitted to any electronic medium or machine-readable form without prior consent, in writing, from FLIR Systems, Inc. Names and marks appearing on the products herein are either registered trademarks or trademarks of FLIR Systems, Inc. and/or its subsidiaries. All other trademarks, trade names or company names referenced herein are used for identification only and are the property of their respective owners.

1.2 Quality Assurance

The Quality Management System under which these products are developed and manufactured has been certified in accordance with the ISO 9001 standard. FLIR Systems, Inc. is committed to a policy of continuous development; therefore, we reserve the right to make changes and improvements on any of the products without prior notice.

1.3 Documentation

To access the latest manuals and notifications, go to the Download tab at: <https://support.flir.com>. It only takes a few minutes to register online. In the download area you will also find the latest releases of manuals for our other products, as well as manuals for our historical and obsolete products.

1.4 Disposal of Electronic Waste





As with most electronic products, this equipment must be disposed of in an environmentally friendly way, and in accordance with existing regulations for electronic waste. Please contact your FLIR representative for more details.

2 Safety



2.1 Safety Notes

- Before operating the device, you must read, understand, and follow all instructions, dangers, warnings, cautions, and notes.
- FLIR Systems reserves the right to discontinue models, parts or accessories, and other items, or to change specifications at any time without prior notice.

 WARNING
<ul style="list-style-type: none">• Do not operate the device if you do not have the correct knowledge. Incorrect operation of the device can cause damage, shock, injury or death to persons.• Do not start a measuring procedure before you have set the function switch to the correct position. Failure to do so can cause damage to the instrument and can cause injury to persons.• Do not change to the resistance mode when measuring voltage. This can cause damage to the instrument and can cause injury to persons.• Do not measure the current on a circuit when the voltage increases to more than 1000 V. This can cause damage to the instrument and can cause injury to persons.• You must disconnect the test leads from the circuit under test before you change the range. Failure to observe this warning can damage the instrument and cause bodily injury.• Do not use the device if the test leads and/or the device show signs of damage. Injury to persons can occur.• Be careful performing measurements if the voltages are > 30 V DC or AC RMS. There is a risk of shock from these voltages. Injury to persons can occur.• Do not do diode, resistance or continuity tests before you have removed the power from capacitors and other devices under test. Injury to persons can occur.• Be careful when performing voltage checks on electrical outlets. These checks are difficult because of the uncertainty of the connection to the recessed electrical contacts. You must not rely solely on this device when determining if the terminals are not “live”. There is a risk of electrical shock. Injury to person can occur.• Do not use the laser near explosive gases or in other potentially explosive areas.• Do not place or use the device in strong direct sunlight for extended periods.• Refer to the CAUTION statement label (shown below) for critical safety information.

	CAUTION
<p>Use caution when the Class 1 (industrial, commercial) Laser pointer is on. Do not point the beam toward anyone's eye or allow the beam to strike the eye from a reflective surface.</p> <p>Use of controls or adjustments or performance of procedures other than those specified herein may result in hazardous radiation exposure.</p>	
	

	CAUTION
<p>Do not use the device in a manner not specified by the manufacturer. This can cause damage to the protection provided.</p>	

	This symbol, adjacent to another symbol or terminal, indicates that the user must refer to the user manual for further information.
	This symbol, adjacent to a terminal, indicates that, under normal use, hazardous voltages may be present.
	Double insulation.

2.2 FCC Compliance

 WARNING
Operation of this equipment in a residential environment could cause radio interference. Class A equipment is intended for use in an industrial environment. Because of conducted, as well as radiated disturbances, potential difficulties exist in ensuring electromagnetic compatibility in other environments.

This equipment has been tested and found to comply with the limits for a Class A digital device, pursuant to part 15 of the FCC Rules. These limits are designed to provide reasonable protection against harmful interference in a commercial environment. This equipment generates, uses, and can radiate radio frequency energy and, if not installed and used in accordance with the instructions, may cause harmful interference to radio communications. Operation of this equipment in a residential area is likely to cause harmful interference in which case the user will be required to correct the interference at their own expense.

 CAUTION
Exposure to Radio Frequency Radiation. To comply with FCC/IC RF exposure compliance requirements, a separation distance of at least 20 cm must be maintained between the antenna of this device and all persons. This device must not be co-located or operating in conjunction with any other antenna or transmitter.

 WARNING
Changes or modifications not expressly approved by the party responsible for compliance could void the user's authority to operate the equipment.

2.3 Industry Canada Compliance

 CAUTION
Exposure to Radio Frequency Radiation. To comply with RSS 102 RF exposure compliance requirements, for mobile configurations, a separation distance of at least 20 cm must be maintained between the antenna of this device and all persons. This device must not be co-located or operating in conjunction with any other antenna or transmitter.

3 Introduction

3.1 Product Overview

Thank you for selecting the FLIR CM276 Imaging Clamp meter, this instrument combines clamp meter and multimeter functionality with cutting edge thermal imaging capabilities.

The CM276 is a True RMS 600 A AC/DC clamp meter with advanced functions, including VFD mode (low pass filter, for use on variable speed drives), inrush current capture, and a low impedance mode (for eliminating 'ghost' voltages).

The thermal imager offers radiometric Lepton® thermal imaging, IGM™ (Infrared Guided Measurement), and MSX® (Multi-Spectral Dynamic Imaging).

The CM276 is compatible with METERLiNK®, the FLIR mobile device sharing application, allowing you to share images, short videos (20 seconds, maximum), and data log records.

This device is shipped fully tested and calibrated and, with proper use, will provide years of reliable service.

3.2 Key Features

- Digital 6000 count, TFT color display 2.4 in. (6.1 cm) with bar graph and intuitive menu system.
- Full clamp and multimeter capabilities with automatic ranging, external clamp adaptor input, data hold, DC A zero, inrush current capture, low impedance setting, and VFD mode.
- Photovoltaic measurements for solar panel installation, testing, & servicing.
- Wide clamp jaw opening 1.38 in. (35 mm).
- Infrared thermal imager and digital camera (visible light).
- Capture, view, delete, and share images, videos, and data logs directly from the meter.
- Share images, video, and data logs using the METERLiNK mobile app or by direct PC connection.
- Thermal images are radiometric (measurement data stored in each image pixel).
- MSX gives sharper detail to thermal images by superimposing the digital camera image.
- Datalogger records up to 40,000 readings at selectable sampling intervals.
- Maximum/Minimum/Average reading memories.
- Programmable Automatic Power OFF (APO).

- Rechargeable lithium polymer battery.
- Safety rating CAT III 1000 V and CAT IV 600 V.

3.3 Supplied Equipment

- One (1) CM276 IGM Clamp Meter
- One (1) set of Test Leads (CAT III 1000 V and CAT IV 600 V)
- One (1) Type C to Type A USB cable for battery charging and PC connection
- One (1) soft, carry case
- One (1) printed Quick Start document
- One (1) FLIR Warranty Card

3.4 Optional Accessories

- TA86 MC4 Photovoltaic plugs
- TA85 Photovoltaic test leads
- TA74 Flexible Current Probe

4 Product Description

4.1 Meter Front

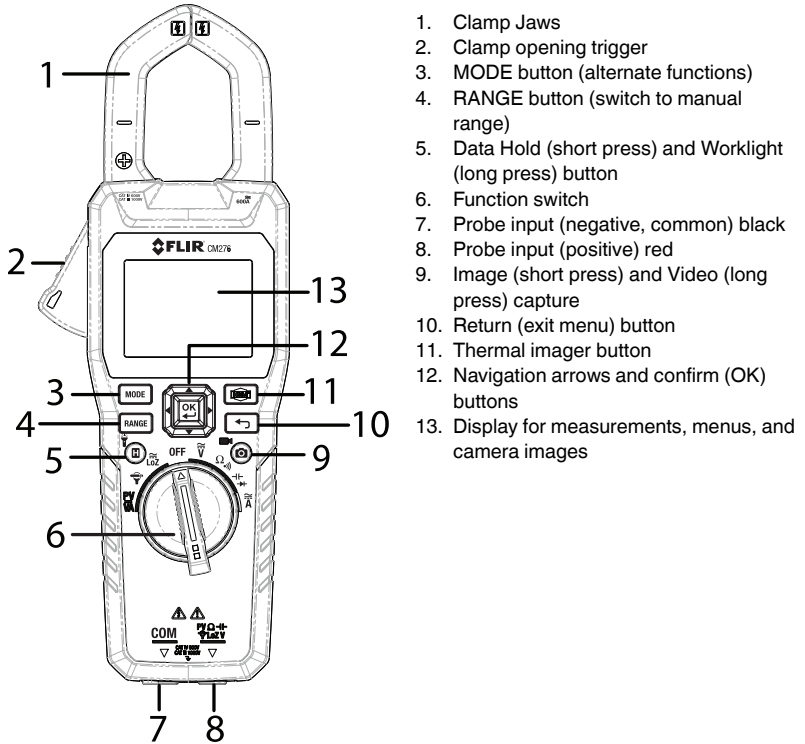
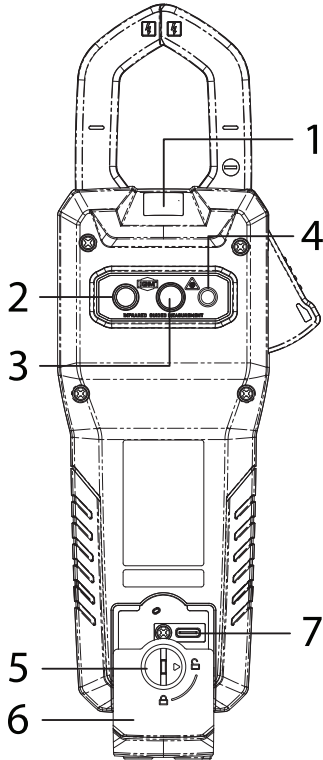

Figure 4.1 Front of meter

4.2 Meter Back



1. Worklight
2. Thermal imaging lens
3. Temperature detection lens
4. Laser pointer lens
5. Rear compartment lock
6. Rear compartment cover
7. USB-C connector in compartment

Figure 4.2 Back of meter.



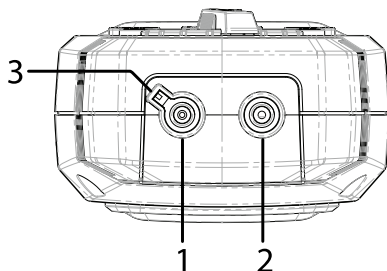



4.3 Meter Bottom



1. Common negative (-) test lead connector
2. Positive (+) test lead connector
3. Keyed part of the COM test lead connector





Figure 4.3 Back of meter.

4.4 Function Switch Positions

	Photo-voltaic DC Voltage, Current, and Power measurements (Section 8.17).
	External clamp meter adaptor mode (Section 8.7).
LoZ	Low impedance mode (Section 8.10).
OFF	Full power saving mode.
	AC/DC voltage measurements, using probe inputs (Section 8.9).
	Resistance and continuity measurements, using probe inputs (Sections 8.12 and 8.13).
	Capacitance (Section 8.14) and diode measurements (Sections 8.15 & 8.16), using probe inputs.
	Current (AC/DC) measurements (Sections 8.6, 8.7, and 8.8).







4.5 Control and Navigation Buttons

MODE	Press to select an alternate mode for the selected function (Section 4.6).
RANGE	From the automatic range mode, press to switch to the manual range mode. In the manual range mode, short press to change the range (scale), and long press to return to the automatic range mode.
	Short press to open/close the Thermal imager (Section 7).







	OK button with navigation arrows, used to confirm/change settings and to navigate menus.
	Press to exit a displayed menu item.
HOLD 	Short press to enter and exit the data hold mode. Long press to switch the worklight on and off.
	Short press to capture an image. Long press to start video recording (short press to stop), see Section 7.5.



4.6 MODE Button Operation

For each mode in the left column, press the **MODE** button to step through the alternate functions shown in the right column.













Switch Position	Mode Button Operation
	AC V > DC V > Frequency (Hz)
	Resistance < > Continuity
	Capacitance < > Diode
	AC A > DC A > Frequency (Hz)
LoZ	AC V > DC V > Frequency (Hz)
	AC A > Frequency (Hz)
	DC Power kVA with DCA > DC Power kVA with DCV

4.7 Status Display Icons

	Auto range		Battery status
	Data Hold mode		Emissivity
	Laser pointer		Data logger

	Worklight		Bluetooth
	Auto Power Off (APO)		

4.8 Measurement Display Icons

	Maximum, Minimum, Average readings (L to R)		Bar graph (right arrow appears in overload)
	Temperature units	k	10 ³ (kilo- prefix)
	AC current or voltage	m	10 ⁻³ (milli- prefix)
	DC current or voltage	μ	10 ⁻⁶ (micro- prefix)
	Continuity	OL	Out of range
	Resistance		> 30 V (AC/DC)
	Diode	LoZ	Low impedance mode
V	Voltage		In-rush current
A	Current (amperes)		DC A zero
F	Capacitance (farads)		Clamp adaptor (with range)
Hz	Frequency		Variable speed drive mode (low pass filter)

5 Meter Power

The meter is powered by an internal rechargeable lithium polymer battery that is charged before it is shipped from the factory. The battery status icon  is shown at the top left of the display. The meter also displays a full screen low battery alert, as shown below.

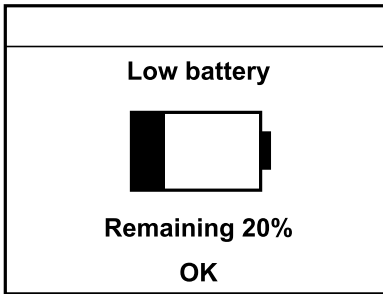
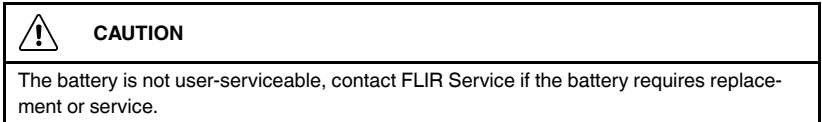

Figure 5.1 Low battery alert screen.



5.1 Powering the Meter

Set the function switch to any position to power the meter, the display will switch on. If the meter does not switch on, recharge the battery. Refer to Section 13 for battery recharging instructions.

5.2 Auto Power Off (APO)

5.2.1 Device APO

The meter enters sleep mode after a programmable period of inactivity, to customize this setting please see Section 6.6 (Settings menu). The default time-out is 10 minutes. The time can be set to 2, 5, or 10 minutes (select OFF to disable the APO).

The meter beeps 20 seconds prior to entering APO mode, press any button or turn the function switch to reset the APO timer.

5.2.2 Worklight APO

The worklight switches off after a programmable period of inactivity, to customize this setting please see Section 6.6. The default time-out is 15 minutes. The time can be set to 5, 15, or 30 minutes (select OFF to disable the worklight APO).

6 Configuring the Meter

6.1 Navigating the Menu

Press **OK** to access the main menu, shown below.



Figure 6.1 Main Menu icons (L to R: Image Mode, Thermal Settings, Gallery, Advanced Menu, Settings)



- Use the left/right navigation buttons to highlight an icon. From left to right the icons are *Image Mode*, *Thermal Settings*, *Gallery*, *Advanced Menu*, and *Settings*. Each is covered in the following sections. The Image and Thermal Settings modes are only available when the thermal imager is on.
- Press **OK** to open a highlighted icon, or to set an option ON or OFF. In many cases, when an option is ON a blue dot will appear next its icon. In some cases, the navigation arrows are used to select or change an option.
- Use the Return button to exit a menu and to return to the normal display mode.

6.2 Image Mode Menu

The image mode icon  is only accessible in the thermal image mode. The image mode menu has four sub-options covered in the next sections. To access the sub-options, press **OK** at the image mode icon in the main menu, use the arrow buttons to scroll to the desired sub-option, and press **OK** to select it.

6.2.1 Thermal MSX Alignment Distance

In MSX mode, the digital camera image is superimposed on the thermal image to provide greater detail. The Alignment tool is used to optimise the alignment of the two images.

1. Scroll to the Thermal MSX icon  in the Image Mode menu, and press **OK** to select it.
2. Scroll to the Alignment tool icon , and press **OK** to open it. A horizontal slider will appear on the bottom of the display.
3. Use the left and right arrow buttons to align the images by moving the slider.

6.2.2 Thermal MSX Activation

MSX provides detail and clarity to thermal images by superimposing digital camera images. Scroll to the Thermal MSX icon  in the Image Mode menu, and press **OK** to select it. Use the Alignment tool, explained above, to align the two images.

6.2.3 Thermal Image Mode

In the Thermal Image mode, the display shows a thermal images with no MSX. This is the default mode. Scroll to the Thermal Image icon  in the Image Mode menu, and press **OK** to select it.

6.2.4 Digital Camera Mode

In the Digital Camera mode, the display shows visible light camera images. Scroll to the Digital Camera icon  in the Image Mode menu, and press **OK** to select it.

6.3 Thermal Settings Menu

The Thermal Settings icon  is only accessible in the thermal image mode. The Thermal Settings menu has five sub-options, *color Palette*, *Measurement Mode*, *Temperature Scale*, *Laser pointer*, and *Emissivity*, covered in the next sections. To access the sub-options, press **OK** at the Thermal Settings icon in the main menu, use the arrow buttons to scroll to the desired sub-option, and press **OK** to open it.

6.3.1 color Palette

Press **OK** on the color icon , scroll to the desired color palette, and press **OK** to select it. The color options are shown below in Figure 6.2.

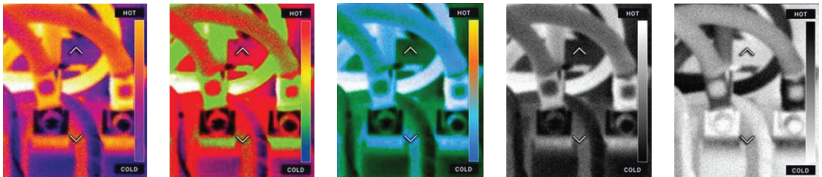



Figure 6.2 color palette options, L to R, Iron, Rainbow, Arctic, White Hot, Black Hot



6.3.2 Measurement Mode

Press **OK** on the Measurement Mode icon , scroll to desired mode, and press **OK** to select it. The measurement modes are *Centre Spot*, *Hot Spot*, *Cold Spot*, and *No Measurements*, explained the sections, below.

6.3.2.1 Centre Spot

Select  to measure surface temperature using cross hair targeting. The temperature measurement is shown on the upper left-hand corner of the thermal image.

6.3.2.2 Hot and Cold Spot

Select  or  to automatically target the warmest (red) or coldest (blue) spot. The thermal image will show a rectangle that can be used for targeting an area. Red or blue cross hairs will automatically move to the warmest (red) or coldest (blue) spot in the rectangle.

6.3.2.3 No Measurements

Select  to remove cross hairs and multimeter measurements from the thermal image.

6.3.3 Temperature Scale

Press **OK** on the Temperature Scale icon , scroll to *Auto* or *Lock*, and press **OK** to select it.

Note: For best results, allow a warm-up period of 3-5 minutes before using this feature.

The Auto/Lock Scale option allows the color palette range to be adjusted to suit a given application. For example, when viewing both cold and hot objects in the same frame, the auto-scaling (default mode) will cause the palette to 'stretch', as to fit the whole range of temperatures.

However, this can cause smaller temperature variations to go undetected, as the difference between two colors might increase from 1° to 10°. In this case, the user may choose to lock the scale with only the cold or medium-temperature objects in the frame. This would cause the hot objects to saturate, but will provide more detail to the colder objects of interest.

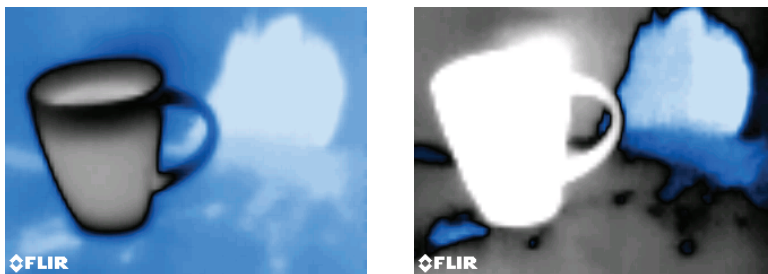

Figure 6.3 Figure on left is 'auto-scaled' while the figure on right is 'scale locked'

6.3.3.1 Automatic Temperature Scale

Select Auto to allow the camera to use the entire thermal range. In Fig. 6.3, above, the image on the left shows the Auto mode where the temperature range uses all the available spectrum.

6.3.3.2 Lock Temperature Scale

Select Lock to limit the thermal range to a narrow thermal region. The image on right, above in Fig. 6.3, shows the Lock mode, where the temperature range is constrained. To constrain the range, point to a spot in the frame that represents the temperature of interest, and then select the Lock mode.

6.3.4 Laser Pointer

Scroll to the Laser icon  in the Thermal Settings menu and press **OK** to toggle the Laser pointer ON/OFF. When on, a blue dot will appear next to the icon and the laser will switch on.

6.3.5 Emissivity

The amount of IR energy emitted by an object is proportional to the object's temperature and its ability to emit energy. This ability is known as emissivity.

Set the emissivity based on the material and finish of the object you are measuring. A flat black surface has an emissivity of 0.95. Preparing a surface with flat black paint or tape simplifies the emissivity setting process. Shiny and reflective surfaces have a much lower emissivity. See the Appendices for a list of common materials and their approximate emissivity values.







1. Press **OK** on the Emissivity icon .
2. Scroll to a preset (*Matte*, *Semi Matte*, *Semi Glossy*), or scroll to the *Custom Value* option, and press **OK**.

3. If you select the Custom Value option, set the emissivity using the arrow keys.
4. Press **OK** to confirm.

6.4 Gallery Menu





Press **OK** on the Gallery menu icon  to open it. In the Gallery menu, you can view, share (METERLiNK mobile app, Section 11), and delete stored images, videos, and logged readings, as explained in the next sections.

6.4.1 Images and Video in the Gallery

1. Press **OK** on the Gallery icon .
2. In the Images and Video Gallery, press **OK** on an image or video to open it.
3. Press **OK** again and four option icons will appear at the bottom of the display, from left to right these are, *Full Screen mode (for images)* , *Video Playback (for videos)* , *Transmit* , *Information* , and *Delete* .
4. Scroll to an option and press **OK**.
5. Images and short Videos can be shared (*transmit* icon ) with mobile devices and downloaded to a PC, as explained in the following sections and in Sections 11 and 12.

6.4.2 Data Log Records in the Gallery

For additional information on data logging, see Section 9.

1. In the Data Log Gallery, scroll to a record and press **OK** to open it.
2. Press **OK** again and three option icons will appear at the bottom of the display (*Transmit* , *Information* , & *Delete* .
3. Scroll to one of these options and press **OK**.
4. Data Logs can be shared (*transmit* icon ) with mobile devices (using the METERLiNK mobile app) and downloaded to a PC, as explained in the following sections and in Section 12.

6.4.3 Sharing Images, Videos, and Data Logs (METERLiNK)

For additional information on METERLiNK, see Section 11.

1. Download and open the METERLiNK mobile app from the App Store® (iOS® devices) or Google Play™ (Android™).
2. In the CM276 Devices menu, switch the Bluetooth utility ON (Main Menu > Settings > Device Settings).
3. Press **OK** on the Gallery icon in the main menu and select either *Images/Video* or *Data Logs*.

4. Press **OK** on an image, video, or data log file to select it.
5. With an image, video, or data log open, press **OK** to show the option icons on the bottom of the display.
6. Scroll to the *Transmit* icon  and press **OK** to share files with the METERLiNK app on your mobile device. Note that video length is limited to 20 seconds when sharing.

6.4.4 Downloading Images, Videos, and Data Logs to a PC

Images, video, and data logs can be downloaded to a PC via a direct connection.

With the meter off, connect the meter to the PC using the supplied USB-C cable. The meter's USB-C port is located in the rear compartment. Once connected, the PC will recognize the meter as an external storage device, allowing you to freely access and move the media.

See Section 12, PC interface, for additional information.



6.5 Advanced Functions Menu

Press **OK** at the Advanced menu icon  to access the functions explained in the next sections. Highlight a menu sub-option using the arrow buttons and then press **OK** to open it. Sub-option availability depends on the function switch position, not all sub-options are available for each function.

6.5.1 VFD (Low Pass Filter)

Scroll to the VFD icon  in the Advanced menu, and press **OK** to activate it. A blue dot appears next to the icon when VFD is active. VFD mode is used when measuring variable speed drives, a low pass filter is introduced in the measurement circuit to protect the meter. See Section 8.11 for additional information.

6.5.2 Maximum, Minimum, and Average Readings

Scroll to this function icon  in the Advanced menu, and press **OK** to open it. The maximum, minimum, and average reading memories will appear on the display . Press **OK** on the icon again to switch off the reading memories. See Section 10 for additional information.

6.5.3 Inrush Current

The meter can capture inrush current using a 100 ms sampling window. Press **OK** at the inrush current icon  to enable the mode. See Section 8.8 for additional information.

6.5.4 DC Current Zero

The DC A Zero function allows you to null the display before taking measurements in the DC A mode. Scroll to the zero icon  and press **OK** to zero the display. See Sections 8.6, 8.7, and 8.8, for current measurement information.

6.5.5 Data Logger

Scroll to the Data Logger icon  in the Advanced menu, and press **OK** to start logging. A blue dot appears next to the icon when the data logger is recording. Select the logger's sample rate in the Device Settings menu (*Settings > Device Settings > Log Sampling Rate*). See Section 9 for additional data logger information.

6.6 Settings Menu

6.6.1 Overview

In the Settings menu you can customize a variety of features. Press **OK** to open the main menu, scroll to the Settings icon , and press **OK** to open it. Four options are available in this menu, covered in the next sections.

6.6.2 Measurement Parameters Menu

In this menu, you can set emissivity, reflected temperature, and atmospheric temperature. Scroll to the desired submenu and press **OK** to open it. Use the arrow buttons to change a setting and press **OK** to confirm. Use the Return button to exit a menu.

6.6.2.1 Emissivity Setting

1. Go to the Emissivity menu (*Settings > Measurement Parameters > Emissivity*).
2. Scroll to a preset (*Matte, Semi Matte, Semi Glossy*), or scroll to the *Custom Value* option, and press **OK** to select it.
3. If you select the Custom Value option, set the emissivity using the arrow keys.
4. Press **OK** to confirm a selection.

For additional information on emissivity, see Section 6.3.5, *Emissivity*, and Section 15.1 (*Emissivity Values for Common Materials*).

6.6.2.2 Reflected Temperature Setting

Reflected temperature (also known as background temperature) is thermal radiation originating from other objects that reflect off the target you are measuring. Reflected temperature can affect the temperature a thermal camera measures.

1. Go to the Reflected Temperature menu (*Settings > Measurement Parameters > Reflected Temperature*).
2. Use the up/down arrow buttons to set the temperature.
3. Press **OK** to confirm.

6.6.2.3 Atmospheric Temperature Setting

Atmospheric conditions (gases and scattered particles between the object and the thermal camera) tend to attenuate radiation. The amount of attenuation depends on radiation wavelength. Fog, clouds, rain, and snow will affect thermal measurements. Adjusting this setting can mitigate these affects.

1. Go to the Atmospheric Temperature menu (*Settings > Measurement Parameters > Atmospheric Temperature*).
2. Use the up/down arrow buttons to set the temperature.
3. Press **OK** to confirm.

6.6.3 Save Options Menu

In the Save Options menu, you can opt to save a separate visible light image in *.jpg format with each thermal image.

1. Press **OK** at the Save Options menu.
2. Press **OK** again to see the options.
3. Scroll to *YES* or *NO* and press **OK** to confirm.

6.6.4 Device Settings

In this menu, you can set the diode mode (classic or smart), language, date/time, units of measure, APO settings, Bluetooth ON/OFF, screen brightness, and data logger sampling rate, as covered in the following sections. Use the arrow buttons to scroll to the Device Settings sub-menu, and press **OK** to open it.

6.6.4.1 Diode Mode (Classic or Smart)

Press **OK** at the Diode sub-menu, scroll to the desired option, and press **OK** to select it. See the diode measurement instructions in Sections 8.15 and 8.16 for complete instructions.

6.6.4.2 Language

Press **OK** at the Language sub-menu (*Settings > Device Settings > Language*), scroll to the desired language, and press **OK** to confirm.

6.6.4.3 Calendar Clock Setting and Format

1. Press **OK** at the Time sub-menu (*Settings > Device Settings > Time*).
2. Press **OK** at the Date/Time option.
3. Use the left/right arrows to step through year, month, day, hours, and minutes fields.
4. Use the up/down arrows to change a setting.
5. Press **OK** to confirm settings.
6. Press **OK** at the Date & Time Format menu.
7. Use the left/right arrows to select Time and Date options.
8. Use the up/down arrows to change a setting.
9. Press **OK** to confirm settings.

6.6.4.4 Temperature Units

1. Press **OK** at the Temperature Units sub-menu (*Settings > Device Settings > Temperature Units*).
2. Use the up/down arrows to select °C or °F.
3. Press **OK** to confirm.

6.6.4.5 APO Settings

In the APO menu, you can select APO for the device (meter) and the worklight.

1. Press **OK** at the Auto Power Off sub-menu (*Settings > Device Settings > Auto Power Off*).
2. Scroll to *Device* or *Worklight* and press **OK**.
3. In the Device menu, scroll to the desired automatic power off time (2, 5, 10 minutes or OFF), press **OK** to confirm.
4. In the Worklight menu, scroll to the desired APO time (5, 15, 30 minutes or OFF), press **OK** to confirm.

6.6.4.6 Bluetooth ON/OFF

1. To toggle Bluetooth ON or OFF, press **OK** at the Bluetooth sub-menu (*Settings > Device Settings > Bluetooth*).
2. Press **OK** to confirm the selection. See Section 11 for additional information on the METERLiNK mobile app that uses Bluetooth to share images, video, and data log records.

6.6.4.7 Screen Brightness

1. Press **OK** at the Screen Brightness sub-menu (*Settings > Device Settings > Screen Brightness*).
2. Use the up/down arrows to select Low, Medium, or High.
3. Press **OK** to confirm.

6.6.4.8 Data Log Sampling Rate

1. Press **OK** at the Log Sampling Rate sub-menu (*Settings > Device Settings > Log Sampling Rate*).
2. Use the up/down arrows to set the sampling interval from 1 to 100 seconds.
3. Press **OK** to confirm.

See Section 9 for additional information on Data Logging.

6.6.5 Information Menu

The Information menu has two sub-menus, *System Information* and *Reset Options*, as explained below. Press **OK** at the Information menu, use the arrow buttons to scroll to an option, and press **OK** to open it.

6.6.5.1 System Information Menu

In the System Information menu, scroll through the following data.

- Model number
- Serial number (S/N)
- Software version
- Build number
- Meter firmware version (FW)
- Bluetooth firmware version (BT FW)
- Storage status (memory total/memory used)
- Battery strength (%)
- Meter Calibration Date
- Infrared (IR) Calibration Date

6.6.5.2 Reset Options Menu

Under Reset Options you can reset the meter to its factory default state or format its internal memory, as explained in the next sections. Scroll to the desired option, use the arrow buttons to select an option, and press **OK** to confirm.

6.6.5.2.1 Factory Default Reset

1. Press **OK** at the Factory Default Reset menu (*Settings > Information > Reset Options > Factory Default Reset*).
2. Use the left/right arrows to select *Cancel* or *Reset* (the selected option is blue in color).
3. Press **OK** to confirm.

Note: To perform a full system hardware reset, see Section 13.5.

6.6.5.2.2 Format Internal Memory

1. Press **OK** at the Format Internal Memory menu (*Settings > Information > Reset Options > Format Internal Memory*).
2. Use the left/right arrows to select *Cancel* or *Format* (the selected option is blue in color). Note that all images, video, and data logs will be erased if the meter's memory is formatted.
3. Press **OK** to confirm.

7 Thermal Imaging

7.1 Basics

Thermal images represent infrared energy emitted by surfaces that you target. color variations in the image represent temperature variations. The laser pointer and display cross hairs assist in targeting.

The meter also digitally displays the measured temperature of a targeted spot, in the upper left hand corner of the display, superimposed on the thermal image.

With the function switch set to any position but OFF, short press the blue imager button to open the camera. Note that the battery must have a charge of at least 25% for the imager to operate.

7.2 Thermal Imaging Display Description

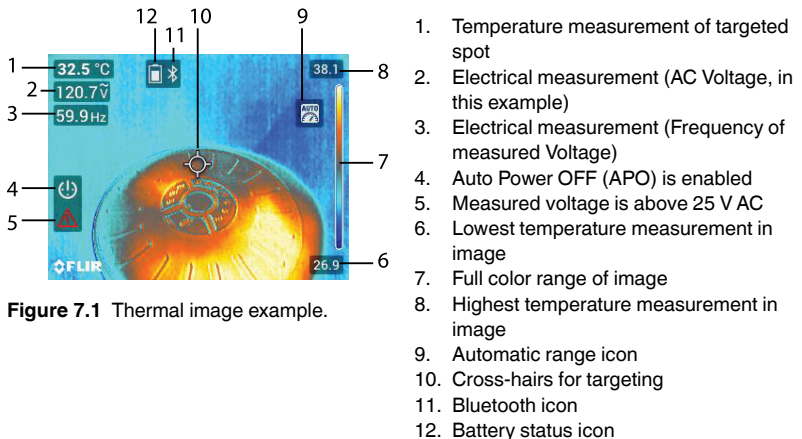

Figure 7.1 Thermal image example.

7.3 Thermal Imager Operation

The thermal imaging camera lens and detection sensors are located on the back of the meter. When you point the camera lenses towards an object, you view its image on the meter's display. The temperature of the targeted surface is shown on the upper, left-hand corner of the display.

Use the cross hairs and laser pointer for targeting, these can be switched ON or OFF in the Thermal Settings menu (see Section 6.3).

In the thermal imaging mode, the meter continues to operate normally as a clamp meter and multimeter. Electrical measurements are shown underneath the temperature reading. In the Image Mode menu (Section 6.2) you can remove the electrical measurement displays from the thermal images.

The thermal imager's field of view (FOV) is 44° (vertical) by 57° (horizontal)

7.4 Configuring the Thermal Imager

The thermal imager is configured using the Image Mode and Thermal Settings menus, as explained in Sections 6.2 and 6.3. Below is a list of the available thermal imaging settings in these two menus.

- Image Mode: Select thermal MSX, thermal image only, or digital camera only modes.
- Thermal Settings: color palette, Measurement Mode, Temperature Scale, Laser pointer, and Emissivity.

7.5 Image and Video Capture

7.5.1 Overview

The meter can capture thermal and visible light (digital camera) images and video. When not using the cameras, only screen shots can be captured as images, not video. Captured images and video are stored in the meter's internal memory and can be viewed, deleted, and shared from the Gallery menu (Section 6.4).

Images and video can be shared with mobile devices, using the METERLiNK mobile app, or can be downloaded to a PC using the supplied USB-C connecting cable. The meter's USB-C connector is located in the rear compartment.

Saved thermal images are fully radiometric, meaning that each pixel in the image contains temperature measurement data. However, the imager must be fully initialized before radiometric data can be captured.

The imager is initialized when the approximation symbol (~), preceding the temperature reading on the upper left corner of the display, switches off (typically within 30 seconds).

7.5.2 Recording Images and Video

When using the thermal or digital camera, short press the image capture button  to save the displayed image. Long press the button to start recording video, and short press the button to stop the recording.

In multimeter mode (when not using cameras), you can capture screen shots as images (not video) by pressing the image capture button.

See the Gallery menu (Section 6.4) for information on sharing and downloading stored media. Section 11 (*METERLiNK*), and Section 12, *PC Interface*, also provide useful information on sharing and downloading media, but the Gallery menu is a good place to start.

8 Clamp and Multimeter Operation

 CAUTION
Before operating the device, you must read, understand, and follow all instructions, dangers, warnings, cautions, and notes.

NOTE

When the meter is not in use, the function switch should be set to the OFF position.

 CAUTION
When connecting the probe leads to the device under test, connect the negative lead before connecting the positive lead. When removing the probe leads, remove the positive lead before removing the negative lead.

 CAUTION
Before and after hazardous voltage measurements, test the voltage function on a known source (such as line voltage) to determine proper meter functionality.

8.1 Powering the Meter

Set the function switch to any position to power the meter ON.

If the low battery voltage warning is displayed, or if the meter does not power ON, recharge the batteries. See Section 13, *Maintenance*, for battery charging details.

8.2 Auto Power OFF (APO)

The CM276 has an APO function for both the device (meter) and the worklight, as explained below.

8.2.1 Device APO

The meter enters sleep mode after a programmable period of inactivity, customize this in the Device settings menu, Section 6.6.4. The default time-out is 10 minutes. The time can be set to 2, 5, or 10 minutes (select OFF to disable the APO).

The meter beeps 20 seconds prior to entering APO mode, press any button or turn the function switch to reset the APO timer.

8.2.2 Worklight APO

The worklight switches off after a programmable period of inactivity, customize this in the Device settings menu, Section 6.6.4. The default time-out is 15 minutes. The time can be set to 5, 15, or 30 minutes (select OFF to disable the worklight APO).

8.3 Automatic and Manual Ranges

The meter uses automatic ranging by default. To manually select a measurement range, short press the **RANGE** button to exit the Auto mode. Subsequent, short presses will step through the available ranges. Long press the **RANGE** button to return to the Auto Range mode.

When the Auto Range mode is active, the Auto Range icon is displayed (Figure 8.1, below). In the manual mode, the meter may display an up arrow, suggesting that a higher range should be selected for best accuracy and resolution.



Figure 8.1 Auto Range Display Icon

8.4 Out-of-Range Alert

If the input is out-of-range, **OL** is displayed. Please do not attempt to make measurements beyond the specified ranges of the meter.

For the bar graph, an arrow (>) appears to the right of the graph when the input is out-of-range.

8.5 Display Hold Function

After taking a measurement, short press the **HOLD** button to freeze a reading. Press the **HOLD** button again to return to normal operation. The **H** icon will appear when the data hold function is engaged.

8.6 AC/DC Current and Frequency Measurements (Clamp)



WARNING

Do not measure current on a circuit if the voltage increases to more than 1000 V. This can cause damage to the instrument and can cause injury to persons.



WARNING

Do not use the meter to measure current above the rated frequency. This may cause the magnetic circuits in the jaws to reach hazardous temperatures.



WARNING

Disconnect the test leads from the meter before taking clamp measurements.

8.6.1 Clamp Measurement Considerations

- Always clamp around the conductor(s) of only **one** pole of a circuit. Enclosing two or more poles will result in differential current measurements.
- Ensure that the jaws are completely closed when making measurements.
- Align the conductor(s) to the jaws centre indicators as closely as possible.
- Adjacent current-carrying devices such as transformers, motors and conductor wires can affect measurement accuracy.

8.6.2 Taking Current Clamp Measurements

Refer to Figure 8.2, below, for the numbered items in this section.

1. Set the function switch to the Ampere position **\bar{A}** .
2. Short press the **MODE** button to select AC or DC current. Long press to read the frequency (Hz).
3. For DC current, with no conductor in the clamp, use the DC Zero feature (Section 6.5.4).
4. Press the trigger to open the clamp jaws and clamp around the conductor under test.
5. Read the Auto Range current measurement on the display.
6. To switch to Manual Range mode, short press the **RANGE** button. Additional short presses will step through the available ranges. Long press the **RANGE** button to return to Auto Range mode.
7. Short press the **HOLD** button to freeze or release the displayed measurement.
8. The current reading is shown at the centre of the display.

9. The DC A Zero icon $\overline{0}$ is shown on the display when enabled (see Section 6.5.4).
10. The Inrush current icon $\overline{I_{in}}$ is shown on the display, when enabled (see Sections 6.5.3 and 8.8).

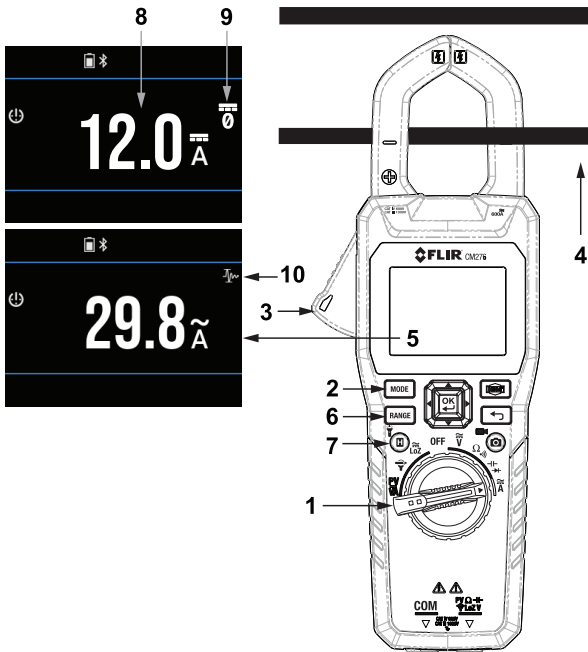



Figure 8.2 Current Clamp Measurements. The upper display shows a DC measurement example (with the DC A Zero icon, see Section 6.5.4). The lower screen shows an AC current measurement (with the inrush current icon, see Section 8.8).

8.7 Current Measurements using an External Clamp Adaptor

Note: This section applies only to measurements taken with an external clamp adaptor (FLIR TA74, for example). For clamp measurements using the CM276 built-in clamp, see Section 8.6.

Refer to Figure 8.3, below, for the numbered items in this section.

1. Insert the black test lead from the external clamp meter into the CM276 negative (COM) terminal, and the red test into the positive terminal.
2. Set the CM276 function switch to the external clamp adaptor position .
3. Short press the **MODE** button to toggle between current measurements and frequency measurements.
4. Unlock the external clamp meter's jaws, enclose one conductor, and re-lock the jaws.
5. View the current that the external clamp is measuring on the CM276 display.
6. Use the **RANGE** button to set the appropriate range (1, 10, or 100 mV per Amp), depending on the magnitude of the current to be measured. The CM276 displays AC Current in ampere units.
7. Short press the **HOLD** button to freeze or release the displayed measurement.
8. The external clamp mode icon is shown at the top of the display.
9. The selected range is shown at the top of the display.
10. The frequency measurement is shown above the current measurement.
11. The measured current is shown at the centre of the display.
12. The bar graph reading is shown at the bottom of the display.
13. When finished, remove the conductor from the external clamp jaws, switch off the external clamp, and disconnect the test leads from the CM276 (positive lead first).

As an example, with both the CM276 and the external clamp set to the 10 mV per amp range, the CM276 will display 5 A when the external clamp is measuring 5 A. The signal sent from the external clamp to the CM276, in this example, is 50 mV.

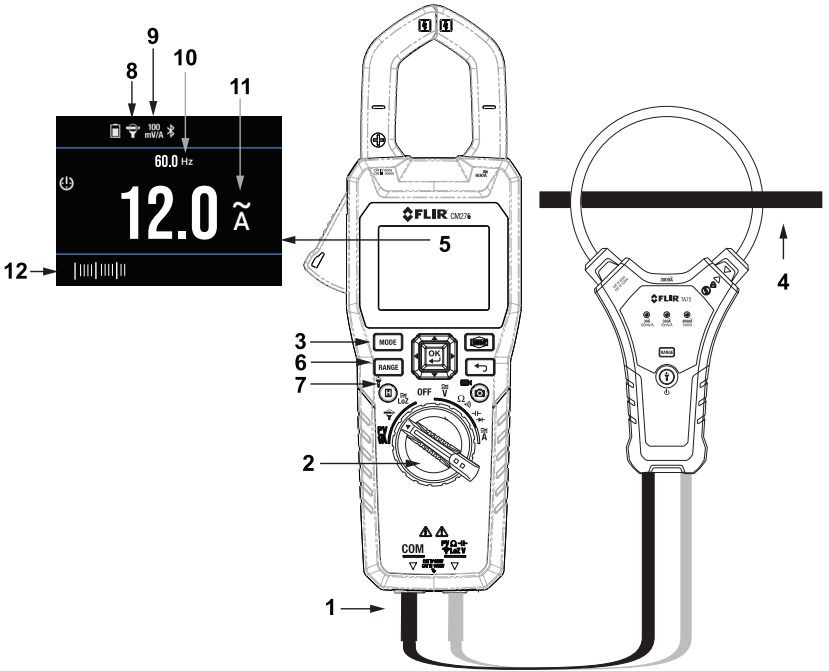

Figure 8.3 External Clamp Adaptor Test Setup.

8.8 Inrush Current Measurements

Set up a current test as described in the sections above, and continue with the information below.

The meter can capture inrush current using a 100 ms sampling window. Press **OK** at the inrush current icon $\overline{I_{in}}$ to enable the mode. See Section 6.5.3 for programming details.

The sampling window opens only when the threshold current is detected (see table, below). When detecting an input current, ± 50 digits of the selected range, the meter will calculate the RMS values for a 100 mS period and display this value. Refer to Figure 8.4, below.

Measurement Range	Minimum triggering current threshold
30 A range	0.5 A
300 A range	5.0 A
3000 A	50 A

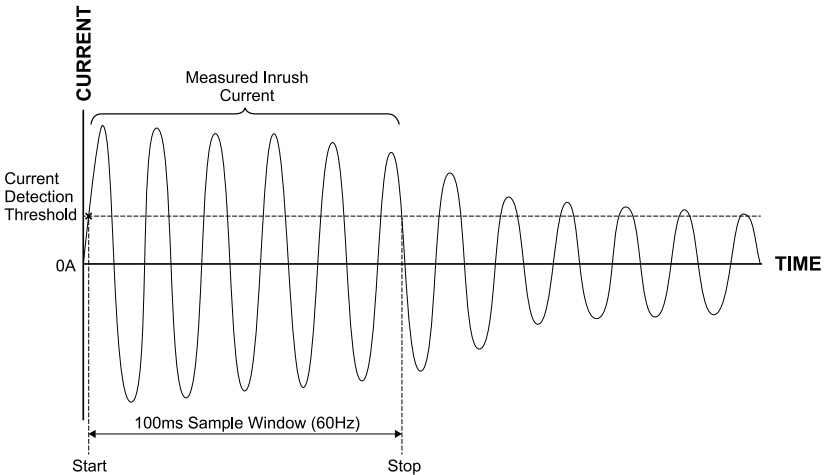

Figure 8.4 Capturing Inrush Current.

8.9 AC/DC Voltage and Frequency Measurements

**CAUTION**

Use caution when the measured voltage is greater than 30 V DC or AC RMS.

Refer to Figure 8.5, below, for the numbered items in this section.

1. Insert the black test lead into the negative (COM) terminal and the red test lead into the positive terminal.
2. Set the function switch to the Voltage position \bar{V} .
3. Short press the **MODE** button to select AC, DC voltage, Frequency.
4. Place the probe ends of the test leads in parallel to the part under test.
5. Read the Auto Range voltage measurement on the display.
6. To switch to Manual Range mode, short press the **RANGE** button. Subsequent short presses of the **RANGE** button will step through the available ranges. Long press the **RANGE** button to return to Auto Range mode.
7. In the Auto Range mode the Auto Range icon is shown on the display.
8. Short press the **HOLD** button to freeze or release the displayed measurement.
9. The voltage measurement is shown, digitally, at the centre of the display.
10. The voltage measurement is shown as a bar graph at the bottom of the display.
11. The frequency of an AC voltage measurement is shown above the voltage reading.
12. The warning symbol is shown when the measured voltage is > 30 V DC or AC RMS.
13. The APO icon is shown when the APO timer is enabled.
14. The battery status icon informs you of battery strength.

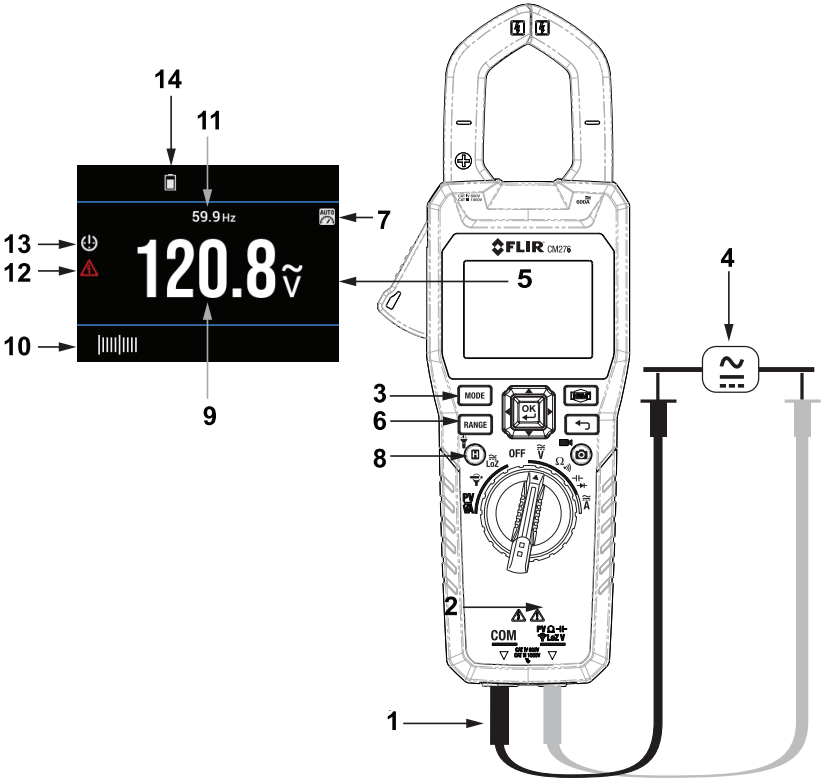



Figure 8.5 AC and DC Voltage Measurement Setup.

8.10 Low Impedance (Lo Z) Voltage Measurements

 CAUTION
Use caution when the measured voltage is greater than 30 V DC or AC RMS.

Lo Z Voltage measurements eliminate the affects of ‘ghost’ voltages. The procedure for taking Lo Z Voltage measurements is virtually the same as for taking standard Voltage measurements, the only difference is that for Lo Z Voltage measurements you select the Lo Z rotary switch position.

Refer to Section 8.9 for voltage measurement instructions. Refer to Figure 8.6, below, for an example of a Lo Z measurement screen, notice the Lo Z icon (item 1, in the figure).

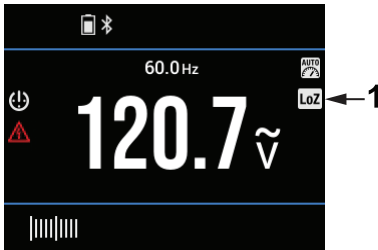

Figure 8.6 Lo Z (low impedance) mode screen example. Notice item 1, the Lo Z icon.

8.11 Low Pass Filter (VFD) Voltage Measurements



CAUTION

Use caution when the measured voltage is greater than 30 V DC or AC RMS.

The VFD feature eliminates high frequency noise in AC voltage measurements by means of a low pass filter. The VFD mode is designed for variable frequency drive measurements. When taking AC Voltage measurements, the VFD function icon is shown on the display (Figure 8.7, below).

Switch the VFD function ON/OFF in the Advanced Menu, see Section 6.5.

The procedure for taking VFD Voltage measurements is virtually the same as for standard Voltage measurements, the only difference is that for VFD Voltage measurements you enable VFD in the Advanced Menu. Refer to Section 8.9 for standard voltage measurement instructions.

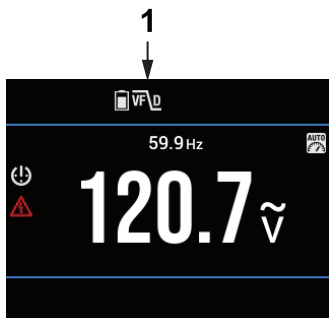

Figure 8.7 VFD (low pass filter) mode screen example. Notice item 1, the VFD icon.

8.12 Resistance Measurements

**WARNING**

Do not take resistance measurements before removing power to the resistor or circuit under test. Injury to persons can occur.

Refer to Figure 8.8, below, for the numbered items in this section.

1. Insert the black test lead into the negative (COM) terminal and the red test lead into the positive terminal.
2. Set the function switch to the Resistance position Ω .
3. If necessary, short press the MODE button to select the Resistance function $k\Omega$.
4. Place the probe ends of the test leads in parallel to the part under test.
5. Read the resistance value on the display.
6. To switch to Manual Range mode, short press the **RANGE** button. Subsequent short presses of the **RANGE** button will step through the available ranges. Long press the **RANGE** button to return to Auto Range mode.
7. In the Auto Range mode the Auto Range icon is shown on the display.
8. Short press the **HOLD** button to freeze or release the displayed measurement.
9. The resistance measurement is shown, digitally, at the centre of the display.
10. The resistance measurement is shown as a bar graph at the bottom of the display.
11. The APO icon is shown when the APO timer is enabled.
12. The Bluetooth icon is shown when Bluetooth is enabled in the Device Settings menu (see Section 6.6).
13. The battery status icon shows the battery strength.

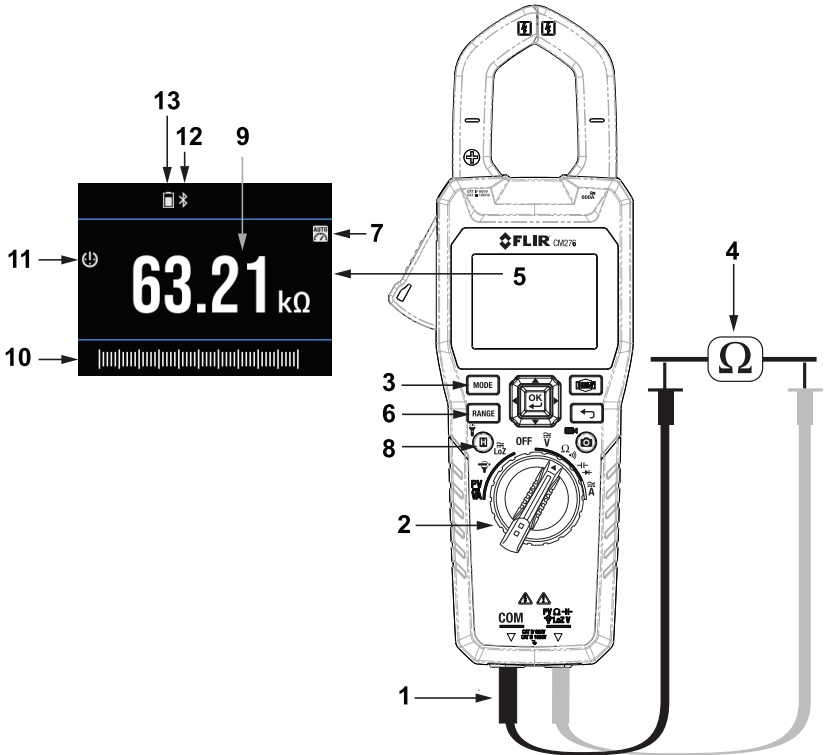

Figure 8.8 Resistance Measurements.

8.13 Continuity Measurements

**WARNING**

Do not perform continuity tests before removing power to the device under test. Injury to persons can occur.

Refer to Figure 8.9, below, for the numbered items in this section.

1. Insert the black test lead into the negative (COM) terminal and the red test lead into the positive terminal.
2. Set the function switch to the Continuity position (•)).
3. If necessary, short press the **MODE** button to select the Continuity function.
4. Place the probe ends of the test leads across the wire or device under test. If the measurement is $< 30 \Omega$, the meter will beep. If the measurement is $> 150 \Omega$, the meter will not beep. Between 30Ω and 150Ω , the meter will stop beeping at an unspecified point.
5. View the measurements on the display.
6. Short press the **HOLD** button to freeze or release the displayed measurement.
7. The continuity icon shown in the continuity mode.
8. Measurements are shown, digitally, at the centre of the display.
9. Measurements are shown as a bar graph at the bottom of the display.

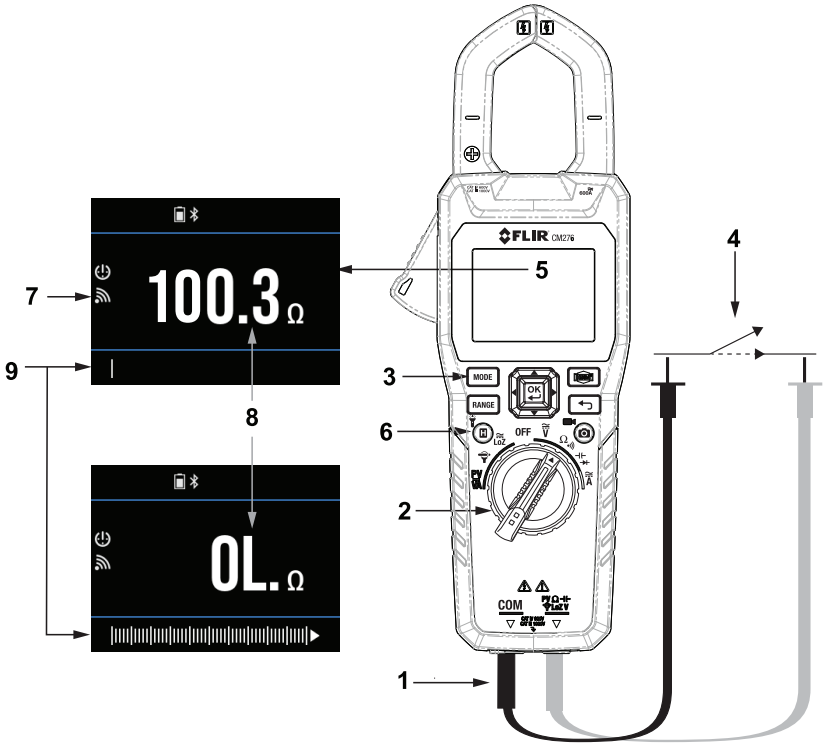

Figure 8.9 Continuity Measurements.

8.14 Capacitance Measurements

**CAUTION**

Discharge capacitors before taking measurements.

Refer to Figure 8.10, below, for the numbered items in this section.

1. Insert the black test lead into the negative (COM) terminal and the red test lead into the positive terminal.
2. Set the function switch to the Capacitance position .
3. Short press the **MODE** button to select Capacitance (diode symbol should be off).
4. Place the probe ends of the test leads in parallel to the part under test.
5. Read the Auto Range measurement on the display.
6. To switch to Manual Range mode, short press the **RANGE** button. Subsequent short presses of the **RANGE** button will step through the available ranges. Long press the **RANGE** button to return to Auto Range mode. In the Auto Range mode the Auto Range icon is shown on the display.
7. Short press the **HOLD** button to freeze or release the displayed measurement.
8. The capacitance measurement is shown, digitally, at the centre of the display.
9. The capacitance measurement is shown as a bar graph at the bottom of the display.

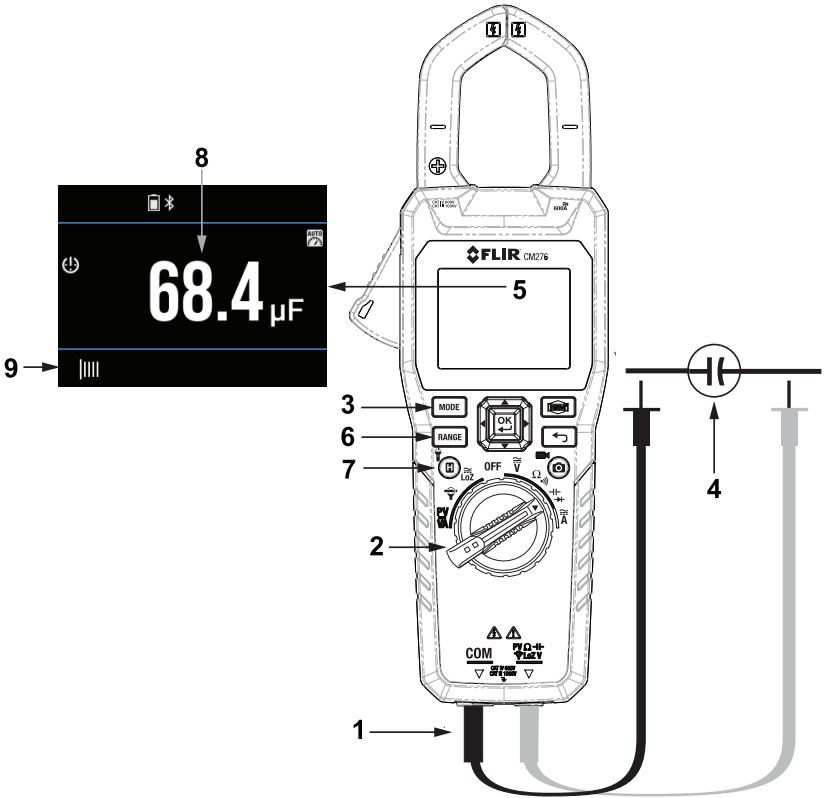

Figure 8.10 Capacitance measurements.

8.15 Classic Diode Measurements

**WARNING**

Do not perform diode tests before removing power to the diode under test. Injury to persons can occur.

Refer to Figure 8.11, below, for the numbered items in this section.

1. Insert the black test lead into the negative (COM) terminal and the red test lead into the positive terminal.
2. Set the function switch to the Diode position \rightarrow .
3. If necessary, short press the **MODE** button to select the Diode function.
4. Take a forward bias diode measurement and note the reading.
5. Take a reverse bias diode measurement and note the reading.
6. View the readings at the centre of the display.
7. The diode icon is shown on the display in diode mode, if it is not shown, press the **MODE** button.
8. If the reading is between 0.40 V and 0.90 V in one direction and **OL** (overload) in the opposite direction, the component is good. If the measurement is **0 V** in both directions (shorted) or **OL** in both directions (open), the component is bad.

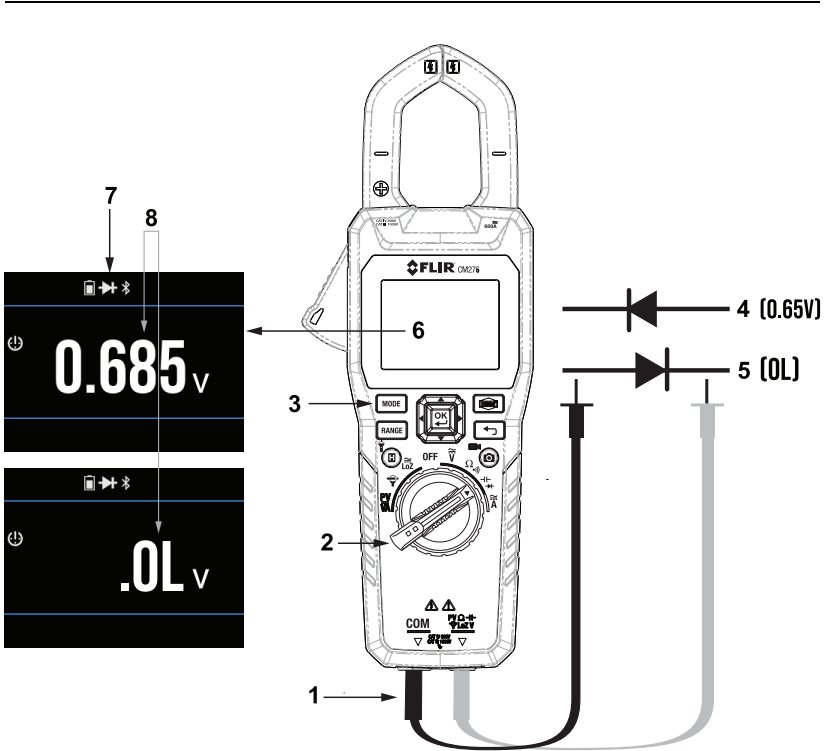

Figure 8.11 Classic diode test.

8.16 Smart Diode Test



WARNING

Do not perform diode tests before removing power to the diode under test. Injury to persons can occur.

In the Smart diode test mode, the meter applies an alternating test signal to the diode under test, allowing you to check the diode without having to reverse polarity by physically moving the test leads.

Refer to Section 8.15, above, for basic (classic) diode test instructions, if needed, and then continue with the steps below.

1. Set the function switch to the diode position \rightarrow .
2. Insert the black probe lead into the negative COM terminal and the red probe lead into the positive terminal.
3. Use the **MODE** button to select the diode test function. The diode indicator \rightarrow will be displayed.
4. Touch the tips of the probe across the diode or semiconductor junction under test.
5. If the reading is between ± 0.40 and **0.80 V**, the component is good.
6. If the reading shows **bAd** (component is open) or **O.L** (component is shorted), then the component is bad.
7. Refer to Figure 8.12, below, for a visual explanation of the test results.

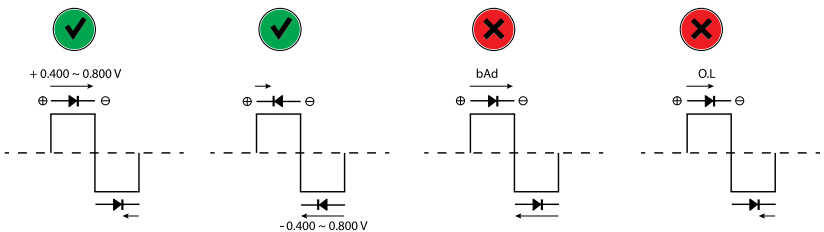



Figure 8.12 Smart diode operation.

8.17 Photovoltaic Power Measurements

	CAUTION
Use caution when the measured voltage is greater than 30 V DC.	

	WARNING
The TA85 photovoltaic test leads and TA86 MC4 photovoltaic plugs have a maximum input limit of 1.5 kV DC (CAT III 1500 V DC safety rating). Use the TA85 or TA86 with the CM276 function switch set to the PV/VA position only. Use standard test leads when setting the function switch to any other position.	

Refer to Figure 8.13, below, for the numbered items in this section. To obtain dedicated photovoltaic plugs (TA86) and/or PV test leads (TA85), contact your FLIR point of purchase.

1. Insert the TA85 or TA86 test leads into the CM276 test lead connectors.
2. Set the function switch to the PV/VA position. Note that if you choose any other switch position, with the TA85 or TA86 connected, an error message will appear (see image, below).

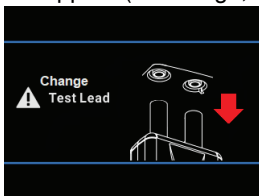

3. Connect the test lead probes or plugs to the solar panel. In Figure 8.13, below, the industry standard TA86 MC4 plugs are shown, these mate directly with most solar panel connectors, and are rated for 1.5 kV DC. Alternatively, you can use the TA85 test lead style PV probes, these are also rated for 1.5 kVA.
4. Press the jaw trigger to open the clamp.
5. Clamp around **only one** of the conductors in the circuit under test.
6. Short press the **MODE** button to select DC Power (kVA) with **DC A** or DC Power (kVA) with **DC V**.
7. Read the measurement on the display. See Section 8.17.1, below, for a display example.

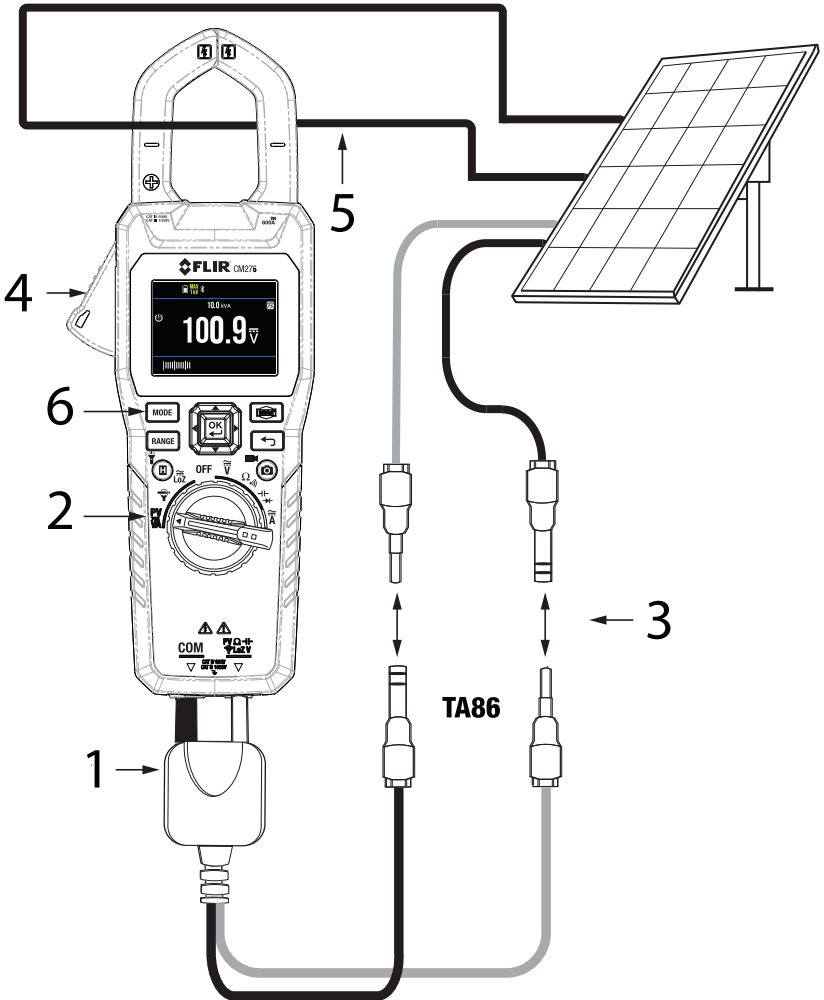
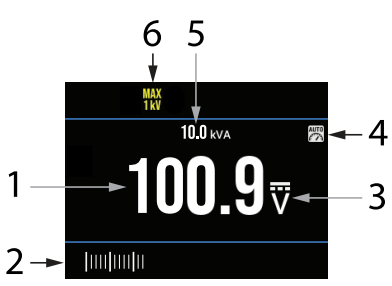

Figure 8.13 Photovoltaic Power Measurement Setup. Refer to the previous paragraph for the numbered references in this figure.

8.17.1 Photovoltaic Display Example

<ol style="list-style-type: none"> 1. Voltage or current reading (select with MODE button). 2. Bar graph representation of the reading. 3. Unit of measure (DC current or voltage, select with MODE button). 4. Auto Range icon (manual range is not available in this mode). 5. Power reading. 6. Safety warning. When the TA85 or TA86 test leads are connected, this display will indicate the 1.5 kV limit. When standard test leads are connected, this display will indicate the 1 kV limit. 	 <p>The image shows a digital display with a black background and white text. At the top, there are two labels '6' and '5' with arrows pointing to 'MAX 1kV' and '10.0 kVA' respectively. Below this, the main reading is '100.9 V' with a 'V' symbol and a horizontal bar graph below it. To the right of the main reading is a small icon labeled '4'. At the bottom left, there is a bar graph labeled '2'. On the left side of the display, there are labels '1' and '3' with arrows pointing to the main reading and the 'V' symbol respectively.</p> <p>Figure 8.14 Display example for Photovoltaic power measurements.</p>
--	---

9 Data Logger Operation

The CM276 can automatically log up to 40,000 readings in each of 10 sets. The data logger is operational in the thermal imaging mode and in the multi-meter mode of operation. However, only electrical measurements are logged.

Logged readings are stored as *.csv files (see Figure 9.1, below) in the meter's internal memory, and can be shared using the METERLiNK app (Section 11) or by connecting to a PC via the supplied USB cable (Section 12). Data log files can be easily opened in spreadsheet applications.

The data logger sampling rate is programmable from 1 to 100 seconds in the Advanced menu as explained below and in Section 6.5.

1. Set up the meter for the desired measurement application.
2. Press **OK** to open the main menu (Section 6.1).
3. Scroll to the Settings menu (Section 6.6) and press **OK** to open it.
4. Scroll down to the Device Settings menu (Section 6.6.4), and press **OK** to open it.
5. Use the arrow keys to select the desired sampling rate (1 to 100 seconds).
6. Press the Return button to exit to the main menu.
7. In the main menu, scroll to the Advanced Menu (Section 6.5), and press **OK** to open it.
8. Scroll to the data logger icon, and press **OK** to start the datalogger (a blue dot will appear next to the icon while the data logger is running).
9. To stop the data logger, press **OK** again at the data logger icon (the blue dot will disappear).
10. Records are stored in the meter's memory, see Section 6.4.3 and Section 11 (METERLiNK) for sharing data log records using the METERLiNK mobile app, or see Section 6.4.4 and Section 12 (PC Interface) for transferring readings to a PC via USB connection.

Device Model	Function Name	Function Index	Unit Name	Unit Index	OL Max	OL Min	Sampling Rate	Sampling Unit (second)
FLIR-CM276 (i)	AC Volt	0x09	Volt	0x02	60	0	1	2
NO	DATE	TIME	VALUE	POWER OF 10	UNIT	OUT OF RANGE		
0	10/31/2023	3:20:26	0.02		0 Volt			
1	10/31/2023	3:20:28	0.02		0 Volt			
2	10/31/2023	3:20:30	0.02		0 Volt			
3	10/31/2023	3:20:32	0.02		0 Volt			
4	10/31/2023	3:20:34	0.02		0 Volt			
5	10/31/2023	3:20:36	0.02		0 Volt			
6	10/31/2023	3:20:38	0.02		0 Volt			

Figure 9.1 Example of data logger *.csv file

10 Maximum, Minimum, and Average Readings

The CM276 monitors the highest, lowest, and average electrical readings. To view these readings, follow the steps below. This feature was covered in some detail in Section 6.5.2, and in the sub-subsections referenced in the steps below.

1. With the meter measuring an electrical signal, press the **OK** button to open the main menu (Section 6).
2. Scroll to the Advanced Menu icon, and press **OK**.
3. Scroll to the MAX/MIN/AVG function icon , and press **OK**. A blue dot will appear next to the icon, indicating that the function is enabled.
4. The highest, lowest, and average readings (from left to right) will be shown above the main measurement display, as shown in Figure 10.1, below.
5. To close this function, repeat steps 1, 2, and 3, above. Use the Return button to exit the menus and return to the normal display mode.

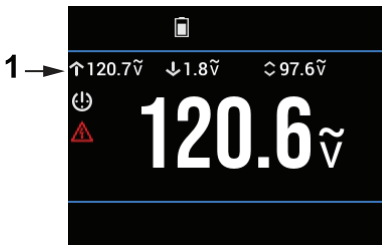



Figure 10.1 Maximum, Minimum, and Average reading display. Item 1, in the figure, shows the row where the reading memories are displayed.

11 METERLiNK Mobile App

Images, video, and data log records can be shared with mobile devices (wirelessly, with Bluetooth), using the FLIR METERLiNK® application. Download the METERLiNK user manual from the FLIR support site. Download the app from the App Store® (iOS® devices) or Google Play™ (Android™ devices).

The maximum communication distance between the meter and the mobile device is 32 ft. (10 m).

After downloading and opening the app on your mobile device, follow the steps below. These steps were covered earlier in some detail, please see the referenced sections, below, for complete instructions.

1. In the Device Settings menu (Section 6.6.4), switch the Bluetooth utility ON (*Main Menu > Settings > Device Settings*).
2. Press **OK** on the Gallery icon in the main menu (Section 6.4), and select either *Images/Video* or *Data Logs*.
3. Press **OK** on an image, video, or data log file to select it.
4. With an image, video, or data log open, press **OK** to show the option icons on the bottom of the display.
5. Scroll to the *Transmit* icon  and press **OK** to share files with your mobile device. Note that video length is limited to 20 seconds when sharing.

12 PC Interface

The CM276 is compatible with Windows® PCs, allowing you to download images, videos, and data log records. You can also upgrade the meter's firmware by loading a firmware update file (obtained from the FLIR support site) to the meter, as explained in Section 13.3.

The meter connects to the PC using the supplied USB-A to USB-C cable. The meter's USB port is located in the rear compartment. When connected, the PC recognizes the meter as a standard external storage drive. There's a folder for images/video and a folder for data log records in the meter's memory, simply drag the files from the folders to the PC.

Additional information can be found in the Specifications (Section 14) and in the Gallery menu (Section 6.4).

13 Maintenance

13.1 Cleaning

Wipe the meter housing with a soft, damp cloth and mild detergent when necessary. Do not use solvents or abrasives to clean the meter.

When cleaning the display and the lenses, use a very soft, lint-free, lens cloth and a high quality lens cleaner. Use a lint free swab to clean the recessed lenses. Use extra caution when cleaning the display and lenses, as scratching and other damage can result if wiped too vigorously with a rough or hard material.

13.2 Recharging the Battery

 CAUTION
Do not use this meter for measurement while charging.
The internal rechargeable lithium battery is not user serviceable. For replacement or repairs, please contact FLIR support. https://flir.support.com

NOTE

The minimum charger voltage and current rating is 5V and 1A. Do not attempt to charge the meter with a charger that has a lower rating.

Recharge the battery by connecting the supplied USB-C cable to the meter's USB-C port and to a 5 V charger with a minimum rating of 1A (ampere). The meter's USB-C port is located in the meter's rear compartment. Use a screwdriver or a coin to unlock and lock the compartment.

The meter's battery status icon will animate while charging. When the charging cable is disconnected, the battery status icon will return to its normal stationary appearance.

The meter will run for approximately 12 hours in IGM mode with the screen brightness set to medium, and for 16 hours in Multimeter mode with the screen brightness set to medium.

13.3 Upgrading the CM276 Firmware

13.3.1 General

If you are not confident that you can complete the upgrade successfully, please contact our customer support site:

<https://support.flir.com>

13.3.2 Prerequisites

To upgrade the firmware, you will need:

- CM276 meter.
- Windows PC and USB cable.
- Firmware upgrade file obtained from the support site, as explained below.

13.3.3 Obtaining the Firmware Upgrade File

1. Go to the support site: <https://support.flir.com>
2. Click on the **DOWNLOADS** menu heading, as shown.

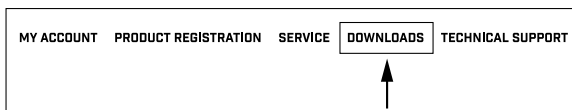

Figure 13.1 Click 'DOWNLOADS'.

3. Click **Software and Firmware** as shown.

Software and Firmware [login needed]

Figure 13.2 Click the 'Software and Firmware' item from the options list.

4. Type your **Email Address** to log in or to create an account, as shown. Click **Continue**.

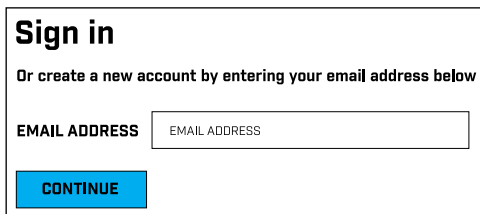
A 'Sign in' form with the following elements: the title 'Sign in' in bold; the text 'Or create a new account by entering your email address below'; a label 'EMAIL ADDRESS' followed by a text input field containing the placeholder text 'EMAIL ADDRESS'; and a blue button labeled 'CONTINUE'.

- For Figure 13.3, below, 1. Type **CM276** in the search field; 2. Select **FLIR / Extech Meters Software** from the pull-down menu; 3. Select **FLIR Software** from the pull-down menu; 4. Click **SEARCH**; 5. Click the upgrade file to download it to your PC.

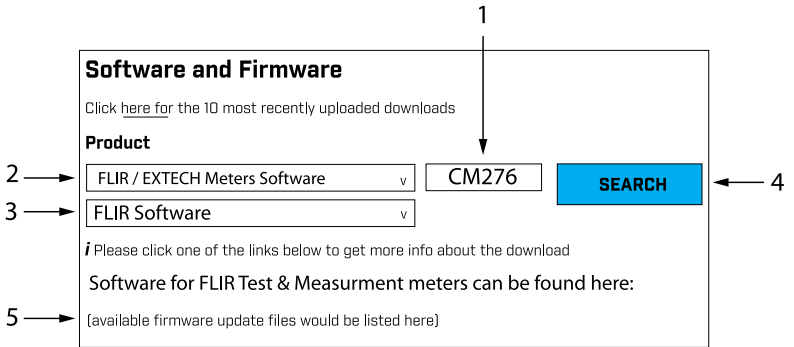

Figure 13.3 Follow the steps to complete the download process.

13.3.4 Firmware Upgrade Procedure

NOTE

The CM276 battery must be charged to at least 50% before continuing.

- With the meter switched off, open the rear compartment to access the USB port.
- Connect the meter to the PC using the supplied USB cable.
- The PC should now recognize the CM276 as an external storage drive.
- Move the firmware file from your PC to the root (top level) directory of the CM276.



CAUTION

Drag only the upgrade file into the CM276 root directory. Do not drag other files or folders that may accompany the upgrade file (*readme.txt*, for example).

Do not copy the upgrade file to the DCIM or DLOG folder.

Do not change the filename of the upgrade file.

- Safely eject the CM276 from the PC (right-click the drive letter in File Explorer and select Eject).
- Physically disconnect the CM276 from the PC.

7. Disconnect the USB cable from the CM276 and switch the meter on.
8. Select 'YES' when prompted by the meter to upgrade the firmware.

**CAUTION**

Do **NOT** switch OFF the CM276 while it is upgrading. If the meter is switched off during the upgrade process, it may not be recoverable and would have to be returned to FLIR for service.

9. If the CM276 does not automatically cycle power after the upgrade, manually power the meter off and on.
10. When the CM276 restarts, note the firmware version as displayed in the *Information* sub-menu in the CM276 *Settings* menu.
11. If you require assistance, please visit the customer support site.
<https://support.flir.com>

13.4 Disposal of Electronic Waste

As with all electronic products, this equipment must be disposed of in an environmentally friendly way, and in accordance with existing regulations for electronic waste.

Please contact your FLIR Systems representative for more details.

13.5 System Reset

If the meter display freezes, or if the meter is otherwise unresponsive, a full hardware reset can be performed. To do so, press the **HOLD** and **Imager** buttons for 10 seconds, the meter will reset and restart. To perform a factory default reset, refer to the *Information Menu*, Section 6.6.5.

14 Specifications

14.1 General Specifications

Display type	Digital 6000 count TFT 2.4 in. (6.1 cm) color display with bar graph
AC measurement type	True RMS
Measurement rate	3 times per second
Over-range indication	OL is displayed (bar graph shows arrow symbol to right of bar)
Worklights	Two (2) high power LED lamps
Calibration	One-year calibration cycle
Operating temperature	14 to 86°F (-10 to 30°C) (\leq 85% RH)
	86 to 104°F (30 to 40°C) (\leq 75% RH)
	104 to 122°F (40 to 50°C) (\leq 45% RH)
Storage temperature	4 to 140°F (-20 to 60°C); 0 to 80 % RH
Operating Relative humidity	0 to 80 % RH
Temperature coefficient	0.2 × (specified accuracy)/°C, <64.4°F (18°C), >82.4°F (28°C)
Operating altitude	6562 ft. (2000 m)
Clamp jaw opening	1.38 in. (35 mm)
Pollution degree	2
IP rating	IP 40
Drop-test	6.6 ft. (2 m)
Dimensions	(D × W × L): 2.0 × 3.9 × 10.7 in. (51.5 × 100 × 272 mm)
Weight	19.8 oz. (560 g)
Over-voltage categories	EN 61010-1 CAT IV-600 V, CAT III-1000 V, EN 61010-2-032
Category III applications	Distribution circuits, machinery, main switching devices close to switch gears, industrial installations and high current close to distribution circuits
Category IV applications	Installation sources, utility transformers, all outside conductors, counters, protective devices on primary sides and electricity meters

14.2 Meter Power

Meter power	Rechargeable 3.7 V (5400 mAH) lithium polymer battery (internal) Minimum charger rating is 5V and 1A, do not charge the meter with a lower rated charger.
Battery status indications	Battery symbol  and low battery text-based information screens
Battery life	12 hours in IGM mode. 16 hours in Multimeter mode. These durations are approximate and are specified for a display brightness set to medium.
Auto Power Off (APO)	Device: 2, 5, or 10 minutes (or OFF) Worklight: 5, 15, 30 minutes (or OFF)

14.3 Thermal Imaging

Detector type	FLIR Lepton microbolometer Focal Plane Array (FPA)
Image modes	Thermal MSX (Multi-Spectral Dynamic Imaging) Thermal Camera (IR) only Digital Camera (visible light) only
Thermal sensitivity	150 mK
IR imaging resolution	160 x 120 pixels (19,200 pixels)
IR imaging field of view	44° x 57° (vertical x horizontal)
IR imaging spectral response	8 to 14 μ m
IR image capture frequency	9 Hz
IR image color palettes	Iron, Rainbow, White Hot, Black Hot
Shutter	Integrated, automatic shutter
Stored thermal image radiometry	Fully radiometric, each image pixel stores temperature measurement data
IR temperature measurement range	14°F to 572°F (-10°C to 300°C)
Temperature reading stabilization	Approximation symbol (~) is shown before the temperature reading for approximately 30 seconds while stabilizing.

IR temperature resolution	0.1 °F (0.1 °C)
IR temperature accuracy	5.4 °F ($\pm 3^{\circ}\text{C}$) or $\pm 3\%$ of reading; whichever is greater
Temperature scanning	Continuous
Emissivity	4 presets plus a custom setting (0.10 to 1.00). Default setting is 0.95
Targeting	Cross hairs and Laser pointer targeting
Laser pointer	Class A (industrial and commercial use)
Laser pointer power	≤ 0.39 mW
Laser pointer wavelength	640 to 660 nm

14.4 Visual Imaging (Digital Camera)

Resolution	2 MP (1600 x 1200 pixels)
Focus	Fixed
Field of View (FOV)	56° x 71° (vertical x horizontal)

14.5 Thermal Image and Video Storage

Thermal image storage type and size	eMMC 8 GB
Thermal image file format	Radiometric (each pixel contains temperature measurement data)
Thermal image storage limits	30,000 images
Video recording	50 minutes maximum duration (20 seconds for file sharing)

14.6 Data Logger Memory

Data logger sampling interval	1 to 99 seconds (selectable)
Data log reading limits	40,000 reading per set (10 set limit)
Sharing data logs	Data log records can be shared using the METERLiNK mobile app or by physically connecting the meter to a PC (USB).

14.7 Wireless Connectivity

Wireless technology	Bluetooth BLE
Communications protocol	METERLiNK mobile application
Bluetooth range	32 ft. (10 m)

14.8 Electrical Specifications

Accuracy is \pm (% reading + number of digits (dgt)) at 73.4°F \pm 9°F (23°C \pm 5°C), <80% RH.

14.8.1 Voltage Measurements (True RMS)

Function	Range	Accuracy (of reading)
DC V	60.00 V	\pm (1.0% + 5 dgt)
	600.0 V	
	1000 V	
AC V	60.00 V	\pm (1.0% + 5 dgt) 45 to 400 Hz
	600.0 V	
	1000 V	
AC V VFD	60.00 V	\pm (1% + 5 dgt) 45 to 65 Hz
	600.0 V	
	1000 V	\pm (5% + 5 dgt) 65 to 400 Hz
Lo Z	Range, resolution, and accuracy specifications for Low Impedance (Lo Z) measurements are the same as DC V, AC V, or VFD specifications (depending on which mode is selected). In Lo Z mode the meter maximum impedance is typically 2.5 kHz but can vary from 1.8 and 3.0 kHz under certain conditions.	

Notes	<i>LCD Displays '0' counts when the AC reading is <10 counts</i>
	<i>Overload protection: 1000 V (RMS)</i>
	<i>Input impedance: 10 MΩ //, <100 pF</i>
	<i>Lo Z input impedance: 2.5kΩ</i>
	<i>AC conversion type: AC coupled, true RMS responding, calibrated to the RMS value of a sine wave input. Accuracies are given for sine waves at full scale and non-sine waves below half scale.</i>
	<i>If the meter measures a 4000 count signal and the Crest Factor of the signal is more than 3.0, the reading may not meet specified tolerances. For non-sine waves (50/60 Hz), add the following Crest Factor corrections:</i>
	<i>For a crest factor of 1.0–2.0, add 3.0% to the accuracy</i>
	<i>For a crest factor of 2.0–2.5, add 5.0% to the accuracy</i>
	<i>For a crest factor of 2.5–3.0, add 7.0% to the accuracy</i>

14.8.2 Current Measurements (True RMS)

Function	Range	Accuracy (of reading)
DC A	60.00 A	± (2.0% + 5 dgt)
	600.0 A	
AC A	60.00 A	± (2.0% + 5 dgt) 45 to 400 Hz
	600.0 A	
AC A VFD	60.00 A	± (2% + 5 dgt) 45 to 65 Hz ± (6% + 5 dgt) 65 to 400 Hz
	600.0 A	

Notes	<i>LCD Displays '0' counts when the AC reading is <10 counts</i>
	<i>Overload protection: 600 A (RMS)</i>
	<i>Position error: 1% of reading</i>
	<i>AC conversion type: AC coupled, true RMS responding, calibrated to the RMS value of a sine wave input. Accuracies are given for sine waves at full scale and non-sine waves below half scale.</i>
	<i>If the meter measures a 4000 count signal and the Crest Factor of the signal is more than 3.0, the reading may not meet specified tolerances. For non-sine waves (50/60 Hz), add the following Crest Factor corrections:</i>
	<i>For a crest factor of 1.0–2.0, add 3.0% to the accuracy</i>
	<i>For a crest factor of 2.0–2.5, add 5.0% to the accuracy</i>
	<i>For a crest factor of 2.5–3.0, add 7.0% to the accuracy</i>

14.8.3 Clamp Adaptor Input

Function	Range	Accuracy (of reading)
AC A	30.00 A	± (1% + 5 dgt) 45 to 400 Hz
	300.0 A	
	3000 A	
Notes	<i>Display shows '0' counts when the reading is < 10 counts</i>	

14.8.4 Inrush Current

Function	Range	Accuracy (of reading)
AC A Inrush	30.00 A	± (3% + 0.3 A)
	300.0 A	± (3% + 5 dgt)
	3000 A	
Notes	<i>Inrush current detection threshold: 0.5 A for 60 A range and 5.0 A for 600.0 A range</i>	
	<i>Overload protection: 1000 V (RMS), 600 A (RMS)</i>	
	<i>Integration time is 100 ms</i>	

14.8.5 Resistance and Continuity

Function	Range	Accuracy (of reading)
Resistance	600.0 Ω	\pm (1.0% + 5 dgt)
	6.000 K Ω	
	60.00 K Ω	
Continuity	< 30 Ω beeper ON >150 Ω beeper OFF	
Notes	Overload protection: 1000 V RMS	
	Maximum open circuit voltage for resistance: 1.8 V	
	Continuity indicator: 2.7 kHz tone buzzer	
	Continuity response time: <100 ms	

14.8.6 Capacitance

Function	Range	Accuracy (of reading)
Capacitance	1 μ F to 1000 μ F	\pm (1.0% + 4 dgt)
Notes	Overload Protection: 1000 V RMS	

14.8.7 Diode Testing

Function	Range	Accuracy (of reading)
Diode testing	1.500 V	\pm (1.5% + 4 dgt)
Notes	Overload Protection: 1000 V RMS	

14.8.8 Photovoltaic (PV) Measurements

Function	Range	Accuracy (of reading)
DC Voltage	1500 V DC	\pm (2%)
DC Power	900 kW	\pm (2%)

14.9 Agency Approvals and Certifications

Certifications	UL, CE, FCC, UKCA, FDA, Energy	
Safety standards	IEC/UL 61010-1; IEC/UL 61010-031; IEC/UL 61010-2-032; IEC/UL 61010-2-033 (CAT IV-600 V, CAT III-1000 V)	
EMC	EN 61326-1, EN 61326-2-2, EN 300328, EN 301489, FCC part 15B	

Laser standards	IEC 60825-1:2014, EN 60825-1:2014+A11:2021; CDRH
Energy standards	CEC; DOE; NRCan

15 Appendices

15.1 Emissivity Values for Common Materials

Table 15.1 Approximate Emissivity values for common materials (for reference only).

Material	Emissivity	Material	Emissivity
Asphalt	0.90 to 0.98	Cloth (black)	0.98
Concrete	0.94	Skin (human)	0.98
Cement	0.96	Leather	0.75 to 0.80
Sand	0.90	Charcoal (powder)	0.96
Soil	0.92 to 0.96	Lacquer	0.80 to 0.95
Water	0.92 to 0.96	Lacquer (matt)	0.97
Ice	0.96 to 0.98	Rubber (black)	0.94
Snow	0.83	Plastic	0.85 to 0.95
Glass	0.90 to 0.95	Timber	0.90
Ceramic	0.90 to 0.94	Paper	0.70 to 0.94
Marble	0.94	Chromium Oxides	0.81
Plaster	0.80 to 0.90	Copper Oxides	0.78
Mortar	0.89 to 0.91	Iron Oxides	0.78 to 0.82
Brick	0.93 to 0.96	Textiles	0.90

15.2 IR Energy and Imaging Overview

A thermal imager generates an image based on temperature differences. In a thermal image, the hottest item in the scene appears as white and the coldest item as black. All other items are represented as a gray scale value between white and black. The camera also offers color images to simulate hot (lighter colors) and cold (darker colors) temperatures.

It may take some time to get used to the thermal imagery. Having a basic understanding of the differences between thermal and daylight cameras can help with getting the best performance from the camera.

One difference between thermal and daylight cameras has to do with where the energy comes from to create an image. When viewing an image with an ordinary camera, there has to be some source of visible light (something hot, such as the sun or other lighting) that reflects off the objects in the scene to the camera. The same is true with human eyesight; the vast majority of what

people see is based on reflected light energy. On the other hand, the thermal imager detects energy that is directly radiated from objects in the scene.

This is why hot objects such as parts on engines and exhaust pipes appear white, while the sky, puddles of water and other cold objects appear dark (or cool). Scenes with familiar objects will be easy to interpret with some experience.

Infrared energy is part of a complete range of radiation called the electromagnetic spectrum. The electromagnetic spectrum includes gamma rays, X-rays, ultraviolet, visible, infrared, microwaves (RADAR), and radio waves. The only difference is their wavelength or frequency. All of these forms of radiation travel at the speed of light. Infrared radiation lies between the visible and RADAR portions of the electromagnetic spectrum.

The primary source of infrared radiation is heat or thermal radiation. Any object that has a temperature radiates in the infrared portion of the electromagnetic spectrum. Even objects that are very cold, such as an ice cube, emit infrared. When an object is not quite hot enough to radiate visible light, it will emit most of its energy in the infrared. For example, hot charcoal may not give off light, but it does emit infrared radiation, which we feel as heat. The warmer the object, the more infrared radiation it emits.

Infrared imaging devices produce an image of invisible infrared or “heat” radiation that is unseen by the human eye. There are no colors or “shades” of gray in infrared, only varying intensities of radiated energy. The infrared imager converts this energy into an image that we can interpret.

The FLIR Infrared Training Centre offers training (including online training) and certification in all aspects of thermography:
<http://www.infraredtraining.com>.

16 CUSTOMER SUPPORT

Customer support and documentation downloads are available at the link below.

<https://support.flir.com>

17 Warranty

This device is protected by the FLIR Limited 10-Year Warranty. Read the warranty document at the link below.

<https://flir.com/testwarranty>



Website

<http://www.flir.com>

Customer support

<http://support.flir.com>

Copyright

© 2024, FLIR Systems, Inc. All rights reserved worldwide.

Disclaimer

Specifications subject to change without further notice. Models and accessories subject to regional market considerations. License procedures may apply. Products described herein may be subject to US Export Regulations. Please refer to exportquestions@flir.com with any questions.

Publ. No.: NAS100167
Release: AA
Commit: 95680
Head: 95684
Language: en-US
Modified: 2024-01-23
Formatted: 2024-01-23

