

Technical Information

Liquiline Compact CM82

Configurable multiparameter transmitter for Memosens sensors



Space-saving transmitter for monitoring and controlling processes in industry and the environmental sector

Application

The CM82 can be used in all sectors and by plant manufacturers in these sectors and supports all sensors with the blue Memosens plug-in head:

- pH, ORP and pH-ORP combined electrodes
- Conductive conductivity
- Oxygen

Direct connection to PLC via:

- 4 to 20 mA
- HART
- Bluetooth® LE interface for commissioning and maintenance

Your benefits

- Space-saving installation and storage:
 - The two-wire device fits into an assembly and does not require a separate power supply.
 - Minimum inventory
- Maximum safety:
 - Tried and trusted Memosens technology
- Easy operation
 - Use your existing tablet and smartphone for operation and commissioning.
 - Standardized operating concept across all devices from the Liquiline platform
- Fast and reliable
 - A reliable Bluetooth® LE connection allows you to check measuring points that are dangerous or difficult to access from a safe distance.
- Suitable for all locations
 - Regardless of whether your measuring point is exposed to dust, steam, rain, snow, heat or cold, the CM82 is always exactly the transmitter you need!

Function and system design

Measuring system

The overview shows examples of measuring systems. Other sensors and assemblies can be ordered for conditions specific to your application (www.endress.com/products).

A complete measuring system comprises:

- Liquiline compact transmitter
- Sensors with Memosens technology
- Assemblies to suit the sensors used

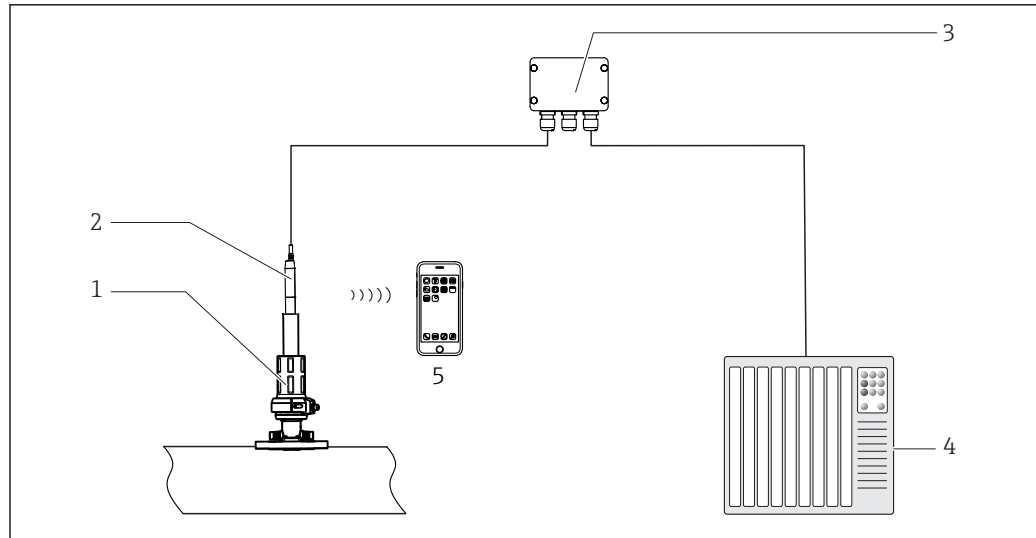

A0036772

1 Example of a measuring system

- 1 Measuring point with assembly and Memosens sensor
- 2 Liquiline Compact CM82
- 3 Junction box, optionally available
- 4 PLC (programmable logic control)
- 5 Bluetooth LE optional for mobile terminals, e.g. tablets

Application example



2 Application example in a fermenter, using a tablet for operation

A0035115

Communication and data processing

Types of communication:

- 4 to 20 mA
- HART fieldbus
- Bluetooth® LE wireless technology (optional)



The device drivers available make it possible to perform a basic setup and display measured values and diagnostics information via the fieldbus. Full device configuration is possible via the fieldbus and Bluetooth.

Dependability

Reliability

Memosens

Memosens makes your measuring point safer and more reliable:

- Non-contact, digital signal transmission enables optimum galvanic isolation
- No contact corrosion
- Completely watertight
- Sensor can be calibrated in a lab, thus increasing the availability of the measuring point in the process
- Predictive maintenance thanks to recording of sensor data, e.g.:
 - Total hours of operation
 - Hours of operation with very high or very low measured values
 - Hours of operation at high temperatures
 - Number of steam sterilizations
 - Sensor condition



A0035116

3 Plug & Play with Memosens technology

The status of the transmitter and the connected sensor is indicated by a red/green LED.



A0036843

4 LED display

USP and EP

- "Water for Injection" (WFI) as per USP <645> and EP
- "Highly Purified Water" (HPW) as per EP
- "Purified Water" (PW) as per EP

The uncompensated conductivity value and the temperature are measured for the USP/EP limit functions. The measured values are compared against the tables defined in the standards. An alarm is triggered if the limit value is exceeded. Furthermore, it is also possible to configure an early warning alarm that signals undesired operating states before they occur.

Safety

Safe signal transmission via Bluetooth® LE

Signal transmission via Bluetooth® wireless technology uses a cryptographic technique tested by the Fraunhofer Institute.

Security levels for Endress and Hauser Bluetooth infrastructure: ¹⁾:

- Protocol: **High**
- Algorithms: **High**

Measured against:

- the security objectives, e.g. confidentiality, integrity, availability, etc.
- the risk analysis, e.g. key distribution, authentication, password recovery, etc.
- the attack model, e.g. motivation for attack, time required, expertise in electronics, etc.
- the weak-point analysis

For comparison: The general Bluetooth standard is classified as "Low".

Protection against unauthorized access:

- Password-protected
- Without the SmartBlue app, the device is not visible via Bluetooth® wireless technology.
- Only one point-to-point connection is established between a sensor and a smartphone or tablet.

1) Multi-level scale for security assessments in accordance with Fraunhofer AISEC cryptographic technique: "Very low", "Low", "High", "Very high"

- The Bluetooth® wireless technology interface can be disabled via SmartBlue.
- Bluetooth® is optional. It can be ordered with this functionality enabled.
If ordered with Bluetooth® disabled, Bluetooth® can be enabled at a later stage by means of an activation code (accessory kit) linked to the serial number.
- A disabled Bluetooth® interface can be re-enabled only via HART.

Measured value compensation

pH:

Temperature

Oxygen:

- Temperature
- Air pressure

Conductivity:

Temperature

Various methods are available to compensate for the temperature dependency:

- Linear
- NaCl (IEC 746-3)
- Water ISO7888 (20°C)
- Water ISO7888 (25°C)

IT security

Our warranty is valid only if the device is installed and used as described in the Operating Instructions. The device is equipped with security mechanisms to protect it against any inadvertent changes to the settings.

IT security measures, which provide additional protection for the device and associated data transfer, must be implemented by the operators themselves in line with their security standards.

Input

Measured values	The transmitter is designed for digital Memosens sensors with inductive plug-in head: <ul style="list-style-type: none"> ▪ pH, ORP. pH/ORP combined sensors ▪ Conductive Conductivity ▪ Dissolved oxygen
Measuring ranges	→ Documentation of the connected sensor
Types of input	Digital sensor inputs for Memosens-sensors
Cable specification	Cable length: <ul style="list-style-type: none"> ▪ Max. 3 m (10 ft) ▪ Max. 7 m (23 ft) ▪ Max. 15 m (49 ft)

Output

Output signal	4 ... 20 mA/HART, galvanically isolated from the sensor circuits
Linearization/transmission behavior	Linear

Power supply

Supply voltage	12.6 to 30 VDC (with setting error current > 20 mA)
	14 to 30 VDC (with setting error current < 4 mA)

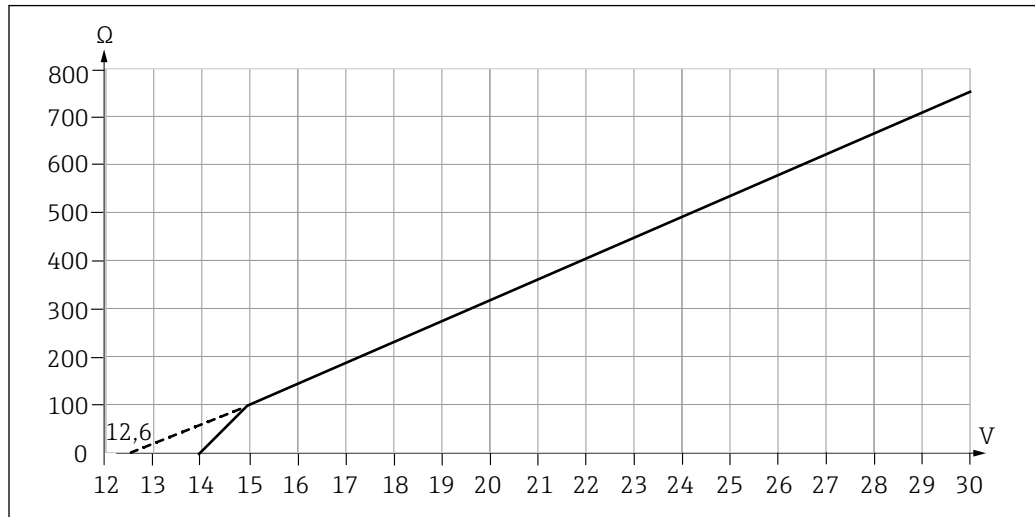

A0036752

5 Supply voltage and load

The lower voltage value in each case applies only to a load resistance of 0 Ohm.

NOTICE

The device does not have a power switch

- ▶ At the supply point, the power supply must be isolated from dangerous live cables by double or reinforced insulation in the case of devices with a 24 V power supply.

Overvoltage protection	IEC 61 000-4-4 and IEC 61 000-4-5 with +/- 1 kV
-------------------------------	---

Sensor connection	<i>Sensors with Memosens protocol</i>
--------------------------	---------------------------------------

Sensor types	Sensors
Digital Sensors with inductive memosens plug head	<ul style="list-style-type: none"> ▪ pH sensors ▪ ORP sensors ▪ pH/ORP combination sensors ▪ Oxygen sensors ▪ Conductivity sensors

Performance characteristics

Response time of current output	t_{90} = max. 500 ms for an increase from 0 to 20 mA
--	--

Tolerance of current output	<p>Typical measuring tolerances:</p> <ul style="list-style-type: none"> < $\pm 20 \mu\text{A}$ (if current value = 4 mA) < $\pm 50 \mu\text{A}$ (for current values 4 to 20 mA) <p>at 25 °C (77 °F) each</p> <p>additional tolerance depending on the temperature:</p> <ul style="list-style-type: none"> < $1.5 \mu\text{A/K}$
------------------------------------	--

Resolution of current output	< $5 \mu\text{A}$
-------------------------------------	-------------------

Repeatability → Documentation of the connected sensor

Environment

Ambient temperature range -20 to +85 °C (0 to 185 °F)

 The maximum ambient temperature depends on the process temperature and the installation situation of the transmitter.

Make sure that the ambient temperature at the transmitter does not exceed +85 °C (185 °F).

Example of environmental conditions in Endress+Hauser fittings:

- with open installation (without protective cover, i.e. free convection at the transmitter), e.g. CPA442, CPA842
- for enclosed installation (with protective cover), e.g. CPA871, CPA875, CPA842

$T_{\text{ambient}} = \text{max. } 60 \text{ °C (140 °F)}$

$T_{\text{prozess}} = \text{max. } 100 \text{ °C (212 °F)}$, in continuous operation

$T_{\text{prozess}} = \text{max. } 140 \text{ °C (284 °F)}$, < 2h (for sterilization)

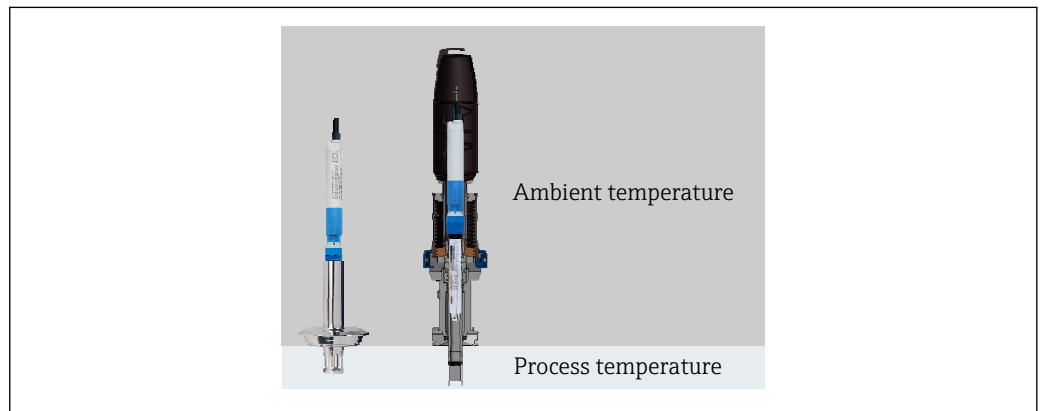

A0036933-EN

 6 Mounting situation of the transmitter with or without protective cover

Storage temperature -40 to +85 °C (-40 to 185 °F)

Humidity 5 to 95 %

Degree of protection IP 67
IP 68
NEMA Type 6

Electromagnetic compatibility

- EN 61326-1
- EN 61326-2-3
- EN 301489-1
- EN 301489-17
- NAMUR NE 21

Electrical safety EN 61010-1

Max. altitude above MSL < 2000 m (< 6562 ft) above MSL

Degree of contamination	Complete device:	Pollution level 4
	Internal:	Pollution level 2

Radio standards

- EN 300 328 (Europa)
- 47 CFR 15.247 (USA)
- RSS-247 Issue 1 (Kanada)
- RSS-GEN Issue 4 (Kanada)

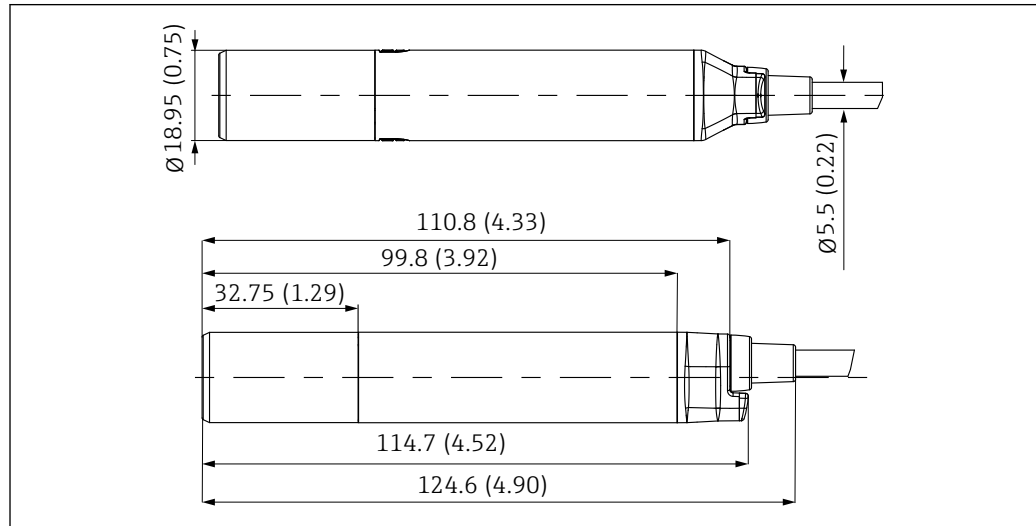
Mechanical construction**Dimensions**

A0033272

7 Dimensions in mm (inch)

Materials

Components	Material
Housing, cover	Peek 151
Strain relief	EPDM (peroxide crosslinked)
Axial ring	Peek 450 G
Optical waveguide	PC transparent

Impact loads

The product is designed for mechanical impact loads of 1 J (IK06) as per the requirements of EN61010-1.

Weight

without cable	Approx. 42 g (1.5 oz)
3 m (9 f) cable	Approx. 190 g (7 oz)
7 m (23 f) cable	Approx. 380 g (13 oz)
15 m (49 f) cable	Approx. 760 g (27 oz)
For every 1 m (3 f) of cable	Approx. 48 g (2 oz)

Operability**Operating concept**

- Bluetooth® LE wireless technology
- HART

Operation via SmartBlue (app)

SmartBlue is available as a download for Android terminals from the Google Playstore and for iOS devices from the Apple iTunes Store.

If you scan the QR code, you will be brought directly to the app:



A0031189-EN

8 Download links

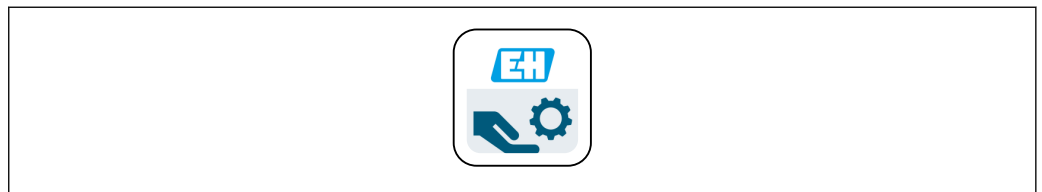

A0029747

9 SmartBlue App



A0035117

10 Livelist

The Livelist displays all of the devices that are within range.

System requirements

- iOS devices: iPhone 4S or higher from iOS9.0; iPad2 or higher from iOS9.0; iPod Touch 5. Generation or higher from iOS9.0
- Devices with Android: from Android 4.4 KitKat and Bluetooth® 4.0

Remote operation

HART

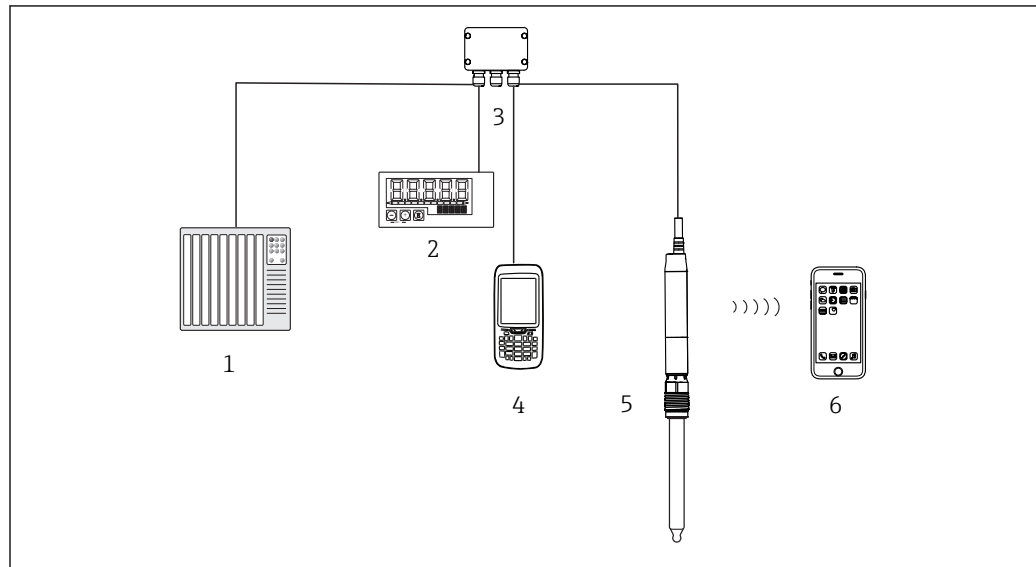

11 Wiring options for remote operation via HART protocol

- 1 PLC (programmable logic control)
- 2 RIA15 loop-powered process indicator, optional
- 3 Junction box
- 4 HART operating device (e.g. Fieldcare), optional
- 5 Transmitter with optional Bluetooth® LE wireless technology
- 6 Optional: Smartphone / tablet with SmartBlue (app)

Certificates and approvals

CE mark

Endress+Hauser Conducta GmbH+CO. KG hereby declares that the radio system type CM82 complies with directives 2014/53/EU and 2011/65/EU.

The complete text of the EU declaration of conformity can be found at the following web address: <http://www.endress.com/CM82>

Frequency band: 2400-2483.5 MHz, power output: < 10dBm EIRP

FCC/IC

Radio approval for USA/Canada

This device complies with Part 15 of the FCC Rules [and with Industry Canada license- exempt RSS standard(s)]. Operation is subject to the following two conditions: (1) this device may not cause harmful interference, and (2) this device must accept any interference received, including interference that may cause undesired operation.

Any changes or modifications made to this equipment not expressly approved by Endress+Hauser may void the FCC authorization to operate this equipment. This device complies with Part 15 of the FCC Rules and with Industry Canada license- exempt RSS standard(s).

Operation is subject to the following two conditions:

- this device may not cause harmful interference, and
- this device must accept any interference received, including interference that may cause undesired operation.

Le présent appareil est conforme aux CNR d'Industrie Canada applicables aux appareils radio exempts de licence. L'exploitation est autorisée aux deux conditions suivantes:

- l'appareil ne doit pas produire de brouillage, et
- l'utilisateur de l'appareil doit accepter tout brouillage radioélectrique subi, même si le brouillage est susceptible d'en compromettre le fonctionnement.

Note: This equipment has been tested and found to comply with the limits for a Class B digital device, pursuant to part 15 of the FCC Rules. These limits are designed to provide reasonable protection against harmful interference in a residential installation. This equipment generates, uses

and can radiate radio frequency energy and, if not installed and used in accordance with the instructions, may cause harmful interference to radio communications. However, there is no guarantee that interference will not occur in a particular installation. If this equipment does cause harmful interference to radio or television reception, which can be determined by turning the equipment off and on, the user is encouraged to try to correct the interference by one or more of the following measures:

- Increase the separation between the equipment and receiver.
- Consult the dealer or an experienced radio technician for help.

Radio approval for Japan

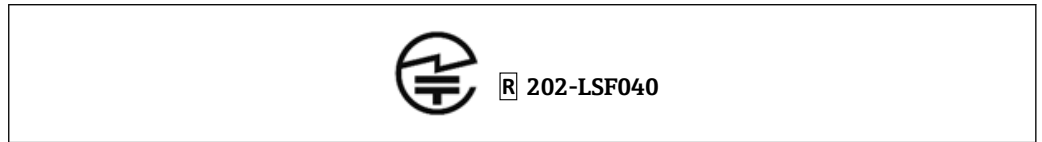

Japanese Radio Law and Japanese Telecommunications Business Law Compliance. This device is granted pursuant to the Japanese Radio Law (電波法). This device should not be modified (otherwise the granted designation number will become invalid).

Radio approval for China

Certification number: **CMIIT ID: 2017DJ6495**

Radio approval for South Korea

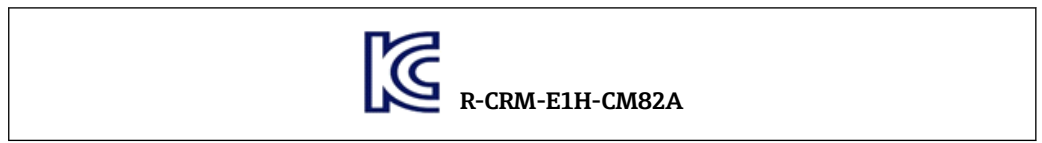

Brazil radio approval



Mexico radio approval

In development

Ordering information

Product page

www.endress.com/CM82

Product Configurator

On the product page there is a **Configure** button to the right of the product image.

1. Click this button.
 - ↳ The Configurator opens in a separate window.
2. Select all the options to configure the device in line with your requirements.
 - ↳ In this way, you receive a valid and complete order code for the device.
3. Export the order code as a PDF or Excel file. To do so, click the appropriate button on the right above the selection window.

 For many products you also have the option of downloading CAD or 2D drawings of the selected product version. Click the **CAD** tab for this and select the desired file type using picklists.

Scope of delivery

The scope of delivery includes:

- CM82
- Brief Operating Instructions

Accessories

Sensors

Glass electrodes

Orbisint CPS11D

- pH electrode for process technology
- Optional SIL version for connecting to SIL transmitter
- With dirt-repellent PTFE diaphragm
- Product Configurator on the product page: www.endress.com/cps11d

 Technical Information TI00028C

Memosens CPS31D

- pH electrode with gel-filled reference system with ceramic diaphragm
- Product Configurator on the product page: www.endress.com/cps31d

 Technical Information TI00030C

Ceraliquid CPS41D

- pH electrode with ceramic junction and KCl liquid electrolyte
- Product Configurator on the product page: www.endress.com/cps41d

 Technical Information TI00079C

Ceragel CPS71D

- pH electrode with reference system including ion trap
- Product Configurator on the product page: www.endress.com/cps71d

 Technical Information TI00245C

Memosens CPS171D

- pH electrode for bio-fermenters with digital Memosens technology
- Product Configurator on the product page: www.endress.com/cps171d

 Technical Information TI01254C

Orbipore CPS91D

- pH electrode with open aperture for media with high dirt load
- Product Configurator on the product page: www.endress.com/cps91d

 Technical Information TI00375C

Orbipac CPF81D

- Compact pH sensor for installation or immersion operation
- In industrial water and wastewater
- Product Configurator on the product page: www.endress.com/cpf81d

 Technical Information TI00191C

Enamel pH electrodes

Ceramax CPS341D

- pH electrode with pH-sensitive enamel
- Meets highest demands of measuring accuracy, pressure, temperature, sterility and durability
- Product Configurator on the product page: www.endress.com/cps341d

 Technical Information TI00468C

ORP sensors

Orbisint CPS12D

- ORP sensor for process technology
- Product Configurator on the product page: www.endress.com/cps12d

 Technical Information TI00367C

Ceraliquid CPS42D

- ORP electrode with ceramic junction and KCl liquid electrolyte
- Product Configurator on the product page: www.endress.com/cps42d

 Technical Information TI00373C

Ceragel CPS72D

- ORP electrode with reference system including ion trap
- Product Configurator on the product page: www.endress.com/cps72d

 Technical Information TI00374C

Orbipac CPF82D

- Compact ORP sensor for installation or immersion operation in process water and wastewater
- Product Configurator on the product page: www.endress.com/cpf82d

 Technical Information TI00191C

Orbipore CPS92D

- ORP electrode with open aperture for media with high dirt load
- Product Configurator on the product page: www.endress.com/cps92d

 Technical Information TI00435C

pH ISFET sensors

Tophit CPS441D

- Sterilizable ISFET sensor for low-conductivity media
- Liquid KCl electrolyte
- Product Configurator on the product page: www.endress.com/cps441d

 Technical Information TI00352C

Tophit CPS471D

- Sterilizable and autoclavable ISFET sensor for food and pharmaceuticals, process engineering
- Water treatment and biotechnology
- Product Configurator on the product page: www.endress.com/cps471d

 Technical Information TI00283C

Tophit CPS491D

- ISFET sensor with open aperture for media with high dirt load
- Product Configurator on the product page: www.endress.com/cps491d

 Technical Information TI00377C

pH and ORP combined sensors

Memosens CPS16D

- Combined pH/ORP sensor for process technology
- With dirt-repellent PTFE diaphragm
- With Memosens technology
- Product Configurator on the product page: www.endress.com/cps16D



Technical Information TI00503C

Memosens CPS76D

- Combined pH/ORP sensor for process technology
- Hygienic and sterile applications
- With Memosens technology
- Product Configurator on the product page: www.endress.com/cps76d



Technical Information TI00506C

Memosens CPS96D

- Combined pH/ORP sensor for chemical processes
- With poison-resistant reference with ion trap
- With Memosens technology
- Product Configurator on the product page: www.endress.com/cps96d



Technical Information TI00507C

Conductivity sensors with conductive measurement of conductivity

Condumax CLS15D

- Conductive conductivity sensor
- For pure water, ultrapure water and Ex applications
- Product Configurator on the product page: www.endress.com/CLS15d



Technical Information TI00109C

Condumax CLS16D

- Hygienic, conductive conductivity sensor
- For pure water, ultrapure water and Ex applications
- With EHEDG and 3A approval
- Product Configurator on the product page: www.endress.com/CLS16d



Technical Information TI00227C

Condumax CLS21D

- Two-electrode sensor in plug-in head version version
- Product Configurator on the product page: www.endress.com/CLS21d



Technical Information TI00085C

Memosens CLS82D

- Four-electrode sensor
- With Memosens technology
- Product Configurator on the product page: www.endress.com/cls82d



Technical Information TI01188C

Oxygen sensors

Oxymax COS22D

- Sterilizable sensor for dissolved oxygen
- With Memosens technology or as an analog sensor
- Product Configurator on the product page: www.endress.com/cos22d



Technical Information TI00446C

Oxymax COS51D

- Amperometric sensor for dissolved oxygen
- With Memosens technology
- Product Configurator on the product page: www.endress.com/cos51d



Technical Information TI00413C

Memosens COS81D

- Sterilizable, optical sensor for dissolved oxygen
- With Memosens technology
- Product Configurator on the product page: www.endress.com/cos81d



Technical Information TI01201C

Software

Memobase Plus CYZ71D

- PC software to support laboratory calibration
- Visualization and documentation of sensor management
- Sensor calibrations stored in database
- Product Configurator on the product page: www.endress.com/cyz71d



Technical Information TI00502C

Other accessories

Activation codes



You must quote the serial number of the device when ordering the activation code.

Activation code: Bluetooth

Order No. 71401176

Cable junction with Velcro strip

Cable junction with Velcro strip

- 4 pieces, for sensor cable
- Order No. 71092051

Communication-specific accessories

Commubox FXA195

Intrinsically safe HART communication with FieldCare via the USB port



Technical Information TI00404F

Wireless HART adapter SWA70

- Wireless device connection
- Easily integrated, offers data protection and transmission safety, can be operated in parallel with other wireless networks, minimum cabling complexity



Technical Information TI00061S

System components

RIA15

- Process display unit, Digital display unit for integration into 4-20 mA circuits
- Panel mounting
- With optional HART communication



Technical Information TI01043K

www.addresses.endress.com
