

Operating Instructions

Liquiline Compact CM82

Compact transmitter configurable for Memosens sensors from the Liquiline series





Table of contents







1	Document information	4	10	Operation	35
1.1	Warnings	4	10.1	Reading measured values	35
1.2	Symbols	4	10.2	Adapting the measuring device to the process conditions	36
1.3	Symbols at the device	4			
1.4	Documentation	5	11	Diagnostics and troubleshooting ...	38
2	Basic safety instructions	6	11.1	Diagnostic information via LED	38
2.1	Requirements for personnel	6	11.2	Adapting the diagnostic information	38
2.2	Designated use	6	11.3	Adapting sensor diagnostic information	39
2.3	Occupational safety	6	11.4	Simulation	47
2.4	Operational safety	6	11.5	Diagnostic list	48
3	Product description	8	11.6	Event logbook	62
3.1	Product design	8	11.7	Resetting the measuring device	62
4	Incoming acceptance and product identification	9	11.8	Device information	63
4.1	Incoming acceptance	9	11.9	Firmware history	63
4.2	Product identification	9	12	Maintenance	64
4.3	Scope of delivery	10	12.1	Maintenance tasks	64
4.4	Certificates and approvals	10	13	Repair	65
5	Installation	12	13.1	General notes	65
5.1	Dimensions	12	13.2	Return	65
6	Electrical connection	13	13.3	Disposal	65
6.1	Connection	13	14	Accessories	66
6.2	Post-connection check	14	14.1	Sensors	66
7	Operation options	15	14.2	Software	69
7.1	Overview of operating options	15	14.3	Other accessories	69
7.2	Access to operating menu via SmartBlue (app)	15	15	Technical data	71
7.3	Access to operating menu via RIA15	17	15.1	Input	71
8	System integration	18	15.2	Output	71
8.1	Integrating the measuring device into the system	18	15.3	Power supply	71
9	Commissioning	19	15.4	Performance characteristics	72
9.1	Preparatory steps	19	15.5	Environment	72
9.2	Function check	19	15.6	Mechanical construction	73
9.3	Establishing connection via SmartBlue (app) ..	20	Index	75	
9.4	Establishing a connection via RIA15	21			
9.5	Setting the operating language	27			
9.6	Date and time	27			
9.7	Configuring the measuring device	27			
9.8	Configuration management	34			
9.9	Unauthorized access	34			

1 Document information

1.1 Warnings

Structure of information	Meaning
 DANGER Causes (/consequences) If necessary, Consequences of non-compliance (if applicable) <ul style="list-style-type: none"> ▶ Corrective action 	This symbol alerts you to a dangerous situation. Failure to avoid the dangerous situation will result in a fatal or serious injury.
 WARNING Causes (/consequences) If necessary, Consequences of non-compliance (if applicable) <ul style="list-style-type: none"> ▶ Corrective action 	This symbol alerts you to a dangerous situation. Failure to avoid the dangerous situation can result in a fatal or serious injury.
 CAUTION Causes (/consequences) If necessary, Consequences of non-compliance (if applicable) <ul style="list-style-type: none"> ▶ Corrective action 	This symbol alerts you to a dangerous situation. Failure to avoid this situation can result in minor or more serious injuries.
NOTICE Cause/situation If necessary, Consequences of non-compliance (if applicable) <ul style="list-style-type: none"> ▶ Action/note 	This symbol alerts you to situations which may result in damage to property.

1.2 Symbols

Symbol	Meaning
	Additional information, tips
	Permitted or recommended
	Not permitted or not recommended
	Reference to device documentation
	Reference to page
	Reference to graphic
	Result of a step

1.3 Symbols at the device

Symbol	Meaning
	Reference to device documentation

1.4 Documentation

The following instructions complement these Operating Instructions and are available on the product pages on the Internet:

Operating Instructions Memosens, BA01245C

- Software description for Memosens inputs
- Calibration of Memosens sensors
- Sensor-specific diagnostics and troubleshooting

2 Basic safety instructions

2.1 Requirements for personnel

- Installation, commissioning, operation and maintenance of the measuring system may be carried out only by specially trained technical personnel.
- The technical personnel must be authorized by the plant operator to carry out the specified activities.
- The electrical connection may be performed only by an electrical technician.
- The technical personnel must have read and understood these Operating Instructions and must follow the instructions contained therein.
- Faults at the measuring point may only be rectified by authorized and specially trained personnel.

 Repairs not described in the Operating Instructions provided must be carried out only directly at the manufacturer's site or by the service organization.

2.2 Designated use

The Liquiline CM72 Liquiline CM82 is a transmitter for connecting digital sensors with Memosens technology, configurable, with 4..20 mA/HART communication and optional operation via smartphone or other mobile devices via Bluetooth.

The device is designed for use in the following industries:

- Life science
- Chemical industry
- Water and wastewater
- Food and beverages
- Power stations
- Other industrial applications

2.3 Occupational safety

As the user, you are responsible for complying with the following safety conditions:

- Installation guidelines
- Local standards and regulations
- Regulations for explosion protection

Electromagnetic compatibility

- The product has been tested for electromagnetic compatibility in accordance with the applicable European standards for industrial applications.
- The electromagnetic compatibility indicated applies only to a product that has been connected in accordance with these Operating Instructions.

2.4 Operational safety

Before commissioning the entire measuring point:

1. Verify that all connections are correct.
2. Ensure that electrical cables and hose connections are undamaged.
3. Do not operate damaged products, and protect them against unintentional operation.
4. Label damaged products as defective.

During operation:

- ▶ If faults cannot be rectified:
products must be taken out of service and protected against unintentional operation.

⚠ CAUTION**Cleaning not switched off during calibration or maintenance activities**

Risk of injury due to medium or cleaning agent!

- ▶ If a cleaning system is connected, switch it off before removing a sensor from the medium.
- ▶ If you wish to check the cleaning function and have therefore not switched off the cleaning system, wear protective clothing, goggles and gloves or take other appropriate measures.

3 Product description

3.1 Product design

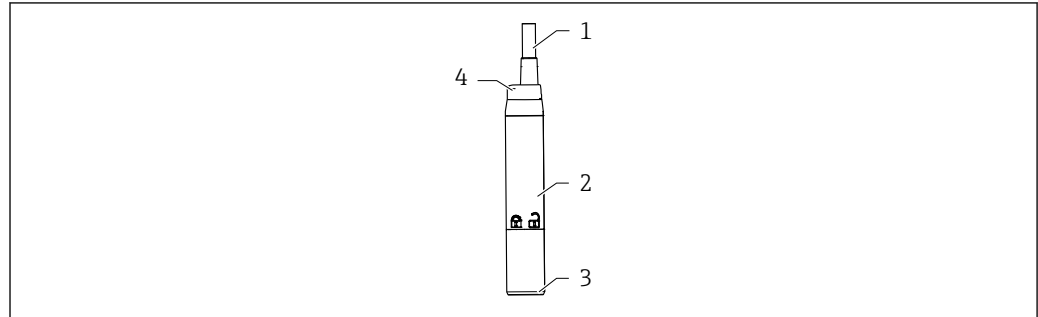

A0036216

1 Transmitter design

- 1 Cable
- 2 Housing
- 3 Memosens connection
- 4 LED, for optical signaling of operating statuses of measuring point

3.1.1 Measuring parameters

The transmitter is designed for digital Memosens sensors with inductive plug-in head:

- pH, ORP. pH/ORP combined sensors
- Conductive Conductivity
- Dissolved oxygen

4 Incoming acceptance and product identification

4.1 Incoming acceptance

1. Verify that the packaging is undamaged.
 - ↳ Notify the supplier of any damage to the packaging.
Keep the damaged packaging until the issue has been resolved.
2. Verify that the contents are undamaged.
 - ↳ Notify the supplier of any damage to the delivery contents.
Keep the damaged goods until the issue has been resolved.
3. Check that the delivery is complete and nothing is missing.
 - ↳ Compare the shipping documents with your order.
4. Pack the product for storage and transportation in such a way that it is protected against impact and moisture.
 - ↳ The original packaging offers the best protection.
Make sure to comply with the permitted ambient conditions.

If you have any questions, please contact your supplier or your local Sales Center.

4.2 Product identification

4.2.1 Nameplate

The nameplate provides you with the following information on your device:

- Manufacturer identification
 - Order code
 - Extended order code
 - Serial number
 - Firmware version
 - Ambient and process conditions
 - Input and output values
 - Safety information and warnings
 - Approvals as per version ordered
- ▶ Compare the data on the nameplate with your order.

4.2.2 Product identification

Product page

www.endress.com/CM82

Interpreting the order code

The order code and serial number of your product can be found in the following locations:

- On the nameplate
- In the delivery papers

Obtaining information on the product

1. Open the product website.
2. In the page header, select: **Product tools**.
 - ↳ **Online Tools**: An additional area opens up.

3. Select: **Access device specific information.**
 - ↳ An additional window opens.
4. Enter the order code from the nameplate into the search field. Then select: **Show details.**
 - ↳ Details of each feature (selected option) of the order code are displayed.

4.3 Scope of delivery

The scope of delivery includes:

- CM82
- Brief Operating Instructions
- ▶ If you have any queries:
Please contact your supplier or local sales center.

4.4 Certificates and approvals

4.4.1 C€ mark

Endress+Hauser Conducta GmbH+CO. KG hereby declares that the radio system type CM82 complies with directives 2014/53/EU and 2011/65/EU.

The complete text of the EU declaration of conformity can be found at the following web address: "<http://www.endress.com/CM82>"

Frequency band: 2400-2483.5 MHz, power output: < 10dBm EIRP

4.4.2 FCC/IC

Radio approval for USA/Canada

This device complies with Part 15 of the FCC Rules [and with Industry Canada license-exempt RSS standard(s)]. Operation is subject to the following two conditions: (1) this device may not cause harmful interference, and (2) this device must accept any interference received, including interference that may cause undesired operation.

Any changes or modifications made to this equipment not expressly approved by Endress+Hauser may void the FCC authorization to operate this equipment. This device complies with Part 15 of the FCC Rules and with Industry Canada license-exempt RSS standard(s).

Operation is subject to the following two conditions:

- this device may not cause harmful interference, and
- this device must accept any interference received, including interference that may cause undesired operation.

Le présent appareil est conforme aux CNR d'Industrie Canada applicables aux appareils radio exempts de licence. L'exploitation est autorisée aux deux conditions suivantes:

- l'appareil ne doit pas produire de brouillage, et
- l'utilisateur de l'appareil doit accepter tout brouillage radioélectrique subi, même si le brouillage est susceptible d'en compromettre le fonctionnement.

Note: This equipment has been tested and found to comply with the limits for a Class B digital device, pursuant to part 15 of the FCC Rules. These limits are designed to provide reasonable protection against harmful interference in a residential installation. This equipment generates, uses and can radiate radio frequency energy and, if not installed and used in accordance with the instructions, may cause harmful interference to radio communications. However, there is no guarantee that interference will not occur in a particular installation. If this equipment does cause harmful interference to radio or television reception, which can be determined by turning the equipment off and on, the

user is encouraged to try to correct the interference by one or more of the following measures:

- Increase the separation between the equipment and receiver.
- Consult the dealer or an experienced radio technician for help.

Radio approval for Japan

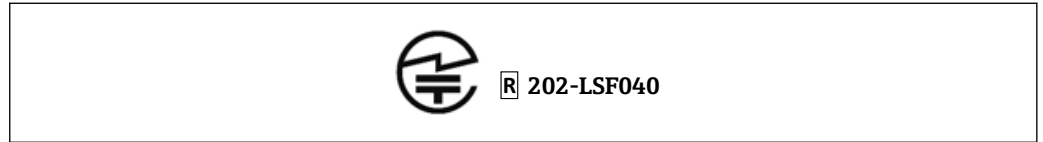

Japanese Radio Law and Japanese Telecommunications Business Law Compliance. This device is granted pursuant to the Japanese Radio Law (電波法). This device should not be modified (otherwise the granted designation number will become invalid).

Radio approval for China

Certification number: **CMIT ID: 2017DJ6495**

Radio approval for South Korea

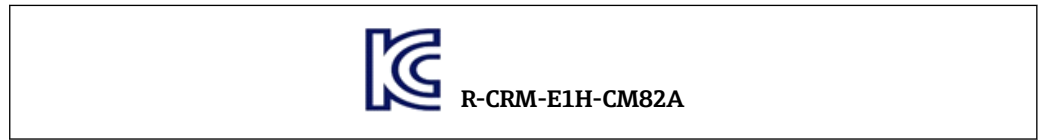

5 Installation

5.1 Dimensions

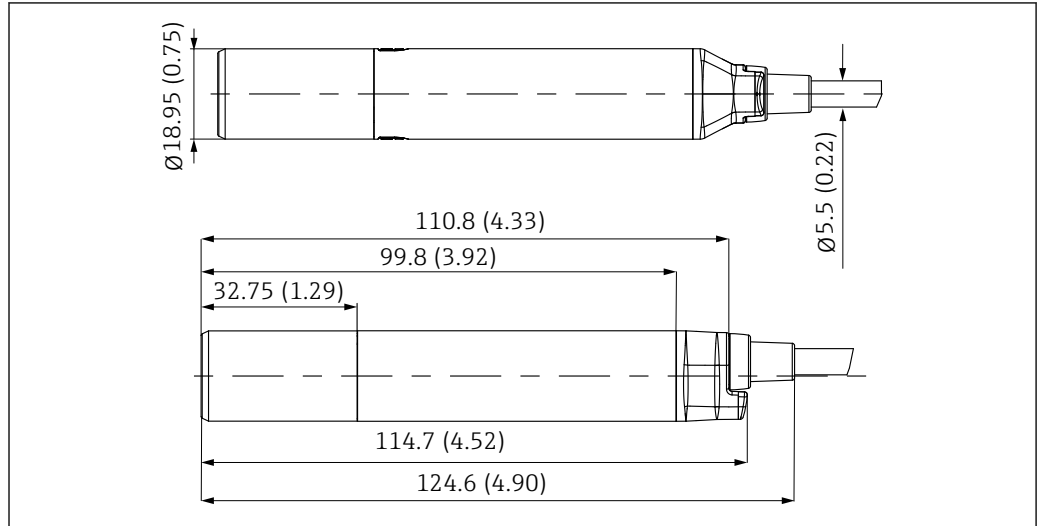

2 Dimensions in mm (inch)

6 Electrical connection

⚠ WARNING

Device is live!

Incorrect connection may result in injury or death!

- ▶ The electrical connection may be performed only by an electrical technician.
- ▶ The electrical technician must have read and understood these Operating Instructions and must follow the instructions contained therein.
- ▶ **Prior** to commencing connection work, ensure that no voltage is present on any cable.

6.1 Connection

Supply voltage:	12,6 to 30 VDC (In the case of a residual current > 20 mA) 14 to 30 VDC (When the failure current is set to 3.6 mA.)
Cable length:	3 m (10 ft) 7 m (23 ft) 15 m (46 ft)
Signal output:	4 to 20 mA
Signal on alarm:	3.6 to 23 mA

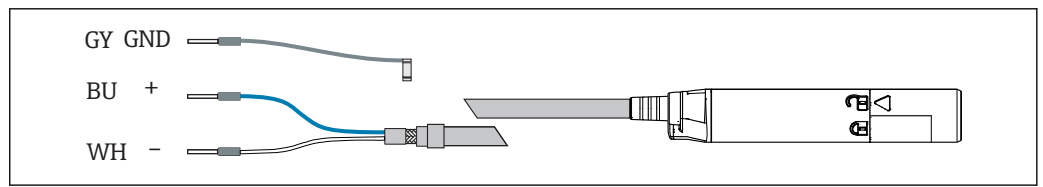

3 Electrical connection

- ▶ Connect ferrules as specified in the table:

Cable	Function
Gray (GY)	Grounding, GND
BU (blue)	4 to 20 mA +
White (WH)	4 to 20 mA -

The grounding cable must be provided by the customer.

6.1.1 With RIA15

i The RIA15 process display unit is loop-powered and does not require any external power supply.

📖 Further information is available in the RIA15 Operating Instructions BA01170K.

6.1.2 With junction box

Max. operating voltage:	30 V
Max. operating current	30 mA

Wiring

1. Unscrew cover and remove.
 - ↳ The terminal assignment is indicated in the box.

2. Guide the cable cores through the M16 cable gland.
3. Connect cores in accordance with the assignment provided.

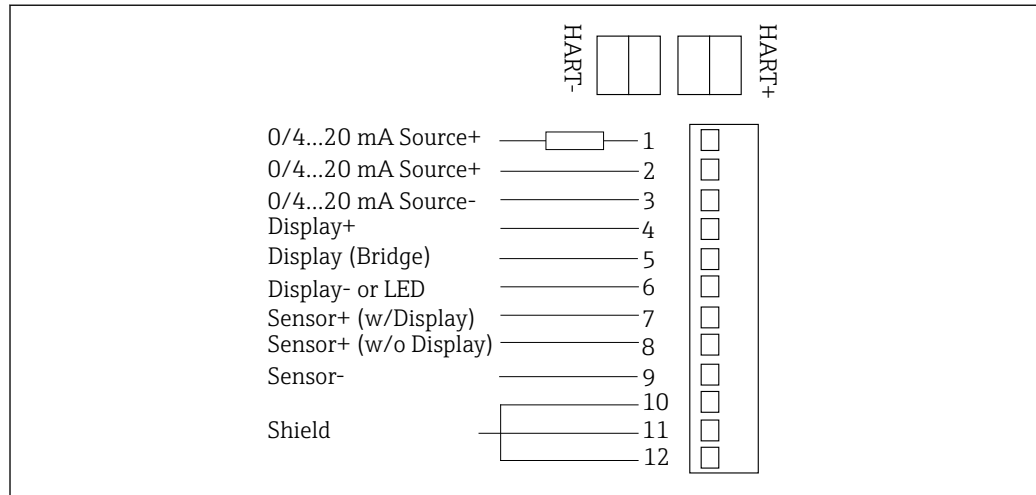

A0034718

4 Terminal diagram

Further information is available in the Operating Instructions BA01802C.

6.2 Post-connection check

WARNING

Connection errors

The safety of people and of the measuring point is under threat. The manufacturer does not accept any responsibility for errors that result from failure to comply with the instructions in this manual.

- ▶ Put the device into operation only if you can answer **yes** to **all** the following questions.

Electrical connection

- ▶ Is the device or cable undamaged (visual inspection)?
- ▶ Do the mounted cables have adequate strain relief?
- ▶ Are the cables routed without loops and cross-overs?
- ▶ Does the supply voltage match the specifications on the nameplate?
- ▶ No reverse polarity, is terminal assignment correct?

7 Operation options

7.1 Overview of operating options

Operation and settings via:

- SmartBlue (app)
- RIA15 (with reduced operating function compared to app and HART)
- PLC control station (via HART)

7.2 Access to operating menu via SmartBlue (app)

SmartBlue is available as a download for Android terminals from the Google Playstore and for iOS devices from the Apple iTunes Store.

If you scan the QR code, you will be brought directly to the app:



A0031189-EN

5 Download links

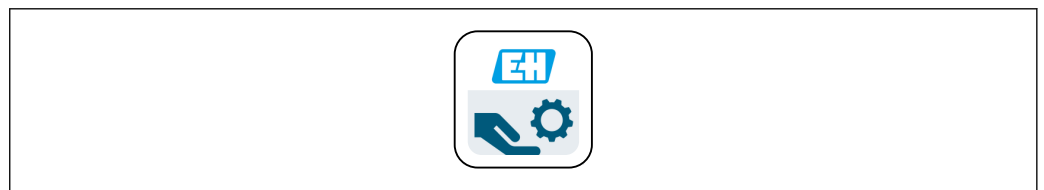

A0029747

6 SmartBlue App

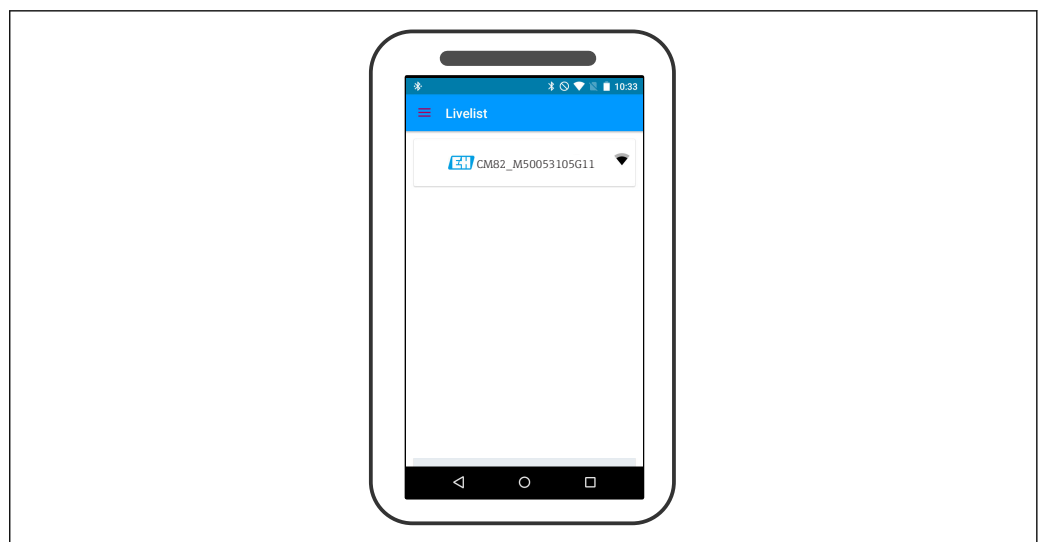

A0035117

7 Livelist

The Livelist displays all of the devices that are within range.

System requirements

- iOS devices: iPhone 4S or higher from iOS9.0; iPad2 or higher from iOS9.0; iPod Touch 5. Generation or higher from iOS9.0
- Devices with Android: from Android 4.4 KitKat and Bluetooth® 4.0

7.2.1 Structure and function of the operating menu

In the Home view, the current measured values are displayed along with the device information (tag, serial number, firmware version, order code).

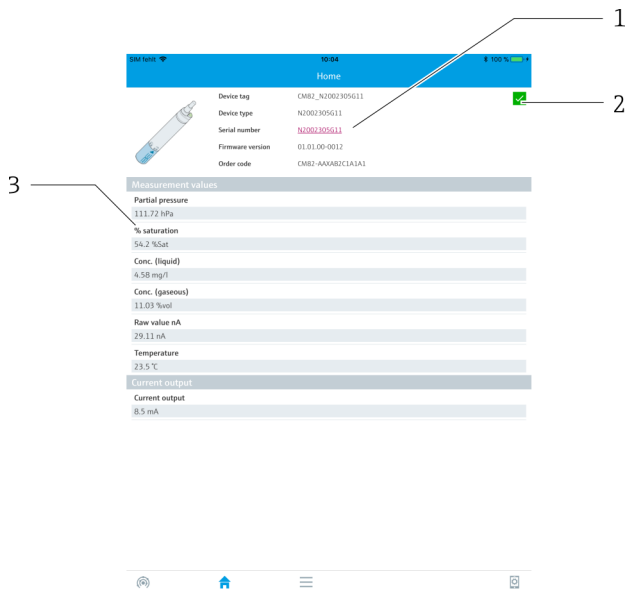

8 Overview of current measured values

- 1 System and device information CM82
- 2 Shortcut to diagnostic list
- 3 Overview of measured values of connected sensor

The device is operated via four main menus:

- Guidance
- Diagnostics
- Application
- System

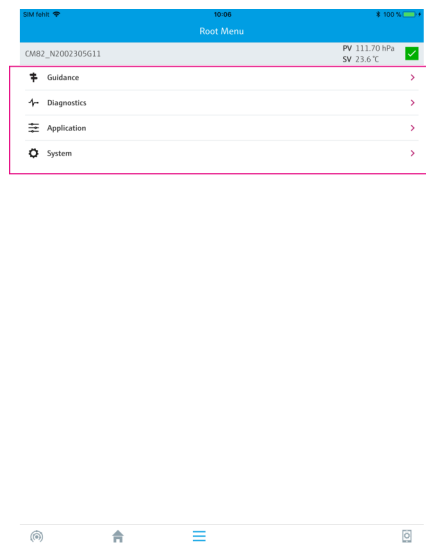

9 Main menu

Menu	Function
Guidance	Contains functions involving a self-contained sequence of activities, e.g. for calibration (=“Wizard”, guided operation).
Diagnostics	Contains information regarding operation, diagnostics and troubleshooting, as well as configuration of the diagnostic behavior.
Application	Sensor data for specific optimization and for detailed process adjustment. Adjustment of measuring point to the application.
System	These menus contain parameters for configuring the overall system.

7.3 Access to operating menu via RIA15

The RIA15 process indicator is incorporated into the 4 to 20 mA/HART® loop and displays the measuring signal in digital form. The process indicator does not require an external power supply. It is powered directly from the current loop.

By means of HART® communication, the RIA15 enables configuration and commissioning of selected field devices and readouts of device/sensor status messages.

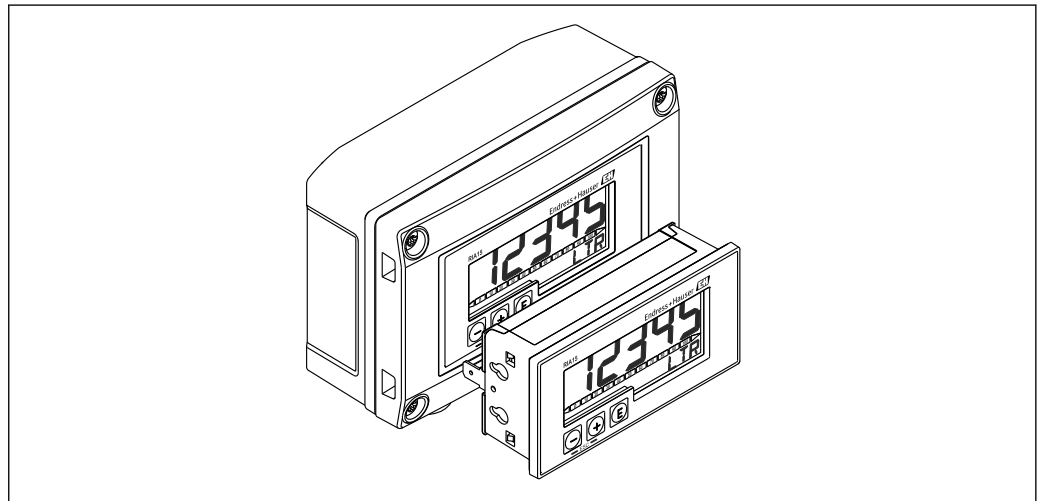

10 Process display unit RIA15

A0017816

8 System integration

8.1 Integrating the measuring device into the system

Interfaces for measured value transmission:

- 4 to 20 mA
- Bluetooth® LE wireless technology
- HART

8.1.1 Bluetooth® wireless technology

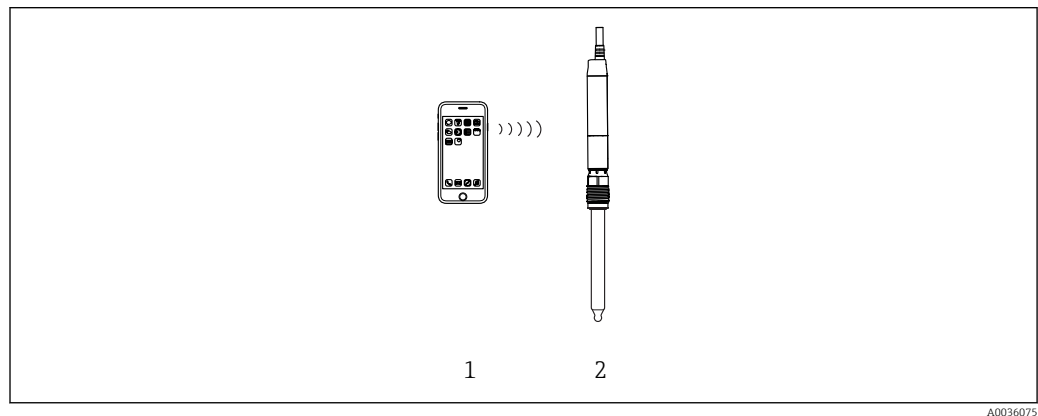

11 Options for remote operation via Bluetooth® LE wireless technology

- 1 Smartphone / tablet with SmartBlue (app)
 3 Transmitter with Bluetooth® wireless technology

8.1.2 HART

In addition to the analog 4 ... 20 mA signal, as well as the status of the device can be transmitted digitally.

Parameterisation is also possible using an additional control unit and a suitable driver.

HART operation is possible via the following hosts (at least):

- Fieldcare und kompatible DTM-Hosts
- SFX350 Handheld
- Emerson 475 Handheld
- Emerson AMS
- Siemens PDM

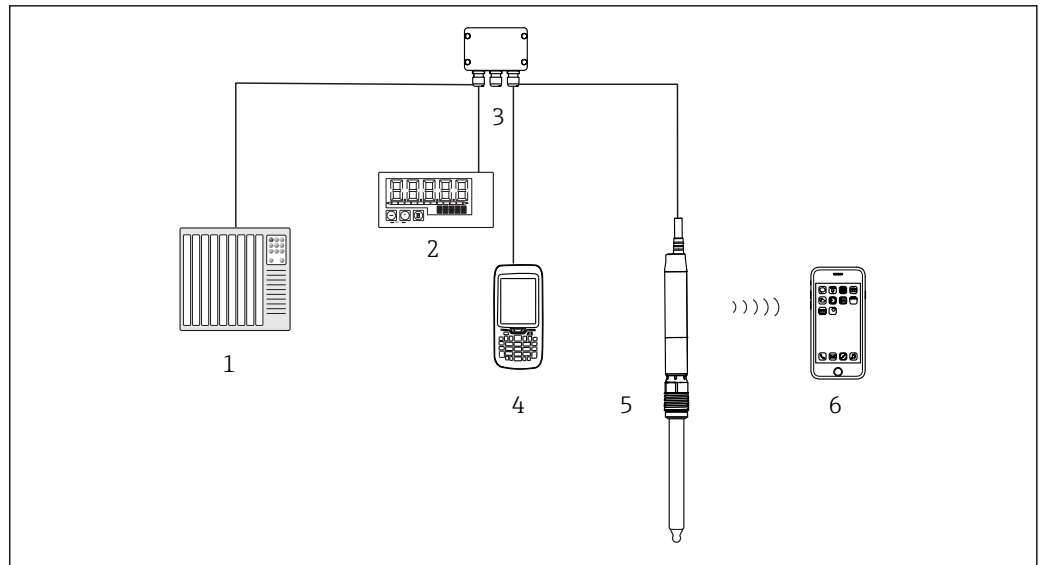

A0036740

12 Wiring options for remote operation via HART protocol

- 1 PLC (programmable logic controller)
- 2 Loop-powered process display unit RIA15, optional
- 3 HART control unit (e.g. SFX350)
- 4 Junction box
- 5 Transmitter with Bluetooth® LE wireless technology
- 6 Optional: Smartphone / tablet with SmartBlue (app)

9 Commissioning

9.1 Preparatory steps

- ▶ Connect the device.
 - ↳ The device starts up and transmits the measured value as a current value.

To operate via the SmartBlue, the Bluetooth® LE signal on the smartphone or tablet must be switched on.

9.2 Function check

⚠ WARNING

Incorrect connection, incorrect supply voltage

Safety risks for staff and device malfunctions!

- ▶ Check that all connections have been established correctly in accordance with the wiring diagram.
- ▶ Ensure that the supply voltage matches the voltage indicated on the nameplate.

Familiarize yourself with the operation of the device before it is first switched on. In particular please read the "Basic safety instructions" sections. After power-up, the device performs a self-test and then goes to the measuring mode.

9.2.1 LED display

LED messages signal the status of the device and sensor.

LED behavior	Status
Green Flashes quickly	Everything OK Device starting up
Green Flashes twice	Everything OK Read out Memosens sensor information from sensor to transmitter (sensor type, calibration data, etc.)
Green Flashes slowly	Everything OK Sensor and device OK and functioning correctly.
Green Flashes quickly three times	Everything OK Measured value at PLC in automatic HOLD. If the "Sensor replacement alarm delay" is exceeded, the device transmits a signal on alarm. The automatic hold is set to 30 seconds but can be configured to suit the customer's needs.
Red Flashes quickly	Failure of device or sensor Fault state as per NAMUR NE107
Red, green Three red flashes alternating with three green flashes	Squawk Squawk is signaled briefly while the connection is established. Squawk can also be activated via the app. This makes it possible to locate the device more quickly, e. g. when several devices are installed, you can see which one the connection is established with.

9.3 Establishing connection via SmartBlue (app)

1. Download and install the SmartBlue.
2. Start the SmartBlue.
3. Select device from livelist displayed. All available devices are displayed.
4. Perform login
5. Enter user name -> admin
6. Enter initial password -> device serial number
7. It is advisable to change the user name and password after logging in for the first time.

 You can drag additional information (e.g. main menu) onto the screen by swiping across the screen

9.3.1 System settings

Path: Settings		
Function	Options	Info
Information		
Version		Displays the app version
About Endress+Hauser		Manufacturer's information
User interface		
Language	Picklist of different languages	Change language

Path: Settings		
Function	Options	Info
Save device login passwords	Selection <ul style="list-style-type: none"> ▪ Off ▪ 5 minutes ▪ 15 minutes ▪ 60 minutes 	Options for saving password The password is stored temporarily for the selected time period. It does not need to be entered when re-establishing a connection, e.g. to replace a sensor.
Device List		
Sorting	Selection <ul style="list-style-type: none"> ▪ Signal strength ▪ Name 	Sorting options
Show demo devices	Selection <ul style="list-style-type: none"> ▪ ▪ 	Which devices are displayed in the list

9.4 Establishing a connection via RIA15

The RIA15 can be used as a local indicator of the measured values as well as for basic configuration of the Liquiline CM82 via HART®.

Here, the RIA15 communicates with the CM82 via HART as a secondary master in addition to the PLC or process control system. The RIA15 is not invisible to the PLC in this case. The RIA15 does not alter the current value of the current output of the CM82.

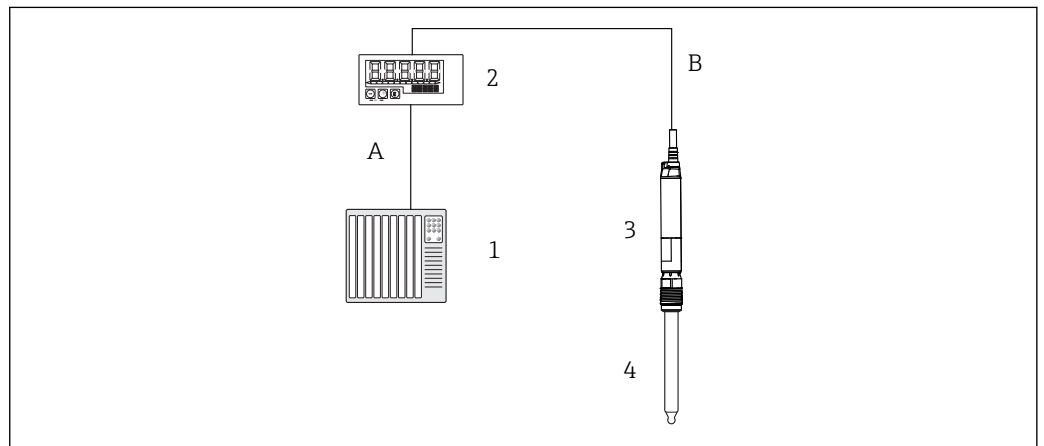

A0036208

13 Remote operation of CM82 via RIA15

- 1 PLC
- 2 RIA15 loop-powered process display unit
- 3 CM82 transmitter
- 4 Memosens sensor (e.g. pH sensor)
- A 4 to 20mA (HART optional)
- B 4 to 20mA with HART

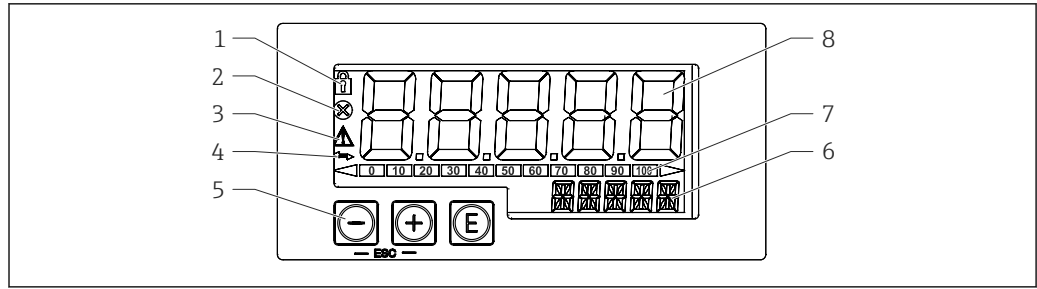

A0017719

14 Display and operating elements of the process display unit

- 1 Operating menu locked
- 2 Error
- 3 Warning
- 4 HART communication enabled
- 5 Operating keys "-", "+", "E"
- 6 14-segment display for unit/TAG
- 7 Bar graph with indicators for under range and over range
- 8 5-digit 7-segment display for measured value, digit height 17 mm (0.67 in)

The device is operated using three operating keys on the front of the housing.

The device setup can be disabled with a 4-digit user code. If the setup is disabled, a padlock symbol appears on the display when an operating parameter is selected.

 <small>A0017716</small>	Enter key; calling up the operating menu, confirming the option/setting parameters in the operating menu
 <small>A0017715</small>	Selecting and setting/changing values in the operating menu; pressing the '-' and '+' keys simultaneously takes the user back up a menu level. The configured value is not saved.
 <small>A0017714</small>	

9.4.1 RIA15 operating matrix

In HART mode, the RIA15 with "Analysis" option can be used for basic configuration of the Liquiline CM82.

The measuring ranges are dependent on the connected sensor and can be found in the relevant sensor documentation.

Local measured value display and basic configuration of the CM82

The RIA15 can be used as a local indicator of the measured values as well as for basic configuration of the Liquiline CM82 via HART®.

The following values are output here: Digital output (HART®): Measured value and unit depending on the connected sensor

PV: Configured primary value (CMAIN operating parameter)

SV: Temperature (sensor)

TV: Dependent on the connected transmitter parameter + sensor type

QV: Dependent on the connected transmitter parameter + sensor type

Transmitter parameter	Sensor type	"TV" value	"QV" value
pH	Glass	Raw value in mV	Glass impedance in MOhm
pH	ISFET	Raw value in mV	Leak current in nA
pH	ORP	Relative ORP value as %	Raw value in mV

Transmitter parameter	Sensor type	"TV" value	"QV" value
pH	pH/ORP combined sensor	pH	ORP in mV
Conductivity		Resistance	Conductivity, raw value
Dissolved oxygen		Liquid concentration	Saturation as %



 If "UC170" is displayed instead of the unit, see footnote in table.

The following settings for the CM82 can be made using the three operating keys on the front of the RIA15:

- Units of connected sensor
- Current output range
- Retrieval of diagnostic information

Basic configuration of the CM82

The RIA15 must be in the HART mode (MODE = HART) to make the basic settings. The ANALYSIS menu is not visible in analog mode (MODE = 4-20).

1. Press the  key.
↳ The **Setup** menu opens.
2. Press the  key.
↳ The **CT** submenu opens.
3. Set the desired parameters. For parameter descriptions, see the following table.

Setup -> ANALYSIS menu		
The CT menu and all of the associated submenus are visible only if the RIA15 was ordered with the "Analysis" option, the HART option has been configured and a CM82 has been detected by the RIA15. Using this menu, the basic settings for the CM82 can be made via the RIA15.		
Parameter	Values	Description
CT		This menu contains the parameters for configuring the CM82 compact transmitter.
CSET		Access the "CM82 setup" submenu
TUNIT	°C °F °K	Select the unit for temperature on the CM82.
OUTS		Access the "CM82 - Output Setting" submenu to change the setting on the CM82. The primary value (CMAIN) of the CM82 is assigned here and the measuring range (4-20mA) configured.  Depending on the sensor type connected, only certain measured values can be configured/displayed.
pH glass sensors		
CMAIN	pH mV_PH IMPGL TEMP	PH: pH measured value in pH mV_PH: pH raw value in mV IMPGL: Glass impedance in MOhm ¹⁾ TEMP: Temperature in °C/°F/°K (unit as per setting in TUNIT)
pH/ISFET sensors		
CMAIN	pH mV_PH LEAKC TEMP	PH: pH measured value in pH mV_PH: pH raw value in mV LEAKC: ISFET leak current in "nA" ¹⁾ TEMP: Temperature in °C/°F/°K (unit as per setting in TUNIT)
pH/ORP sensors		

Setup -> ANALYSIS menu		
The CT menu and all of the associated submenus are visible only if the RIA15 was ordered with the "Analysis" option, the HART option has been configured and a CM82 has been detected by the RIA15. Using this menu, the basic settings for the CM82 can be made via the RIA15.		
Parameter	Values	Description
CMAIN	mVORP %_ORP TEMP	mVORP: ORP measured value in mV %_ORP: Percentage ORP value as % TEMP: Temperature in °C/°F/K (unit as per setting in TUNIT)
pH/ORP combined sensors		
CMAIN	pH mV_PH IMPGL IMPRES mVORP %_ORP RH TEMP	PH: pH measured value in pH mV_PH: pH raw value in mV IMPGL: Glass impedance in MOhm ¹⁾ IMPRES: Reference impedance in Ohm mVORP: ORP measured value in mV %_ORP: Percentage ORP value as % RH: rH value in rH TEMP: Temperature in °C/°F/K (unit as per setting in TUNIT)
Oxygen sensors		
CMAIN	PAR_P %SAT C_LIQ C_GAS CURR RTIME TEMP	PAR_P: Partial pressure of oxygen in hPa %SAT: Percentage saturation as % C_LIQ: Liquid concentration (unit as per setting in UCLIQ) C_GAS: Gas concentration (unit as per setting in UCGAS) CURR: Raw value, measuring current of sensor in nA ¹⁾ (visible only in the case of amperometric oxygen sensors) RTIME: Decay time, raw value in µs (visible only in the case of optical oxygen sensors) TEMP: Temperature in °C/°F/K (unit as per setting in TUNIT)
UCLIQ	mG_L uG_L PPM PPB	Unit of upper and lower turndown setting if the primary value (CMAIN) is set to C_LIQ mG_L: milligram/liter ¹⁾ uG_L: microgram/liter PPM: parts per million PPB: parts per billion
UCGAS	%_VOL PPM_V	Unit of upper and lower turndown setting if the primary value (CMAIN) is set to C_GAS %_VOL: percent by volume PPM_V: parts per million
Conductivity sensors		
CMAIN	COND RESIS RAWC TEMP	COND: specific conductivity (unit as per setting in UCOND) RESIS: specific resistance (unit as per setting in URES) RAWC: uncompensated conductivity (unit as per setting in UCOND) TEMP: temperature (unit as per setting in TUNIT)
URES	KO*CM MO*CM KO*M	Unit of upper and lower turndown setting if the primary value (CMAIN) is set to RESIS KO*CM: kOhm*cm MO*CM: MOhm*cm KO*M: kOhm*m
UCOND	uS/cm mS/cm S/cm uS/m mS/m S/m	Unit of upper and lower turndown setting if the primary value (CMAIN) is set to COND or RESIS uS/cm: microsiemens/cm mS/cm: millisiemens/cm S/cm: siemens/cm uS/m: microsiemens/m mS/m: millisiemens/m S/m: siemens/m
for all sensors		

Setup -> ANALYSIS menu			
The CT menu and all of the associated submenus are visible only if the RIA15 was ordered with the "Analysis" option, the HART option has been configured and a CM82 has been detected by the RIA15. Using this menu, the basic settings for the CM82 can be made via the RIA15.			
Parameter		Values	Description
	LOW	-19,999 to 99,999	<p>Configure turndown of current output. The measured value that corresponds to 4 mA is set here. The limits of adjustment vary depending on the sensor type and measured value. The position of the decimal point is permanently preset depending on the primary value (CMAIN) configured.</p> <p>Valid ranges of adjustment: pH sensor: PH: -2.00 to 16.00 pH mV_PH: -2000 to 2000 mV LEAKC: -4000.0 to 4000.0 nA IMPGL: 0 to 99999 MOhm IMPRE: 0 to 99999 Ohm mVORP: -2000 to 2000 mV %_ORP: -3000.0 to 3000.0 % RH: 0.0 to 70.0 rH TEMP: -50.0 to 150.0 °C (depending on the unit configured under TEMP) -58.0 to 302.0°F 223.1 to 423.1 K</p> <p>dissolved oxygen sensor: PAR_P: 0.0 to 2500.0 hPa %SAT: 0.02 to 200.00 % saturation C_LIQ: -0.02 to 120.00 mg/l -20.00 to 999.99 ug/l -0.02 to 120.00 ppm -20.00 to 999.99 ppb (depending on the unit configured in UCLIQ) C_GAS: -0.02 to 200.00 % Vol -0.02 to 200.00 % Vol -200.00 to 999.99 ppm Vol (depending on the unit configured under UCGAS) CURR: 0.0 to 9999.9 nA RTIME: 0.0 to 100.0 µs TEMP: -10.0 to 140.0 °C 14.0 to 284 °F 263.1 to 413.1 K (depending on the unit configured under TEMP)</p> <p>Conductivity sensor: COND: 0.000 to 99.999 uS/cm 0.000 to 99.999 mS/cm 0.000 to 2.000 S/cm 0.000 to 99.999 uS/m 0.000 to 99.999 mS/m 0.000 to 99.999 S/m (depending on the unit configured in UCOND) RESIS: 0.00 to 999.99 kOhm*cm 0.00 to 200.00 MOhm*cm 0.00 to 999.99 kOhm*m (depending on the unit configured in URES) RAWC: 0.000 to 99.999 uS/cm 0.000 to 99.999 mS/cm 0.000 to 2.000 S/cm 0.000 to 99.999 uS/m 0.000 to 99.999 mS/m 0.000 to 99.999 S/m (depending on the unit configured in UCOND)</p>

Setup -> ANALYSIS menu			
The CT menu and all of the associated submenus are visible only if the RIA15 was ordered with the "Analysis" option, the HART option has been configured and a CM82 has been detected by the RIA15. Using this menu, the basic settings for the CM82 can be made via the RIA15.			
Parameter		Values	Description
			TEMP: -50.0 to 250.0 °C -58.0 to 482.0 °F 223.1 to 523.1 K (depending on the unit configured under TEMP)
		HIGH	-19,999 to 99,999 Configure turndown of current output. The measured value that corresponds to 20 mA is set here. The limits of adjustment vary depending on the sensor type and measured value. The position of the decimal point is permanently preset depending on the primary value (CMAIN) and units (UCLIQ, UCGAS, URES, UCOND) configured. For valid ranges of adjustment, see LOW (setting for 4 mA)
		ERRC	3.6 to 23.0 Configure the error current on the CM82 in mA
CDIAC			Access the "CM82 - Device diagnostics" submenu
		FCSM	Error category as per NAMUR and error number Display the error message with the highest priority on the CM82
		DTAG	Device tag Display the device tag of the CM82 (use +/- keys to scroll through text)
		DSER	Device serial number Display the serial number of the CM82 (use +/- keys to scroll through text)
		SENOC	Sensor order code Display the order code of the sensor (use +/- keys to scroll through text)
		SENSN	Sensor serial number Display the serial number of the sensor (use +/- keys to scroll through text)
CTRES			Access the "CM82 -Reset" submenu
		RBOOT	No YES Trigger a restart of the CM82
		FDEF	No YES Reset the CM82 to factory settings
CTSIM			Access the "CM82 -Simulation" submenu
		SIMUL	OFF ON Switch on simulation for current output value on CM82
		VALUE	3.6 to 23.0 Configure current output value on CM82 for simulation in mA

- 1) If "UC170" is displayed instead of unit. To remedy this, the unit must be set individually and manually in the "TEXT1" menu item. (SETUP => HART => HART1-4 => UNIT1-4 => TEXT1-4) → 26

 Further information is available in the RIA15 Operating Instructions BA01170K.

"UC170" displayed instead of HART® unit

By default, the unit of the transmitted measured value is automatically read out and displayed using a HART® command. If the transmitted "unit code" cannot be uniquely assigned by the RIA15, the unit code (UC170) is displayed instead of the unit. To remedy this, the unit must be set manually. (SETUP => HART => HART1-4 => UNIT1-4 => TEXT1-4).

The unit codes 170 to 219 are assigned multiple times as per the HART® specification. As the UC170 is also used with the CM82, the unit must be assigned manually. This applies to the following measured values/units:

PV (TEXT1):

Transmitter parameter	Primary value (CMAIN)	Unit
pH	Leak current (LEAKC)	nA
pH	Glass impedance (IMPGL)	MOhm
Dissolved oxygen	Liquid concentration (C_LIQ)	mg/l
Dissolved oxygen	Raw value of sensor (CURR)	nA

QV (TEXT4):

Transmitter parameter	Sensor type	Unit
pH	Glass	MOhm
pH	ISFET	nA

9.5 Setting the operating language

You can change the operating language in the app settings:

Settings/User interface/Language

9.6 Date and time

Configure the date and time under **System/Date/Time**.

 The date and time function runs only while the device is supplied with power. They must be reset if the power supply is interrupted.

(Start time: 01.01.1970 0:00 hours...)

9.7 Configuring the measuring device

Path: Application		
Function	Options	Info
Units		
Temperature unit	Selection <ul style="list-style-type: none"> ▪ °C ▪ °F ▪ K Factory setting °C	
Cond. unit	Selection <ul style="list-style-type: none"> ▪ Automatic ▪ µS/cm ▪ mS/cm ▪ S/cm ▪ µS/m ▪ mS/m ▪ S/m Factory setting mS/cm	To be selected for conductivity

Path: Application		
Function	Options	Info
Conc. (liquid) unit	Selection <ul style="list-style-type: none"> ▪ mg/l ▪ µg/l ▪ ppm ▪ ppb 	To be selected for oxygen.
Conc. (gaseous) unit	Selection <ul style="list-style-type: none"> ▪ %vol ▪ ppm 	

9.7.1 Changing the device tag

You can change the device tag here:

System/Device management/TAG

9.7.2 Configuring the sensor

Path: Application		
Function	Options	Info
Sensor		Sensor-dependent settings
Sensor type		Display the sensor type
Order code		Order code of sensor
Damping		The damping causes a floating average curve of the measured values over the time specified.
Damping ORP, Damping pH, Damping DO, Damping conductivity	0 ... 60 s Factory setting 0 s	These functions determine the damping of the primary value of the connected sensor.
Damping temperature	0 to 60 s Factory setting 0 s	These functions determine the damping of the integrated temperature sensor.
Tag control		
Sensor check	Selection <ul style="list-style-type: none"> ▪ Off ▪ Tag ▪ Group Factory setting Off	
Group	Range: 0 to 65535	
Extended setup		
Conductivity:		
Current cell constant	Read only	Value currently saved in the sensor
Compensation	Selection <ul style="list-style-type: none"> ▪ None ▪ Linear ▪ NaCl (IEC 746-3) ▪ Water ISO7888 (20 °C) ▪ Water ISO7888 (25 °C) Factory setting Linear	Various methods are available to compensate for the temperature dependency. Depending on your process, decide which type of compensation you want to use. Alternatively, you can also select None and thus measure uncompensated conductivity.

Path: Application		
Function	Options	Info
Meas. ref. temp.	-5.0 to 100.0 °C (23.0 to 212.0 °F) Factory setting 25.0 °C (77.0 °F)	Reference temperature for calculating the temperature-compensated conductivity
Factor alpha	0.000 to 20.000 %/K Factory setting 2.100 %/K	Enter the conductivity coefficient of your process medium
pH:		
Temp. compensation	Selection <ul style="list-style-type: none"> ▪ Off ▪ Automatic ▪ Manual Factory setting Automatic	Decide how you want to compensate the medium temperature: <ul style="list-style-type: none"> ▪ Automatically using the temperature sensor of your sensor (ATC) ▪ Manually by entering the medium temperature ▪ Not at all
Medium comp.	Selection <ul style="list-style-type: none"> ▪ Off ▪ 2-point calibration ▪ Table Factory setting Off	Take a sample from the medium and determine its pH value at different temperatures in the lab. Decide whether you want to compensate using two points or several points in a table.
Offset	-18.00 to 18.00 pH -100 to 100 mg/l Factory setting 0.00 pH 0.00 mg/l	The offset compensates for a difference between a laboratory measurement and an online measurement which is caused by interference ions. Enter this value manually. If you are using a compensation electrode, keep the offset at zero.
Internal buffer	pH 0 to 14 Factory setting pH 7.00	Only change the value if you are using a sensor with an internal buffer other than pH 7.
Oxygen:		
Medium pressure	Selection <ul style="list-style-type: none"> ▪ Process pressure ▪ Air pressure ▪ Altitude ▪ Measured value Factory setting Air pressure	Press Measured value you can connect a pressure measured value via a fieldbus input or a current input. This measured value is then used for medium pressure compensation. For the other types of compensation, specify a compensation value for the measurement in each case. 1. Specify either the altitude (-300 to 4000 m), the process pressure (500 to 9999 hPa) or the air pressure (500 to 1200 hPa) of the measuring point. <ul style="list-style-type: none"> ↳ The pressure used during the calibration is also displayed for information purposes. You can change this pressure in: Calib. settings/ Medium pressure. 2. ▷ Confirm.
Air pressure	Choose from Medium pressure	Specify air pressure (500 to 9999 hPa) of measuring point
Salinity	Selection <ul style="list-style-type: none"> ▪ Fixed value ▪ Measured value Factory setting Fixed value	

Path: Application		
Function	Options	Info
Diagnostic settings		For diagnostic settings of sensor, see section →  39
Format settings		Number of decimal places

Calibration settings

Path: Application/Sensor/Extended setup/Calibration settings		
Function	Options	Info
pH:		
Stability criteria		Once the stability criterion is met, the measured value is displayed in mV.
Delta mV	0.20 to 2.00 % Factory setting 0 %	Measured value depending on connected sensor
Duration	0 ... 60 s Factory setting 0 s	
Temp. compensation	Selection <ul style="list-style-type: none"> ▪ Off ▪ Automatic ▪ Manual Factory setting Automatic	Decide how you want to compensate the buffer temperature: <ul style="list-style-type: none"> ▪ Automatically using the temperature sensor of your sensor (ATC) ▪ Manually by entering the medium temperature ▪ Not at all
Buffer recognition	Selection <ul style="list-style-type: none"> ▪ Fixed ▪ Automatic ¹⁾ ▪ Manual Factory setting Fixed	<p>Fixed You choose values from a list. This list depends on the setting for Buffer manufacturer.</p> <p>Automatic The device recognizes the buffer automatically. The recognition depends on the setting for Buffer manufacturer.</p> <p> As their zero point is offset, enamel pH sensors cannot be calibrated and adjusted with automatic buffer recognition.</p> <p>Manual You enter any two buffer values. These must differ in terms of their pH value.</p>
Buffer manufacturer	Selection <ul style="list-style-type: none"> ▪ Endress+Hauser ▪ Ingold/Mettler ▪ DIN 19266 ▪ DIN 19267 ▪ Merck/Riedel ▪ Hamilton ▪ Special buffer Factory setting Endress+Hauser	Temperature tables are stored internally in the unit for the following pH values: <ul style="list-style-type: none"> ▪ Endress+Hauser 2.00 / 4.00 / 7.00 / (9.00) / 9.22 / 10.00 / 12.00 ▪ Ingold/Mettler 2.00 / 4.01 / 7.00 / 9.21 ▪ DIN 19266 1.68 / 4.01 / 6.86 / 9.18 ▪ DIN 19267 1.09 / 4.65 / 6.79 / 9.23 / 12.75 ▪ Merck/Riedel 2.00 / 4.01 / 6.98 / 8.95 / 12.00 ▪ Hamilton 1.09 / 1.68 / 2.00 / 3.06 / 4.01 / 5.00 / 6.00 / 7.00 / 8.00 / 9.21 / 10.01 / 11.00 / 12.00
Calibration buffer 1 ... 2		The possible options and the factory setting depend on the Buffer manufacturer
Oxygen:		

Path: Application/Sensor/Extended setup/Calibration settings		
Function	Options	Info
Stability criteria		
Delta signal	0.1 to 2.0 % Factory setting 0.2 %	Permitted measured value fluctuation during calibration. Referenced to the raw value in nA in the case of amperometric sensors, and referenced to the raw value in μ S in the case of optical sensors.
Delta temperature	0.10 to 2.00 K Factory setting 0.50 K	Permitted temperature fluctuation during calibration
Duration	5 to 60 s Factory setting 20 s	Timeframe within which the permitted measured value variation may not be exceeded
Ambient conditions		
Medium pressure	Selection <ul style="list-style-type: none"> ■ Process pressure ■ Air pressure ■ Altitude Factory setting Air pressure	
Process pressure Medium pressure = Process pressure	500 to 9999 hPa Factory setting 1013 hPa	Enter the altitude or the average air pressure of the place of calibration (mutually dependent values). If you specify the altitude, the average air pressure is calculated from the barometric altitude formula and vice versa. If you are compensating using the process pressure, enter the pressure in your calibration medium here. The pressure is then independent of the altitude.
Air pressure Medium pressure = Air pressure	500 to 1200 hPa Factory setting 1013 hPa	
Altitude Medium pressure = Altitude	-300 to 4000 m Factory setting 0 m	
Rel. hum. (air variable)	0 to 100 % Factory setting 100 %	
Calibration timer		
Function	Selection <ul style="list-style-type: none"> ■ Off ■ On Factory setting Off	
Calibration check		The function checks whether the calibration of a sensor is still valid. Example: you install a pre-calibrated sensor. The function checks how long ago the sensor was last calibrated. A diagnostics message is displayed if the time since the last calibration is longer than specified by the predefined warning and alarm limit.
Function	Selection <ul style="list-style-type: none"> ■ Off ■ On Factory setting Off	

Path: Application/Sensor/Extended setup/Calibration settings		
Function	Options	Info
Warning limit	1 to 50 w Factory setting 0 w	Warning and alarm limits mutually influence each other's possible adjustment range.
Alarm limit	1 to 50 w Factory setting 0 w	Warning and alarm limits mutually influence each other's possible adjustment range.

1) Only pH sensor or pH/ORP combined sensor

9.7.3 Current output

Path: Application		
Function	Options	Info
Current output		
Output value	<p>pH, ISFET, ORP and combined options</p> <ul style="list-style-type: none"> ▪ pH ▪ Raw value pH ▪ Impedance glass ▪ Impedance reference ▪ rH ▪ ISFET Leakage current ▪ ORP mV ▪ ORP % ▪ Temperature <p>Oxygen options</p> <ul style="list-style-type: none"> ▪ Partial pressure ▪ % saturation ▪ Conc. (liquid) unit ▪ Conc. (gaseous) unit ▪ Raw value μs ▪ Raw value nA ▪ Temperature <p>Conductivity options</p> <ul style="list-style-type: none"> ▪ Conductivity ▪ Resistivity ▪ Raw value (cond. uncomp.) ▪ Temperature 	Depends on connected sensor
Range lower value (4mA)	The unit depends on the sensor configured.	Enter the measuring range. The lower and upper range values are assigned to the 3.6 mA value and the 20 mA value respectively. The system uses the engineering unit which you entered beforehand.
Range upper value (20mA)		

9.7.4 HART

Path Application/HART		
Function	Options	Info
Bus address	0 to 63 Factory setting 0	Enter the bus address Address 1 to 63 Multidrop - mode
PV value	Choose from Current output/Output value	Primary process value
Partial pressure		Partial pressure dependence for oxygen

Path Application/HART		
Function	Options	Info
SV value	<p>pH, ISFET, ORP and combined units</p> <ul style="list-style-type: none"> ▪ pH ▪ Raw value pH ▪ Impedance glass ▪ Impedance reference ▪ rH ▪ ISFET Leakage current ▪ ORP mV ▪ ORP % ▪ Temperature <p>Oxygen units</p> <ul style="list-style-type: none"> ▪ Partial pressure ▪ % saturation ▪ Conc. (liquid) unit ▪ Conc. (gaseous) unit ▪ Raw value μs ▪ Raw value nA ▪ Temperature <p>Conductivity units</p> <ul style="list-style-type: none"> ▪ Conductivity ▪ Resistivity ▪ Raw value (cond. uncomp.) ▪ Temperature 	Protocol-specific data, dynamic variables of HART communication. SV = Secondary TV = Tertiary QV = Quaternary
TV value		
QV value		

9.7.5 Hold

The hold state is a safe condition during configuration and calibration.

Path:System/Hold		
Function	Options	Info
Hold release time	0 to 600 s Factory setting 0 s	The hold status is maintained for the duration of the delay time when you switch to the measuring mode.
Hold behavior	Selection <ul style="list-style-type: none"> ▪ None ▪ Freeze ▪ Fixed value Factory setting Freeze	
Hold current	3.6 to 23 mA Factory setting 0 mA	
Manual hold	Selection <ul style="list-style-type: none"> ▪ Off ▪ On Factory setting Off	On You can use this function to set the channel manually to "Hold". Off No channel-specific hold
Calibration hold	Selection <ul style="list-style-type: none"> ▪ Off ▪ On Factory setting Off	During calibration, the output signal is set to "HOLD"

9.8 Configuration management

Display the following configurations:

System/System information

- General information
- HART

System/Sensor information

- General information
- Extreme values
- Sensor operation
- Sensor specifications
- Calibration information
 - Temperature adjustment
 - Primary value

9.9 Unauthorized access

The compact transmitter is password-protected against unauthorized access.

You can change this password immediately after the password has been entered or under:

System/Bluetooth password

9.9.1 Resetting the password

The recovery password is used to resolve password problems during commissioning of the device. Data security is achieved only if the default setting for the recovery password is changed by the user.

If the user-defined password is lost, access can be restored via a recovery password.

The recovery password is the *serial number* of the device in reverse.

NOTICE

Forgotten recovery password.

If lost, passwords can be reset via Bluetooth only if HART is used. The device cannot be used if it does not have HART communication.

- ▶ Ensure that the login and recovery password are stored in a safe place.

9.9.2 Safe signal transmission via Bluetooth® LE

Signal transmission via Bluetooth® wireless technology uses a cryptographic technique tested by the Fraunhofer Institute.

- Without the SmartBlue app, the device is not visible via Bluetooth® wireless technology.
- Only one point-to-point connection is established between a sensor and a smartphone or tablet.
- The Bluetooth® wireless technology interface can be disabled via the SmartBlue.
- Bluetooth® is optional. It can be ordered with this functionality enabled.
 - If ordered with Bluetooth® disabled, Bluetooth® can be enabled at a later stage by means of an activation code (accessory kit) linked to the serial number.
- If the Bluetooth® interface has been disabled, it can be reactivated only via HART.

9.9.3 RIA15 locking

The device setup can be disabled with a 4-digit user code.

 Further information is available in the RIA15 Operating Instructions BA01170K.

10 Operation

10.1 Reading measured values

The display of the primary values in the app is dependent on the connected sensor.

HOME view
Function
Measurement values
For pH glass, ISFET, ORP or combined sensors:
pH
Raw value pH
Impedance glass
Impedance reference
ORP mV
ORP %
rH
Temperature
For oxygen sensors:
Partial pressure
% saturation
Conc. (liquid) unit
Conc. (gaseous)
Raw value nA
Raw value μ s
Temperature
For conductivity sensors:
Conductivity
Resistivity
Raw value (cond. uncomp.)
Temperature
Current output

Data relating to the transmitter:

TAG
Device type
Serial number
Firmware version
Order code

10.1.1 Changing the parameters

The device functions according to the plug & play principle of Memosens technology.

However, to ensure that the settings of the previous sensor type do not get lost, the new sensor type must be selected in the software.

Path: Guidance/Measurement parameter		
Function	Options	Info
Measurement parameter	Selection <ul style="list-style-type: none"> ▪ pH ▪ Dissolved oxygen ▪ Conductivity 	Select the parameters supported by the device.
With "Finish" the device will be restarted and the measurement parameter change will be executed. This may take a few minutes.		

10.2 Adapting the measuring device to the process conditions

10.2.1 Medium compensation (in the process) for oxygen

Path: Application/Sensor/Extended setup		
Function	Options	Info
Medium pressure	Selection <ul style="list-style-type: none"> ▪ Process pressure ▪ Air pressure ▪ Altitude 	Specify altitude (-300 to 4000 m), process pressure (500 to 9999 hPa) or air pressure (500 to 1200 hPa) of measuring point
Salinity	0 to 40 g/kg Factory setting 0 g/kg	The influence of salt content on oxygen measurement is compensated with this function. Example: sea water measurement as per Copenhagen Standard (30 g/kg).

10.2.2 LED settings (optical oxygen sensors only)

Path: Application/Sensor/Extended setup		
Function	Options	Info
LED temp. mode	Selection <ul style="list-style-type: none"> ▪ Off ▪ On Factory setting Off	Switches off the LED when the set temperature threshold is exceeded. This prevents the premature aging of the sensor cap, e.g. during a CIP or SIP cycle.
LED temp. threshold	30 to 130 °C (86 to 266 °F) Factory setting 80 °C (176 °F)	
LED measuring interval	Selection <ul style="list-style-type: none"> ▪ 1 second ▪ 3 seconds ▪ 10 seconds ▪ 30 seconds Factory setting 1 second	The LED measuring interval influences the response time on the one hand and the operating life of the sensor cap on the other. Shorter intervals improve the response time but reduce the operating life of the sensor cap. Make your setting depending on the requirements of your process.
Measurement filter	Selection <ul style="list-style-type: none"> ▪ Off ▪ Weak ▪ Normal ▪ Strong ▪ Very strong 	Use this function to select how strong or weak the signal filtering in sensor COS81D should be. Off No signal filtering takes place ☐ the recorded signals are passed through virtually unfiltered. Weak Signal filtering is weak. Normal Signal filtering is normal. Strong Signal filtering is strong. Very strong Signal filtering is very strong. Widely fluctuating raw signals are greatly attenuated by the sensor.

11 Diagnostics and troubleshooting

11.1 Diagnostic information via LED

See LED display in Commissioning section. (→  20)

11.2 Adapting the diagnostic information

Path: Diagnostics/Diagnostic settings		
Function	Options	Info
Sensor change alarm delay	0 ... 180 s Factory setting 30 s	Sensor HOLD
Error current	3.6 to 23.0 mA Factory setting 22.5 s	Possible range of error current.
LED shows NAMUR status signal	Selection ▪ Off ▪ On Factory setting Off	* Additional LED signals for diagnostic messages as per NAMUR NE107 categories.
Diagnostics behavior		The list of diagnostic messages displayed. There are device-specific messages, and messages that depend on what sensor is connected. Select the message to be adapted. Only then can you make the settings for this message.
Status signal		The messages are divided into different error categories in accordance with NAMUR NE 107.
Diagnostics behavior	Selection ▪ Warning ▪ Alarm	

* LED as per NAMUR NE107 categories:

Three rapid green flashes at the start of the message means: Everything OK - but pay attention!

The more red flashes there are at the end of a message, the more critical the diagnosis as per NE107. Continuous red only flashing means: Error in device or sensor, take action immediately.

LED behavior	Status
Three rapid green flashes and a single rapid red flash	Device or sensor requires maintenance. M status signal as per NAMUR NE107
Three rapid green flashes and two rapid red flashes	Device and sensor are being operated out of specification. S status as per NAMUR NE107
Three rapid green flashes and three rapid red flashes	Device or sensor undergoing function check. C status signal as per NAMUR NE107
Red Flashes quickly	Failure of device or sensor F status signal as per NAMUR NE107

11.3 Adapting sensor diagnostic information

This menu branch is used for specifying warning limits, and for defining whether and how diagnostics tools should be used.

11.3.1 Impedance monitoring

Path: Application/Sensor/Extended setup/Diagnostic settings		
Function	Options	Info
Glass impedance		
Upper limit	Selection <ul style="list-style-type: none"> ■ Off ■ On Factory setting Off	On The Sensor Check System (SCS) operates with the following settings for the upper warning and alarm limits. Off Monitoring of the upper warning and alarm limits is switched off.
Upper limit	Selection <ul style="list-style-type: none"> ■ Off ■ On Factory setting On	On The Sensor Check System (SCS) operates with the following settings for the upper warning and alarm limits. Off Monitoring of the upper warning and alarm limits is switched off.
Upper alarm limit	0 to 10000 MΩ Factory setting 3000 MΩ	Diagnostics code and associated message text: 124 Sensor glass
Upper warning limit	0 to 10000 MΩ Factory setting 2500 MΩ	Diagnostics code and associated message text: 125 Sensor glass
Lower limit	Selection <ul style="list-style-type: none"> ■ Off ■ On Factory setting Off	On The Sensor Check System (SCS) operates with the following settings for the lower warning and alarm limits. Off Monitoring of the lower warning and alarm limits is switched off.
Lower limit	Selection <ul style="list-style-type: none"> ■ Off ■ On Factory setting On	On The Sensor Check System (SCS) operates with the following settings for the lower warning and alarm limits. Off Monitoring of the lower warning and alarm limits is switched off.
Lower warning limit	0 to 10000 MΩ Factory setting 0.1 MΩ	Diagnostics code and associated message text: 123 Sensor glass
Lower alarm limit	0 to 10000 MΩ Factory setting 0 MΩ	Diagnostics code and associated message text: 122 Sensor glass

11.3.2 Slope

pH, oxygen

Path: Application/Sensor/Extended setup/Diagnostic settings		
Function	Options	Info
pH		
Slope		The slope characterizes the sensor condition. The greater the deviation from the ideal value (pH), the worse the condition of the sensor.
Warning limit	5.00 to 99.00 mV/pH Factory setting 55.00 mV/pH	Specify your limit values for slope monitoring. Associated diagnostic code and message text: 509 sensor calibration
Oxygen		
Upper warning limit	0.0 to 200.0 % Factory setting 140.0 %	Associated diagnostics code and message text: 511 Sensor calibration
Lower warning limit	0.0 to 200.0 % Factory setting 60.0 %	Associated diagnostics code and message text: 509 Sensor calibration

11.3.3 Delta slope

pH, pH/ORP combined sensor, oxygen

Path: Application/Sensor/Extended setup/Diagnostic settings		
Function	Options	Info
pH and pH/ORP combined sensors		
Delta slope		The device determines the difference in slope between the last calibration and the penultimate calibration, and issues a warning or an alarm depending on the setting configured. The difference is an indicator for the condition of the sensor. The greater the change, the greater the wear experienced by the pH-sensitive glass membrane as a result of chemical corrosion or abrasion.
Function	Selection <ul style="list-style-type: none"> ■ Off ■ On 	Switches the function on or off
Warning limit	0.10 to 10.00 mV/pH Factory setting 5.00 mV/pH	Specify your limit values for monitoring the slope differential. Associated diagnostics code and message text: 518 Sensor calibration
Oxygen		

Path: Application/Sensor/Extended setup/Diagnostic settings		
Function	Options	Info
Delta slope		The device determines the difference in slope between the last calibration and the penultimate calibration, and issues a warning or an alarm depending on the setting configured. The difference is an indicator for the condition of the sensor. An increasing change indicates the formation of buildup on the sensor diaphragm or electrolyte contamination. Replace the diaphragm and electrolyte as specified in the instructions in the sensor operating manual.
Function	Selection <ul style="list-style-type: none"> ▪ Off ▪ On Factory setting Off	Switches the function on or off
Warning limit	0.0 to 50.0 % Factory setting 5.0 %	Specify your limit values for monitoring the slope differential. Associated diagnostics code and message text: 518 Sensor calibration

11.3.4 Zero point and operating point

pH, ISFET, oxygen

Path: Application/Sensor/Extended setup/Diagnostic settings		
Function	Options	Info
pH, ISFET		
Zero point (pH glass) Operating point (ISFET)		The zero point or operating point characterizes the condition of the sensor reference. The bigger the deviation from the ideal value (pH 7.00) the poorer the condition. This can be caused by KCl dissolving away or reference contamination, for example.
Upper warning limit	Lower warning limit ... pH 12.00 ¹⁾ Lower warning limit ... 950 mV ²⁾ Factory setting pH 8.00 / 300 mV	Associated diagnostics code and message text: 505 Sensor calibration 515 Sensor calibration ²⁾
Lower warning limit	pH 2.00 to Upper warning limit -950 mV to Upper warning limit ²⁾ Factory setting pH 6.00 / -300 mV	Associated diagnostics code and message text: 507 Sensor calibration 517 Sensor calibration ²⁾
Oxygen		

Path: Application/Sensor/Extended setup/Diagnostic settings		
Function	Options	Info
Zero point		The zero point corresponds to the sensor signal that is measured in a medium in the absence of oxygen. You can calibrate the zero point in water that is free from oxygen or in high-purity nitrogen. This improves accuracy in the trace range.
Warning limit	0.0 to 10.0 nA Factory setting 3.0 nA	Specify the limit values for zero point monitoring in your sensor. Associated diagnostics code and message text: 513 Zero Warning

- 1) pH Glass
- 2) pH ISFET

11.3.5 Delta zero point/operating point

pH, ISFET, oxygen

Path: Application/Sensor/Extended setup/Diagnostic settings		
Function	Options	Info
pH, ISFET		
Delta zero point		The device determines the difference between the last calibration and the penultimate calibration, and issues a warning or an alarm depending on the setting configured. The difference is an indicator for the condition of the sensor.
Function	Selection <ul style="list-style-type: none"> ▪ Off ▪ On 	Switches the function on or off
Warning limit	pH 0.00 to 2.00 (pH glass) Factory setting pH 0.50 / 25 mV	Specify your limit values for monitoring the slope differential. Associated diagnostics code and message text: <ul style="list-style-type: none"> ▪ 520 Sensor calibration (pH glass) ▪ 522 Sensor calibration (ISFET)
Oxygen		
Function	Selection <ul style="list-style-type: none"> ▪ Off ▪ On Factory setting Off	Switches the function on or off
Warning limit	0.0 to 10 nA Factory setting 1.0 nA	Specify your limit values for monitoring the slope differential. Associated diagnostics code and message text: 520 Sensor calibration

11.3.6 Operating hours limits

Path: Application/Sensor/Extended setup/Diagnostic settings		
Function	Options	Info
Limits operating hours		The total operating time of the sensor and its use under extreme conditions is monitored. If the operating time exceeds the defined threshold values, the device issues a corresponding diagnostics message.
Function	Selection <ul style="list-style-type: none"> ■ Off ■ On 	On The operation of the sensor under extreme conditions is monitored, recorded in the sensor and diagnostics messages are displayed on the controller. Off No diagnostics messages. However, the time the sensor operates under extreme conditions is recorded in the sensor and can be read in the sensor information in the diagnostics menu.
Operating time	Factory setting 60000 h	
Operating time > 80 °C	Factory setting 50000 h	Diagnostics code and associated message text: 193 Operating time
Operating time > 80 °C < 100 nS/cm	Factory setting 30000 h	Only conductive sensors
Operating time > 100 °C	Factory setting 50000 h	Diagnostics code and associated message text: 194 Operating time
Operating time > 120 °C	Factory setting 10000 h	Diagnostics code and associated message text: 195 Operating time
Operating time > 150 °C	Factory setting 10000 h	Diagnostics code and associated message text: 198 Operating time
Operating time < -300 mV	Factory setting 60000 h	<i>Only pH sensor or pH/ORP combined sensor</i>
Operating time > 300 mV	Factory setting 60000 h	<i>Only pH sensor or pH/ORP combined sensor</i>

11.3.7 Sterilizations

Path: Application/Sensor/Extended setup/Diagnostic settings		
Function	Options	Info
Sterilizations		The system counts the number of operating hours in which the sensor is exposed to a temperature that is typical for a sterilization. This temperature depends on the sensor.
Function	Selection <ul style="list-style-type: none"> ■ Off ■ On 	Switches the function on or off
Warning limit	0 to 1000 Factory setting 800	Specify the limit value for the number of sensor sterilizations. Diagnostics code and associated message text: 108 SIP, CIP, autoclaving

Cap sterilizations (only sterilizable sensors)

Path: Application/Sensor/Extended setup/Diagnostic settings		
Function	Options	Info
No. sterilizations cap		Not displayed for optical oxygen sensors. The sterilization counters in the sensor make a distinction between the sensor and the membrane/fluorescence cap currently used. If this cap is replaced, only the (cap) counter is reset.
Function	Selection <ul style="list-style-type: none"> ■ Off ■ On Factory setting Off	Specify how many sterilizations may be performed with a membrane cap before the cap has to be replaced. The number depends heavily on the process and must be determined individually.
Warning limit	0 to 100 Factory setting 25	Associated diagnostics code and message text: 109 Sterilization cap

11.3.8 Sensor Condition Check (SCC)

Path: Application/Sensor/Extended setup/Diagnostic settings		
Function	Options	Info
Sensor condition check		<p>Sensor condition check (SCC) monitors the electrode status and the degree of electrode aging. The condition of the electrode is updated after every calibration.</p> <p>The main reasons for a deteriorating electrode status are:</p> <ul style="list-style-type: none"> ▪ Glass membrane blocked or dry ▪ Diaphragm (reference) blocked
Function	Selection <ul style="list-style-type: none"> ▪ Off ▪ On 	Switches the function on or off Diagnostics code and associated message text: 127 SCC adequate 126 SCC poor

11.3.9 Process monitoring

Path: Application/Sensor/Extended setup/Diagnostic settings		
Function	Options	Info
Process check system		The process check system (PCS) checks the measuring signal for stagnation. An alarm is triggered if the measuring signal does not change over a specific period (several measured values).
Function	Selection <ul style="list-style-type: none"> ▪ Off ▪ On 	Switches the function on or off
Duration	0 to 240 min	Once this time has elapsed, the calibration timer diagnostic message, along with the code 102, appears on the display.
Tolerance width <i>Not for pH/ORP sensors</i>	The range depends on the sensor Factory setting Depends on the sensor	Interval around the measuring signal (raw value) for detecting stagnation. Measured values within the set interval are regarded as stagnating.

11.3.10 Measured value

Path: Application/Sensor/Extended setup/Diagnostic settings		
Function	Options	Info
ORP-Meas value		
Function	Selection <ul style="list-style-type: none"> ▪ Off ▪ On 	Switches the function on or off
Upper alarm value	0 to 10000 mV	Diagnostics code and associated message text: 124 Sensor glass

Path: Application/Sensor/Extended setup/Diagnostic settings		
Function	Options	Info
Upper warning limit	0 to 10000 mV	Diagnostics code and associated message text: 125 Sensor glass
Lower warning limit	0 to 10000 mV	Diagnostics code and associated message text: 123 Sensor glass
Lower alarm value	0 to 10000 mV	Diagnostics code and associated message text: 122 Sensor glass

11.3.11 Pharmaceutical water

Path: Application/Sensor/Extended setup/Diagnostic settings		
Pharma water		Here you can make settings for monitoring pharmaceutical water in accordance with the United States Pharmacopoeia (USP) or European Pharmacopoeia (EP). The uncompensated conductivity value and the temperature are measured for the limit functions. The measured values are compared against the tables defined in the standards. An alarm is triggered if the limit value is exceeded. Furthermore, you can also set a preliminary alarm (warning limit) which signals undesired operating states before they occur.
Function	Selection <ul style="list-style-type: none"> ■ Off ■ EP ■ USP Factory setting Off	The alarm values are stored in the device in accordance with USP <645> or EP <169> specifications. You define the warning limit as a % of the alarm value.
Off	10.0 to 99.9 % Factory setting 80.0 %	Diagnostics code and associated message text: 915 USP / EP warning If the value exceeds the USP or EP alarm values saved in the software, diagnostics message 914 USP/ EP alarm is displayed.

11.3.12 Cap calibrations

Path: Application/Sensor/Extended setup/Diagnostic settings		
Function	Options	Info
No. calibrations cap		Not displayed for optical oxygen sensors The calibration counters in the sensor make a distinction between sensor calibrations and calibrations with the membrane cap currently used. If this cap is replaced, only the (cap) counter is reset.
Function	Selection <ul style="list-style-type: none"> ■ Off ■ On Factory setting Off	Specify how many calibrations may be performed with a membrane cap before the cap has to be replaced. The number depends heavily on the process and must be determined individually.
Warning limit	0 to 1000 Factory setting 6	Associated diagnostics code and message text: 535 Sensor check

11.3.13 Calibration quality index (optical sensors only)

Path: Application/Sensor/Extended setup/Diagnostic settings		
Function	Options	Info
Cal. quality index		Monitoring of calibration quality index for COS81D. Significant changes in the value may be a sign of spot aging or poor calibration.
Function	Selection <ul style="list-style-type: none"> ■ Off ■ On Factory setting Off	Switches the function on or off
Warning limit	0 ... 100 % Factory setting 80 %	Associated diagnostics code and message text: 734 Calibration quality

11.4 Simulation

You can simulate certain parameters for test purposes:

- Current value
- Measured value
- Temperature

Main menu/Diagnostics/Simulation		
Function	Options	Info
Current output		Simulation of an output current
Simulation	Selection <ul style="list-style-type: none"> ▪ Off ▪ On Factory setting Off	Switch on or off simulation
Simulation value	Unit: Window:	Set current value
Measurement value		Simulation of a measured value
Simulation	Selection <ul style="list-style-type: none"> ▪ Off ▪ On Factory setting Off	Switch on or off simulation
Measured value		Select measured variable to be simulated, depending on connected sensor.
Simulation value	Unit: Window:	Display the simulated measured value in the selected unit.
Temperature		Simulation of temperature
Simulation	Selection <ul style="list-style-type: none"> ▪ Off ▪ On Factory setting Off	Switch on or off simulation
Simulation value	Unit: Window:	Display the simulated temperature value in the selected unit

11.5 Diagnostic list

11.5.1 Diagnostic messages

In accordance with Namur specification NE 107, the diagnostic messages are characterized by:

- Message number
- Error category (letter in front of the message number)
 - **F** = (Failure) a malfunction has been detected
 - **C** = (Function check), (no error)
 - Maintenance work is being performed on the device. Wait until the work has been completed.
 - **S** = (Out of specification), the measuring point is being operated outside its specification
 - Operation is still possible. However, you run the risk of increased wear, shorter operating life or lower measurement accuracy. The cause of the problem is to be found outside the measuring point.
 - **M** = (Maintenance required), action should be taken as soon as possible
- Sensor type:
 - P = pH
 - C = conductivity
 - O = oxygen
- Message text

No.	Message	Factory settings			Sensor type	Configurable	Tests or remedial action
		S ¹⁾	D ²⁾	F ³⁾			
002	Sensor unknown	F	On	On	All	No	▶ Replace sensor.
004	Sensor defective	F	On	On	All		
005	Sensor data invalid	F	On	On	All	No	<ol style="list-style-type: none"> 1. Check the firmware compatibility of the sensor and transmitter or load suitable firmware 2. Set the sensor to the factory settings, disconnect the sensor and reconnect it. 3. Update transmitter data 4. Replace sensor.
010	Sensor scanning	F	Off	Off	All	No	▶ Wait for initialization to be finished.
012	Writing data failed	F	On	On	All	No	<ol style="list-style-type: none"> 1. Repeat write process. 2. Replace sensor.
013	Sensor type wrong	F	On	On	All	No	▶ Replace sensor, making sure correct sensor type is used.
018	Sensor not ready	F	On	On	All	No	<p>Sensor communication blocked</p> <ol style="list-style-type: none"> 1. Sensor fails tag check. Replace. 2. Internal software error. Contact the Service Department.
022	Temperature sensor	F	On	On	All	Yes	<p>Temperature sensor defective</p> ▶ Replace sensor.
061	Sensor electronic	F	On	On	All	No	<p>Sensor electronics defective</p> ▶ Replace sensor.
062	Sensor connection	F	On	On	All	No	<ol style="list-style-type: none"> 1. Check sensor connection. 2. Contact the Service Department.
100	Sensor communication	F	On	On	All	No	<p>Sensor not communicating</p> <ol style="list-style-type: none"> 1. Check sensor connection. 2. Check sensor connector. 3. Contact the Service Department.
102	Calibration timer	M	On	Off	All	Yes	<p>Calibration interval elapsed. Measurement can still take place.</p> ▶ Calibrate sensor.
104	Calibration validity	M	On	Off	All	Yes	<p>Last calibration no longer valid. Measurement can still take place.</p> ▶ Calibrate sensor.

No.	Message	Factory settings			Sensor type	Configurable	Tests or remedial action
		S ¹⁾	D ²⁾	F ³⁾			
105	Calibration validity	M	On	Off	All	Yes	Last calibration will lose its validity soon. Measurement can still take place. ► Calibrate sensor.
106	Sensor TAG	F	On	On	All	No	Sensor has invalid tag or tag group
107	Calibration active	C	On	Off	All	No	► Wait for calibration to be finished.
108	SIP, CIP, autoclaving	M	On	Off	O	Yes	Specified number of sterilizations will soon be reached. Measurement can still take place. ► Replace sensor.
109	Sterilization cap	M	On	Off	O	No	Specified number of sterilizations for the cap is reached. Measurement can still take place. ► Replace membrane cap.
111	Operating time cap	M	On	Off	O	No	Hours of operation monitoring The limit set for the total hours of operation for the cap has been reached. Measurement can still take place. <ol style="list-style-type: none">1. Replace the cap.2. Change monitoring limit.
118	Sensor glass break.	F	On	Off	P (glass)	Yes	Glass breakage warning, impedance of pH glass too low
119	Sensor check	M	On	Off	P (glass)	No	Measuring can continue until the alarm (118) occurs. <ol style="list-style-type: none">1. Inspect sensor for hair-line cracks and breakage.2. Check medium temperature.3. Replace sensor.
120	Sensor reference	F	On	Off	P (glass)	Yes	Reference warning, impedance of reference too low
121	Sensor reference	M	On	Off	P (glass)	No	Measuring can continue until the alarm (120) occurs. <ol style="list-style-type: none">1. Check reference for clogging/contamination.2. Clean reference/junction.3. Replace sensor.

No.	Message	Factory settings			Sensor type	Configurable	Tests or remedial action
		S ¹⁾	D ²⁾	F ³⁾			
122	Sensor glass	F	On	Off	P (glass)	Yes	Impedance limit values exceeded/undershot Measuring can continue until the alarm (122, 124) occurs. <ol style="list-style-type: none"> 1. Inspect sensor for hair-line cracks and breakage. 2. Check or change limit values. 3. Replace sensor.
123	Sensor glass	M	On	Off	P (glass)	Yes	
124	Sensor glass	M	On	Off	P (glass)	Yes	
125	Sensor glass	F	On	Off	P (glass)	Yes	
126	Sensor check	M	On	Off	P (glass)	No	Sensor condition check (SCC), poor sensor condition Glass membrane fouled or dry, junction blocked <ol style="list-style-type: none"> 1. Clean sensor, regenerate 2. Replace sensor.
127	Sensor check	M	On	Off	P (glass)	No	Sensor condition check (SCC), adequate sensor condition
128	Sensor leakage	F	On	Off	P (ISFET), O	Yes	Leak current alarm Defective due to abrasion or damage Damage to the gate (only ISFET) ► Replace sensor.
129	Sensor leakage	F	On	Off	P (ISFET), DO	Yes	Leak current warning Measuring can continue until the alarm occurs
130	Sensor supply	F	On	Off	P, O	Yes	Poor sensor power supply <ol style="list-style-type: none"> 1. Check sensor connection. 2. Replace sensor.
131	Sensor calibration	M	On	Off	O	No	Limit values for sensor relaxation time (fluorescence decay time) exceeded/undershot Reasons: high oxygen content, incorrect calibration <ol style="list-style-type: none"> 1. Repeat calibration. 2. Replace sensor cap. 3. Contact the Service Department.
132	Sensor calibration	M	On	Off	O		
133	Sensor signal	F	On	Off	O	No	No signal (fluorescence decay) <ol style="list-style-type: none"> 1. Replace sensor cap. 2. Contact the Service Department.

No.	Message	Factory settings			Sensor type	Configurable	Tests or remedial action
		S ¹⁾	D ²⁾	F ³⁾			
134	Sensor signal	M	On	Off	O	No	Low signal amplitude. Measurement can still take place. <ol style="list-style-type: none">1. Replace sensor cap.2. Contact the Service Department.
136	Sensor temp. high	S	On	Off	O	No	Temperature outside specification <ol style="list-style-type: none">1. Check process.2. Check installation.
141	Polarization	F	On	Off	C	No	Polarization warning The measured value is corrupted at high conductivity levels. ► Use a sensor with a larger cell constant.
142	Sensor signal	F	On	Off	C	No	Reasons: sensor in air, sensor defective <ol style="list-style-type: none">1. Check installation.2. Replace sensor.
146	Sensor temperature	S	Off	Off	All	Yes	Temperature outside specification <ol style="list-style-type: none">1. Check the temperature.2. Check electrode system.3. Replace sensor type.
154	Sensor data invalid	M	Off	Off	C	No	Factory calibration is used ► Calibrate.
160	Sensor data invalid	F	On	Off	All	No	No calibration data Reasons: data deleted <ol style="list-style-type: none">1. Select other data record.2. Use factory calibration.3. Contact the Service Department.
164	Sensor data invalid	M	Off	Off	C	No	No temperature calibration data Factory calibration is used <ol style="list-style-type: none">1. Check process.2. Check or replace sensor.
168	Polarization	S	On	Off	C (cond.)	No	Polarization warning The measured value is corrupted at high conductivity levels. ► Use a sensor with a larger cell constant.

No.	Message	Factory settings			Sensor type	Configurable	Tests or remedial action
		S ¹⁾	D ²⁾	F ³⁾			
178	Operating time	M	On	Off	All	No	Operating hours > 15 °C, measurement can still take place <ol style="list-style-type: none"> 1. Replace sensor. 2. Change monitoring limit. 3. Disable monitoring.
179	Operating time	M	On	Off	P	No	Operating hours > 300 mV, measurement can still take place <ol style="list-style-type: none"> 1. Replace sensor. 2. Change monitoring limit. 3. Disable monitoring.
180	Operating time	M	On	Off	P	No	Operating hours < -300 mV, measurement can still take place <ol style="list-style-type: none"> 1. Replace sensor. 2. Change monitoring limit. 3. Disable monitoring.
183	Operating time	M	On	Off	O (amp.)	No	Operating hours > 10 nA (COS51D), measurement can still take place <ol style="list-style-type: none"> 1. Replace sensor. 2. Change monitoring limit. 3. Disable monitoring.
184	Operating time	M	On	Off	O (amp.)	No	Operating hours > 30 nA (COS22D), measurement can still take place <ol style="list-style-type: none"> 1. Replace sensor. 2. Change monitoring limit. 3. Disable monitoring.
185	Operating time	M	On	Off	O (amp.)	No	Operating hours > 40 nA (COS51D), measurement can still take place <ol style="list-style-type: none"> 1. Replace sensor. 2. Change monitoring limit. 3. Disable monitoring.
186	Operating time	M	On	Off	O (amp.)	No	Operating hours > 160 nA (COS22D), measurement can still take place <ol style="list-style-type: none"> 1. Replace sensor. 2. Change monitoring limit. 3. Disable monitoring.

No.	Message	Factory settings			Sensor type	Configurable	Tests or remedial action
		S ¹⁾	D ²⁾	F ³⁾			
187	Operating time	M	On	Off	C	No	Operating hours > 80 °C, 100 nS/cm, measurement can still take place <ol style="list-style-type: none"> 1. Replace sensor. 2. Change monitoring limit. 3. Disable monitoring.
189	Operating time	M	On	Off	O	No	Operating hours > 5 °C, measurement can still take place <ol style="list-style-type: none"> 1. Replace sensor. 2. Change monitoring limit. 3. Disable monitoring.
191	Operating time	M	On	Off	O	No	Operating hours > 30 °C, measurement can still take place <ol style="list-style-type: none"> 1. Replace sensor. 2. Change monitoring limit. 3. Disable monitoring.
192	Operating time	M	On	Off	O	No	Operating hours > 40 °C, measurement can still take place <ol style="list-style-type: none"> 1. Replace sensor. 2. Change monitoring limit. 3. Disable monitoring.
193	Operating time	M	On	Off	P, C, O	No	Operating hours > 80 °C, measurement can still take place <ol style="list-style-type: none"> 1. Replace sensor. 2. Change monitoring limit. 3. Disable monitoring.
194	Operating time	M	On	Off	P	No	Operating hours > 100 °C, measurement can still take place <ol style="list-style-type: none"> 1. Replace sensor. 2. Change monitoring limit. 3. Disable monitoring.
195	Operating time	M	On	Off	C	No	Operating hours > 120 °C, measurement can still take place <ol style="list-style-type: none"> 1. Replace sensor. 2. Change monitoring limit. 3. Disable monitoring.

No.	Message	Factory settings			Sensor type	Configurable	Tests or remedial action
		S ¹⁾	D ²⁾	F ³⁾			
197	Operating time	M	On	Off	C	No	Operating hours > 140 °C, measurement can still take place <ol style="list-style-type: none"> 1. Replace sensor. 2. Change monitoring limit. 3. Disable monitoring.
198	Operating time	M	On	Off	C	No	Operating hours > 150 °C, measurement can still take place <ol style="list-style-type: none"> 1. Replace sensor. 2. Change monitoring limit. 3. Disable monitoring.
199	Operating time	M	On	Off	All	No	Total operating hours
202	Self-test active	F	On	On	All	No	Self-test active, please wait
215	Simulation active	C	On	Off	All	No	Simulation active End simulation by changing to measuring mode.
216	Hold active	C	On	Off	All	No	HOLD active - output values and channel status are on hold ▶ Please wait
241	Firmware error	F	On	On	All	No	Software error - internal <ol style="list-style-type: none"> 1. Carry out software update 2. Replace backplane please 3. Please contact the Service Department and quote the number shown
243	Firmware error	F	On	On	All	No	Software error - internal <ol style="list-style-type: none"> 1. Carry out software update 2. Replace backplane please 3. Please contact the Service Department and quote the number shown
284	Firmware update	F	On	On	All	No	Firmware update active, please wait.
285	Update error	F	On	On	All	No	Firmware update failed, possible reasons: <ul style="list-style-type: none"> ▪ Read error ▪ SD card is faulty ▪ Incorrect firmware on SD card <ol style="list-style-type: none"> 1. Check device settings 2. Check electronics module type

No.	Message	Factory settings			Sensor type	Configurable	Tests or remedial action
		S ¹⁾	D ²⁾	F ³⁾			
373	Temperature of electronics is high	M	On	Off	All	No	Temperature of backplane electronics is high <ul style="list-style-type: none"> ▶ Check ambient temperature and energy consumption
384	Firmware error	F	On	On	All	No	Sensor measuring sequence counter. No measurement signal from sensor <ol style="list-style-type: none"> 1. Update software 2. Contact the Service Department
408	Calibration aborted	M	Off	Off	P, C, O,	No	Calibration aborted
411	Up-/Download active, please wait	C	On	Off	All	No	Up-/download active <ul style="list-style-type: none"> ▶ Please wait
460	Output undershot	S	On	Off	All	No	Current output undershot Measured value out of specified current range, possible reasons: <ul style="list-style-type: none"> ▪ Sensor / sample line in air ▪ Air pockets in the assembly ▪ Incorrect flow to sensor ▪ Sensor / sample line is contaminated <ol style="list-style-type: none"> 1. Check sensor. 2. Check application. 3. Check application. 4. Clean sensor / sample line.
461	Output overshoot	S	On	Off	All	No	Current output overshoot Measured value out of specified current range, possible reasons: <ul style="list-style-type: none"> ▪ Sensor / sample line in air ▪ Air pockets in the assembly ▪ Incorrect flow to sensor ▪ Sensor / sample line is contaminated <ol style="list-style-type: none"> 1. Check sensor. 2. Check application. 3. Check application. 4. Clean sensor / sample line.
500	Sensor calibration	M	On	Off	All	No	Calibration aborted, main measured value varies Reasons: sensor too old, sensor occasionally dry, calibration value not constant <ol style="list-style-type: none"> 1. Check sensor. 2. Check calibration solution.

No.	Message	Factory settings			Sensor type	Configurable	Tests or remedial action
		S ¹⁾	D ²⁾	F ³⁾			
501	Sensor calibration	M	On	Off	All	No	<p>Calibration aborted, temperature measured value varies</p> <p>Reasons: sensor too old, sensor occasionally dry, temperature of calibration solution not constant</p> <ol style="list-style-type: none"> 1. Check sensor. 2. Regulate calibration solution temperature.
505	Sensor calibration	M	On	Off	P, O	No	<p>Max. zero point warning, measurement can still take place</p> <p>Possible reasons: sensor old or defective, reference blocked, calibration solution too old or contaminated</p> <ol style="list-style-type: none"> 1. Check or replace sensor. 2. Check or replace calibration solution. 3. Repeat calibration.
507	Sensor calibration	M	On	Off	P, O	No	<p>Min. zero point warning, measurement can still take place</p> <p>Possible reasons: sensor old or defective, reference blocked, calibration solution too old or contaminated</p> <ol style="list-style-type: none"> 1. Check or replace sensor. 2. Check or replace calibration solution. 3. Repeat calibration.
509	Sensor calibration	M	On	Off	P, O	No	<p>Min. slope warning, measurement can still take place</p> <p>Possible reasons: sensor old or defective, reference blocked, calibration solution too old or contaminated</p> <ol style="list-style-type: none"> 1. Check or replace sensor. 2. Check or replace calibration solution. 3. Repeat calibration.

No.	Message	Factory settings			Sensor type	Configurable	Tests or remedial action
		S ¹⁾	D ²⁾	F ³⁾			
511	Sensor calibration	M	On	Off	P, O	No	<p>Max. slope warning, measurement can still take place</p> <p>Possible reasons: sensor old or defective, reference blocked, calibration solution too old or contaminated</p> <ol style="list-style-type: none"> 1. Check or replace sensor. 2. Check or replace calibration solution. 3. Repeat calibration.
513	Zero Warning	M	On	Off	O (amp.)	No	<p>Zero point warning, measurement can still take place</p> <p>Possible reasons: sensor old or defective, reference blocked, calibration solution too old or contaminated</p> <ol style="list-style-type: none"> 1. Check or replace sensor. 2. Check or replace calibration solution. 3. Repeat calibration.
515	Sensor calibration	M	On	Off	P (ISFET)	No	<p>Max. operating point warning, measurement can still take place</p> <p>Possible reasons: sensor old or defective, reference blocked, calibration solution too old or contaminated</p> <ol style="list-style-type: none"> 1. Check or replace sensor. 2. Check or replace calibration solution. 3. Repeat calibration.
517	Sensor calibration	M	On	Off	P (ISFET)	No	<p>Min. operating point warning, measurement can still take place</p> <p>Possible reasons: sensor old or defective, reference blocked, calibration solution too old or contaminated</p> <ol style="list-style-type: none"> 1. Check or replace sensor. 2. Check or replace calibration solution. 3. Repeat calibration.

No.	Message	Factory settings			Sensor type	Configurable	Tests or remedial action
		S ¹⁾	D ²⁾	F ³⁾			
518	Sensor calibration	M	On	Off	P, O	No	<p>Delta slope warning, measurement can still take place</p> <p>Possible reasons: sensor old or defective, reference blocked, calibration solution too old or contaminated</p> <ol style="list-style-type: none"> 1. Check or replace sensor. 2. Check or replace calibration solution. 3. Repeat calibration.
520	Sensor calibration	M	On	Off	P, O	No	<p>Delta zero point warning, measurement can still take place</p> <p>Possible reasons: sensor old or defective, reference blocked, calibration solution too old or contaminated</p> <ol style="list-style-type: none"> 1. Check or replace sensor. 2. Check or replace calibration solution. 3. Repeat calibration.
522	Sensor calibration	M	On	Off	P (ISFET)	No	<p>Delta operating point warning, measurement can still take place</p> <p>Possible reasons: sensor old or defective, reference blocked, calibration solution too old or contaminated</p> <ol style="list-style-type: none"> 1. Check or replace sensor. 2. Check or replace calibration solution. 3. Repeat calibration.
532	License error	M	On	Off	All	No	License error
534	Electrolyte warning	M	On	Off	All	No	<p>Electrolyte depletion warning The configured electrolyte depletion limit has been reached. Measurement is still possible.</p> <ol style="list-style-type: none"> 1. Replace electrolyte and, if necessary, the membrane cap. 2. Reset counter for CAL 3. Replace electrolyte, or replace sensor cap and electrolyte. 4. Replace sensor
535	Sensor check	M	On	Off	O (amp.)	No	<p>Specified number of cap calibrations is reached Measurement can still take place.</p> <p>► Replace sensor cap.</p>

No.	Message	Factory settings			Sensor type	Configurable	Tests or remedial action
		S ¹⁾	D ²⁾	F ³⁾			
550	Process temperature	S	On	Off	C	No	Process temperature above/ below concentration table <ul style="list-style-type: none"> ■ Process value outside specification ■ Table incomplete <ul style="list-style-type: none"> ▶ Extend table.
551	Process temperature	S	On	Off	C		
552	Conductivity low	S	On	Off	C	No	Process concentration above/ below concentration table <ul style="list-style-type: none"> ■ Process value outside specification ■ Table incomplete <ul style="list-style-type: none"> ▶ Extend table.
553	Conductivity high	S	On	Off	C		
554	Concentration low	S	On	Off	C	No	Process concentration above/ below concentration table <ul style="list-style-type: none"> ■ Process value outside specification ■ Table incomplete <ul style="list-style-type: none"> ▶ Extend table.
555	Concentration high	S	On	Off	C		
722	Sensor reference	F	On	On	P	Yes	Alarm: Reference membrane impedance too low. <ol style="list-style-type: none"> 1. Check or replace sensor. 2. Check/correct reference limit value.
723	Sensor reference	M	On	Off	All	Yes	Warning: Reference membrane impedance too low. Can continue measuring until the alarm occurs. <ol style="list-style-type: none"> 1. Check or replace sensor. 2. Check/correct reference limit value.
724	Sensor reference	F	On	On	All	Yes	Alarm: Reference membrane impedance too high. <ol style="list-style-type: none"> 1. Check or replace sensor. 2. Check/correct reference limit value.
725	Sensor reference	M	On	Off	All	Yes	Warning: Reference membrane impedance too high. Can continue measuring until the alarm occurs. <ol style="list-style-type: none"> 1. Check or replace sensor. 2. Check/correct reference limit value.

No.	Message	Factory settings			Sensor type	Configurable	Tests or remedial action
		S ¹⁾	D ²⁾	F ³⁾			
734	Calibration quality	M	On	Off	All	No	Min. Calibration quality warning Measurement is still possible. There is a significant change in calibration quality since the last calibration. <ol style="list-style-type: none"> 1. Repeat the calibration 2. Check sensor and replace if necessary
740	Sensor defective	F	On	On	C	No	Internal electrode failure <ol style="list-style-type: none"> 1. Replace sensor. 2. Contact the Service Department.
832	Temp. range exceeded	S	Off	Off	All	Yes	Outside temperature specification <ol style="list-style-type: none"> 1. Check application. 2. Check temperature sensor.
841	Operating range	S	Off	Off	All	Yes	Process value outside operational range <ol style="list-style-type: none"> 1. Check application. 2. Check sensor.
842	Process value	S	Off	Off	P	Yes	Process limit value exceeded/undershot Reasons: sensor in air, air pockets in assembly, incorrect flow to sensor, sensor defective <ol style="list-style-type: none"> 1. Change process value. 2. Check electrode system. 3. Change sensor type.
843	Process value	S	Off	Off	P		
904	Process check alarm	F	On	On	All	No	Stagnating measuring signal Reasons: sensor in air, sensor fouling, incorrect flow to sensor, sensor defective <ol style="list-style-type: none"> 1. Check electrode system. 2. Check sensor. 3. Restart the device.
910	Limit switches	S	On	Off		No	Limit switch activated
914	USP/ EP alarm	M	On	Off	C	Yes	USP limit values exceeded ► Check process.
915	USP / EP warning	M	On	Off	C		
942	Process value	S	Off	Off	P	No	Process value high <ol style="list-style-type: none"> 1. Do not increase process value. 2. Check electrode system. 3. Change sensor type.

No.	Message	Factory settings			Sensor type	Configurable	Tests or remedial action
		S ¹⁾	D ²⁾	F ³⁾			
943	Process value	S	Off	Off	P	No	Process value low <ol style="list-style-type: none"> 1. Do not decrease process value. 2. Check electrode system. 3. Change sensor type.
987	Calibration required	M	On	On	I, DI	No	Electrode replacement <ul style="list-style-type: none"> ▶ Calibrate sensor.

- 1) **Status signal**
2) **Diagnostic message**
3) **Error current**

11.6 Event logbook

Main menu/Diagnostics/Diagnostics logbook	
Function	Info
Time	Time when diagnostic message occurred.
Event	Indicate whether message is going or coming .
Status signal	Error category and fault elimination

11.7 Resetting the measuring device

Path: System/Device management/Reset		
Function	Options	Info
Device restart	Press Finish to start the application Press X to close the wizard without running it and to go back.	Restart and keep all the settings
Factory default	Press Finish to start the application Press X to close the wizard without running it and to go back.	Restart with factory settings Settings that have not been saved are lost.

11.8 Device information

11.8.1 Squawk

Main menu/system

Path: System/Device management/Squawk		
Function	Options	Info
Squawk	Selection ■ Off ■ On Factory setting Off	Squawk is signaled briefly while the connection is established. The app can also be used to enable Squawk. This allows the device to be located more quickly in large installations.

11.9 Firmware history

Date	Version	Changes to firmware	Documentation
02/2018	01.01.00	Original firmware	BA01845C/07/EN/01.18

11.9.1 Firmware update

 Information on available firmware updates can be obtained from your app store or sales office.

The current firmware version and device type can be found under: **System/Firmware update**

12 Maintenance

The maintenance of the measuring point comprises:

- Calibration
- Cleaning the controller, assembly and sensor
- Checking the cables and connections.

WARNING

Process pressure and temperature, contamination

Risk of serious or fatal injury

- ▶ If the sensor has to be removed during maintenance work, avoid hazards posed by pressure, temperature and contamination.

NOTICE

Electrostatic discharge (ESD)

Risk of damaging the electronic components

- ▶ Take personal protective measures to avoid ESD, such as discharging beforehand at PE or permanent grounding with a wrist strap.

12.1 Maintenance tasks

12.1.1 Cleaning

NOTICE

Cleaning agents not permitted

Damage to housing surface and optical waveguide

- ▶ Never use concentrated mineral acids or alkaline solutions for cleaning.
- ▶ Never use organic cleaners such as acetone, benzyl alcohol, methanol, methylene chloride, tetrahydrofuran, xylene or concentrated glycerol cleaner.

The device is resistant to:

- Ethanol (for a short time)
- Diluted acids (max. 2% HCl)
- Diluted bases (max. 3% NaOH)
- Soap-based household cleaning agents
- Washing-up liquid

12.1.2 Calibration

To calibrate the sensor, remove it from the medium and calibrate it in the laboratory. Since Memosens sensors save the data, you can always work with "precalibrated" sensors and do not have to stop monitoring the process to perform a calibration.

1. Menu: **Guidance/Calibration** menu item.
2. Select calibration type.
3. Follow the instructions of the software.
4. Return the sensor to the medium.
 - ↳ This deactivates the hold and the system starts measuring again.

You can cancel the calibration by pressing X. No data are then used to adjust the sensor.

13 Repair

13.1 General notes

- ▶ Only use spare parts from Endress + Hauser to guarantee the safe and stable functioning of the device.

Detailed information on the spare parts is available at:

www.endress.com/device-viewer

13.2 Return

The product must be returned if repairs or a factory calibration are required, or if the wrong product was ordered or delivered. As an ISO-certified company and also due to legal regulations, Endress+Hauser is obliged to follow certain procedures when handling any returned products that have been in contact with medium.

To ensure the swift, safe and professional return of the device:

- ▶ Refer to the website www.endress.com/support/return-material for information on the procedure and conditions for returning devices.

13.3 Disposal

The device contains electronic components, and must therefore be disposed of in accordance with regulations on the disposal of electronic waste.

- ▶ Observe the local regulations.

14 Accessories

14.1 Sensors

14.1.1 Glass electrodes

Orbisint CPS11D

- pH electrode for process technology
- Optional SIL version for connecting to SIL transmitter
- With dirt-repellent PTFE diaphragm
- Product Configurator on the product page: www.endress.com/cps11d



Technical Information TI00028C

Memosens CPS31D

- pH electrode with gel-filled reference system with ceramic diaphragm
- Product Configurator on the product page: www.endress.com/cps31d



Technical Information TI00030C

Ceraliquid CPS41D

- pH electrode with ceramic junction and KCl liquid electrolyte
- Product Configurator on the product page: www.endress.com/cps41d



Technical Information TI00079C

Ceragel CPS71D

- pH electrode with reference system including ion trap
- Product Configurator on the product page: www.endress.com/cps71d



Technical Information TI00245C

Memosens CPS171D

- pH electrode for bio-fermenters with digital Memosens technology
- Product Configurator on the product page: www.endress.com/cps171d



Technical Information TI01254C

Orbipore CPS91D

- pH electrode with open aperture for media with high dirt load
- Product Configurator on the product page: www.endress.com/cps91d



Technical Information TI00375C

Orbipac CPF81D

- Compact pH sensor for installation or immersion operation
- In industrial water and wastewater
- Product Configurator on the product page: www.endress.com/cpf81d



Technical Information TI00191C

14.1.2 Enamel pH electrodes

Ceramax CPS341D

- pH electrode with pH-sensitive enamel
- Meets highest demands of measuring accuracy, pressure, temperature, sterility and durability
- Product Configurator on the product page: www.endress.com/cps341d



Technical Information TI00468C

14.1.3 ORP sensors

Orbisint CPS12D

- ORP sensor for process technology
- Product Configurator on the product page: www.endress.com/cps12d

 Technical Information TI00367C

Ceraliquid CPS42D

- ORP electrode with ceramic junction and KCl liquid electrolyte
- Product Configurator on the product page: www.endress.com/cps42d

 Technical Information TI00373C

Ceragel CPS72D

- ORP electrode with reference system including ion trap
- Product Configurator on the product page: www.endress.com/cps72d

 Technical Information TI00374C

Orbipac CPF82D

- Compact ORP sensor for installation or immersion operation in process water and wastewater
- Product Configurator on the product page: www.endress.com/cpf82d

 Technical Information TI00191C

Orbipore CPS92D

- ORP electrode with open aperture for media with high dirt load
- Product Configurator on the product page: www.endress.com/cps92d

 Technical Information TI00435C

14.1.4 pH ISFET sensors

Tophit CPS441D

- Sterilizable ISFET sensor for low-conductivity media
- Liquid KCl electrolyte
- Product Configurator on the product page: www.endress.com/cps441d

 Technical Information TI00352C

Tophit CPS471D

- Sterilizable and autoclavable ISFET sensor for food and pharmaceuticals, process engineering
- Water treatment and biotechnology
- Product Configurator on the product page: www.endress.com/cps471d

 Technical Information TI00283C

Tophit CPS491D

- ISFET sensor with open aperture for media with high dirt load
- Product Configurator on the product page: www.endress.com/cps491d

 Technical Information TI00377C

14.1.5 pH and ORP combined sensors

Memosens CPS16D

- Combined pH/ORP sensor for process technology
- With dirt-repellent PTFE diaphragm
- With Memosens technology
- Product Configurator on the product page: www.endress.com/cps16D



Technical Information TI00503C

Memosens CPS76D

- Combined pH/ORP sensor for process technology
- Hygienic and sterile applications
- With Memosens technology
- Product Configurator on the product page: www.endress.com/cps76d



Technical Information TI00506C

Memosens CPS96D

- Combined pH/ORP sensor for chemical processes
- With poison-resistant reference with ion trap
- With Memosens technology
- Product Configurator on the product page: www.endress.com/cps96d



Technical Information TI00507C

14.1.6 Conductivity sensors with conductive measurement of conductivity

Condumax CLS15D

- Conductive conductivity sensor
- For pure water, ultrapure water and Ex applications
- Product Configurator on the product page: www.endress.com/CLS15d



Technical Information TI00109C

Condumax CLS16D

- Hygienic, conductive conductivity sensor
- For pure water, ultrapure water and Ex applications
- With EHEDG and 3A approval
- Product Configurator on the product page: www.endress.com/CLS16d



Technical Information TI00227C

Condumax CLS21D

- Two-electrode sensor in plug-in head version version
- Product Configurator on the product page: www.endress.com/CLS21d



Technical Information TI00085C

Memosens CLS82D

- Four-electrode sensor
- With Memosens technology
- Product Configurator on the product page: www.endress.com/cls82d



Technical Information TI01188C

14.1.7 Oxygen sensors

Oxymax COS22D

- Sterilizable sensor for dissolved oxygen
- With Memosens technology or as an analog sensor
- Product Configurator on the product page: www.endress.com/cos22d

 Technical Information TI00446C

Oxymax COS51D

- Amperometric sensor for dissolved oxygen
- With Memosens technology
- Product Configurator on the product page: www.endress.com/cos51d

 Technical Information TI00413C

Memosens COS81D

- Sterilizable, optical sensor for dissolved oxygen
- With Memosens technology
- Product Configurator on the product page: www.endress.com/cos81d

 Technical Information TI01201C

14.2 Software

Memobase Plus CYZ71D

- PC software to support laboratory calibration
- Visualization and documentation of sensor management
- Sensor calibrations stored in database
- Product Configurator on the product page: www.endress.com/cyz71d

 Technical Information TI00502C

14.3 Other accessories

14.3.1 Activation codes

 You must quote the serial number of the device when ordering the activation code.

Activation code: Bluetooth

Order No. 71401176

14.3.2 Cable junction with Velcro strip

Cable junction with Velcro strip

- 4 pieces, for sensor cable
- Order No. 71092051

14.3.3 Communication-specific accessories

Commubox FXA195

Intrinsically safe HART communication with FieldCare via the USB port

 Technical Information TI00404F

Wireless HART adapter SWA70

- Wireless device connection
- Easily integrated, offers data protection and transmission safety, can be operated in parallel with other wireless networks, minimum cabling complexity



Technical Information TI00061S

14.3.4 System components**RIA15**

- Process display unit, Digital display unit for integration into 4-20 mA circuits
- Panel mounting
- With optional HART communication



Technical Information TI01043K

15 Technical data

15.1 Input

Measured variables	<ul style="list-style-type: none"> ■ pH ■ ORP ■ pH/ORP ■ Oxygen ■ Conductivity
--------------------	---

Measuring ranges	→ Documentation of the connected sensor
------------------	---

Types of input	Digital sensor inputs for Memosens-sensors
----------------	--

Cable specification	Cable length: <ul style="list-style-type: none"> ■ Max. 3 m (10 ft) ■ Max. 7 m (23 ft) ■ Max. 15 m (49 ft)
---------------------	--

15.2 Output

Output signal	4 ... 20 mA/HART, galvanically isolated from the sensor circuits
---------------	--

Linearization/transmission behavior	Linear
-------------------------------------	--------

15.3 Power supply

Supply voltage	12.6 to 30 VDC (with setting error current > 20 mA) 14 to 30 VDC (with setting error current < 4 mA)
----------------	---

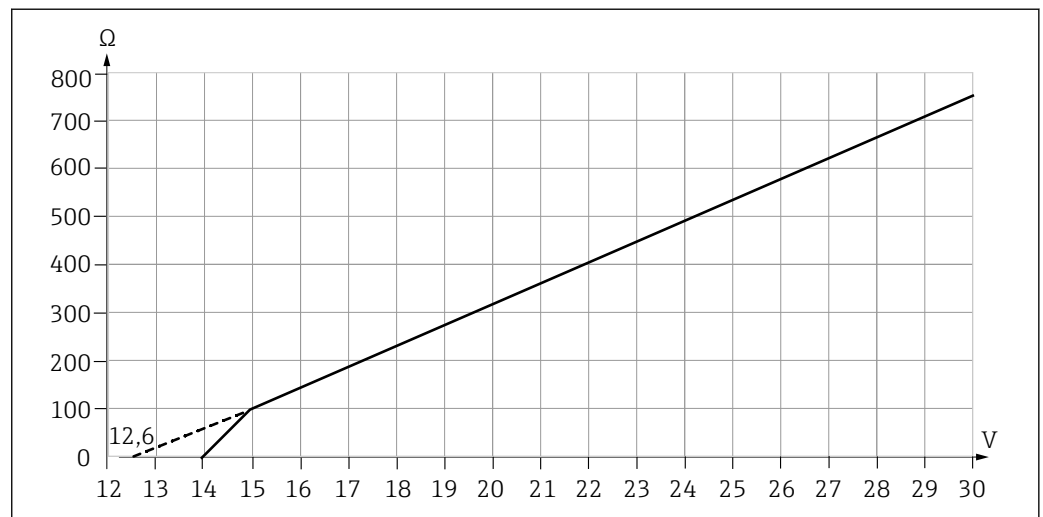

15 Supply voltage and load

A0036752

The lower voltage value in each case applies only to a load resistance of 0 Ohm.

NOTICE

The device does not have a power switch

- ▶ At the supply point, the power supply must be isolated from dangerous live cables by double or reinforced insulation in the case of devices with a 24 V power supply.

Overvoltage protection IEC 61 000-4-4 and IEC 61 000-4-5 with +/- 1 kV

Sensor connection *Sensors with Memosens protocol*

Sensor types	Sensors
Digital Sensors with inductive memosens plug head	<ul style="list-style-type: none"> ▪ pH sensors ▪ ORP sensors ▪ pH/ORP combination sensors ▪ Oxygen sensors ▪ Conductivity sensors

15.4 Performance characteristics

Response time of current output t_{90} = max. 500 ms for an increase from 0 to 20 mA

Tolerance of current output
Typical measuring tolerances:
 < $\pm 20 \mu\text{A}$ (if current value = 4 mA)
 < $\pm 50 \mu\text{A}$ (for current values 4 to 20 mA)
 at 25 °C (77 °F) each
additional tolerance depending on the temperature:
 < 1.5 $\mu\text{A/K}$

Resolution of current output < 5 μA

Repeatability → Documentation of the connected sensor

15.5 Environment

Ambient temperature -20 to +85 °C (0 to 185 °F)

i The maximum ambient temperature depends on the process temperature and the installation situation of the transmitter.

Make sure that the ambient temperature at the transmitter does not exceed +85 °C (185 °F).

Example of environmental conditions in Endress+Hauser fittings:

- with open installation (without protective cover, i.e. free convection at the transmitter), e.g. CPA442, CPA842
- for enclosed installation (with protective cover), e.g. CPA871, CPA875, CPA842

T_{ambient} = max. 60 °C (140 °F)

T_{prozess} = max. 100 °C (212 °F), in continuous operation

$T_{\text{prozess}} = \text{max. } 140\text{ }^{\circ}\text{C (284 }^{\circ}\text{F), } < 2\text{h (for sterilization)}$

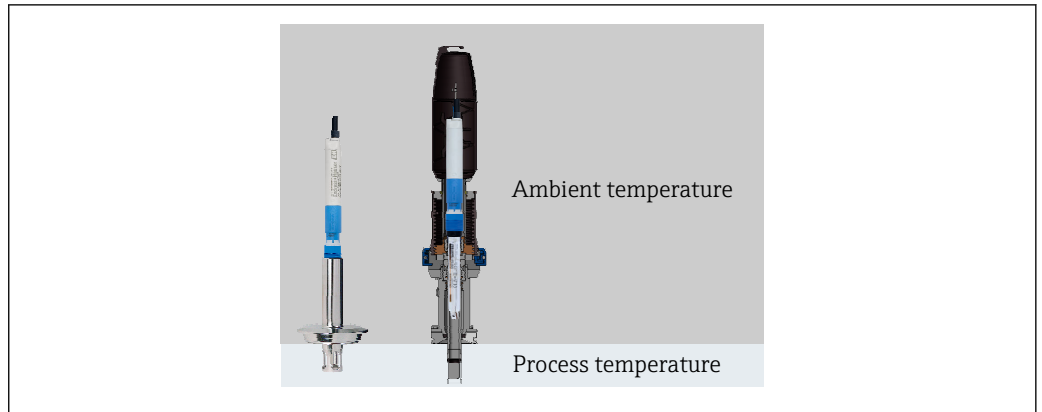

A0036933-EN

16 Mounting situation of the transmitter with or without protective cover

Storage temperature -40 to +85 °C (-40 to 185 °F)

Humidity 5 to 95 %

Degree of protection IP 67
IP 68
NEMA Type 6

Electromagnetic compatibility

- EN 61326-1
- EN 61326-2-3
- EN 301489-1
- EN 301489-17
- NAMUR NE 21

Electrical safety EN 61010-1

Max. altitude above MSL < 2000 m (< 6562 ft) above MSL

Degree of contamination	Complete device:	Pollution level 4
	Internal:	Pollution level 2

Radio standards

- EN 300 328 (Europa)
- 47 CFR 15.247 (USA)
- RSS-247 Issue 1 (Kanada)
- RSS-GEN Issue 4 (Kanada)

15.6 Mechanical construction

Materials	Components	Material
	Housing, cover	Peek 151
	Strain relief	EPDM (peroxide crosslinked)

Components	Material
Axial ring	Peek 450 G
Optical waveguide	PC transparent

Impact loads

The product is designed for mechanical impact loads of 1 J (IK06) as per the requirements of EN61010-1.

Weight		
	without cable	Approx. 42 g (1.5 oz)
	3 m (9 f) cable	Approx. 190 g (7 oz)
	7 m (23 f) cable	Approx. 380 g (13 oz)
	15 m (49 f) cable	Approx. 760 g (27 oz)
	For every 1 m (3 f) of cable	Approx. 48 g (2 oz)

Index

A

Accessories	66
Communication-specific	69
Activation codes	66
Ambient temperature	72
Approvals	10

C

Cable specification	71
Calibration	64
Calibration settings	30
Calibrations	47
Certificates	10
Check	
Installation and function	19
Cleaning	64
Commissioning	19
Configuration	27, 28, 34
Connection	20
Electrical	13
Sensors	72
Supply voltage	71
connection with RIA15	13
Current output	32

D

Date	27
Degree of contamination	73
Degree of protection	73
Delta slope	40
Delta zero point	42
Designated use	6
Device information	63
Diagnostic list	48
Diagnostic messages	48
Diagnostics	38
Dimensions	12
Disposal	65
Documentation	5

E

Electrical connection	13
Electrical safety	73
Electromagnetic compatibility	73
Event logbook	62

F

Firmware	63
Function check	19

H

HART	18, 32
Hold	33
Humidity	73

I

Impedance	39
---------------------	----

Incoming acceptance	9
Input	
Measured variables	71
Installation	12

L

LED display	20
Limit values	43
Linearization	71

M

Maintenance	64
Maintenance tasks	64
Materials	73
Measured variables	71
Measuring parameters	8
Measuring ranges	71
Medium compensation	36

N

Nameplate	9
---------------------	---

O

Occupational safety	6
Operating hours	43
Operating language	27
Operating menu	15
Operation	15, 35
Operation Point	41
Operational safety	6
Output signal	71
Overvoltage protection	72

P

Password	34
Pharmaceutical water	46
Post-connection check	14
Post-installation check	19
Power supply	71
Overvoltage protection	72
Sensor connection	72
Supply voltage	71
Process monitoring	45
Product description	8
Product design	8
Product identification	9

R

Radio standards	73
Repair	65
Requirements for personnel	6
Reset	62
Return	65
RIA15	22
RIA15 operating matrix	22

S

Safety	
Occupational safety	6
Operation	6
Safety instructions	6
SCC	45
Scope of delivery	10
Sensor	
Connection	72
Sensor condition check	45
Sensor Condition Check	45
Sensors	66
Simulation	47
Slope	40
Software	66
Squawk	63
Sterilizations	44
Storage temperature	73
Supply voltage	71
Symbols	4
System integration	18
System settings	20

T

Technical data	71
Environment	72
Input	71
Mechanical construction	73
Output	71
Technical personnel	6
Time	27
Transmission behavior	71
Troubleshooting	38
Types of input	71

U

Use	
Designated	6

W

Warnings	4
--------------------	---

Z

Zero point	41
----------------------	----

www.addresses.endress.com
