

## Data visibility for better machine performance

The Zen IoT G3 collates signals from industrial equipment for processing and publishing to the Cloud. Designed for monitoring small machines and automation systems, it enables data visibility for determining machine health or process efficiency. Industrial grade digital inputs, relay contacts and analog process input channels easily link process sensor inputs and standalone legacy automation such as PLCs, variable frequency drives and other discrete control systems to IoT cloud services.

## Direct wireless interface to field operating data

The Zen IoT G3 converts, conditions and processes analog signals directly to wireless Wi-Fi (802.11), and the built-in cloud interface sends data from your machine directly to the Cloud. A 4G cellular antenna (eMTC) LTE Cat-M1 can also be added for remote applications.

## Easily integrates with your existing automation equipment

The Zen IoT G3 natively supports MQTT Industrial IoT communications protocol. Modbus RTU master/slave communication port directly interfaces to metering and control automation. The unit's onboard logic engine allows customization tailored to specific measurement and monitoring requirements.

## Extra cloud interface security and Store and Forward data integrity

The Zen IoT G3 provides peace of mind with Transport Layer Security (TLS 1.2) protocol. In the event of a network communications failure the Zen IoT G3 Store and Forward function buffers data locally, forwarding to the cloud server once network communications are reinstated, securely monitoring and recording with total data integrity.



## Base Features

- ✓ Define Cloud Services connection
- ✓ MQTT with TLS 1.2
- ✓ Data record store and forward record buffer
- ✓ RTC record data time stamp at origin
- ✓ Application logic & math functions
- ✓ PC configuration, USB interface
- ✓ Wireless Wi-Fi (802.11)
- ✓ 2x 4–20mA inputs (non-isolated)
- ✓ 4x Digital inputs
- ✓ 3x Relay outputs
- ✓ 1x Auxiliary power output
- ✓ RS485 Modbus RTU master/slave
- ✓ Local display (RS485) interface port
- ✓ AC mains or 24V low power operation



Included by  
**DEFAULT**

+ Add-On options available - See p3

## CONTENTS

<b>Contents</b> .....	<b>2</b>	<b>7 - Wiring</b> .....	<b>25</b>
<b>Order Codes</b> .....	<b>3</b>	7.1 - Wiring Overview .....	25
<b>Safety Notices</b> .....	<b>4</b>	7.2 - Connectors .....	26
Symbol Definitions .....	4	7.3 - Relay Outputs .....	27
<b>1 - Cloud Connection</b> .....	<b>5</b>	7.4 - Auxiliary Power Output (Relay D) .....	27
1.1 - Define Cloud Services (DCS) data plans .....	6	7.5 - RS485 Serial Port .....	27
<b>2 - Wi-Fi Operating Modes</b> .....	<b>7</b>	7.6 - Process Analog Inputs (Non-isolated) .....	28
<b>3 - Specifications</b> .....	<b>7</b>	7.7 - RS485 Display Port .....	28
3.1 - Base Unit Specifications .....	7	7.8 - Digital & Logic Input .....	29
3.2 - Expansion Options .....	10	7.9 - Power Supply .....	30
<b>4 - Dimensions &amp; Front Panel</b> .....	<b>11</b>	7.10 - Analog Outputs .....	30
4.1 - Dimensions (Base Unit) .....	11	7.11 - Digital I/O Expansion .....	31
4.2 - Dimensions (Expanded Units) .....	12	<b>8 - Universal Input Specifications &amp; Wiring</b> .....	<b>32</b>
4.3 - Front Panel .....	13	8.1 - Current Input .....	32
4.4 - Power LED .....	14	8.2 - Voltage Input .....	33
4.5 - WLAN LED (Wi-Fi Status) .....	15	8.3 - RTD Input .....	35
4.6 - Mode Button .....	15	8.4 - Thermocouple Input .....	36
4.7 - Module Status LED (Modem) .....	16	8.5 - Digital Pulse .....	37
4.8 - SD Card Slot .....	16	8.6 - Potentiometer Input .....	38
<b>5 - Installation</b> .....	<b>17</b>	8.7 - AC Current Sensor .....	39
5.1 - Installation Environment .....	17	8.8 - Attenuator .....	39
5.2 - Installation Instructions .....	17	<b>9 - Zen IoT G3 Common Registers</b> .....	<b>40</b>
5.3 - EMC Installation Guidelines ..	19	<b>10 - Calibration &amp; Troubleshooting</b> .....	<b>42</b>
<b>6 - Software Setup</b> .....	<b>20</b>	10.1 - Calibration .....	42
6.1 - Installing Define WorkBench .....	20	10.2 - Troubleshooting .....	42
6.2 - Connecting to your PC .....	22	<b>A - Appendix A - EMC Test Results</b> .....	<b>43</b>
6.3 - WorkBench Interface .....	23		
6.4 - WorkBench Navigation .....	24		

## ORDER CODES

Base Configuration	Model	Power Supply
<b>Zen IoT G3 processor module base configuration:</b> MQTT cloud service interface – TLS security layer, store and forward record buffer, RTC data time stamp. Wi-Fi (802.11), RS485 display port, RS485 master port. 2x non-isolated process (4-20mA) inputs, 4x digital inputs, 3x relay outputs (2x form A, 1x form C), 1x auxiliary power output. Logs 200 samples.	ZEN-IOT-G3	
85-265V AC/DC power supply		HV
10-30V DC power supply		LV

Optional Add-Ons	Comms	Data Logging	Inputs/Outputs	Digital I/O
<b>ADD</b> Cellular modem (eMTC) LTE Cat-M1 (USA, Australia, New Zealand)	CM1			
<b>ADD</b> Ethernet ModBus TCP (Slave), HTTP, MQTT Client	ETH			
<b>ADD</b> SD Card extended data, 32GB storage		SD		
<b>ADD</b> 4x Isolated universal input			UI4	
<b>ADD</b> 8x Isolated universal input			UI8	
<b>ADD</b> 16x Isolated universal input			UI16	
<b>ADD</b> 4x Isolated universal input <b>AND</b> 4x Isolated process (4-20mA) output			UI4-AO4	
<b>ADD</b> 8x Isolated universal input <b>AND</b> 8x isolated process (4-20mA) output			UI8-AO8	
<b>ADD</b> 8x Isolated open collector outputs				DO8
<b>ADD</b> 16x Bipolar digital inputs				DI16
<b>ADD</b> 16x Isolated open collector outputs <b>AND</b> 16x Bipolar digital inputs				DO16-DI16
<b>ADD</b> 32x Isolated open collector outputs <b>AND</b> 32x Bipolar digital inputs				DO32-DI32

Required Accessories (Sold Separately)	Order Code
USB Bridge Key, required for programming	BRIDGE-KEY

## SAFETY NOTICES



For your safety and the prevention of damage to the Zen IoT G3 unit and other equipment connected to it, **please read complete instructions prior to installation and operation of the Zen IoT G3 and carefully observe all safety regulations and instructions. Consult this manual carefully in all cases where hazard symbols are marked on the Zen IoT G3 unit.**



Use of this instrument in a manner not specified by the manufacturer may compromise the protection provided by the instrument. This instrument should not be used to directly drive valves, motors, or other actuators, unless equipped with appropriate safeguards. It is the responsibility of the user to identify potential hazards that may arise in the event of a fault to unit, and implement safeguards for the prevention of harm to persons or equipment. The safety of any system incorporating this unit is the responsibility of the assembler of the system.

## Symbol Definitions



### CAUTION

**Risk of electric shock**  
Please refer to user manual.



Direct current.



### CAUTION

**Risk of danger**  
Please refer to user manual.



Both direct and alternating current.



Equipment protected throughout by **DOUBLE INSULATION** or **REINFORCED INSULATION**.

## 1

## CLOUD CONNECTION

Your Zen IoT G3 is preconfigured for **Define Cloud Services (DCS)** - our purpose-built cloud-based Industrial IoT platform.

**DCS** | Define  
Cloud  
Services

DCS allows devices and machinery to securely connect and exchange information in real-time, visualize and analyze this data, generate reports, and set alarm notifications.

The Zen IoT G3 supports a range of internet connection options:



### Wi-Fi (802.11)

Wi-Fi connection enables LOS transmission of up to 1500ft (450m) using the supplied 3dBi wireless antenna.



Included by  
**DEFAULT**



### 4G Cellular (eMTC) LTE CAT-M1

4G cellular interface developed specifically for Internet of Things (IoT) & machine-to-machine (M2M) communications.



Optional  
**ADD ON**



### Ethernet

10/100Mbps Ethernet port provides simple and robust integration to an existing wired network, or adds Internet of Things (IoT) capability to an existing ModBus PLC.



Optional  
**ADD ON**

## 1.1 - Define Cloud Services (DCS) data plans

	Base Plan	Mid Plan	High Plan	Enterprise Plan
Monthly data limit	4.2MB	25MB	46MB	250MB
Real time alarm notifications	✘	✓	✓	✓
Email alarms	✘	100/month	1000/month	2000/month
SMS alarms	✘	20/month	50/month	100/month
Cloud logging interval	10 minutes	1 minute	1 minute	1 minute
Cloud update rate	30 minutes	1 minute	1 minute	1 minute
Max logging channels	8	16	16	30
Number of dashboards/users	4	10	10	50
Data history retention	30 days	365 days	365 days	365 days
Download data from historian	✘	✓	✓	✓
<b>Order Codes</b>				
Wi-Fi or Ethernet Connection	WB*	WM	WH	WE
LTE Cat-M1 Connection	LB	LM	LH	LE

\* WB (Base plan with Wi-Fi or Ethernet connection) is currently offered free of charge.



Define Cloud Services Data Plan prices, limits and exclusions are subject to change without notice. For pricing and the latest plan info please visit:

[defineinstruments.com/dcsplans](https://defineinstruments.com/dcsplans)

## 2

## WI-FI OPERATING MODES

## Station Mode

The most common operating mode for a Wi-Fi enabled Zen IoT G3 is the **Station (or Client) Mode**. Station mode allows your device to connect to an existing network (i.e. router/access point etc.) as a client. This is the same mode your phone runs in when it connects to your home Wi-Fi, for example.

Depending on the plugin (see Section 6), it can be set up to work with a DHCP server (default setting), or to have a fixed (or Static) IP address. The user must enter the SSID and passphrase of the Wi-Fi network that it is attempting to connect to.

## Access Point Mode

Some WorkBench plugins also allow a Wi-Fi enabled Zen IoT G3 to be run as an access point that other devices can connect to, and which is totally independent of any other networks. This can be useful if there are no Wi-Fi networks available, or if they are not accessible for security reasons.

When running in **Access Point Mode**, the Zen IoT G3 will function as a DHCP server and can work with up to 5 Clients. You will be able to see the network it creates from your phone or computer, and set your own SSID, passphrase, and also which Wi-Fi channel to use.



Note that the Zen IoT G3 is capable of running Station Mode and Access Point Mode concurrently.

## 3

## SPECIFICATIONS

### 3.1 - Base Unit Specifications



Included by  
**DEFAULT**

#### General Specifications

**Power supply** 85–265V AC (HV)  
10–30V DC (LV)

**Power consumption** 10W max, 6W typical

**Excitation output** 24V DC @ 100mA max.  
Total on all excitation output pins

**Linearity & repeatability**  $<\pm 0.1\%$  FSO

**RF immunity**  $<\pm 1\%$  effect FSO typical

**Noise immunity (CMRR)** 160dB tested at  
300V RMS 50Hz

**Permanent memory (E<sup>2</sup>ROM)** 100,000  
writes per input parameter

---

## Process Analog Input

---

**2x (4–20mA) process input**

---

**Input resolution** 12 bits

---

**Accuracy**  $\lt\pm 1.0\%$  FSO (unless otherwise stated in input specifications)

---

**Input isolation** Not isolated to power supply or digital inputs

---

**+** *Universal input also available as an optional add-on (see p10)*

---

## Relay Output

---

**1x Change over Form C Relay (Relay A)**  
10A 250V AC or 10A 30V DC

---

**2x Form A Relays (Relays B & C)**  
3A 250V AC or 3A 30V DC

---

## Auxiliary Power Output

---

**1x Auxiliary power output (Relay D)**  
Total excitation Output 100mA  
*Maximum total load on all excitation outputs*

---

## Digital Input

---

**4x Built-in Digital inputs**

---

**Functions** Status, up counter, up/down counter with direction, debounced counter, frequency, gated frequency

---

**Counter register output** 32 bit

---

**Frequency range** 0–10,000Hz  
(0–1,000Hz in Sleep Mode)

---

**Input types** NPN, PNP, Clean Contact, Voltage 2–30V DC

---

**Threshold** 1.65V typical

---

**Debounce counter range** 0–100Hz

---

**Isolation** Not isolated to power supply or analog inputs

---

**+** *Digital I/O add-ons available (see p10)*

---

## Data Logging

---

**200 samples** with up to 30 parameters plus time stamp per sample

---

### Real-Time Clock (RTC)

RTC time base UTC. Local time in device with automatic daylight savings adjustment

---

**+** *32GB SD add-on available (see p10)*

---

## Configuration

---

**USB programmable** Via 'PC Setup' port using Bridge Key USB programmer (sold separately)

---

**Define WorkBench** Simple configuration software. Free download at [defineinstruments.com/workbench](https://defineinstruments.com/workbench)

---

## Comms

---

**Protocols** Modbus RTU, RS485 or Define ASCII, EIA485 compliant

---

**Default comm port** RS485. Selectable baud rate 2400–230400 baud  
Format 8 bit, no parity, 1 stop bit

---

**RS485 display port** meets TIA/EIA-232-F and ITU v28 standards

---

### EIA-485 Compliant

**+** *Ethernet add-on also available (see p10)*

---

---

## Wireless Comms Interface

---

**Wi-Fi (802.11 b/g/n)** Included in all units.  
802.11n max. speed 150Mbps

---

**Wi-Fi Band 2.4GHz**  
Not compatible with 5GHz Wi-Fi networks.  
(Check your configuration as most access points can run 2.4GHz and 5GHz simultaneously.)

---

**+** *Cellular modem also available (see p10)*

---

## TLS Security Protocol

---

**Transport Layer Security (TLS) V1.2** with server certificate and X.509 client certificate authentication

---

## Over Air Updates

---

**Over The Air updates** are available for main plugins, custom macros, certificates, cloud adapter firmware updates (Wi-Fi and cellular)

---

## MQTT Interface

---

**Based on MQTT 3.1.1** with QoS 0 & 1

---

## Environmental Conditions

---

**Operating temperature**  
-4 to 149°F (-20 to 65°C)

---

**Storage temperature**  
-4 to 149°F (-20 to 65°C)

---

**Operating humidity** 5–85% RH max, non-condensing

---



---

## Construction

---

**Casing** DIN 35 rail mounting;  
Material: ABS inflammability V0 (UL94)

---

**Terminals** Phoenix type removable screw terminal connectors

---

**Dimensions (HxWxD)**  
3.98x0.91x4.72" (101x23x120mm)\*  
\*Base unit housing with no expansion modules. Excludes antenna and connectors

---

**Antenna heights**  
Wi-Fi antenna: 3.35" (85mm)  
8Dbi Cellular antenna: 6.89" (175cm)

---

**Required mounting height with antenna(s)**  
Wi-Fi antenna only: 6.69" (170mm)  
Both antennas: 7.28" (185mm)

---

## Compliance Approvals

---

**FCC Part 15 Subpart A+B Including Sections 15.107 & 15.109**  
As a Class A Unintentional Radiator when the methods as described in ANSI C63.4 - 2013 are applied

---

**EN55032: 2015 + A11: 2020**  
As a Class A Device

---

**EN 61326-1:2006** Immunity to Industrial Locations

---

**EMC: EN61326-1: 2006** Class A

---

**Safety requirements for electrical equipment for measurement control, and laboratory use:**  
EN 61010-1 General Requirements  
EN 61010-2-030 Particular Requirements for Testing and Measuring Circuits

---

**UL Listed** File Number Pending Approval

---

## 3.2 - Expansion Options



### Comms

**Order Codes:** *CM1, ETH*

**Cellular Modem (CM1)** (eMTC) LTE Cat-M1  
Regions: USA, Australia & NZ

**Ethernet (ETH)** ModBus TCP (Slave), HTTP, MQTT Client. Link Speed:10/100Mbps.  
IP Config: Static, DHCP Client, DHCP Server

### Data Logging

**Order Code:** *SD*

**SD Card** 32GB additional storage

### Isolated Universal Input

**Order Codes:** *UI4, UI8, UI16*

**Input isolation** 2,500V AC 1 minute between all input channels

**Isolation test voltage** 1000V DC for 1min (Analog input to digital input, analog input to analog input)

**Input resolution** 16 bits

**Accurate to**  $\leq \pm 0.1\%$  FSO

See Section 8 (p32) for universal input specifications and wiring.

### Isolated Analog Output

**Order Codes:** *AO4, AO8*

**Analog output type** Loop powered, isolated 4–20mA or 20–4mA DC

**Isolation** Isolated to Digital IO GND

**Isolation test voltage** 1400Vrms for 1min. Working voltage 125V DC

**Resolution** 15 bits, 16000 steps

**Loop drop** 10V max

**Linearity & repeatability** 0.1% FSO max

**Accuracy** 0.1% FSO max

### Digital I/O Expansion

**Order Codes:** *DO8, DI16, DO16-DI16, DO32-DI32*

**Digital open collector outputs** Outputs are separated into 2 isolated groups of either 4 or 8 channels. 0.5A max on each group.

### Bipolar digital inputs

24V compatible. Up to 2.5KV RMS isolation. Inputs are separated into 2 isolated groups of 8 channels.



See p3 (Order Codes) for ordering information for optional add-ons.

## 4

## DIMENSIONS &amp; FRONT PANEL

## 4.1 - Dimensions (Base Unit)

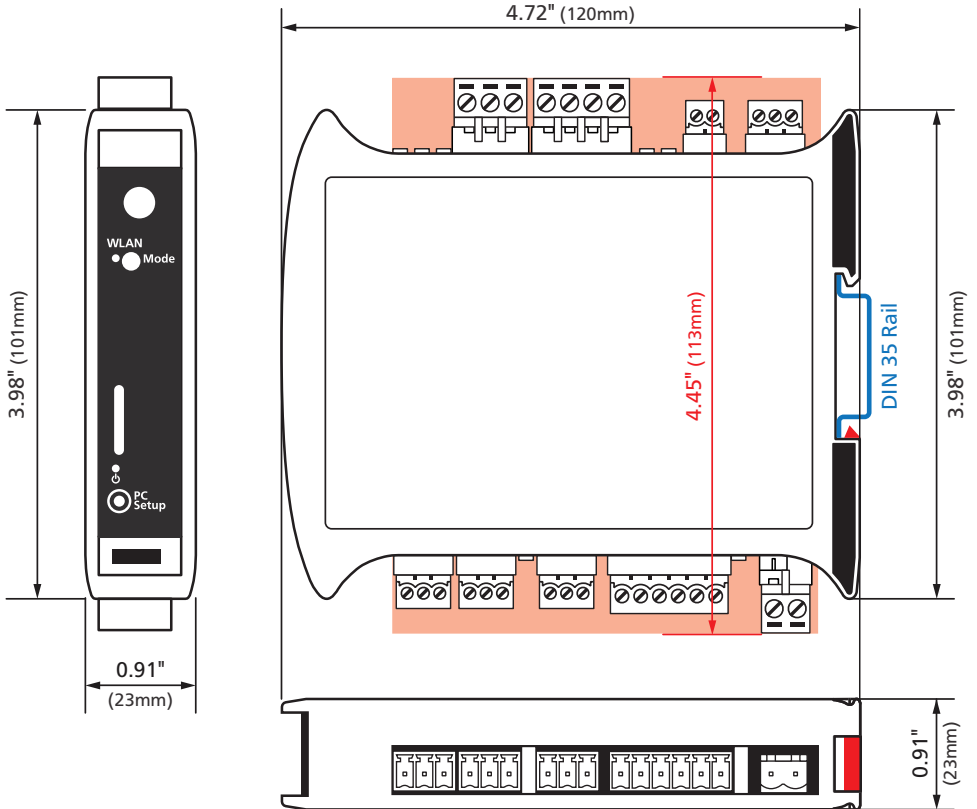
Included by  
**DEFAULT**

## 4.2 - Dimensions (Expanded Units)



The table below indicates the number of expansion units required for different order codes.



**NOTE** that the following options are all installed on the base unit and do not alter the unit dimensions:

**Power Supply (HV/LV)**  
**Cellular Modem (CM1)**  
**Ethernet (ETH) and**  
**SD Card (SD)**

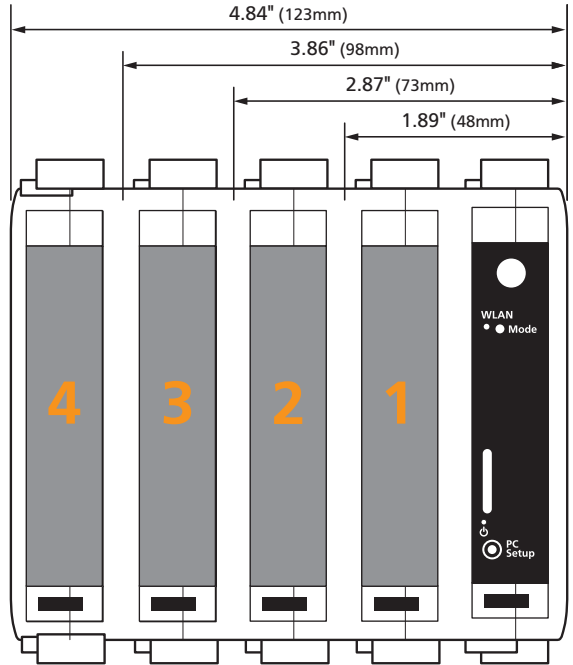



Product Code	Expansions
-UI4	1
-UI4-DO8	2
-UI4-DI16	2
-UI4-DO16-DI16	2
-UI4-DO32-DI32	3
-UI8	1
-UI8-DO8	2
-UI8-DI16	2
-UI8-DO16-DI16	2
-UI8-DO32-DI32	3
-UI16	2
-UI16-DO8	3
-UI16-DI16	3
-UI16-DO16-DI16	3
-UI16-DO32-DI32	4

Product Code	Expansions
-UI4-AO4	1
-UI4-AO4-DO8	2
-UI4-AO4-DI16	2
-UI4-AO4-DO16-DI16	2
-UI4-AO4-DO32-DI32	3
-UI8-AO8	2
-UI8-AO8-DO8	3
-UI8-AO8-DI16	3
-UI8-AO8-DO16-DI16	3
-UI8-AO8-DO32-DI32	4
-DO8	1
-DI16	1
-DO16-DI16	1
-DO32-DI32	2

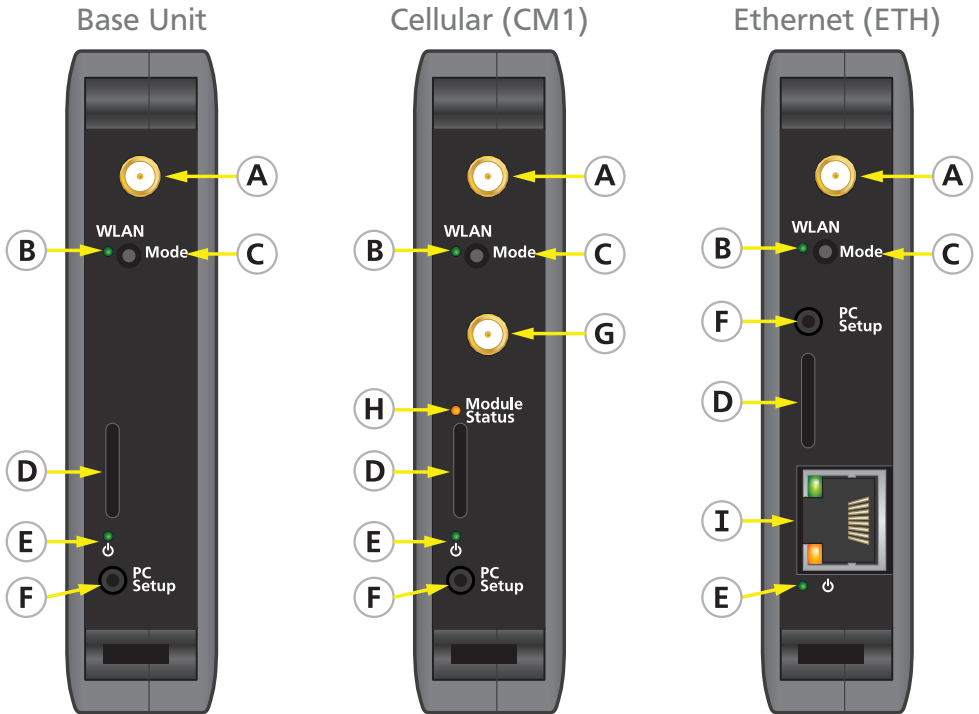
## 4.3 - Front Panel



 <b>Included by DEFAULT</b>	
<b>A</b>	Wi-Fi Antenna Port
<b>B</b>	WLAN LED (Wi-Fi Status) <span style="float: right;">See 4.5</span>
<b>C</b>	Mode Button <span style="float: right;">See 4.6</span>
<b>D</b>	SD Card Slot <span style="float: right;">See 4.8</span>
<b>E</b>	Power LED <span style="float: right;">See 4.4</span>
<b>F</b>	PC Programming Port <span style="float: right;">See 6.2</span>



 <b>Optional ADD ONS</b>	
<b>G</b>	Cellular Antenna Port
<b>H</b>	Module Status LED (Modem) <span style="float: right;">See 4.7</span>
<b>I</b>	Ethernet Port









**NOTE:** The SD Card Slot (D) is present on all models, but is only enabled for models where the *Data Logging* Add On has been purchased. See 4.8 for more information.

## 4.4 - Power LED

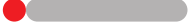
● Off | ● Green | ● Orange | ● Red

LED Pattern	Device Status
 Slow green flash	<b>Normal.</b> Device is operating normally.
 Continuously red for more than 10 seconds	<b>Critical Error.</b> A critical error is preventing the device from operating normally.
 Slow red flash	<b>Configuration Error.</b> The device can still operate, but configuration has been compromised, which may affect measurement data, alarms or control. Use <i>WorkBench</i> or <i>Define Dash</i> to get more information on the specific error number.
 Slow orange flash	<b>RTC Warning.</b> The real-time clock has lost its time setting. <i>Replace the backup battery.</i>
 Fast orange flash, followed by a pause	<b>Warning.</b> Faster orange flashes followed by a brief pause indicate a warning. <i>Count the number of flashes between pauses to determine the warning code. Warning codes can be application specific.</i>
 Very short red flash, once every 10 seconds	<b>Low Supply Voltage (LV Only).</b> A quick red flash every 10 seconds indicates that the supply voltage is insufficient for the device to run correctly. (This is for low voltage models only.)
 Very short green flash, once every 10 seconds	<b>Low Power Shutdown (LV Only).</b> A quick green flash every 10 seconds indicates that the device has entered low power shutdown mode to conserve power. It will not run any updates in this mode, but should return to normal mode after the prescribed time period. (This is for low voltage models only.)
 Changes green to orange to red and back again	<b>Boot Loader Mode.</b> Slowly changing from green to orange to red and back again indicates the device is running in boot loader mode. It may be doing a firmware update during this time. <i>Do not turn it off for several minutes to allow it to finish the update.</i>

## 4.5 - WLAN LED (Wi-Fi Status)

Station	Access Point	LED Pattern	
OFF	OFF		One short red blink, every 2 seconds
TRYING	OFF		Fast toggle between green/red, 4 times per second
OK	OFF		Slow green flash
SLEEP	OFF		Very short green flash, once every 2 seconds
OFF	ON		Slow orange flash
TRYING	ON		Fast red/green toggle interlaced with slow orange
OK	ON		Alternating green/orange slow flash

The **WLAN LED** should never stay the same color for longer than 2 seconds. Wi-Fi *Station Mode* and *Access Point Mode* can both operate at the same time in some circumstances (see *Section 2, Wi-Fi Operating Modes* for more information).



## 4.6 - Mode Button

Pressing the **Mode Button** will temporarily enable the Wi-Fi *Soft Access Point Mode* for 60 minutes. You can connect to this network from your phone or computer, and you will be directed to a setup page (or visit <http://192.168.4.1>). This setup page allows you to connect the device to your Wi-Fi network.



The **Mode Button** can also be used to perform a factory reset or a firmware point rollback. Refer to the table below for LED patterns that indicate what kind of reset is being performed.



**NOTE:** You must remove the Bridge Key cable from the device and then re-power the device while holding this button down.

Hold Time	Bridge Key	Wi-Fi LED State	Action
10–20sec	Disconnected	 Fast red flash	<b>Factory Reset.</b> Some user settings, network names, and passwords etc. are reset to default values.
20–30sec	Disconnected	 Fast green flash	<b>Firmware Rollback.</b> Attempts to find an older version of firmware and revert to it.
>30sec	Disconnected	Normal operation	<b>None.</b> Normal boot.

## 4.7 - Module Status LED (Modem)

State	LED Pattern
Connecting	 Toggle red/orange
Connected	 Flashing green
Modem Disabled	 Off (>3 seconds)

## 4.8 - SD Card Slot

An SD card provides long term storage to support the optional local storage data logging features. All SD card memory will wear with use and is considered a consumable item, but for most applications the supplied card should last the lifetime of the product.

Factors such as large channel counts, fast sample rates, and extreme temperatures can affect this to some degree. A high-endurance replacement SD card can be ordered if necessary.

The **SD Card Slot** is present on all models, but is only enabled for models where the *Data Logging Add On* has been purchased.



### WARNING!

The SD card should not be removed while the device is powered, or data corruption may occur.



**NOTE:** The memory card slot must be enabled on your device as a factory option when purchasing. Contact your service agent if you wish to upgrade a device that does not have data logging capability.

Devices that do not have data logging enabled will still be able to support basic cloud-based logging and view history using the online dashboard, but will not be able to use features that require local storage (such as long term store and forward).

## 5

## INSTALLATION

## 5.1 - Installation Environment

The Zen IoT G3 should be installed in a location that does not exceed the maximum operating temperature, and at a safe distance from other devices that generate excessive heat. The installation environment should provide good air circulation to the unit.

The plastic casing and product label may be cleaned, if required, using a soft, damp cloth and neutral soap product. **Caution should be exercised when cleaning the unit to avoid water dripping inside, as this will damage the internal circuits.**

## 5.2 - Installation Instructions

This unit is rated IP20, and should be mounted in a protective enclosure to protect the unit from weather conditions and dust. If using Wi-Fi, the unit must be located within range of a Wi-Fi network. The maximum distance is 1476ft (450m) with Line Of Sight.

### A - Plastic Enclosure (Fig 1)

Prepare the **Plastic Enclosure** (not supplied) as illustrated by mounting a **DIN 35 rail**, cable glands, and any other required components. The antenna may be mounted directly on the Zen IoT G3 (inside the **Plastic Enclosure**). A cellular modem may also be installed inside the enclosure.

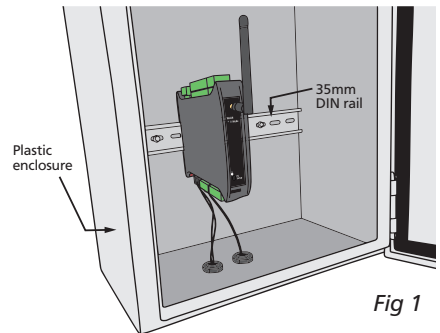

Fig 1

### B - Metal Enclosure (Fig 2)

Prepare the **Metal Enclosure** (not supplied) as illustrated by mounting a **DIN 35 rail**, cable glands, and any other required components. *This enclosure type should be earthed.*

If you are using Wi-Fi or cellular, a **Metal Enclosure** will impede your signal strength. In these cases, the antenna should be installed on the outside of the enclosure using a compatible **Antenna Extension Cable**.

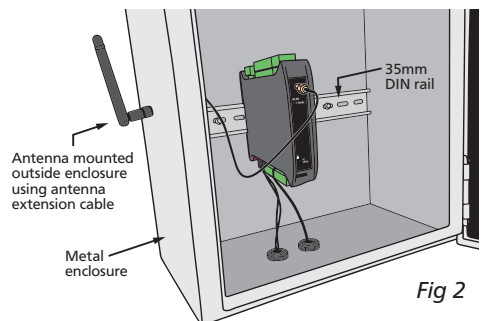

Fig 2

**N.B. Exterior mounting is only suitable for indoor/covered outdoor environments where antenna is protected from rain or wet conditions.**

### C - DIN Rail Mounting (Fig 3)

To clip the unit onto the DIN rail:

(1) Hook the upper part of the unit onto the rail, and then (2) Press down towards the rail until the red hook clicks into place.

Leave at least 0.79" (2cm) clear on either side of unit, and at least 1.97" (5cm) above and below, as space for airflow and wiring.

### D - Wiring

Refer to Sections 7–8 in this manual.

### E - Removal from DIN Rail (Fig 4)

To unclip the unit from the DIN rail, power the unit down and remove the power connector.

Then insert a small screwdriver into the slot on the red hook (just visible when the power connector is removed), and lever it down. This will release the hook, allowing the unit to be detached from the DIN rail.

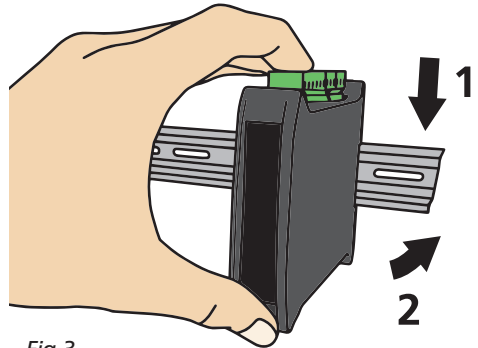

Fig 3

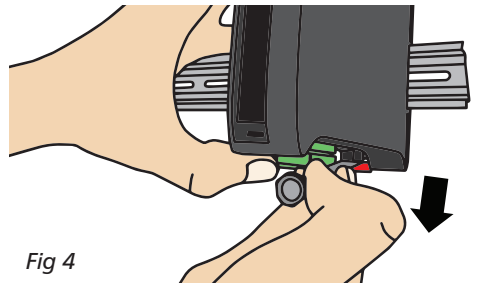

Fig 4



#### IMPORTANT

The supplied Wi-Fi and/or cellular antennas are not suitable for outdoor or wet environments.

---

## 5.3 - EMC Installation Guidelines

The Zen IoT G3 has been designed to cope with large EMC disturbances. This has been achieved by continual testing and improvement of filtering and layout techniques. The unit meets CE noise requirements, and even surpasses them in many tests. (For full details and test results, see Appendix A.)

However in some applications with less than optimum installations and large power switching, the EMC performance of the unit can be further improved by:

- A Installing the unit in an earthed **Metal Enclosure** (as in Fig 2). This is particularly useful if the control box is mounted close to large power switching devices like contactors. Every switching cycle there is a possibility of generating a large amount of near field radiated noise. The **Metal Enclosure**, acting as a faraday cage, will shunt this radiation to ground and away from the unit.
- B Increasing the physical distance from the power devices. For example, increasing the control box distance from 6" to 12" from the noise source will reduce the noise seen by the control box by a factor of 4. (Probably the cheapest and best results in this situation could be obtained by adding RC snubbers to the contactors or power switches.)
- C Using shielded cable on sensitive input and control signal lines. Good results can be obtained by grounding the shields to the metal enclosure close to the entry point. All cables act as aerials and pick up unwanted R.F. radiated signals and noise; the earthed shield acts as a faraday cage around the cables, shunting the unwanted energy to ground.
- D Shields can also help with capacitively coupled noise typically found in circumstances when signal cable is laid on top of noisy switching power cables. Of course in this case you are better off to keep separate signal and power lines.
- D Laying cable on earthed cable trays can also help reduce noise seen by the Zen IoT G3. This is particularly useful if there are long cable runs, or the unit is close to radiating sources such as two way radios.
- E Relay A's outputs have built in MOV's to help reduce EMI when switching inductive loads. EMI can further be reduced at the load by adding snubbers for AC signals or a flyback diode for DC coils.

## 6

## SOFTWARE SETUP

## 6.1 - Installing Define WorkBench

**INSTALL WORKBENCH FIRST**

You must install WorkBench before connecting the Zen IoT G3 to your computer. If you have already connected using the Bridge Key, please disconnect it before continuing.

- A** Define WorkBench offers a comprehensive and yet simple-to-use setup tool for your Zen IoT G3, complete with data log extraction and visualization. Download the latest version of WorkBench from: [www.defineinstruments.com/workbench](http://www.defineinstruments.com/workbench)
- B** Extract the install file from the zip folder. Right-click on the zip folder and choose 'Extract All', (or extract the file using another extraction utility of your choice).

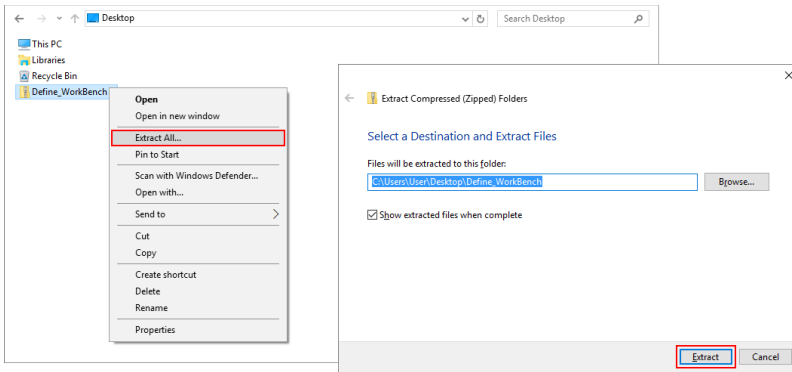

- C** Double-click on the extracted .msi install file. This will launch the WorkBench installer. Depending on your security settings, a 'Security Warning' dialog may appear. If you see the security message, click 'Run'.

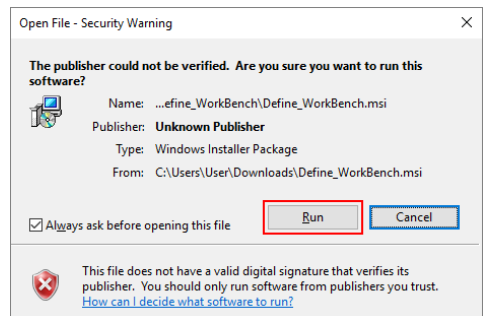

**D** The WorkBench setup wizard will launch. Click 'Next' to get started.

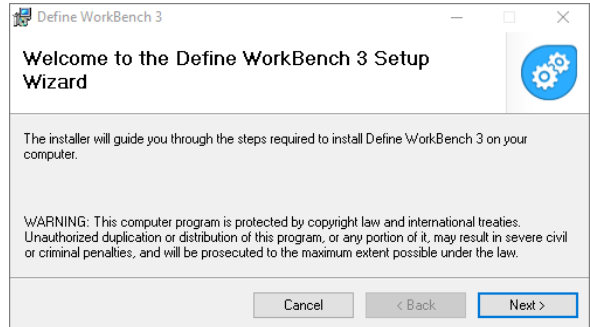

**E** The wizard will also ask for confirmation that you wish to begin the installation. Click 'Next' to continue.

**F** The wizard will then prompt you to select an installation folder.

You may accept the default installation folder, or select an alternative location by clicking 'Browse'.

Click 'Next' to continue.

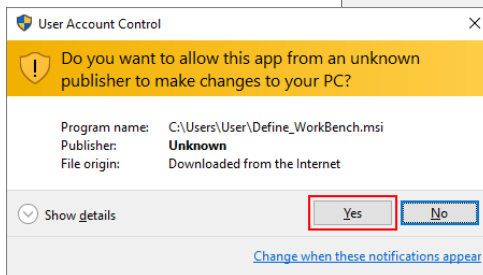
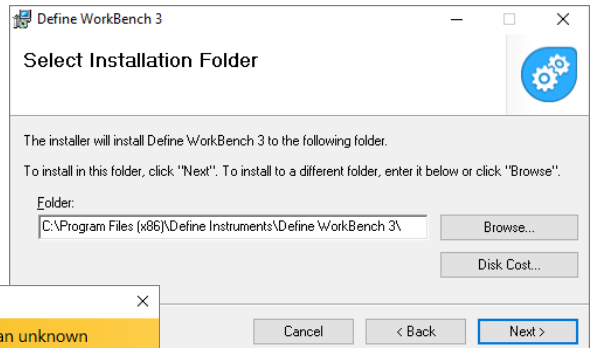

**G** Depending on your security settings, the 'User Account Control' dialog may appear.

If it does, simply click 'Yes' to allow the program to be installed on your computer.

**H** The install wizard will now install Define WorkBench. Please wait. This process usually takes 2–3 minutes, but may take longer in some situations.

**I** When the installation has successfully completed, the following dialog will appear. Click 'Close' to exit.

The installer will place an icon on your desktop for easy access to WorkBench.

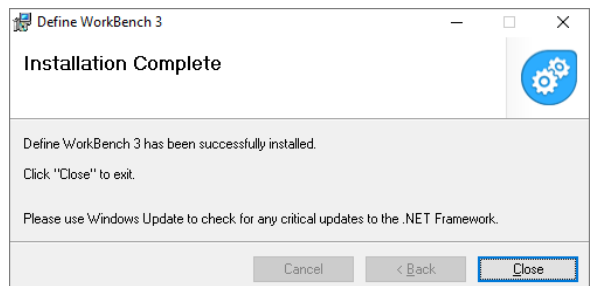

## 6.2 - Connecting to your PC



### CAUTION – RISK OF DAMAGE TO EQUIPMENT OR PC

Ensure that all connections between the Bridge Key and your Zen IoT G3 are **secure**. Connecting your unit with cables that are not firmly 'pushed in' may result in connection faults, and in extreme cases could cause damage to your computer.

**Do not unplug the Bridge Key or any connecting cables while WorkBench is busy applying changes** to the Zen IoT G3. This may cause loss of settings, or unexpected unit behaviour



### CAUTION – NOT FOR PERMANENT INSTALLATIONS

The Bridge Key is **not intended for use in permanent installations**, as it is not rated for the full range of environmental conditions the unit may be subjected to. It is intended for use at room temperature only.



**BRIDGE KEY NOT UL APPROVED** – The Bridge Key is sold separately to the Zen IoT G3, and is not UL approved.

**SERIAL DISPLAY PORT** – Some features on the **display serial port** are unavailable while the Bridge Key is inserted.

### A Connect the Bridge Key

To program your Zen IoT G3, connect one end of the **Interface Cable** to the 'PC Setup' port on the unit's front panel, and the other end to your **Bridge Key (sold separately)**. Then plug the **Bridge Key** into your computer's USB port (see Fig 5).

### B Supply Power

Supply power to the Zen IoT G3 (see Section 7.9).

### C Connect to your Zen IoT G3 in Define WorkBench

Launch Define WorkBench (see 6.1 for installation instructions), and select the 'Prog Port' tab. If your Zen IoT G3 is powered up and connected via the Bridge Key, then the COM Port will be detected automatically.

**Click the green 'Connect' button.**

Connect

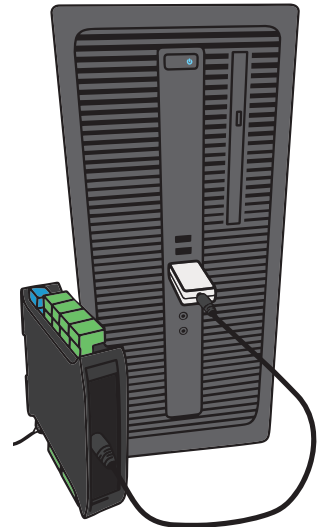

Fig 5

## 6.3 - WorkBench Interface

**Main Navigation**, including channel sub-navigation. See 6.4 for more information.

### Control Area

Main control area for configuring your system. Any changes made in this area will bring up the **Apply Button** (see below)

### Connection Panel

Disconnect button  
Connection status

The screenshot displays the Define WorkBench 3 interface. On the left is a vertical navigation menu with options: Overview, Ports, Modem, WiFi, Inputs, Digital Inputs, Totalizers, Temp Control, Relays, Alarms, Auxiliaries, Cloud Transfer, Data Viewer, and Plugins. The main content area shows the WiFi configuration settings, including a signal strength indicator (100%), status (Connected), SSID, and various setup options like Connection Mode (Station Client), IP Address (Dynamic), and Device Identification (Test Site 2). On the right, a connection panel shows 'Connected: COM4' with a 'Disconnect' button and a green checkmark. Below this, the WiFi Plugin section provides instructions on installation and requirements, followed by a Signal Bar section with a warning that at least 30% signal strength is required for all WiFi applications.

### Apply Button

Appears if you have made any changes in the **Control Area**. WorkBench will not allow you to browse to a new tab in the **Main Navigation** with unapplied changes to your configuration.

### Help Panel

Wiring diagrams, explanations and helpful tips will automatically appear in this panel as you configure the unit.

---

## 6.4 - WorkBench Navigation

### Overview

View basic device information including Serial Number and firmware version. Password protect, export a configuration certificate, and save/upload configuration settings.

### RS485

This tab is only visible if you are connected to your Zen IoT G3 via the USB Programming Port. It enables you to configure a range of settings for the default RS232 / RS485 port.

### Inputs

Set up and scale the input channels. Includes integrated wiring diagrams and examples.

### Digital Inputs

Set up the four digital inputs and view their live status.

### Totalizers

Configure up to 10 totalizers using either an input channel or a digital input as the source.

### Alarms

Configure up to 16 setpoints which can be activated by an input, a digital input or a totalizer. Configure alarms or control functions by selecting from a variety of pre-programmed modes.

### Relays

Configure the 3 relay outputs. These may be driven from one or more setpoints, or directly from one of the digital input pins.

### Cloud Transfer

Configure your data logging interval, set the time, and select which channels are sent to the Cloud.

### Data Viewer

View and analyze your live data and download it to your computer.

### Plugins

Plugins are small programs which are loaded into the Zen IoT G3 to expand its functionality or simplify its use. Available plugins for the Zen IoT G3 include:

#### Wi-Fi

Enables your Zen IoT G3 to wirelessly connect to a LAN or the internet via a local Wi-Fi network, allowing it to become a Modbus TCP server for configuration or data viewing applications, or to send regular data log updates to a variety of IoT Cloud service providers.

#### Cellular modem (*requires Cellular hardware*)

Enables your Zen IoT G3 to wirelessly connect to the internet via a cellular network, allowing it to send regular data log updates to a variety of IoT Cloud service providers.

**For full details on setup for both Wi-Fi and Cellular units see:**

[www.defineinstruments.com/videos/connecting-to-define-cloud-services-dcs](http://www.defineinstruments.com/videos/connecting-to-define-cloud-services-dcs)



## 7

## WIRING

## 7.1 - Wiring Overview

Electrical connections are made via plug in terminal blocks at the rear of the meter. All conductors must conform to the unit's voltage and current ratings, and be suitably rated for the expected temperature range to be incurred.

When wiring the unit, check all connections by comparing the terminal numbers shown on the unit label against the appropriate wiring diagrams in this manual (Sections 7 and 8), or in the Define WorkBench software.

Strip the wire, leaving around 0.25" (6mm) of bare lead exposed. If you are using stranded wire, this should be tinned with solder. Insert the lead into the correct plug

in the correct position, and tighten until the wire is secure. Verify tightness by pulling on the wire.

Follow all local codes and regulations when wiring and installing the unit. Each terminal is rated to accept one wire from #14 AWG (2.5mm) to #20 AWG. However it is also possible to accept two #18 AWG wires, or up to four #20 AWG wires.

**CAUTION**

All field wiring must rated at a minimum of 158°F (70°C).

## 7.2 - Connectors

	<b>Included by DEFAULT</b>
<b>A</b>	Relay Output A
<b>B</b>	Relay Outputs B & C
<b>C</b>	Auxiliary Power Output (Relay D)
<b>D</b>	RS485 Port
<b>E</b>	Process Analog Inputs (Non-Isolated)
<b>F</b>	RS485 Display Port
<b>G</b>	Built-in Digital Inputs
<b>H</b>	Power Supply (HV shown)

	<b>Optional ADD ONS</b>
<b>I</b> + <b>J</b>	Universal Input / Analog Output Expansion
<b>K</b>	Digital Output Expansion(s)
<b>L</b>	Digital I/O Expansion Power Supply(s)
<b>M</b>	Digital Input Expansion(s)

### Top of Unit

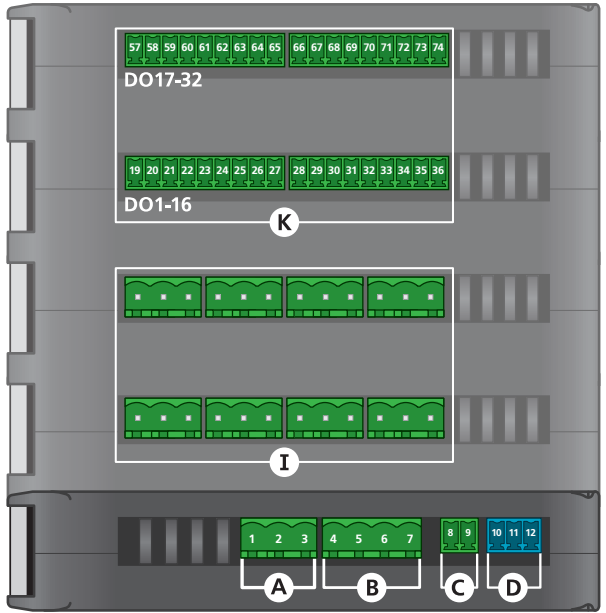

### Bottom of Unit

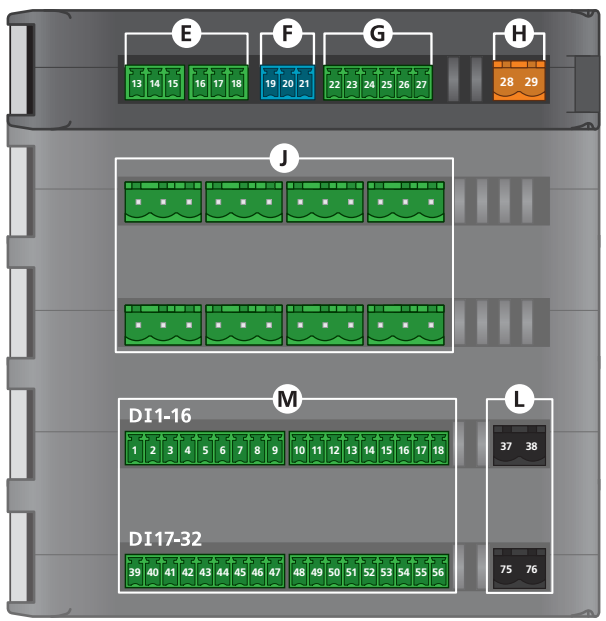

## 7.3 - Relay Outputs

See 7.2 **(A) + (B)**

Relays A (10A 250V AC or 10A 30V DC) and B & C (3A 250V AC or 3A 30V DC) should be wired as shown.

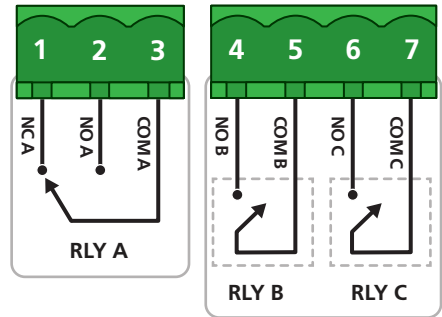

Connection example for relay outputs (A & B)

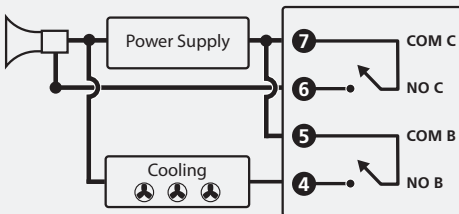

**Note 1** Example uses relays B and C.

**Note 2** 3A (Form A) relays at 250V AC

## 7.4 - Auxiliary Power Output (Relay D)

See 7.2 **(C)**

Switched DC output supply. This output can be used as excitation for low power equipment, or to drive an external relay. It is referred to as 'Relay D' in Define WorkBench.

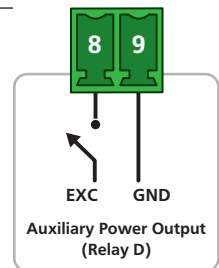

## 7.5 - RS485 Serial Port

See 7.2 **(D)**

The RS485 serial terminal can be wired for RS485 as shown. Note that there is a separate RS485 terminal for the display port (connector F).

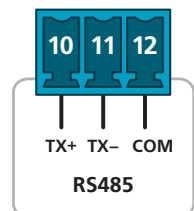

## 7.6 - Process Analog Inputs (Non-isolated)

See 7.2 (E)

The Zen IoT G3 has two non-isolated process inputs that are included with the base unit, and can be wired as shown.

**THE DEFAULT INPUT TYPE IS 4–20mA.** Alternatively you may specify 0–10V non-isolated process inputs when placing your order. *This is a factory configuration - the inputs are not capable of taking both types of signal, and cannot be user configured for a different type.*

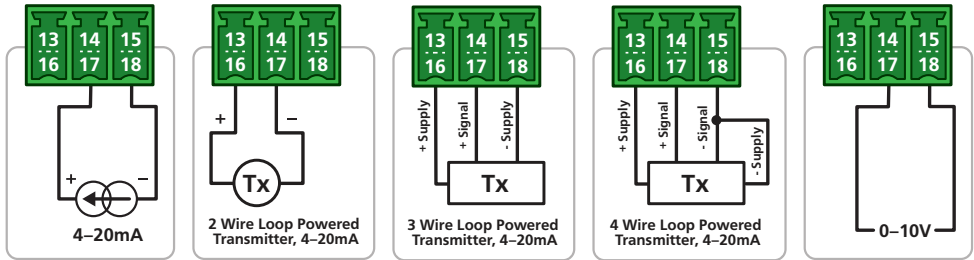
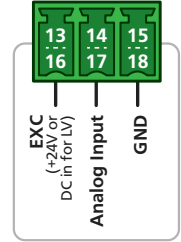

**NOTE:** This section is for the **NON-ISOLATED PROCESS** inputs which are included on the base unit. To wire the **ISOLATED UNIVERSAL** inputs, see Section 8.

## 7.7 - RS485 Display Port

See 7.2 (F)

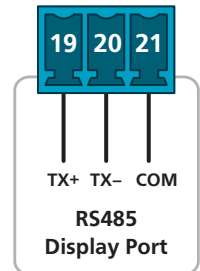

## 7.8 - Digital & Logic Input

See 7.2 **G**

The Zen IoT G3 has four Digital Inputs (A–D) which can be configured and scaled using Define WorkBench from the "**Digital Inputs**" tab, as per the list below:

- › **Status** (active/inactive - can be read by a SCADA system as a general digital input)
- › **Counter** (up to 10KHz, or 100Hz Debounced)
- › **Frequency** (up to 10KHz)
- › **Flow count** (up to 10KHz)
- › **Flow rate** (up to 10KHz)
- › **RPM** (up to 10KHz)

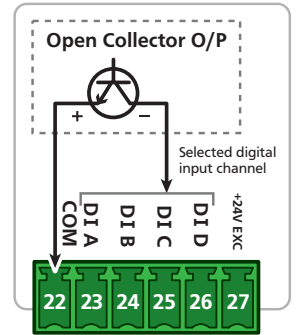
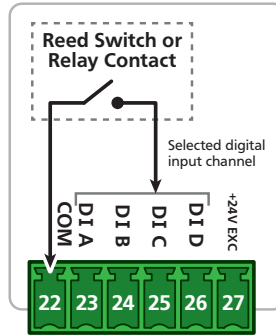
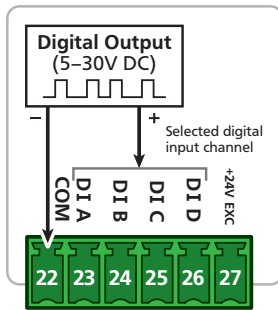
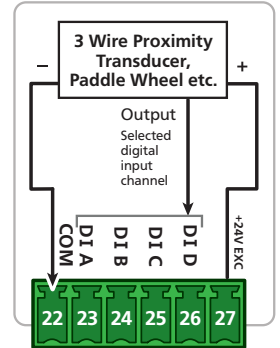

Connection example for digital inputs (A–D) using excitation from Zen IoT G3

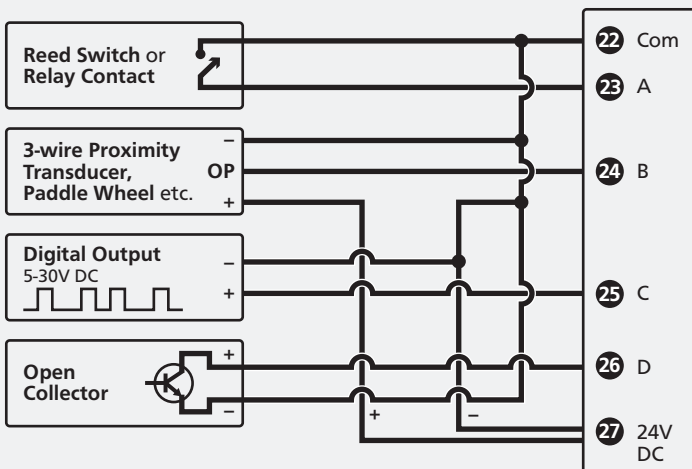

**Note 1** All cables must be screened, with screen earthed at one end only.



**NOTE:** The Digital Inputs can be configured in software to be either **Sinking (active low input)** or **Sourcing (active high input)**. The diagrams in this manual are for **Sinking** wiring, which is the default configuration. To view **Sourcing** wiring, please refer to the help information provided in Define WorkBench.

## 7.9 - Power Supply

See 7.2 (H)

Wire your power supply for 24V DC (LV model, black connector) OR 85–265V AC (HV model, orange connector).

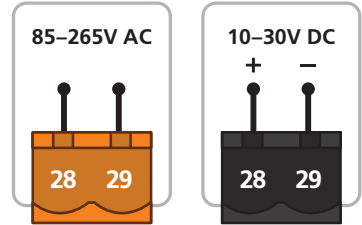

### CAUTION RISK OF ELECTRIC SHOCK!

AC power supplied to the meter must be protected by a UL approved 10A circuit breaker. DC power supplied to the meter must be protected by a UL approved 1A, 250V fuse.

## 7.10 - Analog Outputs

See 7.2 (I + J)

Analog Outputs are available as an optional add-on, and can be wired as shown, referring to the labelling on the unit.



Optional  
ADD ON



**NOTE:** To wire the **ISOLATED UNIVERSAL INPUTS** also located in connectors 7.1 I+J, see Section 8.

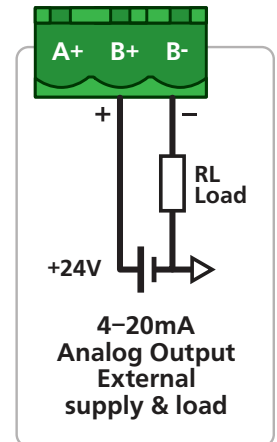

## 7.11 - Digital I/O Expansion

See 7.2 (K) + (M)

Digital I/O's are available as an optional add-on.

If installed, they can be wired as shown (right), also referring to the labelling on the unit.

## Digital I/O Power Supply

See 7.2 (L)

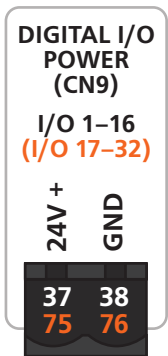

**Optional ADD ON**

### Digital Inputs: Internal Module Circuit

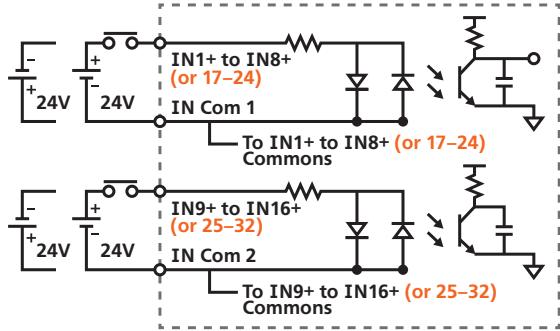

**Digital Inputs 9-16**  
OR 25-32 (CN8)



**Digital Inputs 1-8**  
OR 17-24 (CN7)

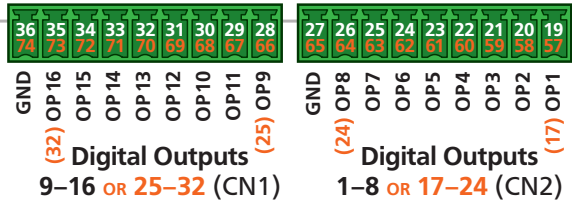
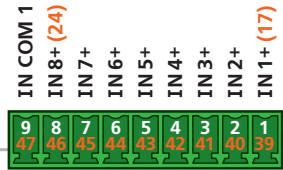

### Digital Outputs: Internal Module Circuit

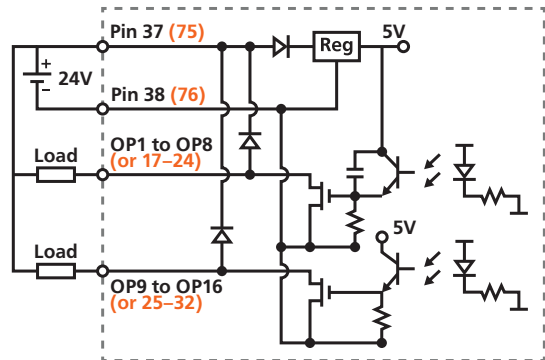

## 8

## UNIVERSAL INPUT SPECIFICATIONS &amp; WIRING

**CAUTION - RISK OF ELECTRIC SHOCK**

Dangerous and lethal voltages may be present on the input terminals. Please take appropriate precautions to ensure safety.

**CAUTION - RISK OF DANGER**

The sensor input can potentially float to dangerous and unexpected voltages depending on what external circuit it is connected to. Appropriate considerations must be given to the potential of the sensor input with respect to earth common.

## 8.1 - Current Input

Range 0–20mA, 4–20mA

Input impedance 45Ω

Maximum over-range protected by PTC to 24V DC

Accuracy 0.1% FSO max

Linearity & repeatability 0.1% FSO max

Channel separation 0.001% max

Ambient drift 0.003%/°C FSO typical

RF immunity 1% effect FSO typical

0/4–20mA DC is the most commonly used analog signal in industry, and is universally accepted. As a current loop, it is unaffected by voltage drops in cables, and can be transmitted over long distances without signal degradation.



This section is for the **ISOLATED UNIVERSAL INPUTS** which are available as an optional add-on.

To wire the **NON-ISOLATED PROCESS** inputs (included on the base unit), see Section 7.6 (p28).

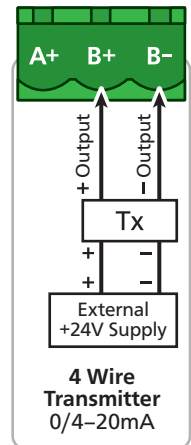
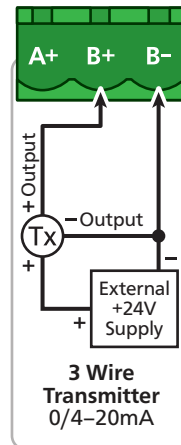
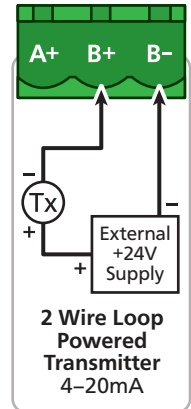
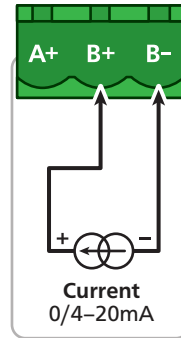

## Connection Example for 2, 3 & 4-Wire mA Output Transmitters

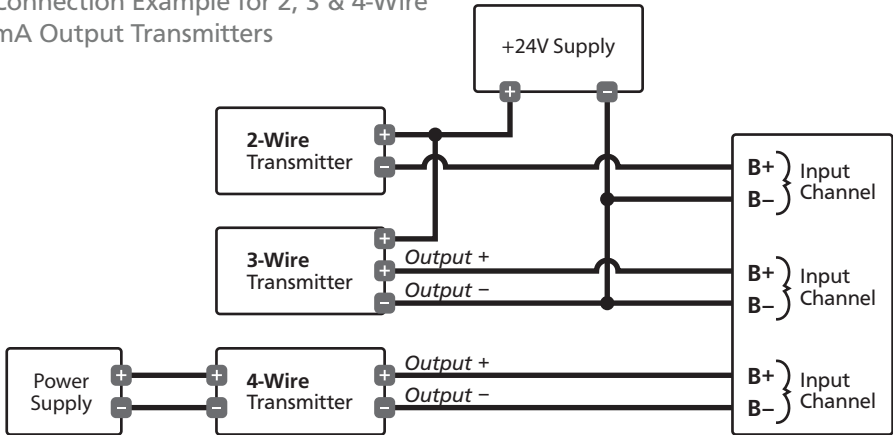

**Note 1** All analog inputs are isolated to other channels and all other voltages. They also have built in over voltage protection to 24V, protecting the unit if the 24V supply is inadvertently connected to the unit when configured for mA input.

**Note 2** All cables must be screened, with screen earthed at one end only.

**Note 3** Do not run input cables in close vicinity to noisy power supplies, contactors or motor cables. The best practice is to run input cables on a separate earthed cable tray. This will minimise RFI effects, of which magnitude cannot be easily predicted.

## 8.2 - Voltage Input

**Ranges**  $\pm 200\text{mV}$ ,  $-200\text{mV}$  to  $1\text{V}$ ,  $0-10\text{V}$ ,  $0-18\text{V}$

**Input impedance**  $>500\text{K}\Omega$  on all ranges

**Maximum over-voltage** 24V DC

**Accuracy** 0.1% FSO max

**Linearity & repeatability** 0.1% FSO max

**Channel separation** 0.001% max

**Ambient drift** 0.003%/°C FSO typical

**RF immunity** 1% effect FSO typical

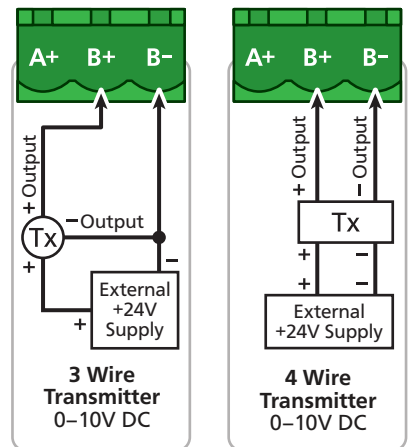

This unit accepts both voltage and millivolt inputs. Along with the standard 0–10V DC range, a variety of other ranges are provided to suit various applications.

These can all be selected using the WorkBench software and easily scaled into engineering units. The  $\pm 200\text{mV}$  DC and  $-200\text{mV}$  to  $1\text{V}$  DC ranges are ideal for low signal applications, such as measuring large DC currents using external current shunts, or interfacing to sensors with low voltage output. A 0–18V general purpose voltage range is also provided.

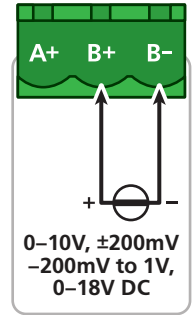

### Connection Example for 3 & 4-Wire Millivolt & Voltage Transmitters

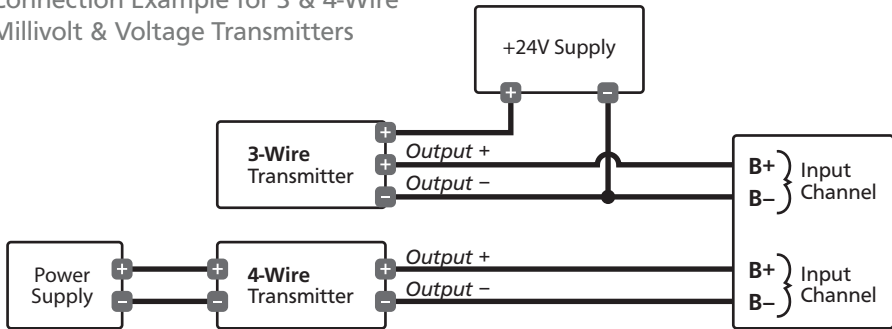

**Note 1** Each voltage input must not see more than 18V peak between the negative and the input, otherwise permanent damage may occur.

**Note 2** All cables must be screened, with screen earthed at one end only.

**Note 3** Do not run input cables in close vicinity to noisy power supplies, contactors or motor cables. The best practice is to run input cables on a separate earthed cable tray (to minimise RFI effects, of which magnitude cannot be easily predicted).

## 8.3 - RTD Input

**RTD Pt100** 3 wire RTD DIN 43760: 1980

**RTD Pt1000** 3 wire RTD standard

**Resolution**

-328–572°F (-200–300°C) = 0.02°F (0.01°C)

-328–1472°F (-200–800°C) = 0.1°F (0.1°C)

**Lead resistance** 10Ω/lead max recommended

**Sensor current** 0.6mA continuous

**Sensor fail** upscale

**Accuracy**

-328–572°F (-200–300°C) = ±0.1°C

-328–1472°F (-200–800°C) = ±0.3°C

**Ambient drift** 0.003°C/°C typical

The RTD (standing for Resistance Temperature Device) is highly stable and accurate, and is fast becoming the most popular temperature sensor in industry. Often referred to as Pt100 and Pt1000, the Pt represents platinum (the dominant metal in its construction), and 100/1000 is the resistance in ohms at 0°C.

### Supported RTD types/ranges

**Pt100/Pt1000 (0.02°F/0.01°C res)** -328 to 572°F (-200 to 300°C)

**Pt100/Pt1000 (0.1°F/0.1°C res)** -328 to 1472°F (-200 to 800°C)

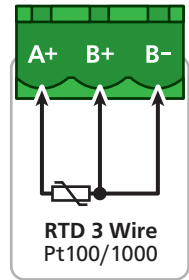

### Connection Example for 3-Wire RTD Inputs

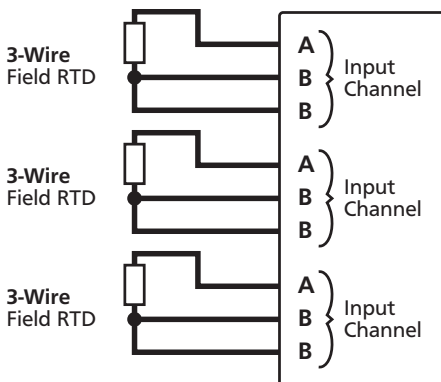

**Note 1** All RTD inputs are isolated from each other.

**Note 2** All RTD cables must be screened, with screen earthed at one end only. All three wires must be the same resistance (i.e. the same type and size).

**Note 3** To minimize lead resistance errors, 3-wire RTD's should be used. Offset errors for 2-wire RTD's may be compensated for in the software.

**Note 4** Do not run input cables in close vicinity to noisy power supplies, contactors or motor cables. The best practice is to run input cables on a separate earthed cable tray. This will minimize RFI effects, of which magnitude cannot be easily predicted.

## 8.4 - Thermocouple Input

**Thermocouple types** B, E, J, K, N, R, S or T type (see table below for ranges)

**Cold junction compensation** 14 to 140°F (-10 to 60°C)

**CJC drift** <0.02°C/°C typical for all inputs

**Sensor open Upscale**

**TC lead resistance** 100Ω max

**Input impedance** >500KΩ

**Accuracy** 0.1% of FSO ±1°C typical

The thermocouple is one of the most common temperature sensors used in industry. It relies on the Seebeck coefficient between dissimilar metals.

The thermocouple type is selected with reference to the application temperature range and environment, with J and K type being the most common.

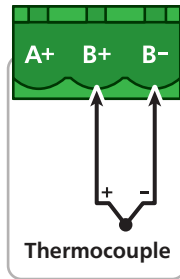

### Supported thermocouple types/ranges

<b>B</b>	32 to 3272°F	(0 to 1800°C)
<b>E</b>	-328 to 1292°F	(-200 to 700°C)
<b>J</b>	-328 to 1832°F	(-200 to 1000°C)
<b>K</b>	-328 to 2300°F	(-200 to 1260°C)
<b>N</b>	-328 to 2372°F	(-200 to 1300°C)
<b>R</b>	32 to 3092°F	(0 to 1700°C)
<b>S</b>	32 to 3092°F	(0 to 1700°C)
<b>T</b>	-328 to 752°F	(-200 to 400°C)

### Connection Example for T/C Inputs

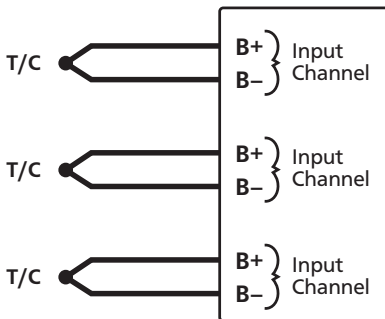

**Note 1** All thermocouple inputs are isolated from each other. There is no need to buy expensive isolated thermocouples.

**Note 2** For accurate thermocouple measurements (especially at low temperatures)

the top cover must always be fitted. Avoid drafts and temperature differences across terminals. Once installation is complete, close the cabinet door and allow the cabinet to reach equilibrium. This may take several hours. Place all thermocouple probes into a calibrated thermal bath at temperature of interest. Any offsets can be zeroed out in the software.

**Note 3** All thermocouples are referenced to a combination of four CJC temperature sensors on the main Zen board. This minimizes errors caused by the mounting orientation of the Zen unit, and temperature differences in enclosures. However, for high accuracy applications it is still recommended to zero errors (see Note 2).

**Note 4** All cables must be screened, with screen earthed at one end only.

**Note 5** When thermocouple inputs are selected, an upscale resistor is automatically connected to the T/C + input, resulting in an overflow condition for open or broken sensors.

**Note 4** Do not run input cables in close vicinity to noisy power supplies, contactors or motor cables. The best practice is to run input cables on a separate earthed cable tray. This will minimize RFI effects, of which magnitude cannot be easily predicted.

## 8.5 - Digital Pulse

(Alternate operating mode of analog universal inputs)

**Frequency range** 0–2500.0Hz

**Fast counter range** 0–2500.0Hz

**Sensors** Open collector (NPN, PNP), TTL or Clean Contact

**Frequency resolution** 0.1Hz

**Debounce counter range** 0–50Hz max

**Counter register output** 32 bit

**Accuracy**  $\pm 0.5\%$

This unit's universal input terminals accept digital inputs from NPN, PNP or TTL sensors as well as Clean Contacts. Pulses up to 2.5kHz can be counted (except for the debounced counter, which has a range of 0–50Hz).

A variety of operating modes are software programmable to suit your application.

Software programmable modes include:

- > General counter
- > General debounced counter (ideal for mechanical relay contacts which are subject to bouncing)
- > General frequency
- > Flow count (uses K-factor)
- > Flow rate (uses K-factor)
- > RPM (uses pulses per revolution)

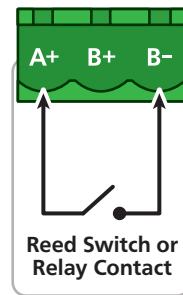
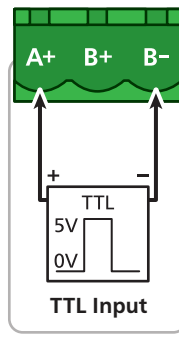
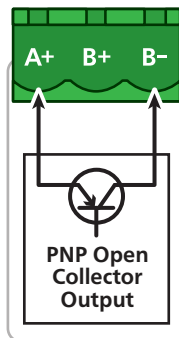
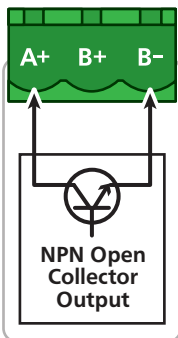

## Connection Example for Digital Pulse Inputs

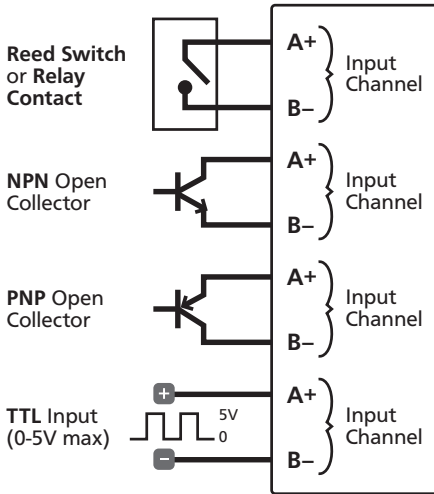

**Note 1** All digital inputs are isolated from each other. Inputs from various sources can be connected without fear of crating unwanted and troublesome ground loops.

**Note 2** Software selectable functions include: frequency to 2kHz, debounced counter for contact closures to 100Hz maximum, fast counter to 20KHz.

**Note 3** All cables must be screened, with screen earthed at one end only.

**Note 4** Do not run input cables in close vicinity to noisy power supplies, contactors or motor cables. The best practice is to run input cables on a separate earthed cable tray. This will minimize RFI effects, of which magnitude cannot be easily predicted.

## 8.6 - Potentiometer Input

**Potentiometer input 3-wire**

**Excitation voltage** Variable

**Potentiometer resistance** <2k $\Omega$  low pot;  
>2k $\Omega$  high pot

**Field prog zero** 0–90% of span

**Field prog span** 0.1–100%

**Linearity and repeatability**  
< $\pm$ 0.05% FSO typical

**Response time** 100msec

**Temperature drift** <50ppm/ $^{\circ}$ C

A 3 wire potentiometer is typically used to measure position. A low or high potentiometer range can be programmed to your unit using the WorkBench software.

These ranges must be calibrated using the two point calibration method.

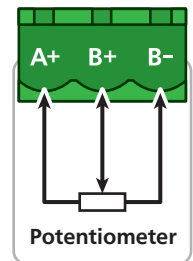

## 8.7 - AC Current Sensor

**Sensor type** Current transformer  
ACCS-420, ACCS-420-L and ACCS-010

**Header selectable amperage range**  
ACCS-420/010 = 100/150/200A  
ACCS-420-L = 10/20/50A

**Output** (Representing 0–100% of full scale input range)  
ACCS-420(-L) = 4–20mA DC loop powered  
ACCS-010 = 0–10V DC

**Power supply**

ACCS-420(-L) = Loop powered, 15–36V DC  
ACCS-010 = Self powered

**Overload (continuous)**

ACCS-420/010 = 175/300/400A respectively  
ACCS-420-L = 80/120/200A respectively

**Accuracy** 1% of full scale

**Response time** 250ms (10–90%)



**Frequency** 50–60Hz

This unit accepts input from a Define Instruments AC current sensor (sold separately). Set the jumper on the top of the current sensor to the desired current range, as shown below.

**ACCS Jump Ranges**

<b>010/420:</b>	0–100A	0–150A	0–200A
<b>420-L:</b>	0–10A	0–20A	0–50A

High ↑ ↓ Mid			
-----------------------	---	---	---

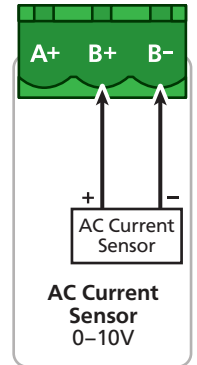
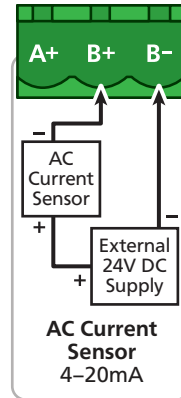

## 8.8 - Attenuator

(Sold separately – order code: HVA-1000)

**Max input voltage** 1000V DC

**Output impedance** 3.8k $\Omega$

**Attenuation factor** 1000  $\pm$ 0.1%

**Attenuator type**  
Differential resistive

**Input impedance** 3.8M $\Omega$

**Ambient drift** 50ppm/ $^{\circ}$ C max

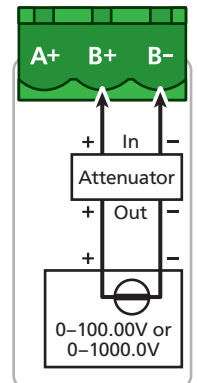

This unit accepts input from a high voltage attenuator (HVA-1000, sold separately). Wire the attenuator as shown.

## 9

## ZEN IOT G3 COMMON REGISTERS

Below is a list of the commonly used Zen IoT G3 registers, displayed first in Modicon addressing format, and then as a direct address (brackets). For a full register list, please see:

[defineinstruments.com/zen-iot-registers](https://defineinstruments.com/zen-iot-registers)

Function	32 bit signed registers	Floating point
<b>Process Analog inputs (Non-Isolated)</b>		
<b>ChA</b>	40765 (764) / 40766 (765)	42045 (2044) / 42046 (2045)
<b>ChB</b>	40767 (766) / 40768 (767)	42047 (2046) / 42048 (2047)
<b>Universal Analog inputs (Isolated)</b>		
<b>Ch1</b>	40645 (644) / 40646 (645)	41193 (1192) / 41194 (1193)
<b>Ch2</b>	40647 (646) / 40648 (647)	41195 (1194) / 41196 (1195)
<b>Ch3</b>	40649 (648) / 40650 (649)	41197 (1196) / 41198 (1197)
<b>Ch4</b>	40651 (650) / 40652 (651)	41199 (1198) / 41200 (1199)
<b>Ch5</b>	40653 (652) / 40654 (653)	41201 (1200) / 41202 (1201)
<b>Ch6</b>	40655 (654) / 40656 (655)	41203 (1202) / 41204 (1203)
<b>Ch7</b>	40657 (656) / 40658 (657)	41205 (1204) / 41206 (1205)
<b>Ch8</b>	40659 (658) / 40660 (659)	41207 (1206) / 41208 (1207)
<b>Ch9</b>	40661 (660) / 40662 (661)	41209 (1208) / 41210 (1209)
<b>Ch10</b>	40663 (662) / 40664 (663)	41211 (1210) / 41212 (1211)
<b>Ch11</b>	40665 (664) / 40666 (665)	41213 (1212) / 41214 (1213)
<b>Ch12</b>	40667 (666) / 40668 (667)	41215 (1214) / 41216 (1215)
<b>Ch13</b>	40669 (668) / 40670 (669)	41217 (1216) / 41218 (1217)
<b>Ch14</b>	40671 (670) / 40672 (671)	41219 (1218) / 41220 (1219)
<b>Ch15</b>	40673 (672) / 40674 (673)	41221 (1220) / 41222 (1221)
<b>Ch16</b>	40675 (674) / 40676 (675)	41223 (1222) / 4124 (1223)
<b>Counters</b>		
<b>CounterA</b>	40525 (524) / 40526 (525)	41805 (1804) / 41806 (1805)
<b>CounterB</b>	40527 (526) / 40526 (527)	41807 (1806) / 41808 (1807)
<b>CounterC</b>	40529 (528) / 40526 (529)	41809 (1808) / 41810 (1809)
<b>CounterD</b>	40531 (530) / 40526 (531)	41811 (1810) / 41812 (1811)

Function	32 bit signed registers	Floating point
<b>Auxiliary registers</b>		
<b>Aux1</b>	40315 (314) / 40316 (315)	41595 (1594) / 41596 (1595)
<b>Aux2</b>	40317 (316) / 40318 (317)	41597 (1596) / 41598 (1597)
<b>Aux3</b>	40319 (318) / 40320 (319)	41599 (1598) / 41600 (1599)
<b>Aux4</b>	40321 (320) / 40322 (321)	41601 (1600) / 41602 (1601)
<b>Aux5</b>	40323 (322) / 40324 (323)	41603 (1602) / 41604 (1603)
<b>Aux6</b>	40325 (324) / 40326 (325)	41605 (1604) / 41606 (1605)
<b>Aux7</b>	40327 (326) / 40328 (327)	41607 (1606) / 41608 (1607)
<b>Aux8</b>	40329 (328) / 40330 (329)	41609 (1608) / 41610 (1609)
<b>Aux9</b>	40331 (330) / 40332 (331)	41611 (1610) / 41612 (1611)
<b>Aux10</b>	40333 (332) / 40334 (333)	41613 (1612) / 41614 (1613)
<b>Aux11</b>	40335 (334) / 40336 (335)	41615 (1614) / 41616 (1615)
<b>Aux12</b>	40337 (336) / 40338 (337)	41617 (1616) / 41618 (1617)
<b>Aux13</b>	40339 (338) / 40340 (340)	41619 (1618) / 41620 (1619)
<b>Aux14</b>	40341 (341) / 40342 (341)	41621 (1620) / 41622 (1621)
<b>Aux15</b>	40343 (342) / 40344 (343)	41623 (1622) / 41624 (1623)
<b>Aux16</b>	40345 (344) / 40346 (345)	41625 (1624) / 41626 (1625)
<b>Totalizers</b>		
<b>Total1</b>	40289 (288) / 40290 (289)	41569 (1569) / 41570 (1569)
<b>Total2</b>	40291 (290) / 40292 (291)	41571 (1570) / 41572 (1571)
<b>Total3</b>	40293 (292) / 40294 (293)	41573 (1572) / 41574 (1573)
<b>Total4</b>	40295 (294) / 40296 (295)	41575 (1574) / 41576 (1575)
<b>Total5</b>	40297 (296) / 40298 (297)	41577 (1576) / 41578 (1577)
<b>Total6</b>	40299 (298) / 40300 (299)	41579 (1578) / 41580 (1579)
<b>Total7</b>	40301 (300) / 40302 (301)	41581 (1580) / 41582 (1581)
<b>Total8</b>	40303 (302) / 40304 (303)	41583 (1582) / 41584 (1583)
<b>Total9</b>	40305 (304) / 40306 (305)	41585 (1584) / 41586 (1585)
<b>Total10</b>	40307 (306) / 40308 (307)	41587 (1586) / 41588 (1587)

**Note:** This unit uses a swapped word order for Modbus 32 bit values (integers and floats). It sends/receives a 32 bit value as least significant word first, followed by the most significant word.

*Integer Example:* if the integer value is 100,000 (0x000186A0), the LSW 0x86A0 will be sent first, followed by the MSW 0x0001. *Float Example:* if the float is value is 1.234 (0x3F9DF3B6), the LSW 0xF3B6 will be sent first, followed by the MSW 0x3F9D.

## 10.1 - Calibration

Your Zen IoT G3 has been fully calibrated at the factory, and can be recalibrated in software using Define WorkBench (see Section 6). Scaling to convert the input signal to a desired display value is also done using WorkBench

If your unit appears to be behaving incorrectly or inaccurately, refer to troubleshooting before attempting to calibrate it. When recalibration is required (generally every 2 years), it should only be performed by qualified technicians using appropriate equipment. Calibration does not change any user programmed parameters. However, it may affect the accuracy of the input signal values previously stored.

## 10.2 - Troubleshooting

The table below shows a brief list of common problems and how to resolve them. Any error detected by the unit will be displayed on the front panel LED's - see Section 4 for more information.

Issue	Resolution
<b>Power LED flashes orange every 2-3 seconds continuously AND data log samples have inaccurate time/date</b>	The most likely cause of this error is the long-life battery for the real-time clock backup needs to be replaced. Contact our service center for further instruction.
<b>Power LED stays red continuously</b>	If the power LED stays red continuously this indicates an internal error which will need to be assessed by the manufacturer. Please return the unit to the manufacturer for analysis and repair.
<b>Cannot power up unit</b>	Check the power supply connections and supply range.
<b>Power LED flashes orange multiple times followed by a 2-3 second pause</b>	The unit has encountered a non-critical error. Count the number of orange flashes between the pauses and contact our service center for further instruction. (Note: the meaning of this condition may change with custom applications so be sure to mention if you are running a custom application)
<b>Power LED is mostly off but flashes a short red pulse every 3 seconds</b>	The unit does not have enough power supplied for it to run correctly. Check that the power supply voltage meets the requirements shown in section 7.9 of this manual.

## A

## APPENDIX A - EMC TEST RESULTS

## Statement of Compliance

Products in the Define Instruments 'Zen' series (incl. the Zen IoT G3) comply with EN 61326-1:2006.

## Results Summary

The results from testing carried out in March 2014 are summarized in the following tables.

### Immunity - Enclosure Ports

Phenomenon	Basic Standard	Test Value	Performance Criteria
<b>EM Field</b>	IEC 61000-4-3	10V/m (80MHz to 1GHz) 3V/m (1.4–2.7GHz)	Meets Criterion A
<b>Electrostatic Discharge (ESD)</b>	IEC 61000-4-2	4kV/8kV contact/air	Meets Criterion A (Note 1) Meets NAMUR NE 21 recommendation

### Immunity - Signal Ports

Phenomenon	Basic Standard	Test Value	Performance Criteria
<b>Conducted RF</b>	IEC 61000-4-6	3V (150kHz to 80MHz)	Meets Criterion A
<b>Burst</b>	IEC 61000-4-4	1kV (5/50ns, 5kHz) 1kV (5/50ns, 100kHz)	Meets Criterion A (Note 1) Meets NAMUR NE 21 recommendation
<b>Surge</b>	IEC 61000-4-5	1kV L-E	Meets Criterion A (Note 1)

### Immunity - AC Power

Phenomenon	Basic Standard	Test Value	Performance Criteria
<b>Conducted RF</b>	IEC 61000-4-6	3V(150Khz to 80Mhz)	Meets Criterion A
<b>Burst</b>	IEC 61000-4-4	2kV (5/50ns, 5kHz) L-N 1kV (5/50ns, 5kHz) L-L	Meets Criterion A Meets Criterion A
<b>Surge</b>	IEC 61000-4-5	2kV L-E 1KV L-L	Meets Criterion A Meets Criterion A (Note 1)
<b>Voltage Dips</b>	IEC 61000-4-11	0% during 1 cycle 40% during 10/12 cycles 70% during 25/30 cycles	Meets Criterion A Meets Criterion A Meets Criterion A
<b>Short Interruptions</b>	IEC 61000-4-11	0% during 250/300 cycles	Meets Criterion A (Note 1)

## **Performance Criteria**

### *Performance Criterion A*

During the test, normal performance within the specification limits.

### *Performance Criterion B*

During testing, temporary degradation, or loss of performance or function which is self-recovering.

### *Performance Criterion C*

During testing, temporary degradation, or loss of function or performance which requires operator intervention or system reset occurs.

\*Note 1: EN61326-1 calls for a Criterion B pass; unit exceeds this by meeting Criterion A.









---

## Define Instruments

### New Zealand (Head Office)

 10B Vega Place, Rosedale,  
Auckland 0632, New Zealand  
PO Box 245 Westpark Village,  
Auckland 0661, New Zealand

**Ph:** +64 (9) 835 1550

**Fax:** +64 (9) 835 1250

 [sales@defineinstruments.com](mailto:sales@defineinstruments.com)

[www.defineinstruments.com](http://www.defineinstruments.com)