



Level



Pressure



Flow



Temperature



Liquid
Analysis



Registration



Systems
Components



Services



Solutions

Operating Instructions

Proline Prosonic Flow 92F HART

Ultrasonic Flow Measuring System

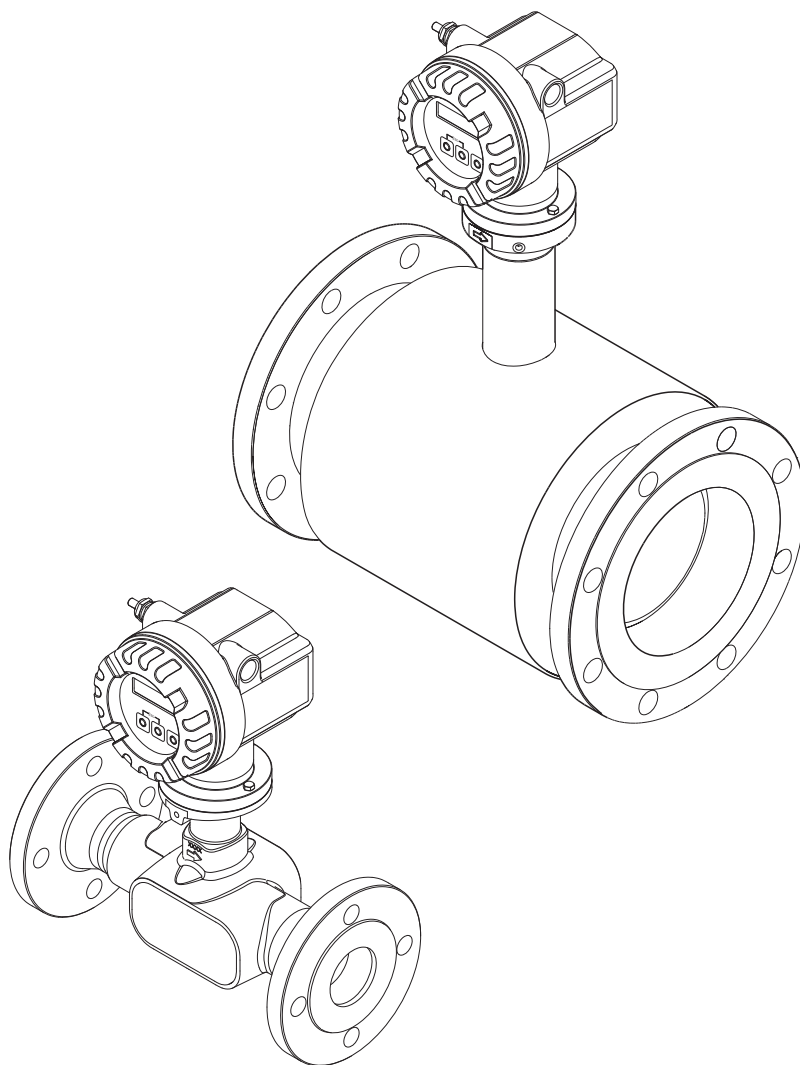

BA00121D/06/EN/13.10
71124139

Valid as of version
V1.01.XX (device software)

Endress+Hauser

People for Process Automation

Table of contents

1	Safety instructions	5	5.3.1	Operating options	27
1.1	Designated use	5	5.3.2	Current device description files	28
1.2	Installation, commissioning and operation	5	5.3.3	Device variables and process variables	29
1.3	Operational safety	5	5.3.4	Universal/common practice HART commands	30
1.4	Return	6	5.3.5	Device status/diagnosis code messages	35
1.5	Notes on safety conventions and icons	6	5.3.6	Switching HART write protection on/off	37
2	Identification	7	6	Commissioning	38
2.1	Device designation	7	6.1	Function check	38
2.1.1	Nameplate of the transmitter	7	6.2	Switching on the measuring device	38
2.1.2	Nameplate of the sensor	8	6.3	Quick Setup	39
2.1.3	Nameplate for connections	8	6.3.1	"Commissioning" Quick Setup	39
2.2	Certificates and approvals	9	6.3.2	Data backup with the T-DAT SAVE/LOAD function	41
2.3	Registered trademarks	9	6.4	Adjust	42
3	Installation	10	6.4.1	Zero point adjustment	42
3.1	Incoming acceptance, transport, storage	10	6.5	Data storage device (HistoROM)	43
3.1.1	Incoming acceptance	10	6.5.1	HistoROM/T-DAT (transmitter-DAT)	43
3.1.2	Transport	10	7	Maintenance	44
3.1.3	Storage	10	7.1	Exterior cleaning	44
3.2	Installation conditions	11	7.2	Cleaning with pigs	44
3.2.1	Dimensions	11	8	Accessories	45
3.2.2	Mounting location	11	8.1	Device-specific accessories	45
3.2.3	Orientation	12	8.2	Measuring principle-specific accessories	45
3.2.4	Heating	12	8.3	Communication-specific accessories	45
3.2.5	Thermal insulation	13	8.4	Service-specific accessories	46
3.2.6	Inlet and outlet run	13	9	Troubleshooting	47
3.2.7	Limiting flow	13	9.1	Troubleshooting instructions	47
3.3	Installation instructions	14	9.2	Diagnosis code messages	48
3.3.1	Mounting the sensor	14	9.2.1	Category F diagnosis code messages	48
3.3.2	Turning the transmitter housing	14	9.2.2	Category C diagnosis code messages	49
3.3.3	Turning the local display	14	9.2.3	Category S diagnosis code messages	50
3.3.4	Mounting the remote version	15	9.3	Process errors without messages	51
3.4	Post-installation check	15	9.4	Response of outputs to errors	52
4	Wiring	16	9.5	Spare parts	53
4.1	Connecting the remote version	16	9.5.1	Installing and removing electronics boards	54
4.1.1	Connecting cable for sensor/transmitter	16	9.6	Return	58
4.1.2	Cable specification for connecting cable	16	9.7	Disposal	58
4.2	Connecting the measuring unit	17	9.8	Software history	58
4.2.1	Connecting the transmitter	17	10	Technical data	59
4.2.2	Terminal assignment	19	10.1	Technical data at a glance	59
4.2.3	HART connection	20	10.1.1	Application	59
4.3	Degree of protection	21	10.1.2	Function and system design	59
4.4	Post-connection check	22	10.1.3	Input	59
5	Operation	23	10.1.4	Output	60
5.1	Display and operating elements	23	10.1.5	Power supply	62
5.2	Operation via the function matrix	24	10.1.6	Performance characteristics	62
5.2.1	General notes	25	10.1.7	Operating conditions: Installation	62
5.2.2	Enabling the programming mode	25	10.1.8	Operating conditions: Environment	63
5.2.3	Disabling the programming mode	25			
5.3	Communication	26			

10.1.9	Operating conditions: Process	64
10.1.10	Mechanical construction	64
10.1.11	Human interface	66
10.1.12	Certificates and approvals	66
10.1.13	Ordering information	67
10.1.14	Accessories	67
10.1.15	Documentation	67
11	Description of device functions	68
11.1	Illustration of the function matrix	68
11.2	Group MEASURING VALUES	70
11.3	Group SYSTEM UNITS	71
11.4	Group QUICK SETUP	75
11.5	Group OPERATION	76
11.6	Group USER INTERFACE	77
11.7	Group TOTALIZER	79
11.7.1	Function group TOTALIZER 1 (TOTALIZER 2)	79
11.7.2	Group HANDLING TOTALIZER	81
11.8	Group CURRENT OUTPUT	82
11.9	Group PULSE, FREQUENCY, STATUS	85
11.10	Information on the response of the status output	98
11.11	Group COMMUNICATION	100
11.12	Group PROCESS PARAMETER	101
11.13	Group SYSTEM PARAMETER	103
11.14	Group SENSOR DATA	104
11.15	Group SUPERVISION	106
11.16	Group SIMULATION SYSTEM	108
11.17	Group SENSOR VERSION	108
11.18	Group AMPLIFIER VERSION	108
12	Factory settings	109
12.1	Metric system units (not for USA and Canada)	109
12.1.1	Low flow cut off, fullscale value, pulse value, totalizer → Page 71	109
12.1.2	Language → Page 76	109
12.1.3	Unit totalizer 1 + 2 → 79	109
12.2	US units (only for USA and Canada)	110
12.2.1	low flow cut off, full scale value, pulse value, totalizer → 71	110
	Index	111

1 Safety instructions

1.1 Designated use

The measuring device described in these Operating Instructions is to be used only for measuring the flow rate of liquids in closed pipes, e.g.:

- Acids, alkalis, paints, oils
- Liquefied gas
- Ultrapure water with a low conductivity, water, wastewater

In addition to measuring the volume flow, the measuring device also always measures the sound velocity of the fluid. In this way, different fluids can be distinguished or the fluid quality can be monitored.

Resulting from incorrect use or from use other than that designated the operational safety of the measuring devices can be suspended. The manufacturer accepts no liability for damages being produced from this.

1.2 Installation, commissioning and operation

Note the following points:

- Installation, connection to the electricity supply, commissioning and maintenance of the device must be carried out by trained, qualified specialists authorized to perform such work by the facility's owner operator. The specialist must have read and understood these Operating Instructions and must follow the instructions they contain.
- The device must be operated by persons authorized and trained by the facility's owner-operator. Strict compliance with the instructions in these Operating Instructions is mandatory.
- In the case of special fluids (incl. fluids for cleaning), Endress+Hauser will be happy to assist in clarifying the corrosion resistance properties of wetted materials. Slight changes to the temperature, concentration or degree of contamination in the process can, however, alter the corrosion resistance. Consequently, Endress+Hauser does not accept any guarantee or liability with regard to the corrosion resistance of wetted materials in a specific application. The user is responsible for the choice of suitable wetted materials in the process.
- If carrying out welding work on the piping, the welding unit may not be grounded by means of the measuring device.
- The installer must ensure that the measuring system is correctly wired in accordance with the wiring diagrams. The transmitter must be grounded, unless the power supply is galvanically isolated.
- Invariably, local regulations governing the opening and repair of electrical devices apply.

1.3 Operational safety

- Measuring systems for use in hazardous environments are accompanied by separate "Ex documentation", which is an integral part of these Operating Instructions. Strict compliance with the installation instructions and ratings as listed in this supplementary documentation is mandatory. The symbol on the front of this supplementary Ex documentation indicates the approval and the inspection authority (Ⓔ Europe, Ⓕ USA, Ⓖ Canada).
- The measuring device complies with the general safety requirements in accordance with EN 61010, the EMC requirements of IEC/EN 61326 and NAMUR recommendations NE 21 and NE 43.
- The manufacturer reserves the right to modify technical data without prior notice. Your Endress+Hauser distributor will supply you with current information and updates to these Operating Instructions.

1.4 Return

- Do not return a measuring device if you are not absolutely certain that all traces of hazardous substances have been removed, e.g. substances which have penetrated crevices or diffused through plastic.
- Costs incurred for waste disposal and injury (burns, etc.) due to inadequate cleaning will be charged to the owner-operator.
- Please note the measures on →  58

1.5 Notes on safety conventions and icons

The devices are designed to meet state-of-the-art safety requirements, have been tested, and left the factory in a condition in which they are safe to operate. The devices comply with the applicable standards and regulations in accordance with EN 61010 "Protection Measures for Electrical Equipment for Measurement, Control, Regulation and Laboratory Procedures". The devices can, however, be a source of danger if used incorrectly or for anything other than the designated use. Consequently, always pay particular attention to the safety instructions indicated in these Operating Instructions by the following symbols:



Warning!

"Warning" indicates an action or procedure which, if not performed correctly, can result in injury or a safety hazard. Comply strictly with the instructions and proceed with care.



Caution!

"Caution" indicates an action or procedure which, if not performed correctly, can result in incorrect operation or destruction of the device. Comply strictly with the instructions.



Note!

"Note" indicates an action or procedure which, if not performed correctly, can have an indirect effect on operation or trigger an unexpected response on the part of the device.

2 Identification

2.1 Device designation

The "Prosonic Flow 92" flowmeter system consists of the following components:

- Prosonic Flow 92 transmitter
- Prosonic Flow F Inline sensor

Two versions are available:

- Compact version: transmitter and sensor form a single mechanical unit.
- Remote version: transmitter and sensor are installed separately.

2.1.1 Nameplate of the transmitter

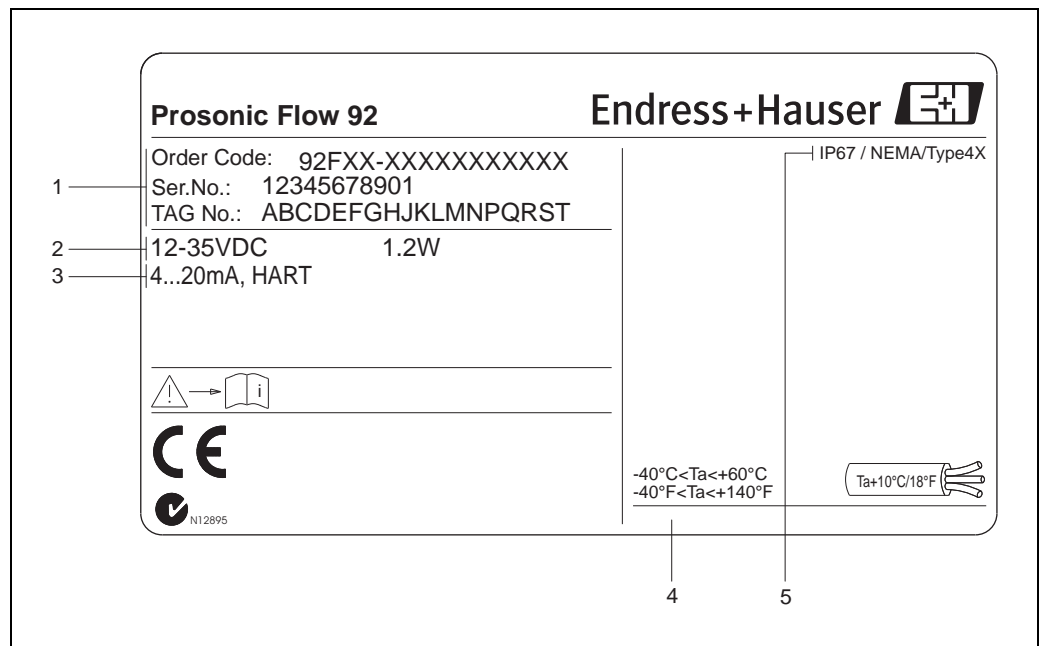

Fig. 1: Nameplate specifications for the "Prosonic Flow" transmitter (example)

- 1 Order code / serial number: See the specifications on the order confirmation for the meanings of the individual letters and digits
- 2 Power supply: 12 to 35 VDC
Power consumption: 1.2 W
- 3 Available outputs
- 4 Permitted ambient temperature range
- 5 Degree of protection

2.1.2 Nameplate of the sensor

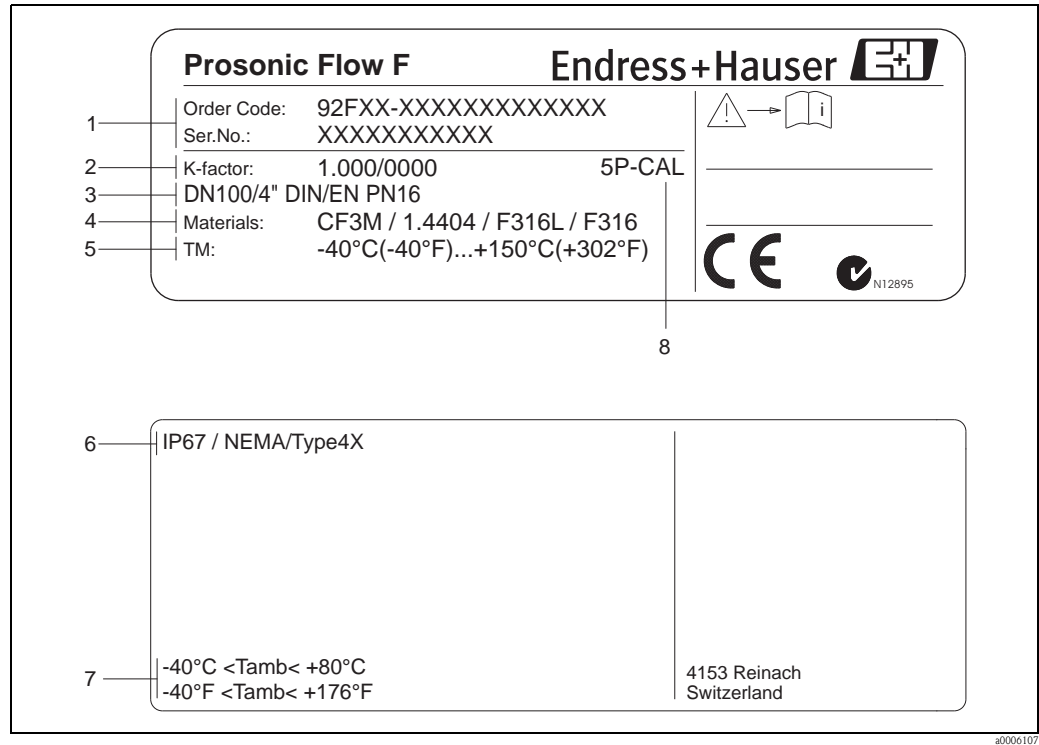

Fig. 2: Nameplate specifications for the Prosonic Flow F sensor (example)

- 1 Order code/serial number: See the specifications on the order confirmation for the meanings of the individual letters and digits
- 2 Calibration factor with zero point
- 3 Device nominal diameter/nominal pressure
- 4 Measuring tube material
- 5 Medium temperature range
- 6 Degree of protection
- 7 Permitted ambient temperature range
- 8 Additional information (examples):
 - 5P-CAL: with 5-point calibration

2.1.3 Nameplate for connections

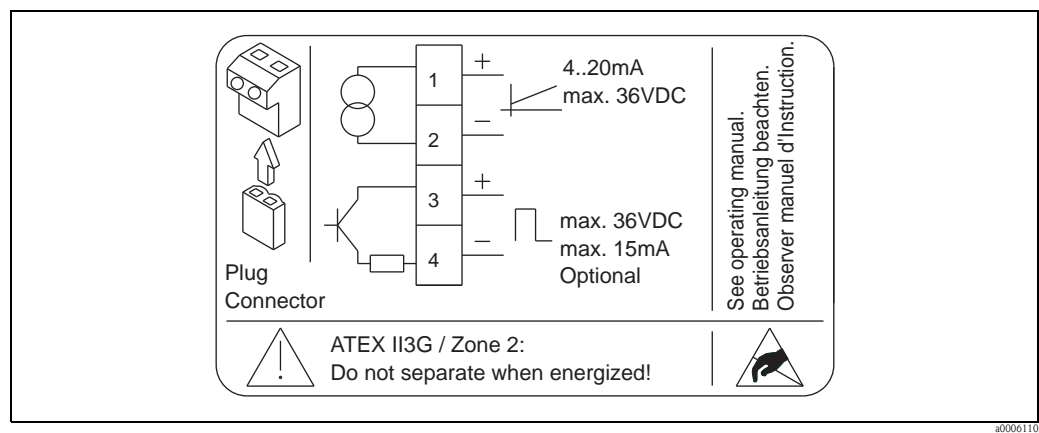

Fig. 3: Nameplate specifications for Proline transmitter (example)

2.2 Certificates and approvals

The devices are designed in accordance with good engineering practice to meet state-of-the-art safety requirements, have been tested, and left the factory in a condition in which they are safe to operate.

The measuring device complies with the general safety requirements in accordance with EN 61010, the EMC requirements of IEC/EN 61326 and NAMUR recommendations NE 21 and NE 43.

The measuring system described in these Operating Instructions thus complies with the statutory requirements of the EC Directives. Endress+Hauser confirms successful testing of the device by affixing to it the CE mark.

The measuring system complies with the EMC requirements of the Australian Communications and Media Authority (ACMA).



Note!

A detailed list of all the certificates and approvals is provided in the technical data on Page 66.

2.3 Registered trademarks

HART®

Registered trademark of the HART Communication Foundation, Austin, USA

HistoROM™ T-DAT®, FieldCare®, Fieldcheck®, FieldXpert™, Applicator®

Registered or registration-pending trademarks of Endress+Hauser Flowtec AG, Reinach, CH

3 Installation

3.1 Incoming acceptance, transport, storage

3.1.1 Incoming acceptance

On receipt of the goods, check the following points:

- Check the packaging and the contents for damage.
- Check the shipment, make sure nothing is missing and that the scope of supply matches your order.

3.1.2 Transport

Please note the following when unpacking or transporting to the measuring point:

- The devices must be transported in the container supplied.
- The covers or caps fitted to the process connections prevent mechanical damage to the sealing faces and the ingress of foreign matter to the measuring tube during transportation and storage. Consequently, do not remove these covers or caps until immediately before installation.
- Devices with nominal diameters $> DN 40$ ($> 1\frac{1}{2}$ ") may not be lifted at the transmitter housing or at the connection housing of the remote version when transporting. Use carrier slings when transporting and put the slings around both process connections. Avoid chains as these could damage the housing.



Warning!

Risk of injury if the measuring device slips. The center of gravity of the entire measuring device might be higher than the points around which the slings are slung.

Therefore, when transporting, make sure that the device does not unintentionally turn or slip.

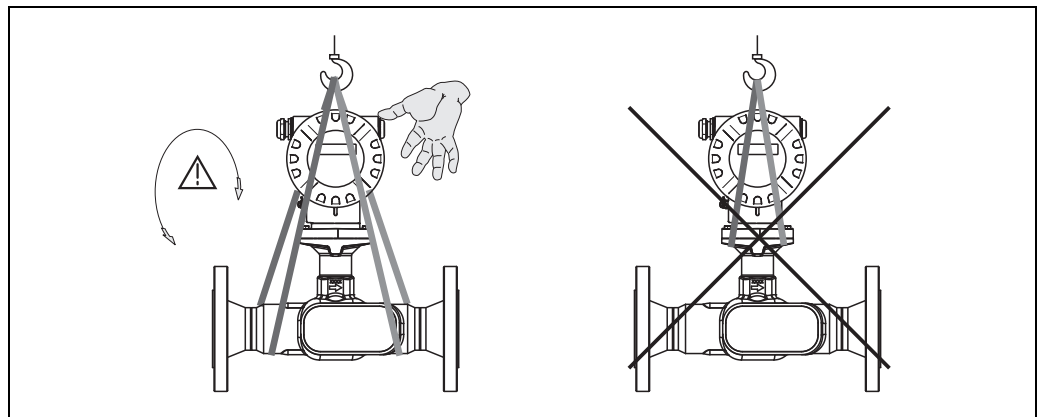

Fig. 4: Instructions for transporting sensors with a nominal diameter $> DN 40$ ($> 1\frac{1}{2}$ ")

3.1.3 Storage

Note the following points:

- Pack the measuring device in such a way as to protect it reliably against impact for storage (and transportation). The original packaging provides optimum protection.
- The permissible storage temperature is -40 to $+80$ °C (-40 °F to 176 °F), preferably $+20$ °C (68 °F).
- Do not remove the protective covers or caps on the process connections until you are ready to install the device.
- The measuring device must be protected against direct sunlight during storage in order to avoid unacceptably high surface temperatures.

3.2 Installation conditions

Note the following points:

- No special measures such as supports are necessary. External forces are absorbed by the construction of the instrument.
- The flowmeter flanges must be coplanar with connecting flanges and free from tension.
- The maximum permitted ambient temperatures (→ 63) and fluid temperatures (→ 63) must be observed.
- Pay particular attention to the notes on orientation and piping insulation on the following pages.
- The correct operation of the measuring system is not influenced by pipe vibrations.

3.2.1 Dimensions

All the dimensions and lengths of the sensor and transmitter are provided in the separate documentation "Technical Information". → 67

3.2.2 Mounting location

Accumulated gas bubbles in the measuring tube can result in measuring errors.

Avoid the following locations:

- Highest point of a pipeline. Risk of gas accumulating.
- Directly upstream of a free pipe outlet in a vertical pipeline.

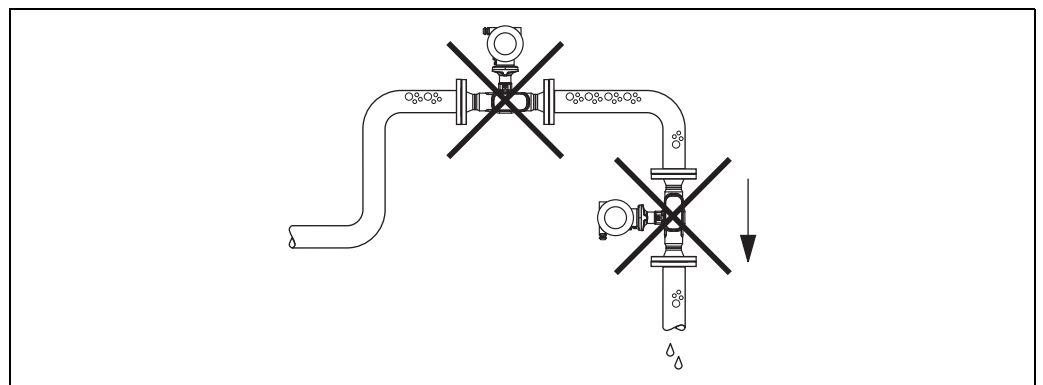

Fig. 5: Mounting location

The proposed configuration in the following diagram, however, permits installation in a vertical pipeline. Pipe restrictors or the use of an orifice plate with a smaller cross section than the nominal diameter prevent the sensor from running empty during measurement.

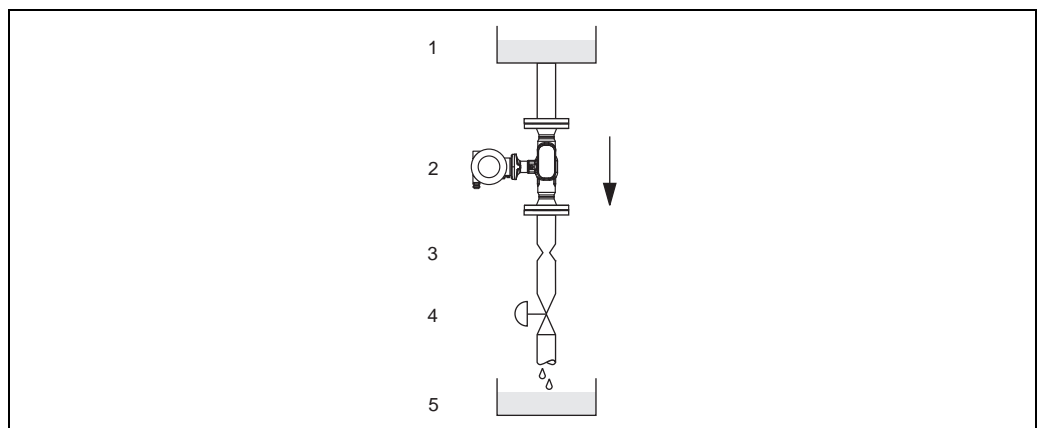

Fig. 6: Installation in a vertical pipe (e.g. for batching applications)

1 = Supply tank, 2 = Sensor, 3 = Orifice plate, pipe restriction, 4 = Valve, 5 = Batching tank

System pressure

No additional pressure loss results from installing the device. It is important to ensure that cavitation or degassing does not occur at fittings upstream from the measuring device as this can affect sound transmission in the fluid.

No special measures need to be taken for fluids which have properties similar to water under normal conditions.

In the case of liquids with a low boiling point (hydrocarbons, solvents, liquefied gases) or in suction lines, it is important to ensure that pressure does not drop below the vapor pressure and that the liquid does not start to boil. It is also important to ensure that the gases that occur naturally in many liquids do not outgas. Such effects can be prevented when system pressure is sufficiently high.

For this reason, preference should be given to the following mounting locations:

- Downstream from pumps (no danger of vacuum)
- At the lowest point in a vertical pipe

3.2.3 Orientation

Make sure that the direction of the arrow on the nameplate of the sensor matches the direction of flow (direction in which the fluid flows through the pipe).

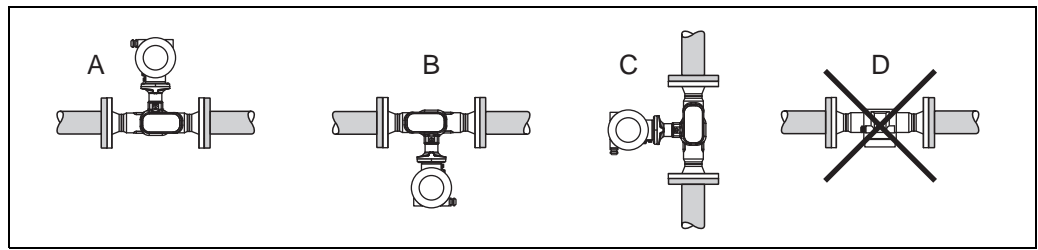

Fig. 7: Orientations A, B and C recommended, orientation D only recommended under certain circumstances

3.2.4 Heating

Some fluids require heat to be transferred at the sensor. Heating can be electric, e.g. with heated elements, or by hot water or steam.



Caution!

- Danger of electronics overheating!
Make sure that the adapter between the sensor and transmitter and the connection housing of the remote version always remain free of insulating material.
- When using electrical heat tracing whose heat is regulated using phase control or by pulse packs, it cannot be ruled out that the measured values are influenced by magnetic fields which may occur, (i.e. at values greater than those permitted by the EC standard (Sinus 30 A/m)). In such cases, the sensor must be magnetically shielded.

3.2.5 Thermal insulation

Some fluids require suitable measures to avoid loss of heat at the sensor. A wide range of materials can be used to provide the required thermal insulation.

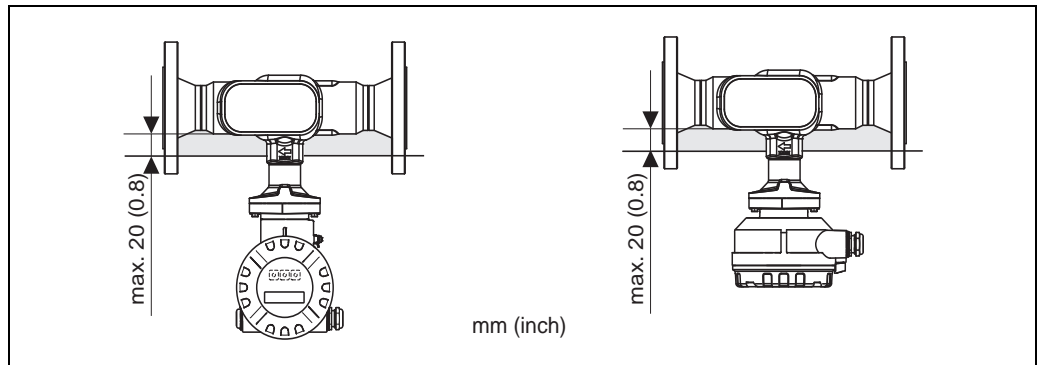

Fig. 8: A maximum insulation thickness of 20 mm (0.8 inch) must be observed in the area of the electronics/neck.

If the device is installed horizontally (with transmitter head pointing upwards), an insulation thickness of min. 10 mm (0.4") is recommended to reduce convection. The maximum insulation thickness of 20 mm (0.8") must not be exceeded.

3.2.6 Inlet and outlet run

If possible, install the sensor well clear of fittings such as valves, T-pieces, elbows, etc. As a minimum, the inlet and outlet runs shown below must be observed to achieve the specified accuracy of the device. The longest inlet run shown must be observed if two or more flow disturbances are present.

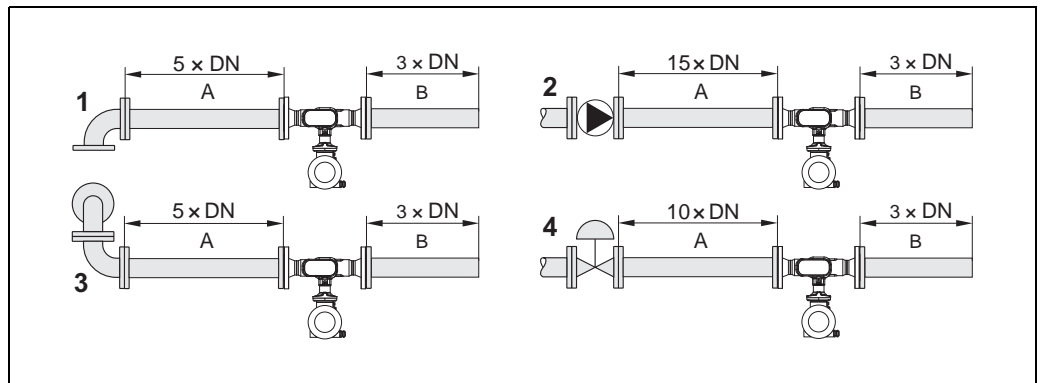

Fig. 9: Minimum inlet and outlet runs with various flow obstructions (values given for 3 and 4 path versions)
 A = Inlet run, B = Outlet run, 1 = 90° elbow or T-piece, 2 = Pump, 3 = 2 x 90° elbow, 3-dimensional, 4 = Control valve

3.2.7 Limiting flow

Information on limiting flow is provided under "Measuring range" in the technical data section.

3.3 Installation instructions

3.3.1 Mounting the sensor

- Prior to installing the measuring device in the piping, remove all traces of transport packaging and any protective covers from the sensor.
- Make sure that the internal diameters of seals are the same as, or greater than, those of the measuring device and piping. If seals with a smaller internal diameter are used, this affects the flow and results in inaccurate measurement.
- Ensure that the arrow on the measuring tube matches the direction of flow in the piping.
- For Carbon steel option remove transport protection coating using mineral spirit (optional).

3.3.2 Turning the transmitter housing

1. Loosen the safety screw.
2. Turn the transmitter housing to the desired position (max. 180° in each direction to the stop).



Note!

There are recesses in the rotating groove at 90° stages (only compact version). These help you align the transmitter easier.

3. Retighten the securing screw.

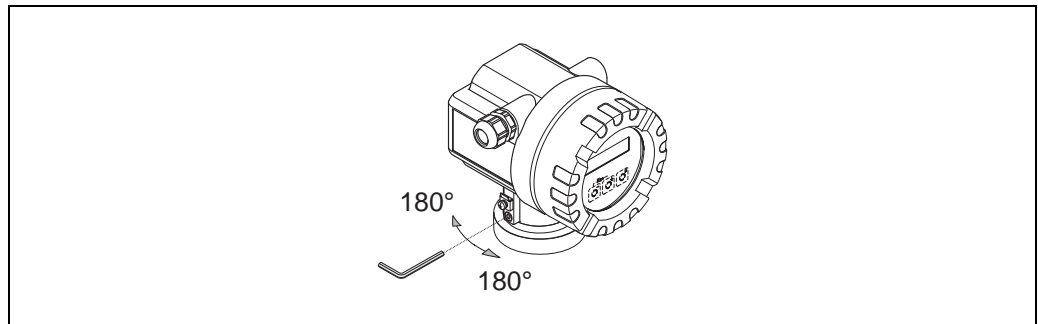

Fig. 10: Turning the transmitter housing

3.3.3 Turning the local display

1. Unscrew the cover of the electronics compartment from the transmitter housing.
2. Remove the display module from the transmitter retainer rails.
3. Turn the display to the desired position (max. 4 x 45° in each direction) and reset it onto the retaining rails.
4. Screw the cover of the electronics compartment firmly back onto the transmitter housing.

3.3.4 Mounting the remote version

The transmitter can be mounted in the following ways:

- Wall mounting
- Pipe mounting (with separate mounting kit, accessories) → 45



Caution!

When mounting on a pipe, the ambient temperature range may not be exceeded.

→ 63

The transmitter and the sensor must be mounted separate in the following circumstances:

- Poor accessibility
- Lack of space
- Extreme ambient temperatures

Mount the transmitter as illustrated in the diagram.

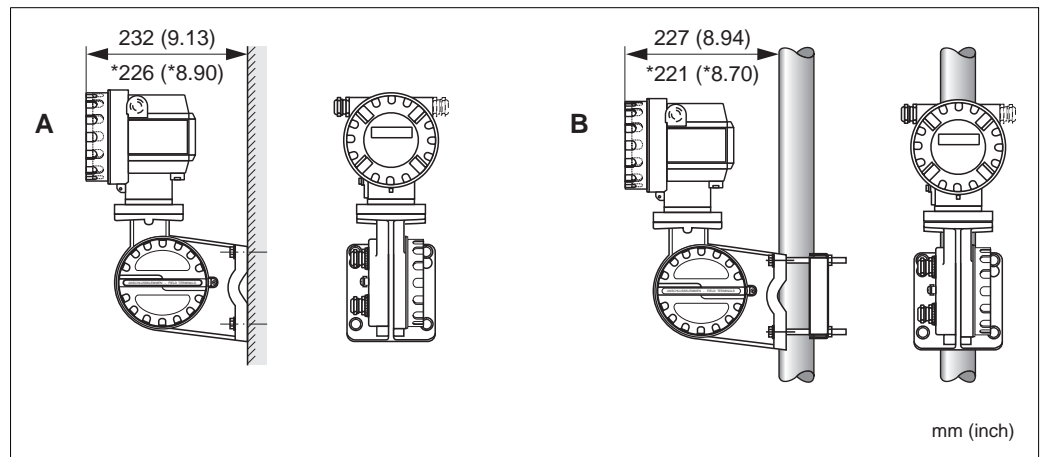

Fig. 11: Mounting the transmitter (remote version)

A Direct wall mounting

B Pipe mounting

* Dimensions for version without local display

3.4 Post-installation check

Perform the following checks after installing the measuring device:

Device condition and specifications	Notes
Is the device damaged (visual inspection)?	-
Do the process temperature/pressure, ambient temperature, measuring range etc. correspond to the specifications of the device?	→ 5
Installation	Notes
Does the arrow on the sensor or sensor neck match the direction of flow through the pipe?	-
Are the measuring point number and labeling correct (visual inspection)?	-
Process environment / process conditions	Notes
Is the measuring device protected against direct sunlight?	→ 63

4 Wiring

4.1 Connecting the remote version

4.1.1 Connecting cable for sensor/transmitter



Note!

- The remote version must be grounded. In doing so, the sensor and transmitter must be connected to the same potential matching (see Fig. 12, d).
- You may only connect the sensor to the transmitter with the same serial number (see nameplate). Communication errors can occur if this is not observed when connecting the devices.

Procedure

1. Remove the covers of the connection compartments (a/b).
2. Feed the connecting cable (c) through the appropriate cable entries.
3. Wire the sensor and transmitter in accordance with the electrical connection diagram: see Fig. 12 or the wiring diagram in the cover of the connection compartment.
4. Connect the appropriate cable shield (e/f).
5. Firmly tighten the glands of the cable entries.
6. Screw the covers of the connection compartments (a/b) back on.

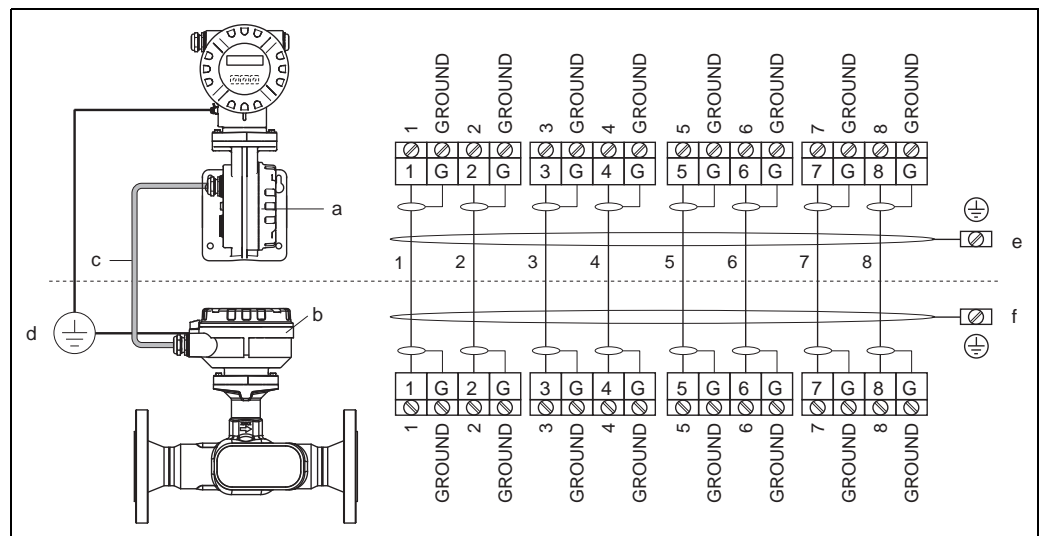

Fig. 12: Connecting the remote version

- a Cover of the connection compartment (transmitter)
 b Cover of the connection compartment (sensor)
 c Connecting cable (signal cable)
 d Identical potential matching for sensor and transmitter
 e Connect the shielding to the ground terminal in the transmitter housing and keep it as short as possible
 f Connect the shielding to the ground terminal in the connection housing

4.1.2 Cable specification for connecting cable

Only use the cables supplied by Endress+Hauser and pre-terminated at the factory. The cables are available with a fixed length of 10 m (30 feet) and 30 m (90 feet) and optionally available with variable lengths ranging from 1 m (3 feet) to max. 50 m (150 feet). The cable sheathing is made of PVC.

4.2 Connecting the measuring unit

4.2.1 Connecting the transmitter



Warning!

When connecting Ex-certified devices, see the notes and diagrams in the Ex-specific supplement to these Operating Instructions. Please do not hesitate to contact your Endress+Hauser representative if you have any questions.



Note!

- Observe national regulations governing the installation of electrical equipment.
- The remote version must be grounded. In doing so, the sensor and transmitter must be connected to the same potential matching.
- When connecting the transmitter, use a connecting cable with a continuous service temperature range between -40 °C (-40 °F) and the permitted max. ambient temperature plus 10 °C (plus 18 °F)

Connecting the transmitter, non-Ex/Ex-i version (→ 13)

1. Unscrew the cover (a) of the electronics compartment from the transmitter housing.
2. Remove the display module (b) from the retaining rails (c) and refit onto the right retaining rail with the left side of the display (this secures the display module).
3. Loosen screw (d) of the cover of the connection compartment and fold the cover down.
4. Push the cable for the power supply current output through the cable gland (e).
Optional: push the cable for the pulse output/frequency output through the cable gland (f).
5. Pull the terminal connector (g) out of the transmitter housing and connect the cable for the power supply/current output. (→ Fig. 14, A)
Optional: pull terminal connector (h) out of the transmitter housing and connect the cable for the pulse output/frequency output. (→ Fig. 14, B)



Note!

The terminal connectors (g / h) are pluggable, i.e. they can be plugged out of the transmitter housing to connect the cables.

6. Plug the terminal connectors (g / h) into the transmitter housing.



Note!

The connectors are coded so you cannot mix them up.

7. Only remote version:
secure the ground cable to the ground terminal (→ Fig. 14, C).
8. Tighten the cable glands (e / f) (see also Page 21).
9. Fold up the cover of the connection compartment and tighten the screws (d).
10. Remove the display module (b) and fit on the retaining rails (c).
11. Screw the cover of the electronics compartment (a) onto the transmitter housing.

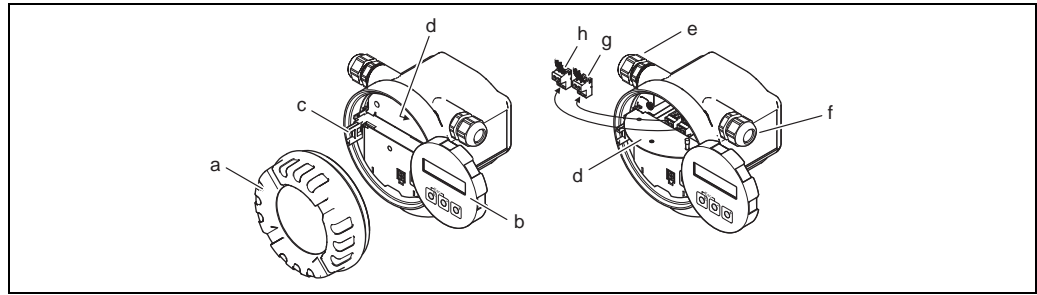

Fig. 13: Connecting the transmitter, non-Ex/Ex i version

- a Cover of electronics compartment
- b Display module
- c Retaining rail for display module
- d Connection compartment cover
- e Cable gland for power supply/current output cable
- f Cable gland for pulse output/frequency output cable (optional)
- g Terminal connector for power supply/current output
- h Terminal connector for pulse output/frequency output (optional)

Connecting the transmitter, Ex-d → 14

1. Open the clamp (a) securing the cover of the connection compartment.
2. Unscrew the cover (b) of the connection compartment from the transmitter housing.
3. Push the cable for the power supply/current output through the cable gland (c).
Optional: push the cable for the pulse output/frequency output through the cable gland (d).
4. Pull the terminal connector (e) out of the transmitter housing and connect the cable for the power supply/current output. (→ Fig. 14, A)
Optional: pull terminal connector (f) out of the transmitter housing and connect the cable for the pulse output/frequency output. (→ Fig. 14, B)



Note!

The terminal connectors (e/f) are pluggable, i.e. they can be plugged out of the transmitter housing to connect the cables.

5. Plug the terminal connectors (e / f) into the transmitter housing.



Note!

The connectors are coded so you cannot mix them up.

6. Only remote version:
secure the ground cable to the ground terminal (→ Fig. 14, C).
7. Tighten the cable glands (c / d) (see also Page 21).
8. Secure the ground cable to the ground terminal (only remote version)
9. Screw the cover (b) of the connection compartment onto the transmitter housing.
10. Tighten the clamp (a) securing the cover of the connection compartment.

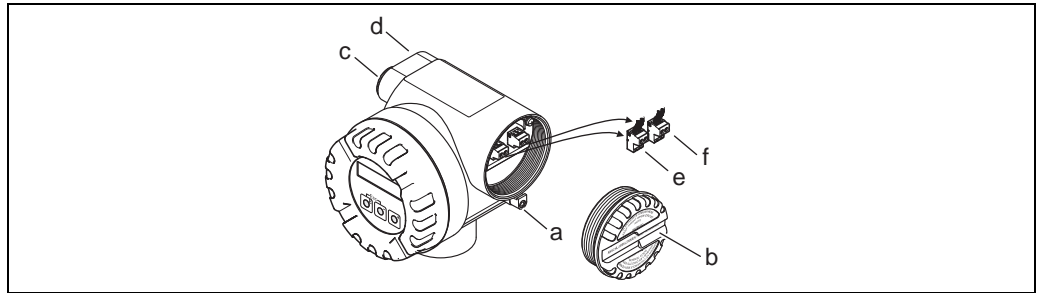

Fig. 14: Connecting the transmitter, Ex d version

- a Clamp securing cover of connection compartment
- b Cover of connection compartment
- c Cable gland for power supply/current output cable
- d Cable gland for pulse output/frequency output cable (optional)
- e Terminal connector for power supply/current output
- f Terminal connector for pulse output/frequency output (optional)

Wiring diagram

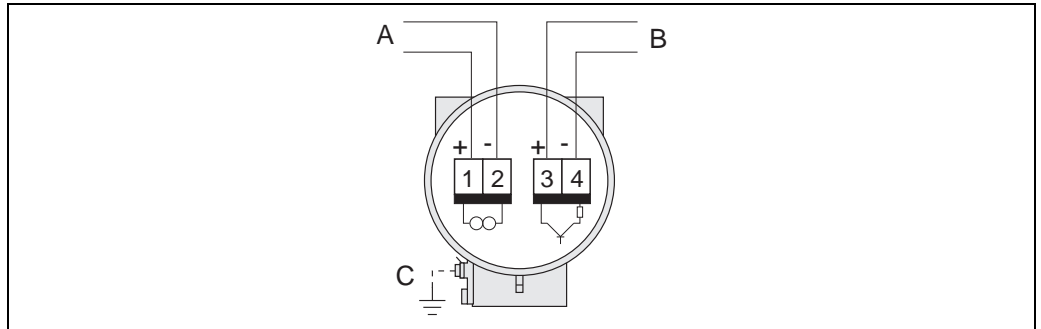

Fig. 15: Assignment of terminals

- A Power supply/current output
- B Optional pulse output/status output
- C Ground terminal (only relevant for remote version)

4.2.2 Terminal assignment

Order version	Terminal No. (inputs/outputs)	
	1 – 2	3 – 4
92***_*****W	HART current output	–
92***_*****A	HART current output	Pulse/status output/ frequency output

HART current output
Galvanically isolated, 4 to 20 mA with HART

Pulse/status output
Open collector, passive, galvanically isolated, $U_{max} = 30\text{ V}$, with 15 mA current limiting, $R_i = 500\ \Omega$, can be configured as pulse output or status output

4.2.3 HART connection

Users have the following connection options at their disposal:

- Direct connection to transmitter by means of terminals 1 (+) / 2 (-)
- Connection by means of the 4 to 20 mA circuit



Note!

- The measuring circuit's minimum load must be at least 250Ω .
- After commissioning, make the following setting:
Switch HART write protection on or off (see Page 38) → Page 37
- For connecting, please refer also to the documentation issued by the HART Communication Foundation, in particular HCF LIT 20: "HART, a technical summary".

Connecting the HART handheld terminal

For the connection, also refer to the documentation issued by the HART Communication Foundation, and in particular HCF LIT 20: "HART, a technical summary".

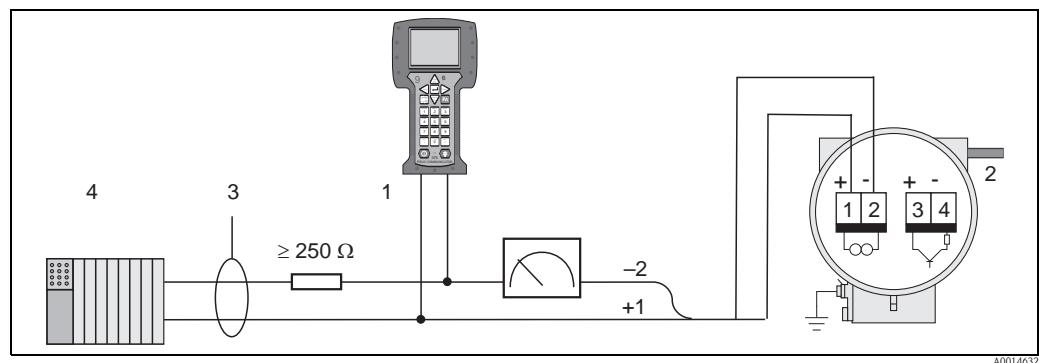

Fig. 16: Electrical connection to the HART operating terminal

- 1 HART operating terminal
- 2 Power supply
- 3 Shielding
- 4 Additional switching units or PLC with passive input

Connecting a PC with operating software

A HART modem (e.g. "Commubox FXA195") is required for connecting a PC with operating software (e.g. "FieldCare").

For the connection, also refer to the documentation issued by the HART Communication Foundation, and in particular HCF LIT 20: "HART, a technical summary".

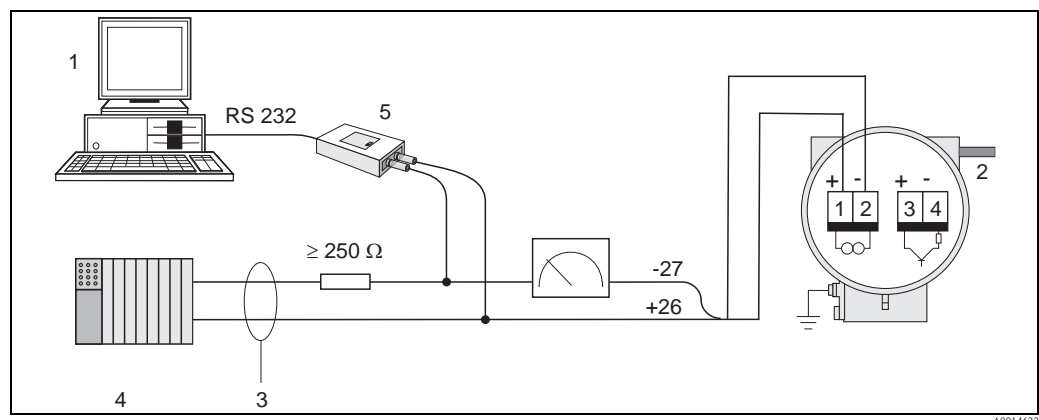

Fig. 17: Electrical connection of a PC with operating software

- 1 PC with operating software
- 2 Power supply
- 3 Shielding
- 4 Additional switching units or PLC with passive input
- 5 HART modem e.g. Commubox FXA195

4.3 Degree of protection

The devices fulfill all the requirements for IP 67 (optional IP 68) degree of protection. Compliance with the following points is mandatory following installation in the field or servicing in order to ensure that IP 67 protection is maintained:

- The housing seals must be clean and undamaged when inserted into their grooves. The seals must be dried, cleaned or replaced if necessary.
- All housing screws and screw caps must be firmly tightened.
- The cables used for connection must be of the specified outside diameter.
- Firmly tighten the cable entries.
- The cables must loop down before they enter the cable entries ("water trap").
This arrangement prevents moisture penetrating the entry. Always install the measuring device in such a way that the cable entries do not point up.
- Replace all unused cable entries with dummy plugs.
- Do not remove the grommet from the cable entry.

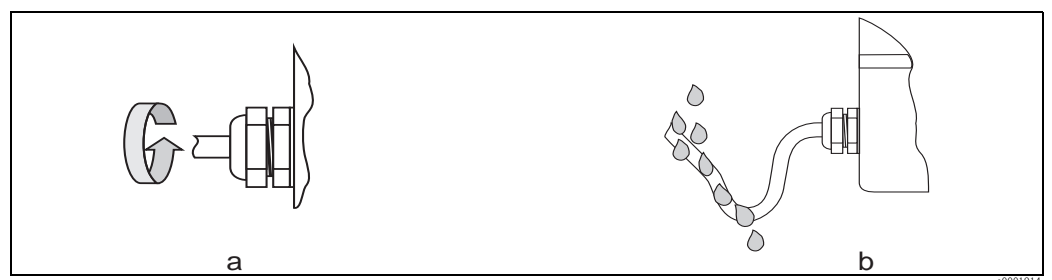

Fig. 18: Installation instructions for cable entries



Caution!

The cable glands of the sensor housing must not be released as the degree of protection guaranteed by Endress+Hauser would no longer apply.



Note!

The Prosonic Flow 92F can be supplied with IP 68 rating (permanent immersion in water to a depth of 3 meters /10 ft). In this case the transmitter must be installed remote from the sensor.

4.4 Post-connection check

Perform the following checks after completing electrical installation of the measuring device:

Device condition and specifications	Notes
Are cables or the device damaged (visual inspection)?	–
Electrical connection	Notes
Does the supply voltage match the specifications on the nameplate? <ul style="list-style-type: none"> ■ Non-Ex: 12 to 35 V DC (with HART: 18 to 35 V DC) ■ Ex i and Ex n: 12 to 30 V DC (with HART 18 to 30 V DC) ■ Ex d: 15 to 35 V DC (with HART 21 to 35 V DC) 	–
Do the cables used comply with the specifications?	→ 16, → 62
Do the cables have adequate strain relief?	–
Are the cables for power supply/current output, frequency output (optional) and grounding connected correctly?	→ 17
Remote version only: Is the connecting cable between the sensor and transmitter connected correctly?	→ 16
Remote version only: Are the sensor and transmitter connected to the same potential matching?	→ 16
Are all screw terminals firmly tightened?	–
Are all the cable entries installed, tightened and sealed? Cable run with "water trap"?	→ 21
Are all the housing covers installed and tightened?	–

5 Operation

5.1 Display and operating elements

The local display enables you to read important parameters directly at the measuring point and configure the device using the "Quick Setup" or the function matrix.

The display consists of two lines; this is where measured values and/or status variables (e.g. bar graph) are displayed.

By means of local operation, you can change the assignment of the display lines to different variables to suit your needs and preferences. See Device Functions in the Appendix → 68

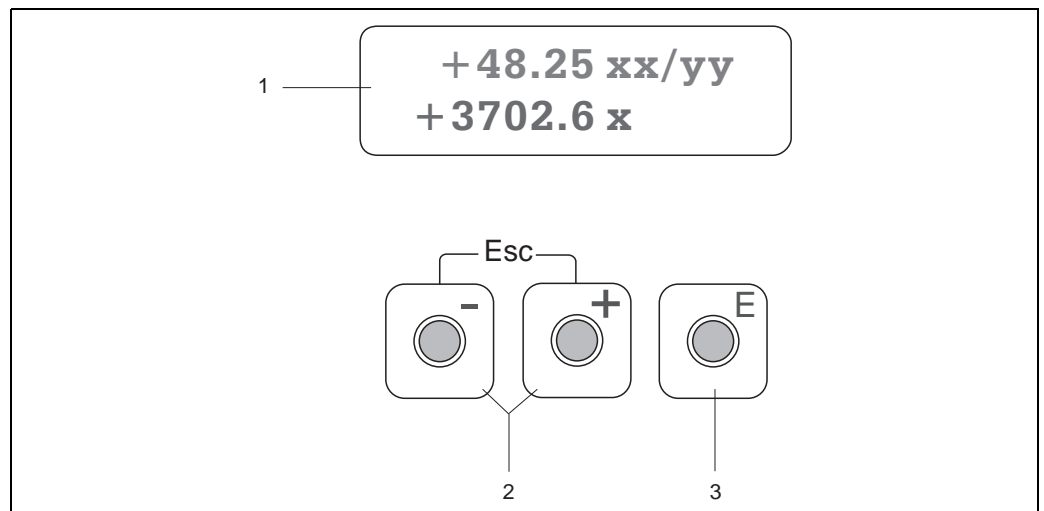

Fig. 19: Display and operating elements

- 1 **Liquid crystal display**
 - The two-line liquid-crystal display shows measured values and diagnosis messages.
 - Top line: shows main measured values, e.g. volume flow in [dm³/h] or in [%].
 - Bottom line: shows additional measured variables and status variables, e.g. totalizer reading in [dm], bar graph, tag name.
 - During commissioning or in the event of a fault in normal measuring operation, a diagnosis message flashes on the screen.
 - The first line shows the diagnosis code beginning with the letters F, C, S or M and a short text containing the diagnosis message appears on the second line.
- 2 **Plus/minus keys**
 - Enter numerical values, select parameters
 - Select different function groups within the function matrix
 - Press the +/- keys simultaneously to trigger the following functions:
 - Exit the function matrix step by step → HOME position
 - Press and hold down +/- keys for longer than 3 seconds → return directly to the HOME position
 - Cancel data entry
- 3 **Enter key**
 - HOME position → enter the function matrix
 - Save the numerical values you input or settings you changed

5.2 Operation via the function matrix



Note!

- Please refer to the general notes → 25
 - Function descriptions → see the "Description of Device Functions" manual
1. HOME position → **E** → enter the function matrix
 2. Select a function group e.g. CURRENT OUTPUT
 3. Select a function (e.g. TIME CONSTANT)
Change parameter/enter numerical values:
 - +** → select or enter enable code, parameters, numerical values
 - E** → save your entries
 4. Exit the function matrix:
 - Press and hold down the Esc key (**Esc**) for more than 3 seconds → HOME position
 - Repeatedly press Esc key (**Esc**) → return step by step to HOME position

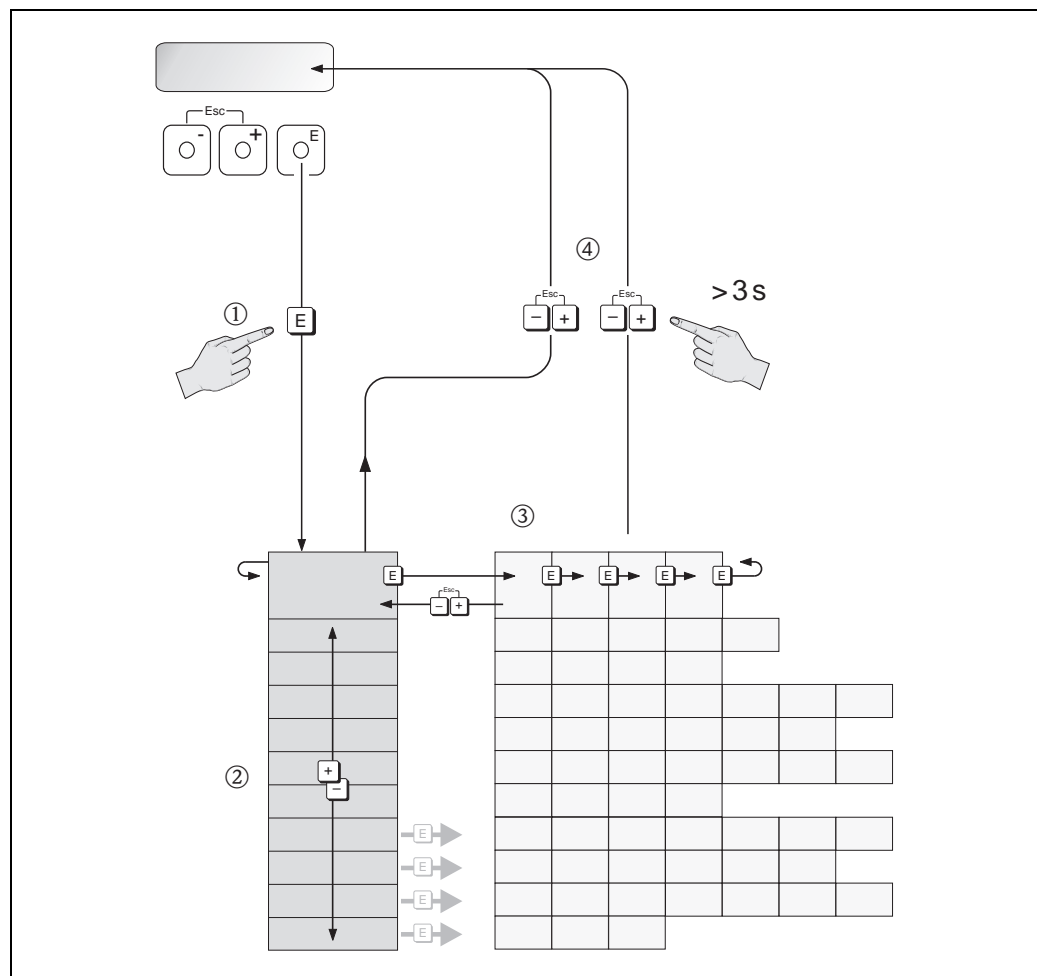



Fig. 20: Selecting and configuring functions (function matrix)

5.2.1 General notes

The Quick Setup menu is adequate for commissioning with the necessary standard settings. Complex measuring operations on the other hand necessitate additional functions that you can configure as necessary and customize to suit your process conditions. The function matrix, therefore, comprises a multiplicity of additional functions which, for the sake of clarity, are arranged in a number of function groups.

Comply with the following instructions when configuring functions:

- You select functions as described already.
- You can switch off certain functions (OFF). If you do so, related functions in other function groups will no longer be displayed.
- Certain functions prompt you to confirm your data entries. Press  to select "SURE [YES]" and press  to confirm. This saves your setting or starts a function, as applicable.
- Return to the HOME position is automatic if no key is pressed for 5 minutes.
- Programming mode is automatically disabled if you do not press a key within 60 seconds following return to the HOME position.



Note!

A detailed description of all the functions required for commissioning is provided in Section 11.1 "Description of device functions".



Note!

- The transmitter continues to measure while data entry is in progress, i.e. the current measured values are output via the signal outputs in the normal way.
- If the power supply fails, all preset and configured values remain safely stored in the EEPROM.

5.2.2 Enabling the programming mode

The function matrix can be disabled. Disabling the function matrix rules out the possibility of inadvertent changes to device functions, numerical values or factory settings. A numerical code (factory setting = 92) has to be entered before settings can be changed.

If you use a code number of your choice, you exclude the possibility of unauthorized persons accessing data (→ see "Description of Device Functions" manual).

Comply with the following instructions when entering codes:

- If programming is disabled and the  operating elements are pressed in any function, a prompt for the code automatically appears on the display.
- If "0" is entered as the private code, programming is always enabled.
- Your Endress+Hauser service organization can be of assistance if you are locked out of the device.



Caution!

Changing certain parameters influences numerous functions of the entire measuring device, and may effect measuring accuracy!

There is no need to change these parameters under normal circumstances and consequently, they are protected by a special service code known only to the Endress+Hauser service organization. Please contact Endress+Hauser if you have any questions.

5.2.3 Disabling the programming mode

Programming mode is disabled if you do not press an operating element within 60 seconds following automatic return to the HOME position.

You can also disable programming by entering any number (other than the private code) in the ACCESS CODE function.

5.3 Communication

In addition to via local operation, the measuring device can also be configured and measured values obtained by means of the HART protocol. Digital communication takes place using the 4–20 mA current output HART.

The HART protocol allows the transfer of measuring and device data between the HART master and the field devices for configuration and diagnostics purposes. HART masters, such as a handheld terminal or PC-based operating programs (such as FieldCare), require device description (DD) files. They are used to access all the information in a HART device. Such information is transferred solely via "commands". There are three different command classes:

There are three different command classes:

- *Universal commands*

All HART devices support and use universal commands. The following functionalities are linked to them:

- Recognizing HART devices
- Reading off digital measured values (volume flow, totalizer, etc.)

- *Common practice commands:*

Common practice commands offer functions which are supported and can be executed by many but not all field devices.

- *Device-specific commands:*

These commands allow access to device-specific functions which are not HART standard. Such commands access individual field device information, (among other things), such as empty-pipe/full-pipe adjustment values, low flow cutoff settings etc.



Note!

The measuring device has all three command classes.

List of all "Universal Commands" and "Common Practice Commands": → 30

5.3.1 Operating options

For the complete operation of the measuring device, including device-specific commands, there are device description (DD) files available to the user to provide the following operating aids and programs:



Note!

- The HART protocol requires the "4 to 20 mA HART" setting (individual options see device function) in the CURRENT SPAN function (current output 1).

HART Field Communicator Field Xpert

Selecting device functions with a HART Communicator is a process involving a number of menu levels and a special HART function matrix.

The HART operating instructions in the carrying case of the HART handheld terminal contain more detailed information on the device.

Operating program "FieldCare"

FieldCare is Endress+Hauser's FDT-based plant asset management tool and allows the configuration and diagnosis of intelligent field devices. By using status information, you also have a simple but effective tool for monitoring devices.

Operating program "SIMATIC PDM" (Siemens)

SIMATIC PDM is a standardized, manufacturer independent tool for the operation, configuration, maintenance and diagnosis of intelligent field devices.

Operating program "AMS" (Emerson Process Management)

AMS (Asset Management Solutions): program for operating and configuring devices.

5.3.2 Current device description files

The following table illustrates the suitable device description file for the operating tool in question and then indicates where these can be obtained.

HART protocol:

Valid for software:	1.01.XX	→ Function "Device software"
Device data HART		
Manufacturer ID:	11 _{hex} (ENDRESS+HAUSER)	→ Function "Manufact ID"
Device ID:	61 _{hex}	→ Function "Device ID"
HART version data:	Device Revision 6/ DD Revision 1	
Software release:	12.2010	
Operating program:	Sources for obtaining device descriptions:	
Handheld terminal Field Xpert	<ul style="list-style-type: none"> ■ Use update function of handheld terminal 	
FieldCare / DTM	<ul style="list-style-type: none"> ■ www.endress.com → Download ■ CD-ROM (Endress+Hauser order number 56004088) ■ DVD (Endress+Hauser order number 70100690) 	
AMS	<ul style="list-style-type: none"> ■ www.endress.com → Download 	
SIMATIC PDM	<ul style="list-style-type: none"> ■ www.endress.com → Download 	

Tester/simulator:	Sources for obtaining device descriptions:
Fieldcheck	<ul style="list-style-type: none"> ■ Update by means of FieldCare via the Flow Device FXA193/291 DTM in the Fieldflash module



Note!

The "Fieldcheck" tester/simulator is used for testing flowmeters in the field. When used in conjunction with the "FieldCare" software package, test results can be imported into a database, printed out and used for official certification. Contact your Endress+Hauser representative for more information.

5.3.3 Device variables and process variables

Device variables:

The following device variables are available via the HART protocol:

ID (decimal)	Device variable
30	Volume flow
40	Sound velocity
43	Signal strength
49	Flow velocity
240	Totalizer 1
241	Totalizer 2

Process variables:

At the factory, the process variables are assigned to the following device variables:

- Primary process variable (PV) → volume flow
- Secondary process variable (SV) → totalizer
- Third process variable (TV) → sound velocity
- Fourth process variable (FV) → flow velocity











Note!

You can set or change the assignment of device variables to process variables using Command 51 → 33.

5.3.4 Universal/common practice HART commands



The following table contains all the universal commands supported by the device.





Command No. HART command/access type		Command data (numeric data in decimal form)	Response data (numeric data in decimal form)
Universal commands			
0	Read the unique device identifier Access type = Read	None	<p>The device identifier provides information on the device and manufacturer; it cannot be altered.</p> <p>The response consists of a 12-byte device ID:</p> <ul style="list-style-type: none"> – Byte 0: fixed value 254 – Byte 1: manufacturer ID, 17 = E+H – Byte 2: device type ID, e.g. 0x61 = Prosonic 92 – Byte 3: number of preambles – Byte 4: rev. no. universal commands – Byte 5: rev. no. device-spec. Commands – Byte 6: software revision – Byte 7: hardware revision – Byte 8: additional device information – Byte 9-11: device identification
1	Read the primary process variable Access type = Read	None	<ul style="list-style-type: none"> – Byte 0: HART unit ID of the primary process variable – Byte 1-4: primary process variable <p><i>Factory setting:</i> Primary process variable = volume flow</p> <p> Note!</p> <ul style="list-style-type: none"> ■ You can set the assignment of device variables to process variables using Command 51. ■ Manufacturer-specific units are represented using the HART unit ID "240".
2	Read the primary process variable as current in mA and percentage of the set measuring range Access type = Read	None	<ul style="list-style-type: none"> – Byte 0-3: current current of the primary process variable in mA – Byte 4-7: percentage of the set measuring range <p><i>Factory setting:</i> Primary process variable = volume flow</p> <p> Note!</p> <p>You can set the assignment of device variables to process variables using Command 51.</p>
3	Read the primary process variable as current in mA and four (preset using command 51) dynamic process variables Access type = Read	None	<p>24 bytes are sent as a response:</p> <ul style="list-style-type: none"> – Byte 0-3: current of the primary process variable in mA – Byte 4: HART unit ID of the primary process variable – Byte 5-8: primary process variable – Byte 9: HART unit ID of the secondary process variable – Byte 10-13: secondary process variable – Byte 14: HART unit ID of the third process variable – Byte 15-18: third process variable – Byte 19: HART unit ID of the fourth process variable – Byte 20-23: fourth process variable <p><i>Factory setting:</i></p> <ul style="list-style-type: none"> ■ Primary process variable = volume flow ■ Secondary process variable = totalizer 1 ■ Third process variable = sound velocity ■ Fourth process variable = flow velocity <p> Note!</p> <ul style="list-style-type: none"> ■ You can set the assignment of device variables to process variables using Command 51. ■ Manufacturer-specific units are represented using the HART unit ID "240".



Command No. HART command/access type		Command data (numeric data in decimal form)	Response data (numeric data in decimal form)
6	Set HART short-form address Access type = Write	Byte 0: desired address (0 to 15) <i>Factory setting:</i> 0  Note! With an address >0 (multidrop mode), the current output of the primary process variable is fixed to 4 mA.	Byte 0: active address
11	Read the unique device identifier using the TAG Access type = Read	Byte 0-5: TAG	The device identifier provides information on the device and manufacturer; it cannot be altered. The response consists of a 12-byte device ID if the given TAG matches the one saved in the device: – Byte 0: fixed value 254 – Byte 1: manufacturer ID, 17 = E+H – Byte 2: device type ID, 0x61 = Prosonic 92 – Byte 3: number of preambles – Byte 4: rev. no. universal commands – Byte 5: rev. no. device-spec. Commands – Byte 6: software revision – Byte 7: hardware revision – Byte 8: additional device information – Byte 9-11: device identification
12	Read user message Access type = Read	None	Byte 0-24: user message  Note! You can write the user message using command 17.
13	Read TAG, TAG description and date Access type = Read	None	– Byte 0-5: TAG – Byte 6-17: TAG description – Byte 18-20: date  Note! You can write the TAG, TAG description and date using command 18.
14	Read sensor information on the primary process variable	None	– Byte 0-2: serial number of the sensor – Byte 3: HART unit ID of the sensor limits and measuring range of the primary process variable – Byte 4-7: upper sensor limit – Byte 8-11: lower sensor limit – Byte 12-15: minimum span  Note! ■ The data relate to the primary process variable (= volume flow). ■ Manufacturer-specific units are represented using the HART unit ID "240".
15	Read output information of the primary process variable Access type = Read	None	– Byte 0: alarm selection ID – Byte 1: ID for transfer function – Byte 2: HART unit ID for the set measuring range of the primary process variable – Byte 3-6: end of measuring range, value for 20 mA – Byte 7-10: start of measuring range, value for 4 mA – Byte 11-14: attenuation constant in [s] – Byte 15: ID for write protection – Byte 16: ID for OEM dealer, 17 = E+H <i>Factory setting:</i> Primary process variable = volume flow  Note! ■ You can set the assignment of device variables to process variables using Command 51. ■ Manufacturer-specific units are represented using the HART unit ID "240".
16	Read the device production number Access type = Read	None	Byte 0-2: production number

Command No. HART command/access type		Command data (numeric data in decimal form)	Response data (numeric data in decimal form)
17	Write user message Access = Write	You can save any 32-character long text in the device with this parameter: Byte 0-23: desired user message	Displays the current user message in the device: Byte 0-23: current user message in the device
18	Write TAG, TAG description and date Access = Write	You can save an 8-character TAG, a 16-character TAG description and a date with this parameter: – Byte 0-5: TAG – Byte 6-17: TAG description – Byte 18-20: date	Displays the current information in the device: – Byte 0-5: TAG – Byte 6-17: TAG description – Byte 18-20: date

The following table contains all the common practice commands supported by the device.

Command No. HART command/access type		Command data (numeric data in decimal form)	Response data (numeric data in decimal form)
Common practice commands			
33	Read measured values	Byte 0: device variable ID for channel 0 Byte 1: device variable ID for channel 1 Byte 2: device variable ID for channel 2 Byte 3: device variable ID for channel 3	Byte 0: device variable ID for channel 0 Byte 1: unit ID for channel 0 Byte 2-5: value of channel 0 Byte 6: device variable ID for channel 1 Byte 7: unit ID for channel 1 Byte 8-11: value of channel 1 Byte 12: device variable ID for channel 2 Byte 13: unit ID for channel 2 Byte 14-17: value of channel 2 Byte 18: device variable ID for channel 3 Byte 19: unit ID for channel 3 Byte 20-23: value of channel 3
34	Write attenuation constant for primary process variable Access = Write	Byte 0-3: attenuation constant of the primary process variable in seconds <i>Factory setting:</i> Primary process variable = flow	Displays the current attenuation constant in the device: Byte 0-3: attenuation constant in seconds
35	Write measuring range of the primary process variable Access = Write	Write the desired measuring range: – Byte 0: HART unit ID for the primary process variable – Byte 1-4: end of measuring range, value for 20 mA – Byte 5-8: start of measuring range, value for 4 mA <i>Factory setting:</i> Primary process variable = flow  Note! ■ You can set the assignment of device variables to process variables using Command 51. ■ If the HART unit ID does not suit the process variable, the device will continue with the last valid unit.	The measuring range currently set is shown as the response: – Byte 0: HART unit ID for the set measuring range of the primary process variable – Byte 1-4: end of measuring range, value for 20 mA – Byte 5-8: start of measuring range, value for 4 mA (is always at "0")  Note! Manufacturer-specific units are represented using the HART unit ID "240".
36	Set full scale value	None	None
37	Set lower range value	None	None
38	Device status reset "configuration changed" Access = Write	None	None
40	Simulate output current of the primary process variable Access = Write	Simulation of the desired output current of the primary process variable. An entry value of 0 exits the simulation mode: Byte 0-3: output current in mA <i>Factory setting:</i> Primary process variable = flow  Note! You can set the assignment of device variables to process variables with Command 51.	The current output current of the primary process variable is displayed as a response: Byte 0-3: output current in mA
42	Perform device reset Access = Write	None	None

Command No. HART command/access type		Command data (numeric data in decimal form)	Response data (numeric data in decimal form)
44	Write unit of the primary process variable Access = Write	Specify the unit of the primary process variable. Only units which are suitable for the process variable are accepted by the device: Byte 0: HART unit ID <i>Factory setting:</i> Primary process variable = flow  Note! <ul style="list-style-type: none"> ■ If the written HART unit ID does not suit the process variable, the device will continue with the last valid unit. ■ If you change the unit of the primary process variable, this does not affect the system units. 	The current unit code of the primary process variable is displayed as a response: Byte 0: HART unit ID  Note! Manufacturer-specific units are represented using the HART unit ID "240".
45	Zero point adjustment at the current output	Byte 0-3: measured current in mA	The current output current of the primary process variable is displayed as a response: Byte 0-3: output current in mA
46	Span adjustment (adjustment of the measuring range) at the current output	Byte 0-3: measured current in mA	The current output current of the primary process variable is displayed as a response: Byte 0-3: output current in mA
48	Read extended device status Access = Read	None	The current device status is displayed in extended form as the response: Coding: see Table → Page 35
50	Read assignment of the device variables to the four process variables Access = Read	None	Display of the current variable assignment of the process variables: <ul style="list-style-type: none"> – Byte 0: device variable ID to the primary process variable – Byte 1: device variable ID to the secondary process variable – Byte 2: device variable ID to the third process variable – Byte 3: device variable ID to the fourth process variable <i>Factory setting:</i> <ul style="list-style-type: none"> ■ Primary process variable: ID 1 for flow ■ Second process variable: code 250 for totalizer 1 ■ Third process variable: code 7 for sound velocity ■ Fourth process variable: code 9 for flow velocity  Note! You can set the assignment of device variables to process variables with Command 51.
51	Write assignments of the device variables to the four process variables Access = Write	Specify device variables for the four process variables: <ul style="list-style-type: none"> – Byte 0: device variable ID to the primary process variable – Byte 1: device variable ID to the secondary process variable – Byte 2: device variable ID to the third process variable – Byte 3: device variable ID to the fourth process variable <i>ID of the supported device variables:</i> See data →  29 <i>Factory setting:</i> <ul style="list-style-type: none"> ■ Primary process variable = flow ■ Secondary process variable = totalizer 1 ■ Third process variable = sound velocity ■ Fourth process variable = flow velocity 	The variable assignment of the process variables is displayed as a response: <ul style="list-style-type: none"> – Byte 0: device variable ID to the primary process variable – Byte 1: device variable ID to the secondary process variable – Byte 2: device variable ID to the third process variable – Byte 3: device variable ID to the fourth process variable

Command No. HART command/access type		Command data (numeric data in decimal form)	Response data (numeric data in decimal form)
53	Write device variable unit Access = Write	<p>This command sets the unit of the given device variables. Only those units which suit the device variable are transferred:</p> <ul style="list-style-type: none"> – Byte 0: device variable ID – Byte 1: HART unit ID <p><i>ID of the supported device variables:</i> See data →  29</p> <p> Note!</p> <ul style="list-style-type: none"> ■ If the written unit does not suit the device variable, the device will continue with the last valid unit. ■ If you change the unit of the device variable, this does not affect the system units. 	<p>The current unit of the device variables is displayed in the device as a response:</p> <ul style="list-style-type: none"> – Byte 0: device variable ID – Byte 1: HART unit ID <p> Note! Manufacturer-specific units are represented using the HART unit ID "240".</p>
54	Read information on the device variables Access = Read	Byte 0: device variable ID	<p>Byte 0: device variable ID Byte 1-3: serial number of the associated sensor Byte 4: unit ID for device variable Byte 5-8: upper limit of the device variable Byte 9-12: lower limit of the device variable Byte 13-16: time constant of device variable (unit: s)</p>
59	Specify number of preambles in message responses Access = Write	<p>This parameter specifies the number of preambles which are inserted in the message responses:</p> <p>Byte 0: number of preambles (2 to 20)</p>	<p>As a response, the current number of the preambles is displayed in the response message:</p> <p>Byte 0: number of preambles</p>

5.3.5 Device status/diagnosis code messages

You can read the extended device status, in this case, current diagnosis code messages, via command "48". The command delivers bit-encoded information (see table below).



Note!

Detailed information on the device status messages and diagnosis code messages, and how they are rectified, can be found in the Troubleshooting section on → [47](#)

Byte	Bit	Diagnosis code	Brief description of the message → 48	
0	0	284	Software update	Loading new amplifier software version. No other commands possible at this point.
	1	481	Diagnostic active	
	2	281	Initialization	Initialization in progress. All outputs are set to 0.
	3	411	Upload/download	Uploading and downloading device files. No other commands possible at this point.
	4	1	Device fault	Serious device error
	5	282-1	Data storage	Error when accessing the amplifier EEPROM
	6	282-2	Data storage	Error when accessing the I/O module EEPROM
	7	282-3	Data storage	Error when accessing the T-DAT
1	0	283-1	Checksum error	Data in the amplifier EEPROM faulty
	1	283-2	Checksum error	Data in the I/O module EEPROM faulty
	2	283-3	Checksum error	Data in the T-DAT EEPROM faulty
	3	242	Incompatible SW	The I/O board and the amplifier board are not compatible
	4	62-1	Sensor connection	Connection (down) sensor K1 / transmitter interrupted
	5	62-2	Sensor connection	Connection (up) sensor K1 / transmitter interrupted
	6	62-3	Sensor connection	Connection (down) sensor K2 / transmitter interrupted
	7	62-5	Sensor connection	Connection (up) sensor K2 / transmitter interrupted
2	0	62-5	Sensor connection	Connection (down) sensor K3 / transmitter interrupted
	1	62-6	Sensor connection	Connection (up) sensor K3 / transmitter interrupted
	2	62-7	Sensor connection	Connection (down) sensor K4 / transmitter interrupted
	3	62-8	Sensor connection	Connection (up) sensor K4 / transmitter interrupted
	4	283-4	Checksum error	Totalizer checksum error
	5	262	Module connection	Internal communication error on the amplifier board
	6	823-1	Ambient temp.	The lower medium temperature limit for the thermosensor was undershot
	7	823-2	Ambient temp.	The upper medium temperature limit for the thermosensor was overshot
3	0	881-1	Sensor signal	Channel 1: signal strength of the sensor too low
	1	881-2	Sensor signal	Channel 2: signal strength of the sensor too low
	2	881-3	Sensor signal	Channel 3: signal strength of the sensor too low
	3	881-4	Sensor signal	Channel 4: signal strength of the sensor too low
	4	431-1	Adjust	Zero point adjustment faulty
	5	431-2	Adjust	Channel 1: zero point adjustment faulty
	6	431-3	Adjust	Channel 2: zero point adjustment faulty
	7	431-4	Adjust	Channel 3: zero point adjustment faulty

Byte	Bit	Diagnosis code	Brief description of the message →  48	
4	0	431-5	Adjust	Channel 4: zero point adjustment faulty
	1	861-1	Medium	Volume flow outside specified range.
	2	861-2	Medium	Flow velocity outside specified range.
	3	861-3	Medium	Signal strength outside specified range.
	4	861-4	Medium	Sound velocity outside specified range.
	5	861-5	Medium	Acceptance rate outside specified range.
	6	861-6	Medium	Profile factor outside specified range.
5	7	861-7	Medium	Symmetry outside specified range.
	0	412	Write backup	Data backup to T-DAT failed
	1	413	Read backup	Error when accessing the T-DAT
	2	461-1	Signal output	Current adjustment active
	3	453	Value suppression	Positive zero return active
	4	484	Simulation error	Simulation of failsafe mode (outputs) active
	5	485	Simulation value	Measured variable simulation active
14	6	482-1	Simulation outp.	Current output simulation active
	7	482-2	Simulation outp.	Simulation frequency output active
	0	482-3	Simulation outp.	Pulse output simulation active
	1	482-4	Simulation outp.	Status output simulation active
	2	461-2	Signal output	Current output: flow outside range
	3	461-3	Signal output	Frequency output: flow outside range
	4	461-4	Signal output	Pulse output: flow outside range
	5	431-6	Adjust	Zero point adjustment in progress

5.3.6 Switching HART write protection on/off

Write protection can be activated or deactivated via switch block 2 (e/D).
The current status is displayed in the WRITE PROTECT function (see → 100).

1. Unscrew the cover of the electronics compartment from the transmitter housing.
2. Remove the display module (a) from the retaining rails (b) and refit onto right retaining rail with the left side (this secures the display module).
3. Fold up the plastic cover (c).
4. At switch block 2 (e), move miniature switch 2 (D) to the desired position:
OFF position, miniature switch moved up = write protection deactivated **ON** position, miniature switch moved down = write protection activated
5. Installation is the reverse of the removal procedure.

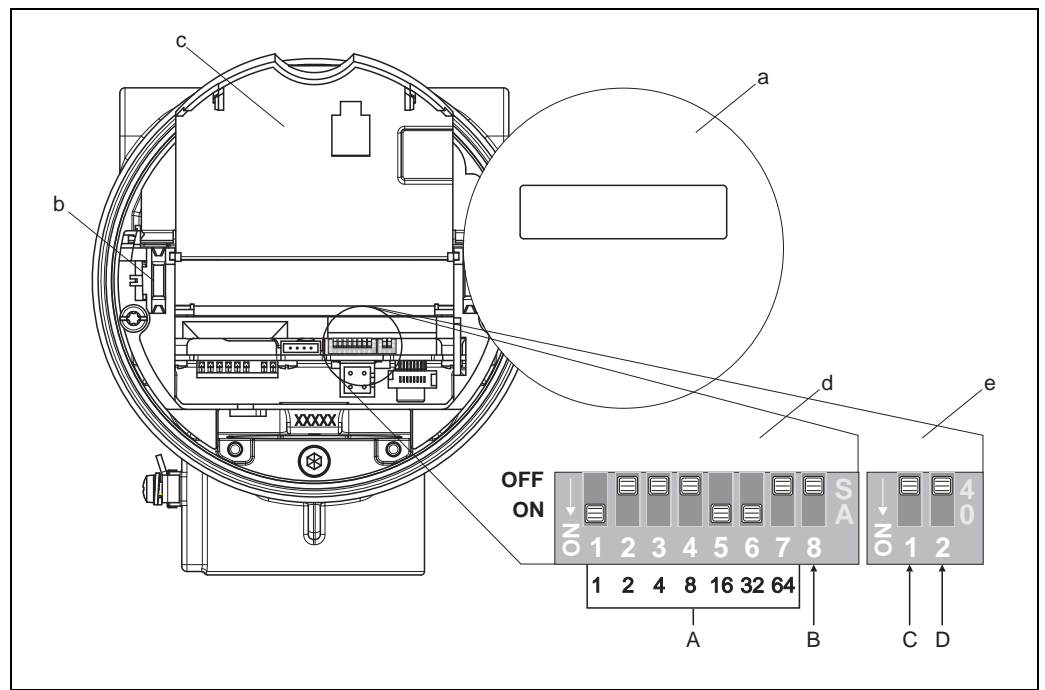



Fig. 21: Switching HART write protection on/off

- a Display module
- b Retaining rails for the display module
- c Plastic cover
- d Switch block 1:
 - A (Miniature switches 1 to 7): not assigned/no function
 - B (Miniature switch 8): not assigned/no function
- e Switch block 2:
 - C (Miniature switch 1): not assigned/no function
 - D (Miniature switch 2):
Switch write protection on/off
OFF = deactivated, write protection deactivated (miniature switch moved up)
ON = activated, write protection activated (miniature switch moved down)
(the current status of the write protection is displayed in the WRITE PROTECT function → → 100)

6 Commissioning

6.1 Function check

Make sure that the following function checks have been performed successfully before switching on the supply voltage for the measuring device:

- "Post-installation check" checklist →  15
- "Post-connection check" checklist →  22

6.2 Switching on the measuring device

Once the function check has been performed successfully, the device is operational and can be switched on via the supply voltage. The device then performs internal test functions and the following messages are shown on the local display:

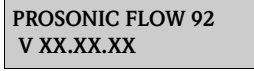

PROSONIC FLOW 92
V XX.XX.XX

Displays the current software

Normal measuring mode commences as soon as device startup completes.
Various measured values and/or status variables appear on the display (HOME position).



Note!

If startup fails, an appropriate diagnosis code appears on the local display, depending on the cause.
→  48

6.3 Quick Setup

In the case of measuring devices without a local display, the individual parameters and functions must be configured via the configuration program, e.g. Fieldcare. If the measuring device is equipped with a local display, all the important device parameters for standard operation, as well as additional functions, can be configured quickly and easily by means of the following Quick Setup menus.

6.3.1 "Commissioning" Quick Setup

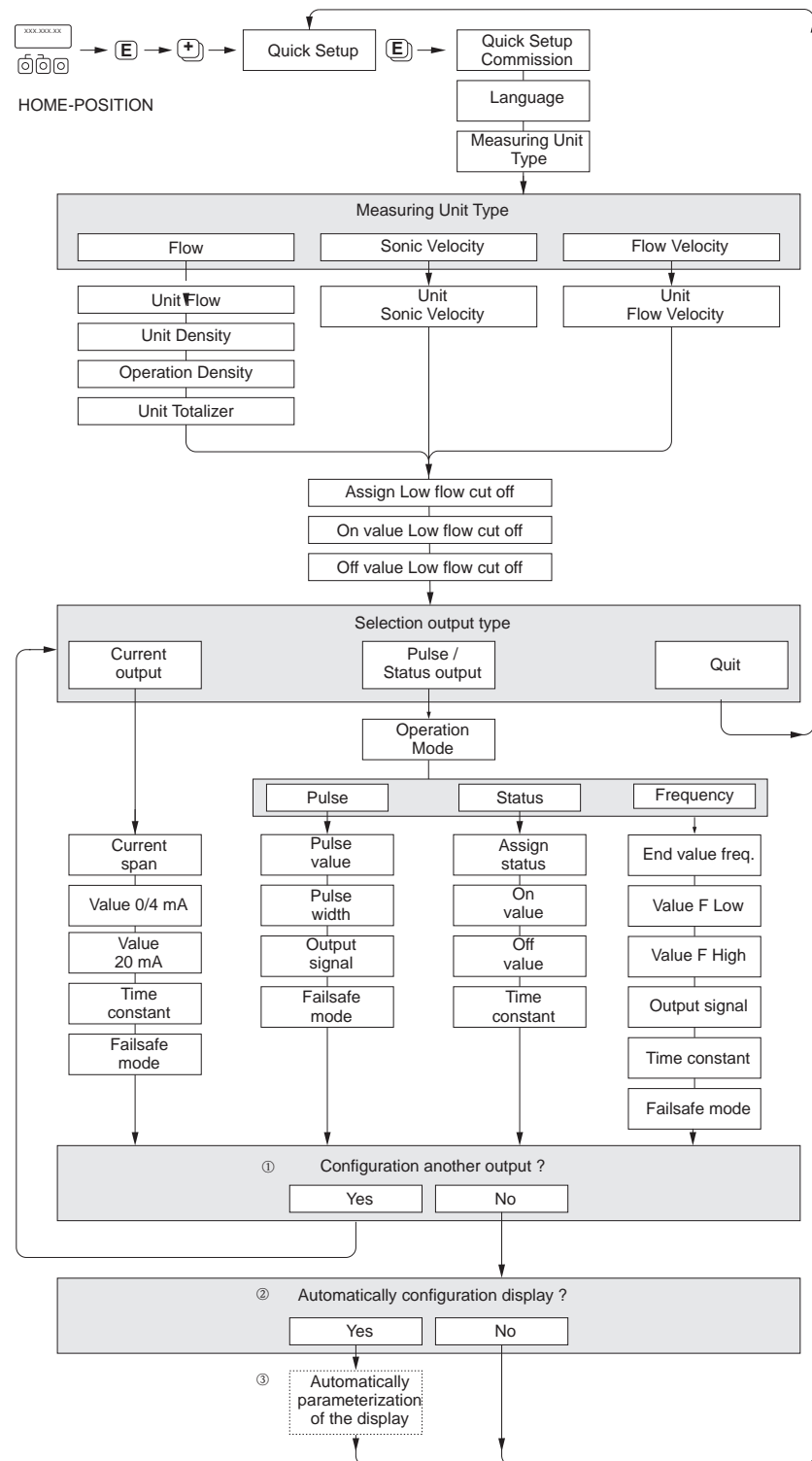



Fig. 22: "QUICK SETUP COMMISSIONING" menu for straightforward configuration of the major device functions

A0005702-en

**Note!**

The display returns to the SETUP COMMISSIONING cell if you press the  key combination during interrogation. The stored configuration remains valid.

- ① Only outputs not yet configured in the current Setup are offered for selection in each cycle.
- ② The "YES" option appears as long as a free output is still available. The next poll is started if no more outputs are available.
- ③ The "automatic parameterization of the display" option contains the following basic settings/factory settings:
 - YES:
 - Line 1 = Volume flow or calculated Mass flow
 - Line 2 = Totalizer 1
 - NO: the existing (selected) settings remain.

6.3.2 Data backup with the T-DAT SAVE/LOAD function

The T-DAT SAVE/LOAD function can be used to save all the settings and parameters of the measuring device on the HistoROM/T-DAT data storage device.

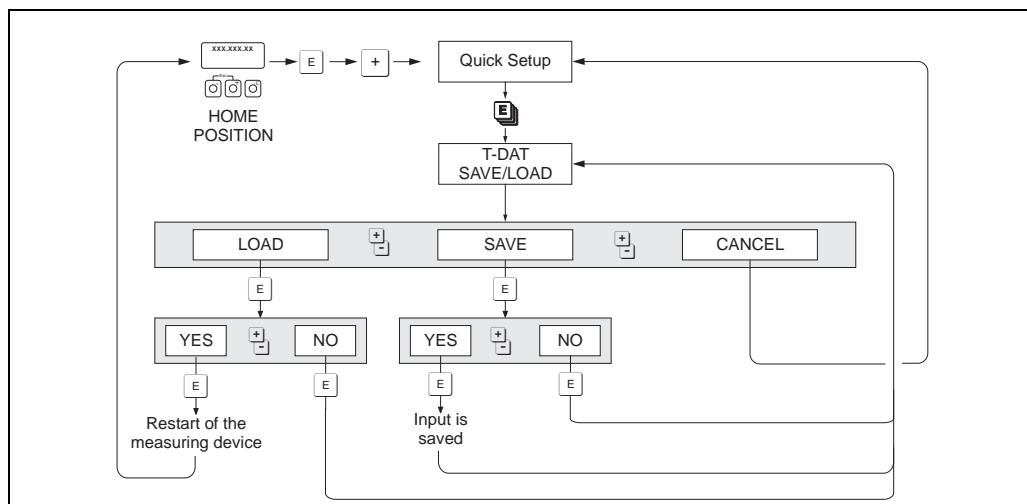

Fig. 23: Data backup with the T-DAT SAVE/LOAD function

Access to HistoROM/T-DAT functions

The T-DAT SAVE/LOAD function is accessed via the QUICK SETUP function.

- Press **[E]** until the "OS COMMISSIONING NO" prompt appears.
- Press **[E]** until "OS COMMUNICATION NO" appears.
- Press **[E]** and the "CANCEL T-DAT SAVE/LOAD" prompt appears.
- Press the key or the **[]** key and the prompt to enter the device input code appears.
- Enter the device input code and press **[E]**; programming is now enabled.
- Choose from the following options with the key or the **[]** key:
 - LOAD
Data in the HistoROM/T-DAT data storage unit are copied to the device memory (EEPROM). This overwrites any settings and parameters of the device. The measuring device is restarted.
 - SAVE
Settings and parameters are copied from the device memory (EEPROM) to the HistoROM/T-DAT.
 - CANCEL
Causes option selection to be aborted and the system to return to the higher selection level.

Application examples

- After commissioning, the current measuring point parameters can be saved to the HistoROM/T-DAT as a backup.
- If the transmitter has to be replaced for some reason, the data can be loaded from the HistoROM/T-DAT to the EEPROM of the new transmitter.

6.4 Adjust

6.4.1 Zero point adjustment

All measuring devices are calibrated with state-of-the-art technology. The zero point obtained in this way is printed on the nameplate.

Calibration takes place under reference operating conditions. → [63](#)

Consequently, the zero point adjustment is generally **not** necessary!

Experience shows that the zero point adjustment is advisable only in special cases:

- To achieve highest measuring accuracy with very small flow rates
- Under extreme process or operating conditions (e.g. very high process temperatures or very high viscosity fluids)

Preconditions for a zero point adjustment

Note the following before you perform a zero point adjustment:

- A zero point adjustment can be performed only with fluids that contain no gas or solid contents.
- Zero point adjustment is performed with the measuring tubes completely filled and at zero flow ($v = 0$ m/s). This can be achieved, for example, with shutoff valves upstream and/or downstream of the sensor or by using existing valves and gates.
 - Normal operation → valves 1 and 2 open
 - Zero point adjustment *with* pump pressure → valve 1 open / valve 2 closed
 - Zero point adjustment *without* pump pressure → valve 1 closed / valve 2 open

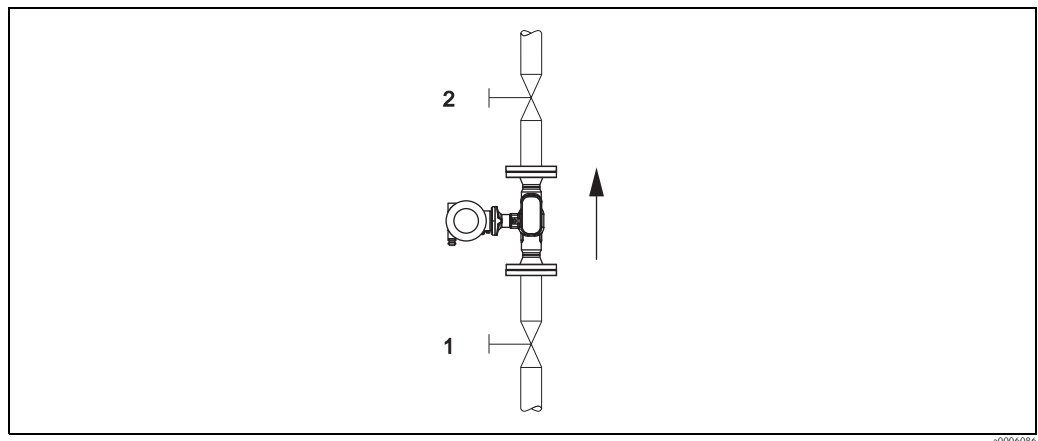

Fig. 24: Zero point adjustment and shutoff valves



Caution!

If the fluid is very difficult to measure (e.g. containing entrained solids or gas) it may prove impossible to obtain a stable zero point despite repeated zero point adjustments. In instances of this nature, please contact your Endress+Hauser service center.

Performing a zero point adjustment

1. Operate the system until operating conditions have settled.
2. Stop the flow ($v = 0$ m/s).
3. Check the shutoff valves for leaks.
4. Check that operating pressure is correct.
5. Start the zero point adjustment (functional description, see → [101](#)):
PROCESSPARAMETER → ZERO POINT ADJUSTMENT → START



Note!

The zero point value currently valid is displayed in the ZEROPOINT function → [102](#)

6.5 Data storage device (HistoROM)

At Endress+Hauser, the term HistoROM refers to various types of data storage modules on which process and measuring device data are stored. By plugging and unplugging such modules, device configurations can be duplicated onto other measuring devices to cite just one example.

6.5.1 HistoROM/T-DAT (transmitter-DAT)

The T-DAT is an exchangeable data storage device in which all transmitter parameters and settings are stored.

Storing of specific parameter settings from the EEPROM to the T-DAT and vice versa has to be carried out by the user (= manual save function). Please refer to →  41 for a description of the related function (T-DAT SAVE/LOAD) and the exact procedure for managing data.

7 Maintenance

No special maintenance work is required.

7.1 Exterior cleaning

When cleaning the exterior of measuring devices, always use cleaning agents that do not attack the surface of the housing and the seals.

7.2 Cleaning with pigs

If pigs are used for cleaning, it is essential to take the inside diameters of measuring tube and process connection into account. See also Technical Information.

8 Accessories

Various accessories, which can be ordered separately from Endress +Hauser, are available for the transmitter and the sensor. Your Endress+Hauser representative can provide detailed information on the order codes in question.

8.1 Device-specific accessories

Accessory	Description	Order code
Transmitter Proline Prosonic Flow 92	Transmitter for replacement or for stock. Use the order code to define the following specifications: <ul style="list-style-type: none"> – Approvals – Degree of protection/version – Cable entry – Display/power supply/operation – Software – Outputs/inputs 	92XXXX - XXXXX * * * * *

8.2 Measuring principle-specific accessories

Accessory	Description	Order code
Mounting kit for transmitter	Mounting kit for remote version, suitable for: <ul style="list-style-type: none"> – Wall mounting – Pipe mounting 	DK8WM - B

8.3 Communication-specific accessories

Accessory	Description	Order code
Handheld terminal HART Communicator FieldXpert	Handheld terminal for remote configuration and for obtaining measured values via the current output HART (4 to 20 mA). Contact your Endress+Hauser representative for more information.	SFX100 - * * * *
FXA195	The Commubox FXA195 connects intrinsically safe Smart transmitters with HART protocol to the USB port of a personal computer. This makes the remote operation of the transmitters possible with the aid of configuration programs (e.g. FieldCare). Power is supplied to the Commubox by means of the USB port.	FXA195 - *



8.4 Service-specific accessories

Accessory	Description	Order code
Applicator	Software for selecting and planning flowmeters. Applicator can be downloaded from the Internet or ordered on CD-ROM for installation on a local PC. Contact your Endress+Hauser representative for more information.	DKA80 – *
Fieldcheck	Tester/simulator for testing flowmeters in the field. When used in conjunction with the "ToF Tool – Fieldtool Package" software package, test results can be imported into a database, printed and used for official certification. Contact your Endress+Hauser representative for more information.	50098801
FieldCare	FieldCare is Endress+Hauser's FDT-based plant asset management tool. It can configure all intelligent field units in your system and helps you manage them. By using the status information, it is also a simple but effective way of checking their status and condition.	See the product page on the Endress+Hauser website: www.endress.com
Commubox FXA291	The Commubox FXA291 connects Endress+Hauser field devices with a CDI (= Endress+Hauser Common Data Interface) to the USB port of a computer or laptop. This makes it possible to remotely operate and execute service functions of field devices with the aid of an Endress+Hauser operating program, e.g. FieldCare software platform for plant-specific asset management.	51516983
FXA193	Service interface from the measuring device to the PC for operation via FieldCare.	FXA193 – *

9 Troubleshooting

9.1 Troubleshooting instructions

Always start troubleshooting with the following checklist if faults occur after commissioning or during operation. This takes you directly (via various queries) to the cause of the problem and the appropriate remedial measures.

Check the display	
No display visible and no output signals present	<ol style="list-style-type: none"> 1. Check the supply voltage → terminals 1, 2 2. Electronics defective → order spare part
No display visible but output signals are present	<ol style="list-style-type: none"> 1. Check whether the ribbon-cable connector of the display module is correctly plugged into the amplifier board 2. Display module defective → order spare part 3. Electronics defective → order spare part
Display texts are in a foreign language.	Switch off power supply. Press and hold down both the  keys and switch on the measuring device. The display text will appear in English (default) and is displayed at maximum contrast.
Measured value indicated, but no signal output at the current or pulse output	Electronics board defective → order spare part
▼	
Diagnosis code on the display	
<p>The measuring device is monitored during commissioning and operation. The results are shown on the display in the form of diagnosis code messages. Diagnosis code messages help the user to detect current conditions and faults and errors. In accordance with the diagnosis code displayed, it is then possible to maintain the measuring device.</p> <p>Depending on the diagnosis code, the behavior of the device can also be affected. Where permitted, the user then has the option of deactivating alarms and defining them as notice messages.</p> <p>There are 4 categories of diagnosis code messages: F, C, S, and M:</p> <p>Category F (failure): The device does not function as it should such that the measured values cannot be used. This also includes some process errors.</p> <p>Category C (function check): The device is being serviced, assembled, configured or is in the simulation mode. The output signals do not correspond to the actual process values and thus cannot be used.</p> <p>Category S (outside specification): One or more measured values (e.g. flow etc.) are outside the specified limit values that were specified at the factory or by the users themselves. Diagnosis messages of this category are also displayed during measuring device startup or during cleaning processes.</p> <p>Category M (maintenance): The measuring signals are still valid but are affected by factors such as wear, corrosion or fouling.</p> <p>The diagnosis code messages are grouped as follows within the F, C, S and M categories.</p> <p>No. 000 – 199: Messages affecting the sensor. No. 200 – 399: Messages affecting the transmitter. No. 400 – 599: Configuration-related messages (simulation, download, data storage etc.) No. 800 – 999: Process-specific messages</p>	
▼	
Other errors (without error message)	
Some other error has occurred.	Diagnosis and remedial measures →  51

9.2 Diagnosis code messages

9.2.1 Category F diagnosis code messages

Code Local display	Cause	Remedy:	Device behavior: Factory setting () = options
F 001 Device fault	Serious device error	Replace the amplifier board.	Alarm (-)
F 062 - 1 Sensor connection	Connection between "channel 1 down" sensor and transmitter interrupted.	<ul style="list-style-type: none"> ■ Check cable connection between the sensor and transmitter ■ Sensor possibly defective 	Alarm (Notice, off)
F 062 - 2 Sensor connection	Connection between "channel 1 up" sensor and transmitter interrupted.		
F 062 - 3 Sensor connection	Connection between "channel 2 down" sensor and transmitter interrupted.		
F 062 - 4 Sensor connection	Connection between "channel 2 up" sensor and transmitter interrupted.		
F 062 - 5 Sensor connection	Connection between "channel 3 down" sensor and transmitter interrupted.		
F 062 - 6 Sensor connection	Connection between "channel 3 up" sensor and transmitter interrupted.		
F 062 - 7 Sensor connection	Connection between "channel 4 down" sensor and transmitter interrupted.		
F 062 - 8 Sensor connection	Connection between "channel 4 up" sensor and transmitter interrupted.		
F 242 Incompatible software	The I/O board and the amplifier board are not compatible	Use only compatible modules and boards. Check the compatibility of the modules used.	Note (-)
F 262 Module connection	Internal communication error on the amplifier board	Replace the amplifier board.	Alarm (-)
F 282 - 1 Data storage	Amplifier: Faulty EEPROM	Replace the amplifier board.	Alarm (-)
F 282 - 2 Data storage	I/O board (COM module) Faulty EEPROM	Replace COM module.	Alarm (-)
F 282 - 3 Data storage	HistoROM/T-DAT is not plugged into the amplifier board or is defective	Order the HistoROM/T-DAT if necessary and plug it into the amplifier board or replace it.	Alarm (-)
F 283 - 1 Checksum error	Amplifier: error when accessing data of the EEPROM	Contact your Endress+Hauser service organization.	Alarm (-)
F 283 - 2 Checksum error	I/O board (COM module) Error when accessing data of the EEPROM	Contact your Endress+Hauser service organization.	Alarm (-)
F 283 - 3 Checksum error	Error accessing the values of the HistoROM/T-DAT <ul style="list-style-type: none"> ■ HistoROM/T-DAT is not plugged into the amplifier board or is defective ■ Amplifier board defective 	<ul style="list-style-type: none"> ■ Order the HistoROM/T-DAT if necessary and plug it into the amplifier board or replace it. ■ Replace the amplifier board. 	Alarm (-)
F 283 - 4 Checksum error	Totalizer checksum error	<ul style="list-style-type: none"> ■ Restart measuring device ■ Replace the amplifier board if necessary. 	Alarm (-)
F 438 Invalid Data	Data needs uploaded into transmitter	<ul style="list-style-type: none"> ■ Perform an upload Histo-RAM T/DAT 	Alarm ((Notice, off)
F 881 - 1 Sensor signal	Attenuation of acoustic measurement section for K1 is too high	<ul style="list-style-type: none"> ■ It is possible that the fluid exhibits too much attenuation ■ The measuring tube is possibly only slightly full ■ Buildup ■ Fouling ■ Solids content to high ■ Air/gas content to high 	Alarm (Notice, off)
F 881 - 2 Sensor signal	Attenuation of acoustic measurement section for K2 is too high		
F 881 - 3 Sensor signal	Attenuation of acoustic measurement section for K3 is too high		
F 881 - 4 Sensor signal	Attenuation of acoustic measurement section for K4 is too high		

9.2.2 Category C diagnosis code messages

Code Local display	Cause	Remedy:	Device behavior: Factory setting () = options
C 281 Initialization	Initialization of channel 1/2 in progress. All outputs are set to 0.	Wait until process is finished.	Note (Alarm)
C 284 Software update	New amplifier or communication module software version is being loaded to the device. Currently no other functions are possible.	Wait until process is finished. The device is restarted automatically.	Alarm (-)
C 411 Upload/download	Up- or downloading the device data via configuration program. Currently no other functions are possible.	Wait until process is finished.	Note (-)
C 412 Write backup	DAT transmitter: Data backup (download) to T-DAT failed or error when accessing (uploading) the values saved in the T-DAT.	<ul style="list-style-type: none"> ■ Check whether the T-DAT is correctly plugged into the amplifier board. ■ Replace T-DAT if defective. Before replacing a DAT, check whether the new replacement DAT is compatible with the existing electronics. ■ Replace measuring electronics boards if necessary. 	Note (-)
C 413 Read backup			Alarm (-)
C 431 – 1 Adjust	Static zero point adjustment is not possible or has been canceled.	Check that the flow velocity is = 0 m/s.	Alarm (Notice, off)
C 431 – 2 Adjust	Static zero point adjustment for channel 1 is not possible or has been canceled.		
C 431 – 3 Adjust	Static zero point adjustment for channel 2 is not possible or has been canceled.		
C 431 – 4 Adjust	Static zero point adjustment for channel 3 is not possible or has been canceled.		
C 431 – 5 Adjust	Static zero point adjustment for channel 4 is not possible or has been canceled.		
C 431 – 6 Adjust	Zero point adjustment in progress	-	Note (-)
C 453 Value suppression	Positive zero return active.	Switch off positive zero return	Note (Alarm)
C 461 – 1 Signal output	Current adjustment is active.	Quit current adjustment.	Alarm (-)
C 481 Diagnostic active	The measuring device is being checked on site via the test and simulation device.	-	Note (-)
C 482 – 1 Simulation outp.	Current output simulation active	Switch off simulation	Note (Alarm, off)
C 482 – 2 Simulation outp.	Simulation frequency output active		
C 482 – 3 Simulation outp.	Pulse output simulation active		
C 482 – 4 Simulation outp.	Status output simulation active		
C 484 Simulation error	Simulation of failsafe mode (outputs) active		
C 485 Simulation value	Measured variable simulation active (e.g. volume flow)		Note (Alarm, off)

9.2.3 Category S diagnosis code messages

Code Local display	Cause	Remedy:	Device behavior: Factory setting () = options
S 461 – 2 Signal output	Current output: The current flow is outside the set range.	<ul style="list-style-type: none"> ■ Change the upper range or lower range values entered ■ Increase or reduce flow, as applicable 	<p>Note (Alarm, off)</p>
S 461 – 3 Signal output	Frequency output: The current flow is outside the set range.		
S 461 – 4 Signal output	Pulse output: The current flow is outside the set range.		
S 823 – 1 Ambient temp.	The limit value for the minimum permissible ambient temperature is undershot.	<ul style="list-style-type: none"> ■ Check whether the device has been correctly insulated. → 13 ■ Check whether the transmitter is pointing upwards or to the side. ■ Increase the ambient temperature. 	<p>Note (Alarm, off)</p>
S 823 – 2 Ambient temp.	The limit value for the maximum permissible ambient temperature is overshoot.	<ul style="list-style-type: none"> ■ Check whether the device has been correctly insulated. → 13 ■ Check whether the transmitter is pointing downwards or to the side. ■ Reduce the ambient temperature. 	

9.3 Process errors without messages

Symptoms	Remedial measures
 Note! You may have to change or correct settings in certain functions of the function matrix in order to rectify faults. The functions outlined below, such as FLOW DAMPING etc., are described in detail in the "Description of device functions" section.	
Measured value reading fluctuates even though flow is steady.	<ol style="list-style-type: none"> 1. Check the fluid for presence of gas bubbles. 2. "FLOW DAMPING" function → increase value (→ SYSTEM PARAMETER) 3. "DISPLAY DAMPING" function → increase value (→ USER INTERFACE)
Flow values are negative, even though the fluid is flowing forwards through the pipe.	<ol style="list-style-type: none"> 1. Remote version: check wiring → 16. 2. Change the setting in the "INSTALLATION DIRECTION SENSOR" function accordingly (change sign)
The measured value display or measured value output pulsates or fluctuates, e.g. because of reciprocating pump, peristaltic pump, diaphragm pump or pump with similar conveying characteristics.	<ol style="list-style-type: none"> 1. "FLOW DAMPING" function → increase value (→ SYSTEM PARAMETER) 2. "DISPLAY DAMPING" function → increase value (→ USER INTERFACE) 3. If the problem persists despite these measures, a pulsation damper will have to be installed between the pump and the flowmeter.
Measured value reading shown on display, even though the fluid is at a standstill and the measuring tube is full.	<ol style="list-style-type: none"> 1. Check the fluid for presence of gas bubbles. 2. Activate "ON VALUE LF CUTOFF", i.e. enter or increase the value for the low flow cutoff (→ PROCESSPARAMETER).
The current output signal is always 4 mA, irrespective of the current flow signal.?	Low flow cutoff too high. Reduce corresponding value in the "LOW FLOW CUTOFF" function.
No flow signal.	<ol style="list-style-type: none"> 1. Check whether the piping is completely filled. The piping must always be completely filled for accurate and reliable flow measurement. 2. Check whether all the packaging material, including the meter body protective covers, was completely removed before mounting the device. 3. Check whether the desired electrical output signal was connected correctly.
The fault cannot be rectified or some other fault not described above has occurred. In these instances, please contact your E+H service organization.	<p>The following options are available for tackling problems of this nature:</p> <p>Request the services of an Endress+Hauser service technician If you contact our service organization to have a service technician sent out, please be ready with the following information:</p> <ul style="list-style-type: none"> – Brief description of the fault – Nameplate specifications: order code and serial number <p>Return devices to Endress+Hauser The procedures on must be carried out before you return a measuring device requiring repair or calibration to Endress+Hauser. Always enclose a fully completed "Declaration of Contamination" form with the flowmeter. A copy of the Dangerous Goods Sheet can be found at the end of these Operating Instructions.</p> <p>Replace transmitter electronics Components in the electronics defective → order spare part</p>

9.4 Response of outputs to errors



Note!

The failsafe mode of totalizers and current, pulse and frequency outputs can be configured by means of various functions in the function matrix. You will find detailed information on these procedures in the "Description of Device Functions" manual.

You can use positive zero return to set the signals of the current, pulse and status outputs to their fallback value, for example when operation has to be interrupted while a pipe is being cleaned. This function has priority over all other device functions; simulations are suppressed, for example.

Response of outputs and totalizers to errors		
	Diagnosis code messages present	Positive zero return activated
<p> Caution! Diagnosis code messages that are defined as "notice messages" have no effect whatsoever on the inputs and outputs. Please refer also to the information on</p>		
Current output 1, 2	<p>MIN. CURRENT Depends on the setting selected in the CURRENT SPAN function. If the current range is: 4 to 20 mA HART NAMUR → output current = 3.6 mA 4 to 20 mA HART US * output current = 3.75 mA</p> <p>MAX. CURRENT 22.6 mA</p> <p>ACTUAL VALUE Measured value output is based on the current flow measurement. The fault is ignored.</p>	Output signal corresponds to "zero flow"
Pulse output	<p>FALLBACK VALUE Signal output → no pulses</p> <p>ACTUAL VALUE Measured value output is based on the current flow measurement. The fault is ignored.</p>	Output signal corresponds to "zero flow"
Frequency output	<p>FALLBACK VALUE Signal output → 0 Hz</p> <p>FAILSAFE VALUE The frequency specified in the FAILSAFE VALUE function is output.</p> <p>ACTUAL VALUE Fault is ignored, i.e. normal measured value output on the basis of ongoing flow measurement.</p>	Output signal corresponds to "zero flow"
Totalizer	<p>STOP The totalizer stops at the last value before the alarm condition occurred.</p> <p>ACTUAL VALUE The totalizer continues to count the flow on the basis of the last valid flow data (before the fault occurred).</p>	Totalizer stops
Status output	In the event of fault or power supply failure: status output → non-conductive	No effect on the status output

9.5 Spare parts

The previous sections contain a detailed troubleshooting guide. → [47](#)

The measuring device, moreover, provides additional support in the form of continuous self-diagnosis and error messages.

Troubleshooting can entail replacing defective components with tested spare parts. The illustration below shows the available scope of spare parts.



Note!

You can order spare parts directly from your Endress+Hauser service organization by providing the serial number printed on the transmitter's nameplate.

Spare parts are shipped as sets comprising the following parts:

- Spare part
- Additional parts, small items (screws, etc.)
- Installation instructions
- Packaging

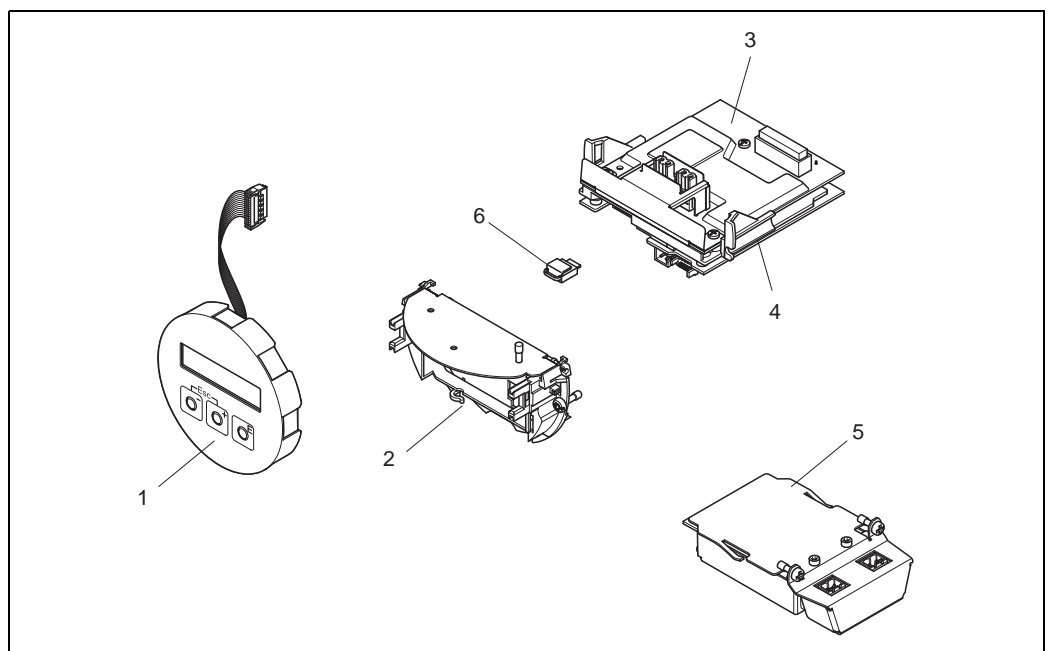

a0005950

Fig. 25: Spare parts for transmitter

- 1 Local display module
- 2 Board holder
- 3 I/O board (COM module), non-Ex/Ex i version
- 4 Amplifier board
- 5 I/O board (COM module), Ex d version
- 6 Histo-ROM/T-DAT data storage device

9.5.1 Installing and removing electronics boards

Non-Ex/Ex-i version



Warning!

- Risk of damaging electronic components (ESD protection). Static electricity can damage electronic components or impair their operability. Use a workplace with a grounded working surface, purpose-built for electrostatically sensitive devices!
- When connecting Ex-certified devices, see the notes and diagrams in the Ex-specific supplement to these Operating Instructions.



Caution!

Use only genuine Endress+Hauser parts.

Procedure when installing/removing electronics boards →  26:

1. Unscrew the cover (1) of the electronics compartment from the transmitter housing.
2. Remove the display module (2) from the retaining rails (3) and refit onto right retaining rail with the left side (this secures the display module).
3. Loosen the fixing screw (4) of the cover of the connection compartment (5) and fold down the cover.
4. Disconnect terminal connector (6) from the I/O board (COM module).
5. Fold up the plastic cover (7).
6. Remove the signal cable connector (8) from the amplifier board.
7. Remove the ribbon-cable connector (9) from the amplifier board and release from the cable holder (10).
8. Remove the display module (2) from the retaining rail (3) and put it to the side.
9. Fold down the plastic cover (7) again.
10. Release both screws (11) of the board holder (12).
11. Pull the board holder (12) out completely.
12. Press the side latches (13) of the board holder (12) and separate the board holder (12) from the board body (14).
13. Replace the I/O board (COM module) (16):
 - Loosen the three fixing screws (15) of the I/O board (COM module).
 - Remove the I/O board (COM module) (16) from the board body (14).
 - Set a new I/O board (COM module) on the board body and screw tight.
14. Replace the amplifier board (18):
 - Loosen the fixing screws (17) of the amplifier board.
 - Remove the amplifier board (18) from the board body (14).
 - Set the new amplifier board onto board body and screw tight.
15. Installation is the reverse of the removal procedure.

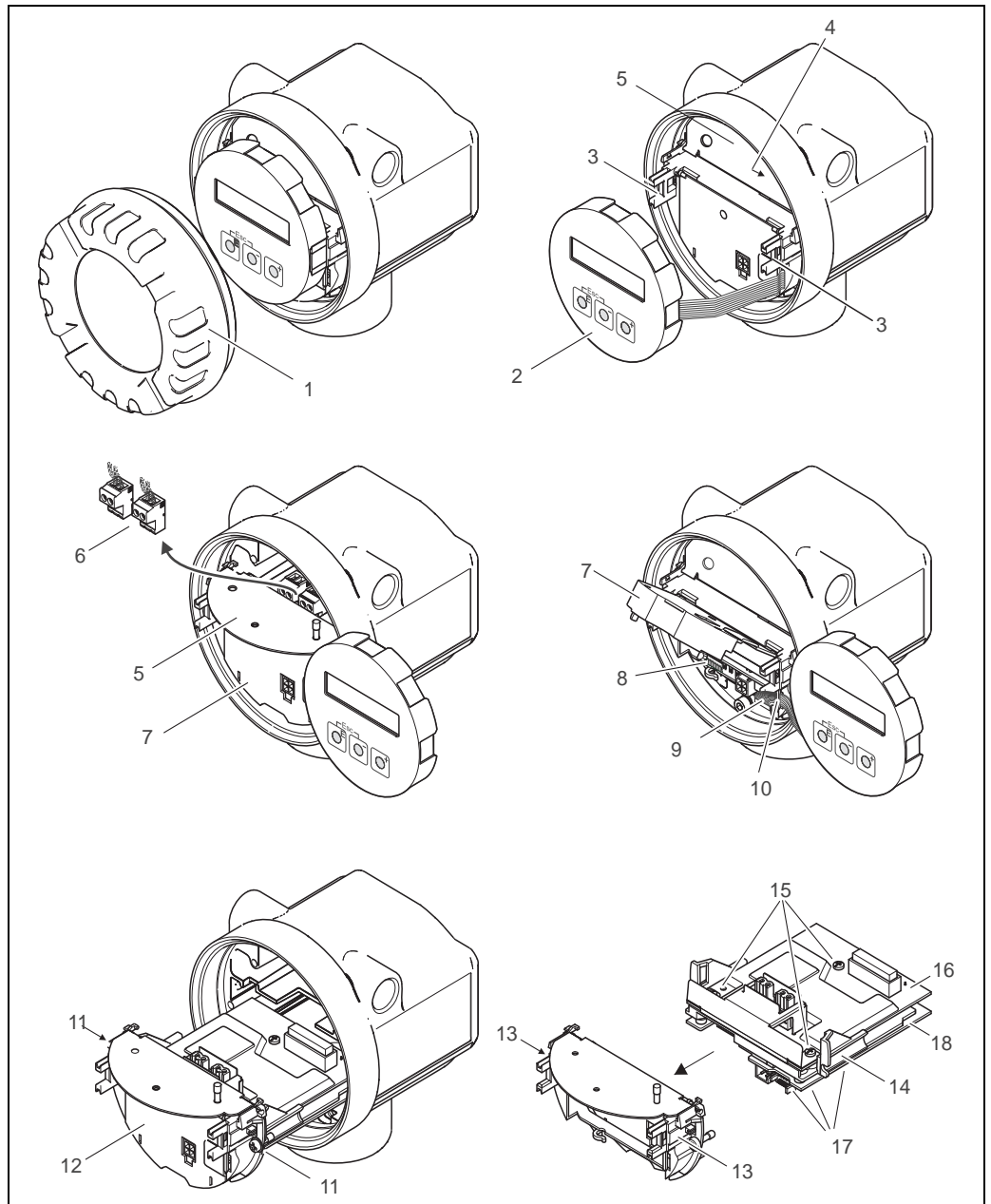

Fig. 26: Installing and removing electronics boards, non-Ex/Ex-i version

- 1 Electronics compartment cover
- 2 Display module
- 3 Display module retaining rails
- 4 Fixing screws for cover of connection compartment
- 5 Connection compartment
- 6 Terminal connector
- 7 Plastic cover
- 8 Signal cable connector
- 9 Ribbon cable retainer
- 10 Display module ribbon-cable connector
- 11 Board holder threaded connection
- 12 Board holder
- 13 Board holder latches
- 14 Board body
- 15 I/O board (COM module) threaded connection
- 16 I/O board (COM module)
- 17 Amplifier board threaded connection
- 18 Amplifier board

Ex-d version**Warning!**

- Risk of damaging electronic components (ESD protection). Static electricity can damage electronic components or impair their operability. Use a workplace with a grounded working surface, purpose-built for electrostatically sensitive devices!
- When connecting Ex-certified devices, see the notes and diagrams in the Ex-specific supplement to these Operating Instructions.

**Caution!**

Use only genuine Endress+Hauser parts.

Procedure when installing/removing electronics boards →  27:

Installing/removing the I/O board (COM module)

1. Release securing clamp (1) of the connection compartment cover (2).
2. Unscrew the connection compartment cover (2) from the transmitter housing.
3. Disconnect terminal connector (3) from the I/O board (COM module) (5).
4. Release the threaded joint (4) of the I/O board (COM module) (5) and pull it out slightly.
5. Disconnect the connecting cable connector (6) from the I/O board (COM module) (5).
6. Completely remove the I/O board (COM module) (5).
7. Installation is the reverse of the removal procedure.

Installing/removing the amplifier board

1. Unscrew the cover (7) of the electronics compartment from the transmitter housing.
2. Remove the display module (8) from the retaining rails (7) and refit onto right retaining rail with the left side (this secures the display module).
3. Fold up the plastic cover (10).
4. Remove the ribbon-cable connector of the display module (8) from the amplifier board and release from the cable holder.
5. Remove the signal cable connector (11) from the amplifier board.
6. Release the fixing screw (12) and fold down the cover (13).
7. Release both screws (14) of the board holder (15).
8. Pull out the board holder (15) slightly and disconnect connecting cable connector (16) from the board body.
9. Pull the board holder (15) out completely.
10. Press the side latches (17) of the board holder and separate the board holder (15) from the board body (18).
11. Replace the amplifier board (20):
 - Loosen the fixing screws (19) of the amplifier board.
 - Remove the amplifier board (20) from the board body (18).
 - Set the new amplifier board onto board body and screw tight.
12. Exchange Histo-ROM/T-DAT:
 - Perform a T-DAT upload after successful installation
13. Installation is the reverse of the removal procedure.

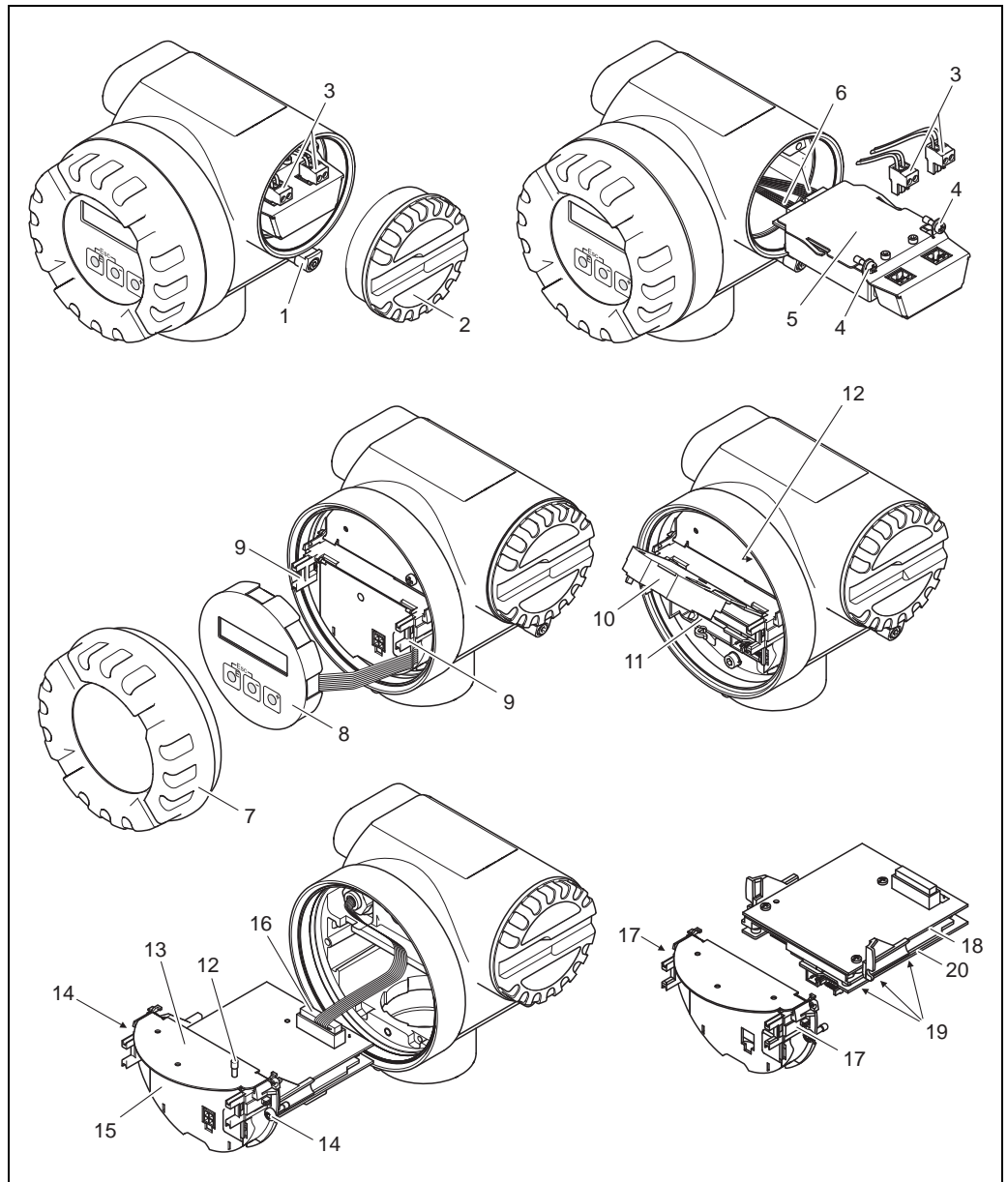

a0005956

Fig. 27: Installing and removing electronics boards Ex d version

- 1 Clamp for cover of connection compartment
- 2 Cover of connection compartment
- 3 Terminal connector
- 4 I/O board (COM module) threaded connection
- 5 I/O board (COM module)
- 6 Connecting cable connector, I/O board
- 7 Electronics compartment cover
- 8 Display module
- 9 Display module retaining rails
- 10 Plastic cover
- 11 Signal cable connector
- 12 Fixing screws for cover of connection compartment
- 13 Connection compartment cover
- 14 Board holder threaded connection
- 15 Board holder
- 16 Connecting cable connector
- 17 Board holder latches
- 18 Board body
- 19 Amplifier board threaded connection
- 20 Amplifier board

9.6 Return



Caution!

Do not return a measuring device if you are not absolutely certain that all traces of hazardous substances have been removed, e.g. substances which have penetrated crevices or diffused through plastic.

Costs incurred for waste disposal and injury (burns, etc.) due to inadequate cleaning will be charged to the owner-operator.

The following steps must be taken before returning a flow measuring device to Endress+Hauser, e.g. for repair or calibration:

- Always enclose a duly completed "Declaration of contamination" form. Only then can Endress+Hauser transport, examine and repair a returned device.
- Enclose special handling instructions if necessary, for example a safety data sheet as per EC REACH Regulation No. 1907/2006.
- Remove all residues. Pay special attention to the grooves for seals and crevices which could contain residues. This is particularly important if the substance is hazardous to health, e.g. flammable, toxic, caustic, carcinogenic, etc..



Note!

You will find a preprinted "Declaration of contamination" form at the back of these Operating Instructions.

9.7 Disposal

Observe the regulations applicable in your country!

9.8 Software history



Note!

Upload/download between different software versions is normally only possible with special service software.

Date	Software version	Changes to software	Operating Instructions
11.2010	Amplifier: V 1.01.01	Softwareerweiterung – Size DN150–300	71124139/13.10
05.2006	Amplifier: V 1.00.00	Original software can be operated using: – FieldCare – ToF Tool - Fieldtool Package – HART-Communicator DRX 375	71028166/06.06

10 Technical data

10.1 Technical data at a glance

10.1.1 Application

→ 5

10.1.2 Function and system design

Measuring principle Prosonic Flow operates on the principle of transit time difference.

Measuring system → 7

10.1.3 Input

Measured variable Flow velocity (transit time difference proportional to flow velocity)

Measuring range *Measuring ranges for liquids*

Typically $v = -10$ to 10 m/s (-32 to 32 ft/s) with the specified accuracy

Nominal diameter		Range for full scale values (liquids) $m_{\min(F)}$ to $m_{\max(F)}$	
25	1"	0 to 300 dm ³ /min	0 to 80 gal/min
40	1½"	0 to 750 dm ³ /min	0 to 200 gal/min
50	2"	0 to 1100 dm ³ /min	0 to 300 gal/min
80	3"	0 to 3000 dm ³ /min	0 to 800 gal/min
100	4"	0 to 4700 dm ³ /min	0 to 1250 gal/min
150	6"	0 to 10 m ³ /min	0 to 2800 gal/min
200	8"	0 to 20 m ³ /min	0 to 5280 gal/min
250	10"	0 to 30 m ³ /min	0 to 7930 gal/min
300	12"	0 to 40 m ³ /min	0 to 10570 gal/min

10.1.4 Output

Outputs in general

The following measured variables can generally be output via the outputs:

	Current output	Freq. output	Pulse output	Status output
Volume flow	X	X	X	Limit value
Calculated Mass flow	X	X	X	Limit value
Sound velocity	X	X	–	Limit value
Flow velocity	X	X	–	Limit value
Signal strength	X	X	–	Limit value

Output signal

Current output:

Current output:

- 4 to 20 mA with HART
- Full scale value and time constant (0 to 100 s) can be set

Pulse/status output/Frequency output:

Open collector, passive, galvanically isolated

- Non-Ex, Ex d - version:
U_{max} = 35 V, with 15 mA current limiting, R_i = 500
- Ex i version:
U_{max} = 30 V, with 15 mA current limiting, R_i = 500

The pulse/status output can be configured as:

- Pulse output:
 - Pulse value and pulse polarity can be selected,
 - Pulse width can be configured (0.005 to 2s)
 - Pulse frequency max. 100 Hz
- Status output:
 - Can be configured for diagnosis code messages or flow limit values
- Frequency output:
 - End frequency 0 to 1000 Hz (f_{max} = 1250 Hz)

Signal on alarm

Current output:

Failsafe mode can be selected (e.g. in accordance with NAMUR recommendation NE 43)

Status output:

"Not conductive" in the event of a fault or power supply failure

Load

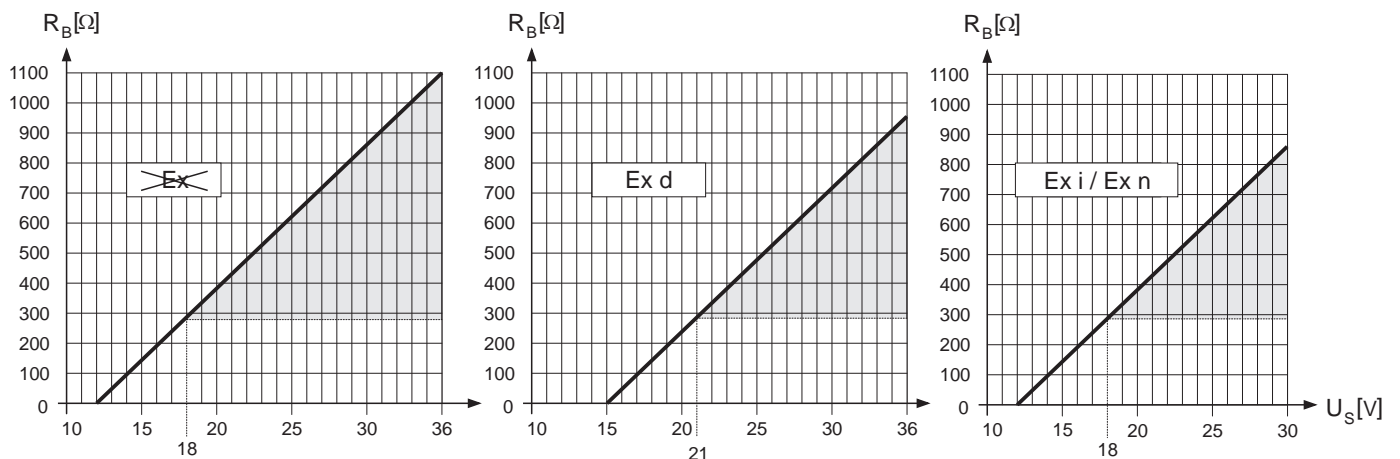

Fig. 28: Behavior of load and supply voltage

The area marked in gray indicates the permissible load (with HART: min. 250 .)
 The load is calculated as follows:

$$R_B = \frac{(U_S - U_{kl})}{(I_{max} - 10^{-3})} = \frac{(U_S - U_{kl})}{0.022}$$

R_B Load, load resistance

U_S Supply voltage:

- Non-Ex = 12 to 35 V DC
- Ex d = 15 to 35 V DC
- Ex i = 12 to 30 V DC

U_{kl} Terminal voltage:

- Non-Ex = min. 12 V DC
- Ex d = min. 15 V DC
- Ex i = min. 12 V DC

I_{max} Output current (22.6 mA)

Low flow cutoff

Switch points for low flow cutoff can be selected as required.

Galvanic isolation

All circuits for inputs, outputs, and power supply are galvanically isolated from each other.

10.1.5 Power supply

Electrical connections → Page 17 ff.

Supply voltage Non-Ex: 12 to 35 V DC (with HART: 18 to 35 V DC)
 Ex i: 12 to 30 V DC (with HART 18 to 30 V DC)
 Ex d: 15 to 35 V DC (with HART: 21 to 35 V DC)

Cable entry *Power supply and signal cables (inputs/outputs):*
 ■ Cable entry M20 × 1.5 (8 to 12 mm) (0.32" to 0.47")
 ■ Thread for cable entries, 1/2" NPT, G 1/2" (not for threaded version)

Cable specifications ■ Use a connecting cable with a continuous service temperature range of at least:
 –40 °C to (permitted max. ambient temperature plus 10 °C) or
 –40 °F to (permitted max. ambient temperature plus 18 °F).
 ■ Remote version connecting cable → Page 16

Power supply failure ■ Totalizer stops at the last value determined (can be configured).
 ■ All settings are kept in the T-DAT.
 ■ Diagnosis code messages (incl. value of operated hours counter) are stored.

10.1.6 Performance characteristics

Reference operating conditions *Error limits following ISO/DIS 11631:*
 ■ 20 to 30 °C (68 to 86 °F); 2 to 4 bar (30 to 60 psi)
 ■ Calibration systems as per national norms
 ■ Zero point calibrated under operating conditions

Maximum measured error

DN 25 to DN300 (1" to 12")

0.5 to 10 m/s (1.6 to 32.8 ft/s)	±0.5% o.r.*
----------------------------------	-------------

optional for DN 80 to DN300 (3" to 12")

0.5 to 10 m/s (1.6 to 32.8 ft/s)	±0.3% o.r.*
----------------------------------	-------------

o.r. = of reading

* for a Reynolds number >10000

Repeatability ±0.2% of reading

10.1.7 Operating conditions: Installation

Installation instructions → 11

Length of connecting cable → 16

10.1.8 Operating conditions: Environment

Ambient temperature range	<p><i>Compact version</i></p> <ul style="list-style-type: none"> ■ Standard: -40 to +60 °C (-40 to +140 °F) ■ EEx-d / EEx-i version: -40 to +60 °C (-40 to +140 °F) <p>Display can be read between -20 °C and +70 °C (-4 to +158 °F)</p> <p><i>Remote version</i></p> <ul style="list-style-type: none"> ■ Sensor: <ul style="list-style-type: none"> - Standard: -40 to +80 °C (-40 to +176 °F) - EEx-d / EEx-i version: -40 to +80 °C (-40 to +176 °F) ■ Transmitter: <ul style="list-style-type: none"> - Standard: -40 to +60 °C (-40 to +140 °F) - EEx-i version: -40 to +60 °C (-40 to +140 °F) - EEx-d version: -40 to +60 °C (-40 to +140 °F) <p>Display can be read between -20 °C and +70 °C (-4 to +158 °F)</p>
	<p>Note!</p> <p>When mounting outside, we recommend you protect from direct sunlight with a protective cover (order number 543199), especially in warmer climates with high ambient temperatures.</p>
Storage temperature	<p>Standard: -40 to +80 °C (-40 to +176 °F)</p> <p>EEx-d / EEx-i version: -40 to +80 °C (-40 to +176 °F)</p>
Degree of protection	<ul style="list-style-type: none"> ■ Prosonic Flow 92 transmitter: IP 67 (NEMA 4X) ■ Prosonic Flow F Inline sensor: IP 67 (NEMA 4X) Optional: IP 68 (NEMA 6P)
Shock resistance	In accordance with IEC 68-2-31
Vibration resistance	Acceleration up to 1 g by analogy with IEC 68-2-6
Electromagnetic compatibility (EMC)	To IEC/EN 1326 and NAMUR recommendation NE 21

10.1.9 Operating conditions: Process

Fluid Temperature Range

DN	DN 25 to 100 (1 to 4")	DN 150 to 300 (6 to 12")		
		ASME & AD2000	ASME	AD2000
Standard	ASME & AD2000	ASME & AD2000	ASME	AD2000
Version	Stainless steel	Stainless steel	Carbon steel	Carbon steel
Standard	-40 to 150 °C (-40 to 302 °F)	-40 to 150 °C (-40 to 302 °F)	-29 to 130 °C* (-84 to 266 °F)	-10 to 130 °C (-14 to 266 °F)
Optional	-40 to 200 °C (-40 to 392 °F)	-40 to 200 °C (-40 to 392 °F)	-29 to 200 °C* (-20 to 392 °F)	-10 to 200 °C (-14 to 392 °F)

*For PED device minimum temperature is -10 °C

Limiting medium pressure range (rated pressure)

The material load diagrams (pressure-temperature diagrams) for the process connections can be found in the separate "Technical Information" documentation on the device in question which you can download in PDF format at www.endress.com.
A list of the "Technical Information" available can be found on → [67](#).

Limiting flow

Refer to "Measuring range" on → [59](#).

Pressure loss

Pressure loss is negligible if the sensor is installed in a pipe of the same nominal diameter.

10.1.10 Mechanical construction

Design, dimensions

The dimensions and lengths of the sensor and transmitter can be found in the separate "Technical Information" documentation on the device in question which you can download in PDF format at www.endress.com.
A list of the "Technical Information" available can be found on → [67](#).

Weight (SI units)

DN	Weight [kg]						
	Compact version			Remote version (without a cable)			
				Sensor			Transmitter
	EN	JIS	ASME	EN	JIS	ASME	
25	10	10	10	8	8	8	6.0
40	12	13	12	11	11	10	6.0
50	14	15	13	12	13	11	6.0
80	24	28	28	22	26	26	6.0
100	35	44	44	32	42	42	6.0
150	54	–	57	48	–	51	6.0
200	92	–	83	86	–	77	6.0
250	131	–	118	125	–	112	6.0
300	174	–	165	168	–	159	6.0

Weight (US units)

DN (inch)	Weight [lbs]						
	Compact version			Remote version (without a cable)			
				Sensor			Transmitter
	EN	JIS	ANSI	EN	JIS	ANSI	
1"	22	22	22	18	18	18	13.0
1 ½"	26	29	26	24	24	22	13.0
2"	31	33	29	26	29	24	13.0
3"	53	62	62	49	57	57	13.0
4"	77	97	97	71	93	93	13.0
6"	119	–	125	113	–	119	13.0
8"	202	–	183	196	–	177	13.0
10"	288	–	260	282	–	254	13.0
12"	383	–	363	377	–	357	13.0

Material

	DN25 to 100	DN150 to 300		
Standard	ASME & AD2000	ASME & AD2000	ASME	AD2000
Meter body	A351-CF3M	1.4404+TP316+TP316L	A106 Grd. B	A106 Grd. B
Sensor	1.4404+316L+316	1.4462 1.4404+316L+316	1.4462 1.4404+316L+316	1.4462 1.4404+316L+316
Flanges	1.4404+F316+F316L	1.4404+F316+F316L	A105+1.0432	1.0426

Designed for NACE MR0175/ISO 15156 and NACE MR0103
It is the equipment user's responsibility to select the materials suitable for the intended services.

Carbon steel with outer protective painting to 130 °C (266 °F) or optional 200 °C (392 °F)

Material load diagram

The material load diagrams (pressure-temperature diagrams) for the process connections can be found in the separate "Technical Information" documentation on the device in question which you can download in PDF format at www.endress.com.
A list of the "Technical Information" available can be found on Page 67.

10.1.11 Human interface

Display elements	<ul style="list-style-type: none"> ■ Liquid crystal display: two lines with 16 characters per line ■ Selectable display of different measured values and status variables ■ At ambient temperatures below -20 °C (-68 °F) the readability of the display may be impaired
Operating elements	<ul style="list-style-type: none"> ■ Local operation with three keys (-, +, E) ■ Quick Setup menus for quick commissioning ■ Operating elements accessible also in Ex zones
Remote operation	Remote operation via: <ul style="list-style-type: none"> ■ HART ■ FieldCare

10.1.12 Certificates and approvals

CE mark	The measuring system is in conformity with the statutory requirements of the EC Directives. Endress+Hauser confirms successful testing of the device by affixing to it the CE mark.
C-tick mark	The measuring system complies with the EMC requirements of the Australian Communications and Media Authority (ACMA).
Ex approval	Information about currently available Ex versions (ATEX, FM, CSA) can be supplied by your Endress+Hauser sales organization. All explosion protection data are given in a separate documentation which is available upon request.
Pressure equipment Directive	<p>The measuring devices can be ordered with or without PED (Pressure Equipment Directive). If a device with PED is required, this must be ordered explicitly. For devices with nominal diameters less than or equal to DN 25 (1"), this is neither possible nor necessary.</p> <ul style="list-style-type: none"> ■ With the identification PED/G1/III on the sensor nameplate, Endress+Hauser confirms conformity with the "Basic safety requirements" of Appendix I of the Pressure Equipment Directive 97/23/EC. ■ Devices with this identification (with PED) are suitable for the following types of fluid: <ul style="list-style-type: none"> - Fluids of Group 1 and 2 with a steam pressure of greater or less than 0.5 bar (7.3 psi) - Unstable gases ■ .Devices without this identification (without PED) are designed and manufactured according to good engineering practice. They correspond to the requirements of Art. 3, Section 3 of the Pressure Equipment Directive 97/23/EC. Their application is illustrated in Diagrams 6 to 9 in Appendix II of the Pressure Equipment Directive 97/23/EC.

Other standards and guidelines

- EN 60529
Degrees of protection by housing (IP code)
- EN 61010-1
Protection Measures for Electrical Equipment for Measurement, Control, Regulation and Laboratory Procedures.
- IEC/EN 1326
"Emission in accordance with requirements for Class A"
Electromagnetic compatibility (EMC requirements).
- NAMUR NE 21
Electromagnetic compatibility (EMC) of industrial process and laboratory control equipment.
- NAMUR NE 43
Standardization of the signal level for the breakdown information of digital transmitters with analog output signal.
- ANSI/ISA-S.61010-1(82.02.01) CSA-C22.2 No. 1010.1 ANSI/UL 61010-1
Safety Requirements for Electrical Equipment for Measurement and Control and Laboratory Use
Pollution degree 2
- NACE Standard MR0103
Standard Material Requirements - Materials Resistant to Sulfide Stress Cracking in Corrosive Petroleum Refining Environments
- NACE Standard MR0175
Standard Material Requirements - Sulfide Stress Cracking Resistant Metallic Materials for Oilfield Equipment

10.1.13 Ordering information

Your Endress +Hauser service organization can provide detailed ordering information and information on the order codes on request.

10.1.14 Accessories

Various accessories, which can be ordered separately from Endress +Hauser, are available for the transmitter and the sensor → Page 45.

10.1.15 Documentation

- Flow measuring technology (FA005D/06/en)
- Technical Information, Prosonic Flow 92F (TI072D/06/en)
- Supplementary documentation on Ex-ratings: ATEX, FM, CSA



11 Description of device functions

11.1 Illustration of the function matrix



Groups / function groups		Functions				
MEASURED VALUES →	→ 70	→	FLOW	SOUND VELOCITY	FLOW VELOCITY	SIGNAL STRENGTH
↓						
SYSTEM UNITS →	→ 71	→	MEASURING UNITS	UNIT FLOW	UNIT VOLUME	UNIT MASS
↓			UNIT DENSITY	UNIT LENGTH	UNIT VELOCITY	FORMAT DATE/TIME
QUICK SETUP →	→ 75	→	QUICK SETUP COMMISSIONING	T-DAT SAVE/LOAD		
↓						
OPERATION →	→ 76	→	LANGUAGE	ACCESS CODE	DEFINE PRIVATE CODE	STATUS ACCESS
↓			ACCESS CODE COUNTER			
USER INTERFACE →	→ 77	→	ASSIGN LINE 1	ASSIGN LINE 2	100% VALUE LINE 1	100% VALUE LINE 2
↓			FORMAT	DISPLAY DAMPING	CONTRAST LCD	TEST DISPLAY
TOTALIZER →	TOTALIZER 1 (2) → 79	→	ASSIGN TOTALIZER	SUM	OVERFLOW	UNIT TOTALIZER
↓			TOTALIZER MODE	RESET TOTAL.		
↓	HANDLING TOTAL. → 81	→	RESET ALL TOTALIZERS	FAILSAFE ALL TOTALIZERS		
CURRENT OUTPUT →	→ 82	→	ASSIGN CURRENT OUTPUT	CURRENT SPAN	VALUE 4 mA	VALUE 20 mA
↓			TIME CONSTANT	FAILSAFE MODE	ACTUAL CURRENT	SIMULATION CURRENT
↓			VALUE SIMULATION CURRENT			
PUL., FREQ., STATUS →	→ 85	→	OPERATION MODE	ASSIGN FREQUENCY	START VALUE FREQUENCY	END VALUE FREQUENCY
↓			VALUE-f LOW	VALUE-f HIGH	OUTPUT SIGNAL	TIME CONSTANT
↓			FAILSAFE MODE	FAILSAFE VALUE	ACTUAL FREQUENCY	SIMULATION FREQUENCY
↓			VALUE SIMULATION FREQUENCY	ASSIGN PULSE	PULSE VALUE	PULSE WIDTH
↓			OUTPUT SIGNAL	FAILSAFE MODE	ACTUAL PULSE	SIMULATION PULSE
↓			VALUE SIMULATION PULSE	ASSIGN STATUS	SWITCH-ON POINT	OFF VALUE
↓			TIME CONSTANT	ACTUAL STATUS OUTPUT	SIMULATION SWITCHPOINT	VALUE SIMULATION SWITCHPOINT



Groups / function groups			Functions				
COMMUNICATION	→	→ 100	→	TAG NAME	TAG DESCRIPTION	FIELDBUS ADDRESS	WRITE PROTECTION
				MANUFACTURER ID	DEVICE ID	DEVICE REVISION	
PROCESS PARAMETER	→	→ 101	→	ASSIGN LOW FLOW CUTOFF	ON VALUE LOW FLOW CUTOFF	OFF VALUE LOW FLOW CUTOFF	ZERO POINT ADJUST
				FIXED OPERATION DENSITY			
SYSTEM PARAMETER	→	→ 103	→	INSTALLATION DIRECTION SENSOR	FLOW DAMPING	POSITIVE ZERO RETURN	MEASURING MODE
SENSOR DATA	→	→ 104	→	CALIBRATION DATE	CALIBRATION FACTOR	ZEROPOINT	ZEROPOINT STATIC
				CORRECTION FACTOR	CABLE LENGTH	CABLE LENGTH VARIABLE	
SUPERVISION	→	→ 106	→	ACTUAL SYSTEM CONDITION	PREVIOUS SYSTEM CONDITIONS	ASSIGN DIAGNOSTIC CODE	ERROR CATEGORY
				ALARM DELAY	TROUBLESHOOTING	SYSTEM RESET	OPERATION HOURS
SIMULAT. SYSTEM	→	→ 108	→	SIMULATION FAILSAFE MODE	SIMULATION MEASURAND	VALUE SIMULATION MEASURAND	
SENSOR VERSION	→	→ 108	→	SERIAL NUMBER			
AMP. VERSION	→	→ 108	→	DEVICE SOFTWARE	I/O TYPE		



11.2 Group MEASURING VALUES

Function description, MEASURING VALUES group	
FLOW	<p>The flow currently measured appears on the display.</p> <p>Display: 5-digit floating-point number, including unit (e.g. 5.545 dm³/m; 731.63 gal/d etc.)</p> <p> Note! The appropriate unit is taken from the UNIT FLOW function. → Page 71</p>
SOUND VELOCITY	<p>The sound velocity currently measured in the liquid appears on the display.</p> <p>Display: 5-digit fixed-point number, incl. unit (e.g. 1400.0 m/s, 5249.3 ft/s)</p> <p> Note! The appropriate unit is taken from the UNIT VELOCITY function. → Page 74</p>
FLOW VELOCITY	<p>The flow velocity currently measured appears on the display.</p> <p>Display: 5-digit floating-point number, including unit and sign (e.g. 8.0000 m/s, 26.247 ft/s)</p> <p>The appropriate unit is taken from the UNIT VELOCITY function. → Page 74</p>
SIGNAL STRENGTH	<p>The signal strength appears on the display.</p> <p>Display: 4-digit fixed point number, incl. unit (e.g. 80.0) dB</p> <p> Note! To ensure reliable measurement takes place, Prosonic Flow requires a signal strength of > 50 dB.</p>

11.3 Group SYSTEM UNITS





Function description, SYSTEM UNITS group	
MEASURING UNITS	<p>Description Use this function to select the desired type of unit which the measuring device should use to output the flow.</p> <p>Unit types:</p> <ul style="list-style-type: none"> ■ Volumetric flow (volume flow) Is measured by the measuring device. No other calculation takes place. ■ Calculated mass flow Is calculated using the measured volume flow and the value entered in the FIXED OPERATION DENSITY function (→  102). <p> Note! The "calculated mass flow" unit types are calculated with fixed values for FIXED OPERATION DENSITY.</p> <ul style="list-style-type: none"> ■ If the process conditions are known and do not change, select these two types of unit. ■ If the process conditions are not known or if the process conditions could change, we recommend you use a flow computer (e.g. Compart DXF351 or RMC621). Even when the process conditions change, these flow computers can calculate the flow correctly by means of pressure and temperature compensation. <p>Options VOLUME FLOW CALCULATED MASS FLOW</p> <p>Factory setting See the parameter printout provided. The parameter printout is an integral part of these Operating Instructions.</p> <p> Note! If the type of unit is changed, you are asked whether the totalizer should be reset to 0. This message has to be confirmed before the measuring device accepts the new type of unit; otherwise the measuring device continues to use the type of unit previously active.</p>

Function description, SYSTEM UNITS group	
UNIT FLOW	<p>Description</p> <p>For selecting the unit required and displayed for the flow. Depending on what is selected in the MEASURING UNIT TYPE (→  71) function, only the associated units (volume, or calculated mass flow) are displayed here.</p> <p>The unit you select here is also valid for:</p> <ul style="list-style-type: none"> ■ Flow display ■ Current output (value 20 mA) ■ Pulse/status output (pulse value; on-value/off-value) ■ On-value low flow cut off ■ Simulation measurand <p> Note!</p> <p>The unit for the totalizer is independent of the option selected here; it is selected in the UNIT TOTALIZER function (→  80).</p> <p>The following time units can be selected: s = second, m = minute, h = hour, d = day</p> <p>Options (MEASURING UNITS function = VOLUME FLOW)</p> <p>Metric:</p> <p>Cubic centimeter → cm³/time unit Cubic decimeter → dm³/time unit Cubic meter → m³/time unit Milliliter → ml/time unit Liter → l/time unit Hectoliter → hl/time unit Megaliter → Ml/time unit MEGA</p> <p>US:</p> <p>Cubic centimeter → cc/time unit Acre foot → af/time unit Cubic foot → ft³/time unit Fluid ounce → ozf/time unit Gallon → US gal/time unit Mega gallon → US Mgal/time unit Barrel (normal fluids: 31.5 gal/bbl) → US bbl/time unit NORM. Barrel (beer: 31.0 gal/bbl) → US bbl/time unit BEER Barrel (petrochemicals: 42.0 gal/bbl) → US bbl/time unit PETR. Barrel (filling tanks: 55.0 gal/bbl) → US bbl/time unit TANK</p> <p>Imperial:</p> <p>Gallon → imp. gal/time unit Mega gallon → imp. Mgal/time unit Barrel (beer: 36.0 gal/bbl) → imp. bbl/time unit BEER Barrel (petrochemicals: 34.97 gal/bbl) → imp. bbl/time unit PETR.</p> <p>Factory setting</p> <p>See the parameter printout provided. The parameter printout is an integral part of these Operating Instructions.</p> <p>Options (MEASURING UNITS function = CALCULATED MASS FLOW)</p> <p>Metric:</p> <p>Gram → g/time unit Kilogram → kg/time unit Metric ton → t/time unit</p> <p>US:</p> <p>Ounce → oz/time unit (US) Pound → lb/time unit Ton → ton/time unit</p> <p>Factory setting</p> <p>See the parameter printout provided. The parameter printout is an integral part of these Operating Instructions.</p>

Function description, SYSTEM UNITS group	
UNIT VOLUME	<p>Use this function to select the unit for displaying the volume.</p> <p>The unit you select here is also valid for:</p> <ul style="list-style-type: none"> ■ Pulse weighting (e.g. m³/p) <p>Options</p> <p>Metric: cm³; dm³; m³; ml; l; hl; Ml Mega</p> <p>US: cc; af; ft³; oz f; gal; Kgal; Mgal; bbl (normal fluids); bbl (beer); bbl (petrochemicals); bbl (filling tanks)</p> <p>Imperial: gal; Mgal; bbl (beer); bbl (petrochemicals)</p> <p>Factory setting m³</p> <p> Note!</p> <ul style="list-style-type: none"> ■ The unit of the totalizers is independent of your choice here. The unit for each totalizer is selected separately for the totalizer in question.
UNIT MASS	<p>Use this function to select the unit for displaying the mass.</p> <p>The unit you select here is also valid for:</p> <ul style="list-style-type: none"> ■ Pulse weighting (e.g. kg/p) <p>Options</p> <p>Metric: g; kg; t</p> <p>US: oz; lb; ton;</p> <p>Factory setting Country-dependent (kg or US-lb)</p> <p> Note!</p> <ul style="list-style-type: none"> ■ The unit of the totalizers is independent of your choice here. The unit for each totalizer is selected separately for the totalizer in question.
FORMAT DATE/TIME	<p>Use this function to select the format for the date and the time.</p> <p>The unit you select here is valid for: Displaying the current calibration date (function CALIBRATION DATE (6808) →  104</p> <p>Options</p> <p>DD.MM.YY 24H MM/DD/YY 12H A/P DD.MM.YY 12H A/P MM/DD/YY 24H</p> <p>Factory setting DD.MM.YY 24H (SI units) MM/DD/YY 12H A/P (US units)</p>

Function description, SYSTEM UNITS group	
UNIT DENSITY	<p>Prerequisite This function is only available if the CALCULATED MASS FLOW values were selected in the MEASURING UNITS function (→ 71).</p> <p>Description For selecting the unit required and displayed for the density. The density is selected in the FIXED OPERATION DENSITY (→ 102).</p> <p>Options Metric: g/cm³ g/cc kg/dm³ kg/l kg/m³ SD* 4 °C, SD 15 °C, SD 20 °C SG* 4 °C, SG 15 °C, SG 20 °C US: lb/ft³ lb/US gal lb/US bbl NORM (normal fluids) lb/US bbl BEER (beer) lb/US bbl PETR. (petrochemicals) lb/US bbl TANK (filling tanks) Imperial: lb/imp. gal lb/imp. bbl BEER (beer) lb/imp. bbl PETR. (petrochemicals)</p> <p>Factory setting See the parameter printout provided. The parameter printout is an integral part of these Operating Instructions.</p> <p>* SD = specific density, SG = specific gravity The specific density is the ratio of fluid density to water density (at water temperature = 4, 15, 20 °C).</p>
UNIT LENGTH	<p>For selecting the unit for the length.</p> <p>Options: MILLIMETER INCH</p> <p>Factory setting: MILLIMETER</p>
UNIT VELOCITY	<p>For selecting the unit for the velocity.</p> <p>The unit you select here is also valid for:</p> <ul style="list-style-type: none"> ■ Sound velocity ■ Flow velocity <p>Options: m/s ft/s</p> <p>Factory setting: m/s</p>





11.4 Group QUICK SETUP





Function description, QUICK SETUP group	
QUICK SETUP COMMISSIONING	<p>By means of this function, you can access a range of instrument functions with which you can put the measuring device into operation quickly.</p> <p>Options: YES NO</p> <p>Factory setting: NO</p> <p> Note! Further information on Quick Setups is provided on →  39</p>
T-DAT SAVE/LOAD	<p>In this function, the configuration/settings of the transmitter can be saved to a transmitter DAT (T-DAT) or uploading a configuration from the T-DAT to the EEPROM can be activated (manual safety function).</p> <p>Application examples:</p> <ul style="list-style-type: none"> ■ After commissioning, the current measuring point parameters can be saved to the T-DAT as a backup. ■ If the transmitter is replaced for some reason, the data can be loaded from the T-DAT to the new transmitter (EEPROM). <p>Options: CANCEL SAVE (from EEPROM to T-DAT) LOAD (from T-DAT to EEPROM)</p> <p>Factory setting: CANCEL</p> <p> Note! Flowchart of T-DAT SAVE/LOAD function and more detailed description →  41)</p>

11.5 Group OPERATION

Function description, OPERATION group	
LANGUAGE	<p>For selecting the language in which all messages are shown on the local display.</p> <p>Options: ENGLISH DEUTSCH FRANCAIS ESPANOL ITALIANO NEDERLANDS NORSK SVENSKA SUOMI PORTUGUES POLSKI CESKI</p> <p>Factory setting: Depends on country → 109</p> <p> Note! If you press the +/- keys simultaneously at startup, the language defaults to "ENGLISH".</p>
ACCESS CODE	<p>All data of the measuring system are protected against inadvertent change. Programming is disabled and the settings cannot be changed until a code is entered in this function. If you press the +/- keys in any function, the measuring system automatically goes to this function and the prompt to enter the code appears on the display (when programming is disabled). You can enable programming by entering the private code (factory setting = 92, see DEFINE PRIVATE CODE function).</p> <p>Application examples:</p> <ul style="list-style-type: none"> ■ After commissioning, the current measuring point parameters can be saved to the HistoROM/T-DAT as a backup. ■ If the transmitter is replaced for some reason, the data can be loaded from the HistoROM/T-DAT to the new transmitter (EEPROM). <p>User input: Max. 4-digit number: 0 to 9999</p> <p> Note!</p> <ul style="list-style-type: none"> ■ The programming levels are disabled if you do not press a key within 60 seconds following a return to the HOME position. ■ You can also disable programming by entering any number (other than the private code) in this function. ■ Your Endress+Hauser representative can be of assistance if you mislay your private code.
DEFINE PRIVATE CODE	<p>Use this function to specify the private code for enabling programming.</p> <p>User input: Max. 4-digit number: 0 to 9999</p> <p>Factory setting: 92</p> <p> Note!</p> <ul style="list-style-type: none"> ■ Programming is always enabled if the code defined = 0. ■ Programming has to be enabled before this code can be changed. When programming is disabled this function cannot be edited, thus preventing others from accessing your personal code.
STATUS ACCESS	<p>The access status for the function matrix appears on the display.</p> <p>Display: ACCESS CUSTOMER (parameters can be modified) LOCKED (parameters cannot be modified)</p>
ACCESS CODE COUNTER	<p>The number of times the private and service code was entered to access the device appears on the display.</p> <p>Display: Integer (delivery status: 0)</p>



11.6 Group USER INTERFACE

Function description, USER INTERFACE group	
ASSIGN LINE 1	<p>For assigning a display value to the main line (top line of the local display). This value is displayed during normal operation.</p> <p>Options: OFF FLOW FLOW IN % TOTALIZER 1 TOTALIZER 2</p> <p>Factory setting: VOLUME FLOW</p>
ASSIGN LINE 2	<p>For assigning a display value to the additional line (bottom line of the local display). This value is displayed during normal operation.</p> <p>Options: OFF FLOW FLOW IN % FLOW BAR GRAPH IN % SOUND VELOCITY FLOW VELOCITY SIGNAL STRENGTH SIGNAL STRENGTH BAR GRAPH IN % TOTALIZER 1 TOTALIZER 2 OPERATING/SYSTEM CONDITIONS</p> <p>Factory setting: TOTALIZER 1</p>
100% VALUE LINE 1	<p> Note! This function is not available unless the FLOW IN % option was selected in the ASSIGN LINE 2 function.</p> <p>For specifying the value which should be shown on the display as the 100% value.</p> <p>User input: 5-digit floating-point number</p> <p>Factory setting: 10 l/s</p> <p> Note! If a value was specified for the VALUE 20 mA function when ordering, this value is also used here as the factory setting.</p>
100% VALUE LINE 2	<p> Note! This function is not available unless the FLOW IN %, FLOW BAR GRAPH IN % or SIGNAL STRENGTH BAR GRAPH IN % option was selected in the ASSIGN LINE 2 function.</p> <p>For specifying the value which should be shown on the display as the 100% value.</p> <p>User input: 5-digit floating-point number</p> <p>Factory setting: 10 l/s (for volume flow); 100 dB (for signal strength)</p> <p> Note! If a value was specified for the VALUE 20 mA function when ordering, this value is also used here as the factory setting.</p>

Function description, USER INTERFACE group	
FORMAT	<p>For selecting the number of places displayed after the decimal point for the display value in the main line.</p> <p>Options: XXXXX. - XXXX.X - XXX.XX - XX.XXX -X.XXXX</p> <p>Factory setting: X.XXXX</p> <p> Note!</p> <ul style="list-style-type: none"> ■ Note that this setting only affects the reading as it appears on the display, it has no influence on the accuracy of the system's calculations. ■ The places after the decimal point as computed by the measuring device cannot always be displayed, depending on this setting and the engineering unit. In these instances an arrow appears on the display between the measured value and the engineering unit (e.g. 1.2 → kg/h), indicating that the measuring system is computing with more decimal places than can be shown on the display.
DISPLAY DAMPING	<p>For entering a time constant used to define how the display reacts to severely fluctuating flow variables, either very quickly (enter a low time constant) or with damping (enter a high time constant).</p> <p>User input: 0 to 100 seconds</p> <p>Factory setting: 0 seconds</p> <p> Note! The setting 0 seconds switches off damping.</p>
CONTRAST LCD	<p>For adjusting the display contrast to suit local operating conditions.</p> <p>User input: 10 to 100%</p> <p>Factory setting: 50%</p> <p> Note! If you press the   keys simultaneously at startup, the language defaults to "ENGLISH" and the contrast is reset to the factory setting.</p>
TEST DISPLAY	<p>Use this function to test the operability of the local display and its pixels.</p> <p>Options: OFF ON</p> <p>Factory setting: OFF</p> <p>Test sequence:</p> <ol style="list-style-type: none"> 1. Start the test by selecting ON. 2. All pixels of the main line and additional line are darkened for minimum 0.75 seconds. 3. The main line and additional line show an "8" in each field for minimum 0.75 seconds. 4. The main line and additional line show a "0" in each field for minimum 0.75 seconds. 5. The main line and additional line show nothing (blank display) for minimum 0.75 seconds. 6. When the test is completed, the local display returns to its initial state and the displays the option OFF.

11.7 Group TOTALIZER

11.7.1 Function group TOTALIZER 1 (TOTALIZER 2)

Function description TOTALIZER group → TOTALIZER 1 or 2 function group	
ASSIGN TOTALIZER	<p>A measured variable is assigned to the totalizer.</p> <p>Options (totalizer 1 and 2): OFF FLOW</p> <p>Factory setting: (totalizer 1) FLOW</p> <p>Factory setting: (totalizer 2) VOLUME FLOW</p> <p> Note!</p> <ul style="list-style-type: none"> ■ If the selection is changed, you are asked whether the totalizer should be reset. This query first has to be confirmed before the new option is accepted and the totalizer is reset to 0. ■ If OFF is selected, the ASSIGN TOTALIZER function is the only function displayed in the totalizer 1 or 2 group.
SUM	<p>The total for the totalizer's measured variable aggregated since measuring commenced appears on the display.</p> <p>Display: Max. 7-digit floating-point number, including unit (e.g. 15467.04 m³)</p> <p> Note!</p> <p>The totalizer's response to errors is defined in the "FAILSAFE MODE" function.</p>
OVERFLOW	<p>The total for the totalizer's overflow aggregated since measuring commenced appears on the display.</p> <p>Total flow is represented by a floating-point number consisting of max. 7 digits. You can use this function to view higher numerical values (>9,999,999) as overflows. The effective quantity is thus the total of the SUM function plus the value displayed in the OVERFLOW function.</p> <p>Example: Reading after 2 overflows: 2 E7 kg (= 20,000,000 kg) The value displayed in the SUM function = 196,845.7 kg Effective total quantity = 20,196,845.7 kg</p> <p>Display: Integer with exponent, including unit, e.g. 2 E7 kg</p>





Function description TOTALIZER group → TOTALIZER 1 or 2 function group	
UNIT TOTALIZER	<p>Description For selecting the unit for the measured variable assigned to the totalizer.</p> <p>Options (MEASURING UNITS assigned to VOLUME FLOW)</p> <p>Metric: Cubic centimeter → cm³ Cubic decimeter → dm³ Cubic meter → m³ Milliliter → ml Liter → l Hectoliter → hl Megaliter → Ml MEGA</p> <p>US: Cubic centimeter → cc Acre foot → af Cubic foot → ft³ Fluid ounce → oz f Gallon → US gal Mega gallon → US Mgal Barrel (normal fluids: 31.5 gal/bbl) → US bbl NORM.FL. Barrel (beer: 31.0 gal/bbl) → US bbl BEER Barrel (petrochemicals: 42.0 gal/bbl) → US bbl PETROCH. Barrel (filling tanks: 55.0 gal/bbl) → US bbl TANK</p> <p>Imperial: Gallon → imp. gal Mega gallon → imp. Mgal Barrel (beer: 36.0 gal/bbl) → imp. bbl BEER Barrel (petrochemicals: 34.97 gal/bbl) → imp. bbl PETROCH.</p> <p>Factory setting Depends on country → 109</p> <p>Options (MEASURING UNIT TYPE assigned to CALCULATED MASS FLOW)</p> <p>Metric: Gram → g Kilogram → kg Metric ton → t</p> <p>US: Ounce → oz (US) Pound → lb Ton → ton</p> <p>Factory setting Depends on country → 109</p>
TOTALIZER MODE	<p>For selecting how the flow components should be totalized.</p> <p>Options:</p> <p>BALANCE Positive and negative flow components. The positive and negative flow components are balanced. In other words, net flow in the flow direction is registered.</p> <p>FORWARD Only positive flow components are recorded.</p> <p>REVERSE Only negative flow components are recorded.</p> <p>Factory setting: Totalizer 1 = FORWARD Totalizer 2 = FORWARD</p>
RESET TOTALIZER	<p>Resets the sum and overflow in the totalizer selected.</p> <p>Options: NO YES</p> <p>Factory setting: NO</p>



11.7.2 Group HANDLING TOTALIZER

Function description, TOTALIZER group → HANDLING TOTALIZER function group	
RESET ALL TOTALIZERS	<p>Use this function to reset the sums and the overflows of both totalizers to "zero" (=RESET).</p> <p>Options: NO YES</p> <p>Factory setting: NO</p>
FAILSAFE ALL TOTALIZERS	<p>For selecting the behavior of the totalizer in an alarm condition.</p> <p>Options: STOP The totalizer does not continue to count the flow if a fault is present. The totalizer stops at the last value before the alarm condition occurred.</p> <p>ACTUAL VALUE The totalizers continue to count on the basis of the current flow data. The fault is ignored.</p> <p>Factory setting: STOP</p>





11.8 Group CURRENT OUTPUT





Function description, CURRENT OUTPUT group													
<p>ASSIGN CURRENT OUTPIUT</p>	<p>Use this function to assign a measured variable to the current output.</p> <p>Options: FLOW SOUND VELOCITY FLOW VELOCITY SIGNAL STRENGTH</p> <p>Factory setting: See parameter printout supplied (the parameter printout is an integral part of these Operating Instructions)</p>												
<p>CURRENT SPAN</p>	<p>Use this function to define the current range. You can configure the current output either in accordance with the NAMUR recommendation or for the values common in the United States.</p> <p>Options: 4-20 mA HART NAMUR 4-20 mA HART US</p> <p>Factory setting: See parameter printout supplied (the parameter printout is an integral part of these Operating Instructions)</p> <p>Current span, operational range and signal on alarm level</p> <table border="1"> <thead> <tr> <th>A</th> <th>①</th> <th>②</th> <th>③</th> </tr> </thead> <tbody> <tr> <td>4-20 mA HART NAMUR</td> <td>3.8 - 20.5 mA</td> <td>3.5</td> <td>22.6</td> </tr> <tr> <td>4-20 mA HART US</td> <td>3.9 - 20.8 mA</td> <td>3.75</td> <td>22.6</td> </tr> </tbody> </table> <p style="text-align: right;"><small>a0006213</small></p> <p><i>Fig. 29: Current span, operational range and signal on alarm level</i></p> <p>A = Current span ① = Work range ② = Lower signal on alarm level ③ = Upper signal on alarm level ④ = Scaled full scale value Q = Flow</p> <p> Note!</p> <ul style="list-style-type: none"> ■ If the measured value is outside the measuring range (defined in the VALUE 20 mA function → Page 83), a notice message is generated. ■ The current output's response to faults is defined in the central ASSIGN DIAGNOSTIC CODE function → 106. 	A	①	②	③	4-20 mA HART NAMUR	3.8 - 20.5 mA	3.5	22.6	4-20 mA HART US	3.9 - 20.8 mA	3.75	22.6
A	①	②	③										
4-20 mA HART NAMUR	3.8 - 20.5 mA	3.5	22.6										
4-20 mA HART US	3.9 - 20.8 mA	3.75	22.6										
<p>VALUE 4 mA</p>	<p>Use this function to assign the 4 mA current a value. The value must be smaller than the value entered in the VALUE 20 mA function.</p> <p>User input: 5-digit floating-point number</p> <p>Factory setting: See parameter printout supplied (the parameter printout is an integral part of these Operating Instructions)</p>												







Function description, CURRENT OUTPUT group	
VALUE 20 mA	<p>Use this function to assign the 20 mA current a value.</p> <p>User input: 5-digit floating-point number</p> <p>Factory setting: See parameter printout supplied (the parameter printout is an integral part of these Operating Instructions)</p>
TIME CONSTANT	<p>Use this function to select a time constant defining how the current output signal reacts to severely fluctuating measured variables, either very quickly (low time constant) or with damping (high time constant).</p> <p>User input: Fixed-point number: 0 to 100 s</p> <p>Factory setting: 5 s</p> <p> Note!</p> <p>The reaction time of the function also depends on the time specified in the FLOW DAMPING function (→  103).</p>
FAILSAFE MODE	<p>The dictates of safety render it advisable to ensure that the current output assumes a predefined state in the event of a fault. Use this function to define the response of the current output to fault. The setting you select here affects only the current output. It has no effect on other outputs or the display (e.g. totalizers).</p> <p>Options:</p> <p>MIN. CURRENT Depends on the setting selected in the CURRENT SPAN function. → Page 82 If the current range is: 4-20 mA HART NAMUR → output current = 3.6 mA 4-20 mA HART US → output current = 3.75 mA</p> <p>MAX. CURRENT 22.6 mA</p> <p>ACTUAL VALUE Measured value output is based on the current flow measurement. The fault is ignored.</p> <p>Factory setting: MAX. CURRENT</p>
ACTUAL CURRENT	<p>The current computed actual value of the output current appears on the display.</p> <p>Display: 3.60 to 22.60 mA</p>
SIMULATION CURRENT	<p>Use this function to activate simulation of the current output.</p> <p>Options: OFF ON</p> <p>Factory setting: OFF</p> <p> Note!</p> <ul style="list-style-type: none"> ■ The diagnosis code message "C 482– 1 Simulation Outpt" indicates that simulation is active. → Page 49 ■ The value which should be output at the current output is defined in the VALUE SIMULATION CURRENT function. ■ The measuring device continues to measure while simulation is in progress, i.e. the current measured values are output correctly via the other outputs and the display. <p> Caution! The setting is not saved if the power supply fails.</p>



Function description, CURRENT OUTPUT group	
VALUE SIMULATION CURRENT	<p> Note! This function is not available unless the ON option was selected in the SIMULATION CURRENT function.</p> <p>Use this function to define a selectable value (e.g. 12 mA) to be output at the current output. This value is used to test downstream devices and the measuring device itself.</p> <p>User input: Floating-point number: 3.60 to 22.60 mA</p> <p>Factory setting: 3.60 mA</p> <p> Note! Simulation is started by confirming the simulation value with the <input type="checkbox"/> key. If the <input type="checkbox"/> key is pressed again afterwards, the prompt "End simulation" (NO/YES) appears. If you choose "NO", simulation remains active and the group selection is called up. The simulation can be switched off again via the SIMULATION CURRENT function. If you choose "YES", you end the simulation and the group selection is called up.</p> <p> Caution! The setting is not saved if the power supply fails.</p>

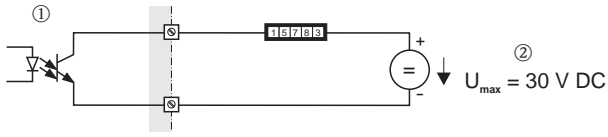

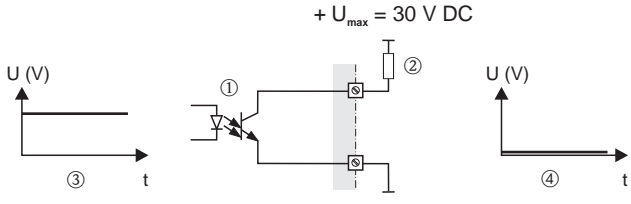

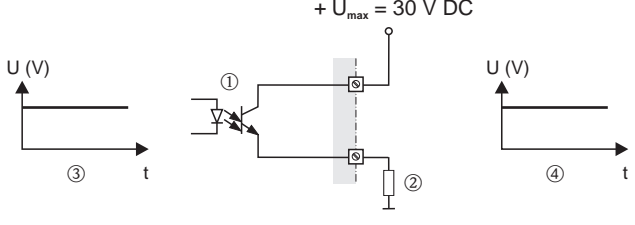
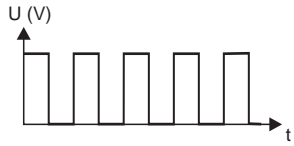
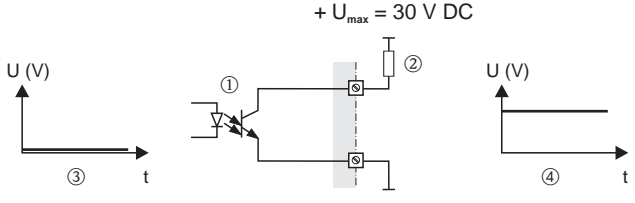

11.9 Group PULSE, FREQUENCY, STATUS











Function description, PULSE, FREQUENCY, STATUS group	
OPERATION MODE	<p>Use this function to specify whether the output functions as a frequency output, pulse output or status output. The functions available in this function group vary, depending on which option you select here.</p> <p>Options: FREQUENCY PULSE STATUS</p> <p>Factory setting: PULSE</p>
ASSIGN FREQUENCY	<p> Note! This function is not available unless the FREQUENCY option was selected in the OPERATION MODE function.</p> <p>Use this function to assign a measured variable to the frequency output.</p> <p>Options: OFF FLOW SOUND VELOCITY FLOW VELOCITY SIGNAL STRENGTH</p> <p>Factory setting: VOLUME FLOW</p> <p> Note! If the FREQUENCY option was selected in the OPERATION MODE function and the OFF option was selected in this function, only the OPERATION MODE and ASSIGN FREQUENCY functions are displayed in this function group.</p>
START VALUE FREQUENCY	<p> Note! This function is not available unless the FREQUENCY option was selected in the OPERATION MODE function.</p> <p>Use this function to define a start value frequency for the frequency output. You define the associated measured value of the measuring range in the VALUE-f LOW function.</p> <p>User input: 5-digit fixed point number: 0 to 1000 Hz</p> <p>Factory setting: 0 Hz</p> <p>Example: Start value frequency = 0 Hz, VALUE-f LOW = 0 l/h: i.e. a frequency of 0 Hz is output at a flow of 0 l/h. Start value frequency = 10 Hz, VALUE-f LOW = 1 l/h: i.e. a frequency of 10 Hz is output at a flow of 1l/h.</p>
END VALUE FREQUENCY	<p> Note! This function is not available unless the FREQUENCY option was selected in the OPERATION MODE function.</p> <p>Use this function to define an end value frequency for the frequency output. You define the associated measured value of the measuring range in the VALUE-f HIGH function.</p> <p>User input: 5-digit fixed point number: 2 to 1000 Hz</p> <p>Factory setting: 1000 Hz</p> <p>Example: End value frequency = 1000 Hz, VALUE-f HIGH = 100 l/h: i.e. a frequency of 1000 Hz is output at a flow of 100l/h.</p> <p> Note! In the FREQUENCY operating mode the output signal is symmetrical (on/off ratio = 1:1).</p>



Function description, PULSE, FREQUENCY, STATUS group	
VALUE-f LOW	<p> Note! This function is not available unless the FREQUENCY option was selected in the OPERATION MODE function.</p> <p>Use this function to assign a value to the start value frequency. The value entered here must be smaller than the value assigned to the VALUE-f HIGH. The required span is defined by specifying the VALUE-f LOW and VALUE-f HIGH.</p> <p>User input: 5-digit floating-point number</p> <p>Factory setting: Depends on the setting selected in the ASSIGN FREQUENCY function</p> <ul style="list-style-type: none"> - 0 [UNIT FLOW] - 0 [UNIT FLOW VELOCITY] - 0 [UNIT SOUND VELOCITY] <p> Note! The appropriate unit is taken from the SYSTEM UNITS group. → Page 71</p>
VALUE-f HIGH	<p> Note! This function is not available unless the FREQUENCY option was selected in the OPERATION MODE function.</p> <p>Use this function to assign a value to the end value frequency. The value entered here must be larger than the value assigned to the VALUE-f LOW. The required span is defined by specifying the VALUE-f LOW and VALUE-f HIGH.</p> <p>User input: 5-digit floating-point number</p> <p>Factory setting: Depends on the setting selected in the ASSIGN FREQUENCY function</p> <ul style="list-style-type: none"> - [UNIT FLOW] - [UNIT FLOW VELOCITY] - [UNIT SOUND VELOCITY] <p> Note! The appropriate unit is taken from the SYSTEM UNITS group. → Page 71</p>



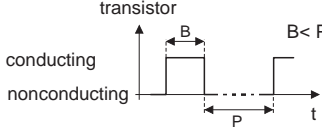
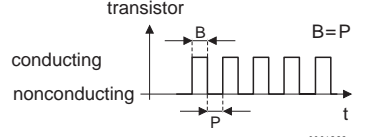

Function description, PULSE, FREQUENCY, STATUS group	
OUTPUT SIGNAL	<p> Note! This function is not available unless the FREQUENCY option was selected in the OPERATION MODE function.</p> <p>Use this function to select the polarity of the frequency.</p> <p>Options: PASSIVE - POSITIVE PASSIVE-NEGATIVE</p> <p>Factory setting: PASSIVE - POSITIVE</p> <p>Explanation: PASSIVE = power is supplied to the frequency output by means of an external power supply</p> <p>Configuring the output signal level (POSITIVE or NEGATIVE) determines the quiescent behavior (at zero flow) of the frequency output. The internal transistor is activated as follows:</p> <ul style="list-style-type: none"> ■ If POSITIVE is selected, the internal transistor is activated with a positive signal level ■ If NEGATIVE is selected, the internal transistor is activated with a negative signal level (0 V) <p> Note! With the passive output configuration, the output signal levels of the frequency output depend on the external wiring (see examples).</p> <p>Example for passive output wiring (PASSIVE): If PASSIVE is selected, the frequency output is configured as an open collector.</p>  <p style="text-align: right; font-size: small;">a0001225</p> <p>1 = Open collector 2 = External power supply</p> <p> Note! For continuous currents up to 25 mA ($I_{max} = 250 \text{ mA} / 20 \text{ ms}$).</p> <p>Example for output configuration PASSIVE-POSITIVE: Output configuration with an external pull-up resistor. In the quiescent state (at zero flow), the output signal level at the terminals is 0 V.</p>  <p style="text-align: right; font-size: small;">a0004687</p> <p>1 = Open collector 2 = Pull-up resistor 3 = Transistor activation in "POSITIVE" quiescent state (at zero flow) 4 = Output signal level in quiescent state (at zero flow)</p> <p>In the operating status (flow present), the output signal level switches from 0 V to a positive voltage level.</p>  <p style="text-align: right; font-size: small;">a0001975</p> <p>(continued on next page)</p>

Function description, PULSE, FREQUENCY, STATUS group	
OUTPUT SIGNAL (continued)	<p>Example for output configuration PASSIVE-POSITIVE: Output configuration with an external pull-down resistor. At the quiescent state (at zero flow), a positive voltage level is measured via the pull-down resistor.</p>  <p>1 = Open collector 2 = Pull-up resistor 3 = Transistor activation in "POSITIVE" quiescent state (at zero flow) 4 = Output signal level in quiescent state (at zero flow)</p> <p>In the operating status (flow present), the output signal level switches from a positive voltage level to 0 V.</p>  <p>Example for output configuration PASSIVE-NEGATIVE: Output configuration with an external pull-up resistor. In the quiescent state (at zero flow), the output signal level at the terminals is at a positive voltage level.</p>  <p>1 = Open collector 2 = Pull-up resistor 3 = Transistor activation in "NEGATIVE" quiescent state (at zero flow) 4 = Output signal level in quiescent state (at zero flow)</p> <p>In the operating status (flow present), the output signal level switches from a positive voltage level to 0 V.</p> 





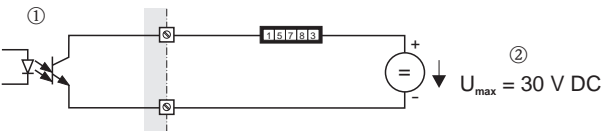

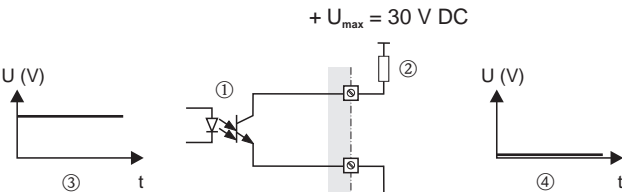
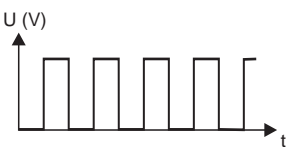

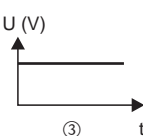
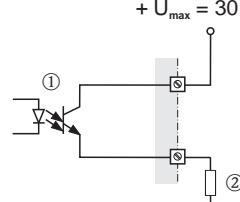
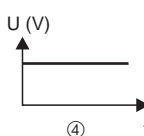
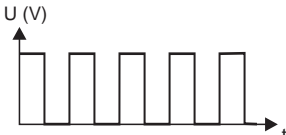
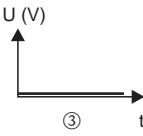
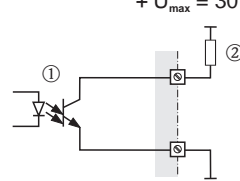
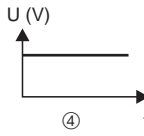
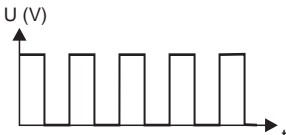
Function description, PULSE, FREQUENCY, STATUS group	
TIME CONSTANT	<p> Note! This function is not available unless the FREQUENCY option was selected in the OPERATION MODE function.</p> <p>Use this function to select a time constant defining how the frequency output signal reacts to severely fluctuating measured variables, either very quickly (low time constant) or with damping (high time constant).</p> <p>User input: Floating-point number 0 to 100 s</p> <p>Factory setting: 5 s</p>
FAILSAFE MODE	<p> Note! This function is not available unless the FREQUENCY option was selected in the OPERATION MODE function.</p> <p>The dictates of safety render it advisable to ensure that the frequency output assumes a predefined state in the event of a fault. Use this function to define this state. The setting you select here affects only the frequency output. It has no effect on other outputs or the display (e.g. totalizers).</p> <p>Options:</p> <p>FALLBACK VALUE Output is 0 Hz.</p> <p>FAILSAFE VALUE The frequency specified in the FAILSAFE VALUE function is output.</p> <p>ACTUAL VALUE Measured value output is based on the current flow measurement. The fault is ignored.</p> <p>Factory setting: FALLBACK VALUE</p>
FAILSAFE VALUE	<p> Note! This function is not available unless FREQUENCY was selected in the OPERATION MODE function and FAILSAFE LEVEL was selected in the FAILSAFE MODE function.</p> <p>Use this function to define the frequency that the measuring device outputs in the event of a fault.</p> <p>Display: Max. 4-digit number: 0 to 1250 Hz</p> <p>Factory setting: 1250 Hz</p>
ACTUAL FREQUENCY	<p> Note! This function is not available unless the FREQUENCY option was selected in the OPERATION MODE function.</p> <p>The current computed actual value of the output frequency appears on the display.</p> <p>Display: 0 to 1250 Hz</p>
SIMULATION FREQUENCY	<p> Note! This function is not available unless the FREQUENCY option was selected in the OPERATION MODE function.</p> <p>Use this function to activate simulation of the frequency output.</p> <p>Options: OFF ON</p> <p>Factory setting: OFF</p> <p> Note! The diagnosis code message "C 482- 2 Simulation Outpt" indicates that simulation is active. The measuring device continues to measure while simulation is in progress, i.e. the current measured values are output correctly via the other outputs.</p>









Function description, PULSE, FREQUENCY, STATUS group	
VALUE SIMULATION FREQUENCY	<p> Note! This function is not available unless FREQUENCY was selected in the OPERATION MODE function and ON was selected in the SIMULATION FREQUENCY function.</p> <p>Use this function to specify a selectable frequency value (e.g. 500 Hz) to be output at the frequency output. This value is used to test downstream devices and the measuring device itself. Simulation is started once the specified value is confirmed with the  key.</p> <p>User input: 0 to 1250 Hz</p> <p>Factory setting: 0 Hz</p> <p> Note! Simulation is started by confirming the simulation value with the  key. If the  key is pressed again afterwards, the prompt "End simulation" (NO/YES) appears. If you choose "NO", simulation remains active and the group selection is called up. The simulation can be switched off again by means of the "C 482– 2 Simulation Outp" diagnosis code. If you choose "YES", you end the simulation and the group selection is called up.</p> <p> Caution! The setting is not saved if the power supply fails.</p>
ASSIGN PULSE	<p> Note! This function is not available unless the PULSE option was selected in the OPERATION MODE function.</p> <p>Use this function to assign a measured variable to the pulse output.</p> <p>Options: OFF VOLUME FLOW</p> <p>Factory setting: See parameter printout supplied (the parameter printout is an integral part of these Operating Instructions)</p>
PULSE VALUE	<p> Note! This function is not available unless the PULSE option was selected in the OPERATION MODE function.</p> <p>Use this function to define the flow at which a pulse should be output. These pulses can be totaled by an external totalizer and in this way the total flow since measuring commenced can be registered.</p> <p> Note! The pulse value must be selected as follows: Pulse value [l/pulse] > maximum flow [l/s] · 2 · pulse width [s]</p> <p>User input: 5-digit floating-point number</p> <p>Factory setting: See parameter printout supplied (the parameter printout is an integral part of these Operating Instructions)</p> <p> Note! The appropriate unit is taken from the SYSTEM UNITS group.</p>







Function description, PULSE, FREQUENCY, STATUS group	
PULSE WIDTH	<p> Note! This function is not available unless the PULSE option was selected in the OPERATION MODE function.</p> <p>Use this function to enter the pulse width of the output pulses.</p> <p>User input: 5 to 2000 ms</p> <p>Factory setting: 10 ms</p> <p>Pulse output is always with the pulse width (B) entered in this function. The intervals (P) between the individual pulses are automatically adjusted. However, they must at least correspond to the pulse width (B = P).</p> <div style="display: flex; justify-content: space-around; align-items: flex-start;"> <div style="text-align: center;"> <p>transistor</p>  </div> <div style="text-align: center;"> <p>transistor</p>  <p style="font-size: small;">a0001233-en</p> </div> </div> <p>B = Pulse width entered (the illustration applies to positive pulses) P = Intervals between the individual pulses</p> <p> Note! When entering the pulse width, select a value that can still be processed by an external totalizer (e.g. mechanical totalizers, PLC, etc.).</p> <p> Caution! If the pulse number or the frequency resulting from the pulse value entered (PULSE VALUE function) and from the current flow is too large to maintain the pulse width selected, (interval P is smaller than the pulse width B entered), a diagnosis code message is generated after 5 seconds buffering/idling time.</p>











Function description, PULSE, FREQUENCY, STATUS group	
OUTPUT SIGNAL	<p> Note! This function is not available unless the PULSE option was selected in the OPERATION MODE function.</p> <p>For selecting the output configuration of the pulse output.</p> <p>Options: PASSIVE - POSITIVE PASSIVE-NEGATIVE</p> <p>Factory setting: PASSIVE - POSITIVE</p> <p>Explanation: PASSIVE = power is supplied to the pulse output by means of an external power supply</p> <p>Configuring the output signal level (POSITIVE or NEGATIVE) determines the quiescent behavior (at zero flow) of the pulse output. The internal transistor is activated as follows:</p> <ul style="list-style-type: none"> ■ If POSITIVE is selected, the internal transistor is activated with a positive signal level ■ If NEGATIVE is selected, the internal transistor is activated with a negative signal level (0 V) <p> Note! With the passive output configuration, the output signal levels of the pulse output depend on the external wiring (see examples).</p> <p>Example for passive output wiring (PASSIVE): If PASSIVE is selected, the pulse output is configured as an open collector.</p>  <p style="text-align: right; font-size: small;">a0001225</p> <p>1 = Open collector 2 = External power supply</p> <p> Note! For continuous currents up to 25 mA ($I_{max} = 250 \text{ mA} / 20 \text{ ms}$).</p> <p>Example for output configuration PASSIVE-POSITIVE: Output configuration with an external pull-up resistor. In the quiescent state (at zero flow), the output signal level at the terminals is 0 V.</p>  <p style="text-align: right; font-size: small;">a0004687</p> <p>1 = Open collector 2 = Pull-up resistor 3 = Transistor activation in "POSITIVE" quiescent state (at zero flow) 4 = Output signal level in quiescent state (at zero flow)</p> <p>In the operating status (flow present), the output signal level switches from 0 V to a positive voltage level.</p>  <p style="text-align: right; font-size: small;">a0001975</p> <p>(continued on next page)</p>

Function description, PULSE, FREQUENCY, STATUS group	
<p>OUTPUT SIGNAL (continued)</p>	<p>Example for output configuration PASSIVE-POSITIVE: Output configuration with an external pull-down resistor. At the quiescent state (at zero flow), a positive voltage level is measured via the pull-down resistor.</p> <div style="display: flex; justify-content: space-around; align-items: center;">    </div> <p style="text-align: right; font-size: small;">a0004689</p> <p>1 = Open collector 2 = Pull-up resistor 3 = Transistor activation in "POSITIVE" quiescent state (at zero flow) 4 = Output signal level in quiescent state (at zero flow)</p> <p>In the operating status (flow present), the output signal level switches from a positive voltage level to 0 V.</p> <div style="display: flex; justify-content: center; align-items: center;">  </div> <p style="text-align: right; font-size: small;">a0001981</p> <p>Example for output configuration PASSIVE-NEGATIVE: Output configuration with an external pull-up resistor. In the quiescent state (at zero flow), the output signal level at the terminals is at a positive voltage level.</p> <div style="display: flex; justify-content: space-around; align-items: center;">    </div> <p style="text-align: right; font-size: small;">a0004690</p> <p>1 = Open collector 2 = Pull-up resistor 3 = Transistor activation in "NEGATIVE" quiescent state (at zero flow) 4 = Output signal level in quiescent state (at zero flow)</p> <p>In the operating status (flow present), the output signal level switches from a positive voltage level to 0 V.</p> <div style="display: flex; justify-content: center; align-items: center;">  </div> <p style="text-align: right; font-size: small;">a0001981</p>

Function description, PULSE, FREQUENCY, STATUS group	
FAILSAFE MODE	<p> Note! This function is not available unless the PULSE option was selected in the OPERATION MODE function.</p> <p>The dictates of safety render it advisable to ensure that the pulse output assumes a predefined state in the event of a fault. Use this function to define this state. The setting you select here affects only the pulse output. It has no effect on other outputs or the display (e.g. totalizers).</p> <p>Options: FALLBACK VALUE Output is 0 Hz. ACTUAL VALUE Measured value output is based on the current flow measurement. The fault is ignored.</p> <p>Factory setting: FALLBACK VALUE</p>
ACTUAL PULSE	<p> Note! This function is not available unless the PULSE option was selected in the OPERATION MODE function.</p> <p>The current computed actual value of the output frequency appears on the display.</p> <p>Display: 0 to 100 pulse/second</p>
SIMULATION PULSE	<p> Note! This function is not available unless the PULSE option was activated in the OPERATION MODE function.</p> <p>Use this function to activate simulation of the pulse output.</p> <p>Options: OFF COUNTDOWN The pulses specified in the VALUE SIMULATION PULSE function are output. CONTINUOUSLY Pulses are continuously output with the pulse width specified in the PULSE WIDTH function. Simulation is started once the CONTINUOUSLY option is confirmed with the  key.</p> <p> Note! Simulation is started by confirming the CONTINUOUSLY option with the  key. If the  key is pressed again afterwards, the prompt "End simulation" (NO/YES) appears. If you choose "NO", simulation remains active and the group selection is called up. The simulation can be switched off again via the SIMULATION PULSE function. If you choose "YES", you end the simulation and the group selection is called up.</p> <p>Factory setting: OFF</p> <p> Note!</p> <ul style="list-style-type: none"> ■ The diagnosis code message "C 482– 3 Simulation Outpt" indicates that simulation is active. → Page 49 ■ The on/off ratio is for both types of simulation ■ The measuring device continues to measure while simulation is in progress, i.e. the measured values are output correctly via the other outputs. <p> Caution! The setting is not saved if the power supply fails.</p>

Function description, PULSE, FREQUENCY, STATUS group	
<p>VALUE SIMULATION PULSE</p>	<p> Note! This function is not available unless the COUNTDOWN option was selected in the SIMULATION PULSE function.</p> <p>Use this function to specify the number of pulses (e.g. 50) which are output during the simulation. This value is used to test downstream devices and the measuring device itself. The pulses are output with the pulse width specified in the PULSE WIDTH function. The on/off ratio is 1:1. Simulation is started once the specified value is confirmed with the  key. The display remains at 0 if the specified pulses have been output.</p> <p>User input: 0 to 10000</p> <p>Factory setting: 0</p> <p> Note! Simulation is started by confirming the simulation value with the  key. If the  key is pressed again afterwards, the prompt "End simulation" (NO/YES) appears. If you choose "NO", simulation remains active and the group selection is called up. The simulation can be switched off again via the SIMULATION PULSE function. If you choose "YES", you end the simulation and the group selection is called up.</p> <p> Caution! The setting is not saved if the power supply fails.</p>
<p>ASSIGN STATUS</p>	<p> Note! This function is not available unless the STATUS option was selected in the OPERATION MODE function.</p> <p>Use this function to assign a switching function to the status output.</p> <p>Options: OFF ON (operation) FAULT MESSAGE NOTICE MESSAGE FAULT MESSAGE & NOTICE MESSAGE FLOW DIRECTION LIMIT FLOW LIMIT SOUND VELOCITY LIMIT FLOW VELOCITY LIMIT SIGNAL STRENGTH LIMIT TOTALIZER 1 LIMIT TOTALIZER 2</p> <p>Factory setting: FAULT MESSAGE</p> <p> Note! The status output displays quiescent current behavior, in other words the output is closed (transistor conductive) when normal, error-free operation is in progress. Please pay particular attention to the illustrations and detailed information on the switching behavior of the status output. →  98 If you select OFF, the only function shown in this function group is this function (ASSIGN STATUS).</p>

Function description, PULSE, FREQUENCY, STATUS group	
SWITCH-ON POINT	<p> Note! This function is not available unless a limit value was selected in the ASSIGN STATUS function.</p> <p>Use this function to assign a value to the switch-on point (status output pulls down). The value can be equal to, greater or less than the switch-off point.</p> <p>User input: 5-digit floating-point number, [unit]</p> <p>Factory setting: Depends on the setting selected in the ASSIGN STATUS function</p> <ul style="list-style-type: none"> – If LIMIT FLOW is selected: see Table → Page 109 – If LIMIT SOUND VELOCITY is selected: 800 m/s (converted to the selected UNIT SOUND VELOCITY) – If LIMIT FLOW VELOCITY is selected: 10 m/s (converted to the selected UNIT FLOW VELOCITY) – If LIMIT SIGNAL STRENGTH is selected: 50 dB – If LIMIT TOTALIZER 1 is selected: 0 (converted to the selected UNIT TOTALIZER 1) – If LIMIT TOTALIZER 2 is selected: 0 (converted to the selected UNIT TOTALIZER 2) <p> Note! The appropriate unit is taken from the SYSTEM UNITS group.</p>
OFF VALUE	<p> Note! This function is not available unless a limit value was selected in the ASSIGN STATUS function.</p> <p>Use this function to assign a value to the switch-off point (status output drops out). The value can be equal to, greater or less than the switch-off point.</p> <p>User input: 5-digit floating-point number, [unit]</p> <p>Factory setting: Depends on the setting selected in the ASSIGN STATUS function</p> <ul style="list-style-type: none"> – If LIMIT FLOW is selected: see Table → Page 109 – If LIMIT SOUND VELOCITY is selected: 800 m/s (converted to the selected UNIT SOUND VELOCITY) – If LIMIT FLOW VELOCITY is selected: 10 m/s (converted to the selected UNIT FLOW VELOCITY) – If LIMIT SIGNAL STRENGTH is selected: 50 dB – If LIMIT TOTALIZER 1 is selected: 0 (converted to the selected UNIT TOTALIZER 1) – If LIMIT TOTALIZER 2 is selected: 0 (converted to the selected UNIT TOTALIZER 2) <p> Note! The appropriate unit is taken from the SYSTEM UNITS group.</p>
TIME CONSTANT	<p> Note! This function is not available unless a limit value (apart from LIMIT TOTALIZER 1 or 2) was selected in the ASSIGN STATUS function.</p> <p>Use this function to select a time constant defining how the measuring signal reacts to severely fluctuating measured variables, either very quickly (low time constant) or with damping (high time constant). The purpose of damping, therefore, is to prevent the status output changing state continuously in response to fluctuations in flow.</p> <p>User input: 0 to 100 s</p> <p>Factory setting: 0 s</p> <p> Note! The reaction time of the function depends on the time specified in the FLOW DAMPING function. → 103</p>

Function description, PULSE, FREQUENCY, STATUS group	
ACTUAL STATUS OUTPUT	<p> Note! This function is not available unless the STATUS option was selected in the OPERATION MODE function.</p> <p>The current status of the status output appears on the display.</p> <p>Display: NOT CONDUCTIVE CONDUCTIVE</p>
SIMULATION SWITCHPOINT	<p> Note! This function is not available unless the STATUS option was selected in the OPERATION MODE function.</p> <p>Use this function to activate simulation of the status output.</p> <p>Options: OFF ON</p> <p>Factory setting: OFF</p> <p> Note!</p> <ul style="list-style-type: none"> ■ The diagnosis code message "C 482– 4 Simulation Outpt" indicates that simulation is active. →  49 ■ The measuring device continues to measure while simulation is in progress, i.e. the current measured values are output correctly via the other outputs. <p> Caution! The setting is not saved if the power supply fails.</p>
VALUE SIMULATION SWITCHPOINT	<p> Note! This function is not available unless the ON option was selected in the SIMULATION SWITCH POINT function.</p> <p>Use this function to define the switching behavior of the status output during the simulation. This value is used to test downstream devices and the measuring device itself.</p> <p>User input: NOT CONDUCTIVE CONDUCTIVE</p> <p>Factory setting: NOT CONDUCTIVE</p> <p> Note!</p> <p>You can change the switching behavior of the status output during the simulation. The prompt "CONDUCTIVE" or "NOT CONDUCTIVE" appears if the + or – key is pressed. Select the desired switching behavior and start the simulation with the  key. If the  key is pressed again afterwards, the prompt "End simulation" (NO/YES) appears. If you choose "NO", simulation remains active and the group selection is called up. The simulation can be switched off again via the SIMULATION SWITCHPOINT function. If you choose "YES", you end the simulation and the group selection is called up.</p> <p> Caution! The setting is not saved if the power supply fails.</p>

11.10 Information on the response of the status output

General information

If you have configured the status output for "LIMIT VALUE", you can specify the required switch points in the ON VALUE and OFF VALUE functions.

When the measured variable in question reaches these predefined values, the status output switches as shown in the illustrations below.

Status output configured for limit value

The status output switches as soon as the current measured variable undershoots or overshoots a defined switch point.



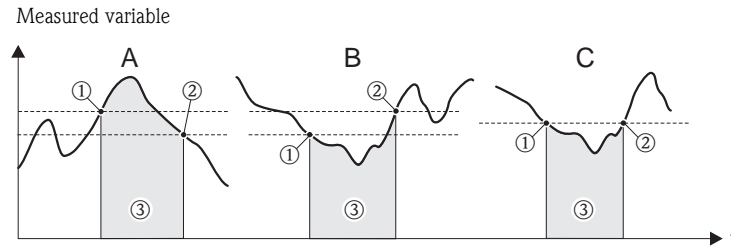



Application: monitoring flow or process-related boundary conditions.



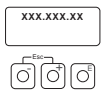
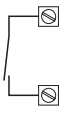

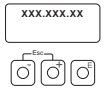
- 1 = ON \leq OFF VALUE (maximum safety)
- 2 = ON $>$ OFF VALUE (minimum safety)
- 3 = Status output switched off (not conductive)

Switching behavior of the status output





Function	Status		Open collector behavior (transistor)	
ON (operation)	System in operation	xxx.xxx.xx 	Conductive	22 23
	System not in operation (power supply failed)	xxx.xxx.xx 	Not conductive	22 23
Fault message	System OK	xxx.xxx.xx 	Conductive	22 23
	(Diagnosis code messages) fault → Error response of outputs/inputs and totalizer	xxx.xxx.xx 	Not conductive	22 23
Notice message	System OK	xxx.xxx.xx 	Conductive	22 23
	(Diagnosis code messages) fault → Continuation of measuring	xxx.xxx.xx 	Not conductive	22 23

Function	Status		Open collector behavior (transistor)	
Fault message or notice message	System OK		Conductive	
	(Diagnosis code messages) fault → Failsafe mode or notice → Continuation of measuring		Not conductive	
Limit value ■ Flow ■ Totalizer	Limit value not overshoot or undershot		Conductive	
	Limit value overshoot or undershot		Not conductive	

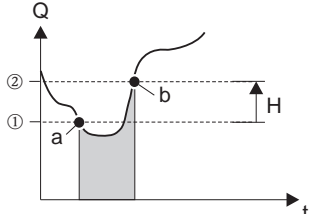

11.11 Group COMMUNICATION

Function description, COMMUNICATION group	
TAG NAME	<p>Use this function to enter a tag name for the measuring device. You can edit and read this tag name via the local display or the HART protocol.</p> <p>User input: Max. 8-character text, permitted characters are: A-Z, 0-9, +,-, punctuation marks</p> <p>Factory setting: "-----" (no text)</p>
TAG DESCRIPTION	<p>Use this function to enter a tag description for the measuring device. You can edit and read this tag description via the local display or the HART protocol.</p> <p>User input: Max. 16-character text, permitted characters are: A-Z, 0-9, +,-, punctuation marks</p> <p>Factory setting: "-----" (no text)</p>
FIELDBUS ADDRESS	<p>Use this function to define the address for the exchange of data with the HART protocol.</p> <p>User input: 0 to 15</p> <p>Factory setting: 0</p> <p> Note! A constant 4 mA current is applied with addresses 1 to 15. Simulation is not possible if the address 0 is specified.</p>
WRITE PROTECTION	<p>Use this function to check whether it is possible to write-access the flowmeter.</p> <p>Display: OFF = Data exchange is possible ON = Data exchange disabled</p> <p>Factory setting: OFF</p> <p> Note! Write protection is activated and deactivated by means of DIP switches on the I/O module. →  37</p>
MANUFACTURER ID	<p>The manufacturer number in decimal numerical format appears on the display.</p> <p>Display: 17 = (11 hex) for Endress+Hauser</p>
DEVICE ID	<p>The instrument number in hexadecimal numerical format appears on the display.</p> <p>Display: 61= Prosonic Flow 92</p>
DEVICE REVISION	<p>Displays the device-specific revision of the HART command interface.</p> <p>Display: e. g.: = 5</p>



11.12 Group PROCESS PARAMETER

Function description, PROCESS PARAMETER group	
<p>ASSIGN LOW FLOW CUTOFF</p>	<p>For selecting the measured variable on which low flow cutoff should act.</p> <p>Options: OFF FLOW FLOW VELOCITY</p> <p>Factory setting: VOLUME FLOW</p>
<p>ON VALUE LOW FLOW CUTOFF</p>	<p> Note! This function is not available if OFF has been selected in the ASSIGN LOW FLOW CUTOFF function.</p> <p>Use this function to enter the on-value for low flow cutoff. Low flow cutoff is on if the value entered is not equal to 0. As soon as the low flow cutoff is active, an inverted plus sign is shown on the local display.</p> <p>User input: 5-digit floating-point number</p> <p>Factory setting: Below the standard measuring range</p> <p> Note! The unit is taken from the FLOW function → 71.</p>
<p>OFF VALUE LOW FLOW CUTOFF</p>	<p>Use this function to enter the switch-off point (b) for low flow cutoff. Enter the switch-off point as a positive hysteresis (H) in % from the switch-on point (a).</p> <p>User input: Integer 0 to 100%</p> <p>Factory setting: 50%</p> <div style="text-align: center;">  </div> <p><i>Fig. 30:</i></p> <p>① = switch-on point , ② = switch-off point <i>a</i> low flow cutoff is switched on <i>b</i> low flow cutoff is switched off ($a + a \cdot H$) <i>H</i> Hysteresis value: 0 to 100%  low flow cutoff active <i>Q</i> Flow</p>



a000388



Function description, PROCESS PARAMETER group	
ZERO POINT ADJUST	<p> Caution! Please refer to the instructions and the exact procedure on → Page 42. Start of zero point adjustment.</p> <p>Options: CANCEL START</p> <p>Factory setting: CANCEL</p> <p> Note!</p> <ul style="list-style-type: none"> ■ The diagnosis code message "C 431 - 6" appears on the display. → 49. ■ If the zero point adjustment is not possible, (e.g. if $v > 0.1$ m/s), or has been canceled, then a diagnosis code message "C 431 - 1 to 5" appears on the display. → 49.
FIXED OPERATION DENSITY	<p>Prerequisite This function is only available if CALCULATED MASS FLOW was selected in the MEASURING UNITS function (→ 71).</p> <p>Description Use this function to enter a fixed value for the density at process conditions. This value is used to calculate the calculated mass flow and the corrected volume flow (see MEASURING UNITS function → 71).</p> <p>The appropriate unit is taken from the UNIT DENSITY function (→ 74). If the option selected in the function is changed, you are asked whether the totalizer should be reset to 0. We recommend you confirm this message and reset the totalizer.</p> <p>User input 5-digit floating-point number</p> <p>Factory setting See the parameter printout provided. The parameter printout is an integral part of these Operating Instructions.</p>

11.13 Group SYSTEM PARAMETER











Function description, SYSTEM PARAMETER group									
<p>INSTALLATION DIRECTION SENSOR</p>	<p>Use this function to reverse the sign of the flow measured variable, if necessary.</p> <p>Options: NORMAL (flow as indicated by the arrow) INVERSE (flow opposite to direction indicated by the arrow)</p> <p>Factory setting: NORMAL</p> <p> Note! Ascertain the actual direction of fluid flow with reference to the direction indicated by the arrow on the sensor (nameplate).</p>								
<p>FLOW DAMPING</p>	<p>Use this function to set the filter depth of the digital filter. This reduces the sensitivity of the measuring signal to interference peaks (e.g. in the event of high solids content, gas bubbles in the fluid, etc.). The measuring system reaction time increases with the filter setting.</p> <p>User input: 0 to 100 s</p> <p>Factory setting: 1 s</p> <p> Note! The flow damping acts on the following functions and outputs of the measuring device:</p> <table border="1" data-bbox="778 987 1509 1234"> <tr> <td colspan="2">AMPLIFICATION</td> </tr> <tr> <td colspan="2">FLOW DAMPING</td> </tr> <tr> <td>DISPLAY DAMPING</td> <td>→ Display</td> </tr> <tr> <td>TIME CONSTANT</td> <td>→ Current output → Frequency output → Status output</td> </tr> </table> <p style="text-align: right; font-size: small;">a0005914-en</p>	AMPLIFICATION		FLOW DAMPING		DISPLAY DAMPING	→ Display	TIME CONSTANT	→ Current output → Frequency output → Status output
AMPLIFICATION									
FLOW DAMPING									
DISPLAY DAMPING	→ Display								
TIME CONSTANT	→ Current output → Frequency output → Status output								
<p>POSITIVE ZERO RETURN</p>	<p>Use this function to interrupt evaluation of measured variables. This is necessary when a pipe is being cleaned, for example. The setting acts on all functions and outputs of the measuring device.</p> <p>Options: OFF ON</p> <p>Factory setting: OFF</p>								
<p>MEASURING MODE</p>	<p>For determining the measuring mode for the current output.</p> <p>Options: STANDARD SYMMETRY</p> <p>Factory setting: STANDARD</p>								

11.14 Group SENSOR DATA

Function description, SENSOR DATA group	
CALIBRATION DATE	<p>Use this function to view the current calibration date and time for the sensor..</p> <p>User interface: Calibration date and time</p> <p>Factory setting: Calibration date and time of the current calibration.</p> <p> Note! The calibration date and time format is defined in the FORMAT DATE/TIME (0429) function, →  73</p>
CALIBRATION FACTOR	<p>The calibration factor determined and set at the factory appears on the display.</p> <p>Display: 5-digit floating-point number 0.5000 to 2.0000</p> <p>Factory setting: Depends on nominal diameter and calibration.</p>
ZEROPOINT	<p>The zero point correction value determined and set at the factory appears on the display.</p> <p>Display: Max. 5-digit number: -1000 to +1000</p> <p>Factory setting: Depends on nominal diameter and calibration.</p>
ZEROPOINT STATIC	<p>The zero point correction value determined and set at the factory is adjusted. The zero point correction value (see ZEROPOINT function) can be adjusted with the value entered here. If the value 0 (factory setting) is entered, the zero point correction value determined and set at the factory is not adjusted.</p> <p>User input: Max. 5-digit number: -1000 to +1000</p> <p>Factory setting: 0</p>
CORRECTION FACTOR	<p>The calibration factor determined and set at the factory is adjusted. The calibration factor (see K-FACTOR function) can be adjusted with the value entered here. If the value 1.0000 (factory setting) is entered, the calibration factor determined and set at the factory is not adjusted.</p> <p>User input: 5-digit floating-point number 0.5000 to 2.0000</p> <p>Factory setting: 1.0000</p>
CABLE LENGTH	<p>For selecting the device version (compact version = COMPACT) or the length of the connecting cable for the remote version.</p> <p>Options: COMPACT LENGTH 5m/15feet LENGTH 10m/30 feet LENGTH 15m/45 feet LENGTH 30m/90 feet LENGTH 50m/150feet OTHER</p> <p>Factory setting: COMPACT</p> <p> Note! If OTHER is selected, the cable length effectively used can be entered in the subsequent CABLE LENGTH VARIABLE function.</p>



Function description, SENSOR DATA group	
CABLE LENGTH VARIABLE	<p>If the OTHER option is selected in the CABLE LENGTH function, the effective length of the connecting cable for the remote version can be entered in this function. If a cable length or COMPACT is selected in the CABLE LENGTH function, the corresponding value is displayed here.</p> <p>User input: Input limits: 0.00 to 50.00 or 0.00 to 150.00</p> <p>Factory setting: 0.00 (= compact version)</p> <p> Note! The appropriate unit is taken from the LENGTH function. →  71</p>

11.15 Group SUPERVISION

Function description, SUPERVISION group	
ACTUAL SYSTEM CONDITION	<p>The current system status appears on the display.</p> <p>Display: SYSTEM OK or The diagnosis messages with the highest priority appear on the display</p> <p> Note! Further information is provided in the "Troubleshooting" section on →  47</p>
PREVIOUS SYSTEM CONDITIONS	<p>Use this function to view the 16 most recent diagnosis messages since measuring last started.</p> <p>Display: The last 16 diagnosis messages</p> <p> Note! Further information is provided in the "Troubleshooting" section on →  47</p>
ASSIGN DIAGNOSTIC CODE	<p>All the diagnosis code messages and their device behavior appear on the display. By selecting the individual diagnosis code messages, the device behavior can be altered provided other options can still be selected.</p> <p>Display: CANCEL INITIALIZATION SENSOR CONNECTION AMBIENT TEMPERATURE ADJUST MEDIUM SENSOR SIGNAL SIMULATION ERROR SIMULATION OUTPUT SIGNAL OUTPUT</p> <p> Note!</p> <ul style="list-style-type: none"> ■ If the  key is pressed twice, the ERROR CATEGORY function is called up. ■ The function can be exited by using the  key combination, or by selecting the "CANCEL" parameter (in the list of diagnosis code messages). ■ List of diagnosis code messages: →  48
ERROR CATEGORY	<p>Use this function to define what device behavior a diagnosis code message triggers. If you select "ALARM", all outputs respond to an error in accordance with their defined device behavior.</p> <p>Options: NOTICE MESSAGES (display only) ALARM (outputs and display) OFF</p> <p> Note! If the  key is pressed twice, the ASSIGN DIAGNOSIS CODE function is called up.</p>
ALARM DELAY	<p>For entering the time span for which the criteria for an error have to be satisfied without interruption before a diagnosis message is generated. Depending on the setting and the diagnosis code, this suppression acts on the display, the current output and the frequency output.</p> <p>User input: 0 to 100 s (in steps of one second)</p> <p>Factory setting: 0 s</p> <p> Caution! If this function is activated, diagnosis messages are delayed before being forwarded to the higher-order controller (PCS, etc.). It is therefore imperative to check in advance whether a delay of this nature could affect the safety requirements of the process. If diagnosis messages may not be suppressed, a value of 0 seconds must be entered here.</p>

Function description, SUPERVISION group	
TROUBLESHOOTING	<p>For acknowledging the diagnosis messages for data/checksum errors.</p> <p>If a data/checksum error occurs (diagnosis messages F283-1, F283-2 or F283-4, see → Page 47 ff.), the associated error block is displayed in this function and the functions of the error block are reset to the factory setting. Only the diagnosis message in question is acknowledged by selecting the error block in this function.</p> <p>Display: CANCEL The error block in which a data/checksum error was present appears on the display</p>
SYSTEM RESET	<p>For restarting (resetting) the device.</p> <p>Options:</p> <p>NO The device is not restarted.</p> <p>MEASURING TUBE Restart without disconnecting main power. In doing so, the sensor data (zero point, cal. factor, etc.) are reset to the factory setting. All the other data (functions) are accepted unchanged.</p> <p>RESTART Restart without disconnecting main power. In doing so, all the data (functions) are accepted unchanged.</p> <p>RESET DELIVERY Restart without disconnecting main power. In doing so, all the data (functions) apart from the sensor data are reset to the factory setting.</p> <p>Factory setting: NO</p>
OPERATION HOURS	<p>The hours of operation of the device appear on the display.</p> <p>Display: Depends on the number of hours of operation elapsed: Hours of operation < 10 hours → display format = 0:00:00 (hr:min:sec) Hours of operation 10 to 10 000 hours → display format = 0000:00 (hr:min) Hours of operation < 10 000 hours → display format = 000000 (hr)</p>

11.16 Group SIMULATION SYSTEM

Function description, SIMULATION SYSTEM group	
SIMULATION FAILSAFE MODE	<p>Use this function to set all inputs, outputs and the totalizer to their defined failsafe modes, in order to check whether they respond correctly. During this time, the diagnosis message C 484 "Simulation Error" appears on the local display. → 49</p> <p>Options: OFF ON</p> <p>Factory setting: OFF</p>
SIMULATION MEASURAND	<p>Use this function to set all inputs, outputs and the totalizer to their defined flow-response modes, in order to check whether they respond correctly. During this time, the diagnosis message C 485 "Simulation Value" appears on the local display. → 49</p> <p>Options: OFF FLOW SOUND VELOCITY FLOW VELOCITY SIGNAL STRENGTH</p> <p>Factory setting: OFF</p> <p> Note!</p> <ul style="list-style-type: none"> ■ The measuring device can only be used for measuring to a certain extent while the simulation is in progress. ■ The setting is not saved if the power supply fails.
VALUE SIMULATION MEASURAND	<p> Note! This function is not available if OFF has been selected in the SIMULATION MEASURAND function.</p> <p>For specifying a freely selectable value (e.g. 12 m³/s) to check the assigned functions in the device itself and downstream signal circuits.</p> <p>User input: 5-digit floating-point number</p> <p>Factory setting: 0</p> <p> Note!</p> <ul style="list-style-type: none"> ■ The measuring device can only be used for measuring to a certain extent while the simulation is in progress. ■ The unit is taken from the SYSTEM UNITS group. → 71

11.17 Group SENSOR VERSION

Function description, SENSOR VERSION group	
SERIAL NUMBER	The serial number of the sensor appears on the display.

11.18 Group AMPLIFIER VERSION

Function description, AMPLIFIER VERSION group	
DEVICE SOFTWARE	The current device software version appears on the display.
I/O TYPE	The configuration of the I/O module with terminal numbers appears on the display.

12 Factory settings

12.1 Metric system units (not for USA and Canada)

12.1.1 Low flow cut off, fullscale value, pulse value, totalizer → Page 71

Nominal Diameter (mm)	Low flow cut off (approx. $V = 0.1$ m/s)		Full scale value current output (approx. $V = 5$ m/s)		Pulse value		Totalizer
25	3	dm ³ /min	150	dm ³ /min	1	dm ³	dm ³
40	7.5	dm ³ /min	375	dm ³ /min	2.5	dm ³	dm ³
50	11	dm ³ /min	550	dm ³ /min	4	dm ³	dm ³
80	30	dm ³ /min	1500	dm ³ /min	10	dm ³	dm ³
100	47	dm ³ /min	2350	dm ³ /min	16	dm ³	dm ³
150	0.1	m ³ /min	5	m ³ /min	0.03	m ³	m ³
200	0.2	m ³ /min	10	m ³ /min	0.07	m ³	m ³
250	0.3	m ³ /min	15	m ³ /min	0.1	m ³	m ³
300	0.4	m ³ /min	20	m ³ /min	0.13	m ³	m ³

12.1.2 Language → Page 76

Country	Language	Country	Language
Australia	English	Luxembourg	Francais
Austria	Deutsch	Malaysia	English
Belgium	English	Netherlands	Nederlands
Czechia	Ceski	Norway	Norsk
Denmark	English	Poland	Polski
England	English	Portugal	Portugues
Finland	Suomi	Singapore	English
France	Francais	South Africa	English
Germany	Deutsch	Spain	Espanol
Hong Kong	English	Sweden	Svenska
Hungary	English	Switzerland	Deutsch
India	English	Thailand	English
Italy	Italiano	Other countries	English

12.1.3 Unit totalizer 1 + 2 → 79

Assign totalizer	Unit
Volume flow	m ³ or dm ³

12.2 US units (only for USA and Canada)

12.2.1 low flow cut off, full scale value, pulse value, totalizer → 71

Nominal Diameter (inch)	Low flow cut off (approx. V = 0.1 m/s)		Full scale value current output (approx. V = 5 m/s)		Pulse value		Totalizer
		us.gal/min		us.gal/min		us.gal/min	
1"	0.8	us.gal/min	40	us.gal/min	0.25	us.gal/min	us.gal/min
1 ½"	2	us.gal/min	100	us.gal/min	0.5	us.gal/min	us.gal/min
2"	3	us.gal/min	150	us.gal/min	1	us.gal/min	us.gal/min
3"	8	us.gal/min	400	us.gal/min	2.5	us.gal/min	us.gal/min
4"	12.5	us.gal/min	625	us.gal/min	5	us.gal/min	us.gal/min
6"	28	us.gal/min	1400	us.gal/min	10	us.gal/min	us.gal/min
8"	53	us.gal/min	2640	us.gal/min	20	us.gal/min	us.gal/min
10"	79	us.gal/min	3965	us.gal/min	25	us.gal/min	us.gal/min
12"	106	us.gal/min	5285	us.gal/min	35	us.gal/min	us.gal/min

Index

Numerics

100% VALUE LINE 1 (fct.)	77
100% VALUE LINE 2 (fct.)	77

A

ACCESS CODE (fct.)	76
Access code (function matrix)	25
ACCESS CODE COUNTER (fct.)	76
Accessories	45
ACTUAL CURRENT (fct.)	83
ACTUAL FREQUENCY (fct.)	89
ACTUAL PULSE (fct.)	94
ACTUAL STATUS OUTPUT (fct.)	97
ACTUAL SYSTEM CONDITION (fct.)	106
ALARM DELAY (fct.)	106
Ambient temperature range	63
Applicator (selection software)	46
Approvals	9
ASSIGN CURRENT OUTPUT (fct.)	82
ASSIGN DIAGNOSTIC CODE (fct.)	106
ASSIGN FREQUENCY (fct.)	85
ASSIGN LINE 1 (fct.)	77
ASSIGN LINE 2 (fct.)	77
ASSIGN LOW FLOW CUTOFF (fct.)	101
ASSIGN PULSE (fct.)	90
ASSIGN STATUS (fct.)	95
ASSIGN TOTALIZER (fct.)	79

C

Cable entry	
Degree of protection	21
Technical data	62
CABLE LENGTH (fct.)	104
CABLE LENGTH VARIABLE (fct.)	105
Cable specifications (remote version)	16
CALCULATION FACTOR (fct.)	104
CALIBRATION DATE (fct.)	104
CE mark (declaration of conformity)	9
Certificates	9
Cleaning	
Exterior cleaning	44
Commissioning	
Zero point adjustment	42
Commubox FXA 195 (electrical connection)	45
Commubox FXA195 (electrical connection)	20
Communication	26
Connection	
See Electrical connection	
CONTRAST LCD (fct.)	78
CORRECTION FACTOR (fct.)	104
C-tick mark	9
Current output	
Technical data	60
CURRENT SPAN (fct.)	82

D

Data backup	41
Declaration of conformity (CE mark)	9
DEFINE PRIVATE CODE (fct.)	76
Degree of protection	21, 63
Device description files	28
Device designation	7
DEVICE ID (fct.)	100
DEVICE SOFTWARE (fct.)	108
Device status	35
Device variables	29
Diagnosis code messages	
Category C	49
Category F	48
Category S	50
Display	23
Display and operating elements	23
Turning the display	14
DISPLAY DAMPING (fct.)	78
Disposal	58
Documentation	67

E

Electrical connection	
Cable specifications (remote version)	16
Commubox FXA195	20
Degree of protection	21
HART handheld terminal	20
Remote version	16
END VALUE FREQUENCY (fct.)	85
ERROR CLASS (fct.)	106
Ex approval	66
Exterior cleaning	44

F

FAILSAFE ALL TOTALIZERS (fct.)	81
FAILSAFE MODE (fct.)	83, 89, 94
Failsafe mode, inputs/outputs	52
FIELDBUS ADDRESS (fct.)	100
FieldCare	27
Fieldcheck (tester and simulator)	46
FIXED OPERATION DENSITY (fct.)	102
FLOW DAMPING (fct.)	103
FLOW VELOCITY (fct.)	70
FORMAT (fct.)	78
FORMAT DATE/TIME (fct.)	73
Function check	38
Function groups	24
Function matrix (brief operating instructions)	24
Functions	24
Functions, function groups	24
FXA193	46
FXA195	45

G

Galvanic isolation 61

H

HART

Command classes 26

Command No. 30

Device status, diagnosis code messages 35

Electrical connection 20

Error messages 30

Handheld terminal 27

HistoROM/T-DAT 43

I

I/O TYPE (fct.) 108

Incoming acceptance 10

Inlet runs 13

Inputs

Measured variable 59

Measuring ranges 59

Installation

See Installation conditions

Installation conditions

Dimensions 11

Mounting location 11

System pressure 12

Vertical pipe 11

INSTALLATION DIRECTION SENSOR (fct.) 103

Installation instructions 62

Insulation of sensors 13

L

LANGUAGE (fct.) 76

Length of connecting cable 16

Load 61

Local display

See Display

Low flow cutoff 61

M

Maintenance 44

MANUFACT ID (fct.) 100

Material load diagram 64–65

MEASURED VALUES 70

Measured variables 59

MEASURING MODE (fct.) 103

Measuring principle 59

Measuring range 59

Measuring system 7

MEASURING UNITS 71

MEASURING UNITS (fct.) 71

N

Nameplate

Connections 8

Sensor 8

O

OFF VALUE (fct.) 96

OFF VALUE LOW FLOW CUTOFF (fct.) 101

ON VALUE (fct.) 96

ON VALUE LOW FLOW CUTOFF (fct.) 101

Operating conditions 62–63

Operation

Device description files 28

Display and operating elements 23

FieldCare 27

Function matrix 24

HART handheld terminal 27

OPERATION HOURS (fct.) 107

OPERATION MODE (fct.) 85

Order code

Accessories 45

Transmitter 7–8

Ordering information 67

Outlet runs 13

Output signal 60

OUTPUT SIGNAL (fct.) 87, 92

Outputs

Current output 60

Pulse/status output 60

Response to errors 52

OVERFLOW (fct.) 79

P

Performance characteristics

Reference operating conditions 62

Repeatability 62

POSITIVE ZERO RETURN (fct.) 103

Power supply (supply voltage) 62

PREVIOUS SYSTEM CONDITIONS (fct.) 106

Process errors without messages 51

Process variable 29

Programming mode

Disabling 25

Enable 25

PULSE VALUE (fct.) 90

PULSE WIDTH (fct.) 91

Pumps, mounting location, system pressure 12

Q

QUICK SETUP COMMISSIONING (fct.) 75

R

Registered trademarks 9

Remote operation 66

Repeatability (performance characteristics) 62

RESET ALL TOTALIZERS (fct.) 81

RESET TOTALIZER (fct.) 80

S

Safety icons 6

Sensor heating 12

Serial number 7–8

SERIAL NUMBER (fct.) 108

Signal on alarm 60

SIGNAL STRENGTH (fct.) 70

SIMULATION CURRENT (fct.) 83

SIMULATION FAILSAFE MODE (fct.) 108

SIMULATION FREQUENCY (fct.) 89

SIMULATION MEASURAND (fct.)	108
SIMULATION PULSE (fct.)	94
SIMULATION SWITCHPOINT (fct.)	97
Software	
Amplifier display	38
Versions (history)	58
SOUND VELOCITY (fct.)	70
Spare parts	53
Standards, guidelines	66
START VALUE FREQUENCY (fct.)	85
STATUS ACCESS (fct.)	76
Storage	10
SUM (fct.)	79
Supply voltage (power supply)	62
SYSTEM RESET (fct.)	107

T

TAG DESCRIPTION (fct.)	100
TAG NAME (fct.)	100
T-DAT	43
Save/load	41
T-DAT SAVE/LOAD (fct.)	75
Temperature ranges	
Ambient temperature range	63
Storage temperature	63
TEST DISPLAY (fct.)	78
Thermal insulation, general notes	13
TIME CONSTANT (fct.)	83, 89, 96
TOTALIZER MODE (fct.)	80
Transport, sensor	10
Troubleshooting	47
TROUBLESHOOTING (fct.)	107

U

UNIT LENGTH (fct.)	74
UNIT MASS (fct.)	73
UNIT TOTALIZER (fct.)	80
UNIT VELOCITY (fct.)	74
UNIT VOLUME	73
UNIT VOLUME (fct.)	72–73

V

VALUE 20 mA (fct.)	83
VALUE 4 mA (fct.)	82
VALUE SIMULATION CURRENT (fct.)	84
VALUE SIMULATION FREQUENCY (fct.)	90
VALUE SIMULATION MEASUREMENT (fct.)	108
VALUE SIMULATION PULSE (fct.)	95
VALUE SIMULATION SWITCHPOINT (fct.)	97
VALUE-F-HIGH (fct.)	86
VALUE-F-LOW (fct.)	86
Vertical pipe	11
Vibration resistance	63
Vibrations	63
VOLUME FLOW (fct.)	70

W

Weight	64
Wiring	
See Electrical connection	
WRITE PROTECT (fct.)	100

Z

Zero point adjustment	42
ZERO POINT ADJUSTMENT (fct.)	102
ZEROPOINT (fct.)	104
ZEROPOINT STATIC (fct.)	104

Declaration of Hazardous Material and De-Contamination *Erklärung zur Kontamination und Reinigung*

RA No.

Please reference the Return Authorization Number (RA#), obtained from Endress+Hauser, on all paperwork and mark the RA# clearly on the outside of the box. If this procedure is not followed, it may result in the refusal of the package at our facility.
Bitte geben Sie die von E+H mitgeteilte Rücklieferungsnummer (RA#) auf allen Lieferpapieren an und vermerken Sie diese auch außen auf der Verpackung. Nichtbeachtung dieser Anweisung führt zur Ablehnung ihrer Lieferung.

Because of legal regulations and for the safety of our employees and operating equipment, we need the "Declaration of Hazardous Material and De-Contamination", with your signature, before your order can be handled. Please make absolutely sure to attach it to the outside of the packaging.

Aufgrund der gesetzlichen Vorschriften und zum Schutz unserer Mitarbeiter und Betriebseinrichtungen, benötigen wir die unterschriebene "Erklärung zur Kontamination und Reinigung", bevor Ihr Auftrag bearbeitet werden kann. Bringen Sie diese unbedingt außen an der Verpackung an.

Type of instrument / sensor

Geräte-/Sensortyp _____

Serial number

Seriennummer _____

Used as SIL device in a Safety Instrumented System / Einsatz als SIL Gerät in Schutzeinrichtungen

Process data / Prozessdaten

Temperature / *Temperatur* _____ [°F] _____ [°C]

Pressure / *Druck* _____ [psi] _____ [Pa]

Conductivity / *Leitfähigkeit* _____ [µS/cm]

Viscosity / *Viskosität* _____ [cp] _____ [mm²/s]

Medium and warnings

Warnhinweise zum Medium



	Medium /concentration <i>Medium /Konzentration</i>	Identification CAS No.	flammable <i>entzündlich</i>	toxic <i>giftig</i>	corrosive <i>ätzend</i>	harmful/ irritant <i>gesundheitsschädlich/ reizend</i>	other * <i>sonstiges*</i>	harmless <i>unbedenklich</i>
Process medium <i>Medium im Prozess</i>								
Medium for process cleaning <i>Medium zur Prozessreinigung</i>								
Returned part cleaned with <i>Medium zur Endreinigung</i>								

* explosive; oxidising; dangerous for the environment; biological risk; radioactive

* *explosiv; brandfördernd; umweltgefährlich; biogefährlich; radioaktiv*

Please tick should one of the above be applicable, include safety data sheet and, if necessary, special handling instructions.

Zutreffendes ankreuzen; trifft einer der Warnhinweise zu, Sicherheitsdatenblatt und ggf. spezielle Handhabungsvorschriften beilegen.

Description of failure / Fehlerbeschreibung _____

Company data / Angaben zum Absender

Company / <i>Firma</i> _____	Phone number of contact person / <i>Telefon-Nr. Ansprechpartner:</i> _____
Address / <i>Adresse</i> _____	Fax / E-Mail _____
	Your order No. / <i>Ihre Auftragsnr.</i> _____

"We hereby certify that this declaration is filled out truthfully and completely to the best of our knowledge. We further certify that the returned parts have been carefully cleaned. To the best of our knowledge they are free of any residues in dangerous quantities."

"Wir bestätigen, die vorliegende Erklärung nach unserem besten Wissen wahrheitsgetreu und vollständig ausgefüllt zu haben. Wir bestätigen weiter, dass die zurückgesandten Teile sorgfältig gereinigt wurden und nach unserem besten Wissen frei von Rückständen in gefährbringender Menge sind."

(place, date / Ort, Datum)

Name, dept./ *Abt.* (please print / *bitte Druckschrift*)

Signature / *Unterschrift*

www.endress.com/worldwide

Endress+Hauser 
People for Process Automation
