

Operating Instructions

Memosens

Sensor inputs with Memosens protocol

For all devices in the Liquiline family: CM44x, CM44xR,
CM44P, CSFXX, CSP44, CA80XX

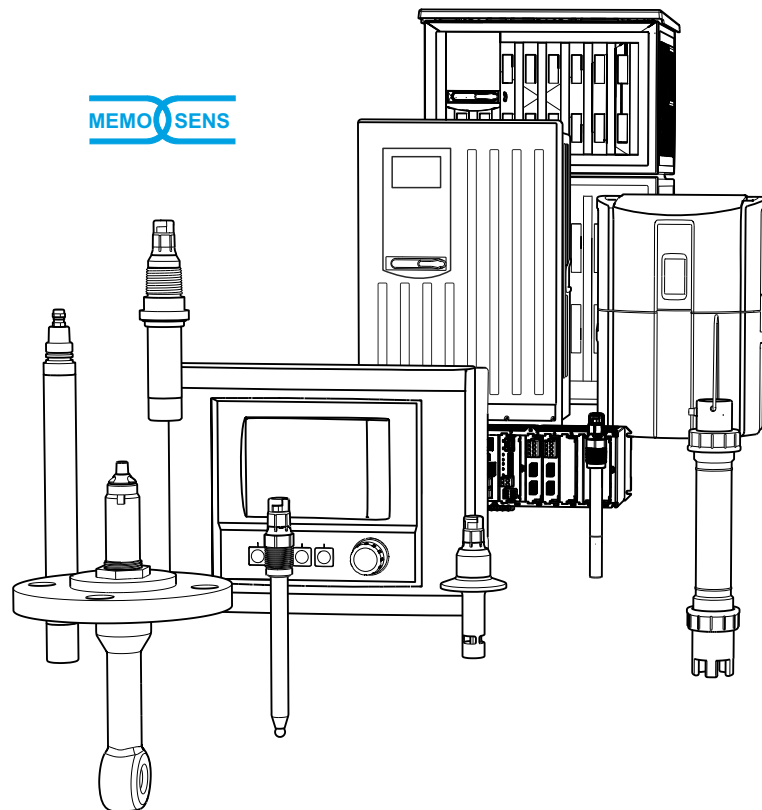





Table of contents







1	Document information	4	12.2	Advanced setup	92
1.1	Warnings	4	13	Inputs: ISE	99
1.2	Symbols	4	13.1	Basic settings	99
1.3	Documentation	5	13.2	Advanced setup	100
2	Information on sensors with Memosens protocol	6	13.3	Electrode slot menus	103
3	Electrical connection	7	14	Inputs: Interface	110
3.1	Sensor types with Memosens protocol	7	14.1	Basic settings	110
3.2	Connecting sensors with Memosens protocol	7	14.2	Tank configuration	110
4	Inputs: General	10	14.3	Sensor signal	112
5	Inputs:pH/ORP	11	14.4	Advanced setup	113
5.1	Basic settings	11	15	Diagnostics and troubleshooting ..	117
5.2	Advanced setup	12	15.1	Process errors without messages	117
5.3	Name check	23	15.2	Overview of diagnostic information	124
5.4	Sensor replacement	23	15.3	Sensor information	140
5.5	Data processing factory setting	23	16	Maintenance	141
6	Inputs: Conductivity	24	16.1	Cleaning digital sensors	141
6.1	Basic settings	24	16.2	Cleaning assemblies	141
6.2	Advanced setup	31	16.3	Performing a decade resistance test on digital inductive conductivity sensors	142
7	Inputs: Oxygen	38	17	Calibration	143
7.1	Basic settings	38	17.1	Definitions	143
7.2	Advanced setup	39	17.2	Terminology	143
8	Inputs: disinfection	53	17.3	Calibration instructions	145
8.1	Basic settings	53	17.4	pH sensors	145
8.2	Advanced setup	54	17.5	ORP sensors	150
9	Inputs: Drinking water turbidity	66	17.6	Conductivity sensors	152
9.1	Basic settings	66	17.7	Oxygen sensors	155
9.2	Advanced setup	67	17.8	Disinfection sensors	162
10	Inputs: Turbidity and solids	75	17.9	Ion-selective sensors	166
10.1	Basic settings	75	17.10	Turbidity and solids sensors	171
10.2	Advanced setup	76	17.11	SAC sensor	181
11	Inputs: SAC	83	17.12	Nitrate sensors	185
11.1	Basic settings	83	17.13	Calibration accessories	190
11.2	Advanced setup	84	Index	192	
12	Inputs: Nitrate	91			
12.1	Basic settings	91			

1 Document information

1.1 Warnings

Structure of information	Meaning
 DANGER Causes (/consequences) If necessary, Consequences of non-compliance (if applicable) ▶ Corrective action	This symbol alerts you to a dangerous situation. Failure to avoid the dangerous situation will result in a fatal or serious injury.
 WARNING Causes (/consequences) If necessary, Consequences of non-compliance (if applicable) ▶ Corrective action	This symbol alerts you to a dangerous situation. Failure to avoid the dangerous situation can result in a fatal or serious injury.
 CAUTION Causes (/consequences) If necessary, Consequences of non-compliance (if applicable) ▶ Corrective action	This symbol alerts you to a dangerous situation. Failure to avoid this situation can result in minor or more serious injuries.
NOTICE Cause/situation If necessary, Consequences of non-compliance (if applicable) ▶ Action/note	This symbol alerts you to situations which may result in damage to property.

1.2 Symbols

Symbol	Meaning
	Additional information, tips
	Permitted or recommended
	Not permitted or not recommended
	Reference to device documentation
	Reference to page
	Reference to graphic
	Result of a step

1.3 Documentation

The following instructions complement these Operating Instructions and are available on the product pages on the Internet:

- Operating Instructions
 - Liquiline CM44x, BA00444C
 - Liquiline CM44xR, BA01225C
 - Liquiline CM44P, BA01570C
 - Liquistation CSF48, BA00443C
 - Liquiport CSP44, BA00465C
 - Liquistation CSF34, BA00478C
 - Liquistation CSF39, BA01407C
 - Lquisystem CA80AM, BA01240C
 - Lquisystem CA80PH, BA01416C and BA01435C
 - Lquisystem CA80NO, BA01574C
 - Lquisystem CA80CR, BA01575C
 - Lquisystem CA80AL, BA001585C
 - Lquisystem CA80FE, BA01586C
 - Lquisystem CA80COD, BA01354C
 - Lquisystem CA80TP, BA01593C
 - Lquisystem CA80HA, BA01772C
 - Lquisystem CA80SI, BA01650C
- Brief Operating Instructions for the devices mentioned
- Technical Information for the devices mentioned
- Liquiline Operating Instructions for HART communication, BA00486C
 - Onsite settings and installation instructions for HART
 - Description of HART driver
- Guidelines for communication via fieldbus and web server
 - HART, SD01187C
 - PROFIBUS, SD01188C
 - Modbus, SD01189C
 - Web server, SD01190C
 - EtherNet/IP, SD01293C

2 Information on sensors with Memosens protocol

Sensors with Memosens protocol have an integrated electronics unit that stores calibration data and other information. Once the sensor has been connected, the sensor data are transferred automatically to the transmitter and used to calculate the measured value.

- ▶ Call up the sensor data via the corresponding DIAG menu.

Digital sensors can store measuring system data in the sensor. These include the following:

- Manufacturer data
 - Serial number
 - Order code
 - Date of manufacture
- Calibration data
 - Calibration date
 - Calibration values
 - Number of calibrations
 - Serial number of the transmitter used to perform the last calibration
- Operating data
 - Temperature application range
 - Date of initial commissioning
 - Hours of operation under extreme conditions
 - Sensor monitoring data

 Which exact data are recorded and communicated to the transmitter is dependent on the sensor. Even within a sensor type, differences may occur. This means that, depending on which sensor is connected, menu items may or may not be available. Please note the relevant information in this manual.

Example:

The amperometric oxygen sensor COS51D cannot be sterilized. For this reason, limit values for sterilization cannot be defined in the diagnostic settings for this sensor. However, these menu items are available for a sterilizable amperometric sensor, e.g. COS22D.

3 Electrical connection

⚠ WARNING

Device is live!

Incorrect connection may result in injury or death!

- ▶ The electrical connection may be performed only by an electrical technician.
- ▶ The electrical technician must have read and understood these Operating Instructions and must follow the instructions contained therein.
- ▶ **Prior** to commencing connection work, ensure that no voltage is present on any cable.

3.1 Sensor types with Memosens protocol

Sensors with Memosens protocol



Sensor types	Sensor cable	Sensors
Digital sensors without additional internal power supply	With plug-in connection and inductive signal transmission	<ul style="list-style-type: none"> ▪ pH sensors ▪ ORP sensors ▪ Combined sensors ▪ Oxygen sensors (amperometric and optical) ▪ Conductivity sensors with conductive measurement of conductivity ▪ Chlorine sensors (disinfection)
	Fixed cable	Conductivity sensors with inductive measurement of conductivity
Digital sensors with additional internal power supply	Fixed cable	<ul style="list-style-type: none"> ▪ Turbidity sensors ▪ Sensors for interface measurement ▪ Sensors for measuring the spectral absorption coefficient (SAC) ▪ Nitrate sensors ▪ Optical oxygen sensors ▪ Ion-sensitive sensors

The following rule applies if connecting CUS71D sensors:

- CM442R
 - Only one CUS71D is possible; an additional sensor is not permitted.
 - The second sensor input may also not be used for another type of sensor.
- CM444R
 - No restrictions. All the sensor inputs can be used as required.
- CM448R
 - If a CUS71D is connected, the number of sensor inputs that can be used is limited to a maximum of 4.
 - Of these, all 4 inputs can be used for CUS71D sensors.
 - Every combination of CUS71D and other sensors is possible, provided that the total number of connected sensors does not exceed 4.

3.2 Connecting sensors with Memosens protocol

Connection Types of connection

- Direct connection of sensor cable to terminal connector of the sensor module 2DS or of base module L, H or E (→  1 ff.)
- Optional: Sensor cable plug connected to the M12 sensor socket on the underside of the device
 - With this type of connection, the device is already wired at the factory (→  4).

1. Sensor cable connected directly

Connect the sensor cable to the Memosens terminal connector of the sensor module 2DS or of base module L, H or E.

2. When connecting via M12 connector
Connect the sensor connector to an M12 sensor socket which has been previously installed or is supplied on delivery.

Sensor cable connected directly

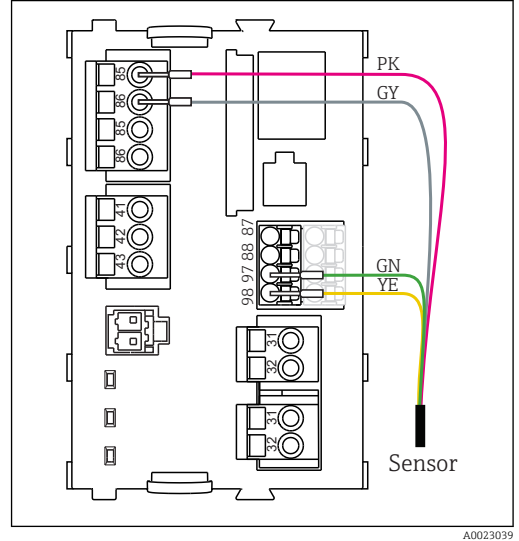
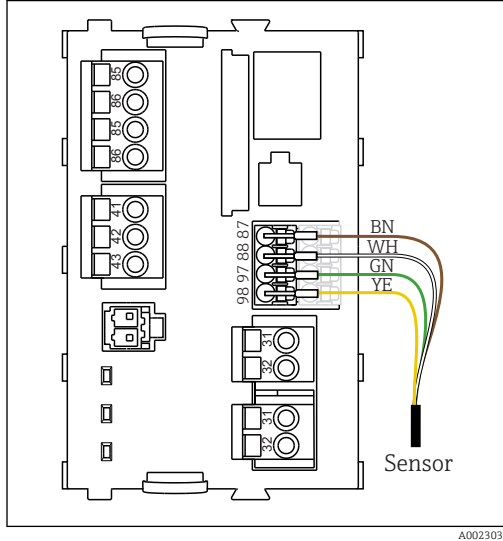

1 sensors without additional supply voltage

2 sensors with additional supply voltage

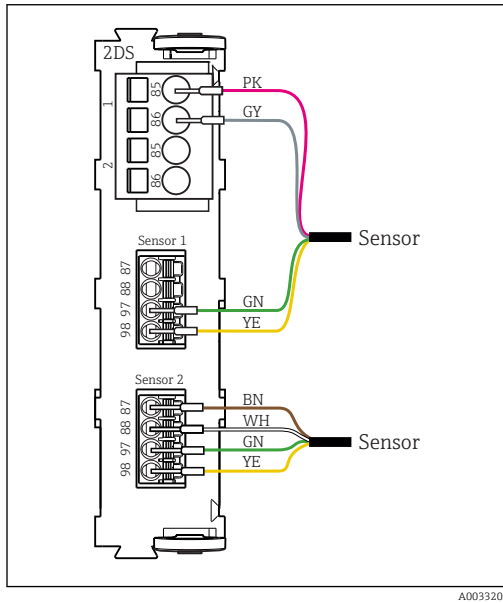

3 sensors with and without additional supply voltage at sensor module 2DS

connection via M12 plug-in connection

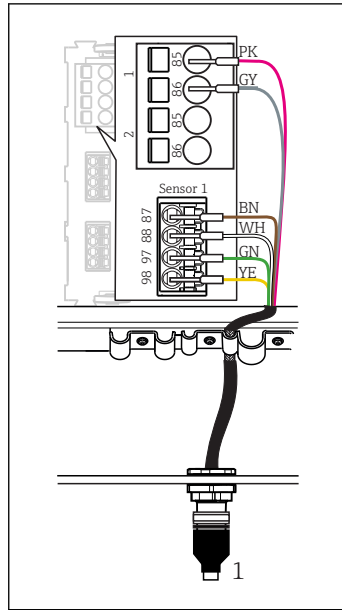

A0018019

4 M12 plug-in connection (e.g. at sensor module)

1 Sensor cable with M12 connector

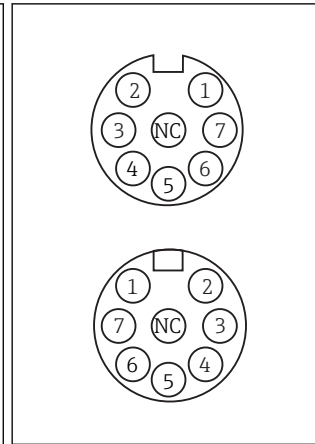

A0018021

5 M12 assignment Top: socket Bottom: connector (top view in each case)

- 1 PK (24 V)
- 2 GY (Ground 24 V)
- 3 BN (3 V)
- 4 WH (Ground 3 V)
- 5 GN (Memosens)
- 6 YE (Memosens)
- 7, NC Not connected

Device versions with a pre-installed M12 socket are ready-wired upon delivery.

Version without a pre-installed M12 socket

1. Insert an M12 socket (accessory) into a suitable opening in the base of the housing.
2. Connect the cable to a Memosens terminal as per the wiring diagram.

Connecting the sensor

- Plug the connector of the sensor cable (→ 4item 1) directly into the M12 socket.

Please note the following:

- The internal device wiring is always the same regardless of what kind of sensor you connect to the M12 socket (plug&play).
- The signal or power supply cables are assigned in the sensor head in such a way that the PK and GY power supply cables are either used (e.g. optical sensors) or not (e.g. pH or ORP sensors).

4 Inputs: General

An input can be configured in one of two ways:

- Configuration where a sensor is not connected
- Configuration where a sensor is connected

Configuration where a sensor is not connected

Some settings require sensor communication. You cannot make these settings if a sensor is not connected.



It is also possible to save a setup and transfer it to another device (→ Operating Instructions for the device, →  6). This function might be a better option than performing a configuration when a sensor is not connected.

1. Select the relevant channel.
2. From the list of sensor types, select the sensor that you want to configure.
3. Configure the channel as explained in the following sections.
4. At a later point, connect a sensor of the selected type.
 - ↳ The channel is ready for operation immediately.

Configuration where a sensor is connected

- ▶ Configure the channel as explained in the following sections.

5 Inputs:pH/ORP

5.1 Basic settings

5.1.1 Sensor identification

Menu/Setup/Inputs/Channel: sensor type		
Function	Options	Info
Channel	Selection <ul style="list-style-type: none"> ▪ Off ▪ On Factory setting On	On The channel display is switched on in the measuring mode Off The channel is not displayed in the measuring mode, regardless of whether a sensor is connected or not.
Sensor type	Read only (Only available if a sensor is connected)	Connected sensor type
Order code		Order code of the connected sensor

5.1.2 Main value

Menu/Setup/Inputs/Channel: pH or ORP or pH/ORP		
Function	Options	Info
Main value	Selection <ul style="list-style-type: none"> ▪ pH ¹⁾ ▪ mV ²⁾ ▪ ORP mV ³⁾ ▪ ORP % ³⁾ ▪ pH/ORP/rH ⁴⁾ Factory setting <ul style="list-style-type: none"> ▪ pH ¹⁾ ▪ ORP mV ⁵⁾ 	Select how the main measured value should be displayed. Subsequent configuration options depend on the option selected here. You can display the main measured value of a pH sensor as a pH value or as a raw value in mV. If using an ORP sensor, here you decide which ORP mode to use: mV or %. If you have connected a combined sensor, you can also select the rH value. Note the following for pH/ORP combined sensors: Select pH/ORP/rH as the main value if you want to calibrate pH and ORP.

- 1) pH sensor and pH/ORP combined sensor
- 2) pH sensor
- 3) ORP sensor and pH/ORP combined sensor
- 4) pH/ORP combined sensor
- 5) ORP sensor

5.1.3 Damping

The damping causes a floating average curve of the measured values over the time specified.

Menu/Setup/Inputs/Channel: sensor type		
Function	Options	Info
Depends on the sensor ¹⁾	0 to 600 s	You specify the damping of the main measured value and that of the integrated temperature sensor.
Damping temp.	Factory setting 0 s	



1) **Damping pH** or **Damping ORP** or **Damping Cond** or **Damping DO** or **Damping DI** or **Damping nitrate** or **Damping SAC** or **Damping turbidity**

5.1.4 Manual hold

Menu/Setup/Inputs/Channel: sensor type		
Function	Options	Info
Manual hold	Selection <ul style="list-style-type: none"> ▪ Off ▪ On Factory setting Off	On You can use this function to set the channel manually to "Hold". Off No channel-specific hold

5.2 Advanced setup

5.2.1 Temperature and medium compensation (only pH and pH/ORP)

Menu/Setup/Inputs/Channel: pH or pH/ORP/► Extended setup		
Function	Options	Info
Temp. compensation	Selection <ul style="list-style-type: none"> ▪ Off ▪ Automatic ▪ Manual Factory setting Automatic	Decide how you want to compensate the medium temperature: <ul style="list-style-type: none"> ▪ Automatically using the temperature sensor of your sensor (ATC) ▪ Manually by entering the medium temperature ▪ Not at all
Temperature Temp. compensation = Manual	-50 to 250 °C (-58 to 482 °F) Factory setting 25 °C (77 °F)	Specify the medium temperature.
 This setting only refers to compensation during measurement. You enter the compensation for calibration in the calibration settings.		
Medium comp.	Selection <ul style="list-style-type: none"> ▪ Off ▪ 2-point calibration ▪ Table Factory setting Off	Take a sample from the medium and determine its pH value at different temperatures in the lab. Decide whether you want to compensate using two points or several points in a table.
 The dissociation of water changes with increasing temperature. The balance shifts towards the protons; the pH value drops. You can balance out this effect with the Medium comp. function.		
Internal buffer	pH 0 to 14 Factory setting pH 7.00	Only change the value if you are using a sensor with an internal buffer other than pH 7.

5.2.2 Measured value formats

Menu/Setup/Inputs/Channel: pH or ORP or pH/ORP/▶ Extended setup		
Function	Options	Info
Main value format <i>only pH and pH/ORP</i>	Selection <ul style="list-style-type: none"> ▪ #.# ▪ #.## 	Specify the number of decimal places.
Temperature format	Factory setting #.#	

5.2.3 Cleaning hold

Menu/Setup/Inputs/Channel: Sensor type/▶ Extended setup		
Function	Options	Info
Cleaning hold	Selection <ul style="list-style-type: none"> ▪ None ▪ Cleaning 1 ... 4 Factory setting None	<ul style="list-style-type: none"> ▶ For selecting one or more cleaning programs (multiple selection). <ul style="list-style-type: none"> ↳ For the programs defined, the channel goes to "Hold" while cleaning is in progress. Cleaning programs are executed: <ul style="list-style-type: none"> ▪ At a specified interval For this, the cleaning program must be started. ▪ If a diagnostics message is pending on the channel and a cleaning has been specified for this message (→ Inputs/Channel: Sensor type/Diagnostics settings/Diag. behavior/Diagnostic number/Cleaning program).

 You define the cleaning programs in the **Setup/Additional functions/Cleaning**.

5.2.4 External hold

You can trigger a hold for all the devices of a measuring point via a digital signal, e.g. a fieldbus signal. Make sure that you do not use the hold signal elsewhere. You can assign an external hold individually to every sensor input.

 You will only find the function in the initial menu if you have configured the signals for the external hold in the general hold settings beforehand:

Menu/Setup/General settings/Hold settings/External hold.

Menu/Setup/Inputs/Channel: Sensor type/Extended setup/▶ External hold		
Function	Options	Info
Source	Selection <ul style="list-style-type: none"> ▪ Binary inputs ▪ Fieldbus signals Factory setting None	<ol style="list-style-type: none"> 1. For selecting the signal source of the external hold. <ul style="list-style-type: none"> ↳ Multiple selection is possible. 2. OK: confirms selection.

5.2.5 Calibration settings

Stability criteria

You define the permitted measured value fluctuation which must not be exceeded in a certain timeframe during calibration. If the permitted difference is exceeded, calibration is not permitted and is aborted automatically.

Menu/Setup/Inputs/Channel: pH or ORP or pH/ORP/Extended setup/Calib. settings/► Stability criteria		
Function	Options	Info
Delta mV	1 to 10 mV Factory setting 1 mV	Permitted measured value fluctuation during calibration
Duration	10 to 60 s Factory setting 20 s	Timeframe within which the permitted range for measured value fluctuation should not be exceeded

Temperature compensation during calibration

Menu/Setup/Inputs/Channel: pH or pH/ORP/Extended setup/► Calib. settings		
Function	Options	Info
Temp. compensation	Selection <ul style="list-style-type: none"> ▪ Off ▪ Automatic ▪ Manual Factory setting Automatic	Decide how you want to compensate the buffer temperature: <ul style="list-style-type: none"> ▪ Automatically using the temperature sensor of your sensor (ATC) ▪ Manually by entering the medium temperature ▪ Not at all
Temperature Temp. compensation = Manual	-50 to 250 °C (-58 to 482 °F) Factory setting 25 °C (77 °F)	Specify the buffer temperature.
 This setting only refers to compensation during calibration, not in measuring mode. You perform the compensation in the measuring mode further up in the menu.		



Buffer recognition

Automatic buffer recognition

To ensure a buffer is detected correctly, the measuring signal may deviate by a maximum of 30 mV from the value stored in the buffer table. This is approx. 0.5 pH at a temperature of 25°C.

If both buffers - 9.00 and 9.20 - were used, this would cause the signal intervals to overlap and buffer recognition would not work. For this reason, the device would recognize a buffer with a pH of 9.00 as a pH of 9.20.

→ Do not use the buffer with a pH of 9.00 for automatic buffer recognition.

Menu/Setup/Inputs/Channel: pH or ORP or pH/ORP or (ISE/Electrode slot)/Extended setup/► Calib. settings		
Function	Options	Info
Buffer recognition	Selection <ul style="list-style-type: none"> ▪ Fixed ▪ Automatic ¹⁾ ▪ Manual Factory setting Fixed	Fixed You choose values from a list. This list depends on the setting for Buffer manufacturer . Automatic The device recognizes the buffer automatically. The recognition depends on the setting for Buffer manufacturer .  As their zero point is offset, enamel pH sensors and CPS4xx ISFET sensors cannot be calibrated and adjusted with automatic buffer recognition. Manual You enter any two buffer values. These must differ in terms of their pH value.
Buffer manufacturer	Selection <ul style="list-style-type: none"> ▪ Endress+Hauser ▪ Ingold/Mettler ▪ DIN 19266 ▪ DIN 19267 ▪ Merck/Riedel ▪ Hamilton ▪ Special buffer Factory setting Endress+Hauser	Temperature tables are stored internally in the unit for the following pH values: <ul style="list-style-type: none"> ▪ Endress+Hauser 2.00 / 4.00 / 7.00 / (9.00) / 9.22 / 10.00 / 12.00 ▪ Ingold/Mettler 2.00 / 4.01 / 7.00 / 9.21 ▪ DIN 19266 1.68 / 4.01 / 6.86 / 9.18 ▪ DIN 19267 1.09 / 4.65 / 6.79 / 9.23 / 12.75 ▪ Merck/Riedel 2.00 / 4.01 / 6.98 / 8.95 / 12.00 ▪ Hamilton 1.09 / 1.68 / 2.00 / 3.06 / 4.01 / 5.00 / 6.00 / 7.00 / 8.00 / 9.21 / 10.01 / 11.00 / 12.00  With the Special buffer option, you have the possibility of defining two buffers of your own. For this purpose, two tables are displayed in which you can enter value pH value/temperature value pairs.
Calibration buffer 1 ... 2 Buffer recognition = Fixed or Manual	The possible options and the factory setting depend on the Buffer manufacturer	
1 point adjustment	Selection <ul style="list-style-type: none"> ▪ Transmitter ▪ Sensor Factory setting Transmitter	Function not in the ISE menu Choose whether the offset should be saved in the transmitter or in the sensor.

1) Only pH sensor or pH/ORP combined sensor

Calibration monitoring

You can specify the calibration interval for the sensor here. Once the time configured elapses, the **Calibration validity**.

 The timer is reset automatically if you recalibrate the sensor.

Menu/Setup/Inputs/Channel: Sensor type/Extended setup/► Calib. settings		
Function	Options	Info
Calib. expiration time	Selection <ul style="list-style-type: none"> ■ Off ■ During operation ■ When connecting Factory setting Off	This function checks the time elapsed since the last sensor calibration. This may occur continuously during operation or just once while the calibration data are being read (sensor connection, device start, calibration kit replacement). <ol style="list-style-type: none"> 1. During operation During continuous operation, this function informs the user of the time elapsed since the last calibration. 2. When connecting During a batch process, this function ensures that only recently calibrated sensors are used. No error message is generated during the batch process.
► Calibration validity		
Warning limit	Factory setting 800 h	Diagnostic message: 105 Calibration validity
Alarm limit	Factory setting 1000 h	Diagnostic message: 104 Calibration validity
Warning and alarm limits mutually influence each other's possible adjustment range. Range of adjustment which must include both limits: 1 to 20000 h Generally, the following applies: alarm limit > warning limit		

5.2.6 Diagnostics settings

This menu branch is used for specifying warning limits, and for defining whether and how diagnostics tools should be used.

The associated diagnostics code is displayed for every setting.

Impedance monitoring, Sensor Check System (only pH glass and pH/ORP combined sensor)

The Sensor Check System (SCS) monitors the high impedance of the pH glass. An alarm is issued if a minimum impedance value is undershot or a maximum impedance is exceeded.

- Main reason for drop in high impedance values: glass breakage
- Reasons for increasing impedance values:
 - Dry sensor
 - Worn pH glass membrane

Menu/Setup/Inputs/Channel: pH or pH/ORP/Extended setup/Diagnostics settings/► Glass impedance (SCS)		
Function	Options	Info
Upper limit	Selection <ul style="list-style-type: none"> ■ Off ■ On Factory setting On	On SCS operates with the following settings for the upper warning and alarm limits. Off Monitoring of the upper warning and alarm limits is switched off.
Upper alarm limit	0 to 10000 MΩ Factory setting 3000 MΩ	Diagnostics code and associated message text: 124 Sensor glass
Upper warning limit	0 to 10000 MΩ Factory setting 2500 MΩ	Diagnostics code and associated message text: 125 Sensor glass
Lower limit	Selection <ul style="list-style-type: none"> ■ Off ■ On Factory setting On	On SCS operates with the following settings for the lower warning and alarm limits. Off Monitoring of the lower warning and alarm limits is switched off.
Lower warning limit	0 to 10000 MΩ Factory setting 0.1 MΩ	Diagnostics code and associated message text: 123 Sensor glass
Lower alarm limit	0 to 10000 MΩ Factory setting 0 MΩ	Diagnostics code and associated message text: 122 Sensor glass

 For the SCS, upper and lower limit values can be enabled or disabled independently of one another.

Slope (only pH)

The slope characterizes the sensor condition. The bigger the deviation from the ideal value (59 mV/pH) the poorer the condition of the sensor.

Menu/Setup/Inputs/Channel: pH or pH/ORP/Extended setup/Diagnostics settings/► Slope		
Function	Options	Info
Warning limit	5.00 to 99.00 mV/pH Factory setting 55.00 mV/pH	Specify your limit values for slope monitoring. Associated diagnostics code and message text: 509 Sensor calibration

Zero point (pH Glass) and Operating point (pH ISFET)

pH glass sensors

The zero point characterizes the condition of the sensor reference. The bigger the deviation from the ideal value (pH 7.00) the poorer the condition.

This can be caused by KCl dissolving away or reference contamination, for example.

Menu/Setup/Inputs/Channel: pH or pH/ORP/Extended setup/Diagnostics settings/► Zero point or Operating point		
Function	Options	Info
Upper warning limit	Lower warning limit ... pH 12.00 ¹⁾ Lower warning limit ... 950 mV ²⁾ Factory setting pH 8.00 / 300 mV	Associated diagnostics code and message text: 505 Sensor calibration ¹⁾ 515 Sensor calibration ²⁾
Lower warning limit	pH 2.00 to Upper warning limit ¹⁾ -950 mV to Upper warning limit ²⁾ Factory setting pH 6.00 / -300 mV	Associated diagnostics code and message text: 507 Sensor calibration ¹⁾ 517 Sensor calibration ²⁾

- 1) pH Glass
 2) pH ISFET

Sensor Condition Check (only pH Glass)

Sensor condition check (SCC) monitors the electrode status and the degree of electrode aging. The condition of the electrode is updated after every calibration.

The main reasons for a deteriorating electrode status are:

- Glass membrane blocked or dry
- Diaphragm (reference) blocked

Remedial action

1. Clean or regenerate sensor.
2. If this does not have the desired effect:
 Replace sensor.

Menu/Setup/Inputs/Channel: pH or pH/ORP/Extended setup/Diagnostics settings/► Sensor Condition Check		
Function	Options	Info
Function	Selection <ul style="list-style-type: none"> ▪ Off ▪ On Factory setting Off	The function can only be switched on or off. It uses internal limit values Diagnostics code and associated message text: 127 SCC sufficient 126 SCC bad

ORP-Meas value (only ORP)

You can specify limit values in order to monitor your process. A diagnostics message is displayed if the limits are exceeded or undershot.

Menu/Setup/Inputs/Channel: pH or pH/ORP/Extended setup/Diagnostics settings/► ORP-Meas value		
Function	Options	Info
Upper alarm limit	Factory setting 1000 mV	Diagnostics code and associated message text: 842 Process value
Upper warning limit	Factory setting 900 mV	Diagnostics code and associated message text: 942 Process value
Lower warning limit	Factory setting -900 mV	Diagnostics code and associated message text: 943 Process value
Lower alarm limit	Factory setting -1000 mV	Diagnostics code and associated message text: 843 Process value

Process check system (PCS)

The process check system (PCS) checks the measuring signal for stagnation. An alarm is triggered if the measuring signal does not change over a specific period (several measured values).

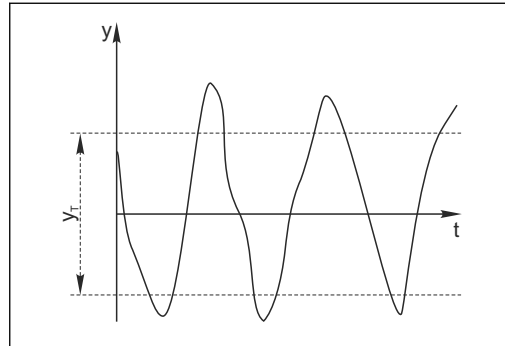

6 Normal measuring signal, no alarm

y Measuring signal
 y_T Set value for Tolerance width

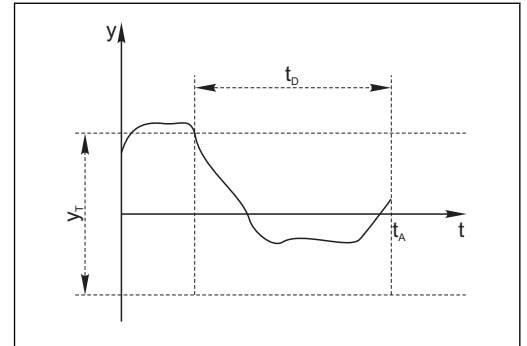

7 Stagnating signal, alarm is triggered

t_D Set value for Duration
 t_A Time when the alarm is triggered

Main causes of stagnating measured values

- Contaminated sensor, or sensor outside of medium
- Sensor defective
- Process error (e.g. through control system)

Remedial action

1. Clean sensor.
2. Check positioning of sensor in medium.
3. Check electrode system.
4. Switch controller off and then switch it back on.

Menu/Setup/Inputs/Channel: Sensor type/Extended setup/Diagnostics settings/► Process Check System		
Function	Options	Info
Function	Selection <ul style="list-style-type: none"> ■ Off ■ On Factory setting Off	Switches the function on or off
Duration	1 to 240 min Factory setting 60 min	Enter the time after which the timer should time out. When this time expires, diagnostic message Calibration timer is displayed with code 102.
Tolerance width <i>Not for pH/ORP sensors</i>	The range depends on the sensor Factory setting Depends on the sensor	Interval around the measuring signal (raw value) for detecting stagnation. Measured values within the set interval are regarded as stagnating.

Limits operating hours

The total operating time of the sensor and its use under extreme conditions is monitored. If the operating time exceeds the defined threshold values, the device issues a corresponding diagnostics message.

- i** Each sensor has a limited life expectancy which heavily depends on the operating conditions. If you specify warning limits for operating times under extreme conditions, you can guarantee the operation of your measuring point without any downtime by performing maintenance tasks in time.

Menu/Setup/Inputs/Channel: pH or pH/ORP/Extended setup/Diagnostics settings/► Limits operating hours		
Function	Options	Info
 The range of adjustment for the operating hours alarm and warning limits is generally 1 to 50000 h.		
Function	Selection <ul style="list-style-type: none"> ▪ Off ▪ On Factory setting On	On The operation of the sensor under extreme conditions is monitored, recorded in the sensor and diagnostics messages are displayed on the controller. Off No diagnostics messages. However, the time the sensor operates under extreme conditions is recorded in the sensor and can be read in the sensor information in the diagnostics menu.
► Operating time		Total operating time of the sensor
Warning limit	Factory setting 10000 h	Diagnostics code and associated message text: 199 Operating time
► Operation > 80 °C		
Warning limit	Factory setting 10000 h	Diagnostics code and associated message text: 193 Operating time
► Operation > 100 °C		
Warning limit	Factory setting 10000 h	Diagnostics code and associated message text: 194 Operating time
Operation < -300 mV		<i>Only pH sensor or pH/ORP combined sensor</i>
Warning limit	Factory setting 10000 h	Diagnostics code and associated message text: 180 Operating time
Operation > 300 mV		<i>Only pH sensor or pH/ORP combined sensor</i>
Warning limit	Factory setting 10000 h	Diagnostics code and associated message text: 179 Operating time

Delta slope (only pH and pH/ORP combined sensor)

The device determines the difference in slope between the last calibration and the penultimate calibration, and issues a warning or an alarm depending on the setting configured. The difference is an indicator for the condition of the sensor. The greater the change, the greater the wear experienced by the pH-sensitive glass membrane as a result of chemical corrosion or abrasion.

Menu/Setup/Inputs/Channel: pH or pH/ORP/Extended setup/Diagnostics settings/► Delta slope		
Function	Options	Info
Function	Selection <ul style="list-style-type: none"> ▪ Off ▪ On Factory setting Off	Switches the function on or off
Warning limit	0.10 to 10.00 mV/pH Factory setting 5.00 mV/pH	Specify your limit values for monitoring the slope differential. Associated diagnostics code and message text: 518 Sensor calibration

Delta zero point (pH glass) or Delta operating point (ISFET)

The device determines the difference between the last calibration and the penultimate calibration, and issues a warning or an alarm depending on the setting configured. The difference is an indicator for the condition of the sensor.

The following applies to pH glass electrodes:
 The greater the change, the greater the wear experienced by the reference as a result of contaminating ions or KCl dissolving away.

Menu/Setup/Inputs/Channel: pH or pH/ORP/Extended setup/Diagnostics settings/► Delta zero point or Delta operating point		
Function	Options	Info
Function	Selection <ul style="list-style-type: none"> ■ Off ■ On Factory setting Off	Switches the function on or off
Warning limit	pH 0.00 to 2.00 (pH glass) 0 to 950 mV (ISFET) Factory setting pH 0.50 / 25 mV	Specify your limit values for monitoring the slope differential. Associated diagnostics code and message text: <ul style="list-style-type: none"> ■ 520 Sensor calibration (pH glass) ■ 522 Sensor calibration (ISFET)

Sterilizations



The system counts the number of operating hours in which the sensor is exposed to a temperature that is typical for a sterilization. This temperature depends on the sensor.

Menu/Setup/Inputs/Channel: Sensor type/Extended setup/Diagnostics settings/► Sterilizations		
Function	Options	Info
Function	Selection <ul style="list-style-type: none"> ■ Off ■ On Factory setting Off	Switches the function on or off
Warning limit	0 to 99 Factory setting 30 ¹⁾	Specify the limit value for the number of sensor sterilizations. Diagnostics code and associated message text: 108 SIP, CIP, autoclaving

1) For oxygen: 25

Diagnostic behavior

The list of diagnostic messages displayed depends on the path selected. There are device-specific messages, and messages that depend on what sensor is connected.

Menu/Setup/(General settings or Inputs<Sensor channel>)/Extended setup/Diagnostics settings/Diag. behavior		
Function	Options	Info
List of diagnostic messages		► Select the message to be changed. Only then can you make the settings for this message.
Diag. code	Read only	
Diagnostic message	Selection <ul style="list-style-type: none"> ▪ On ▪ Off Factory setting Depends on the message	You can deactivate or reactivate a diagnostic message here. Deactivating means: <ul style="list-style-type: none"> ▪ No error message in the measuring mode ▪ No error current at the current output
Error current	Selection <ul style="list-style-type: none"> ▪ On ▪ Off Factory setting Depends on the message	► Decide whether an error current should be output at the current output if the diagnostic message display is activated.  In the event of general device errors, the error current is output at all the current outputs. In the event of channel-specific errors, the error current is only output at the assigned current output.
Status signal	Selection <ul style="list-style-type: none"> ▪ Maintenance (M) ▪ Out of specification (S) ▪ Function check (C) ▪ Failure (F) Factory setting Depends on the message	The messages are divided into different error categories in accordance with NAMUR NE 107. ► Decide whether you want to change a status signal assignment for your application.
Diag. output	Selection <ul style="list-style-type: none"> ▪ None ▪ Alarm relay ▪ Binary output ▪ Relay 1 to n (depends on the device version) Factory setting None	You can use this function to select an output to which the diagnostic message should be assigned. You can use this function to select a relay output and/or binary output to which the diagnostic message should be assigned. You can use this function to select a binary output to which the diagnostic message should be assigned. For sensors with the Memosens protocol: Before being able to assign the message to an output you must first configure a relay output to Diagnostics . (Menu/Setup/Outputs: Assign the Diagnostics function and set the Operating mode to as assigned.)
 An alarm relay is always available, regardless of the device version. Other relays are optional.		
Cleaning program (for sensors)	Selection <ul style="list-style-type: none"> ▪ None ▪ Cleaning 1 ▪ Cleaning 2 ▪ Cleaning 3 ▪ Cleaning 4 Factory setting None	► Decide whether the diagnostic message should trigger a cleaning program. You can define the cleaning programs under: Menu/Setup/Additional functions/Cleaning .
Detail information	Read only	Here you can find more information on the diagnostic message and instructions on how to resolve the problem.

5.3 Name check

With this function, you specify which sensors are accepted at your device.

Menu/Setup/Inputs/Channel: Sensor type/Extended setup/Diagnostics settings/► Tag control		
Function	Options	Info
Operating mode	Selection <ul style="list-style-type: none"> ▪ Off ▪ Tag ▪ Group Factory setting Off	Off No name check, all sensors are accepted. Tag Only sensors with the same tag name are accepted. Group Only sensors in the same tag group are accepted.
Tag	Free text Factory setting <ul style="list-style-type: none"> ▪ EH_CM44_ ▪ EH_CM44R_ ▪ EH_CSF48_ ▪ EH_CSP44_ 	Enter the tag name. The controller checks every sensor to be connected as to whether this sensor belongs to the measuring point, and only accepts the sensors that have the same name.
Group	Numerical Factory setting 0	

5.4 Sensor replacement

Menu/Setup/Inputs/Channel: Sensor type/Extended setup/Sensor change

- On
When the sensor is replaced, the last measured value is retained via the "hold" function. A diagnostics message is not triggered.
- Off
When the sensor is replaced, the last measured value is not retained and triggers a diagnostics message.

5.5 Data processing factory setting

Here you can restore the factory settings for the sensor input.

Menu/Setup/Inputs/Channel: Sensor type/Extended setup

1. ► **Factory default measurement processing**
2. Respond to prompt: **OK** when the prompt for the device software appears.
 - ↳ Only the factory settings for this particular input are restored. All other settings remain unchanged.

6 Inputs: Conductivity

6.1 Basic settings

6.1.1 Sensor identification

Menu/Setup/Inputs/Channel: sensor type		
Function	Options	Info
Channel	Selection <ul style="list-style-type: none"> ▪ Off ▪ On Factory setting On	On The channel display is switched on in the measuring mode Off The channel is not displayed in the measuring mode, regardless of whether a sensor is connected or not.
Sensor type	Read only (Only available if a sensor is connected)	Connected sensor type
Order code		Order code of the connected sensor

6.1.2 Damping

The damping causes a floating average curve of the measured values over the time specified.

Menu/Setup/Inputs/Channel: sensor type		
Function	Options	Info
Depends on the sensor ¹⁾	0 to 600 s	You specify the damping of the main measured value and that of the integrated temperature sensor.
Damping temp.	Factory setting 0 s	

- 1) **Damping pH** or **Damping ORP** or **Damping Cond** or **Damping DO** or **Damping DI** or **Damping nitrate** or **Damping SAC** or **Damping turbidity**

6.1.3 Manual hold

Menu/Setup/Inputs/Channel: sensor type		
Function	Options	Info
Manual hold	Selection <ul style="list-style-type: none"> ▪ Off ▪ On Factory setting Off	On You can use this function to set the channel manually to "Hold". Off No channel-specific hold

6.1.4 Operating mode and cell constant

The measured value that is available via the current outputs depends on the option selected under **Operating mode**.

Menu/Setup/Inputs/Channel: Conductivity		
Function	Options	Info
Operating mode	<p>Selection</p> <ul style="list-style-type: none"> ▪ Conductivity ▪ Resistance ¹⁾ ▪ Concentration ²⁾ ▪ TDS ²⁾ <p>Factory setting Conductivity</p>	<p>Alternatively to the conductivity, you can also measure the resistivity and the total dissolved solids (TDS) parameter with a conductive conductivity sensor.</p> <p>Alternatively to the conductivity, you can determine the concentration of the medium with an inductive conductivity sensor or the conductive four-pin sensor CLS82D.</p> <p>TDS TDS stands for all the organic and inorganic substances in the water in ionic, molecular or microgranular (<2 µm) form. Compared with laboratory methods (gravimetric analysis), TDS measurement via the conductivity value delivers a maximum measured error of less than 10%.</p>
Cell constant	Read only (Only available if a sensor is connected)	The cell constant of the connected sensor is displayed (→ sensor certificate)

- 1) Only conductive sensor
- 2) Only inductive sensor and CLS82D

6.1.5 Installation factor (only inductive sensors and CLS82D)

In confined installation conditions, the conductivity measurement is affected by the pipe walls.

The installation factor compensates for this effect. The transmitter corrects the cell constant by multiplying by the installation factor.

The value of the installation factor depends on the diameter and the conductivity of the pipe nozzle as well as the sensor's distance to the wall.

If there is a sufficient distance between the wall and the sensor, the installation factor *f* does not have to be taken into consideration (*f* = 1.00). If the distance to the wall is smaller, the installation factor increases for electrically insulating pipes (*f* > 1) and decreases for electrically conductive pipes (*f* < 1).

The installation factor can be determined using calibration solutions. Approximate values for the sensor-specific installation factor are provided in the Operating Instructions of the sensor.

Menu/Setup/Inputs/Channel: Conductivity		
Function	Options	Info
Inst. factor	Read only (Only available if a sensor is connected)	Displays the current value. Only changes with a calibration.

6.1.6 Concentration table (only inductive sensors and CLS82D)

Menu/Setup/Inputs/Channel: Conductivity		
Function	Options	Info
Conc. Table Operating mode = Concentration	Selection <ul style="list-style-type: none"> ■ NaOH 0..15% ■ NaOH 25..50% ■ HCl 0..20% ■ HNO₃ 0..25% ■ HNO₃ 24..30% ■ H₂SO₄ 0..28% ■ H₂SO₄ 40..80% ■ H₂SO₄ 93..100% ■ H₃PO₄ 0..40% ■ NaCl 0..26% ■ User table 1 ... 4 Factory setting NaOH 0..15%	Concentration tables saved at the factory: <ul style="list-style-type: none"> ■ NaOH: 0 to 15 %, 0 to 100 °C (32 to 212 °F) ■ NaOH: 25 to 50 %, 2 to 80 °C (36 to 176 °F) ■ HCl: 0 to 20 %, 0 to 65 °C (32 to 149 °F) ■ HNO₃: 0 to 25 %, 2 to 80 °C (36 to 176 °F) ■ H₂SO₄: 0.5 to 27 %, 0 to 100 °C (32 to 212 °F) (While the table name is 0 to 28%, useful results can only be achieved from 0.5 to 27%) ■ H₂SO₄: 40 to 80 %, 0 to 100 °C (32 to 212 °F) ■ H₂SO₄: 93 to 100 %, 10 to 115 °C (50 to 239 °F) ■ H₃PO₄: 0 to 40 %, 2 to 80 °C (36 to 176 °F) ■ NaCl: 0 to 26 %, 2 to 80 °C (36 to 176 °F)
Temp. comp. mode Conc. Table = User table 1 ... 4	Selection <ul style="list-style-type: none"> ■ with temp. comp ■ without temp. comp Factory setting with temp. comp	Only select without temp. comp. In all other cases: with temp. comp.
Table name Conc. Table = User table 1 ... 4	Customized text, 16 characters	Assign a meaningful name to the selected table.
► Edit table Conc. Table = User table 1 ... 4	3-column table	Assign conductivity and concentration value pairs for a specific temperature.

Data records for entering a concentration table

Given a defined medium composition, you can take data records for concentration tables from tables. Alternatively you can determine the data records experimentally.

To this end:

1. Create samples of the medium in the concentrations that occur in the process. Two samples of different concentrations are required at the very minimum.
2. Measure the uncompensated conductivity of these samples at a constant temperature.
 - ↳ If the variable process temperature is to be taken into consideration, determine data records for at least two different temperatures (minimum 0.5 °C apart). The transmitter requires at least 4 support points. Ideally, measure the conductivity of two different concentrations at the minimum and maximum process temperature.

You should receive measured data which, from a qualitative perspective, are presented as illustrated in the following charts.

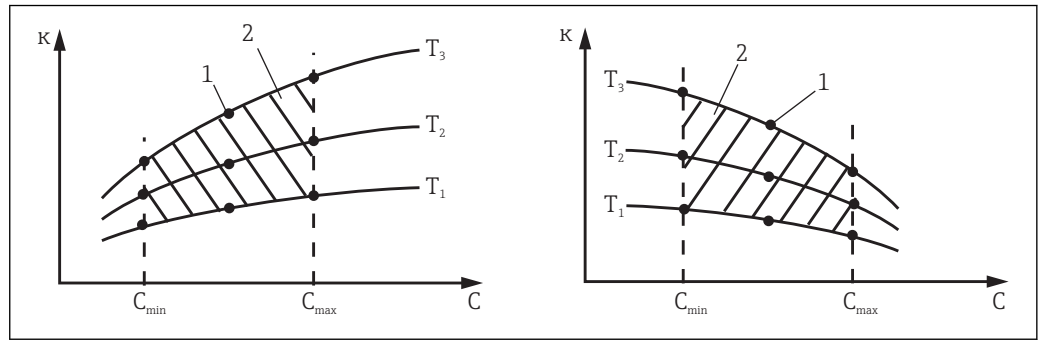

A0036618

8 Example of measured data for variable temperatures

- κ Conductivity
- c Concentration
- T Temperature
- 1 Measuring point
- 2 Measuring range

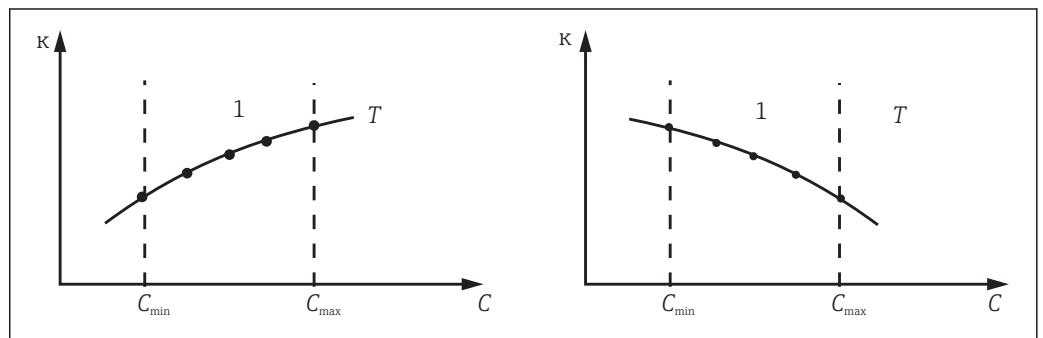

A0036619

9 Example of measured data for constant temperatures

- κ Conductivity
- c Concentration
- T Constant temperature
- 1 Measuring range

i The characteristic curves received from the measuring points must increase or decrease very monotonically in the range of the process conditions, this means that neither maximum points, nor minimum points, nor ranges with a constant behavior can occur. The curve profiles opposite are therefore not permitted.

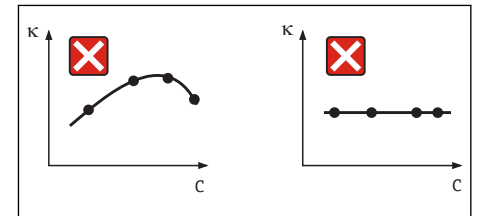

A0036620

10 Impermissible curve profiles

- κ Conductivity
- c Concentration

Example of a concentration table:

Conductivity (uncompensated) [mS/cm]	Concentration [mg/l]	Temperature [°C (°F)]
1.000	0.000	0.00 (32.00)
2.000	0.000	100.00 (212.00)
100.0	3.000	0.00 (32.00)
300.0	3.000	100.00 (212.00)

6.1.7 Unit and format

Menu/Setup/Inputs/Channel: Conductivity		
Function	Options	Info
Main value format	Selection <ul style="list-style-type: none"> ▪ Auto ▪ # ▪ #.# ▪ #.## ▪ #.### Factory setting Auto	Specify the number of decimal places. Only CLS82D If Operating mode = Conductivity the format #.### is not available.
Cond. unit	Selection <ul style="list-style-type: none"> ▪ Auto ▪ $\mu\text{S/cm}$ ▪ mS/cm ▪ S/cm ▪ $\mu\text{S/m}$ ▪ mS/m ▪ S/m Factory setting Auto	Operating mode = Conductivity All conductivity sensors
Unit	Selection <ul style="list-style-type: none"> ▪ Auto ▪ $\text{M}\Omega\text{m}$ ▪ $\text{M}\Omega\text{cm}$ ▪ $\text{k}\Omega\text{cm}$ ▪ $\text{k}\Omega\text{m}$ ▪ Ωm ▪ Ωcm Factory setting Auto	Operating mode = Resistance Conductive conductivity sensors
Conc. unit	Selection <ul style="list-style-type: none"> ▪ % ▪ $\text{mg/l}^{1)}$ Factory setting %	Operating mode = Concentration Inductive conductivity sensors and CLS82D
Unit	Selection <ul style="list-style-type: none"> ▪ ppm ▪ mg/l Factory setting ppm	Operating mode = TDS All conductivity sensors

1) Only with user table

6.1.8 Temperature compensation

Temperature coefficient α = change in the conductivity per degree of temperature change:

$$\kappa(T) = \kappa(T_0)(1 + \alpha(T - T_0))$$

$\kappa(T)$... conductivity at process temperature T

$\kappa(T_0)$... conductivity at reference temperature T_0

The temperature coefficient depends both on the chemical composition of the solution and the temperature itself.

Menu/Setup/Inputs/Channel: Conductivity		
Function	Options	Info
Temp. source	Selection <ul style="list-style-type: none"> ▪ Sensor ▪ Manual ▪ Measured value Factory setting Sensor	Decide how you want to compensate the medium temperature: <ul style="list-style-type: none"> ▪ Automatically using the temperature sensor of your sensor ▪ Manually by entering the medium temperature ▪ Using an external temperature sensor
Medium temperature Temp. source = Manual	-50.0 to 250.0 °C (-58.0 to 482.0 °F) Factory setting 25.0 °C (77 °F)	Enter the temperature of your medium.
Measured value Temp. source = Measured value	Selection <ul style="list-style-type: none"> ▪ Sensor input ▪ Fieldbus input with subsequent selection of the input signal 	External temperature signals only in °C Select an input to which a temperature sensor is connected. Alternatively you can use a temperature signal via the fieldbus. In this case, you must select the fieldbus input afterwards.
Compensation Operating mode = Conductivity	Selection <ul style="list-style-type: none"> ▪ None ▪ Linear ▪ NaCl (IEC 746-3) ▪ Water ISO7888 (25°C) ▪ UPW HCl ▪ UPW NaCl ▪ User table 1 ... 4 Factory setting Linear	Various methods are available to compensate for the temperature dependency. Depending on your process, decide which type of compensation you want to use. Alternatively, you can also select None and thus measure uncompensated conductivity.

Linear temperature compensation

The change between two temperature points is taken to be constant, i.e. $\alpha = \text{const.}$ The value for α remains stored in the sensor and is recalculated for each calibration.

Reference temperature and alpha coefficient (only for linear temperature compensation)

The alpha coefficients and alpha reference temperatures of your process medium must be known. Typical alpha coefficients at a reference temperature of 25 °C are:

- Salts (e.g. NaCl): approx. 2.1 %/K
- Bases (e.g. NaOH): approx. 1.7 %/K
- Acids (e.g. HNO₃): approx. 1.3 %/K

Menu/Setup/Inputs/Channel: Conductivity		
Function	Options	Info
Ref. temp.	-5.0 to 100.0 °C (23.0 to 212.0 °F) Factory setting 25.0 °C (77.0 °F)	Reference temperature for calculating the temperature-compensated conductivity
Factor alpha	0.000 to 20.000 %/K Factory setting 2.100 %/K	Enter the conductivity coefficient of your process medium

NaCl compensation

In the case of NaCl compensation (as per IEC 60746), a fixed non-linear curve specifying the relationship between the temperature coefficient and temperature is saved in the device. This curve applies to low concentrations of up to approx. 5 % NaCl.

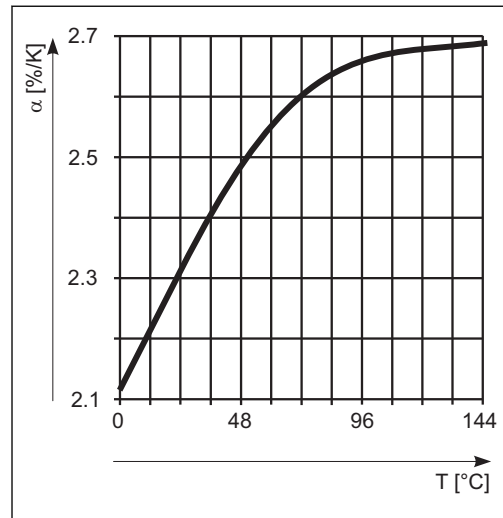

A0028902

Compensation for natural water

A non-linear function in accordance with ISO 7888 is saved in the device for temperature compensation in natural water.

Ultrapure water compensation (for conductive sensors)

Algorithms for pure and ultrapure water are stored in the device. These algorithms take the dissociation of the water and its temperature dependency into account. They are used for conductivity levels of approx. 10 $\mu\text{S}/\text{cm}$.

- UPW HCl

Optimized for measuring the acid conductivity downstream of a cation exchanger. Also suitable for ammonia (NH_3) and caustic soda (NaOH).

- UPW NaCl

Optimized for pH-neutral contamination.

User-defined tables

You can save a function that takes the properties of your specific process into account. To do so, determine the value pairs made up of the temperature T and conductivity κ with:

- $\kappa(T_0)$ for the reference temperature T_0
- $\kappa(T)$ for the temperatures that occur in the process
- Use the following formula to calculate the α values for the temperatures that are relevant in your process:

$$\alpha = \frac{100\%}{\kappa(T_0)} \cdot \frac{\kappa(T) - \kappa(T_0)}{T - T_0} ; T \neq T_0$$



Values must be constantly increasing or decreasing.

Menu/Setup/Inputs/Channel: Conductivity		
Function	Options	Info
Temp. comp. mode	Selection <ul style="list-style-type: none"> ▪ Conductivity ▪ Coeff. Alpha Factory setting Conductivity	Conductivity You specify the temperature, conductivity and uncompensated conductivity. Recommended for large measuring ranges and small measured values. Coeff. Alpha As the value pairs, you specify an alpha value and the related temperature.
Table name Conc. Table = User table 1 ... 4	Customized text, 16 characters	Assign a meaningful name to the selected table.
► Edit table Conc. Table = User table 1 ... 4	<ul style="list-style-type: none"> ▪ Temperature ▪ Conductivity ▪ Temperature comp. cond. ▪ Temperature ▪ Coefficient alpha 	Maximum number of rows: 25 The type of table depends on the option selected under Temp. comp. mode .

6.2 Advanced setup

6.2.1 Temperature format

Menu/Setup/InputsChannel: Conductivity/► Extended setup		
Function	Options	Info
Temperature format	Selection <ul style="list-style-type: none"> ▪ #.# ▪ #.## Factory setting #.#	Specify the number of decimal places.

6.2.2 Cleaning hold

Menu/Setup/Inputs/Channel: Sensor type/► Extended setup		
Function	Options	Info
Cleaning hold	Selection <ul style="list-style-type: none"> ▪ None ▪ Cleaning 1 ... 4 Factory setting None	<ul style="list-style-type: none"> ► For selecting one or more cleaning programs (multiple selection). <ul style="list-style-type: none"> ↳ For the programs defined, the channel goes to "Hold" while cleaning is in progress. Cleaning programs are executed: <ul style="list-style-type: none"> ▪ At a specified interval For this, the cleaning program must be started. ▪ If a diagnostics message is pending on the channel and a cleaning has been specified for this message (→ Inputs/Channel: Sensor type/Diagnostics settings/Diag. behavior/Diagnostic number/Cleaning program).

 You define the cleaning programs in the **Setup/Additional functions/Cleaning**.

6.2.3 External hold

You can trigger a hold for all the devices of a measuring point via a digital signal, e.g. a fieldbus signal. Make sure that you do not use the hold signal elsewhere. You can assign an external hold individually to every sensor input.

 You will only find the function in the initial menu if you have configured the signals for the external hold in the general hold settings beforehand:

Menu/Setup/General settings/Hold settings/External hold.

Menu/Setup/Inputs/Channel: Sensor type/Extended setup/► External hold		
Function	Options	Info
Source	Selection <ul style="list-style-type: none"> ▪ Binary inputs ▪ Fieldbus signals Factory setting None	<ol style="list-style-type: none"> 1. For selecting the signal source of the external hold. ↳ Multiple selection is possible. 2. OK: confirms selection.

6.2.4 Diagnostics settings

This menu branch is used for specifying warning limits, and for defining whether and how diagnostics tools should be used.

The associated diagnostics code is displayed for every setting.

Sterilizations

The system counts the number of operating hours in which the sensor is exposed to a temperature that is typical for a sterilization. This temperature depends on the sensor.

Menu/Setup/Inputs/Channel: Sensor type/Extended setup/Diagnostics settings/► Sterilizations		
Function	Options	Info
Function	Selection <ul style="list-style-type: none"> ▪ Off ▪ On Factory setting Off	Switches the function on or off
Warning limit	0 to 99 Factory setting 30 ¹⁾	Specify the limit value for the number of sensor sterilizations. Diagnostics code and associated message text: 108 SIP, CIP, autoclaving

1) For oxygen: 25

CIP cycles (CLS82D)

Menu/Setup/Inputs/Channel: Cond c 4-pol/Extended setup/Diagnostics settings/► CIP-cycles		
Function	Options	Info
Function	Selection <ul style="list-style-type: none"> ▪ Off ▪ On Factory setting Off	Switches the function on or off
Warning limit	0 ... 1500 Factory setting 1000	Specify the limit value for the number of CIP cycles of your sensor. Diagnostics code and associated message text: 108 SIP, CIP, autoclaving

Process check system (PCS)

The process check system (PCS) checks the measuring signal for stagnation. An alarm is triggered if the measuring signal does not change over a specific period (several measured values).

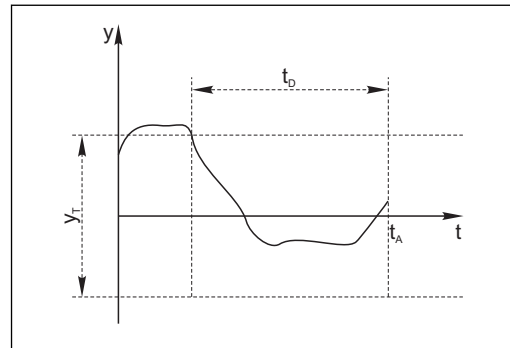
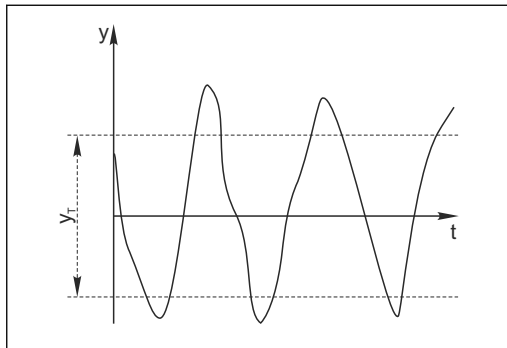

11 Normal measuring signal, no alarm

12 Stagnating signal, alarm is triggered

y Measuring signal

y_T Set value for Tolerance width

t_D Set value for Duration

t_A Time when the alarm is triggered

Main causes of stagnating measured values

- Contaminated sensor, or sensor outside of medium
- Sensor defective
- Process error (e.g. through control system)

Remedial action

1. Clean sensor.
2. Check positioning of sensor in medium.
3. Check electrode system.
4. Switch controller off and then switch it back on.

Menu/Setup/Inputs/Channel: Sensor type/Extended setup/Diagnostics settings/► Process Check System		
Function	Options	Info
Function	Selection <ul style="list-style-type: none"> ■ Off ■ On Factory setting Off	Switches the function on or off
Duration	1 to 240 min Factory setting 60 min	Enter the time after which the timer should time out. When this time expires, diagnostic message Calibration timer is displayed with code 102.
Tolerance width <i>Not for pH/ORP sensors</i>	The range depends on the sensor Factory setting Depends on the sensor	Interval around the measuring signal (raw value) for detecting stagnation. Measured values within the set interval are regarded as stagnating.

Limits operating hours

The total operating time of the sensor and its use under extreme conditions is monitored. If the operating time exceeds the defined threshold values, the device issues a corresponding diagnostics message.

- i** Each sensor has a limited life expectancy which heavily depends on the operating conditions. If you specify warning limits for operating times under extreme conditions, you can guarantee the operation of your measuring point without any downtime by performing maintenance tasks in time.

Menu/Setup/Inputs/Channel: Conductivity/Extended setup/Diagnostics settings/► Limits operating hours		
Function	Options	Info
 The range of adjustment for the operating hours alarm and warning limits is generally 1 to 50000 h.		
Function	Selection <ul style="list-style-type: none"> ▪ Off ▪ On Factory setting On	On The operation of the sensor under extreme conditions is monitored, recorded in the sensor and diagnostics messages are displayed on the controller. Off No diagnostics messages. However, the time the sensor operates under extreme conditions is recorded in the sensor and can be read in the sensor information in the diagnostics menu.
► Operating time		Total operating time of the sensor
Warning limit	Factory setting 10000 h	Diagnostics code and associated message text: 199 Operating time
► Operation > 80 °C		
Warning limit	Factory setting 10000 h	Diagnostics code and associated message text: 193 Operating time
► Operation > 100 °C		
Warning limit	Factory setting 10000 h	Diagnostics code and associated message text: 194 Operating time
► Operation > 120 °C		Only conductive sensors
Warning limit	Factory setting 10000 h	Diagnostics code and associated message text: 195 Operating time
► Operation > 125 °C		Only inductive sensors
Warning limit	Factory setting 10000 h	Diagnostics code and associated message text: 196 Operating time
► Operation > 140 °C		Only conductive sensors
Warning limit	Factory setting 10000 h	Diagnostics code and associated message text: 197 Operating time
► Operation > 150 °C		Only inductive sensors and CLS82D
Warning limit	Factory setting 10000 h	Diagnostics code and associated message text: 198 Operating time
► Operation > 80°C < 100nS/cm		Only conductive sensors
Warning limit	Factory setting 10000 h	Diagnostics code and associated message text: 187 Operating time
► Operation < 5 °C		Only inductive sensors
Warning limit	Factory setting 10000 h	Diagnostics code and associated message text: 188 Operating time

Polarization compensation (only conductive two-electrode sensors, not CLS82D)

As a result of flow through the electrolyte/electrode interface, reactions take place here which result in additional voltage. These polarization effects limit the measuring range of conductive sensors. Sensor-specific compensation increases the level of accuracy at the measuring range limits.

 The controller recognizes the Memosens sensor and automatically uses suitable compensation. You can view the measuring range limits of the sensor under **Diagnostics/Sensor information/Sensor specifications** .

Menu/Setup/Inputs/Channel: Conductivity/Extended setup/Diagnostics settings/► Polarization compensation		
Function	Options	Info
 The range of adjustment for the operating hours alarm and warning limits is generally 1 to 50000 h.		
Function	Selection <ul style="list-style-type: none"> ▪ Off ▪ On Factory setting Off	Diagnostics code and associated message text: 168 Polarization

Pharmaceutical water



Here you can make settings for monitoring pharmaceutical water in accordance with the United States Pharmacopoeia (USP) or European Pharmacopoeia (EP).

The uncompensated conductivity value and the temperature are measured for the limit functions. The measured values are compared against the tables defined in the standards. An alarm is triggered if the limit value is exceeded. Furthermore, you can also set a preliminary alarm (warning limit) which signals undesired operating states before they occur.

Menu/Setup/Inputs/Channel: Conductivity/Extended setup/Diagnostics settings/► Pharmacy-water		
Function	Options	Info
 The range of adjustment for the operating hours alarm and warning limits is generally 1 to 50000 h.		
Function	Selection <ul style="list-style-type: none"> ▪ Off ▪ EP ▪ USP Factory setting Off	The alarm values are stored in the device in accordance with USP <645> or EP <169> specifications. You define the warning limit as a % of the alarm value.
Warning limit	10.0 to 99.9 % Factory setting 80.0 %	Diagnostics code and associated message text: 915 USP / EP warning If the value exceeds the USP or EP alarm values saved in the software, diagnostics message 914 USP/ EP alarm is displayed.

Diagnostic behavior

The list of diagnostic messages displayed depends on the path selected. There are device-specific messages, and messages that depend on what sensor is connected.

Menu/Setup/(General settings or Inputs<Sensor channel>)/Extended setup/Diagnostics settings/Diag. behavior		
Function	Options	Info
List of diagnostic messages		► Select the message to be changed. Only then can you make the settings for this message.
Diag. code	Read only	
Diagnostic message	Selection <ul style="list-style-type: none"> ▪ On ▪ Off Factory setting Depends on the message	You can deactivate or reactivate a diagnostic message here. Deactivating means: <ul style="list-style-type: none"> ▪ No error message in the measuring mode ▪ No error current at the current output
Error current	Selection <ul style="list-style-type: none"> ▪ On ▪ Off Factory setting Depends on the message	► Decide whether an error current should be output at the current output if the diagnostic message display is activated.  In the event of general device errors, the error current is output at all the current outputs. In the event of channel-specific errors, the error current is only output at the assigned current output.
Status signal	Selection <ul style="list-style-type: none"> ▪ Maintenance (M) ▪ Out of specification (S) ▪ Function check (C) ▪ Failure (F) Factory setting Depends on the message	The messages are divided into different error categories in accordance with NAMUR NE 107. ► Decide whether you want to change a status signal assignment for your application.
Diag. output	Selection <ul style="list-style-type: none"> ▪ None ▪ Alarm relay ▪ Binary output ▪ Relay 1 to n (depends on the device version) Factory setting None	You can use this function to select an output to which the diagnostic message should be assigned. You can use this function to select a relay output and/or binary output to which the diagnostic message should be assigned. You can use this function to select a binary output to which the diagnostic message should be assigned. For sensors with the Memosens protocol: Before being able to assign the message to an output you must first configure a relay output to Diagnostics . (Menu/Setup/Outputs: Assign the Diagnostics function and set the Operating mode to as assigned.)
 An alarm relay is always available, regardless of the device version. Other relays are optional.		
Cleaning program (for sensors)	Selection <ul style="list-style-type: none"> ▪ None ▪ Cleaning 1 ▪ Cleaning 2 ▪ Cleaning 3 ▪ Cleaning 4 Factory setting None	► Decide whether the diagnostic message should trigger a cleaning program. You can define the cleaning programs under: Menu/Setup/Additional functions/Cleaning.
Detail information	Read only	Here you can find more information on the diagnostic message and instructions on how to resolve the problem.

6.2.5 Name check

With this function, you specify which sensors are accepted at your device.

Menu/Setup/Inputs/Channel: Sensor type/Extended setup/Diagnostics settings/► Tag control		
Function	Options	Info
Operating mode	Selection <ul style="list-style-type: none"> ▪ Off ▪ Tag ▪ Group Factory setting Off	Off No name check, all sensors are accepted. Tag Only sensors with the same tag name are accepted. Group Only sensors in the same tag group are accepted.
Tag	Free text Factory setting <ul style="list-style-type: none"> ▪ EH_CM44_ ▪ EH_CM44R_ ▪ EH_CSF48_ ▪ EH_CSP44_ 	Enter the tag name. The controller checks every sensor to be connected as to whether this sensor belongs to the measuring point, and only accepts the sensors that have the same name.
Group	Numerical Factory setting 0	

6.2.6 Sensor replacement

Menu/Setup/Inputs/Channel: Sensor type/Extended setup/Sensor change

- On
When the sensor is replaced, the last measured value is retained via the "hold" function. A diagnostics message is not triggered.
- Off
When the sensor is replaced, the last measured value is not retained and triggers a diagnostics message.

6.2.7 Data processing factory setting

Here you can restore the factory settings for the sensor input.

Menu/Setup/Inputs/Channel: Sensor type/Extended setup

1. ► **Factory default measurement processing**
2. Respond to prompt: **OK** when the prompt for the device software appears.
 - ↳ Only the factory settings for this particular input are restored. All other settings remain unchanged.

7 Inputs: Oxygen

7.1 Basic settings

7.1.1 Sensor identification

Menu/Setup/Inputs/Channel: sensor type		
Function	Options	Info
Channel	Selection <ul style="list-style-type: none"> ▪ Off ▪ On Factory setting On	On The channel display is switched on in the measuring mode Off The channel is not displayed in the measuring mode, regardless of whether a sensor is connected or not.
Sensor type	Read only	Connected sensor type
Order code	(Only available if a sensor is connected)	Order code of the connected sensor

7.1.2 Main value

Menu/Setup/Inputs/Channel: DO		
Function	Options	Info
Main value	Selection <ul style="list-style-type: none"> ▪ Concentration liquid ▪ Concentration gaseous ▪ Saturation ▪ Partial pressure ▪ Raw value nA ¹⁾ ▪ Raw value µs ²⁾ Factory setting Concentration liquid	Decide how you want to display the main value. Other functions, such as the setting for the unit, depend on this setting.

1) Amperometric sensor

2) Optical sensor

7.1.3 Damping

The damping causes a floating average curve of the measured values over the time specified.

Menu/Setup/Inputs/Channel: sensor type		
Function	Options	Info
Depends on the sensor ¹⁾	0 to 600 s	You specify the damping of the main measured value and that of the integrated temperature sensor.
Damping temp.	Factory setting 0 s	

1) **Damping pH or Damping ORP or Damping Cond or Damping DO or Damping DI or Damping nitrate or Damping SAC or Damping turbidity**

7.1.4 Unit

Menu/Setup/Inputs/Channel: DO		
Function	Options	Info
Unit	Selection <ul style="list-style-type: none"> ▪ mg/l ¹⁾ ▪ µg/l ¹⁾ ▪ ppm ¹⁾ ▪ ppb ¹⁾ ▪ %Vol ²⁾ ▪ ppmVol ²⁾ Factory setting mg/l ¹⁾ %Vol ²⁾	The unit can only be selected for the main measured values: <ul style="list-style-type: none"> ▪ Concentration liquid ▪ Concentration gaseous

- 1) Main value = Concentration liquid
- 2) Main value = Concentration gaseous

7.1.5 Manual hold

Menu/Setup/Inputs/Channel: sensor type		
Function	Options	Info
Manual hold	Selection <ul style="list-style-type: none"> ▪ Off ▪ On Factory setting Off	On You can use this function to set the channel manually to "Hold". Off No channel-specific hold

7.2 Advanced setup

7.2.1 Temperature compensation (only amperometric sensors and COS81D)

Menu/Setup/Inputs/Channel: DO/Extended setup		
Function	Options	Info
Temp. compensation	Selection <ul style="list-style-type: none"> ▪ Automatic ▪ Manual Factory setting Automatic	Decide how you want to compensate the medium temperature: <ul style="list-style-type: none"> ▪ Automatically using the temperature sensor of your sensor This means that the temperature is always compensated based on the current temperature value. ▪ Manually by entering the medium temperature This means that the measured value is always compensated against the value entered, e.g. for inlet and outlet monitoring in a cooling facility.
Temperature Temp. compensation = Manual	0 to 80 °C (32 to 176 °F) Factory setting 20 °C (68 °F)	Enter the temperature of your medium, or another temperature which you want to use as a reference temperature.

7.2.2 Measured value formats

Menu/Setup/Inputs/Channel: DO/► Extended setup		
Function	Options	Info
Main value format	Selection <ul style="list-style-type: none"> ■ #.# ■ #.## ■ #.### ■ # Factory setting #.##	Specify the number of decimal places.
Temperature format	Selection <ul style="list-style-type: none"> ■ #.# ■ #.## Factory setting #.#	

7.2.3 Medium compensation (in the process)

Menu/Setup/Inputs/Channel: DO/► Extended setup		
Function	Options	Info
Medium pressure	Selection <ul style="list-style-type: none"> ■ Process pressure ■ Air pressure ■ Altitude ■ Measured value Factory setting Air pressure	<p>Press Measured value you can connect a pressure measured value via a fieldbus input or a current input. This measured value is then used for medium pressure compensation.</p> <p>For the other types of compensation, specify a compensation value for the measurement in each case.</p> <ol style="list-style-type: none"> 1. Specify either the altitude (-300 to 4000 m), the process pressure (500 to 9999 hPa) or the air pressure (500 to 1200 hPa) of the measuring point. <ul style="list-style-type: none"> ↳ The pressure used during the calibration is also displayed for information purposes. You can change this pressure in: Calib. settings/Medium pressure. 2. ▷ Confirm.
Input pressure Medium pressure = Measured value	Selection <ul style="list-style-type: none"> ■ Current inputs ■ Fieldbus signals ■ None Factory setting None	<p>Only available if a fieldbus is activated or a current input is available. Configure a current input before using its measured value for pressure compensation of the oxygen sensor.</p> <p> Operating Instructions of the transmitter/ analyzer/sampler, → 5</p> <p>Configure the input variable of the current input with Parameter with the hPa unit in order to ensure correct scaling. Adjust the measuring range limits accordingly.</p> <p>Example: The measuring range of the connected pressure sensor is from 0 to 10 bar.</p> <ol style="list-style-type: none"> 1. Parameter: Configure current input. 2. Define hPa as the unit. 3. Enter 0 for Lower range value and 10,000 for Upper range value (1 bar ≈ 1000 hPa).

Menu/Setup/Inputs/Channel: DO/► Extended setup		
Function	Options	Info
Salinity	Selection <ul style="list-style-type: none"> ▪ Fixed value ▪ Measured value Factory setting Fixed value	
Fixed value Salinity = Fixed value	0 to 40 g/kg Factory setting 0 g/kg	The influence of salt content on oxygen measurement is compensated with this function. Example: sea water measurement as per Copenhagen Standard (30 g/kg).
Sensorselection Salinity = Measured value	Selection <ul style="list-style-type: none"> ▪ None ▪ Conductivity sensor Factory setting None	As an alternative to specifying a fixed value that corresponds to your application, you can use the measured value of a connected conductivity sensor. A CLS50D or a CLS54D is recommended to this end. Salinity compensation via a measured value works optimally in the temperature range 2 - 35 °C at a conductivity level up to a maximum of 42 S/m.

7.2.4 LED settings (only COS81D)

Menu/Setup/Inputs/Channel: DO/► Extended setup		
Function	Options	Info
LED temp. mode	Options <ul style="list-style-type: none"> ▪ Off ▪ On Factory setting Off	Switches off the LED when the set temperature threshold is exceeded. This prevents the premature aging of the sensor cap, e.g. during a CIP or SIP cycle.
LED temp. threshold LED temp. mode = On	30 to 130 °C (86 to 266 °F) Factory setting 80 °C (176 °F)	
LED measuring interval	Options <ul style="list-style-type: none"> ▪ 1 second ▪ 3 seconds ▪ 10 seconds ▪ 30 seconds Factory setting 1 second	The LED measuring interval influences the response time on the one hand and the operating life of the sensor cap on the other. Shorter intervals improve the response time but reduce the operating life of the sensor cap. Make your setting depending on the requirements of your process.

7.2.5 Cleaning hold

Menu/Setup/Inputs/Channel: Sensor type/► Extended setup		
Function	Options	Info
Cleaning hold	Selection <ul style="list-style-type: none"> ▪ None ▪ Cleaning 1 ... 4 Factory setting None	<ul style="list-style-type: none"> ► For selecting one or more cleaning programs (multiple selection). <ul style="list-style-type: none"> ↳ For the programs defined, the channel goes to "Hold" while cleaning is in progress. Cleaning programs are executed: <ul style="list-style-type: none"> ▪ At a specified interval For this, the cleaning program must be started. ▪ If a diagnostics message is pending on the channel and a cleaning has been specified for this message (→ Inputs/Channel: Sensor type/Diagnostics settings/Diag. behavior/Diagnostic number/Cleaning program).

 You define the cleaning programs in the **Setup/Additional functions/Cleaning**.

7.2.6 External hold

You can trigger a hold for all the devices of a measuring point via a digital signal, e.g. a fieldbus signal. Make sure that you do not use the hold signal elsewhere. You can assign an external hold individually to every sensor input.

 You will only find the function in the initial menu if you have configured the signals for the external hold in the general hold settings beforehand:

Menu/Setup/General settings/Hold settings/External hold.

Menu/Setup/Inputs/Channel: Sensor type/Extended setup/► External hold		
Function	Options	Info
Source	Selection <ul style="list-style-type: none"> ▪ Binary inputs ▪ Fieldbus signals Factory setting None	<ol style="list-style-type: none"> 1. For selecting the signal source of the external hold. <ul style="list-style-type: none"> ↳ Multiple selection is possible. 2. OK: confirms selection.

7.2.7 Calibration settings

Stability criteria

You define the permitted measured value fluctuation which must not be exceeded in a certain timeframe during calibration. If the permitted difference is exceeded, calibration is not permitted and is aborted automatically.

Menu/Setup/Inputs/Channel: DO/► Extended setup/Calib. settings/► Stability criteria		
Function	Options	Info
Delta signal	0.1 to 2.0 % Factory setting 0.2 %	Permitted measured value fluctuation during calibration. Referenced to the raw value in nA in the case of amperometric sensors, and referenced to the raw value in µS in the case of optical sensors.
Delta temperature	0.10 to 2.00 K Factory setting 0.50 K	Permitted temperature fluctuation during calibration
Duration	5 to 60 s Factory setting 20 s	Timeframe within which the permitted range for measured value fluctuation should not be exceeded

Medium compensation (during calibration)

Menu/Setup/Inputs/Channel: DO/► Extended setup/Calib. settings		
Function	Options	Info
Medium pressure	Selection <ul style="list-style-type: none"> ■ Process pressure ■ Air pressure ■ Altitude Factory setting Air pressure	
Process pressure Medium pressure = Process pressure	500 to 9999 hPa Factory setting 1013 hPa	Enter the altitude or the average air pressure of the place of calibration (mutually dependent values). If you specify the altitude, the average air pressure is calculated from the barometric altitude formula and vice versa. If you are compensating using the process pressure, enter the pressure in your calibration medium here. The pressure is then independent of the altitude.
Air pressure Medium pressure = Air pressure	500 to 1200 hPa Factory setting 1013 hPa	
Altitude Medium pressure = Altitude	-300 to 4000 m Factory setting 0 m	
Rel. hum. (air variable)	0 to 100 % Factory setting 100 %	

Calibration monitoring

You can specify the calibration interval for the sensor here. Once the time configured elapses, the **Calibration validity**.



The timer is reset automatically if you recalibrate the sensor.

Menu/Setup/Inputs/Channel: Sensor type/Extended setup/► Calib. settings		
Function	Options	Info
Calib. expiration time	Selection <ul style="list-style-type: none"> ■ Off ■ During operation ■ When connecting Factory setting Off	This function checks the time elapsed since the last sensor calibration. This may occur continuously during operation or just once while the calibration data are being read (sensor connection, device start, calibration kit replacement). <ol style="list-style-type: none"> 1. During operation During continuous operation, this function informs the user of the time elapsed since the last calibration. 2. When connecting During a batch process, this function ensures that only recently calibrated sensors are used. No error message is generated during the batch process.
► Calibration validity		
Warning limit	Factory setting 800 h	Diagnostic message: 105 Calibration validity
Alarm limit	Factory setting 1000 h	Diagnostic message: 104 Calibration validity
Warning and alarm limits mutually influence each other's possible adjustment range. Range of adjustment which must include both limits: 1 to 20000 h Generally, the following applies: alarm limit > warning limit		

7.2.8 Diagnostics settings

This menu branch is used for specifying warning limits, and for defining whether and how diagnostics tools should be used.

The associated diagnostics code is displayed for every setting.

Slope (only amperometric sensors and COS61D)

The (relative) slope characterizes the sensor condition. Decreasing values indicate electrolyte exhaustion. You can control when the electrolyte should be replaced by specifying limit values and the diagnostics messages these limit values trigger.

- Specify the limit values for slope monitoring in your sensor.

Menu/Setup/Inputs/Channel: DO/Extended setup/Diagnostics settings/► Slope		
Function	Options	Info
Upper warning limit	0.0 to 200.0 % Factory setting 140.0 %	Associated diagnostics code and message text: 511 Sensor calibration
Lower warning limit	0.0 to 200.0 % Factory setting 60.0 %	Associated diagnostics code and message text: 509 Sensor calibration

Delta slope (only amperometric sensors and COS61D)

The device determines the difference in slope between the last calibration and the penultimate calibration, and issues a warning or an alarm depending on the setting configured. The difference is an indicator for the condition of the sensor.

An increasing change indicates the formation of buildup on the sensor diaphragm or electrolyte contamination. Replace the diaphragm and electrolyte as specified in the instructions in the sensor operating manual.

Menu/Setup/Inputs/Channel: DO/Extended setup/Diagnostics settings/► Delta slope		
Function	Options	Info
Function	Selection <ul style="list-style-type: none"> ■ Off ■ On Factory setting Off	Switches the function on or off
Warning limit	0.0 to 50.0 % Factory setting 5.0 %	Specify your limit values for monitoring the slope differential. Associated diagnostics code and message text: 518 Sensor calibration

Zero point (only amperometric sensors and COS61D)

The zero point corresponds to the sensor signal that is measured in a medium in the absence of oxygen. You can calibrate the zero point in water that is free from oxygen or in high-purity nitrogen. This improves accuracy in the trace range.

Menu/Setup/Inputs/Channel: DO/Extended setup/Diagnostics settings/► Zero point		
Function	Options	Info
Warning limit	0.0 to 10.0 nA Factory setting 3.0 nA	Specify the limit values for zero point monitoring in your sensor. Associated diagnostics code and message text: 513 Zero Warning

Delta zero point (only amperometric sensors and COS61D)

The device determines the difference between the last calibration and the penultimate calibration, and issues a warning or an alarm depending on the setting configured. The difference is an indicator for the condition of the sensor. Increasing differences indicate the formation of buildup on the cathode. Clean or replace the cathode as specified in the instructions in the sensor operating manual.

Menu/Setup/Inputs/Channel: DO/Extended setup/Diagnostics settings/► Delta zero point		
Function	Options	Info
Function	Selection <ul style="list-style-type: none"> ■ Off ■ On Factory setting Off	Switches the function on or off
Warning limit	0.0 to 10 nA Factory setting 1.0 nA	Specify your limit values for monitoring the slope differential. Associated diagnostics code and message text: 520 Sensor calibration

Calibration quality index (only COS81D)

Menu/Setup/Inputs/Channel: DO/Extended setup/Diagnostics settings/► Calibration quality index		
Function	Options	Info
Function	Selection <ul style="list-style-type: none"> ▪ Off ▪ On Factory setting Off	
Warning limit	0 ... 100 % Factory setting 80 %	Associated diagnostics code and message text: 734 Calibration quality

Cap calibrations (only COS22D and COS81D)

The calibration counters in the sensor make a distinction between sensor calibrations and calibrations with the membrane cap currently used. If this cap is replaced, only the (cap) counter is reset.

Menu/Setup/Inputs/Channel: DO/Extended setup/Diagnostics settings/► Number of cap calibrations		
Function	Options	Info
Function	Selection <ul style="list-style-type: none"> ▪ Off ▪ On Factory setting Off	Specify how many calibrations may be performed with a membrane cap before the cap has to be replaced. The number depends heavily on the process and must be determined individually.
Warning limit	0 to 1000 Factory setting 6	Associated diagnostics code and message text: 535 Sensor check

Cap sterilizations (only sterilizable sensors)

The sterilization counters in the sensor make a distinction between the sensor and the membrane/fluorescence cap currently used. If this cap is replaced, only the (cap) counter is reset.

Menu/Setup/Inputs/Channel: DO/Extended setup/Diagnostics settings/► Number of cap sterilizations		
Function	Options	Info
Function	Selection <ul style="list-style-type: none"> ▪ Off ▪ On Factory setting Off	Specify how many sterilizations may be performed with a membrane cap before the cap has to be replaced. The number depends heavily on the process and must be determined individually.
Warning limit	0 to 100 Factory setting 25	Associated diagnostics code and message text: 109 Sterilization cap

Sterilizations

The system counts the number of operating hours in which the sensor is exposed to a temperature that is typical for a sterilization. This temperature depends on the sensor.

Menu/Setup/Inputs/Channel: Sensor type/Extended setup/Diagnostics settings/► Sterilizations		
Function	Options	Info
Function	Selection ■ Off ■ On Factory setting Off	Switches the function on or off
Warning limit	0 to 99 Factory setting 30 ¹⁾	Specify the limit value for the number of sensor sterilizations. Diagnostics code and associated message text: 108 SIP, CIP, autoclaving

1) For oxygen: 25

Process check system (PCS)

The process check system (PCS) checks the measuring signal for stagnation. An alarm is triggered if the measuring signal does not change over a specific period (several measured values).

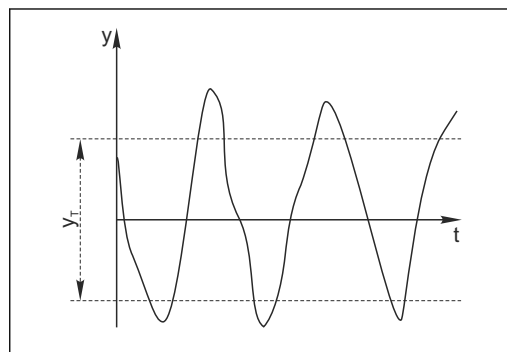

13 Normal measuring signal, no alarm

y Measuring signal
y_T Set value for **Tolerance width**

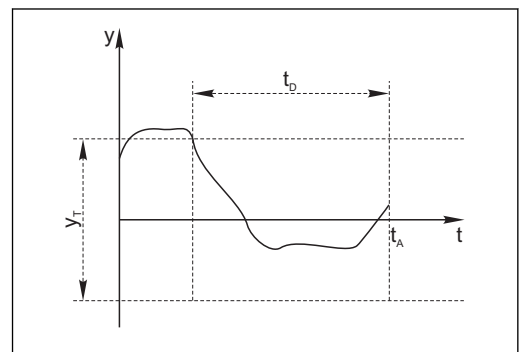

14 Stagnating signal, alarm is triggered

t_D Set value for **Duration**
t_A Time when the alarm is triggered

Main causes of stagnating measured values

- Contaminated sensor, or sensor outside of medium
- Sensor defective
- Process error (e.g. through control system)

Remedial action

1. Clean sensor.
2. Check positioning of sensor in medium.
3. Check electrode system.
4. Switch controller off and then switch it back on.

Menu/Setup/Inputs/Channel: Sensor type/Extended setup/Diagnostics settings/► Process Check System		
Function	Options	Info
Function	Selection <ul style="list-style-type: none"> ▪ Off ▪ On Factory setting Off	Switches the function on or off
Duration	1 to 240 min Factory setting 60 min	Enter the time after which the timer should time out. When this time expires, diagnostic message Calibration timer is displayed with code 102.
Tolerance width <i>Not for pH/ORP sensors</i>	The range depends on the sensor Factory setting Depends on the sensor	Interval around the measuring signal (raw value) for detecting stagnation. Measured values within the set interval are regarded as stagnating.

Limits operating hours

The total operating time of the sensor and its use under extreme conditions is monitored. If the operating time exceeds the defined threshold values, the device issues a corresponding diagnostics message.

 Each sensor has a limited life expectancy which heavily depends on the operating conditions. If you specify warning limits for operating times under extreme conditions, you can guarantee the operation of your measuring point without any downtime by performing maintenance tasks in time.

Menu/Setup/Inputs/Channel: DO/Extended setup/Diagnostics settings/► Limits operating hours		
Function	Options	Info
 The range of adjustment for the operating hours alarm and warning limits is generally 1 to 50000 h.		
Function	Selection <ul style="list-style-type: none"> ▪ Off ▪ On Factory setting On	On The operation of the sensor under extreme conditions is monitored, recorded in the sensor and diagnostics messages are displayed on the controller. Off No diagnostics messages. However, the time the sensor operates under extreme conditions is recorded in the sensor and can be read in the sensor information in the diagnostics menu.
► Operating time		Total operating time of the sensor
Warning limit	Factory setting 10000 h	Diagnostics code and associated message text: 199 Operating time
► Operation < 5 °C		Only optical sensors
Warning limit	Factory setting 10000 h	Diagnostics code and associated message text: 188 Operating time
► Operation > 5 °C		Only COS51D
Warning limit	Factory setting 10000 h	Diagnostics code and associated message text: 189 Operating time
► Operation > 25 °C		Only COS61D
Warning limit	Factory setting 10000 h	Diagnostics code and associated message text: 190 Operating time
► Operation > 30 °C		Only COS51D
Warning limit	Factory setting 10000 h	Diagnostics code and associated message text: 191 Operating time

Menu/Setup/Inputs/Channel: DO/Extended setup/Diagnostics settings/► Limits operating hours		
Function	Options	Info
► Operation > 40 °C		Only COS22D, COS61D and COS81D
Warning limit	Factory setting 10000 h	Diagnostics code and associated message text: 192 Operating time
► Operation > 80 °C		Only COS22D and COS81D
Warning limit	Factory setting 10000 h	Diagnostics code and associated message text: 193 Operating time
Operation > 120 °C		Only COS81D
Warning limit	Factory setting 10000 h	Diagnostics code and associated message text: 195 Operating time
► Operation > 15 nA		Only COS22D
Warning limit	Factory setting 10000 h	Diagnostics code and associated message text: 183 Operating time
Operation > 30 nA		Only COS51D
Warning limit	Factory setting 10000 h	Diagnostics code and associated message text: 184 Operating time
Operation > 50 nA		Only COS22D
Warning limit	Factory setting 10000 h	Diagnostics code and associated message text: 185 Operating time
Operation > 160 nA		Only COS51D
Warning limit	Factory setting 10000 h	Diagnostics code and associated message text: 186 Operating time
Operation < 25 µs		Only COS61D
Warning limit	Factory setting 10000 h	Diagnostics code and associated message text: 181 Operating time
Operation > 40 µs		Only COS61D
Warning limit	Factory setting 10000 h	Diagnostics code and associated message text: 182 Operating time

Limits operating hours cap (only COS81D)

Menu/Setup/Inputs/Channel: DO/Extended setup/Diagnostics settings/► Limits operating hours cap		
Function	Options	Info
 The range of adjustment for the operating hours alarm and warning limits is generally 1 to 50000 h.		
Function	Selection <ul style="list-style-type: none"> ▪ Off ▪ On Factory setting On	On The operation of the sensor under extreme conditions is monitored, recorded in the sensor and diagnostics messages are displayed on the controller. Off No diagnostics messages. However, the time the sensor operates under extreme conditions is recorded in the sensor and can be read in the sensor information in the diagnostics menu.
► Operating time		Total operating time of the sensor cap
Warning limit	Factory setting 10000 h	Diagnostics code and associated message text: 199 Operating time
► Operation > 40 °C		
Warning limit	Factory setting 10000 h	Diagnostics code and associated message text: 192 Operating time

Menu/Setup/Inputs/Channel: DO/Extended setup/Diagnostics settings/► Limits operating hours cap		
Function	Options	Info
► Operation > 80 °C		
Warning limit	Factory setting 10000 h	Diagnostics code and associated message text: 193 Operating time
Operation > 120 °C		
Warning limit	Factory setting 10000 h	Diagnostics code and associated message text: 195 Operating time
Operation < 5 °C		
Warning limit	Factory setting 10000 h	Diagnostics code and associated message text: 188 Operating time

Electrolyte counter (amperometric sensors only)

Menu/Setup/Inputs/Channel: DO/Extended setup/Diagnostics settings/► Electrolyte counter		
Function	Options	Info
Function	Selection <ul style="list-style-type: none"> ▪ Off ▪ On Factory setting Off	Electrolyte depletion is calculated based on the quantity of analyte transformed. <ul style="list-style-type: none"> ► After replacing electrolyte: Reset counter (CAL/Oxygen (amp.)/Change electrolyte).
Electrolyte capacity	Display only	Displays the remaining capacity
Warning limit	100 000 to 20 000 000 µAs Factory setting 2896000 µAs	Associated diagnostics code and message text: 534 Electrolyte warning

Diagnostic behavior

The list of diagnostic messages displayed depends on the path selected. There are device-specific messages, and messages that depend on what sensor is connected.

Menu/Setup/(General settings or Inputs<Sensor channel>)/Extended setup/Diagnostics settings/Diag. behavior		
Function	Options	Info
List of diagnostic messages		► Select the message to be changed. Only then can you make the settings for this message.
Diag. code	Read only	
Diagnostic message	Selection <ul style="list-style-type: none"> ▪ On ▪ Off Factory setting Depends on the message	You can deactivate or reactivate a diagnostic message here. Deactivating means: <ul style="list-style-type: none"> ▪ No error message in the measuring mode ▪ No error current at the current output
Error current	Selection <ul style="list-style-type: none"> ▪ On ▪ Off Factory setting Depends on the message	► Decide whether an error current should be output at the current output if the diagnostic message display is activated.  In the event of general device errors, the error current is output at all the current outputs. In the event of channel-specific errors, the error current is only output at the assigned current output.

Menu/Setup/(General settings or Inputs<Sensor channel>)/Extended setup/Diagnostics settings/Diag. behavior		
Function	Options	Info
Status signal	<p>Selection</p> <ul style="list-style-type: none"> ▪ Maintenance (M) ▪ Out of specification (S) ▪ Function check (C) ▪ Failure (F) <p>Factory setting Depends on the message</p>	<p>The messages are divided into different error categories in accordance with NAMUR NE 107.</p> <ul style="list-style-type: none"> ▶ Decide whether you want to change a status signal assignment for your application.
Diag. output	<p>Selection</p> <ul style="list-style-type: none"> ▪ None ▪ Alarm relay ▪ Binary output ▪ Relay 1 to n (depends on the device version) <p>Factory setting None</p>	<p>You can use this function to select an output to which the diagnostic message should be assigned.</p> <p>You can use this function to select a relay output and/or binary output to which the diagnostic message should be assigned.</p> <p>You can use this function to select a binary output to which the diagnostic message should be assigned.</p> <p>For sensors with the Memosens protocol: Before being able to assign the message to an output you must first configure a relay output to Diagnostics . (Menu/Setup/Outputs: Assign the Diagnostics function and set the Operating mode to as assigned .)</p>
<p> An alarm relay is always available, regardless of the device version. Other relays are optional.</p>		
Cleaning program (for sensors)	<p>Selection</p> <ul style="list-style-type: none"> ▪ None ▪ Cleaning 1 ▪ Cleaning 2 ▪ Cleaning 3 ▪ Cleaning 4 <p>Factory setting None</p>	<ul style="list-style-type: none"> ▶ Decide whether the diagnostic message should trigger a cleaning program. <p>You can define the cleaning programs under: Menu/Setup/Additional functions/Cleaning.</p>
Detail information	Read only	Here you can find more information on the diagnostic message and instructions on how to resolve the problem.

7.2.9 Name check

With this function, you specify which sensors are accepted at your device.

Menu/Setup/Inputs/Channel: Sensor type/Extended setup/Diagnostics settings/► Tag control		
Function	Options	Info
Operating mode	Selection <ul style="list-style-type: none"> ▪ Off ▪ Tag ▪ Group Factory setting Off	Off No name check, all sensors are accepted. Tag Only sensors with the same tag name are accepted. Group Only sensors in the same tag group are accepted.
Tag	Free text Factory setting <ul style="list-style-type: none"> ▪ EH_CM44_ ▪ EH_CM44R_ ▪ EH_CSF48_ ▪ EH_CSP44_ 	Enter the tag name. The controller checks every sensor to be connected as to whether this sensor belongs to the measuring point, and only accepts the sensors that have the same name.
Group	Numerical Factory setting 0	

7.2.10 Sensor replacement

Menu/Setup/Inputs/Channel: Sensor type/Extended setup/Sensor change

- On
When the sensor is replaced, the last measured value is retained via the "hold" function. A diagnostics message is not triggered.
- Off
When the sensor is replaced, the last measured value is not retained and triggers a diagnostics message.

7.2.11 Data processing factory setting

Here you can restore the factory settings for the sensor input.

Menu/Setup/Inputs/Channel: Sensor type/Extended setup

1. ► **Factory default measurement processing**
2. Respond to prompt: **OK** when the prompt for the device software appears.
 - ↳ Only the factory settings for this particular input are restored. All other settings remain unchanged.

7.2.12 Sensor factory settings (only COS61D)

Here you can restore the sensor factory settings.

Menu/Setup/Inputs/Channel: Sensor type/Extended setup

1. ► **Factory default sensor**
2. Respond to prompt: **OK** when the prompt for the device software appears.
 - ↳ Only the factory settings for the sensor are restored. The settings for the input remain unchanged.

8 Inputs: disinfection

8.1 Basic settings

8.1.1 Sensor identification

Menu/Setup/Inputs/Channel: Disinfection		
Function	Options	Info
Channel	Options <ul style="list-style-type: none"> ▪ Off ▪ On Factory setting On	On The channel display is switched on in the measuring mode Off The channel is not displayed in the measuring mode, regardless of whether a sensor is connected or not.
Sensor type	Read only (Only available if a sensor is connected)	Disinfection
Sensor element		<ul style="list-style-type: none"> ▪ Free chlorine ▪ Chlorine dioxide
Order code		Order code of the connected sensor

8.1.2 Main value

Menu/Setup/Inputs/Channel: Disinfection		
Function	Options	Info
Main value	Options <ul style="list-style-type: none"> ▪ Concentration ▪ Sensor current Factory setting Concentration	Decide how you want to display the main value.

8.1.3 Damping

The damping causes a floating average curve of the measured values over the time specified.

Menu/Setup/Inputs/Channel: sensor type		
Function	Options	Info
Depends on the sensor ¹⁾	0 to 600 s	You specify the damping of the main measured value and that of the integrated temperature sensor.
Damping temp.	Factory setting 0 s	

1) Damping pH or Damping ORP or Damping Cond or Damping DO or Damping DI or Damping nitrate or Damping SAC or Damping turbidity

8.1.4 Manual hold

Menu/Setup/Inputs/Channel: sensor type		
Function	Options	Info
Manual hold	Selection <ul style="list-style-type: none"> ▪ Off ▪ On Factory setting Off	On You can use this function to set the channel manually to "Hold". Off No channel-specific hold

8.1.5 Unit

Menu/Setup/Inputs/Channel: Disinfection		
Function	Options	Info
Unit Main value = Concentration	Options <ul style="list-style-type: none"> ▪ mg/l ▪ µg/l ▪ ppm ▪ ppb Factory setting mg/l	The measured parameter is displayed in abbreviated format after the unit. Example: If chlorine is being measured in mg/l, the unit is displayed as mg/l Cl₂ , and chlorine dioxide is displayed as mg/l ClO₂ .

8.2 Advanced setup

8.2.1 Measured value formats

Menu/Setup/Inputs/Channel: Disinfection/► Extended setup		
Function	Options	Info
Temperature format	Options <ul style="list-style-type: none"> ▪ #.# ▪ #.## Factory setting #.#	Specify the number of decimal places.
Main value format	Options <ul style="list-style-type: none"> ▪ #.# ▪ #.## ▪ #.### ▪ # Factory setting #.#	

8.2.2 Medium and temperature compensation

Medium compensation (only CCS142D sensor)

Menu/Setup/Inputs/Channel: Disinfection/► Extended setup		
Function	Options	Info
Medium comp. (pH)	Options <ul style="list-style-type: none"> ▪ Off ▪ On Factory setting On	Off The measured value corresponds to the proportion of hypochlorous acid (e.g. HOCl) of the free halogen (e.g. chlorine). On On the basis of the pH value, the corresponding value for the hypohalide (e.g. OCl ⁻) is added to the measured value for the hypochlorous acid (e.g. HOCl) and indicated as the total value of the free available chlorine.
Mode Medium comp. (pH) = On	Options <ul style="list-style-type: none"> ▪ Fixed value ▪ Measured value Factory setting Fixed value	Decide whether you want to specify a fixed pH value for calculating the total free available chlorine or whether the measured value of a pH sensor attached to another input should be used.
Fixed value pH Mode = Fixed value	pH 4.00 to 9.00 Factory setting pH 7.20	Useful for media with a constant pH value Enter the pH value of your medium which you determined with a reference measurement.
Associated pH-sensor Mode = Measured value	Select the pH sensor Factory setting None	Preferred method for media with varying pH values Select the sensor input with the connected pH sensor. The measured value of the sensor is then continuously used to calculate the total free available chlorine.

Temp. source (only CCS50D)

Menu/Setup/Inputs/Channel: Disinfection/► Extended setup		
Function	Options	Info
Temp. source	Options <ul style="list-style-type: none"> ▪ Manual ▪ Internal sensor ▪ External meas. value Factory setting Internal sensor	Decide how you want to compensate the medium temperature: <ul style="list-style-type: none"> ▪ Automatically using the temperature sensor of your sensor ▪ Manually by entering the medium temperature ▪ Using an external temperature sensor
Medium temperature Temp. source = Manual	0 to 55 °C (32 to 130 °F) Factory setting 20.0 °C (68 °F)	Enter the temperature of your medium.
Input Temp. source = External meas. value	Options <ul style="list-style-type: none"> ▪ Sensor input ▪ Fieldbus input with subsequent selection of the input signal 	External temperature signals only in °C Select an input to which a temperature sensor is connected. Alternatively you can use a temperature signal via the fieldbus. In this case, you must select the fieldbus input afterwards.

Temperature compensation (all sensors)

Menu/Setup/Inputs/Channel: Disinfection/► Extended setup		
Function	Options	Info
Temp. compensation	Options <ul style="list-style-type: none"> ▪ Automatic ▪ Manual Factory setting Automatic	Decide whether and how you want to compensate the medium temperature: <ul style="list-style-type: none"> ▪ Automatically using the temperature sensor of your sensor ▪ Manually by entering the medium temperature
Temperature Temp. compensation = Manual	-5.0 to 50.0 °C (23.0 to 122.0 °F) Factory setting 20.0 °C (68 °F)	Enter the temperature of your medium.

8.2.3 Cleaning hold

Menu/Setup/Inputs/Channel: Sensor type/► Extended setup		
Function	Options	Info
Cleaning hold	Selection <ul style="list-style-type: none"> ▪ None ▪ Cleaning 1 ... 4 Factory setting None	<p>► For selecting one or more cleaning programs (multiple selection).</p> <p>↳ For the programs defined, the channel goes to "Hold" while cleaning is in progress.</p> <p>Cleaning programs are executed:</p> <ul style="list-style-type: none"> ▪ At a specified interval For this, the cleaning program must be started. ▪ If a diagnostics message is pending on the channel and a cleaning has been specified for this message (→ Inputs/Channel: Sensor type/Diagnostics settings/Diag. behavior/Diagnostic number/Cleaning program).

 You define the cleaning programs in the **Setup/Additional functions/Cleaning**.

8.2.4 External hold

You can trigger a hold for all the devices of a measuring point via a digital signal, e.g. a fieldbus signal. Make sure that you do not use the hold signal elsewhere. You can assign an external hold individually to every sensor input.

 You will only find the function in the initial menu if you have configured the signals for the external hold in the general hold settings beforehand:

Menu/Setup/General settings/Hold settings/External hold.

Menu/Setup/Inputs/Channel: Sensor type/Extended setup/► External hold		
Function	Options	Info
Source	Selection <ul style="list-style-type: none"> ▪ Binary inputs ▪ Fieldbus signals Factory setting None	<ol style="list-style-type: none"> 1. For selecting the signal source of the external hold. <ul style="list-style-type: none"> ↳ Multiple selection is possible. 2. OK: confirms selection.

8.2.5 Calibration settings

Calibration monitoring

You can specify the calibration interval for the sensor here. Once the time configured elapses, the **Calibration timer**.

 The timer is reset automatically if you recalibrate the sensor.

Menu/Setup/Inputs/Channel: Disinfection/Extended setup/► Calib. settings		
Function	Options	Info
Calibration timer	Options <ul style="list-style-type: none"> ▪ Off ▪ On Factory setting Off	Switches the function on or off
Calibration timer value	14 to 365 d Factory setting 180 d	Enter the time after which the timer should time out. When this time elapses, diagnostics message Calibration timer is displayed with code 102.
Calib. expiration time	Options <ul style="list-style-type: none"> ▪ Off ▪ On Factory setting Off	The function checks whether the calibration of a sensor is still valid. Example: you install a pre-calibrated sensor. The function checks how long ago the sensor was last calibrated. A diagnostics message is displayed if the time since the last calibration is longer than specified by the predefined warning and alarm limit.
► Calib. expiration time		
Warning limit	Factory setting 48 weeks	Diagnostics message: 105 Calibration validity
Alarm limit	Factory setting 52 weeks	Diagnostics message: 104 Calibration validity
Warning and alarm limits mutually influence each other's possible adjustment range. Range of adjustment which must include both limits: 1 to 104 weeks Generally, the following applies: alarm limit > warning limit		

Stability criteria

You define the permitted measured value fluctuation which must not be exceeded in a certain timeframe during calibration. If the permitted difference is exceeded, calibration is not permitted and is aborted automatically.

Menu/Setup/Inputs/Channel: Disinfection/► Extended setup/Calib. settings/► Stability criteria		
Function	Options	Info
Delta slope	0.1 to 5.0 % Factory setting Depends on the sensor	Permitted measured value fluctuation during slope calibration (with reference to the raw value in nA).
Delta zero point	0.0 to 10.0 nA Factory setting Depends on the sensor	Permitted measured value fluctuation during zero point calibration.

Menu/Setup/Inputs/Channel: Disinfection/► Extended setup/Calib. settings/► Stability criteria		
Function	Options	Info
Delta temperature	0.10 to 2.00 K Factory setting Depends on the sensor	Permitted temperature fluctuation during calibration
Duration signal	5 to 60 s Factory setting Depends on the sensor	Timeframe within which the permitted range for measured value fluctuation should not be exceeded

8.2.6 Diagnostics settings

This menu branch is used for specifying warning limits, and for defining whether and how diagnostics tools should be used.

The associated diagnostics code is displayed for every setting.

Slope

The (relative) slope characterizes the sensor condition. Decreasing values indicate electrolyte exhaustion. You can control when the electrolyte should be replaced by specifying limit values and the diagnostics messages these limit values trigger.

Menu/Setup/Inputs/Channel: Disinfection/Extended setup/Diagnostics settings/► Slope		
Function	Options	Info
Upper warning limit	3.0 to 500.0 % Factory setting 200.0 %	Associated diagnostics code and message text: 511 Sensor calibration
Lower warning limit	3.0 to 500.0 % Factory setting 25.0 %	Associated diagnostics code and message text: 509 Sensor calibration

Delta slope

The device determines the difference in slope between the last calibration and the penultimate calibration, and issues a warning or an alarm depending on the setting configured. The difference is an indicator for the condition of the sensor.

An increasing change indicates the formation of buildup on the sensor diaphragm or electrolyte contamination. Replace the diaphragm and electrolyte as specified in the instructions in the sensor operating manual.

Menu/Setup/Inputs/Channel: Disinfection/Extended setup/Diagnostics settings/► Delta slope		
Function	Options	Info
Function	Options ▪ Off ▪ On Factory setting Off	Switches the function on or off
Warning limit	1.0 to 15.0 % Factory setting 5.0 %	Specify your limit values for monitoring the slope differential. Associated diagnostics code and message text: 518 Sensor calibration

Zero point

The zero point corresponds to the sensor signal that is measured in a medium in the absence of chlorine. You can calibrate the zero point in water that is free from chlorine. This improves accuracy in the trace range.

Menu/Setup/Inputs/Channel: Disinfection/Extended setup/Diagnostics settings/► Zero point		
Function	Options	Info
Warning limit	0.0 to 3.2 nA Factory setting 2.0 nA	Specify the limit values for zero point monitoring in your sensor. Associated diagnostics code and message text: 513 Zero Warning

Delta zero point

The device determines the difference between the last calibration and the penultimate calibration, and issues a warning or an alarm depending on the setting configured. The difference is an indicator for the condition of the sensor.

Increasing differences indicate the formation of buildup on the cathode. Clean the cathode as specified in the instructions in the sensor operating manual.

Menu/Setup/Inputs/Channel: Disinfection/Extended setup/Diagnostics settings/► Delta zero point		
Function	Options	Info
Function	Options ▪ Off ▪ On Factory setting Off	Switches the function on or off
Warning limit	0.0 to 3.2 nA Factory setting 1.0 nA	Specify your limit values for monitoring the slope differential. Associated diagnostics code and message text: 520 Sensor calibration

Number of cap calibrations

The calibration counters in the sensor make a distinction between sensor calibrations and calibrations with the membrane cap currently used. If this cap is replaced, only the (cap) counter is reset.

Menu/Setup/Inputs/Channel: Disinfection/Extended setup/Diagnostics settings/► Number of cap calibrations		
Function	Options	Info
Function	Options ▪ Off ▪ On Factory setting Off	Specify how many calibrations may be performed with a membrane cap before the cap has to be replaced. The number depends heavily on the process and must be determined individually.
Warning limit	1 to 75 Factory setting 10	Associated diagnostics code and message text: 535 Sensor check

Cap change monitoring

Menu/Setup/Inputs/Channel: Disinfection/Extended setup/Diagnostics settings/► Cap change monitoring		
Function	Options	Info
Function	Options <ul style="list-style-type: none"> ■ Off ■ On Factory setting Off	Associated diagnostics code and message text: 987 Calibration required

Process check system (PCS)

The process check system (PCS) checks the measuring signal for stagnation. An alarm is triggered if the measuring signal does not change over a specific period (several measured values).

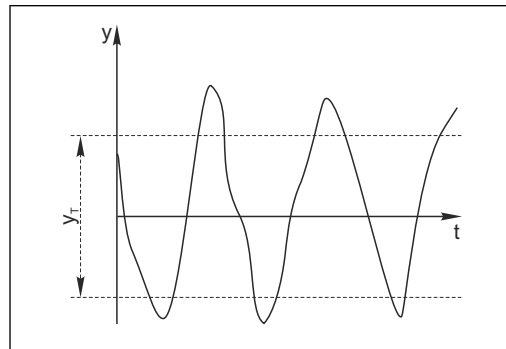

A0027276

15 Normal measuring signal, no alarm

y Measuring signal
 y_T Set value for **Tolerance width**

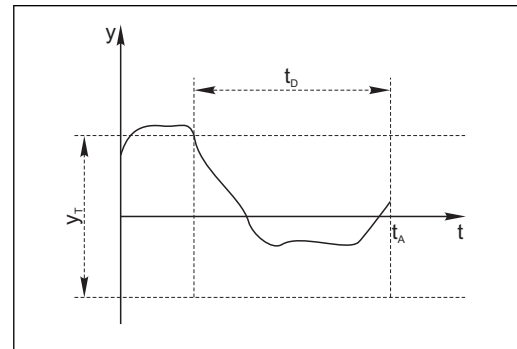

A0028842

16 Stagnating signal, alarm is triggered

t_D Set value for **Duration**
 t_A Time when the alarm is triggered

Main causes of stagnating measured values

- Contaminated sensor, or sensor outside of medium
- Sensor defective
- Process error (e.g. through control system)

Remedial action

1. Clean sensor.
2. Check positioning of sensor in medium.
3. Check electrode system.
4. Switch controller off and then switch it back on.

Menu/Setup/Inputs/Channel: Sensor type/Extended setup/Diagnostics settings/► Process Check System		
Function	Options	Info
Function	Selection <ul style="list-style-type: none"> ▪ Off ▪ On Factory setting Off	Switches the function on or off
Duration	1 to 240 min Factory setting 60 min	Enter the time after which the timer should time out. When this time expires, diagnostic message Calibration timer is displayed with code 102.
Tolerance width <i>Not for pH/ORP sensors</i>	The range depends on the sensor Factory setting Depends on the sensor	Interval around the measuring signal (raw value) for detecting stagnation. Measured values within the set interval are regarded as stagnating.

Limits operating hours

The total operating time of the sensor and its use under extreme conditions is monitored. If the operating time exceeds the defined threshold values, the device issues a corresponding diagnostics message.

-  Each sensor has a limited life expectancy which heavily depends on the operating conditions. If you specify warning limits for operating times under extreme conditions, you can guarantee the operation of your measuring point without any downtime by performing maintenance tasks in time.

Menu/Setup/Inputs/Channel: Disinfection/Extended setup/Diagnostics settings/► Limits operating hours		
Function	Options	Info
 The range of adjustment for the operating hours alarm and warning limits is generally 1 to 50000 h.		
Function	Options <ul style="list-style-type: none"> ▪ Off ▪ On Factory setting On	On The operation of the sensor under extreme conditions is monitored, recorded in the sensor and diagnostics messages are displayed on the controller. Off No diagnostics messages. However, the time the sensor operates under extreme conditions is recorded in the sensor and can be read in the sensor information in the diagnostics menu.
► Operating time		Total operating time of the sensor
Warning limit	Factory setting 10000 h	Diagnostics code and associated message text: 199 Operating time
► Operation > 15 °C		
Warning limit	Factory setting 10000 h	Diagnostics code and associated message text: 178 Operating time
► Operation > 30 °C		
Warning limit	Factory setting 10000 h	Diagnostics code and associated message text: 191 Operating time
► Operation > 20 nA		
Warning limit	Factory setting 10000 h	Diagnostics code and associated message text: 177 Operating time
► Operation > 100 nA		
Warning limit	Factory setting 10000 h	Diagnostics code and associated message text: 176 Operating time

Limits operating hours cap

Menu/Setup/Inputs/Channel: Disinfection/Extended setup/Diagnostics settings/► Limits operating hours cap		
Function	Options	Info
 The range of adjustment for the operating hours alarm and warning limits is generally 1 to 50000 h.		
Function	Options <ul style="list-style-type: none"> ▪ Off ▪ On Factory setting On	On The operation of the sensor cap under extreme conditions is monitored, recorded in the sensor and diagnostics messages are displayed on the controller. Off No diagnostics messages. However, the time the sensor operates under extreme conditions is recorded in the sensor and can be read in the sensor information in the diagnostics menu.
► Operating time		Total operating time of the sensor cap
Warning limit	Factory setting 10000 h	Diagnostics code and associated message text: 199 Operating time
► Operation > 15 °C		
Warning limit	Factory setting 10000 h	Diagnostics code and associated message text: 178 Operating time
► Operation > 30 °C		
Warning limit	Factory setting 10000 h	Diagnostics code and associated message text: 191 Operating time
► Operation > %0V nA		%0V is a variable. Depending on the sensor, a numerical value is displayed instead of this variable.
Warning limit	Factory setting 2200 h	Diagnostics code and associated message text: 111 Operating time cap
► Operation > %0V nA		%0V is a variable. Depending on the sensor, a numerical value is displayed instead of this variable.
Warning limit	Factory setting 2200 h	Diagnostics code and associated message text: 111 Operating time cap

Electrolyte counter

The electrolyte consumption is calculated on the basis of the amount of charge that penetrates the sensor diaphragm.

The following applies for the sensor CCS142D:

Half the chloride would be consumed and the entire dihydrogen phosphate would be converted to monohydrogen phosphate in an electrolyte filling (4 ml) at 20 000 000 µAs (=20 As). This would render the electrolyte and the sensor unusable. With a view to predictive maintenance, you should replace the electrolyte at 10 000 000 µAs at the latest, and preferably at 5 000 000 µAs. 25%-50% of the dihydrogen phosphate is then consumed. The calculation presumes that the buffer of the electrolyte is only changed by the electrochemical conversion of hypochlorous acid. It does not take into account the penetration of acids or bases into the sensor.

Depending on the application it can be necessary to change the electrolyte before a charge of 5 As is reached.

Menu/Setup/Inputs/Channel: Disinfection/Extended setup/Diagnostics settings/► Electrolyte counter		
Function	Options	Info
Function	Options <ul style="list-style-type: none"> ▪ Off ▪ On Factory setting Off	Switches the function on or off
Electrolyte capacity	Read only	
Warning limit	Range of adjustment and factory setting Depends on the sensor	Associated diagnostics code and message text: 534 Electrolyte warning

pH limit value monitoring

Menu/Setup/Inputs/Channel: Disinfection/Extended setup/Diagnostics settings/► pH limit monitoring		
Function	Options	Info
Function	Options <ul style="list-style-type: none"> ▪ Off ▪ On Factory setting Off	Switches the function on or off
Upper warning limit	Lower warning limit +0.01 to 14.00 Factory setting 13.00	Associated diagnostics code and message text: 945
Lower warning limit	1.0 to 12.99 Factory setting 2.0	Associated diagnostics code and message text: 946

Diagnostic behavior

The list of diagnostic messages displayed depends on the path selected. There are device-specific messages, and messages that depend on what sensor is connected.

Menu/Setup/(General settings or Inputs<Sensor channel>)/Extended setup/Diagnostics settings/Diag. behavior		
Function	Options	Info
List of diagnostic messages		► Select the message to be changed. Only then can you make the settings for this message.
Diag. code	Read only	
Diagnostic message	Selection <ul style="list-style-type: none"> ▪ On ▪ Off Factory setting Depends on the message	You can deactivate or reactivate a diagnostic message here. Deactivating means: <ul style="list-style-type: none"> ▪ No error message in the measuring mode ▪ No error current at the current output
Error current	Selection <ul style="list-style-type: none"> ▪ On ▪ Off Factory setting Depends on the message	► Decide whether an error current should be output at the current output if the diagnostic message display is activated.  In the event of general device errors, the error current is output at all the current outputs. In the event of channel-specific errors, the error current is only output at the assigned current output.

Menu/Setup/(General settings or Inputs<Sensor channel>)/Extended setup/Diagnostics settings/Diag. behavior		
Function	Options	Info
Status signal	<p>Selection</p> <ul style="list-style-type: none"> ▪ Maintenance (M) ▪ Out of specification (S) ▪ Function check (C) ▪ Failure (F) <p>Factory setting Depends on the message</p>	<p>The messages are divided into different error categories in accordance with NAMUR NE 107.</p> <ul style="list-style-type: none"> ▶ Decide whether you want to change a status signal assignment for your application.
Diag. output	<p>Selection</p> <ul style="list-style-type: none"> ▪ None ▪ Alarm relay ▪ Binary output ▪ Relay 1 to n (depends on the device version) <p>Factory setting None</p>	<p>You can use this function to select an output to which the diagnostic message should be assigned.</p> <p>You can use this function to select a relay output and/or binary output to which the diagnostic message should be assigned.</p> <p>You can use this function to select a binary output to which the diagnostic message should be assigned.</p> <p>For sensors with the Memosens protocol: Before being able to assign the message to an output you must first configure a relay output to Diagnostics . (Menu/Setup/Outputs: Assign the Diagnostics function and set the Operating mode to as assigned .)</p>
<p> An alarm relay is always available, regardless of the device version. Other relays are optional.</p>		
Cleaning program (for sensors)	<p>Selection</p> <ul style="list-style-type: none"> ▪ None ▪ Cleaning 1 ▪ Cleaning 2 ▪ Cleaning 3 ▪ Cleaning 4 <p>Factory setting None</p>	<ul style="list-style-type: none"> ▶ Decide whether the diagnostic message should trigger a cleaning program. <p>You can define the cleaning programs under: Menu/Setup/Additional functions/Cleaning.</p>
Detail information	Read only	Here you can find more information on the diagnostic message and instructions on how to resolve the problem.

8.2.7 Name check

With this function, you specify which sensors are accepted at your device.

Menu/Setup/Inputs/Channel: Sensor type/Extended setup/Diagnostics settings/► Tag control		
Function	Options	Info
Operating mode	Selection <ul style="list-style-type: none"> ▪ Off ▪ Tag ▪ Group Factory setting Off	Off No name check, all sensors are accepted. Tag Only sensors with the same tag name are accepted. Group Only sensors in the same tag group are accepted.
Tag	Free text Factory setting <ul style="list-style-type: none"> ▪ EH_CM44_ ▪ EH_CM44R_ ▪ EH_CSF48_ ▪ EH_CSP44_ 	Enter the tag name. The controller checks every sensor to be connected as to whether this sensor belongs to the measuring point, and only accepts the sensors that have the same name.
Group	Numerical Factory setting 0	

8.2.8 Sensor replacement

Menu/Setup/Inputs/Channel: Sensor type/Extended setup/Sensor change

- On
When the sensor is replaced, the last measured value is retained via the "hold" function. A diagnostics message is not triggered.
- Off
When the sensor is replaced, the last measured value is not retained and triggers a diagnostics message.

8.2.9 Data processing factory setting

Here you can restore the factory settings for the sensor input.

Menu/Setup/Inputs/Channel: Sensor type/Extended setup

1. ► **Factory default measurement processing**
2. Respond to prompt: **OK** when the prompt for the device software appears.
 - ↳ Only the factory settings for this particular input are restored. All other settings remain unchanged.

9 Inputs: Drinking water turbidity

9.1 Basic settings

9.1.1 Sensor identification

Menu/Setup/Inputs/Channel: sensor type		
Function	Options	Info
Channel	Selection <ul style="list-style-type: none"> ▪ Off ▪ On Factory setting On	On The channel display is switched on in the measuring mode Off The channel is not displayed in the measuring mode, regardless of whether a sensor is connected or not.
Sensor type	Read only	Connected sensor type
Order code	(Only available if a sensor is connected)	Order code of the connected sensor

9.1.2 Application

The sensor is precalibrated on leaving the factory. As such, it can be used in a wide range of applications (e.g. clear water measurement) without the need for additional calibration. The factory calibrations for the Formazine, Kaolin, PSL and Diatomite applications are based on 20 calibration points in each case. In addition to the factory calibration data, which cannot be modified, the sensor has five other data records to be used for storing process calibrations.

 Calibration data records are saved under an individual name. You can add your own data records during each calibration. These are then available for selection under **Application**.

Menu/Setup/Inputs/Channel: Turbidity		
Function	Options	Info
Application type	Selection Clear water Factory setting Clear water	Preselection for saved calibration data records
Application	Selection <ul style="list-style-type: none"> ▪ Formazine ▪ Kaolin ▪ PSL ▪ Diatomite Factory setting Clear water	Select a saved calibration data record

9.1.3 Damping

The damping causes a floating average curve of the measured values over the time specified.

Menu/Setup/Inputs/Channel: sensor type		
Function	Options	Info
Depends on the sensor ¹⁾	0 to 600 s	You specify the damping of the main measured value and that of the integrated temperature sensor.
Damping temp.	Factory setting 0 s	

- 1) **Damping pH** or **Damping ORP** or **Damping Cond** or **Damping DO** or **Damping DI** or **Damping nitrate** or **Damping SAC** or **Damping turbidity**

9.1.4 Manual hold

Menu/Setup/Inputs/Channel: sensor type		
Function	Options	Info
Manual hold	Selection <ul style="list-style-type: none"> ■ Off ■ On Factory setting Off	On You can use this function to set the channel manually to "Hold". Off No channel-specific hold

9.2 Advanced setup

9.2.1 Measured value formats

Menu/Setup/Inputs/Channel: Turbidity/► Extended setup		
Function	Options	Info
Temperature format	Selection <ul style="list-style-type: none"> ■ #.# ■ #.## Factory setting #.#	Specify the number of decimal places.
Main value format	Selection <ul style="list-style-type: none"> ■ #.# ■ #.## ■ #.### ■ # Factory setting #.#	

9.2.2 Unit

Menu/Setup/Inputs/Channel: Turbidity/► Extended setup		
Function	Options	Info
Unit Application = Formazine	Selection <ul style="list-style-type: none"> ▪ FNU ▪ NTU ▪ FTU ▪ TE/F ▪ EBC ▪ ASBC Factory setting FNU	Select the unit for the main measured value. FNU Formazine Nephelometric Unit, 90° scattered light measurement as per ISO 7027 NTU Nephelometric Turbidity Unit, 90° scattered light measurement as per US standards, identical to FTU FTU Formazine Turbidity Unit, used in water treatment TE/F Turbidity unit/formazine, German unit in water treatment EBC Turbidity unit, European/international unit in breweries ASBC American Society of Brewing Chemists auto (g/l; mg/l) Automatic changeover between mg/l or g/lfnu
Unit Application = Kaolin or Diatomite	Selection <ul style="list-style-type: none"> ▪ auto (g/l; mg/l) ▪ ppm ▪ mg/l ▪ g/l Factory setting mg/l	
Unit Application = PSL	Selection 度 Factory setting 度	

9.2.3 Cleaning hold

Menu/Setup/Inputs/Channel: Sensor type/► Extended setup		
Function	Options	Info
Cleaning hold	Selection <ul style="list-style-type: none"> ▪ None ▪ Cleaning 1 ... 4 Factory setting None	► For selecting one or more cleaning programs (multiple selection). ↳ For the programs defined, the channel goes to "Hold" while cleaning is in progress. Cleaning programs are executed: <ul style="list-style-type: none"> ▪ At a specified interval For this, the cleaning program must be started. ▪ If a diagnostics message is pending on the channel and a cleaning has been specified for this message (→ Inputs/Channel: Sensor type/Diagnostics settings/Diag. behavior/Diagnostic number/Cleaning program).

 You define the cleaning programs in the **Setup/Additional functions/Cleaning**.

9.2.4 External hold

You can trigger a hold for all the devices of a measuring point via a digital signal, e.g. a fieldbus signal. Make sure that you do not use the hold signal elsewhere. You can assign an external hold individually to every sensor input.

 You will only find the function in the initial menu if you have configured the signals for the external hold in the general hold settings beforehand:

Menu/Setup/General settings/Hold settings/External hold.

Menu/Setup/Inputs/Channel: Sensor type/Extended setup/► External hold		
Function	Options	Info
Source	Selection <ul style="list-style-type: none"> ▪ Binary inputs ▪ Fieldbus signals Factory setting None	<ol style="list-style-type: none"> 1. For selecting the signal source of the external hold. <ul style="list-style-type: none"> ↳ Multiple selection is possible. 2. OK: confirms selection.

9.2.5 Calibration settings

Calibration timer and calibration expiration date

You can specify the calibration interval for the sensor here. Once the time configured elapses, the **Calibration timer**.

 The timer is reset automatically if you recalibrate the sensor.

Menu/Setup/Inputs/Channel: Sensor type/Extended setup/► Calib. settings		
Function	Options	Info
Calibration timer	Selection <ul style="list-style-type: none"> ▪ Off ▪ On Factory setting Off	Switches the function on or off
Calibration timer value	1 to 10 000 h Factory setting 1000 h	Enter the time after which the timer should time out. When this time expires, diagnostic message Calibration timer is displayed with code 102.
Calib. expiration time	Selection <ul style="list-style-type: none"> ▪ Off ▪ On Factory setting Off	The function checks whether the calibration of a sensor is still valid. Example: you install a pre-calibrated sensor. The function checks how long ago the sensor was last calibrated. A diagnostics message is displayed if the time since the last calibration is longer than specified by the predefined warning and alarm limit.
► Calib. expiration time		
Warning limit	Factory setting 48 weeks	Diagnostic message: 105 Calibration validity
Alarm limit	Factory setting 52 weeks	Diagnostic message: 104 Calibration validity
Warning and alarm limits mutually influence each other's possible adjustment range. Range of adjustment which must include both limits: 1 to 104 weeks Generally, the following applies: alarm limit > warning limit		

Stability criteria

You define the permitted measured value fluctuation which must not be exceeded in a certain timeframe during calibration. If the permitted difference is exceeded, calibration is not permitted and is aborted automatically.

Menu/Setup/Inputs/Channel: Turbidity/► Extended setup/Calib. settings/► Stability criteria		
Function	Options	Info
Delta signal	0.1 to 5.0 % Factory setting 2.0 %	Permitted measured value fluctuation during calibration.
Delta temperature	0.10 to 2.00 K Factory setting 0.50 K	Permitted temperature fluctuation during calibration
Duration	5 to 100 s Factory setting 20 s	Timeframe within which the permitted range for measured value fluctuation should not be exceeded

9.2.6 Diagnostics settings

This menu branch is used for specifying warning limits, and for defining whether and how diagnostics tools should be used.

The associated diagnostics code is displayed for every setting.

Process check system (PCS)

The process check system (PCS) checks the measuring signal for stagnation. An alarm is triggered if the measuring signal does not change over a specific period (several measured values).

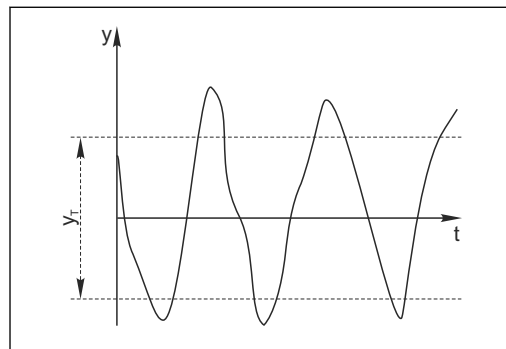

17 Normal measuring signal, no alarm

y Measuring signal
 y_T Set value for **Tolerance width**

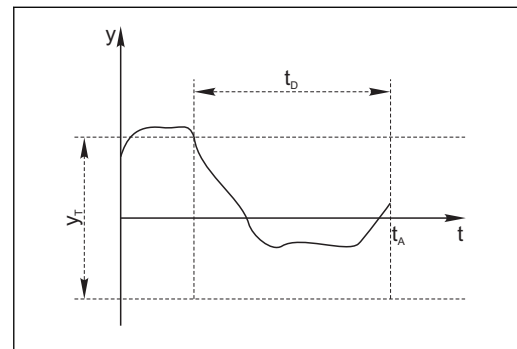

18 Stagnating signal, alarm is triggered

t_D Set value for **Duration**
 t_A Time when the alarm is triggered

Main causes of stagnating measured values

- Contaminated sensor, or sensor outside of medium
- Sensor defective
- Process error (e.g. through control system)

Remedial action



1. Clean sensor.
2. Check positioning of sensor in medium.
3. Check electrode system.
4. Switch controller off and then switch it back on.

Menu/Setup/Inputs/Channel: Sensor type/Extended setup/Diagnostics settings/► Process Check System		
Function	Options	Info
Function	Selection <ul style="list-style-type: none"> ▪ Off ▪ On Factory setting Off	Switches the function on or off
Duration	1 to 240 min Factory setting 60 min	Enter the time after which the timer should time out. When this time expires, diagnostic message Calibration timer is displayed with code 102.
Tolerance width <i>Not for pH/ORP sensors</i>	The range depends on the sensor Factory setting Depends on the sensor	Interval around the measuring signal (raw value) for detecting stagnation. Measured values within the set interval are regarded as stagnating.

Limits operating hours

The total operating time of the sensor and its use under extreme conditions is monitored. If the operating time exceeds the defined threshold values, the device issues a corresponding diagnostics message.



-  Each sensor has a limited life expectancy which heavily depends on the operating conditions. If you specify warning limits for operating times under extreme conditions, you can guarantee the operation of your measuring point without any downtime by performing maintenance tasks in time.

Menu/Setup/Inputs/Channel: Turbidity/Extended setup/Diagnostics settings/► Limits operating hours		
Function	Options	Info
 The range of adjustment for the operating hours alarm and warning limits is generally 1 to 50000 h.		
Function	Selection <ul style="list-style-type: none"> ▪ Off ▪ On Factory setting On	On The operation of the sensor under extreme conditions is monitored, recorded in the sensor and diagnostics messages are displayed on the controller. Off No diagnostics messages. However, the time the sensor operates under extreme conditions is recorded in the sensor and can be read in the sensor information in the diagnostics menu.
► Operating time		Total operating time of the sensor
Warning limit	Factory setting 10000 h	Diagnostics code and associated message text: 199 Operating time
 The names of the following menu functions depend on the sensor specification. For this reason, they cannot be specified here.		
► Below specified temperature		
Warning limit	Factory setting 10000 h	Diagnostics code and associated message text: 935 Process temp. low
► Above specified temperature		
Warning limit	Factory setting 10000 h	Diagnostics code and associated message text: 934 Process temp. high
► Below specified limit value		
Warning limit	Factory setting 10000 h	Diagnostics code and associated message text: 943 Process value

Menu/Setup/Inputs/Channel: Turbidity/Extended setup/Diagnostics settings/► Limits operating hours		
Function	Options	Info
► Above specified limit value		
Warning limit	Factory setting 10000 h	Diagnostics code and associated message text: 942 Process value

Diagnostic behavior

The list of diagnostic messages displayed depends on the path selected. There are device-specific messages, and messages that depend on what sensor is connected.

Menu/Setup/(General settings or Inputs<Sensor channel>)/Extended setup/Diagnostics settings/Diag. behavior		
Function	Options	Info
List of diagnostic messages		► Select the message to be changed. Only then can you make the settings for this message.
Diag. code	Read only	
Diagnostic message	Selection <ul style="list-style-type: none"> ▪ On ▪ Off Factory setting Depends on the message	You can deactivate or reactivate a diagnostic message here. Deactivating means: <ul style="list-style-type: none"> ▪ No error message in the measuring mode ▪ No error current at the current output
Error current	Selection <ul style="list-style-type: none"> ▪ On ▪ Off Factory setting Depends on the message	► Decide whether an error current should be output at the current output if the diagnostic message display is activated.  In the event of general device errors, the error current is output at all the current outputs. In the event of channel-specific errors, the error current is only output at the assigned current output.
Status signal	Selection <ul style="list-style-type: none"> ▪ Maintenance (M) ▪ Out of specification (S) ▪ Function check (C) ▪ Failure (F) Factory setting Depends on the message	The messages are divided into different error categories in accordance with NAMUR NE 107. ► Decide whether you want to change a status signal assignment for your application.
Diag. output	Selection <ul style="list-style-type: none"> ▪ None ▪ Alarm relay ▪ Binary output ▪ Relay 1 to n (depends on the device version) Factory setting None	You can use this function to select an output to which the diagnostic message should be assigned. You can use this function to select a relay output and/or binary output to which the diagnostic message should be assigned. You can use this function to select a binary output to which the diagnostic message should be assigned. For sensors with the Memosens protocol: Before being able to assign the message to an output you must first configure a relay output to Diagnostics . (Menu/Setup/Outputs: Assign the Diagnostics function and set the Operating mode to as assigned.)
 An alarm relay is always available, regardless of the device version. Other relays are optional.		

Menu/Setup/(General settings or Inputs<Sensor channel>)/Extended setup/Diagnostics settings/Diag. behavior		
Function	Options	Info
Cleaning program (for sensors)	Selection <ul style="list-style-type: none"> ▪ None ▪ Cleaning 1 ▪ Cleaning 2 ▪ Cleaning 3 ▪ Cleaning 4 Factory setting None	<p>► Decide whether the diagnostic message should trigger a cleaning program.</p> <p>You can define the cleaning programs under: Menu/Setup/Additional functions/Cleaning.</p>
Detail information	Read only	Here you can find more information on the diagnostic message and instructions on how to resolve the problem.

9.2.7 Signal processing

Menu/Setup/Inputs/Channel: Turbidity/► Extended setup/Signal processing/► Measurement filter		
Function	Options	Info
Configuration method	Selection <ul style="list-style-type: none"> ▪ Standard ▪ Specialist Factory setting Specialist	Standard Choice of 3 predefined configurations Specialist You specify in detail how the measured value filter should react.
Filter level Configuration method = Standard	Selection <ul style="list-style-type: none"> ▪ Low ▪ Medium ▪ High Factory setting Medium	Select a filter method. The following parameters are preset at the factory and are displayed as non-editable parameters. With Configuration method = Specialist you can configure the parameters.
► Display parameter Configuration method = Standard	Read only	
Relative limit Configuration method = Specialist	0.000000 to 1.000000 Factory setting 0.000020	Specify the filter strength 0.000000 ... constant measured value 0.000020 ... standard 0.010000 ... low 1.000000 ... off
Dwell time before jump Configuration method = Specialist	0 to 1000 s Factory setting 10 s	Specify the time after which the measured value must change at the very latest.
Integration time before jump Configuration method = Specialist	0 to 1000 s Factory setting 4 s	Specify the number of measured values (time span) which should be used for the next change value.
Dynamic Configuration method = Specialist	1 to 3 Factory setting 3	How dynamically should the filter respond: slow (1) to fast (3).
Smoothing Configuration method = Specialist	0.00000 to 10.00000 Factory setting 0.00800	Value smoothing The smoothing value should always be attuned with the filter strength (Relative limit). The higher the relative limit the smaller the smoothing and vice versa. You should set the smoothing value to 0 as of a relative limit of 0.01.

9.2.8 Name check

With this function, you specify which sensors are accepted at your device.

Menu/Setup/Inputs/Channel: Sensor type/Extended setup/Diagnostics settings/► Tag control		
Function	Options	Info
Operating mode	Selection <ul style="list-style-type: none"> ▪ Off ▪ Tag ▪ Group Factory setting Off	Off No name check, all sensors are accepted. Tag Only sensors with the same tag name are accepted. Group Only sensors in the same tag group are accepted.
Tag	Free text Factory setting <ul style="list-style-type: none"> ▪ EH_CM44_ ▪ EH_CM44R_ ▪ EH_CSF48_ ▪ EH_CSP44_ 	Enter the tag name. The controller checks every sensor to be connected as to whether this sensor belongs to the measuring point, and only accepts the sensors that have the same name.
Group	Numerical Factory setting 0	

9.2.9 Sensor replacement

Menu/Setup/Inputs/Channel: Sensor type/Extended setup/Sensor change

- On
When the sensor is replaced, the last measured value is retained via the "hold" function. A diagnostics message is not triggered.
- Off
When the sensor is replaced, the last measured value is not retained and triggers a diagnostics message.

9.2.10 Data processing factory setting

Here you can restore the factory settings for the sensor input.

Menu/Setup/Inputs/Channel: Sensor type/Extended setup

1. ► **Factory default measurement processing**
2. Respond to prompt: **OK** when the prompt for the device software appears.
 - ↳ Only the factory settings for this particular input are restored. All other settings remain unchanged.

9.2.11 Sensor factory setting

Here you can restore the sensor factory settings.

Menu/Setup/Inputs/Channel: Sensor type/Extended setup

1. ► **Factory default sensor**
2. Respond to prompt: **OK** when the prompt for the device software appears.
 - ↳ Only the factory settings for the sensor are restored. The settings for the input remain unchanged.

10 Inputs: Turbidity and solids

10.1 Basic settings

10.1.1 Sensor identification

Menu/Setup/Inputs/Channel: sensor type		
Function	Options	Info
Channel	Selection <ul style="list-style-type: none"> ▪ Off ▪ On Factory setting On	On The channel display is switched on in the measuring mode Off The channel is not displayed in the measuring mode, regardless of whether a sensor is connected or not.
Sensor type	Read only (Only available if a sensor is connected)	Connected sensor type
Order code		Order code of the connected sensor

10.1.2 Application

The sensor is precalibrated on leaving the factory. As such, it can be used in a wide range of applications (e.g. clear water measurement) without the need for additional calibration. The factory calibrations are each based on a "three-point calibration". The Kaolin and Formazine applications are already fully calibrated and can be used without any further calibration. All other applications are precalibrated with reference samples and require calibration to the corresponding application. In addition to the factory calibration data, which cannot be modified, the sensor has five other data records to be used for storing process calibrations.

 Calibration data records are saved under an individual name. You can add your own data records during each calibration. These are then available for selection under **Application** .

Menu/Setup/Inputs/Channel: Turbidity		
Function	Options	Info
Application type	Selection <ul style="list-style-type: none"> ▪ Clear water ▪ Solid Factory setting Clear water	Preselection for saved calibration data records
Application	Depends on the sensor	Select a saved calibration data record  Detailed information on selecting the relevant data record is provided in the Operating Instructions for the sensor. Operating Instructions Turbimax CUS51D, BA00461C

10.1.3 Damping

The damping causes a floating average curve of the measured values over the time specified.

Menu/Setup/Inputs/Channel: sensor type		
Function	Options	Info
Depends on the sensor ¹⁾	0 to 600 s	You specify the damping of the main measured value and that of the integrated temperature sensor.
Damping temp.	Factory setting 0 s	

- 1) **Damping pH** or **Damping ORP** or **Damping Cond** or **Damping DO** or **Damping DI** or **Damping nitrate** or **Damping SAC** or **Damping turbidity**

10.1.4 Manual hold

Menu/Setup/Inputs/Channel: sensor type		
Function	Options	Info
Manual hold	Selection <ul style="list-style-type: none"> ■ Off ■ On Factory setting Off	On You can use this function to set the channel manually to "Hold". Off No channel-specific hold

10.2 Advanced setup

10.2.1 Measured value formats

Menu/Setup/Inputs/Channel: Turbidity/► Extended setup		
Function	Options	Info
Temperature format	Selection <ul style="list-style-type: none"> ■ #.# ■ #.## Factory setting #.#	Specify the number of decimal places.
Main value format	Selection <ul style="list-style-type: none"> ■ #.# ■ #.## ■ #.### ■ # Factory setting #.#	

10.2.2 Unit

Menu/Setup/Inputs/Channel: Turbidity/► Extended setup		
Function	Options	Info
Unit Application type = Clear water	Selection <ul style="list-style-type: none"> ▪ FNU ▪ NTU Factory setting FNU	Select the unit for the main measured value. FNU Formazine Nephelometric Unit, 90° scattered light measurement as per ISO 7027 NTU Nephelometric Turbidity Unit, 90° scattered light measurement as per US standards, identical to FTU %TS % total solids auto (g/l; mg/l) Automatic changeover between mg/l or g/lfnu
Unit Application type = Solid	Selection <ul style="list-style-type: none"> ▪ auto (g/l; mg/l) ▪ ppm ▪ %TS ▪ mg/l ▪ g/l Factory setting auto (g/l; mg/l)	(Information from previous row continues)

10.2.3 Cleaning hold

Menu/Setup/Inputs/Channel: Sensor type/► Extended setup		
Function	Options	Info
Cleaning hold	Selection <ul style="list-style-type: none"> ▪ None ▪ Cleaning 1 ... 4 Factory setting None	<ul style="list-style-type: none"> ► For selecting one or more cleaning programs (multiple selection). <ul style="list-style-type: none"> ↳ For the programs defined, the channel goes to "Hold" while cleaning is in progress. Cleaning programs are executed: <ul style="list-style-type: none"> ▪ At a specified interval For this, the cleaning program must be started. ▪ If a diagnostics message is pending on the channel and a cleaning has been specified for this message (→ Inputs/Channel: Sensor type/Diagnostics settings/Diag. behavior/Diagnostic number/Cleaning program).

 You define the cleaning programs in the **Setup/Additional functions/Cleaning**.

10.2.4 External hold

You can trigger a hold for all the devices of a measuring point via a digital signal, e.g. a fieldbus signal. Make sure that you do not use the hold signal elsewhere. You can assign an external hold individually to every sensor input.

 You will only find the function in the initial menu if you have configured the signals for the external hold in the general hold settings beforehand:

Menu/Setup/General settings/Hold settings/External hold.

Menu/Setup/Inputs/Channel: Sensor type/Extended setup/► External hold		
Function	Options	Info
Source	Selection <ul style="list-style-type: none"> ▪ Binary inputs ▪ Fieldbus signals Factory setting None	<ol style="list-style-type: none"> 1. For selecting the signal source of the external hold. <ul style="list-style-type: none"> ↳ Multiple selection is possible. 2. OK: confirms selection.

10.2.5 Calibration settings

Calibration timer and calibration expiration date

You can specify the calibration interval for the sensor here. Once the time configured elapses, the **Calibration timer**.

 The timer is reset automatically if you recalibrate the sensor.

Menu/Setup/Inputs/Channel: Sensor type/Extended setup/► Calib. settings		
Function	Options	Info
Calibration timer	Selection <ul style="list-style-type: none"> ■ Off ■ On Factory setting Off	Switches the function on or off
Calibration timer value	1 to 10 000 h Factory setting 1000 h	Enter the time after which the timer should time out. When this time expires, diagnostic message Calibration timer is displayed with code 102.
Calib. expiration time	Selection <ul style="list-style-type: none"> ■ Off ■ On Factory setting Off	The function checks whether the calibration of a sensor is still valid. Example: you install a pre-calibrated sensor. The function checks how long ago the sensor was last calibrated. A diagnostics message is displayed if the time since the last calibration is longer than specified by the predefined warning and alarm limit.
► Calib. expiration time		
Warning limit	Factory setting 48 weeks	Diagnostic message: 105 Calibration validity
Alarm limit	Factory setting 52 weeks	Diagnostic message: 104 Calibration validity
Warning and alarm limits mutually influence each other's possible adjustment range. Range of adjustment which must include both limits: 1 to 104 weeks Generally, the following applies: alarm limit > warning limit		

Stability criteria

You define the permitted measured value fluctuation which must not be exceeded in a certain timeframe during calibration. If the permitted difference is exceeded, calibration is not permitted and is aborted automatically.

Menu/Setup/Inputs/Channel: Turbidity/► Extended setup/Calib. settings/► Stability criteria		
Function	Options	Info
Delta signal	0.1 to 5.0 % Factory setting 2.0 %	Permitted measured value fluctuation during calibration.
Delta temperature	0.10 to 2.00 K Factory setting 0.50 K	Permitted temperature fluctuation during calibration
Duration	5 to 100 s Factory setting 20 s	Timeframe within which the permitted range for measured value fluctuation should not be exceeded

10.2.6 Diagnostics settings

This menu branch is used for specifying warning limits, and for defining whether and how diagnostics tools should be used.

The associated diagnostics code is displayed for every setting.

Process check system (PCS)

The process check system (PCS) checks the measuring signal for stagnation. An alarm is triggered if the measuring signal does not change over a specific period (several measured values).

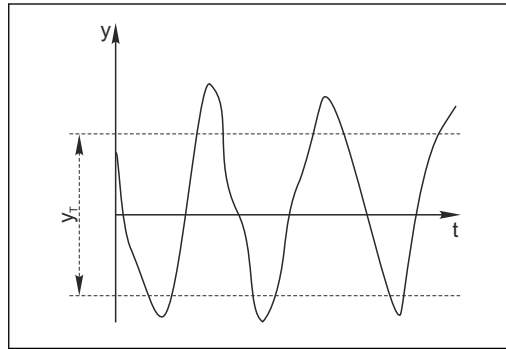

A0027276

19 Normal measuring signal, no alarm

y Measuring signal
 y_T Set value for Tolerance width

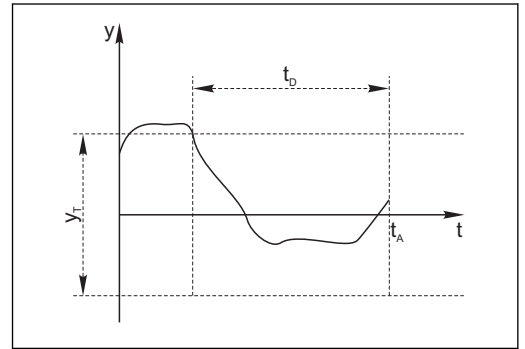

A0028842

20 Stagnating signal, alarm is triggered

t_D Set value for Duration
 t_A Time when the alarm is triggered

Main causes of stagnating measured values

- Contaminated sensor, or sensor outside of medium
- Sensor defective
- Process error (e.g. through control system)

Remedial action



1. Clean sensor.
2. Check positioning of sensor in medium.
3. Check electrode system.
4. Switch controller off and then switch it back on.

Menu/Setup/Inputs/Channel: Sensor type/Extended setup/Diagnostics settings/► Process Check System		
Function	Options	Info
Function	Selection <ul style="list-style-type: none"> ■ Off ■ On Factory setting Off	Switches the function on or off
Duration	1 to 240 min Factory setting 60 min	Enter the time after which the timer should time out. When this time expires, diagnostic message Calibration timer is displayed with code 102.
Tolerance width <i>Not for pH/ORP sensors</i>	The range depends on the sensor Factory setting Depends on the sensor	Interval around the measuring signal (raw value) for detecting stagnation. Measured values within the set interval are regarded as stagnating.

Limits operating hours



The total operating time of the sensor and its use under extreme conditions is monitored. If the operating time exceeds the defined threshold values, the device issues a corresponding diagnostics message.

-  Each sensor has a limited life expectancy which heavily depends on the operating conditions. If you specify warning limits for operating times under extreme conditions, you can guarantee the operation of your measuring point without any downtime by performing maintenance tasks in time.

Menu/Setup/Inputs/Channel: Turbidity/Extended setup/Diagnostics settings/▶ Limits operating hours		
Function	Options	Info
 The range of adjustment for the operating hours alarm and warning limits is generally 1 to 50000 h.		
Function	Selection <ul style="list-style-type: none"> ▪ Off ▪ On Factory setting On	On The operation of the sensor under extreme conditions is monitored, recorded in the sensor and diagnostics messages are displayed on the controller. Off No diagnostics messages. However, the time the sensor operates under extreme conditions is recorded in the sensor and can be read in the sensor information in the diagnostics menu.
▶ Operating time		Total operating time of the sensor
Warning limit	Factory setting 10000 h	Diagnostics code and associated message text: 199 Operating time
 The names of the following menu functions depend on the sensor specification. For this reason, they cannot be specified here.		
▶ Below specified temperature		
Warning limit	Factory setting 10000 h	Diagnostics code and associated message text: 935 Process temp. low
▶ Above specified temperature		
Warning limit	Factory setting 10000 h	Diagnostics code and associated message text: 934 Process temp. high
▶ Below specified limit value		
Warning limit	Factory setting 10000 h	Diagnostics code and associated message text: 943 Process value
▶ Above specified limit value		
Warning limit	Factory setting 10000 h	Diagnostics code and associated message text: 942 Process value

Diagnostic behavior

The list of diagnostic messages displayed depends on the path selected. There are device-specific messages, and messages that depend on what sensor is connected.

Menu/Setup/(General settings or Inputs<Sensor channel>)/Extended setup/Diagnostics settings/Diag. behavior		
Function	Options	Info
List of diagnostic messages		▶ Select the message to be changed. Only then can you make the settings for this message.
Diag. code	Read only	
Diagnostic message	Selection <ul style="list-style-type: none"> ▪ On ▪ Off Factory setting Depends on the message	You can deactivate or reactivate a diagnostic message here. Deactivating means: <ul style="list-style-type: none"> ▪ No error message in the measuring mode ▪ No error current at the current output
Error current	Selection <ul style="list-style-type: none"> ▪ On ▪ Off Factory setting Depends on the message	▶ Decide whether an error current should be output at the current output if the diagnostic message display is activated.  In the event of general device errors, the error current is output at all the current outputs. In the event of channel-specific errors, the error current is only output at the assigned current output.
Status signal	Selection <ul style="list-style-type: none"> ▪ Maintenance (M) ▪ Out of specification (S) ▪ Function check (C) ▪ Failure (F) Factory setting Depends on the message	The messages are divided into different error categories in accordance with NAMUR NE 107. ▶ Decide whether you want to change a status signal assignment for your application.
Diag. output	Selection <ul style="list-style-type: none"> ▪ None ▪ Alarm relay ▪ Binary output ▪ Relay 1 to n (depends on the device version) Factory setting None	You can use this function to select an output to which the diagnostic message should be assigned. You can use this function to select a relay output and/or binary output to which the diagnostic message should be assigned. You can use this function to select a binary output to which the diagnostic message should be assigned. For sensors with the Memosens protocol: Before being able to assign the message to an output you must first configure a relay output to Diagnostics . (Menu/Setup/Outputs : Assign the Diagnostics function and set the Operating mode to as assigned .)
 An alarm relay is always available, regardless of the device version. Other relays are optional.		
Cleaning program (for sensors)	Selection <ul style="list-style-type: none"> ▪ None ▪ Cleaning 1 ▪ Cleaning 2 ▪ Cleaning 3 ▪ Cleaning 4 Factory setting None	▶ Decide whether the diagnostic message should trigger a cleaning program. You can define the cleaning programs under: Menu/Setup/Additional functions/Cleaning .
Detail information	Read only	Here you can find more information on the diagnostic message and instructions on how to resolve the problem.

10.2.7 Name check

With this function, you specify which sensors are accepted at your device.

Menu/Setup/Inputs/Channel: Sensor type/Extended setup/Diagnostics settings/► Tag control		
Function	Options	Info
Operating mode	Selection <ul style="list-style-type: none"> ▪ Off ▪ Tag ▪ Group Factory setting Off	Off No name check, all sensors are accepted. Tag Only sensors with the same tag name are accepted. Group Only sensors in the same tag group are accepted.
Tag	Free text Factory setting <ul style="list-style-type: none"> ▪ EH_CM44_ ▪ EH_CM44R_ ▪ EH_CSF48_ ▪ EH_CSP44_ 	Enter the tag name. The controller checks every sensor to be connected as to whether this sensor belongs to the measuring point, and only accepts the sensors that have the same name.
Group	Numerical Factory setting 0	

10.2.8 Sensor replacement

Menu/Setup/Inputs/Channel: Sensor type/Extended setup/Sensor change

- On
When the sensor is replaced, the last measured value is retained via the "hold" function. A diagnostics message is not triggered.
- Off
When the sensor is replaced, the last measured value is not retained and triggers a diagnostics message.

10.2.9 Data processing factory setting

Here you can restore the factory settings for the sensor input.

Menu/Setup/Inputs/Channel: Sensor type/Extended setup

1. ► **Factory default measurement processing**
2. Respond to prompt: **OK** when the prompt for the device software appears.
 - ↳ Only the factory settings for this particular input are restored. All other settings remain unchanged.

10.2.10 Sensor factory setting

Here you can restore the sensor factory settings.

Menu/Setup/Inputs/Channel: Sensor type/Extended setup

1. ► **Factory default sensor**
2. Respond to prompt: **OK** when the prompt for the device software appears.
 - ↳ Only the factory settings for the sensor are restored. The settings for the input remain unchanged.

11 Inputs: SAC

11.1 Basic settings

11.1.1 Sensor identification

Menu/Setup/Inputs/Channel: sensor type		
Function	Options	Info
Channel	Selection <ul style="list-style-type: none"> ▪ Off ▪ On Factory setting On	On The channel display is switched on in the measuring mode Off The channel is not displayed in the measuring mode, regardless of whether a sensor is connected or not.
Sensor type	Read only (Only available if a sensor is connected)	Connected sensor type
Order code		Order code of the connected sensor

11.1.2 Basic application

 Calibration data records are saved under an individual name in the sensor. A new sensor is calibrated at the factory and thus already has appropriate data records. You can add your own data records during each calibration. These are then available for selection under **Application**.

Menu/Setup/Inputs/Channel: SAC		
Function	Options	Info
Basic application	Selection <ul style="list-style-type: none"> ▪ SAC ▪ Transm. ▪ Absorption ▪ COD ▪ TOC ▪ DOC ▪ BOD ▪ Tr. 10mm Factory setting SAC	Preselection for saved calibration data records Tr. 10mm The measured transmission is converted to an optical path length of 10 mm.
Application	Selection <ul style="list-style-type: none"> ▪ Factory calib. ▪ Dataset 1 ... 6 Factory setting Factory calib.	Select a saved calibration data record

11.1.3 Damping

The damping causes a floating average curve of the measured values over the time specified.

Menu/Setup/Inputs/Channel: sensor type		
Function	Options	Info
Depends on the sensor ¹⁾	0 to 600 s	You specify the damping of the main measured value and that of the integrated temperature sensor.
Damping temp.	Factory setting 0 s	

- 1) **Damping pH** or **Damping ORP** or **Damping Cond** or **Damping DO** or **Damping DI** or **Damping nitrate** or **Damping SAC** or **Damping turbidity**

11.1.4 Manual hold

Menu/Setup/Inputs/Channel: sensor type		
Function	Options	Info
Manual hold	Selection <ul style="list-style-type: none"> ■ Off ■ On Factory setting Off	On You can use this function to set the channel manually to "Hold". Off No channel-specific hold

11.2 Advanced setup

11.2.1 Measured value formats, unit and flash rate

Menu/Setup/Inputs/Channel: SAC/► Extended setup		
Function	Options	Info
Temperature format	Selection <ul style="list-style-type: none"> ■ #.# ■ #.## Factory setting #.#	Specify the number of decimal places.
Main value format	Selection <ul style="list-style-type: none"> ■ #.# ■ #.## ■ #.### ■ # Factory setting #.#	
Unit	Selection <ul style="list-style-type: none"> ■ None ■ % ■ mg/l ■ ppm ■ 1/m 	The unit of the main value depends on the basic application selected. Depending on the Basic application you can only choose from certain units. The factory setting is also dependent on the basic application.
Flash rate	0.1 to 2.0 Hz Factory setting 2.0 Hz	The flash rate influences the response time of the sensor on the one hand, and the sensor operating life on the other. The lower the rate, the slower the measured value change and the longer the operating life of the sensor. The faster the process needs to react to changes depending on the measured value, the higher the flash rate setting should be. However, this negatively impacts the sensor operating life.

11.2.2 Cleaning hold

Menu/Setup/Inputs/Channel: Sensor type/► Extended setup		
Function	Options	Info
Cleaning hold	Selection <ul style="list-style-type: none"> ▪ None ▪ Cleaning 1 ... 4 Factory setting None	<ul style="list-style-type: none"> ► For selecting one or more cleaning programs (multiple selection). <ul style="list-style-type: none"> ↳ For the programs defined, the channel goes to "Hold" while cleaning is in progress. Cleaning programs are executed: <ul style="list-style-type: none"> ▪ At a specified interval For this, the cleaning program must be started. ▪ If a diagnostics message is pending on the channel and a cleaning has been specified for this message (→ Inputs/Channel: Sensor type/Diagnostics settings/Diag. behavior/Diagnostic number/Cleaning program).

 You define the cleaning programs in the **Setup/Additional functions/Cleaning**.

11.2.3 External hold

You can trigger a hold for all the devices of a measuring point via a digital signal, e.g. a fieldbus signal. Make sure that you do not use the hold signal elsewhere. You can assign an external hold individually to every sensor input.

 You will only find the function in the initial menu if you have configured the signals for the external hold in the general hold settings beforehand:

Menu/Setup/General settings/Hold settings/External hold.

Menu/Setup/Inputs/Channel: Sensor type/Extended setup/► External hold		
Function	Options	Info
Source	Selection <ul style="list-style-type: none"> ▪ Binary inputs ▪ Fieldbus signals Factory setting None	<ol style="list-style-type: none"> 1. For selecting the signal source of the external hold. <ul style="list-style-type: none"> ↳ Multiple selection is possible. 2. OK: confirms selection.

11.2.4 Calibration settings

Calibration timer and calibration expiration date

You can specify the calibration interval for the sensor here. Once the time configured elapses, the **Calibration timer**.

 The timer is reset automatically if you recalibrate the sensor.

Menu/Setup/Inputs/Channel: Sensor type/Extended setup/► Calib. settings		
Function	Options	Info
Calibration timer	Selection <ul style="list-style-type: none"> ▪ Off ▪ On Factory setting Off	Switches the function on or off
Calibration timer value	1 to 10 000 h Factory setting 1000 h	Enter the time after which the timer should time out. When this time expires, diagnostic message Calibration timer is displayed with code 102.
Calib. expiration time	Selection <ul style="list-style-type: none"> ▪ Off ▪ On Factory setting Off	The function checks whether the calibration of a sensor is still valid. Example: you install a pre-calibrated sensor. The function checks how long ago the sensor was last calibrated. A diagnostics message is displayed if the time since the last calibration is longer than specified by the predefined warning and alarm limit.
► Calib. expiration time		
Warning limit	Factory setting 48 weeks	Diagnostic message: 105 Calibration validity
Alarm limit	Factory setting 52 weeks	Diagnostic message: 104 Calibration validity
Warning and alarm limits mutually influence each other's possible adjustment range. Range of adjustment which must include both limits: 1 to 104 weeks Generally, the following applies: alarm limit > warning limit		

Stability criteria

You define the permitted measured value fluctuation which must not be exceeded in a certain timeframe during calibration. If the permitted difference is exceeded, calibration is not permitted and is aborted automatically.

Menu/Setup/Inputs/Channel: SAC/► Extended setup/Calib. settings/► Stability criteria		
Function	Options	Info
Delta SAC	0.1 to 5.0 % Factory setting 2.0 %	Permitted measured value fluctuation during calibration.
Delta temperature	0.10 to 2.00 K Factory setting 0.50 K	Permitted temperature fluctuation during calibration
Duration	5 to 100 s Factory setting 10 s	Timeframe within which the permitted range for measured value fluctuation should not be exceeded

11.2.5 Diagnostics settings

This menu branch is used for specifying warning limits, and for defining whether and how diagnostics tools should be used.

The associated diagnostics code is displayed for every setting.

Process check system (PCS)

The process check system (PCS) checks the measuring signal for stagnation. An alarm is triggered if the measuring signal does not change over a specific period (several measured values).

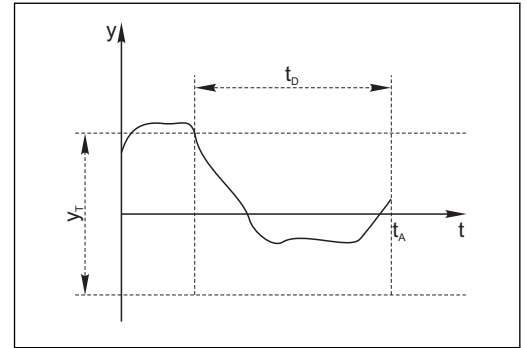
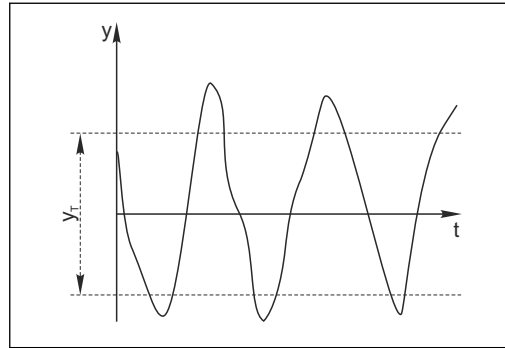

21 Normal measuring signal, no alarm

22 Stagnating signal, alarm is triggered

y Measuring signal

y_T Set value for Tolerance width

t_D Set value for Duration

t_A Time when the alarm is triggered

Main causes of stagnating measured values

- Contaminated sensor, or sensor outside of medium
- Sensor defective
- Process error (e.g. through control system)

Remedial action



1. Clean sensor.
2. Check positioning of sensor in medium.
3. Check electrode system.
4. Switch controller off and then switch it back on.

Menu/Setup/Inputs/Channel: Sensor type/Extended setup/Diagnostics settings/► Process Check System		
Function	Options	Info
Function	Selection <ul style="list-style-type: none"> ■ Off ■ On Factory setting Off	Switches the function on or off
Duration	1 to 240 min Factory setting 60 min	Enter the time after which the timer should time out. When this time expires, diagnostic message Calibration timer is displayed with code 102.
Tolerance width <i>Not for pH/ORP sensors</i>	The range depends on the sensor Factory setting Depends on the sensor	Interval around the measuring signal (raw value) for detecting stagnation. Measured values within the set interval are regarded as stagnating.

Limits operating hours



The total operating time of the sensor and its use under extreme conditions is monitored. If the operating time exceeds the defined threshold values, the device issues a corresponding diagnostics message.

- i** Each sensor has a limited life expectancy which heavily depends on the operating conditions. If you specify warning limits for operating times under extreme conditions, you can guarantee the operation of your measuring point without any downtime by performing maintenance tasks in time.

Menu/Setup/Inputs/Channel: SAC/Extended setup/Diagnostics settings/► Limits operating hours		
Function	Options	Info
 The range of adjustment for the operating hours alarm and warning limits is generally 1 to 50000 h.		
Function	Selection <ul style="list-style-type: none"> ▪ Off ▪ On Factory setting On	On The operation of the sensor under extreme conditions is monitored, recorded in the sensor and diagnostics messages are displayed on the controller. Off No diagnostics messages. However, the time the sensor operates under extreme conditions is recorded in the sensor and can be read in the sensor information in the diagnostics menu.
► Operating time		Total operating time of the sensor
Warning limit	Factory setting 10000 h	Diagnostics code and associated message text: 199 Operating time
 The names of the following menu functions depend on the sensor specification. For this reason, they cannot be specified here.		
► Below specified temperature		
Warning limit	Factory setting 10000 h	Diagnostics code and associated message text: 935 Process temp. low
► Above specified temperature		
Warning limit	Factory setting 10000 h	Diagnostics code and associated message text: 934 Process temp. high
► Below specified limit value		
Warning limit	Factory setting 10000 h	Diagnostics code and associated message text: 170 Process value
► Above specified limit value		
Warning limit	Factory setting 10000 h	Diagnostics code and associated message text: 169 Process value
► Filter change		
Warning limit	Factory setting 10000 h	Diagnostics code and associated message text: 157 Filter change
Alarm limit	Factory setting 15000 h	Diagnostics code and associated message text: 161 Filter change
► Flash counter, lamp		
Warning limit	Factory setting 126000000	Diagnostics code and associated message text: 171 Filter change
Alarm limit	Factory setting 131400000	Diagnostics code and associated message text: 771 Filter change

Diagnostic behavior

The list of diagnostic messages displayed depends on the path selected. There are device-specific messages, and messages that depend on what sensor is connected.

Menu/Setup/(General settings or Inputs<Sensor channel>)/Extended setup/Diagnostics settings/Diag. behavior		
Function	Options	Info
List of diagnostic messages		▶ Select the message to be changed. Only then can you make the settings for this message.
Diag. code	Read only	
Diagnostic message	Selection <ul style="list-style-type: none"> ▪ On ▪ Off Factory setting Depends on the message	You can deactivate or reactivate a diagnostic message here. Deactivating means: <ul style="list-style-type: none"> ▪ No error message in the measuring mode ▪ No error current at the current output
Error current	Selection <ul style="list-style-type: none"> ▪ On ▪ Off Factory setting Depends on the message	▶ Decide whether an error current should be output at the current output if the diagnostic message display is activated.  In the event of general device errors, the error current is output at all the current outputs. In the event of channel-specific errors, the error current is only output at the assigned current output.
Status signal	Selection <ul style="list-style-type: none"> ▪ Maintenance (M) ▪ Out of specification (S) ▪ Function check (C) ▪ Failure (F) Factory setting Depends on the message	The messages are divided into different error categories in accordance with NAMUR NE 107. ▶ Decide whether you want to change a status signal assignment for your application.
Diag. output	Selection <ul style="list-style-type: none"> ▪ None ▪ Alarm relay ▪ Binary output ▪ Relay 1 to n (depends on the device version) Factory setting None	You can use this function to select an output to which the diagnostic message should be assigned. You can use this function to select a relay output and/or binary output to which the diagnostic message should be assigned. You can use this function to select a binary output to which the diagnostic message should be assigned. For sensors with the Memosens protocol: Before being able to assign the message to an output you must first configure a relay output to Diagnostics . (Menu/Setup/Outputs: Assign the Diagnostics function and set the Operating mode to as assigned .)
 An alarm relay is always available, regardless of the device version. Other relays are optional.		
Cleaning program (for sensors)	Selection <ul style="list-style-type: none"> ▪ None ▪ Cleaning 1 ▪ Cleaning 2 ▪ Cleaning 3 ▪ Cleaning 4 Factory setting None	▶ Decide whether the diagnostic message should trigger a cleaning program. You can define the cleaning programs under: Menu/Setup/Additional functions/Cleaning .
Detail information	Read only	Here you can find more information on the diagnostic message and instructions on how to resolve the problem.

11.2.6 Name check

With this function, you specify which sensors are accepted at your device.

Menu/Setup/Inputs/Channel: Sensor type/Extended setup/Diagnostics settings/► Tag control		
Function	Options	Info
Operating mode	Selection <ul style="list-style-type: none"> ▪ Off ▪ Tag ▪ Group Factory setting Off	Off No name check, all sensors are accepted. Tag Only sensors with the same tag name are accepted. Group Only sensors in the same tag group are accepted.
Tag	Free text Factory setting <ul style="list-style-type: none"> ▪ EH_CM44_ ▪ EH_CM44R_ ▪ EH_CSF48_ ▪ EH_CSP44_ 	Enter the tag name. The controller checks every sensor to be connected as to whether this sensor belongs to the measuring point, and only accepts the sensors that have the same name.
Group	Numerical Factory setting 0	

11.2.7 Sensor replacement

Menu/Setup/Inputs/Channel: Sensor type/Extended setup/Sensor change

- On
When the sensor is replaced, the last measured value is retained via the "hold" function. A diagnostics message is not triggered.
- Off
When the sensor is replaced, the last measured value is not retained and triggers a diagnostics message.

11.2.8 Data processing factory setting

Here you can restore the factory settings for the sensor input.

Menu/Setup/Inputs/Channel: Sensor type/Extended setup

1. ► **Factory default measurement processing**
2. Respond to prompt: **OK** when the prompt for the device software appears.
 - ↳ Only the factory settings for this particular input are restored. All other settings remain unchanged.

11.2.9 Sensor factory setting

Here you can restore the sensor factory settings.

Menu/Setup/Inputs/Channel: Sensor type/Extended setup

1. ► **Factory default sensor**
2. Respond to prompt: **OK** when the prompt for the device software appears.
 - ↳ Only the factory settings for the sensor are restored. The settings for the input remain unchanged.

12 Inputs: Nitrate

12.1 Basic settings

12.1.1 Sensor identification

Menu/Setup/Inputs/Channel: sensor type		
Function	Options	Info
Channel	Selection <ul style="list-style-type: none"> ▪ Off ▪ On Factory setting On	On The channel display is switched on in the measuring mode Off The channel is not displayed in the measuring mode, regardless of whether a sensor is connected or not.
Sensor type	Read only (Only available if a sensor is connected)	Connected sensor type
Order code		Order code of the connected sensor

12.1.2 Application

Calibration data records are saved under an individual name in the nitrate sensor. A new sensor is calibrated at the factory and always has a corresponding data record. You can add additional data records during each calibration. These are then available for selection under **Application**.

Menu/Setup/Inputs/Channel: Nitrate		
Function	Options	Info
Application	Depends on the sensor	Select a saved calibration data record

12.1.3 Damping

The damping causes a floating average curve of the measured values over the time specified.

Menu/Setup/Inputs/Channel: sensor type		
Function	Options	Info
Depends on the sensor ¹⁾	0 to 600 s	You specify the damping of the main measured value and that of the integrated temperature sensor.
Damping temp.	Factory setting 0 s	

1) Damping pH or Damping ORP or Damping Cond or Damping DO or Damping DI or Damping nitrate or Damping SAC or Damping turbidity

12.1.4 Manual hold

Menu/Setup/Inputs/Channel: sensor type		
Function	Options	Info
Manual hold	Selection <ul style="list-style-type: none"> ▪ Off ▪ On Factory setting Off	On You can use this function to set the channel manually to "Hold". Off No channel-specific hold

12.2 Advanced setup

12.2.1 Measured value formats, unit and flash rate

Menu/Setup/Inputs/Channel:Nitrate /► Extended setup		
Function	Options	Info
Temperature format	Selection <ul style="list-style-type: none"> ■ #.# ■ #.## Factory setting #.#	Specify the number of decimal places.
Main value format	Selection <ul style="list-style-type: none"> ■ #.# ■ #.## ■ #.### ■ # Factory setting #.#	
Unit	Selection <ul style="list-style-type: none"> ■ mg/l NO3-N ■ mg/l NO3 ■ ppm NO3-N ■ ppm NO3 Factory setting mg/l NO3-N	Select the unit for the main measured value.
Flash rate	0.1 to 2.0 Hz Factory setting 2.0 Hz	The flash rate influences the response time of the sensor on the one hand, and the sensor operating life on the other. The lower the rate, the slower the measured value change and the longer the operating life of the sensor. The faster the process needs to react to changes depending on the measured value, the higher the flash rate setting should be. However, this negatively impacts the sensor operating life.

12.2.2 Cleaning hold

Menu/Setup/Inputs/Channel: Sensor type/► Extended setup		
Function	Options	Info
Cleaning hold	Selection <ul style="list-style-type: none"> ■ None ■ Cleaning 1 ... 4 Factory setting None	<p>► For selecting one or more cleaning programs (multiple selection).</p> <p>↳ For the programs defined, the channel goes to "Hold" while cleaning is in progress.</p> <p>Cleaning programs are executed:</p> <ul style="list-style-type: none"> ■ At a specified interval For this, the cleaning program must be started. ■ If a diagnostics message is pending on the channel and a cleaning has been specified for this message (→ Inputs/Channel: Sensor type/Diagnostics settings/Diag. behavior/Diagnostic number/Cleaning program).



You define the cleaning programs in the **Setup/Additional functions/Cleaning**.

12.2.3 External hold

You can trigger a hold for all the devices of a measuring point via a digital signal, e.g. a fieldbus signal. Make sure that you do not use the hold signal elsewhere. You can assign an external hold individually to every sensor input.

 You will only find the function in the initial menu if you have configured the signals for the external hold in the general hold settings beforehand:

Menu/Setup/General settings/Hold settings/External hold.

Menu/Setup/Inputs/Channel: Sensor type/Extended setup/► External hold		
Function	Options	Info
Source	Selection <ul style="list-style-type: none"> ▪ Binary inputs ▪ Fieldbus signals Factory setting None	<ol style="list-style-type: none"> 1. For selecting the signal source of the external hold. ↳ Multiple selection is possible. 2. OK: confirms selection.

12.2.4 Calibration settings

Calibration timer and calibration expiration date

You can specify the calibration interval for the sensor here. Once the time configured elapses, the **Calibration timer**.

 The timer is reset automatically if you recalibrate the sensor.

Menu/Setup/Inputs/Channel: Sensor type/Extended setup/► Calib. settings		
Function	Options	Info
Calibration timer	Selection <ul style="list-style-type: none"> ▪ Off ▪ On Factory setting Off	Switches the function on or off
Calibration timer value	1 to 10 000 h Factory setting 1000 h	Enter the time after which the timer should time out. When this time expires, diagnostic message Calibration timer is displayed with code 102.
Calib. expiration time	Selection <ul style="list-style-type: none"> ▪ Off ▪ On Factory setting Off	The function checks whether the calibration of a sensor is still valid. Example: you install a pre-calibrated sensor. The function checks how long ago the sensor was last calibrated. A diagnostics message is displayed if the time since the last calibration is longer than specified by the predefined warning and alarm limit.
► Calib. expiration time		
Warning limit	Factory setting 48 weeks	Diagnostic message: 105 Calibration validity
Alarm limit	Factory setting 52 weeks	Diagnostic message: 104 Calibration validity
Warning and alarm limits mutually influence each other's possible adjustment range. Range of adjustment which must include both limits: 1 to 104 weeks Generally, the following applies: alarm limit > warning limit		

Stability criteria

You define the permitted measured value fluctuation which must not be exceeded in a certain timeframe during calibration. If the permitted difference is exceeded, calibration is not permitted and is aborted automatically.

Menu/Setup/Inputs/Channel: Nitrate/► Extended setup/Calib. settings/► Stability criteria		
Function	Options	Info
Delta nitrate	0.1 to 5.0 % Factory setting 2.0 %	Permitted measured value fluctuation during calibration.
Delta temperature	0.10 to 2.00 K Factory setting 0.50 K	Permitted temperature fluctuation during calibration
Duration	10 to 100 s Factory setting 10 s	Timeframe within which the permitted range for measured value fluctuation should not be exceeded

12.2.5 Diagnostics settings

This menu branch is used for specifying warning limits, and for defining whether and how diagnostics tools should be used.

The associated diagnostics code is displayed for every setting.

Process check system (PCS)

The process check system (PCS) checks the measuring signal for stagnation. An alarm is triggered if the measuring signal does not change over a specific period (several measured values).

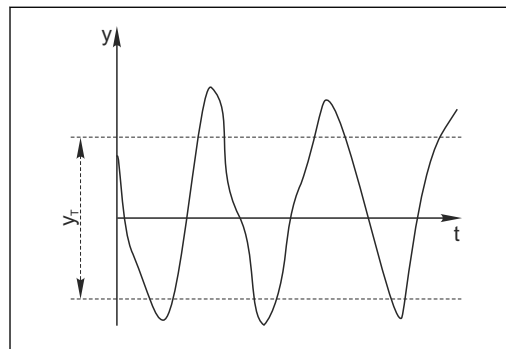

23 Normal measuring signal, no alarm

y Measuring signal
 y_T Set value for **Tolerance width**

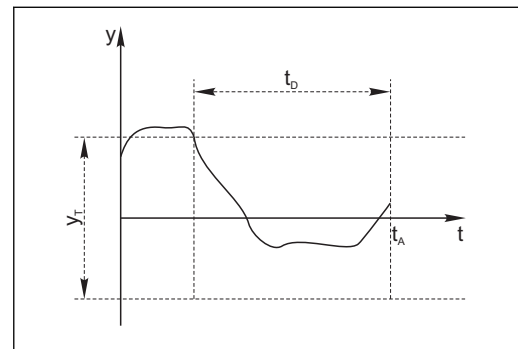

24 Stagnating signal, alarm is triggered

t_D Set value for **DURATION**
 t_A Time when the alarm is triggered

Main causes of stagnating measured values

- Contaminated sensor, or sensor outside of medium
- Sensor defective
- Process error (e.g. through control system)

Remedial action



1. Clean sensor.
2. Check positioning of sensor in medium.
3. Check electrode system.
4. Switch controller off and then switch it back on.

Menu/Setup/Inputs/Channel: Sensor type/Extended setup/Diagnostics settings/► Process Check System		
Function	Options	Info
Function	Selection <ul style="list-style-type: none"> ▪ Off ▪ On Factory setting Off	Switches the function on or off
Duration	1 to 240 min Factory setting 60 min	Enter the time after which the timer should time out. When this time expires, diagnostic message Calibration timer is displayed with code 102.
Tolerance width <i>Not for pH/ORP sensors</i>	The range depends on the sensor Factory setting Depends on the sensor	Interval around the measuring signal (raw value) for detecting stagnation. Measured values within the set interval are regarded as stagnating.

Limits operating hours

The total operating time of the sensor and its use under extreme conditions is monitored. If the operating time exceeds the defined threshold values, the device issues a corresponding diagnostics message.

-  Each sensor has a limited life expectancy which heavily depends on the operating conditions. If you specify warning limits for operating times under extreme conditions, you can guarantee the operation of your measuring point without any downtime by performing maintenance tasks in time.

Menu/Setup/Inputs/Channel: Nitrate/Extended setup/Diagnostics settings/► Limits operating hours		
Function	Options	Info
 The range of adjustment for the operating hours alarm and warning limits is generally 1 to 50000 h.		
Function	Selection <ul style="list-style-type: none"> ▪ Off ▪ On Factory setting On	On The operation of the sensor under extreme conditions is monitored, recorded in the sensor and diagnostics messages are displayed on the controller. Off No diagnostics messages. However, the time the sensor operates under extreme conditions is recorded in the sensor and can be read in the sensor information in the diagnostics menu.
► Operating time		Total operating time of the sensor
Warning limit	Factory setting 10000 h	Diagnostics code and associated message text: 199 Operating time
 The names of the following menu functions depend on the sensor specification. For this reason, they cannot be specified here.		
► Below specified temperature		
Warning limit	Factory setting 10000 h	Diagnostics code and associated message text: 935 Process temp. low
► Above specified temperature		
Warning limit	Factory setting 10000 h	Diagnostics code and associated message text: 934 Process temp. high
► Below specified limit value		
Warning limit	Factory setting 10000 h	Diagnostics code and associated message text: 943 Process value

Menu/Setup/Inputs/Channel: Nitrate/Extended setup/Diagnostics settings/► Limits operating hours		
Function	Options	Info
► Above specified limit value		
Warning limit	Factory setting 10000 h	Diagnostics code and associated message text: 942 Process value
► Filter change		
Warning limit	Factory setting 10000 h	Diagnostics code and associated message text: 157 Filter change
Alarm limit	Factory setting 15000 h	Diagnostics code and associated message text: 161 Filter change
► Flash counter, lamp		
Warning limit	Factory setting 126000000	Diagnostics code and associated message text: 171 Filter change
Alarm limit	Factory setting 131400000	Diagnostics code and associated message text: 771 Filter change

Diagnostic behavior

The list of diagnostic messages displayed depends on the path selected. There are device-specific messages, and messages that depend on what sensor is connected.

Menu/Setup/(General settings or Inputs<Sensor channel>)/Extended setup/Diagnostics settings/Diag. behavior		
Function	Options	Info
List of diagnostic messages		► Select the message to be changed. Only then can you make the settings for this message.
Diag. code	Read only	
Diagnostic message	Selection <ul style="list-style-type: none"> ▪ On ▪ Off Factory setting Depends on the message	You can deactivate or reactivate a diagnostic message here. Deactivating means: <ul style="list-style-type: none"> ▪ No error message in the measuring mode ▪ No error current at the current output
Error current	Selection <ul style="list-style-type: none"> ▪ On ▪ Off Factory setting Depends on the message	► Decide whether an error current should be output at the current output if the diagnostic message display is activated.  In the event of general device errors, the error current is output at all the current outputs. In the event of channel-specific errors, the error current is only output at the assigned current output.
Status signal	Selection <ul style="list-style-type: none"> ▪ Maintenance (M) ▪ Out of specification (S) ▪ Function check (C) ▪ Failure (F) Factory setting Depends on the message	The messages are divided into different error categories in accordance with NAMUR NE 107. ► Decide whether you want to change a status signal assignment for your application.

Menu/Setup/(General settings or Inputs<Sensor channel>)/Extended setup/Diagnostics settings/Diag. behavior		
Function	Options	Info
Diag. output	<p>Selection</p> <ul style="list-style-type: none"> ▪ None ▪ Alarm relay ▪ Binary output ▪ Relay 1 to n (depends on the device version) <p>Factory setting None</p>	<p>You can use this function to select an output to which the diagnostic message should be assigned.</p> <p>You can use this function to select a relay output and/or binary output to which the diagnostic message should be assigned.</p> <p>You can use this function to select a binary output to which the diagnostic message should be assigned.</p> <p>For sensors with the Memosens protocol: Before being able to assign the message to an output you must first configure a relay output to Diagnostics . (Menu/Setup/Outputs: Assign the Diagnostics function and set the Operating mode to as assigned .)</p>
<p> An alarm relay is always available, regardless of the device version. Other relays are optional.</p>		
Cleaning program (for sensors)	<p>Selection</p> <ul style="list-style-type: none"> ▪ None ▪ Cleaning 1 ▪ Cleaning 2 ▪ Cleaning 3 ▪ Cleaning 4 <p>Factory setting None</p>	<p>► Decide whether the diagnostic message should trigger a cleaning program.</p> <p>You can define the cleaning programs under: Menu/Setup/Additional functions/Cleaning.</p>
Detail information	Read only	Here you can find more information on the diagnostic message and instructions on how to resolve the problem.

12.2.6 Name check

With this function, you specify which sensors are accepted at your device.

Menu/Setup/Inputs/Channel: Sensor type/Extended setup/Diagnostics settings/► Tag control		
Function	Options	Info
Operating mode	<p>Selection</p> <ul style="list-style-type: none"> ▪ Off ▪ Tag ▪ Group <p>Factory setting Off</p>	<p>Off No name check, all sensors are accepted.</p> <p>Tag Only sensors with the same tag name are accepted.</p> <p>Group Only sensors in the same tag group are accepted.</p>
Tag	<p>Free text</p> <p>Factory setting</p> <ul style="list-style-type: none"> ▪ EH_CM44_ ▪ EH_CM44R_ ▪ EH_CSF48_ ▪ EH_CSP44_ 	<p>Enter the tag name.</p> <p>The controller checks every sensor to be connected as to whether this sensor belongs to the measuring point, and only accepts the sensors that have the same name.</p>
Group	<p>Numerical</p> <p>Factory setting 0</p>	

12.2.7 Sensor replacement

Menu/Setup/Inputs/Channel: Sensor type/Extended setup/Sensor change

- On
When the sensor is replaced, the last measured value is retained via the "hold" function.
A diagnostics message is not triggered.
- Off
When the sensor is replaced, the last measured value is not retained and triggers a diagnostics message.

12.2.8 Data processing factory setting

Here you can restore the factory settings for the sensor input.

Menu/Setup/Inputs/Channel: Sensor type/Extended setup

1. ▷ **Factory default measurement processing**
2. Respond to prompt: **OK** when the prompt for the device software appears.
 - ↳ Only the factory settings for this particular input are restored. All other settings remain unchanged.

12.2.9 Sensor factory setting

Here you can restore the sensor factory settings.

Menu/Setup/Inputs/Channel: Sensor type/Extended setup

1. ▷ **Factory default sensor**
2. Respond to prompt: **OK** when the prompt for the device software appears.
 - ↳ Only the factory settings for the sensor are restored. The settings for the input remain unchanged.

13 Inputs: ISE

13.1 Basic settings

13.1.1 Sensor identification

Menu/Setup/Inputs/Channel: sensor type		
Function	Options	Info
Channel	Selection <ul style="list-style-type: none"> ▪ Off ▪ On Factory setting On	On The channel display is switched on in the measuring mode Off The channel is not displayed in the measuring mode, regardless of whether a sensor is connected or not.
Sensor type	Read only (Only available if a sensor is connected)	Connected sensor type
Order code		Order code of the connected sensor

13.1.2 Main value

Menu/Setup/Inputs/Channel: ISE		
Function	Options	Info
Main value	Selection <ul style="list-style-type: none"> ▪ Ammonium ▪ Nitrate ▪ Potassium ▪ Chloride ▪ pH ▪ ORP Factory setting pH	Decide which parameter you want to display as the main value for the ISE channel. Here, you can only choose from the electrodes which you configured via the electrode slot menus. At the factory, this is equivalent to the types of electrode that are actually installed in the ISE sensor.

13.1.3 Damping of the temperature measured value

The damping causes a floating average curve of the measured values over the time specified.

Menu/Setup/Inputs/Channel: ISE		
Function	Options	Info
Damping temp.	0 to 600 s Factory setting 0 s	You specify the damping of the main measured value and that of the integrated temperature sensor.

13.1.4 Manual hold

Menu/Setup/Inputs/Channel: sensor type		
Function	Options	Info
Manual hold	Selection <ul style="list-style-type: none"> ▪ Off ▪ On Factory setting Off	On You can use this function to set the channel manually to "Hold". Off No channel-specific hold

13.2 Advanced setup

13.2.1 Temperature format

Menu/Setup/Inputs/Channel: ISE/► Extended setup		
Function	Options	Info
Temperature format	Selection <ul style="list-style-type: none"> ■ #.# ■ #.## Factory setting #.#	Specify the number of decimal places.

13.2.2 Cleaning hold

Menu/Setup/Inputs/Channel: Sensor type/► Extended setup		
Function	Options	Info
Cleaning hold	Selection <ul style="list-style-type: none"> ■ None ■ Cleaning 1 ... 4 Factory setting None	<ul style="list-style-type: none"> ► For selecting one or more cleaning programs (multiple selection). <ul style="list-style-type: none"> ↳ For the programs defined, the channel goes to "Hold" while cleaning is in progress. Cleaning programs are executed: <ul style="list-style-type: none"> ■ At a specified interval For this, the cleaning program must be started. ■ If a diagnostics message is pending on the channel and a cleaning has been specified for this message (→ Inputs/Channel: Sensor type/Diagnostics settings/Diag. behavior/Diagnostic number/Cleaning program).

 You define the cleaning programs in the **Setup/Additional functions/Cleaning**.

13.2.3 External hold

You can trigger a hold for all the devices of a measuring point via a digital signal, e.g. a fieldbus signal. Make sure that you do not use the hold signal elsewhere. You can assign an external hold individually to every sensor input.

 You will only find the function in the initial menu if you have configured the signals for the external hold in the general hold settings beforehand:

Menu/Setup/General settings/Hold settings/External hold.

Menu/Setup/Inputs/Channel: Sensor type/Extended setup/► External hold		
Function	Options	Info
Source	Selection <ul style="list-style-type: none"> ■ Binary inputs ■ Fieldbus signals Factory setting None	<ol style="list-style-type: none"> 1. For selecting the signal source of the external hold. <ul style="list-style-type: none"> ↳ Multiple selection is possible. 2. OK: confirms selection.

13.2.4 Diagnostics settings

This menu branch is used for specifying warning limits, and for defining whether and how diagnostics tools should be used.

The associated diagnostics code is displayed for every setting.

Limits operating hours



The total operating time of the sensor and its use under extreme conditions is monitored. If the operating time exceeds the defined threshold values, the device issues a corresponding diagnostics message.

 Each sensor has a limited life expectancy which heavily depends on the operating conditions. If you specify warning limits for operating times under extreme conditions, you can guarantee the operation of your measuring point without any downtime by performing maintenance tasks in time.

Menu/Setup/Inputs/Channel: ISE/Extended setup/Diagnostics settings/► Limits operating hours		
Function	Options	Info
 The range of adjustment for the operating hours alarm and warning limits is generally 1 to 50000 h.		
Function	Selection <ul style="list-style-type: none"> ▪ Off ▪ On Factory setting On	On The operation of the sensor under extreme conditions is monitored, recorded in the sensor and diagnostics messages are displayed on the controller. Off No diagnostics messages. However, the time the sensor operates under extreme conditions is recorded in the sensor and can be read in the sensor information in the diagnostics menu.
► Operating time		Total operating time of the sensor
Warning limit	Factory setting 10000 h	Diagnostics code and associated message text: 199 Operating time
► Operation > 30 °C		
Warning limit	Factory setting 10000 h	Diagnostics code and associated message text: 191 Operating time
► Operation > 40 °C		
Warning limit	Factory setting 10000 h	Diagnostics code and associated message text: 192 Operating time

Diagnostic behavior

The list of diagnostic messages displayed depends on the path selected. There are device-specific messages, and messages that depend on what sensor is connected.

Menu/Setup/(General settings or Inputs<Sensor channel>)/Extended setup/Diagnostics settings/Diag. behavior		
Function	Options	Info
List of diagnostic messages		► Select the message to be changed. Only then can you make the settings for this message.
Diag. code	Read only	
Diagnostic message	Selection <ul style="list-style-type: none"> ▪ On ▪ Off Factory setting Depends on the message	You can deactivate or reactivate a diagnostic message here. Deactivating means: <ul style="list-style-type: none"> ▪ No error message in the measuring mode ▪ No error current at the current output
Error current	Selection <ul style="list-style-type: none"> ▪ On ▪ Off Factory setting Depends on the message	► Decide whether an error current should be output at the current output if the diagnostic message display is activated.  In the event of general device errors, the error current is output at all the current outputs. In the event of channel-specific errors, the error current is only output at the assigned current output.
Status signal	Selection <ul style="list-style-type: none"> ▪ Maintenance (M) ▪ Out of specification (S) ▪ Function check (C) ▪ Failure (F) Factory setting Depends on the message	The messages are divided into different error categories in accordance with NAMUR NE 107. ► Decide whether you want to change a status signal assignment for your application.
Diag. output	Selection <ul style="list-style-type: none"> ▪ None ▪ Alarm relay ▪ Binary output ▪ Relay 1 to n (depends on the device version) Factory setting None	You can use this function to select an output to which the diagnostic message should be assigned. You can use this function to select a relay output and/or binary output to which the diagnostic message should be assigned. You can use this function to select a binary output to which the diagnostic message should be assigned. For sensors with the Memosens protocol: Before being able to assign the message to an output you must first configure a relay output to Diagnostics . (Menu/Setup/Outputs: Assign the Diagnostics function and set the Operating mode to as assigned.)
 An alarm relay is always available, regardless of the device version. Other relays are optional.		
Cleaning program (for sensors)	Selection <ul style="list-style-type: none"> ▪ None ▪ Cleaning 1 ▪ Cleaning 2 ▪ Cleaning 3 ▪ Cleaning 4 Factory setting None	► Decide whether the diagnostic message should trigger a cleaning program. You can define the cleaning programs under: Menu/Setup/Additional functions/Cleaning.
Detail information	Read only	Here you can find more information on the diagnostic message and instructions on how to resolve the problem.

13.2.5 Name check

With this function, you specify which sensors are accepted at your device.

Menu/Setup/Inputs/Channel: Sensor type/Extended setup/Diagnostics settings/► Tag control		
Function	Options	Info
Operating mode	Selection <ul style="list-style-type: none"> ▪ Off ▪ Tag ▪ Group Factory setting Off	Off No name check, all sensors are accepted. Tag Only sensors with the same tag name are accepted. Group Only sensors in the same tag group are accepted.
Tag	Free text Factory setting <ul style="list-style-type: none"> ▪ EH_CM44_ ▪ EH_CM44R_ ▪ EH_CSF48_ ▪ EH_CSP44_ 	Enter the tag name. The controller checks every sensor to be connected as to whether this sensor belongs to the measuring point, and only accepts the sensors that have the same name.
Group	Numerical Factory setting 0	

13.2.6 Sensor replacement

Menu/Setup/Inputs/Channel: Sensor type/Extended setup/Sensor change

- On
When the sensor is replaced, the last measured value is retained via the "hold" function. A diagnostics message is not triggered.
- Off
When the sensor is replaced, the last measured value is not retained and triggers a diagnostics message.

13.2.7 Data processing factory setting

Here you can restore the factory settings for the sensor input.

Menu/Setup/Inputs/Channel: Sensor type/Extended setup

1. ► **Factory default measurement processing**
2. Respond to prompt: **OK** when the prompt for the device software appears.
 - ↳ Only the factory settings for this particular input are restored. All other settings remain unchanged.

13.3 Electrode slot menus

13.3.1 Electrode slot and measured variable

A CAS40D sensor has 4 electrode slots in total. Consequently, each of these slots has its own menu.

Making the settings

1. Define the parameters for the slot (slots 2-4 only). The 1st slot is always designated to the pH electrode. It is not possible to select another parameter for this slot.
2. You can populate and assign the other three slots as you wish.

3. Slots 2 to 4 only:

Specify the measured variable that should be output.

Selection Measured variable depending on the parameter

pH and ORP	Ammonium	Nitrate	Potassium	Chloride
No options	NH ₄ -N NH ₄	NO ₃ -N NO ₃	K	Cl



You can also configure a user-defined measured variable (**Measured variable = user defined**). The following values must then be specified for calculation purposes:

- **Electrode name**
Customized text. Enter a name. This is displayed under **Electrode slot** afterwards.
- **Measured variable**
Customized text
- **Valency**
Specify the ion charge including the sign.
- **Molar mass**
Specify the molar mass of the measured variable.

Selecting the pH reference electrode**4. Reference electrode:** Specify the pH electrode version, **Standard** or **Salt ring**.

The pH electrode version can be found only on its nameplate (CPS11-1AS*** = **Salt ring**, CPS11-1AT*** = **Standard**).

NOTICE**Incorrect assignment between the electrode (hardware) and the software menu**

Unreliable measured values and faults in the measuring point can occur!

- ▶ When assigning the slot in the software, make sure it matches the assignment in the sensor.
- ▶ Example: You have connected the ammonium electrode to cable no. 2 in the sensor. Then configure the ammonium parameter in the software menu for slot 2.

13.3.2 Damping

The damping causes a floating average curve of the measured values over the time specified.

Menu/Setup/Inputs/Channel: ISE/Electrode slot		
Function	Options	Info
Damping	0 to 600 s Factory setting 0 s	Specify the damping of the main value of the electrode assigned to the slot.

13.3.3 Compensation

Depending on the selectivity of the ion-selective electrode vis-à-vis other ions (interference ions), and the concentration of these ions, such ions could also be interpreted as part of the measuring signal and thus cause measuring errors.

When measuring in wastewater, the potassium ion which is chemically similar to the ammonium ion can cause higher measured values.

High concentrations of chloride may result in the measured values for nitrate being too high. To reduce measuring errors resulting from such cross-interference, the concentration

of the potassium or chloride interference ion can be measured and compensated for with a suitable additional electrode.

 For the pH, chloride and the potassium electrode, you can only configure an offset. The settings for compensation of the effect of interference ions are available only for ammonium and nitrate.

Menu/Setup/Inputs/Channel: ISE/Electrode slot/► Compensation		
Function	Options	Info
Compensation	Selection <ul style="list-style-type: none"> ■ Off ■ On Factory setting Off	If you want to use the compensation function, you must have installed a compensation electrode (potassium or chloride) in another electrode slot and have configured it in the software.
Offset	-14.00 to 14.00 pH -100 to 100 mg/l Factory setting 0.00 pH 0.00 mg/l	The offset compensates for a difference between a laboratory measurement and an online measurement which is caused by interference ions. Enter this value manually. If you are using a compensation electrode, keep the offset at zero.
Compensation type	Selection <ul style="list-style-type: none"> ■ Chloride ■ pH ■ Potassium ■ pH and potassium Factory setting Chloride Potassium	The options depend on the parameter to be compensated. You compensate for chloride when using a nitrate electrode, and you can compensate for potassium and pH when using the ammonium electrode. The factory setting depends on the electrode used.
Comp. electrode	Choice of slot	If you have installed and configured several compensation electrodes of the same type in the CAS40D sensor, you must use this function to define which electrode is used for compensation. Generally, you have a potassium or chloride electrode and the Liquiline recognizes the right slot.
Selectivity coefficient	-10.00 to 10.00 Factory setting -2.00 (chloride) -0.85 (potassium)	The coefficients are empirical values.
Mode	Selection <ul style="list-style-type: none"> ■ + ■ - Factory setting -	The standard setting (-) corrects a measured value that is too high as a result of the effect of interference ions.

13.3.4 Advanced setup

Format of main measured value and membrane timer

Menu/Setup/Inputs/Channel: ISE/Electrode slot/► Extended setup		
Function	Options	Info
Main value format	Selection <ul style="list-style-type: none"> ■ #.# ■ #.## Factory setting #.#	Specify the number of decimal places.
Membrane timer	Selection <ul style="list-style-type: none"> ■ Off ■ On Factory setting Off	
Membrane timer value	0 to 80 weeks Factory setting 26 weeks	

Calibration settings

Stability criteria

Menu/Setup/Inputs/Channel: ISE/Electrode slot/► Extended setup		
Function	Options	Info
Stability criteria	Selection <ul style="list-style-type: none"> ■ Off ■ Weak ■ Medium ■ Hard Factory setting Medium	In normal situations leave the stability criteria set to Medium .

Calibration timer

You can specify the calibration interval for the sensor here. Once the time configured elapses, the **Calibration timer** diagnostics message appears on the display.



The timer is reset automatically if you recalibrate the sensor.

Menu/Setup/Inputs/Channel: ISE/Electrode slot/► Extended setup/► Calib. settings		
Function	Options	Info
Calibration timer	Selection <ul style="list-style-type: none"> ■ Off ■ On Factory setting Off	Switches the function on or off
Calibration timer value	1 to 10000 h Factory setting 2500 h	Specify the time after which the timer should have timed out. When this time elapses, diagnostics message Calibration timer is displayed with code 102.

Buffer recognition (only pH)

Automatic buffer recognition

To ensure a buffer is detected correctly, the measuring signal may deviate by a maximum of 30 mV from the value stored in the buffer table. This is approx. 0.5 pH at a temperature of 25°C.

If both buffers - 9.00 and 9.20 - were used, this would cause the signal intervals to overlap and buffer recognition would not work. For this reason, the device would recognize a buffer with a pH of 9.00 as a pH of 9.20.

→ Do not use the buffer with a pH of 9.00 for automatic buffer recognition.

Menu/Setup/Inputs/Channel: pH or ORP or pH/ORP or (ISE/Electrode slot)/Extended setup/► Calib. settings		
Function	Options	Info
Buffer recognition	Selection <ul style="list-style-type: none"> ■ Fixed ■ Automatic ¹⁾ ■ Manual Factory setting Fixed	Fixed You choose values from a list. This list depends on the setting for Buffer manufacturer . Automatic The device recognizes the buffer automatically. The recognition depends on the setting for Buffer manufacturer .  As their zero point is offset, enamel pH sensors and CPS4xx ISFET sensors cannot be calibrated and adjusted with automatic buffer recognition. Manual You enter any two buffer values. These must differ in terms of their pH value.
Buffer manufacturer	Selection <ul style="list-style-type: none"> ■ Endress+Hauser ■ Ingold/Mettler ■ DIN 19266 ■ DIN 19267 ■ Merck/Riedel ■ Hamilton ■ Special buffer Factory setting Endress+Hauser	Temperature tables are stored internally in the unit for the following pH values: <ul style="list-style-type: none"> ■ Endress+Hauser 2.00 / 4.00 / 7.00 / (9.00) / 9.22 / 10.00 / 12.00 ■ Ingold/Mettler 2.00 / 4.01 / 7.00 / 9.21 ■ DIN 19266 1.68 / 4.01 / 6.86 / 9.18 ■ DIN 19267 1.09 / 4.65 / 6.79 / 9.23 / 12.75 ■ Merck/Riedel 2.00 / 4.01 / 6.98 / 8.95 / 12.00 ■ Hamilton 1.09 / 1.68 / 2.00 / 3.06 / 4.01 / 5.00 / 6.00 / 7.00 / 8.00 / 9.21 / 10.01 / 11.00 / 12.00  With the Special buffer option, you have the possibility of defining two buffers of your own. For this purpose, two tables are displayed in which you can enter value pH value/temperature value pairs.
Calibration buffer 1 ... 2 Buffer recognition = Fixed or Manual	The possible options and the factory setting depend on the Buffer manufacturer	
1 point adjustment	Selection <ul style="list-style-type: none"> ■ Transmitter ■ Sensor Factory setting Transmitter	Function not in the ISE menu Choose whether the offset should be saved in the transmitter or in the sensor.

1) Only pH sensor or pH/ORP combined sensor

Standard addition (all except for pH)

Different types of calibration are available to calibrate an ion-selective electrode. Initial settings only have to be made for the standard addition method.

Menu/Setup/Inputs/Channel: ISE/Electrode slot/► Standard addition		
Function	Options	Info
Sampling volume	0.00 to 5000.00 ml Factory setting 1000.00 ml	Here, specify the sample volume which you use during the calibration.
Standard volume	0.00 to 100.00 ml Factory setting 1.00 ml	Volume of the added standard solution per addition step
Standard concentration	0.00 to 10.00 mol/l Factory setting 1.00 mol/l	Concentration of the standard solution
No. of additions	1 to 4 Factory setting 3	Number of addition steps (=measuring points of the calibration function)

Diagnostic settings

Process check system

The process check system (PCS) checks the measuring signal for stagnation. An alarm is triggered if the measuring signal does not change over a specific period (several measured values).

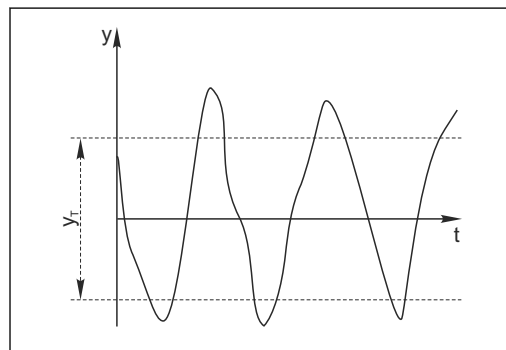

A0027276

25 Normal measuring signal, no alarm

y Measuring signal
 y_T Set value for **Tolerance width**

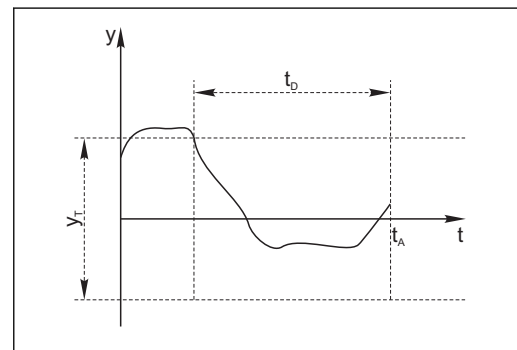

A0028842

26 Stagnating signal, alarm is triggered

t_D Set value for **Duration**
 t_A Time when the alarm is triggered

Main causes of stagnating measured values

- Contaminated sensor, or sensor outside of medium
- Sensor defective
- Process error (e.g. through control system)

Remedial action

1. Clean sensor.
2. Check positioning of sensor in medium.
3. Check electrode system.
4. Switch controller off and then switch it back on.

Menu/Setup/Inputs/Channel: Sensor type/Extended setup/Diagnostics settings/► Process Check System		
Function	Options	Info
Function	Selection <ul style="list-style-type: none"> ▪ Off ▪ On Factory setting Off	Switches the function on or off
Duration	1 to 240 min Factory setting 60 min	Enter the time after which the timer should time out. When this time expires, diagnostic message Calibration timer is displayed with code 102.
Tolerance width <i>Not for pH/ORP sensors</i>	The range depends on the sensor Factory setting Depends on the sensor	Interval around the measuring signal (raw value) for detecting stagnation. Measured values within the set interval are regarded as stagnating.

14 Inputs: Interface

14.1 Basic settings

14.1.1 Sensor identification

The CUS71D sensor is not detected automatically. It must be selected manually (**Current sensor**). During initial commissioning, data are recorded and calculated for 3 to 5 minutes before a measured value is displayed.

Menu/Setup/Inputs/Channel: Ultrasonic interface		
Function	Options	Info
Sensor operation	Selection <ul style="list-style-type: none"> ▪ Scan for memosens sensor ▪ Current sensor Factory setting Current sensor	Scan for memosens sensor Searches for Memosens sensors Current sensor Connected sensor is used
Wiper function	Selection <ul style="list-style-type: none"> ▪ Off ▪ On Factory setting On	Only for sensor version with wiper function
Wiper timing	1 to 240 min Factory setting 10 min	Only for sensor version with wiper function

14.1.2 Manual hold

Menu/Setup/Inputs/Channel: sensor type		
Function	Options	Info
Manual hold	Selection <ul style="list-style-type: none"> ▪ Off ▪ On Factory setting Off	On You can use this function to set the channel manually to "Hold". Off No channel-specific hold

14.2 Tank configuration

The mounting location is defined by the tank depth and the sensor zero point. The accuracy of the measurement results depends on the accuracy of these settings.

 Since the data in the sensor are overwritten with each change, data input might be delayed.

Menu/Setup/Inputs/Channel: Ultrasonic interface/► Tank configuration		
Function	Options	Info
Blanket definition	Selection <ul style="list-style-type: none"> ▪ Interface level ▪ Interface range Factory setting Interface level	Type of measurement that should be displayed and calculated Interface level Distance from the tank floor to the interface, measuring direction from bottom to top Interface range Distance from the water line to the interface, measuring direction from top to bottom
		<p>A0029403</p> <ol style="list-style-type: none"> 1 Reference point, e.g. water line 2 Clear water 3 Transmitted and reflected ultrasonic waves 4 Solids/clear water separation zone 5 Deposited sludge 6 Ultrasonic transmitter and receiver 7 Interface range 8 Interface level <p>i Tank depth and Zero adjust have the same reference point.</p>
Unit of measure	Selection <ul style="list-style-type: none"> ▪ m ▪ cm ▪ ft ▪ inch Factory setting m	Any change to the unit is automatically accepted in all the displays.
Tank depth	0.4 to 10.0 m (1.4 to 32.8 ft) Factory setting 8.0 m (26.2 ft)	Distance from the water level to the tank floor
Zero adjust	0.0 to 10.0 m (0.0 to 32.8 ft) Factory setting 0.4 m (1.3 ft)	Distance from the water level to the sensor diaphragm
Blanking zone	Selection <ul style="list-style-type: none"> ▪ Off ▪ On Factory setting Off	Permanent echo signals above and below a search window are masked out as interference signals.

Menu/Setup/Inputs/Channel: Ultrasonic interface/► Tank configuration		
Function	Options	Info
Upper window limit	0.0 m ... Lower window limit (1.4 ft ...) Factory setting 0.3 m (1.0 ft)	Distance to the water line below which the system should search for an interface. Permanent echo signals above this value are masked out as interference signals.
Lower window limit	Upper window limit to 11.0 m (to 32.8 ft) Factory setting 3.3 m (10.8 ft)	Distance to the water line Permanent echo signals below this value are masked out as interference signals.

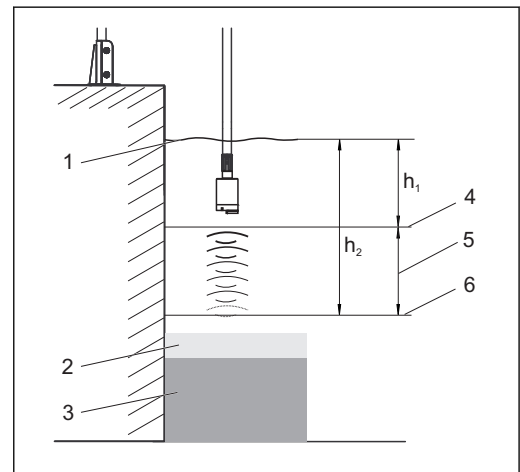
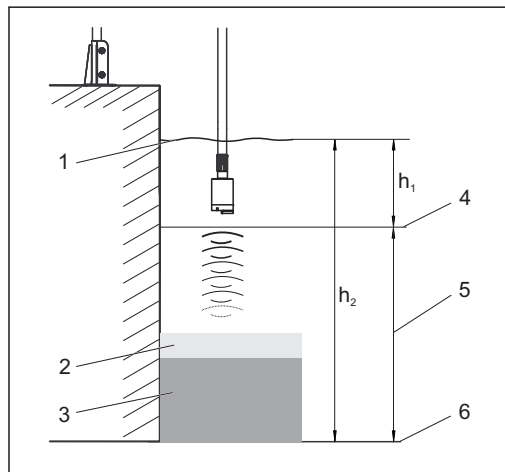

27 Detection limit on tank floor
 1 Reference point, for example water line
 2 Solids/clear water separation zone
 3 Deposited sludge

28 Detection limit above tank floor
 4 Upper window limit
 5 Measuring range
 6 Lower window limit

If the lower detection limit is above the tank floor, all signals below this value are hidden and no separation zone is displayed.

14.3 Sensor signal

Change the factory settings in this menu if you discover incorrect measurements.

Menu/Setup/Inputs/Channel: Ultrasonic interface/► Sensor signal		
Function	Options	Info
Acoustic control	Selection <ul style="list-style-type: none"> ■ Manual ■ Automatic Factory setting Automatic	Controls the graphic display of the echo signal Manual You can enter a fixed gain value for diagnostics or test purposes. Automatic The transmitter uses the gain value determined in the self-test (initialization). In the measuring mode, this value is automatically adapted to the current process conditions.
Current gain	0 to 100 Factory setting 30	You can only configure the value with manual acoustic control. The value is read-only for automatic acoustic control.
<p>i Common gain values for applications involving relatively clear water and a "hard" interface are between 25 and 35. The values can be as high as 60 if the sludge/water transition is relatively "soft". If you require significantly higher gain values, this is an indication of overranging. It is then difficult or impossible to reliably evaluate the echo signal.</p>		

Menu/Setup/Inputs/Channel: Ultrasonic interface/► Sensor signal		
Function	Options	Info
Gain control set point Acoustic control = Automatic	1 to 50 Factory setting 20	Horizontal position of the intersection of the interface line with the echo peak. The factory setting "20" corresponds to 20 % of the maximum display height.
Refresh rate	Selection <ul style="list-style-type: none"> ■ 2 s ■ 4 s ■ 6 s ■ 8 s Factory setting 4 s	Time frame for data refresh
Damping	5 to 255 Factory setting 130	Number of averaged values until data refresh Select a low damping value if the height of the interface can change very quickly. Higher damping prevents the system from tracking echo signals that occur briefly (e.g. caused by material movement, a rake or a floor scraper).

14.4 Advanced setup

14.4.1 Sensor signal

You can adapt the sensor signal to the measuring point in this menu.

Menu/Setup/Inputs/Channel: Ultrasonic interface/Extended setup/► Sensor signal		
Function	Options	Info
Speed of sound	300 to 2000 m/s (985 to 6561 ft/s) Factory setting 1482 m/s (4862 ft/s)	The sound speed depends on the medium temperature and the medium density. Since the temperature and density only fluctuate slightly in most water and wastewater applications, the factory setting of 1482 m/s has proven to be a suitable value.
 Always consult with the manufacturer service department before changing the setting for the Speed of sound .		
► Sedimentation area		
Gain band	5 to 30 Factory setting 20	Restricts the gain in automatic mode in order to prevent system overload.
Gain increment	0.1 to 0.5 Factory setting 0.1	Defines how quickly the gain can adapt to changing process conditions in the automatic mode.
Bottom definition		
Range above bottom	0.0 to 1.0 m (0.0 to 3.2 ft) Factory setting 0.1 m(0.3 ft)	Zone around the tank bottom in which extraneous signals can occur. Signals above your setting are masked out. This is needed for very low sludge levels or tanks free from sludge.
Bottom signal set point	0 to 100 Factory setting 60	Restricts the gain in automatic mode in order to prevent system overload when the tank is empty or does not have an interface.

14.4.2 Calculation

You can adapt the sensor signal to the measuring point in this menu.

Menu/Setup/Inputs/Channel: Ultrasonic interface/Extended setup/► Calculation		
Function	Options	Info
Interface	Selection <ul style="list-style-type: none"> ■ Top layer ■ Lower interface Factory setting Top layer	Defines which signal the system should track and display when several interfaces are calculated. Top layer Determine the interface of thin material in the upper section Lower interface Determine the interface of thicker material near the floor
Interface window	Selection <ul style="list-style-type: none"> ■ Off ■ On Factory setting On	You can open another window near the interface. Specify a distance above and below the interface. The system primarily focuses on the signal within this window. Any signal outside this window must meet the search criteria for an interface for an extended period before the system recognizes it as an interface.
Above interface Interface window = On	0.0 to 10.0 m (0.0 to 32.8 ft)	The search window is indicated by broken lines in the graphic mode. The search window is 1.2 m wide in the factory setting for both parameters.
Below interface Interface window = On	Factory setting 0.6 m (2.0 ft)	
Gate response rate	0 to 50 Factory setting 1	The response rate determines the speed at which the system updates the measuring window. A high value stands for a quick change.
Threshold	0 to 100 Factory setting 0	Filter for examining signals If a high value is selected, stronger signals are taken into account more. If a low value is selected, weaker signals are taken into account more.

14.4.3 Diagnostics settings

This menu branch is used for specifying warning limits, and for defining whether and how diagnostics tools should be used.



The associated diagnostics code is displayed for every setting.

Alarm delay echo loss

Menu/Setup/Inputs/Channel: Ultrasonic interface/Extended setup/ Diagnostics settings		
Function	Options	Info
Alarm delay echo loss	0 to 255 min Factory setting 10 min	Delay time for an error message if the echo is lost

Diagnostic behavior

The list of diagnostic messages displayed depends on the path selected. There are device-specific messages, and messages that depend on what sensor is connected.

Menu/Setup/(General settings or Inputs<Sensor channel>)/Extended setup/Diagnostics settings/Diag. behavior		
Function	Options	Info
List of diagnostic messages		▶ Select the message to be changed. Only then can you make the settings for this message.
Diag. code	Read only	
Diagnostic message	Selection <ul style="list-style-type: none"> ▪ On ▪ Off Factory setting Depends on the message	You can deactivate or reactivate a diagnostic message here. Deactivating means: <ul style="list-style-type: none"> ▪ No error message in the measuring mode ▪ No error current at the current output
Error current	Selection <ul style="list-style-type: none"> ▪ On ▪ Off Factory setting Depends on the message	▶ Decide whether an error current should be output at the current output if the diagnostic message display is activated.  In the event of general device errors, the error current is output at all the current outputs. In the event of channel-specific errors, the error current is only output at the assigned current output.
Status signal	Selection <ul style="list-style-type: none"> ▪ Maintenance (M) ▪ Out of specification (S) ▪ Function check (C) ▪ Failure (F) Factory setting Depends on the message	The messages are divided into different error categories in accordance with NAMUR NE 107. ▶ Decide whether you want to change a status signal assignment for your application.
Diag. output	Selection <ul style="list-style-type: none"> ▪ None ▪ Alarm relay ▪ Binary output ▪ Relay 1 to n (depends on the device version) Factory setting None	You can use this function to select an output to which the diagnostic message should be assigned. You can use this function to select a relay output and/or binary output to which the diagnostic message should be assigned. You can use this function to select a binary output to which the diagnostic message should be assigned. For sensors with the Memosens protocol: Before being able to assign the message to an output you must first configure a relay output to Diagnostics . (Menu/Setup/Outputs: Assign the Diagnostics function and set the Operating mode to as assigned .)
 An alarm relay is always available, regardless of the device version. Other relays are optional.		
Cleaning program (for sensors)	Selection <ul style="list-style-type: none"> ▪ None ▪ Cleaning 1 ▪ Cleaning 2 ▪ Cleaning 3 ▪ Cleaning 4 Factory setting None	▶ Decide whether the diagnostic message should trigger a cleaning program. You can define the cleaning programs under: Menu/Setup/Additional functions/Cleaning .
Detail information	Read only	Here you can find more information on the diagnostic message and instructions on how to resolve the problem.

14.4.4 Restart the sensor signal

Restart sensor signal

The sensor is reinitialized with this action. The sensor starts in the automatic mode and searches for the interface with the last sensor settings. The first measured value appears after around 3 to 5 minutes.

14.4.5 Sensor replacement

Menu/Setup/Inputs/Channel: Sensor type/Extended setup/Sensor change

- On
When the sensor is replaced, the last measured value is retained via the "hold" function. A diagnostics message is not triggered.
- Off
When the sensor is replaced, the last measured value is not retained and triggers a diagnostics message.

14.4.6 Data processing factory setting

Here you can restore the factory settings for the sensor input.

Menu/Setup/Inputs/Channel: Sensor type/Extended setup

1. ▷ Factory default measurement processing
2. Respond to prompt: **OK** when the prompt for the device software appears.
 - ↳ Only the factory settings for this particular input are restored. All other settings remain unchanged.

14.4.7 Sensor factory setting

Here you can restore the sensor factory settings.

Menu/Setup/Inputs/Channel: Sensor type/Extended setup

1. ▷ Factory default sensor
2. Respond to prompt: **OK** when the prompt for the device software appears.
 - ↳ Only the factory settings for the sensor are restored. The settings for the input remain unchanged.

14.4.8 External hold

You can trigger a hold for all the devices of a measuring point via a digital signal, e.g. a fieldbus signal. Make sure that you do not use the hold signal elsewhere. You can assign an external hold individually to every sensor input.

 You will only find the function in the initial menu if you have configured the signals for the external hold in the general hold settings beforehand:

Menu/Setup/General settings/Hold settings/External hold.

Menu/Setup/Inputs/Channel: Sensor type/Extended setup/▶ External hold		
Function	Options	Info
Source	Selection <ul style="list-style-type: none"> ■ Binary inputs ■ Fieldbus signals Factory setting None	<ol style="list-style-type: none"> 1. For selecting the signal source of the external hold. <ul style="list-style-type: none"> ↳ Multiple selection is possible. 2. OK: confirms selection.

15 Diagnostics and troubleshooting

15.1 Process errors without messages

15.1.1 pH/ORP measurement

Problem	Possible cause	Tests and/or remedial measures
Display deviates from reference measurement	Incorrect calibration	Repeat calibration Where necessary, check the calibration with the reference device and repeat.
	Sensor fouled	Clean sensor
	Temperature measurement	Check the temperature measured values of both devices
	Temperature compensation	Check the settings for temperature compensation and adjustment for both devices
Measuring chain zero-point cannot be adjusted	Contaminated reference system	Test with a new sensor
	Membrane clogged	Clean or grind membrane
	Asymmetric sensor voltage too high	Clean junction or test with another sensor
No or slow change of readings	<ul style="list-style-type: none"> ▪ Sensor fouled ▪ Sensor old ▪ Sensor defective (reference lead) 	Clean sensor
	Reference has low level of KCl	Check KCl supply: 0.8 bar (12 psi) over medium pressure
Measuring chain slope: <ul style="list-style-type: none"> ▪ Cannot be adjusted ▪ Too low ▪ No slope 	Device input defective	Check device directly
	<ul style="list-style-type: none"> ▪ Sensor old ▪ Hair-line crack in the glass membrane 	Replace sensor
Constant, incorrect measured value	Sensor does not immerse properly or protection cap not removed	Check installation position, remove protection cap
	Air pockets in assembly	Check assembly and installation position
	Grounding short at or in device	Perform test measurement in insulated vessel, with buffer solution if applicable
	Hair-line crack in the glass membrane	Replace sensor
	Device in impermissible operating condition (does not respond when key pressed)	Switch off device and switch it on again
Incorrect temperature value	Sensor defective	Change sensor
Fluctuations in measured value	Interference on signal output cable	Check cable routing, possibly route cable separately
	Interference potential in medium	Eliminate source of interference or ground medium as close as possible to sensor.
No current output signal	Cable disconnected or short-circuited	Disconnect cable and measure directly at device
	Output defective	See "Device-specific errors" in the Operating Instructions of the transmitter, sampler, analyzer
Fixed current output signal	Current simulation active	Switch off simulation.

Problem	Possible cause	Tests and/or remedial measures
Incorrect current output signal	Total load in current loop too high	Measure the load and reduce it to the permitted value if necessary (see "Technical data" in the Operating Instructions of the transmitter, sampler, analyzer).
	EMC (interference coupling)	Check the wiring, identify and eliminate cause of interference

15.1.2 Conductivity measurement

Problem	Possible cause	Tests and/or remedial measures
Display deviates from reference measurement	Incorrect calibration	Repeat calibration Where necessary, check the calibration with the reference device and repeat.
	Sensor fouled	Clean sensor
	Temperature measurement	Check the temperature measured values of both devices
	Temperature compensation	Check the settings for temperature compensation and adjustment for both devices
	Polarization errors	Use suitable sensor <ul style="list-style-type: none"> ▪ Larger cell constant ▪ Graphite instead of stainless steel (observe material resistance properties)
Implausible measured values: <ul style="list-style-type: none"> ▪ Measured value constantly 000 ▪ Measured value too low ▪ Measured value too high ▪ Measured value frozen ▪ Current output value not as expected 	Short-circuit/moisture in sensor	Check sensor
	Short-circuit in cable or socket	Check cable and socket
	Disconnection in sensor	Check sensor
	Disconnection in cable or socket	Check cable and socket
	Incorrect cell constant setting	Check cell constant
	Incorrect output assignment	Check assignment of measured value to current signal
	Air pockets in assembly	Check assembly and installation position
	Grounding short at or in device	Measure in insulated vessel
	Device in impermissible operating condition (does not respond when key pressed)	Switch off device and switch it on again
Incorrect temperature value	Sensor defective	Change sensor
Measured value in process incorrect	No/incorrect temperature compensation	ATC: select type of compensation; if linear, set suitable coefficients MTC: set process temperature
	Incorrect temperature measurement	Check temperature measured value
	Bubbles in medium	Suppress formation of bubbles by: <ul style="list-style-type: none"> ▪ Gas bubble trap ▪ Creating counterpressure (orifice plate) ▪ Measurement in bypass
	Flow rate too high (can lead to bubble formation)	Reduce flow rate or select less turbulent mounting location
	Voltage potential in medium (only for conductive)	Ground medium close to sensor
	Sensor fouling or buildup on sensor	Clean sensor

Problem	Possible cause	Tests and/or remedial measures
Fluctuations in measured value	Interference on signal output cable	Check cable routing, possibly route cable separately
	Interference potential in medium	Eliminate source of interference or ground medium as close as possible to sensor.
	Interference on measuring cable	Connect cable shield as per wiring diagram
No current output signal	Cable disconnected or short-circuited	Disconnect cable and measure directly at device
	Output defective	See "Device-specific errors" in the Operating Instructions of the transmitter, sampler, analyzer
Fixed current output signal	Current simulation active	Switch off simulation.
Incorrect current output signal	Total load in current loop too high	Measure the load and reduce it to the permitted value if necessary (see "Technical data" in the Operating Instructions of the transmitter, sampler, analyzer).
	EMC (interference coupling)	Check the wiring, identify and eliminate cause of interference

15.1.3 Oxygen measurement

Problem	Possible cause	Tests and/or remedial measures
Display value - - - -	Sensor defective	Test with a new sensor
	Sensor cable disconnected	Check the cable or cable extension
	Incorrect sensor connection	Check the connection at the input module (→ 7)
	Electronics module defective	Replace module
No or slow change of readings	<ul style="list-style-type: none"> ▪ Sensor fouled ▪ Sensor old 	Clean sensor If necessary, replace the electrolyte, membrane cap (amperometric sensor) or fluorescence cap (optical sensor)
Constant, incorrect measured value	Device in impermissible operating condition (does not respond when key pressed)	Switch off device and switch it on again
Measured value too low	Membrane soiled	Clean the sensor or replace the cap
	Electrolyte used up or contaminated	Replacing electrolyte
	Anode coating worn	Repolarize sensor
	Black anode coating	Regenerate sensor in factory
Measured value too high	Air pocket under membrane	Clean the sensor, optimize the installation if necessary
	Polarization not complete	Wait for polarization time to finish (→ Techn. data the Operating Instructions of the sensor)
Implausible measured value	Incorrect temperature measurement	Check/correct value
	Incorrect altitude setting	Incorrect calibration Reconfigure and repeat calibration
	Incorrect air pressure	
Incorrect temperature value	Sensor defective	Change sensor
	Incorrect sensor connection	Check input module (→ 7)

Problem	Possible cause	Tests and/or remedial measures
Fluctuations in measured value	Interference on signal output cable	Check cable routing, possibly route cable separately
	Interference potential in medium	Eliminate source of interference or ground medium as close as possible to sensor.
	Interference on measuring cable	Connect cable shield as per wiring diagram
No current output signal	Cable disconnected or short-circuited	Disconnect cable and measure directly at device
	Output defective	See "Device-specific errors" in the Operating Instructions of the transmitter, sampler, analyzer
Fixed current output signal	Current simulation active	Switch off simulation.
Incorrect current output signal	Total load in current loop too high	Measure the load and reduce it to the permitted value if necessary (see "Technical data" in the Operating Instructions of the transmitter, sampler, analyzer).
	EMC (interference coupling)	Check the wiring, identify and eliminate cause of interference

15.1.4 Chlorine measurement

Problem	Possible cause	Tests and/or remedial measures
Display value - - - -	Sensor defective	Test with a new sensor
	Sensor cable disconnected	Check the cable or cable extension
	Incorrect sensor connection	Check the connection at the input module (→ 7)
	Electronics module defective	Replace module
Slope too low	Sensor was in chlorine-free water or in air	Short conditioning over (not in!) chlorine bleach Wait for adjustment time in water to elapse before calibration
No match with DPD control measurement	Measurement takes place without pH compensation, while DPD measurement is always buffered to pH 6.3.	Measure chlorine value pH-compensated
DPD measured value much too high	Organic chlorination agent used (may also be used only at times or for shock chlorination). In this case, no correlation between actual free chlorine, DPD measurement and amperometric measurement. DPD value too high by a factor of up to 5.	Use free (gaseous) chlorine or chlorine from inorganic chlorine compounds
Chlorine value too high	Membrane defective	Replace membrane cap.
	Polarization not complete	Wait for polarization time to finish
	Foreign oxidizing agent	Analyze medium
	Shunt in chlorine sensor	Replace sensor
Chlorine value too low	Measuring chamber not closed	Refill and screw closed carefully
	Air cushion outside in front of membrane	Remove air bubble, possibly select better installation position
	Air cushion inside membrane	Refill and screw closed so that it is bubble-free
No or slow change of readings	Sensor fouled	Clean sensor
	Sensor old	Replace sensor
	Sensor defective (reference lead)	Replace sensor

Problem	Possible cause	Tests and/or remedial measures
Constant, incorrect measured value	Sensor does not immerse properly or protection cap not removed	Check installation position, remove protection cap
	Air pockets in assembly	Check assembly and installation position
No current output signal	Cable disconnected or short-circuited	Disconnect cable and measure directly at device
	Output defective	See "Device-specific errors" in the Operating Instructions of the transmitter, sampler, analyzer
Fixed current output signal	Current simulation active	Switch off simulation.
Incorrect current output signal	Total load in current loop too high	Measure the load and reduce it to the permitted value if necessary (see "Technical data" in the Operating Instructions of the transmitter, sampler, analyzer).
	EMC (interference coupling)	Check the wiring, identify and eliminate cause of interference

15.1.5 Measurement with ion-selective sensors

Problem	Possible cause	Tests and/or remedial measures
Temperature value always 20 °C or incorrect	<ul style="list-style-type: none"> ▪ Temperature sensor not connected or connected incorrectly ▪ temperature sensor defective ▪ Cable to temperature sensor defective 	Check temperature sensor and replace where necessary Replace the cable
Display deviates from reference measurement	Incorrect calibration	Repeat calibration Where necessary, check the calibration with the reference device and repeat.
	Electrode connected to the wrong slot	Compare terminal assignment to setting on transmitter
	Electrode is contaminated	Clean the electrode
	Temperature measurement	Check the temperature measured values of both devices
	Temperature compensation	Check the settings for temperature compensation and adjustment for both devices
	pH compensation (only for ammonium), pH measurement	Check the settings and the pH measurement if necessary
No or slow change of readings	<ul style="list-style-type: none"> ▪ Electrodes fouled ▪ Electrodes too old ▪ Electrodes defective 	<ul style="list-style-type: none"> ▪ Clean the electrodes ▪ Replace membrane cap and electrolyte ▪ Replace the electrodes
Measured value drift	Reference of pH electrode defective	Replace the pH electrode
	Contamination of reference electrode or ion-selective electrodes	Application problem

Problem	Possible cause	Tests and/or remedial measures
Measuring chain zero-point not stable and cannot be adjusted	Sensor does not immerse properly or protection cap of the pH electrode not removed	Check installation position, remove protection cap
	Air bubble in the electrode between membrane and inner terminal leads	Tap the electrolyte in the electrode towards the membrane
	Membrane cap or electrode defective	Replace the membrane cap or electrode
	Electrodes contaminated	Test with new electrodes
	Reference of pH electrode used	Replace the pH electrode
	Electrode connected to the wrong slot	Compare terminal assignment to setting on transmitter
Display fluctuates greatly	Air bubbles in the electrodes	Tap the electrolyte in the electrode towards the membrane
Fluctuations in measured value	Interference on signal output cable	Check cable routing, possibly route cable separately
	Interference potential in medium	Eliminate source of interference or ground medium as close as possible to sensor.
No current output signal	Cable disconnected or short-circuited	Disconnect cable and measure directly at device
	Output defective	See "Device-specific errors" in the Operating Instructions of the transmitter, sampler, analyzer
Fixed current output signal	Current simulation active	Switch off simulation.
Incorrect current output signal	Total load in current loop too high	Measure the load and reduce it to the permitted value if necessary (see "Technical data" in the Operating Instructions of the transmitter, sampler, analyzer).
	EMC (interference coupling)	Check the wiring, identify and eliminate cause of interference

15.1.6 Turbidity, SAC and nitrate measurement

Problem	Possible cause	Tests and/or remedial measures
Display value - - - -	Sensor defective	Test with a new sensor
	Sensor cable disconnected	Check the cable or cable extension
	Incorrect sensor connection	Check the connection at the input module (→  7)
	Electronics module defective	Replace module
No or slow change of readings	Sensor fouled	Clean sensor
Constant, incorrect measured value	Device in impermissible operating condition (does not respond when key pressed)	Switch off device and switch it on again

Problem	Possible cause	Tests and/or remedial measures
Implausible measured value	Sensor not calibrated or incorrectly calibrated	Calibration with original sample might be necessary for concentration or solids content
	Sensor fouled	Clean sensor
	Sensor installed in "dead zone" or air pocket in assembly or flange	Check installation position, move sensor to area that receives good flow. Pay attention when mounting in horizontal pipes
	Incorrect sensor orientation	Align sensor: <ul style="list-style-type: none"> ■ Normal media: Direct flow to measuring window ■ For high solids content: Align measuring window at angle of 90° to flow
Incorrect temperature value	Sensor defective	Change sensor
	Incorrect sensor connection	Check input module (→ 7)
Fluctuations in measured value	Interference on signal output cable	Check cable routing, possibly route cable separately
	Irregular flow / turbulence / air bubbles / large solid particles	Select a better mounting location or reduce turbulence, use a large measured value damping factor if necessary
No current output signal	Cable disconnected or short-circuited	Disconnect cable and measure directly at device
	Output defective	See "Device-specific errors" in the Operating Instructions of the transmitter, sampler, analyzer
Fixed current output signal	Current simulation active	Switch off simulation.
Incorrect current output signal	Total load in current loop too high	Measure the load and reduce it to the permitted value if necessary (see "Technical data" in the Operating Instructions of the transmitter, sampler, analyzer).
	EMC (interference coupling)	Check the wiring, identify and eliminate cause of interference
Value switches to zero and back to measured value	Air bubbles	Do not mount sensor above aeration discs

15.2 Overview of diagnostic information

15.2.1 Device-specific diagnostics messages

 Operating Instructions of the transmitter, sampler or analyzer

15.2.2 Sensor-specific diagnostics messages

The following abbreviations for the various sensor types are used in the table:

- P ... pH/ORP (general, applies for all pH sensors)
 - P (glass) ... only applies for glass electrodes
 - P (ISFET) ... only applies for ISFET sensors
- C ... conductivity (general, applies for all conductivity sensors)
 - C (cond.) ... only applies for sensors with conductive measurement of conductivity
 - C (ind.) ... only applies for sensors with inductive measurement of conductivity
- O ... oxygen (general, applies for all oxygen sensors)
 - O (opt.) ... only applies for optical oxygen sensors
 - O (amp.) ... only applies for amperometric oxygen sensors
- N ... nitrate sensors
- T ... turbidity and solids sensors
- S ... SAC sensors
- U ... interface sensors
- I ... ion-selective sensors
- DI ... disinfection sensors

No.	Message	Factory settings			Sensor type	Tests or remedial action
		S ¹⁾	D ²⁾	F ³⁾		
002	Sensor unknown	F	On	On	All	▶ Replace sensor.
004	Sensor defective	F	On	On	All	
005	Sensor data invalid	F	On	On	All	<ol style="list-style-type: none"> 1. Check the firmware compatibility of the sensor and transmitter or load suitable firmware 2. Set the sensor to the factory settings, disconnect the sensor and reconnect it. 3. Update transmitter data 4. Replace sensor.
010	Sensor scanning	F	Off	On	All	▶ Wait for initialization to be finished.
012	Writing data failed	F	On	On	All	<ol style="list-style-type: none"> 1. Repeat write process. 2. Replace sensor.
013	Sensor type wrong	F	On	On	All	<p>Sensor does not suit the device configuration or device configuration must be changed to new type of sensor</p> <ol style="list-style-type: none"> 1. Change to a sensor of the type that is configured. 2. Adapt the device configuration to the connected sensor.
018	Sensor not ready	F	On	On	All	<p>Sensor communication blocked</p> <ol style="list-style-type: none"> 1. Sensor fails tag check. Replace. 2. Internal software error. Contact the Service Department.
022	Temperature sensor	F	On	On	P, C, O, I, DI	<p>Temperature sensor defective</p> <p>▶ Replace sensor.</p>

No.	Message	Factory settings			Sensor type	Tests or remedial action
		S ¹⁾	D ²⁾	F ³⁾		
061	Sensor electronic	F	On	On	All	Sensor electronics defective ▶ Replace sensor.
062	Sensor connection	F	On	On	All	1. Check sensor connection. 2. Contact the Service Department.
081	Initialization	F	On	On	All	▶ Wait for initialization to be finished.
100	Sensor communication	F	On	On	All	Sensor not communicating 1. Check sensor connection. 2. Check sensor connector. 3. Contact the Service Department.
101	Sensor incompatible	F	On	On	All	1. Update sensor firmware 2. Replace sensor. 3. Contact the Service Department.
102	Calibration timer	M	On	Off	All	Calibration interval elapsed. Measurement can still take place. ▶ Calibrate sensor.
103	Calibration timer	M	On	Off	All	Calibration interval will elapse soon. Measurement can still take place. ▶ Calibrate sensor.
104	Calibration validity	M	On	Off	All	Last calibration no longer valid. Measurement can still take place. ▶ Calibrate sensor.
105	Calibration validity	M	On	Off	All	Last calibration will lose its validity soon. Measurement can still take place. ▶ Calibrate sensor.
106	Sensor TAG	F	On	On	All	Sensor has invalid tag or tag group
107	Calibration active	C	On	Off	P, C, O, I, DI, Phot	▶ Wait for calibration to be finished.
108	SIP, CIP, autoclaving	M	On	Off	P, C, O	Specified number of sterilizations will soon be reached. Measurement can still take place. ▶ Replace sensor.
109	Sterilization cap	M	On	Off	O (amp.)	Specified number of sterilizations for the cap is reached. Measurement can still take place. ▶ Replace membrane cap.
110	Init. channel	F	On	On	All	Channel initialization has failed. Measuring operation not possible. ▶ Contact the Service Department.
111	Operating time cap	M	On	Off	DI	Hours of operation monitoring The limit set for the total hours of operation for the cap has been reached. Measurement can still take place. 1. Replace the cap. 2. Change monitoring limit.
114	Temp.offset high	M	On	Off	All except U, Phot	Calibration alarm: Limit values for temperature offset exceeded 1. Check temperature sensor. 2. Replace sensor.
115	Temp. offset low	M	On	Off	All except U, Phot	

No.	Message	Factory settings			Sensor type	Tests or remedial action
		S ¹⁾	D ²⁾	F ³⁾		
116	Temp. slope high	M	On	Off	All except U, Phot	Calibration alarm: Limit values for temperature slope exceeded
117	Temp. slope low	M	On	Off	All except U, Phot	Sensor old or defective <ol style="list-style-type: none"> Repeat calibration. Replace sensor.
118	Sensor glass break.	F	On	Off	P (glass)	Glass breakage warning, impedance of pH glass too low
119	Sensor check	M	On	Off	P (glass)	Measuring can continue until the alarm (118) occurs. <ol style="list-style-type: none"> Inspect sensor for hair-line cracks and breakage. Check medium temperature. Replace sensor.
120	Sensor reference	F	On	Off	P (glass)	Reference warning, impedance of reference too low
121	Sensor reference	M	On	Off	P (glass)	Measuring can continue until the alarm (120) occurs. <ol style="list-style-type: none"> Check reference for clogging/contamination. Clean reference/junction. Replace sensor.
122	Sensor glass	F	On	Off	P (glass)	Impedance limit values exceeded/undershot
123	Sensor glass	M	On	On	P (glass)	Measuring can continue until the alarm (122, 124) occurs.
124	Sensor glass	M	On	Off	P (glass)	
125	Sensor glass	F	On	Off	P (glass)	<ol style="list-style-type: none"> Inspect sensor for hair-line cracks and breakage. Check or change limit values. Replace sensor.
126	Sensor check	M	On	Off	P (glass)	Sensor condition check (SCC), poor sensor condition Glass membrane fouled or dry, junction blocked <ol style="list-style-type: none"> Clean sensor, regenerate Replace sensor.
127	Sensor check	M	On	Off	P (glass)	Sensor condition check (SCC), adequate sensor condition
128	Sensor leakage	F	On	Off	P (ISFET), O (amp.), DI	Leak current alarm Defective due to abrasion or damage Damage to the gate (only ISFET) ▶ Replace sensor.
129	Sensor leakage	F	On	Off	P (ISFET), O (amp.), DI	Leak current warning Measuring can continue until the alarm occurs
130	Sensor supply	F	On	Off	P, O, I, DI	Poor sensor power supply <ol style="list-style-type: none"> Check sensor connection. Replace sensor.

No.	Message	Factory settings			Sensor type	Tests or remedial action
		S ¹⁾	D ²⁾	F ³⁾		
131	Sensor calibration	M	On	Off	O (opt.)	Limit values for sensor relaxation time (fluorescence decay time) exceeded/undershot Reasons: high oxygen content, incorrect calibration 1. Repeat calibration. 2. Replace sensor cap. 3. Contact the Service Department.
132	Sensor calibration	M	On	Off	O (opt.)	
133	Sensor signal	F	On	Off	O (opt.)	No signal (fluorescence decay) 1. Replace sensor cap. 2. Contact the Service Department.
134	Sensor signal	M	On	Off	O (opt.)	Low signal amplitude. Measurement can still take place. 1. Replace sensor cap. 2. Contact the Service Department.
135	Sensor temp. low	S	On	Off	O	Temperature outside specification 1. Check process. 2. Check installation.
136	Sensor temp. high	S	On	Off	O	
137	Sensor LED	F	On	Off	O (opt.)	Sensor LED: no voltage ► Contact the Service Department.
138	Sensor LED	F	On	Off	O (opt.)	Sensor LED: no power ► Contact the Service Department.
140	Sensor check	F	On	Off	O	Sensor range errors ► Contact the Service Department.
141	Polarization	F	On	Off	C (cond.)	Polarization warning The measured value is corrupted at high conductivity levels. ► Use a sensor with a larger cell constant.
142	Sensor signal	F	On	Off	C	Reasons: sensor in air, sensor defective 1. Check installation. 2. Replace sensor.
143	Sensor check	F	On	Off	C	Sensor self-test error 1. Replace sensor. 2. Contact the Service Department.
144	Conductivity range	S	Off	On	C	Conductivity outside measuring range ► Use a sensor with a suitable cell constant.
146	Sensor temperature	S	Off	Off	C, N, T, S	Temperature outside specification 1. Check the temperature. 2. Check electrode system. 3. Replace sensor type.
147	Sensor check	F	On	On	C (ind.)	Coil transmission current too high Reasons: transmission coil short-circuit, inductance too low 1. Replace sensor. 2. Contact the Service Department.

No.	Message	Factory settings			Sensor type	Tests or remedial action
		S ¹⁾	D ²⁾	F ³⁾		
148	Sensor check	F	On	On	C (ind.)	Reasons: transmission coil interrupted, inductance too high <ol style="list-style-type: none"> 1. Replace sensor. 2. Contact the Service Department.
149	Sensor LED	F	On	On	T	Sensor LED error <ol style="list-style-type: none"> 1. Replace sensor. 2. Contact the Service Department.
151	Sensor buildup	F	On	On	T	Buildup, high degree of contamination <ol style="list-style-type: none"> 1. Clean sensor. 2. Replace sensor. 3. Contact the Service Department.
152	Sensor data invalid	M	Off	Off	C (ind.)	No calibration data ▶ Perform air set calibration.
153	Sensor defective	F	On	On	N, T, S, Phot	Sensor strobe lamp defective Reasons: aging, end of operating life, mechanical disturbance/vibration <ol style="list-style-type: none"> 1. Replace sensor. 2. Contact the Service Department.
154	Sensor data invalid	M	Off	Off	C	Factory calibration is used ▶ Calibrate.
155	Sensor defective	F	On	On	N, T, S	Sensor defective Error with analog evaluation <ol style="list-style-type: none"> 1. Replace sensor. 2. Contact the Service Department.
156	Organic pollution	F	On	On	N, T, S	Excessive organic fouling Reasons: sensor fouling, high organic content, incorrect orientation <ol style="list-style-type: none"> 1. Clean sensor 2. Install automatic cleaning. 3. Check application.
157	Filter change	M	On	Off	N, S, Phot	Optical filter must be replaced Reasons: long period of operation, moisture in sensor <ol style="list-style-type: none"> 1. Replace sensor. 2. Contact the Service Department.
158	Sensor check	F	On	Off	N, T, S	Invalid measured value <ol style="list-style-type: none"> 1. Check sensor power supply. 2. Restart the device. 3. Contact the Service Department.
159	Sensor check	F	On	Off	N, T, S	Uncertain measured value Reasons: sensor fouling, incorrect application <ol style="list-style-type: none"> 1. Clean sensor. 2. Check application.

No.	Message	Factory settings			Sensor type	Tests or remedial action
		S ¹⁾	D ²⁾	F ³⁾		
160	Sensor data invalid	F	On	Off	N, T, S, DI	No calibration data Reasons: data deleted <ol style="list-style-type: none"> 1. Select other data record. 2. Use factory calibration. 3. Contact the Service Department.
161	Filter change	F	On	Off	N, T, S	Filter needs to be changed Reasons: long period of operation, moisture in sensor <ol style="list-style-type: none"> 1. Replace sensor. 2. Contact the Service Department.
162	Install.factor	M	On	Off	C (ind.)	Installation factor exceeded/undershot, alarm Reason: distance between wall and sensor too small (< 15 mm) <ol style="list-style-type: none"> 1. Check pipe diameter. 2. Clean sensor. 3. Calibrate sensor.
163	Install.factor	M	On	Off	C (ind.)	
164	Sensor data invalid	M	Off	Off	C	No temperature calibration data Factory calibration is used <ol style="list-style-type: none"> 1. Check process. 2. Check or replace sensor.
168	Polarization	S	On	Off	C (cond.)	Polarization warning The measured value is corrupted at high conductivity levels. <ul style="list-style-type: none"> ▶ Use a sensor with a larger cell constant.
169	Operating time	M	On	Off	S	Operating hours, conc. > 200 mg/l, measurement can still take place <ol style="list-style-type: none"> 1. Replace sensor. 2. Change monitoring limit. 3. Disable monitoring.
170	Operating time	M	On	Off	S	Operating hours, conc. < 50 mg/l, measurement can still take place <ol style="list-style-type: none"> 1. Replace sensor. 2. Change monitoring limit. 3. Disable monitoring.
171	Lamp change	M	On	Off	N, T, S, Phot	Lamp must be replaced <ol style="list-style-type: none"> 1. Replace sensor. 2. Contact the Service Department.
172	Echo lost	F	On	On	U	Echo signal lost
173	Sludge level	F	On	On	U	Incorrect separation zone measurement <ul style="list-style-type: none"> ▶ Replace sensor.
174	Turbid. failure	F	On	On	U	Incorrect turbidity measurement <ul style="list-style-type: none"> ▶ Replace sensor.
175	Wiper failure	F	On	On	U	Wiper not working <ul style="list-style-type: none"> ▶ Clean or replace sensor.

No.	Message	Factory settings			Sensor type	Tests or remedial action
		S ¹⁾	D ²⁾	F ³⁾		
176	Operating time	M	On	Off	DI	Operating hours > 100 nA, measurement can still take place <ol style="list-style-type: none"> 1. Replace sensor. 2. Change monitoring limit. 3. Disable monitoring.
177	Operating time	M	On	Off	DI	Operating hours > 20 nA, measurement can still take place <ol style="list-style-type: none"> 1. Replace sensor. 2. Change monitoring limit. 3. Disable monitoring.
178	Operating time	M	On	Off	DI	Operating hours > 15 °C, measurement can still take place <ol style="list-style-type: none"> 1. Replace sensor. 2. Change monitoring limit. 3. Disable monitoring.
179	Operating time	M	On	Off	P	Operating hours > 300 mV, measurement can still take place <ol style="list-style-type: none"> 1. Replace sensor. 2. Change monitoring limit. 3. Disable monitoring.
180	Operating time	M	On	Off	P	Operating hours < -300 mV, measurement can still take place <ol style="list-style-type: none"> 1. Replace sensor. 2. Change monitoring limit. 3. Disable monitoring.
181	Operating time	M	On	Off	O (opt.)	Operating hours < 25 µS, measurement can still take place <ol style="list-style-type: none"> 1. Replace sensor. 2. Change monitoring limit. 3. Disable monitoring.
182	Operating time	M	On	Off	O (opt.)	Operating hours > 40 µS, measurement can still take place <ol style="list-style-type: none"> 1. Replace sensor. 2. Change monitoring limit. 3. Disable monitoring.
183	Operating time	M	On	Off	O (amp.)	Operating hours > 10 nA (COS51D), measurement can still take place <ol style="list-style-type: none"> 1. Replace sensor. 2. Change monitoring limit. 3. Disable monitoring.
184	Operating time	M	On	Off	O (amp.)	Operating hours > 30 nA (COS22D), measurement can still take place <ol style="list-style-type: none"> 1. Replace sensor. 2. Change monitoring limit. 3. Disable monitoring.

No.	Message	Factory settings			Sensor type	Tests or remedial action
		S ¹⁾	D ²⁾	F ³⁾		
185	Operating time	M	On	Off	O (amp.)	Operating hours > 40 nA (COS51D), measurement can still take place <ol style="list-style-type: none"> 1. Replace sensor. 2. Change monitoring limit. 3. Disable monitoring.
186	Operating time	M	On	Off	O (amp.)	Operating hours > 160 nA (COS22D), measurement can still take place <ol style="list-style-type: none"> 1. Replace sensor. 2. Change monitoring limit. 3. Disable monitoring.
187	Operating time	M	On	Off	C	Operating hours > 80 °C, 100 nS/cm, measurement can still take place <ol style="list-style-type: none"> 1. Replace sensor. 2. Change monitoring limit. 3. Disable monitoring.
188	Operating time	M	On	Off	C, O	Operating hours < 5 °C, measurement can still take place <ol style="list-style-type: none"> 1. Replace sensor. 2. Change monitoring limit. 3. Disable monitoring.
189	Operating time	M	On	Off	O	Operating hours > 5 °C, measurement can still take place <ol style="list-style-type: none"> 1. Replace sensor. 2. Change monitoring limit. 3. Disable monitoring.
190	Operating time	M	On	Off	O	Operating hours > 25 °C, measurement can still take place <ol style="list-style-type: none"> 1. Replace sensor. 2. Change monitoring limit. 3. Disable monitoring.
191	Operating time	M	On	Off	O, I, DI	Operating hours > 30 °C, measurement can still take place <ol style="list-style-type: none"> 1. Replace sensor. 2. Change monitoring limit. 3. Disable monitoring.
192	Operating time	M	On	Off	O, I	Operating hours > 40 °C, measurement can still take place <ol style="list-style-type: none"> 1. Replace sensor. 2. Change monitoring limit. 3. Disable monitoring.
193	Operating time	M	On	Off	P, C, O	Operating hours > 80 °C, measurement can still take place <ol style="list-style-type: none"> 1. Replace sensor. 2. Change monitoring limit. 3. Disable monitoring.

No.	Message	Factory settings			Sensor type	Tests or remedial action
		S ¹⁾	D ²⁾	F ³⁾		
194	Operating time	M	On	Off	P	Operating hours > 100 °C, measurement can still take place <ol style="list-style-type: none"> 1. Replace sensor. 2. Change monitoring limit. 3. Disable monitoring.
195	Operating time	M	On	Off	C	Operating hours > 120 °C, measurement can still take place <ol style="list-style-type: none"> 1. Replace sensor. 2. Change monitoring limit. 3. Disable monitoring.
196	Operating time	M	On	Off	C	Operating hours > 125 °C, measurement can still take place <ol style="list-style-type: none"> 1. Replace sensor. 2. Change monitoring limit. 3. Disable monitoring.
197	Operating time	M	On	Off	C	Operating hours > 140 °C, measurement can still take place <ol style="list-style-type: none"> 1. Replace sensor. 2. Change monitoring limit. 3. Disable monitoring.
198	Operating time	M	On	Off	C	Operating hours > 150 °C, measurement can still take place <ol style="list-style-type: none"> 1. Replace sensor. 2. Change monitoring limit. 3. Disable monitoring.
199	Operating time	M	On	Off	All except U, Phot	Total operating hours
215	Simulation active	C	On	Off	All except Phot	Simulation active End simulation by changing to measuring mode.
408	Calibration aborted	M	Off	Off	P, C, O, I, DI, Phot	Calibration aborted
500	Sensor calibration	M	On	Off	All	Calibration aborted, main measured value varies Reasons: sensor too old, sensor occasionally dry, calibration value not constant <ol style="list-style-type: none"> 1. Check sensor. 2. Check calibration solution.
501	Sensor calibration	M	On	Off	All except U, Phot	Calibration aborted, temperature measured value varies Reasons: sensor too old, sensor occasionally dry, temperature of calibration solution not constant <ol style="list-style-type: none"> 1. Check sensor. 2. Regulate calibration solution temperature.

No.	Message	Factory settings			Sensor type	Tests or remedial action
		S ¹⁾	D ²⁾	F ³⁾		
505	Sensor calibration	M	On	Off	P, O, I, DI	<p>Max. zero point warning, measurement can still take place</p> <p>Possible reasons: sensor old or defective, reference blocked, calibration solution too old or contaminated</p> <ol style="list-style-type: none"> 1. Check or replace sensor. 2. Check or replace calibration solution. 3. Repeat calibration.
507	Sensor calibration	M	On	Off	P, O, I, DI	<p>Min. zero point warning, measurement can still take place</p> <p>Possible reasons: sensor old or defective, reference blocked, calibration solution too old or contaminated</p> <ol style="list-style-type: none"> 1. Check or replace sensor. 2. Check or replace calibration solution. 3. Repeat calibration.
509	Sensor calibration	M	On	Off	P, O, I, DI	<p>Min. slope warning, measurement can still take place</p> <p>Possible reasons: sensor old or defective, reference blocked, calibration solution too old or contaminated</p> <ol style="list-style-type: none"> 1. Check or replace sensor. 2. Check or replace calibration solution. 3. Repeat calibration.
511	Sensor calibration	M	On	Off	P, O, I, DI	<p>Max. slope warning, measurement can still take place</p> <p>Possible reasons: sensor old or defective, reference blocked, calibration solution too old or contaminated</p> <ol style="list-style-type: none"> 1. Check or replace sensor. 2. Check or replace calibration solution. 3. Repeat calibration.
513	Zero Warning	M	On	Off	O (amp.), DI	<p>Zero point warning, measurement can still take place</p> <p>Possible reasons: sensor old or defective, reference blocked, calibration solution too old or contaminated</p> <ol style="list-style-type: none"> 1. Check or replace sensor. 2. Check or replace calibration solution. 3. Repeat calibration.

No.	Message	Factory settings			Sensor type	Tests or remedial action
		S ¹⁾	D ²⁾	F ³⁾		
515	Sensor calibration	M	On	Off	P (ISFET)	<p>Max. operating point warning, measurement can still take place</p> <p>Possible reasons: sensor old or defective, reference blocked, calibration solution too old or contaminated</p> <ol style="list-style-type: none"> 1. Check or replace sensor. 2. Check or replace calibration solution. 3. Repeat calibration.
517	Sensor calibration	M	On	Off	P (ISFET)	<p>Min. operating point warning, measurement can still take place</p> <p>Possible reasons: sensor old or defective, reference blocked, calibration solution too old or contaminated</p> <ol style="list-style-type: none"> 1. Check or replace sensor. 2. Check or replace calibration solution. 3. Repeat calibration.
518	Sensor calibration	M	On	Off	P, O, I, DI	<p>Delta slope warning, measurement can still take place</p> <p>Possible reasons: sensor old or defective, reference blocked, calibration solution too old or contaminated</p> <ol style="list-style-type: none"> 1. Check or replace sensor. 2. Check or replace calibration solution. 3. Repeat calibration.
520	Sensor calibration	M	On	Off	P, O, I, DI	<p>Delta zero point warning, measurement can still take place</p> <p>Possible reasons: sensor old or defective, reference blocked, calibration solution too old or contaminated</p> <ol style="list-style-type: none"> 1. Check or replace sensor. 2. Check or replace calibration solution. 3. Repeat calibration.
522	Sensor calibration	M	On	Off	P (ISFET)	<p>Delta operating point warning, measurement can still take place</p> <p>Possible reasons: sensor old or defective, reference blocked, calibration solution too old or contaminated</p> <ol style="list-style-type: none"> 1. Check or replace sensor. 2. Check or replace calibration solution. 3. Repeat calibration.
534	Electrolyte warning	M	On	Off	DI	<p>Electrolyte consumption warning</p> <p>The limit set for the electrolyte capacity has been reached.</p> <ol style="list-style-type: none"> 1. Replace electrolyte. 2. Reset consumption counter. 3. Replace sensor.

No.	Message	Factory settings			Sensor type	Tests or remedial action
		S ¹⁾	D ²⁾	F ³⁾		
535	Sensor check	M	On	Off	O (amp.), DI	Specified number of cap calibrations is reached Measurement can still take place. ▶ Replace sensor cap.
550	Process temperature	S	On	On	C	Process temperature above/below concentration table ■ Process value outside specification ■ Table incomplete ▶ Extend table.
551	Process temperature	S	On	On	C	
552	Conductivity low	S	On	On	C	Process concentration above/below concentration table ■ Process value outside specification ■ Table incomplete ▶ Extend table.
553	Conductivity high	S	On	On	C	
554	Concentration low	S	On	On	C	Process concentration above/below concentration table ■ Process value outside specification ■ Table incomplete ▶ Extend table.
555	Concentration high	S	On	On	C	
556	Temperature low	S	On	On	C	Process temperature above/below compensation table ■ Process value outside specification ■ Table incomplete ▶ Extend table.
557	Temperature high	S	On	On	C	
558	Conductivity low	S	On	On	C	Process conductivity above/below compensation table ■ Process value outside specification ■ Table incomplete ▶ Extend table.
559	Conductivity high	S	On	On	C	
560	Conduc. compensation	S	On	On	C	Conductivity compensation above/below compensation table ■ Process value outside specification ■ Table incomplete ▶ Extend table.
561	Conduc. compensation	S	On	On	C	
720	Membrane change	M	On	Off	I	Membrane cap must be replaced 1. Replace membrane cap. 2. Reset timer.
722	Sensor reference	F	On	On	P	Alarm: Reference membrane impedance too low. 1. Check or replace sensor. 2. Check/correct reference limit value.
723	Sensor reference	M	On	Off	I	Warning: Reference membrane impedance too low. Can continue measuring until the alarm occurs. 1. Check or replace sensor. 2. Check/correct reference limit value.

No.	Message	Factory settings			Sensor type	Tests or remedial action
		S ¹⁾	D ²⁾	F ³⁾		
724	Sensor reference	F	On	On	I	Alarm: Reference membrane impedance too high. <ol style="list-style-type: none"> 1. Check or replace sensor. 2. Check/correct reference limit value.
725	Sensor reference	M	On	Off	I	Warning: Reference membrane impedance too high. Can continue measuring until the alarm occurs. <ol style="list-style-type: none"> 1. Check or replace sensor. 2. Check/correct reference limit value.
734	Calibration quality	M	On	Off	O (opt.)	Warning: The calibration quality index indicates a substantial change since the last calibration. Measurement can still take place. <ol style="list-style-type: none"> 1. Repeat calibration. 2. Check the sensor and replace if necessary.
740	Sensor defective	F	On	On	CLS82D	Internal electrode failure <ol style="list-style-type: none"> 1. Replace sensor. 2. Contact the Service Department.
771	Lamp change	F	On	Off	N, T, S	Lamp change alarm Configured operating time has been reached <ol style="list-style-type: none"> 1. Replace lamp. 2. Contact the Service Department.
832	Temp. range exceeded	S	Off	Off	All except U	Outside temperature specification <ol style="list-style-type: none"> 1. Check application. 2. Check temperature sensor.
841	Operating range	S	Off	Off	All	Process value outside operational range <ol style="list-style-type: none"> 1. Check application. 2. Check sensor.
842	Process value	S	Off	Off	P	Process limit value exceeded/undershot Reasons: sensor in air, air pockets in assembly, incorrect flow to sensor, sensor defective <ol style="list-style-type: none"> 1. Change process value. 2. Check electrode system. 3. Change sensor type.
843	Process value	S	Off	Off	P	
844	Process value	S	Off	Off	N, T, S	Measured value outside specified range Reasons: sensor in air, air pockets in assembly, incorrect flow to sensor, sensor defective <ol style="list-style-type: none"> 1. Increase process value. 2. Check electrode system. 3. Change sensor type.

No.	Message	Factory settings			Sensor type	Tests or remedial action
		S ¹⁾	D ²⁾	F ³⁾		
904	Process check alarm	F	On	On	All except Phot	Stagnating measuring signal Reasons: sensor in air, sensor fouling, incorrect flow to sensor, sensor defective 1. Check electrode system. 2. Check sensor. 3. Restart the device.
914	USP/ EP alarm	M	On	Off	C	USP limit values exceeded ► Check process.
915	USP / EP warning	M	On	Off	C	
934	Process temp. high	S	Off	Off	N, S, U	Process temperature high 1. Do not increase process temperature. 2. Check electrode system. 3. Change sensor type.
935	Process temp. low	S	Off	Off	N, S, U	Process temperature low 1. Do not lower process temperature. 2. Check electrode system. 3. Change sensor type.
942	Process value	S	Off	Off	N, P, U	Process value high 1. Do not increase process value. 2. Check electrode system. 3. Change sensor type.
943	Process value	S	Off	Off	N, P, U	Process value low 1. Do not decrease process value. 2. Check electrode system. 3. Change sensor type.
944	Sensor range	S	On	Off	S, U	Measurement at periphery of sensor dynamic range Reasons: changes in process to a higher or lower measuring range 1. Check application. 2. Use sensor that suits the measuring range of the application.
945	pH value high	S	On	Off	DI	Warning maximum pH value exceeded 1. Check application. 2. Check pH sensor.
946	pH value low	S	On	Off	DI	Warning minimum pH value not reached. Potential leaking of gaseous chlorine! 1. Check application. 2. Check pH sensor.
950	Process temperature	F	On	On	C	Concentration table (conductivity) Process temperature below the lowest value in the table ► Extend table.

No.	Message	Factory settings			Sensor type	Tests or remedial action
		S ¹⁾	D ²⁾	F ³⁾		
951	Process temperature	F	On	On	C	Concentration table (conductivity) Process temperature above the highest value in the table ▶ Extend table.
952	Conductivity low	F	On	On	C	Concentration table (conductivity) Process conductivity below the lowest value in the table ▶ Extend table.
953	Conductivity high	F	On	On	C	Concentration table (conductivity) Process conductivity above the highest value in the table ▶ Extend table.
954	Concentration low	F	On	On	C	Concentration table (conductivity) Process concentration below the lowest value in the table ▶ Extend table.
955	Concentration high	F	On	On	C	Concentration table (conductivity) Process concentration above the highest value in the table ▶ Extend table.
983	Sensor ISE check	F	On	On	I	Electrode or membrane defective 1. Check or replace electrode. 2. Check or replace membrane cap.
984	Process temp. high	S	On	On	I	Temperature outside specification 1. Check process temperature. 2. Check electrode system.
985	Sensor Interface	F	On	On	I	Sensor interface error 1. Check connector. 2. Check or replace cable.
987	Calibration required	M	On	On	I, DI	Electrode replacement ▶ Calibrate sensor.

- 1) **Status signal**
2) **Diagnostic message**
3) **Error current**

15.2.3 Configuration options for troubleshooting

The table only lists the diagnostics messages that depend on your settings in the menu. The path where you can change the settings is specified in the table.

- The sensor type is only indicated if the message only applies to one type of sensor.
- If several types of sensor are affected, the abbreviation ../ is used for the path.

No.	Menu/Setup/Inputs/..
102	../Extended setup/Calib. settings/Calibration timer
103	../Extended setup/Calib. settings/Calibration timer
104	../Extended setup/Calib. settings/Calib. expiration time/Alarm limit
105	../Extended setup/Calib. settings/Calib. expiration time/Warning limit

No.	Menu/Setup/Inputs/..
108	../Extended setup/Diagnostics settings/Sterilizations/Warning limit
109	Oxygen (amp.)/Extended setup/Diagnostics settings/Number of cap sterilizations/Warning limit
111	Disinfection/Extended setup/Diagnostics settings/Limits operating hours cap
122	pH Glass/Extended setup/Diagnostics settings/Glass impedance (SCS)/Lower alarm limit
123	pH Glass/Extended setup/Diagnostics settings/Glass impedance (SCS)/Lower warning limit
124	pH Glass/Extended setup/Diagnostics settings/Glass impedance (SCS)/Upper alarm limit
125	pH Glass/Extended setup/Diagnostics settings/Glass impedance (SCS)/Upper warning limit
126	pH Glass/Extended setup/Diagnostics settings/Sensor Condition Check
127	pH Glass/Extended setup/Diagnostics settings/Sensor Condition Check
145	pH Glass/Extended setup/Diagnostics settings/Sensor Condition Check
157	Nitrate/Extended setup/Diagnostics settings/Limits operating hours/Filter change
168	Cond c/Extended setup/Diagnostics settings/Polarization compensation
169	SAC/Extended setup/Diagnostics settings/Limits operating hours/Operation > 200 mg/l/Warning limit
170	SAC/Extended setup/Diagnostics settings/Limits operating hours/Operation < 50 mg/l/Warning limit
176	Chlorine/Extended setup/Diagnostics settings/Limits operating hours/Operation > 100 nA/Warning limit
178	Oxygen (amp.)/Extended setup/Diagnostics settings/Number of cap sterilizations/Alarm limit
179	../Extended setup/Diagnostics settings/Limits operating hours/Operation > 300 mV/Warning limit
180	../Extended setup/Diagnostics settings/Limits operating hours/Operation < -300 mVWarning limit
181	Oxygen (opt. fixed cable)/Extended setup/Diagnostics settings/Limits operating hours/Operation < 25 µs/Warning limit
182	Oxygen (opt. fixed cable)/Extended setup/Diagnostics settings/Limits operating hours/Operation > 40 µs/Warning limit
183	Oxygen (amp.)/Extended setup/Diagnostics settings/Limits operating hours/Operation > 15 nA/Warning limit
184	Oxygen (amp.)/Extended setup/Diagnostics settings/Limits operating hours/Operation > 30 nA/Warning limit
185	Oxygen (amp.)/Extended setup/Diagnostics settings/Limits operating hours/Operation > 50 nA/Warning limit
186	Oxygen (amp.)/Extended setup/Diagnostics settings/Limits operating hours/Operation > 160 nA/Warning limit
187	Cond c/Extended setup/Diagnostics settings/Limits operating hours/Operation > 80°C < 100nS/cm/Warning limit
188	../Extended setup/Diagnostics settings/Limits operating hours/Operation < 5 °C/Warning limit
190	../Extended setup/Diagnostics settings/Limits operating hours/Operation > 25 °C/Warning limit
192	../Extended setup/Diagnostics settings/Limits operating hours/Operation > 40 °C/Warning limit
193	../Extended setup/Diagnostics settings/Limits operating hours/Operation > 80 °C/Warning limit
194	../Extended setup/Diagnostics settings/Limits operating hours/Operation > 100 °C/Warning limit
195	../Extended setup/Diagnostics settings/Limits operating hours/Operation > 120 °C/Warning limit
196	../Extended setup/Diagnostics settings/Limits operating hours/Operation > 125 °C/Warning limit
197	../Extended setup/Diagnostics settings/Limits operating hours/Operation > 140 °C/Warning limit
198	../Extended setup/Diagnostics settings/Limits operating hours/Operation > 150 °C/Warning limit
199	../Extended setup/Diagnostics settings/Limits operating hours/Operating time/Warning limit

No.	Menu/Setup/Inputs/..
505	../Extended setup/Diagnostics settings/Zero point/Upper warning limit
507	../Extended setup/Diagnostics settings/Zero point/Lower warning limit
509	Oxygen (amp.)/Extended setup/Diagnostics settings/Slope/Lower warning limit
511	Oxygen (amp.)/Extended setup/Diagnostics settings/Slope/Upper warning limit
513	Oxygen (amp.)/Extended setup/Diagnostics settings/Zero point/Warning limit
515	pH ISFET/Extended setup/Diagnostics settings/Operating point/Upper warning limit
517	pH ISFET/Extended setup/Diagnostics settings/Operating point/Lower warning limit
518	../Extended setup/Diagnostics settings/Delta slope/Warning limit
520	../Extended setup/Diagnostics settings/Delta zero point/Warning limit
522	pH ISFET/Extended setup/Diagnostics settings/Delta operating point/Warning limit
535	Chlorine/Extended setup/Diagnostics settings/Number of cap calibrations/Warning limit
842	ORP/Extended setup/Diagnostics settings/ORP-Meas value/Upper alarm limit
843	ORP/Extended setup/Diagnostics settings/ORP-Meas value/Lower alarm limit
904	../Extended setup/Diagnostics settings/Process Check System
942	ORP/Extended setup/Diagnostics settings/ORP-Meas value/Upper warning limit
943	ORP/Extended setup/Diagnostics settings/ORP-Meas value/Lower warning limit

15.3 Sensor information

- ▶ Select the channel you want from the list of channels.

Information in the following categories is displayed:

- **Extreme values**

Extreme conditions to which the sensor was previously exposed, e. g. min./max. temperatures ¹⁾

- **Operating time**

Operating time of the sensor under defined extreme conditions

- **Calibration information**

Calibration data of the last calibration

- **Sensor specifications**

Measuring range limits for main measured value and temperature

- **General information**

Information on sensor identification

The specific data that are displayed depends on what sensor is connected.

1) Not available for all sensor types.

16 Maintenance

16.1 Cleaning digital sensors

CAUTION

Cleaning not switched off during calibration or maintenance activities

Risk of injury due to medium or cleaning agent!

- ▶ If a cleaning system is connected, switch it off before removing a sensor from the medium.
- ▶ If you wish to check the cleaning function and have therefore not switched off the cleaning system, wear protective clothing, goggles and gloves or take other appropriate measures.

Replacing the sensor while ensuring measuring point availability

If an error occurs or the maintenance schedule stipulates that the sensor has to be replaced, use a new sensor, or a sensor that has been precalibrated in the laboratory.

- A sensor is calibrated in the laboratory under optimum external conditions, thereby ensuring better quality of measurement.
- You must perform onsite calibration if you use a sensor that is not precalibrated.

1. Remove the sensor that requires maintenance.
2. Install the new sensor.
 - ↳ The sensor data are automatically accepted by the transmitter. A release code is not required.
Measurement is resumed.
3. Take the used sensor back to the laboratory.
 - ↳ In the laboratory you can get the sensor ready for reuse while ensuring the availability of the measuring point.

Prepare the sensor for reuse

1. Clean sensor.
 - ↳ For this purpose, use the cleaning agent specified in the sensor manual.
2. Inspect the sensor for cracks or other damage.
3. If no damage is found, regenerate the sensor. Where necessary, store the sensor in a regeneration solution (→ sensor manual).
4. Recalibrate the sensor for reuse.

16.2 Cleaning assemblies

Refer to the assembly operating manual for information on servicing and troubleshooting the assembly. The assembly operating manual describes the procedure for mounting and disassembling the assembly, replacing the sensors and seals, and contains information on the material resistance properties, as well as on spare parts and accessories.

16.3 Performing a decade resistance test on digital inductive conductivity sensors

The inductive sensor cannot be simulated.

However, the overall system comprising the transmitter and inductive sensor can be tested using equivalent resistors. Note the cell constant k (e.g. $k_{\text{nominal}} = 1.98 \text{ cm}^{-1}$ for CLS50D, $k_{\text{nominal}} = 6.3 \text{ cm}^{-1}$ for CLS54D).

For accurate simulation, the actual cell constant used must be used to calculate the display value.

The formula for calculation also depends on the type of sensor:

- CLS50D: conductivity reading [mS/cm] = $k[\text{cm}^{-1}] \cdot 1/R[\text{k}\Omega]$
- CLS54D: conductivity reading [mS/cm] = $k[\text{cm}^{-1}] \cdot 1/R[\text{k}\Omega] \cdot 1.21$

Simulation with CLS50D at 25 °C (77 °F):

Simulation resistance R	Default cell constant k	Conductivity reading
2 Ω	1.98 cm^{-1}	990 mS/cm
10 Ω	1.98 cm^{-1}	198 mS/cm
100 Ω	1.98 cm^{-1}	19.8 mS/cm
1 k Ω	1.98 cm^{-1}	1.98 mS/cm

Simulation with CLS54D at 25 °C (77 °F):

Simulation resistance R	Default cell constant k	Conductivity reading
10 Ω	6.3 cm^{-1}	520 mS/cm
26 Ω	6.3 cm^{-1}	200 mS/cm
100 Ω	6.3 cm^{-1}	52 mS/cm
260 Ω	6.3 cm^{-1}	20 mS/cm
2.6 k Ω	6.3 cm^{-1}	2 mS/cm
26 k Ω	6.3 cm^{-1}	200 $\mu\text{S/cm}$
52 k Ω	6.3 cm^{-1}	100 $\mu\text{S/cm}$

Conductivity simulation

Guide a suitable cable through the opening of the sensor (sensor coil). Then connect the cable to a decade resistor.

17 Calibration

- Sensors with Memosens protocol are calibrated at the factory.
- Users must decide whether the process conditions present require calibration during initial commissioning.
- Additional calibration is not required in many standard applications.
- Calibrate the sensors at sensible intervals depending on the process.

17.1 Definitions

Calibration

(according to DIN 1319)

A calibration is defined as an operation to establish the relationship between the measured value or expected value of the output variable and the related true or correct value of the measured variable (input variable) for a measuring system under specified conditions.

A calibration does not alter the performance of the measuring device.

Adjustment

An adjustment corrects the value displayed by a measuring device, in other words the measured/displayed value (the actual value) is corrected so that the reading agrees with the correct, set value.

The value determined during calibration is used to calculate the correct measured value and saved in the sensor.

17.2 Terminology

17.2.1 Zero point and slope

Using a mathematical function, the transmitter converts the input signal of the sensor y (raw measured value) to the measured value x . In many cases, this function is a simple linear function with the form $y = a + b \cdot x$.

The linear element "a" is usually equivalent to the zero point and the factor "b" is the slope of the line and is often known as the sensor slope.

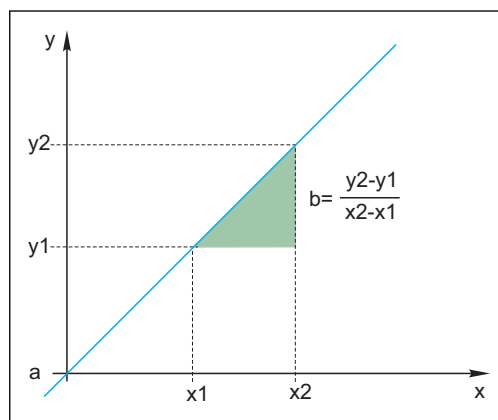

The Nernst equation, which is used to calculate the pH value, is a typical linear relationship:

$$U_i = U_0 - \frac{2.303 RT}{F} \text{pH}$$

pH = $-\lg(a_{\text{H}^+})$, a_{H^+} ... activity of the hydrogen ions

U_i ... raw measured value in mV

U_0 ... zero point (=voltage at pH 7)

R ... universal gas constant (8.3143 J/molK)

T ... temperature [K]

F ... Faraday constant (26.803 Ah/mol)

i The slope of the Nernst equation ($-2.303RT/F$) is known as the **Nernst factor** and has the value -59.16 mV/pH at 25°C (298 K).

17.2.2 Delta slope

The device determines the difference in the slope between the calibration currently valid and the last calibration. Depending on the sensor type, this difference is an indicator of the condition of the sensor. The smaller the slope, the less sensitive the measurement, and the accuracy deteriorates particularly in the low measuring range.

Depending on the operating conditions, users can define limit values that represent the still tolerable absolute values of the slope and/or slope differentials. If the limit values are exceeded, maintenance must be performed on the sensor at the very least. The sensor must be replaced if the insensitivity problems persist after maintenance has been carried out.

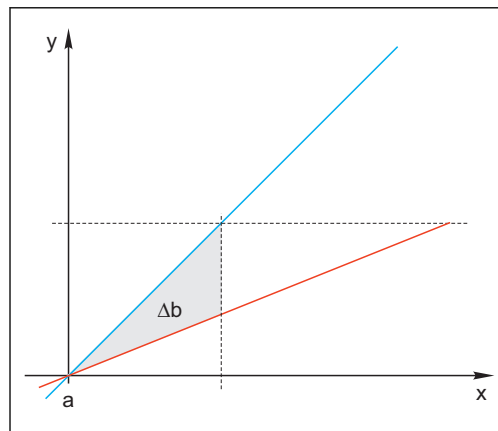

i 29 Delta slope

BU Last calibration

RD Current calibration

Δb Delta slope

17.2.3 Delta zero point

The device determines the difference between the zero points or operating points (ISFET sensor) of the last and second-last calibration. A shift in the zero point or operating point (= offset) does not alter the sensitivity of the measurement. However, if the offset is not corrected this can falsify the measured value.

As with the slope, you can also define and monitor limit values for the offset. If the limit values are exceeded, this means that maintenance must be performed on the sensor. For example, you may have to eliminate a blockage in the reference for the pH sensor.

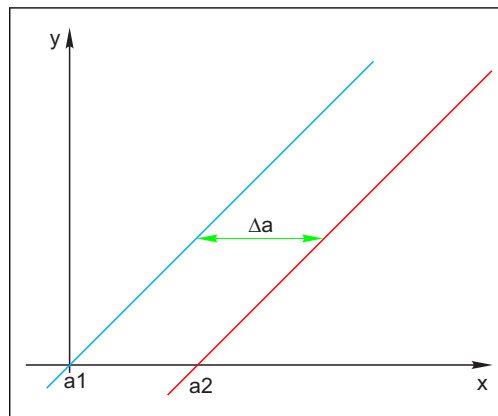

30 Delta zero point/operating point

a1 Zero point/operating point, penultimate calibration

a2 Zero point/operating point, last calibration

Δa Delta zero point/operating point

17.3 Calibration instructions

The following rules apply for all parameters:

1. Calibrate in a way that reflects conditions in the process.
 - If the process medium is constantly moving, also move the calibration solution accordingly (e.g. use a magnetic stirrer if calibrating in the laboratory).
 - If your medium is relatively stationary, calibrate in solutions that are also stationary.
 2. Always make sure that the samples are homogeneous for reference measurements, sample calibration etc.
 3. Avoid changes in the medium samples resulting from ongoing biological activity.

Example: Use outlet water instead of a sample from the aeration basin for nitrate calibration.
 4. Use the same menu settings as those in the process to perform the calibration.

Example: If you automatically compensate for the temperature effect during pH measurement, switch on automatic temperature compensation for the calibration also.
- i** It is advisable to perform the laboratory calibration using the "Memobase Plus" (\rightarrow 190) database software. This improves the availability of your measuring points and all the calibration and sensor data records are stored securely in the database.

17.4 pH sensors

17.4.1 Calibration intervals

The service life of a pH glass electrode is limited. This is due, in part, to the deterioration and aging of the pH-sensitive membrane glass. This aging causes the gel-like layer to change and become thicker over time.

Symptoms of aging include:

- Higher membrane resistance
- Slow response
- Decrease in the slope

A change in the reference system (e.g. due to contamination, i.e. unwanted redox reactions at the reference electrode) or electrolyte solution dissolving away in the reference half cell can change the reference potential, which, in turn, causes a zero point shift in the measuring electrode.

To ensure a high level of accuracy, it is important to readjust the pH sensors at set intervals.

The calibration interval depends heavily on the area of application of the sensor, as well as the required level of accuracy and reproducibility. The calibration interval can vary between daily and once every few months.

Defining the calibration interval for the process

1. Check sensor using a buffer solution, e.g. pH 7.
 - ↳ Proceed as specified in Step 2 only if the value deviates from the set point. No calibration/adjustment is necessary if the value is within the defined deviation tolerance range (→ Technical Information for the sensor).
2. Calibrate and adjust the sensor.
3. After 24 hours, check again with the buffer solution.
 - ↳ a) If the deviation is within the permitted tolerance range, increase the test interval by doubling it, for example.
 - ↳ b) If the deviation is larger, you must shorten the interval.
4. Continue to proceed as defined in Steps 2 and 3 until you have identified the appropriate interval for your sensor.

Monitoring the calibration

- ▶ Define the limit values for monitoring the slope and zero point differences: **Menu/Setup/Inputs/pH/Extended setup/Diagnostics settings/Delta slope** or **Delta zero point (Delta operating point)**.
 - ↳ These limit values depend on the process and must be determined by empirical means.

During calibration a diagnostics message is displayed if the defined warning limits have been exceeded. You then have to service the sensor, e.g. by cleaning the sensor or reference, or by regenerating the glass membrane.

You have to replace the sensor if warning messages continue to be displayed despite the maintenance measure.

Monitoring the calibration interval

You can also allow the device to monitor the calibration intervals for your process.

- ▶ **Menu/Setup/Inputs/pH/Extended setup/Calib. settings/Calib. expiration time**
 - ↳ Set time limits to specify how long a calibration should be regarded as valid. Memosens sensors save all the calibration data. In this way it is easy to see whether the last calibration took place in the specified timeframe and is therefore still valid. This is particularly advantageous when working with precalibrated sensors.

17.4.2 Types of calibration

The following types of calibration are possible:

- Two-point calibration
 - With calibration buffers
- Single-point calibration
 - Entry of an offset or a reference value
 - Sample calibration with laboratory comparative value
- Data entry
 - Entry of the zero point, slope and temperature
- Temperature adjustment by entering a reference value

 With a combined sensor (CPS16D/CPS76D/CPS96D) you have to calibrate both the pH and the ORP electrode in order to obtain reliable rH values.

17.4.3 Two-point calibration

Applications and requirements

Two-point calibration is the preferred method for pH sensors, particularly in the following applications:

- Municipal and industrial wastewater
- Natural waters and drinking water
- Boiler feedwater and condensates
- Beverages

Calibrating with buffers with pH 7.0 and 4.0 is recommended for most applications.

Alkaline buffer solutions have the disadvantage that carbon dioxide from the air can alter the pH value of the buffer on the long term. If calibrating with alkaline buffers it is best to do so in closed systems, such as flow assemblies or retractable assemblies with a rinse chamber, to minimize the effect of air.

 You use calibration buffers to perform two-point calibration. The quality buffers supplied by Endress+Hauser are certified and measured in an accredited laboratory. The accreditation (DAR registration number "DKD-K-52701") confirms that the actual values and the maximum deviations are correct and traceable.

With calibration buffers

To calibrate the sensor, remove it from the medium and calibrate it in the laboratory. Since Memosens sensors save the data, you can always work with "precalibrated" sensors and do not have to stop monitoring the process to perform a calibration.

1. Open the menu: **CAL/pH Glass** or **pH ISFET/2-pnt. calibration**.
2. Follow the instructions of the software.
3. **After** you have immersed the sensor in the first buffer and the measured value has stabilized, press **OK**.
 - ↳ The system starts calculating the measured value for the first buffer. Once the stability criterion is met, the measured value is displayed in mV.
4. Continue to follow the instructions.
5. **After** you have immersed the sensor in the second buffer and the measured value has stabilized, press **OK**.
 - ↳ The system starts calculating the measured value for the second buffer. Once the stability criterion is met, the measured values of the two buffers and the calculated values for the slope and zero point are displayed.
6. Respond to the prompt to accept the calibration data for adjustment.
7. Return the sensor to the medium and press **OK** again.
 - ↳ This deactivates the hold and the system starts measuring again.

You can cancel the calibration any time by pressing **ESC**. No data are then used to adjust the sensor.

 Only use calibration buffers once.

17.4.4 Single-point calibration

Applications and requirements

Single-point calibration is particularly useful if the deviation of the pH value from a reference value, and not the absolute pH value itself, is of interest to the user. Applications for single-point calibration include:

- Process control
- Quality assurance

Fluctuations in the process value should not exceed ± 0.5 pH and the process temperature must remain relatively constant. As the measuring range is limited as a result, it is possible to set the slope to -59 mV/pH (at 25 °C). To adjust the sensor, you enter an offset or a reference value.

Alternatively, you can also use the **Sample calibration**. Here, you take a sample from the process and determine the pH value in the laboratory. In the case of the laboratory sample, you must make sure that the pH value is determined at the process temperature.

Entering a reference value

You enter a previously determined reference measured value. This then shifts the calibration function along the X-axis (pH). The slope is not affected.

1. Open the menu: **CAL/pH Glass** or **pH ISFET/1-pnt. calibration**.
2. **Reference**: Enter previously determined value.
3. Accept the calibration data and then return to the measuring mode.

You can cancel the calibration any time by pressing **ESC**. No data are then used to adjust the sensor.

Sample calibration

With this type of calibration, you take a sample of the medium and determine its pH value (at process temperature) in the laboratory. You then use this laboratory value to adjust the sensor. This does not change the slope of the calibration function.

1. Open the menu: **CAL/pH Glass** or **pH ISFET/Sample calibration**.
2. Follow the instructions of the software.
3. **After** you have taken the sample: Press **OK**.
 - ↳ The following message appears on the display: ► **Sample calibration**.
4. **After** you have determined the laboratory value, press the navigation button.
 - ↳ A line appears where you can enter the laboratory value.
5. Enter the laboratory measured value here and then go to ► **Continue**.
 - ↳ The measured value, laboratory value and the resulting offset (zero point for ISE) are displayed.
6. Accept the calibration data and then return to the measuring mode.

You can cancel the calibration any time by pressing **ESC**. No data are then used to adjust the sensor.

17.4.5 Data entry

You enter the slope, zero point and temperature manually. The function for determining the pH value is calculated from these values. Thus, the data entry returns the same result as two-point calibration.

1. Determine the slope, zero point and temperature in an alternative way (reference measurement).
2. Open the menu: **CAL/pH Glass** or **pH ISFET/Numeric input**.
 - ↳ The slope, zero point and temperature are shown on the display.
3. Select each value one after the other and then enter the desired numerical value.
 - ↳ Since you are entering all the variables for the Nernst equation directly, no additional information is displayed by the software.
4. Respond to the prompt to accept the calibration data for adjustment by selecting **OK**.

You can cancel the calibration any time by pressing **ESC**. No data are then used to adjust the sensor.

17.4.6 Temperature adjustment

1. Determine the temperature of the process medium with an alternative measurement, such as a precision thermometer.
2. Open the menu: **CAL/<Sensor type>/Temperature adjustment**.
3. **Leave the sensor in the process medium** and keep clicking **OK** until temperature measurement is started via the sensor.
4. Enter the reference temperature from the alternative measurement. You can either enter the absolute value or an offset for this purpose.
5. Then keep clicking **OK** until the new data have been accepted.
 - ↳ This completes the temperature adjustment.

17.4.7 Error messages when performing the calibration

Display message	Causes and possible remedial measures
The calibration is invalid. Do you want to start a new calibration? Slope out of tolerance. Zeropoint out of tolerance. Sample concentration too low.	The calibration buffer is contaminated or the pH value is no longer within the permitted limits. As a result, the permitted measured value deviation is exceeded. <ol style="list-style-type: none"> 1. Check the expiry date 2. Use a fresh buffer
The stability criterion is not fulfilled. Do you want to repeat the last step?	The measured value or temperature is not stable. As a result, the stability criterion is not met. <ol style="list-style-type: none"> 1. Keep the temperature constant during calibration. 2. Replace the buffer. 3. Sensor old or contaminated. Clean or regenerate. 4. Adjust stability criteria → 14.
Calibration aborted. Please clean sensor before immersing in process medium. (Hold will be disabled)	The user has aborted the calibration.

17.5 ORP sensors

17.5.1 Types of calibration

The following types of calibration are possible:

- Two-point calibration with medium samples
(Main value = ORP %)
- Single-point calibration with calibration buffer
(Main value = ORP mV)
- Entry of data for an offset
(Main value = ORP mV)
- Temperature adjustment by entering a reference value

17.5.2 Single-point calibration

The buffers contain ORP pairs with a high exchange current density. Such buffers have the advantage of higher accuracy levels, better reproducibility and faster measurement response times.

Temperature compensation does not take place when measuring the ORP since the thermal behavior of the medium is not known. However, the temperature is indicated with the measurement result and for this reason it makes sense to adjust the temperature sensor at process-dependent intervals.

Single-point calibration with calibration buffers

With this type of calibration, you work with calibration buffers, e.g. ORP buffers from Endress+Hauser. For this purpose, you remove the sensor from the medium and calibrate it in the laboratory. Since Memosens sensors save the data, you can always work with "precalibrated" sensors and do not have to stop monitoring the process for extended periods to perform a calibration (does not apply to ISE).

1. Open the menu: **CAL/ORP/1-pnt. calibration.**
2. Follow the instructions of the software.
3. Accept the calibration data and then return to the measuring mode.

You can cancel the calibration any time by pressing **ESC**. No data are then used to adjust the sensor.

17.5.3 Numeric input (offset)

Entry of data for an offset

You enter the offset directly with this type of calibration. Use the measured value of a reference measurement, for example, to determine the offset.

1. Open the menu: **CAL/ORP/Numeric input (offset).**
 - ↳ Display **Offset**.
2. Decide whether you wish to retain the current value or enter a new value.
3. Change value or retain value.
4. Accept the calibration data and then return to the measuring mode.

You can cancel the calibration any time by pressing **ESC**. No data are then used to adjust the sensor.

17.5.4 Two-point calibration (only ORP %)

You must adapt the sensor to your process to obtain useful ORP % values. This is achieved through two-point calibration. The two calibration points are characteristic of the most important states your medium can assume in the process.

You require two different compositions of your medium that represent the characteristic limits of your process (e.g. 20% and 80% value). The absolute value in mV is not relevant for the ORP % measurement.

1. Open the menu: **CAL/ORP/2-pnt. calibration.**
2. Follow the instructions of the software.
3. Determine ORP of medium for the first calibration point.
4. Specify which % value this point represents.
5. ▷ **Continue.**
6. Follow the instructions of the software.
7. Determine ORP of medium for the second calibration point.
8. Specify which % value this point represents.
9. Accept the calibration data and then return to the measuring mode.

You can cancel the calibration any time by pressing **ESC**. No data are then used to adjust the sensor.

17.5.5 Temperature adjustment

1. Determine the temperature of the process medium with an alternative measurement, such as a precision thermometer.
2. Open the menu: **CAL/<Sensor type>/Temperature adjustment.**
3. **Leave the sensor in the process medium** and keep clicking **OK** until temperature measurement is started via the sensor.
4. Enter the reference temperature from the alternative measurement. You can either enter the absolute value or an offset for this purpose.
5. Then keep clicking **OK** until the new data have been accepted.
 - ↳ This completes the temperature adjustment.

17.5.6 Error messages when performing the calibration

Display message	Causes and possible remedial measures
The calibration is invalid. Do you want to start a new calibration?	The calibration buffer is contaminated or the ORP potential is no longer within the permitted limits. As a result, the permitted measured value deviation is exceeded. <ol style="list-style-type: none"> 1. Check the expiry date 2. Use a fresh buffer
The stability criterion is not fulfilled. Do you want to repeat the last step?	The measured value is not stable. As a result, the stability criterion is not met. <ol style="list-style-type: none"> 1. Replace the buffer. 2. Sensor old or contaminated. Clean or regenerate. 3. Adjust stability criteria → 14.
Calibration aborted. Please clean sensor before immersing in process medium. (Hold will be disabled)	The user has aborted the calibration.

17.6 Conductivity sensors

17.6.1 Types of calibration

The following types of calibration are possible:

- Cell constant with calibration solution
- Installation factor
(Only inductive sensors and CLS82D)
- Air set (residual coupling)
(Only inductive sensors)
- Temperature adjustment by entering a reference value

17.6.2 Cell constant

A conductivity measuring system is generally calibrated in such a way that the exact cell constant is determined or checked using suitable calibration solutions.

This process is described in the standards EN 27888 and ASTM D 1125, for example, and the method for producing a number of calibration solutions is explained.

Another alternative is to purchase international calibration standards from national measurement institutes. This is particularly important in the pharmaceutical industry, which requires a calibration to be traced to internationally recognized standards. To calibrate its testing units, the manufacturer, uses special reference material (SRM) from the US National Institute of Standards and Technology (NIST).

Calibrating the cell constant

You enter a reference value for the conductivity with this type of calibration. In addition, you specify how the system should compensate for the influence of temperature. In the result, the device calculates a new cell constant for the sensor.

1. Open the menu: **CAL/Cond c** or **Cond i** or **Cond c 4-pol/Cell constant**.
2. Make the settings:

CAL/Cond c or Cond i or Cond c 4-pol/Cell constant		
Function	Options	Info
Current cell const.	Read only	Value currently saved in the sensor
Temp. compensation	Selection <ul style="list-style-type: none"> ■ Yes ■ No Factory setting Yes	As an alternative to the compensated conductivity (Yes) you can also determine the cell constant by calibrating the uncompensated conductivity (No).
Coeff. Alpha Temp. compensation = Yes	0.00 to 20.00 %/K Factory setting Depends on the sensor	The alpha coefficients and alpha reference temperatures of Endress+Hauser can be found in the documentation supplied with the calibration solutions. ▶ Enter the appropriate values.
Alpha ref. temp. Temp. compensation = Yes	-5.0 to 100.0 °C (23.0 to 212.0 °F) Factory setting 25.0 °C (77.0 °F)	
Temp. source	Selection <ul style="list-style-type: none"> ■ Sensor ■ Manual Factory setting Sensor	Decide how you want to compensate the medium temperature: <ul style="list-style-type: none"> ■ Automatically using the temperature sensor of your sensor ■ Manually by entering the medium temperature

CAL/Cond c or Cond i or Cond c 4-pol/Cell constant		
Function	Options	Info
Medium temperature Temp. source = Manual	-50.0 to 250.0 °C (-58.0 to 482.0 °F) Factory setting 25.0 °C (77.0 °F)	▶ Enter the temperature of your medium.
Conductivity ref.	0.000 to 2000000 µS/cm Factory setting 0.000 µS/cm	Temp. compensation = Yes ▶ Enter the compensated conductivity of your calibration solution here. Temp. compensation = No ▶ Enter the uncompensated conductivity of your calibration solution here.

3. ▶ Start calibration.
4. Follow the instructions.
5. Decide whether to use the calibration data captured, or to abort or repeat the calibration.

After calibration, the transmitter automatically switches back to the measuring mode and your measuring point is now ready for operation.

17.6.3 Air set (residual coupling, only inductive sensors)

While the calibration line goes through zero for physical reasons in the case of conductive sensors (a current flow of 0 corresponds to a conductivity of 0), when working with inductive sensors, the residual coupling between the primary coil (transmitter coil) and secondary coil (receiver coil) must be taken into account or compensated for. The residual coupling is not only caused by the direct magnetic coupling of the coils but also by crosstalk in the supply cables. For this reason, the process of commissioning an inductive sensor always starts with an "air set". Here, the sensor is connected to the transmitter with the cables provided, held in air in a dry state (zero conductivity) and an air set calibration is performed at the transmitter.

The cell constant is then determined using a precise calibration solution, as is the case with conductive sensors.

 Sensors with a Memosens protocol are already calibrated at the factory and their residual coupling generally does not have to be adjusted on site.

17.6.4 Installation factor (only inductive sensors and CLS82D)

In confined installation conditions, the conductivity measurement is affected by the pipe walls. The installation factor compensates for this effect. The transmitter corrects the cell constant by multiplying by the installation factor. The value of the installation factor depends on the diameter and the conductivity of the pipe nozzle as well as the sensor's distance to the wall.

If there is a sufficient distance between the wall and the sensor, the installation factor f does not have to be taken into consideration (f = 1.00). If the distance to the wall is smaller, the installation factor increases for electrically insulating pipes (f > 1) and decreases for electrically conductive pipes (f < 1).

There are two ways to compensate the installation factor:

- Determine the installation factor using calibration solutions
- Enter a known installation factor

Calibrating the installation factor

1. Open the menu: CAL/Cond i or Cond c 4-pol/Inst. factor/Calibration.
2. Make the settings:

CAL/Cond i or Cond c 4-pol/Inst. factor/Calibration		
Function	Options	Info
Current cell const.	Read only	Value currently saved in the sensor
Temp. compensation	Selection <ul style="list-style-type: none"> ▪ Yes ▪ No Factory setting Yes	As an alternative to the compensated conductivity (Yes) you can also determine the cell constant by calibrating the uncompensated conductivity (No).
Coeff. Alpha Temp. compensation = Yes	0.00 to 20.00 %/K Factory setting Depends on the sensor	The alpha coefficients and alpha reference temperatures of Endress+Hauser can be found in the documentation supplied with the calibration solutions.
Alpha ref. temp. Temp. compensation = Yes	-5.0 to 100.0 °C (23.0 to 212.0 °F) Factory setting 25.0 °C (77.0 °F)	<ul style="list-style-type: none"> ▶ Enter the appropriate values.
Temp. source	Selection <ul style="list-style-type: none"> ▪ Sensor ▪ Manual Factory setting Sensor	Decide how you want to compensate the medium temperature: <ul style="list-style-type: none"> ▪ Automatically using the temperature sensor of your sensor ▪ Manually by entering the medium temperature
Medium temperature Temp. source = Manual	-50.0 to 250.0 °C (-58.0 to 482.0 °F) Factory setting 25.0 °C (77.0 °F)	<ul style="list-style-type: none"> ▶ Enter the temperature of your medium.
Conductivity ref.	0.000 to 2000000 µS/cm Factory setting 0.000 µS/cm	Temp. compensation = Yes <ul style="list-style-type: none"> ▶ Enter the compensated conductivity of your calibration solution here. Temp. compensation = No <ul style="list-style-type: none"> ▶ Enter the uncompensated conductivity of your calibration solution here.

3. ▷ **Start calibration.**
4. Follow the instructions.
5. Decide whether to use the calibration data captured, or to abort or repeat the calibration.

You can cancel the calibration any time by pressing **ESC**. No data are then used to adjust the sensor.

Entering the installation factor

1. Open the menu: **CAL/Cond i** or **Cond c 4-pol/Inst. factor/Entry**.
 - ↳ The installation factor currently used is displayed.
2. **New inst. factor:** Enter the installation factor which you took from the Operating Instructions for your sensor, for example.
3. ▷ **Start calibration.**
4. Decide whether to use the calibration data captured, or to abort or repeat the calibration.

You can cancel the calibration any time by pressing **ESC**. No data are then used to adjust the sensor.

17.6.5 Temperature adjustment

1. Determine the temperature of the process medium with an alternative measurement, such as a precision thermometer.
2. Open the menu: **CAL/Cond c** or **Cond i** or **Cond c 4-pol/Temperature adjustment**.
 - ↳ The offset (of the last calibration) and the actual temperature value are shown on the display.
3. **Mode:** Decide on the mode of temperature adjustment.
 - **1-point calibration**
You measure the medium temperature with a reference measurement and use this value to adjust the temperature sensor.
 - **2-point calibration**
You use two samples of different temperatures.
 - **Table**
Adjustment based on data entries. You enter value pairs comprising the measured temperature of the temperature sensor and the related reference temperature. The temperature function is calculated from these value pairs. Press **SAVE** once you have entered all the points and select **OK**.
4. Follow the instructions of the software.
5. Accept the calibration data and then return to the measuring mode.

You can cancel the calibration any time by pressing **ESC**. No data are then used to adjust the sensor.

17.6.6 Error messages when performing the calibration

Display message	Causes and possible remedial measures
The calibration is invalid. Do you want to start a new calibration?	Calibration solution exhausted. As a result, the permitted measured value deviation is exceeded. <ol style="list-style-type: none"> 1. Check the expiry date 2. Use a fresh calibration solution
Currently no calibration possible due to sensor failure.	Sensor communication problem <ol style="list-style-type: none"> 1. Replace sensor. 2. Contact the Service Department.
Calibration aborted. Please clean sensor before immersing in process medium. (Hold will be disabled)	The user has aborted the calibration.

17.7 Oxygen sensors

17.7.1 Signal generation with amperometric sensors

The amperometric oxygen sensor is based on the reduction of oxygen at the noble metal cathode of a system filled with electrolyte.

Oxygen coming from the medium (e.g. air) diffuses through a membrane into the electrolyte film and is reduced at the cathode. This means that there is practically no molecular oxygen at the cathode. Intense oxygen consumption takes place here and the oxygen partial pressure approaches zero.

The oxygen partial pressure of the medium is present in front of the membrane. This pressure is approx. 209 hPa in water vapor-saturated air under reference conditions (1013 hPa, 20°C). The partial pressure acts as the driving force to transport oxygen molecules

through the membrane. The membrane acts as a diffusion barrier, i.e. oxygen molecules permeate the membrane depending on the difference in partial pressure.

In summary, an amperometric oxygen sensor has two important features:

- The rate of oxygen consumption at the cathode is extremely high. Oxygen permeates the membrane depending on the external oxygen partial pressure (the internal pressure is practically zero) - the external oxygen partial pressure is the driving force.
- Due to the diffusion-inhibiting properties of the membrane, the flow of oxygen through the membrane and thus the electric signal current subsequently generated is in direct proportion to the oxygen partial pressure in front of the membrane, i.e. the sensor provides a linear signal current that depends on the oxygen partial pressure.

→ The amperometric oxygen sensor is therefore an oxygen partial pressure sensor.

17.7.2 Signal generation with optical sensors

The optical oxygen sensor is based on the principle of fluorescence quenching.

The basic concept is as follows:

The medium to be measured and the sensor optics are separated by an area that is sensitive to oxygen, known as the sensor spot.

Towards the process this sensor spot is protected against pressure, temperature and other influences of medium by a black covering that is permeable to oxygen. This covering therefore allows the oxygen that is present in the medium to diffuse into the sensor spot, based on the equilibrium of the oxygen partial pressure in the medium.

The sensor optics direct light at a constant wavelength A or color A onto the sensor spot containing a fluorescent dye (stimulation). As a result of this stimulation, the molecules of the dye emit a light at a constant wavelength B or color B (response).

The oxygen in the medium and therefore in the sensor spot changes the fluorescence properties of the dye. This process is known as quenching.

The relation between the stimulation and response therefore depends on the oxygen partial pressure in the medium, and is used in the sensor for measurement purposes. From a technical perspective, the concentration of oxygen is often calculated based on the relation of the signals over time (also known as the phase angle).

17.7.3 Calibration intervals

Specifying the intervals

If you want to calibrate the sensor intermittently for a special application and/or on account of a special type of installation, you can calculate the intervals using the following method:

1. Remove the sensor from the medium.
2. Clean the outside of the sensor with a damp cloth.
3. Then dry the sensor diaphragm carefully with a soft paper towel for example.
4. **NOTICE**

Incorrect measurements caused by atmospheric influences!

- ▶ Protect the sensor against external influences such as sunlight and wind.

After 20 minutes (amperometric sensors) or 10 minutes (optical sensors), measure the oxygen saturation index in air.

5. Decide using the results:

a) Amperometric sensor: Measured value is **not** 102 ± 2 %SAT (COS51D) or 100 ± 2 %SAT (COS22D) → Calibrate sensor.

Optical sensor: Measured value is **not** 100 ± 2 %SAT → Calibrate sensor.

b) If the values are within the interval specified, you do not need to calibrate the sensor. Extend the period until the next inspection.

6. Repeat the steps specified after two, four or eight months to determine the optimum calibration interval for your sensor.

Monitoring the calibration

- ▶ Define the limit values for monitoring the slope and zero point differences: **Menu/Setup/Inputs/Oxygen (amp.)** or **Oxygen (opt.)/Extended setup/Diagnostics settings/Delta slope** or **Delta zero point** (amperometric sensors or COS61D) or **Calibration quality index** (COS81D).
 - ↳ These limit values depend on the process and must be determined by empirical means.

During calibration a diagnostics message is displayed if the defined warning limits have been exceeded. You then have to service the sensor by cleaning the sensor or reference, or by regenerating the glass membrane.

You have to replace the sensor if warning messages continue to be displayed despite the maintenance measure.

Monitoring the calibration interval

Once you have established the calibration intervals for your process, you can also have the device monitor them.

- ▶ **Menu/Setup/Inputs/Oxygen (amp.)** or **Oxygen (opt.)/Extended setup/Calib. settings/Calib. expiration time**
 - ↳ Set time limits to specify how long a calibration should be regarded as valid. Memosens sensors save all the calibration data. In this way it is easy to see whether the last calibration took place in the specified timeframe and is therefore still valid. This is particularly advantageous when working with precalibrated sensors.

17.7.4 Types of calibration

The following types of calibration are possible:

- **Zero point**
 - **1-point cal.** (Single-point calibration in nitrogen or COY8 zero-point gel)
 - **Numeric input**
- **Slope** (amperometric sensors and COS61D) or **Point at oxygen** (COS81D)
 - **Air 100% rh** (Air, water vapor-saturated)
 - **H2O air-saturated** (Air-saturated water)
 - **Air variable** (Air, variable)
 - **Test gas calibration** (COS81D only)
 - **Numeric input**
- **Sample calibration**
 - **Slope** (only amperometric sensors and COS61D)
 - **Point at oxygen** (only COS81D)
 - **Zero point** (amperometric sensors only)
- **Fermenter scaling** (only COS81D)
- **Temperature adjustment**

Furthermore, the calibration menu for amperometric sensors and COS81D contains two additional functions to reset the sensor's internal counters:

- **Change electrolyte** (amperometric sensors only)
- **Change sensor cap** (amperometric sensors and COS81D)
- **Reset to factory calibration** (only COS81D)

17.7.5 Slope calibration (COS22D, COS51D, COS61D) or point at oxygen (COS81D)

In the case of slope calibration, the dependency on partial pressure is used to compare the signal current to a known and readily available reference – air.

The composition of dry air is known:

- 20.95 % oxygen
- 79.05 % nitrogen and other gases

Altitude and partial pressure

The oxygen partial pressure otherwise only depends on the altitude or the current absolute air pressure.

At an air pressure of 1013 hPa at sea level, the oxygen partial pressure is approximately 212 hPa. The absolute pressure and thus also the oxygen partial pressure change depending on the altitude. Using the barometric formula, the expected oxygen partial pressure can be calculated with only marginal errors up to a height of several kilometers. As a result, calibration is independent of the altitude.

Three methods for obtaining reliable values for the absolute pressure of air

1. Using the altitude and the barometric formula which provide the correlation between the expected value for the average absolute air pressure and the altitude (also saved and accessible in the transmitter or sensor).
2. By measuring the absolute pressure of air with a pressure cell, for example.
3. The relative air pressure reduced to sea level is often available from weather reports. This relative air pressure can be converted to the absolute value using the barometric formula.

Water vapor

In reality, water in the form of water vapor is also always present in air. This is a contributing factor to the total pressure. This means that the water vapor in the air changes the oxygen partial pressure.

However, air can only hold a specific maximum volume of water. The rest is given off as condensate in liquid form (e.g. drops). The maximum amount of water vapor in air depends on the temperature and follows known functions.

Air 100% rh

In this calibration model, the percentage of water vapor is deducted on the basis of the altitude and temperature so that information is available on the oxygen partial pressure actually present.

For this model to work correctly, the sensor to be calibrated must be close to a water surface or be located in the headspace of a vessel partially filled with water. In this way, oxygen sensors can be precisely calibrated in a wide variety of applications, ranging from power stations to water treatment.

H₂O air-saturated

After an adequate amount of time, water which has been aerated sufficiently is in equilibrium with the oxygen partial pressure of the air above the water. This calibration model uses this property.

Here too, the model uses the temperature value to automatically reference back to the expected oxygen partial pressures. This model is often used to measure oxygen in closed tanks, such as fermenters filled with water.

Air variable

This calibration model is for all applications in which the air pressure and air humidity in the vicinity of the sensor do not correspond to the standard atmospheric values previously mentioned, but are still known. Both variables can be specified here.

The model is used, for example, for installed sensors that should be calibrated in operation at known conditions, such as in dry rinse air at 1020 hPa.

Test gas calibration (only COS81D)

This calibration model allows the user to calibrate the slope of the sensor using a defined oxygen gas mixture. Traceable calibration can be performed in conjunction with an absolute pressure measurement (to determine the gas pressure at the sensor membrane) and a certified calibration gas. The reference variable in oxygen volume concentration and the gas pressure are entered here as input variables in the transmitter. The model assumes a dry gas mixture with 0% humidity.

Sample calibration

Sample calibration is another calibration option. Here, the measured value of the sensor is adjusted to a reference, obtained externally, of the same medium.

Calibrating the sensor in the media mentioned

The calibration procedure is identical regardless of whether you are calibrating in water vapor-saturated air, air-saturated water or variable air:

1. Open the menu: **CAL/Oxygen (amp.)** or **Oxygen (opt.)/Slope** or **Point at oxygen**.
2. Choose from the following: **Air 100% rh** or **H2O air-saturated** or **Air variable** or **Test gas calibration** (COS81D only) or **Sample calibration**.
3. Follow the instructions of the software.
4. Accept the calibration data and then return to the measuring mode.

You can cancel the calibration any time by pressing **ESC**. No data are then used to adjust the sensor.

Calibrating the sensor by data entry

1. Open the menu: **CAL/Oxygen (amp.)** or **Oxygen (opt.)/Slope/Numeric input**.
2. **New slope**: Enter value.
3. Respond to the prompt to accept the calibration data for adjustment by selecting **OK**.
↳ The new slope is used.

17.7.6 Zero point calibration

The zero point is not so important when working with relatively high concentrations of oxygen.

This situation changes, however, as soon as oxygen sensors are used in the trace range and calibration should be performed in the zero point. Zero point calibrations are demanding as the ambient medium - usually air - already has a high oxygen content. This oxygen must be excluded for the zero point calibration of the sensor and existing residual oxygen must be eliminated from the sensor environment.

There are two preferred methods of doing so:

1. Calibration of the zero point in a flow assembly that has been rinsed with gaseous nitrogen of acceptable quality (N5).
2. The calibration in oxygen-depleting zero point gel.

Alternatively you can also adjust the zero point via data entry. You require a reference measured value for this.

Prior to sensor zero point calibration

- Has the sensor signal settled and is it steady?
- Is the value displayed plausible?

If the oxygen sensor is calibrated too early, this can result in an incorrect zero point.

As a general rule, operate the sensor in a zero point gel for 0.5 hours and then assess the signal current in the steady state. If the sensor was already operated in the trace range before the zero point calibration, the time specified above generally suffices. If the sensor was operated in air, significantly more time must be factored in to also remove residual oxygen from any dead volume inherent to the design. Here a value of 2 hours applies as a general rule.

The zero point can be calibrated as soon as the sensor signal has settled. Here, the current measured value is calibrated to the zero value. The reference method (sample calibration in zero point) can also be used here if appropriate collecting vessels or reference measurement are available.

Zero point calibration with zero point gel

As an alternative to the zero point gel, you can also work in an atmosphere that is free from oxygen, such as high-purity nitrogen.

1. Open the menu: **CAL/Oxygen (amp.)** or **Oxygen (opt.)/Zero point**.
2. ▷ **1-point cal.**
3. Immerse the sensor in **zero-point gel** or hold it in **nitrogen** (not in air!).
4. ▷ **Start calibration**.
5. Decide whether to use the calibration data captured, or to abort or repeat the calibration.
6. Clean the sensor and then place it back in the medium.

You can cancel the calibration any time by pressing **ESC**. No data are then used to adjust the sensor.

Calibrating the sensor by data entry

You can calibrate the zero point by entering a percentage offset. To do this, determine the zero point by comparing with a reference measurement.

1. Open the menu: **CAL/Oxygen (amp.)** or **Oxygen (opt.)/Zero point/▷ Numeric input**.
2. **New zeropoint**: Enter value.
3. ▷ **Accept calibration data**.
 - ↳ The new zero point is used.

17.7.7 Sample calibration

Calibration is possible both in the medium (in the process or in the laboratory) and in air.

For this purpose, you measure the raw oxygen value using a reference measurement. You use this reference value to adjust the sensor.

You can either calibrate the slope or the zero point with the reference value.

1. Open the menu: **CAL/Oxygen (amp.)** or **Oxygen (opt.)/Sample calibration**.
2. Choose from the following: **Slope** or **Zero point** (amperometric sensor only).
 - ↳ Use the calibration of the zero point if you want to align the measurement with another measurement. You can correct the sensitivity of your measurement with the slope calibration.
3. Follow the instructions of the software.
 - ↳ The current measured value is displayed.
4. **Reference** Enter the comparative value from the external measurement.
5. ▷ **Continue**.
6. ▷ **Accept calibration data**.
 - ↳ Sample calibration is completed.
7. If you have performed the calibration in the laboratory, clean the sensor and then immerse it in the medium again.

You can cancel the calibration any time by pressing **ESC**. No data are then used to adjust the sensor.

17.7.8 Fermenter scaling

As a general rule, overpressure is present in a fermenter before fermentation begins. In addition, the sensor was subjected to stress in the form of sterilization in place (SIP).

Using the **Fermenter scaling** method, the measured value of the installed sensor is adjusted to match your preferred start value in %SAT.

You determine the set point of the saturation (**Required saturation**) to which the measured saturation should correspond (100 %SAT generally). This results in a factor for the calibration function (**Scaling factor**). In the menu, select the saturation index as primary value and you will then see the scaled saturation index in the measured value display.

1. Open the menu: **CAL/Oxygen (opt.)/Fermenter scaling**.
2. ▷ **Activate**.
3. Respond to the prompt by selecting **OK**.
 - ↳ The current measured saturation (**Current saturation**) is displayed.
4. **Required saturation**: Specify the saturation to which this value should correspond.
5. ▷ **Continue**.
 - ↳ The scaling factor is calculated and displayed (**Scaling factor**).
6. Respond to the prompt by selecting **OK**.

If you no longer wish to use fermenter scaling, deactivate the function in the calibration menu.

17.7.9 Reset counters

These functions do not adjust the sensor, but reset the sensor's internal counters to "0".

 The counters can be used to set warning limits and alarm limits for changing the membrane cap (fluorescence cap) or the electrolyte (amperometric sensors only). This ensures that exhausted caps and electrolyte are replaced in time.

Reset the counters to "0" after replacing the cap or electrolyte.

1. Select the desired action: ▷ **Change sensor cap** or ▷ **Change electrolyte**.
2. Respond to query: ▷ **Save**.
 - ↳ The sensor's internal counter is reset.

17.7.10 Temperature adjustment

1. Determine the temperature of the process medium with an alternative measurement, such as a precision thermometer.
2. Open the menu: **CAL/<Sensor type>/Temperature adjustment**.
3. **Leave the sensor in the process medium** and keep clicking **OK** until temperature measurement is started via the sensor.
4. Enter the reference temperature from the alternative measurement. You can either enter the absolute value or an offset for this purpose.
5. Then keep clicking **OK** until the new data have been accepted.
 - ↳ This completes the temperature adjustment.

17.7.11 Error messages when performing the calibration

Display message	Causes and possible remedial measures
The calibration is invalid. The range was overrun. Do you want repeat the last step?	Sensor contaminated or zero point gel used up. As a result, the permitted limit values for the zero point are exceeded. <ol style="list-style-type: none"> 1. Clean sensor 2. Renew the zero point gel 3. Repeat calibration
The stability criterion is not fulfilled. Do you want to repeat the last step?	The measured value is not stable. As a result, the stability criterion is not met. <ol style="list-style-type: none"> 1. Replace exhausted electrolyte and/or sensor cap 2. Adjust stability criteria → 43.
Storage of the data failed. Do you want to retry?	<i>Optical fixed cable sensor only</i> The calibration data could not be stored in the sensor <ol style="list-style-type: none"> 1. Check the sensor connection 2. Repeat calibration
Calibration aborted. Please clean sensor before immersing in process medium. (Hold will be disabled)	The user has aborted the calibration.

17.8 Disinfection sensors

17.8.1 Calibration intervals

The calibration intervals depend greatly on:

- The application
- The installation position of the sensor

Specifying the intervals

If you want to calibrate the sensor intermittently for a special application and/or on account of a special type of installation, you can calculate the intervals using the following method:

1. Check the sensor three months (in the case of drinking water) or one month (in the case of process water) after commissioning using a reference measured value (DPD method) of a medium sample.
2. Compare the sensor measured value to the reference measured value.
3. Depending on your requirements, decide whether the deviation is acceptable or whether the sensor should be recalibrated.

Make sure to calibrate the sensor at least twice a year.

 Please note that the DPD method itself is susceptible to high measured errors when the measured values are very low (< 0.2 mg/l) and can then no longer be regarded as a reliable method.

Monitoring the calibration

- ▶ Define the limit values for monitoring the slope and zero point differences: **Menu/Setup/Inputs/Disinfection /Extended setup/Diagnostics settings/Delta slope or Delta zero point.**
 - ↳ These limit values depend on the process and must be determined by empirical means.

During calibration a diagnostics message is displayed if the defined warning limits have been exceeded. You then have to service the sensor by cleaning the sensor or reference, or by regenerating the glass membrane.

You have to replace the sensor if warning messages continue to be displayed despite the maintenance measure.

Monitoring the calibration interval

Once you have established the calibration intervals for your process, you can also have the device monitor them.

► Menu/Setup/Inputs/Disinfection/Extended setup/Calib. settings/ Calib. expiration time

- ↳ Set time limits to specify how long a calibration should be regarded as valid. Memosens sensors save all the calibration data. In this way it is easy to see whether the last calibration took place in the specified timeframe and is therefore still valid. This is particularly advantageous when working with precalibrated sensors.

17.8.2 Polarization

The voltage applied between cathode and anode by the transmitter polarizes the surface of the working electrode. Therefore, after switching on the transmitter with the sensor connected, you must wait until the polarization period has elapsed before starting calibration.

To achieve a stable display value, the sensor requires the following polarization periods:

First commissioning

Sensor for standard measuring range	60 min.
Sensor for trace measuring range	90 min.

Recommissioning

Sensor for standard measuring range	30 min.
Sensor for trace measuring range	45 min.

17.8.3 Types of calibration

The following types of calibration are possible:

- Slope
 - Sample calibration
 - Data entry
- Zero point
 - Sample calibration
 - Data entry
- Temperature adjustment

Furthermore, the calibration menu contains additional functions to reset the sensor's internal counters:

- Change electrolyte
- Change sensor cap
- Reset to factory settings of the sensor channel

17.8.4 Reference measurement

Reference measurement according to the DPD method

To calibrate the measuring system, carry out a colorimetric comparison measurement in accordance with the DPD method. Chlorine as well as chlorine dioxide react with diethyl-p-phenylenediamine (DPD) and turn red. The intensity of the red coloration is proportional to the chlorine content.

This red coloration is measured with a photometer (e.g. CCM182) and indicated as the chlorine content.

Prerequisites

The sensor reading is stable (no drifts or unsteady values for at least 5 minutes). This is normally guaranteed once the following preconditions have been met:

- The polarization period has elapsed.
- The flow is constant and within the correct range.
- The sensor and the medium are at the same temperature.
- The pH value is within the permitted range.

17.8.5 Slope calibration

You can correct the sensitivity of your measurement with the slope calibration.

Sample calibration

Measure the raw chlorine value using a reference measurement. You use this reference value to adjust the sensor.

1. Open the menu: **CAL/Disinfection/Slope**.
2. ▷ **Sample calibration**.
3. **Follow** the software instructions.
4. Choose between the following: ▷ **Continue calibration** or **Back to measurement (finish cal. later)**.
5. **Nominal value**: Enter the reference value.
6. ▷ **Accept calibration data**.
7. Accept the calibration data and then return to the measuring mode.

You can cancel the calibration any time by pressing **ESC**. No data are then used to adjust the sensor.

Data entry

Measure the raw chlorine value using a reference measurement. You use this reference value to adjust the sensor.

1. Open the menu: **CAL/Disinfection/Slope**.
2. ▷ **Numeric input**.
3. **New abs. slope** or **New rel. slope**: Enter value.
 - ↳ The other value is calculated by the device.
4. ▷ **Accept calibration data**.
5. Accept the calibration data and then return to the measuring mode.

You can cancel the calibration any time by pressing **ESC**. No data are then used to adjust the sensor.

17.8.6 Zero point calibration

Zero point calibration is particularly important if measurements are to be compared to one another, or in the event of measurements near the zero point.

A zero point shift in amperometric sensors is primarily caused by fouling on the cathode. The special mechanical construction of the sensor with the membrane cap and electrolyte almost completely eliminates such fouling.

Sample calibration

Measure the raw chlorine value using a reference measurement. You use this reference value to adjust the sensor.

1. Open the menu: **CAL/Disinfection/Zero point**.
2. ▷ **Sample calibration**.
3. **Follow** the software instructions.
4. Choose between the following: ▷ **Continue calibration** or **Back to measurement (finish cal. later)**.
5. **Nominal value**: Enter reference value.
6. ▷ **Accept calibration data**.
7. Accept the calibration data and then return to the measuring mode.

You can cancel the calibration any time by pressing **ESC**. No data are then used to adjust the sensor.

Data entry

Measure the raw chlorine value using a reference measurement. You use this reference value to adjust the sensor.

1. Open the menu: **CAL/Disinfection/Zero point**.
2. ▷ **Numeric input**.
3. **New zero point**: Enter value.
4. ▷ **Accept calibration data**.
5. Accept the calibration data and then return to the measuring mode.

You can cancel the calibration any time by pressing **ESC**. No data are then used to adjust the sensor.

17.8.7 Reset counters

These functions do not adjust the sensor, but reset the sensor's internal counters to "0".

 The counter for sensor cap calibrations is used to set warning limits and alarm limits for changing the cap. This ensures that exhausted membrane caps are replaced in time.

Reset the counters to "0" after replacing the cap or electrolyte.

1. Select the desired action: **Change electrolyte** or **Change sensor cap and electrolyte**.
2. Respond to query: ▷ **Save**.
 - ↳ The sensor's internal counter is reset.

17.8.8 Error messages when performing the calibration

Display message	Causes and possible remedial measures
The calibration is invalid. Do you want to start a new calibration?	Sensor contaminated. As a result, the permitted limit values for the zero point are exceeded. <ol style="list-style-type: none"> 1. Clean sensor 2. Repeat calibration
The stability criterion is not fulfilled. Do you want to repeat the last step?	The measured value is not stable. As a result, the stability criterion is not met. <ol style="list-style-type: none"> 1. Replace exhausted electrolyte and/or sensor cap 2. Adjust stability criteria → 57.
Calibration aborted. Please clean sensor before immersing in process medium. (Hold will be disabled)	The user has aborted the calibration.

17.9 Ion-selective sensors

Some measured values from other electrodes or sensors are used for measured value compensation of ion-selective electrodes:

- Measured value of temperature sensor for temperature compensation
- pH measured value for pH compensation of ammonium (optional)
- Potassium or chloride measured value for compensation of interference ions in the case of ammonium or nitrate (optional)

For this reason, there is a sequence for calibration and adjustment that must be followed in order to achieve a reliable measurement:

1. Temperature adjustment
2. Calibration and adjustment of pH electrode
3. If compensation electrodes are used:
Calibration and adjustment of ion-selective compensation electrodes (potassium, chloride)
4. If no compensation electrodes are used:
A correct manual offset is configured for the ammonium and nitrate electrode
5. Calibration and adjustment of ion-selective measuring electrodes (ammonium, nitrate)

17.9.1 Types of calibration

The following types of calibration are possible:

- pH electrode:
 - Two-point calibration
 - Single-point calibration
- Ion-selective electrodes:
 - Single-point calibration
 - Data entry
 - Two-point calibration
 - Standard addition ("Expert" user role only)
 - Sample calibration ("Expert" user role only)
- ORP sensor:
 - Single-point calibration
- Temperature adjustment by entering a reference value

17.9.2 pH sensor

Two-point calibration

 You use calibration buffers to perform two-point calibration. The quality buffers supplied by Endress+Hauser are certified and measured in an accredited laboratory. The accreditation (DAR registration number "DKD-K-52701") confirms that the actual values and the maximum deviations are correct and traceable.

1. Open the menu: **CAL/ISE/2-pnt. calibration**.
2. Select the pH sensor and **▷ Start calibration**.
3. Follow the instructions of the software.
4. **After** you have immersed the sensor in the first buffer and the measured value has stabilized, press **OK**.
 - ↳ The system starts calculating the measured value for the first buffer. Once the stability criterion is met, the measured value is displayed in mV.
5. Continue to follow the instructions.
6. **After** you have immersed the sensor in the second buffer and the measured value has stabilized, press **OK**.
 - ↳ The system starts calculating the measured value for the second buffer. Once the stability criterion is met, the measured values of the two buffers and the calculated values for the slope and zero point are displayed.
7. Respond to the prompt to accept the calibration data for adjustment by selecting **Yes**.
8. Return the sensor to the medium and press **OK** again.
 - ↳ This deactivates the hold and the system starts measuring again.

You can cancel the calibration any time by pressing **ESC**. No data are then used to adjust the sensor.

 Only use calibration buffers once.

Single-point calibration

1. Open the menu: **CAL/ISE/1-pnt. calibration**.
2. Select the pH sensor and **▷ Start calibration**.
 - ↳ A question is displayed: **Do you know the measured value of the reference medium?**
3. Respond by selecting **▷ Yes**.
4. **Reference value:** Enter the value of the buffer.
5. Follow the software instructions, and immerse the sensor in the buffer.
6. **▷ Continue**.
7. **OK:** Start calibration.
 - ↳ The system starts calculating the measured value for the buffer. Once the stability criterion is met, the measured value is displayed in mV.
8. Respond to the prompt to accept the calibration data for adjustment by selecting **Yes**.
9. Return the sensor to the medium and press **OK** again.
 - ↳ This deactivates the hold and the system starts measuring again.

You can cancel the calibration any time by pressing **ESC**. No data are then used to adjust the sensor.

 Only use calibration buffers once.

17.9.3 Ammonium, nitrate, potassium, chloride

In the case of potentiometric methods to determine the ion concentration, the voltage supplied by the electrochemical measuring cell (comprising the ion-selective electrode and a reference electrode), is proportional to the logarithm of the concentration (or activity) of the ions under analysis within the "linear" or preferably "NERNST" range (→ 31, red arrow). The slope and zero point calibration parameters refer to this logarithmic relationship, which gives these parameters a completely different meaning in this measurement method compared with other measurement methods.

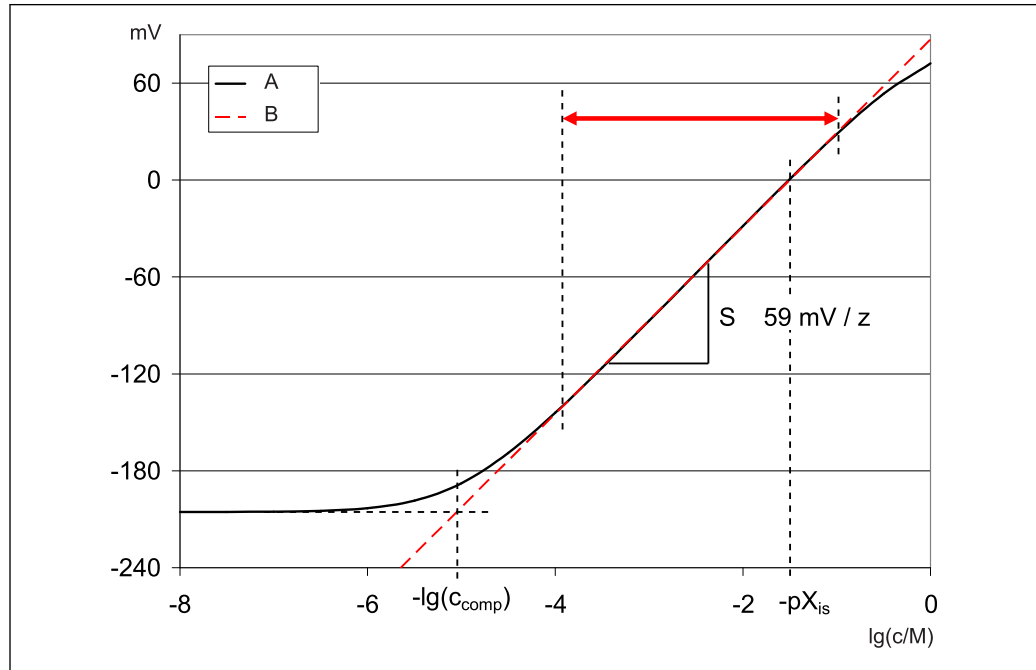

31 The measuring signal of ion-selective electrodes depends on the concentration

- A Real curve
B Ideal curve

Within this range, the following applies for the correlation between the logarithm of the concentration and the measured voltage:

$$E = E_0 + S \cdot \log \left\{ \frac{c}{1 \text{ mol/l}} \right\}$$

- E ... measured voltage
E₀ ... voltage at concentration of 1 mol/l
S ... slope of electrode in mV/mol

Single-point calibration

You use a calibration solution with a known concentration.

1. Open the menu: **CAL/ISE/1-pnt. calibration.**
2. Select the electrode to be calibrated and ▷ **Start calibration.**
↳ A question is displayed: **Do you know the measured value of the reference medium?**
3. Respond by selecting ▷ **Yes.**
4. **Reference value:** Enter the value of the buffer.

5. Follow the software instructions, and immerse the sensor in the buffer.
-  During the calibration, move the sensor in the tank to ensure the necessary flow of medium to the ion-selective electrode.
6. ▷ **Continue**.
7. **OK**: Start calibration.
 - ↳ The system starts calculating the measured value for the buffer. Once the stability criterion is met, the measured value is displayed in mV.
8. Respond to the prompt to accept the calibration data for adjustment by selecting **Yes**.
9. Return the sensor to the medium and press **OK** again.
 - ↳ This deactivates the hold and the system starts measuring again.

You can cancel the calibration any time by pressing **ESC**. No data are then used to adjust the sensor.

Two-point calibration

Remove the sensor from the medium for calibration.

1. Open the menu: **CAL/ISE/2-pnt. calibration**.
2. Select the electrode to be calibrated and ▷ **Start calibration**.
3. Follow the instructions of the software.
4. Immerse the sensor in the first calibration solution and, once the measured value has stabilized, press **OK**.
 - ↳ The sensor starts calculating the measured value. Once the stability criterion is met, the measured value is displayed.
5. Continue to follow the instructions.
6. Immerse the sensor in the second calibration solution and, once the measured value has stabilized, press **OK**.
 - ↳ The sensor starts calculating the measured value. Once the stability criterion is met, the measured values of the two calibration solutions and the calculated values for the slope and zero point are displayed.
7. Respond to the prompt to accept the calibration data for adjustment by selecting **Yes**.
8. Return the sensor to the medium and press **OK** again.
 - ↳ This deactivates the hold and the system starts measuring again.

You can cancel the calibration any time by pressing **ESC**. No data are then used to adjust the sensor.

Data entry

You enter the slope and zero point manually. The calibration function is calculated from these values. Thus, the data entry returns the same result as two-point calibration. You must determine the slope and zero point in an alternative way.

1. Open the menu: **CAL/ISE/Numeric input**.
2. Select the electrode to be calibrated and ▷ **Start calibration**.
 - ↳ The slope and zero point are shown on the display.
3. Select each value one after the other and enter value.
4. Then ▷ **Accept calibration data**.
 - ↳ Since you are entering all the variables directly, no additional information is displayed by the controller.

You can cancel the calibration any time by pressing **ESC**. No data are then used to adjust the sensor.

17.9.4 ORP

Single-point calibration with calibration buffers

With this type of calibration, you work with calibration buffers, e.g. ORP buffers from Endress+Hauser. For this calibration, you remove the sensor from the medium.

1. Open the menu: **CAL/ISE/ORP/1-pnt. calibration.**
2. Select the ORP sensor and **▷ Start calibration.**
3. **Buffer::** Enter the value of the buffer.
4. **▷ Continue.**
5. Follow the software instructions, and immerse the sensor in the buffer.
6. **OK:** Start calibration.
 - ↳ The system starts calculating the measured value for the buffer. Once the stability criterion is met, the measured value is displayed in mV.
7. Accept the calibration data and then return to the measuring mode.

You can cancel the calibration any time by pressing **ESC**. No data are then used to adjust the sensor.

17.9.5 Error messages when performing the calibration

Display message	Causes and possible remedial measures
The calibration is invalid. Do you want to start a new calibration? Slope out of tolerance. Zeropoint out of tolerance. Sample concentration too low.	The calibration buffer is contaminated or the pH value is no longer within the permitted limits. As a result, the permitted measured value deviation is exceeded. <ol style="list-style-type: none"> 1. Check the expiry date 2. Use a fresh buffer Incorrect buffers used. As a result, the buffer recognition function - for example - does not work correctly. <ol style="list-style-type: none"> 1. pH values of the buffers are too close together, e.g. pH 9 and 9.2 2. Use buffers with a larger pH difference Sensor aging or contaminated. As a result, the permitted limit values for the slope and/or zero point are exceeded <ol style="list-style-type: none"> 1. Clean sensor 2. Adjust the limit values 3. Regenerate or replace the sensor
The stability criterion is not fulfilled. Do you want to repeat the last step?	The measured value or temperature is not stable. As a result, the stability criterion is not met. <ol style="list-style-type: none"> 1. Keep the temperature constant during calibration 2. Replace the buffer 3. Clean or regenerate aged or contaminated sensor 4. Adjust stability criteria →  106.
Calibration aborted. Please clean sensor before immersing in process medium. (Hold will be disabled)	The user has aborted the calibration.

17.10 Turbidity and solids sensors

17.10.1 Sensor for turbidity and solids content (CUS51D)

The sensor is precalibrated on leaving the factory. As such, it can be used in a wide range of applications (e.g. clear water measurements) without the need for additional calibration. The **Kaolin** and **Formazine** applications are already fully calibrated and can be used without any further calibration.

All other applications are precalibrated with reference samples and require calibration to the corresponding application.

In addition to the factory calibration data, which cannot be modified, the sensor has five other data records to be used for storing process calibrations.

 Operating Instructions Turbimax CUS51D, BA00461C

All information regarding the range of applications, recommended calibration types, sampling, handling and use of the sensor during calibration and reference measurement can be found in the Operating Instructions for the sensor.

One to five points can be calibrated for each application.

Opening the calibration menu

1. Press **CAL**.
2. <Channel no.>: select **TU/TS**.

Creating a calibration data record

1. Perform a single-point or multi-point calibration.
 - ↳ A new calibration data record is created.
2. *Alternatively:*
 - Duplicate an existing data record.

Single-point or multi-point calibration

If possible, start the calibration at the same time as the sampling procedure and enter the laboratory value of the sample as the set point. If no laboratory value is available during calibration, enter an approximate value as the set point. As soon as the laboratory value is available, amend the set point on the transmitter.

From Liquiline-software version 01.06.04:

1. Select an empty data record (identified by an empty box before the name, e.g. **Dataset1**).
2. **Dataset name:** Assign a name to the data record.
3. **Basic application:** Select application.
4. **Unit:** Select unit.
5. **Calibration table:** Select table.
6. **Add calibration points:** Select function.
7. Confirm prompts (start calibration, clean sensor): **OK**.
8. Enter reference value (set point).
9. Where necessary, select **Calibrate next assay**.
10. Once you have determined the last measuring point:
 - Accept calibration data.**
 - ↳ A message is displayed informing you whether the data record is valid.
11. Confirm prompt (clean sensor): **OK**.
 - ↳ Decide if you wish to activate the calibrated data record.

Only set points can be changed in the case of activated data records. It is then no longer possible to delete measuring points.

Duplicating a data record

1. **Duplicate dataset:** Start function.
2. **Copy from:** Select source data record.
3. **Copy to:** Select target data record.
4. **Dataset name:** Enter a name for the duplicated record.
5. **Duplicate dataset.**

Editing a data record

You can apply a factor or an offset to the data records created. This factor or offset is determined by means of a reference measurement. In addition, the active table can be also edited or extended to include additional calibration points.

Editing options:

- Factor/Offset
 - Data input (offset)
 - Data input (factor)
- Edit table
 - Add calibration points
 - Substitute calib. point

► Factor/Offset

1. ► **Data input (offset)**
2. **Offset:** Enter offset from reference measurement.
3. ▷ **Accept calibration data.**

1. ► **Data input (factor)**

2. **Cal. factor:** Enter the factor calculated from the measured value and reference value.
3. ▷ **Accept calibration data.**

► Calibration table

1. ▷ **Edit table**
 - ↳ You will receive a warning if the data record is the one that is currently active. Take note of this warning before continuing.
2. **OK:** Adjust values.
3. **SAVE.**

Adding a calibration point

1. ▷ **Add calibration points**
 - ↳ You will receive a warning if the data record is the one currently active for the measurement. Adding calibration points can result in invalid data.
2. **OK:** Add additional calibration points.
3. Immerse the sensor in the calibration solution, and wait for the measured value to stabilize.
4. Enter set point.
5. Add additional points or ▷ **Accept calibration data.**

Calibration points can also be added to the table by entering data for target and actual values (**INSERT**).

Replacing a calibration point

You can replace a calibration point if it is regarded as valid.

6. ▷ **Substitute calib. point**
↳ Prompt, asking if calibration should be started.
7. **OK.**
8. Immerse the sensor in the calibration solution, and wait for the measured value to stabilize.
9. Select the point to be replaced.
10. ▷ **Accept calibration data.**

Measured value filter

Measured value filter	Description
Weak	Low filtering, high sensitivity, fast response time
Normal (factory setting)	Medium filtering
Strong	Strong filtering, low sensitivity, slow response to changes

1. **Configuration method:** Select **Standard**.
2. **Filter level:** Select in accordance with the above table.
3. ▷ **Accept calibration data.**

Configuration method = Specialist

The individual parameters for filtering must be entered here. This task should be left to Endress+Hauser Service.

Editing the name of the sample set

1. **Dataset name:** Enter the desired name.
2. ▷ **Accept calibration data.**

17.10.2 Turbidity sensor for drinking water applications (CUS52D)

The sensor is precalibrated on leaving the factory. As such, it can be used in a wide range of applications without the need for additional calibration. The **Formazine** application is already fully calibrated and can be used without any further calibration.

All other applications are precalibrated with reference samples and require calibration to the corresponding application.

In addition to the factory calibration data, which cannot be modified, the sensor has six other data records to be used for storing process calibrations.

Operating Instructions Turbimax CUS52D, BA01275C

All information regarding the range of applications, recommended calibration types, sampling, handling and use of the sensor during calibration and reference measurement can be found in the Operating Instructions for the sensor.

One to six points can be calibrated for each application.

Opening the calibration menu

1. Press **CAL**.
2. <Channel no.>: Select **TU**.

Creating a calibration data record

1. Perform a single-point or multi-point calibration.
 - ↳ A new calibration data record is created.
2. *Alternatively:*
Duplicate an existing data record.

Single-point or multi-point calibration

If possible, start the calibration at the same time as the sampling procedure and enter the laboratory value of the sample as the set point. If no laboratory value is available during calibration, enter an approximate value as the set point. As soon as the laboratory value is available, amend the set point on the transmitter.

From Liquiline-software version 01.06.04:

1. Select an empty data record (identified by an empty box before the name, e.g. **Dataset1**).
2. **Dataset name:** Assign a name to the data record.
3. **Basic application:** Select application.
4. **Unit:** Select unit.
5. **Calibration table:** Select table.
6. **Add calibration points:** Select function.
7. Confirm prompts (start calibration, clean sensor): **OK**.
8. Enter reference value (set point).
9. Where necessary, select **Calibrate next assay**.
10. Once you have determined the last measuring point:
Accept calibration data.
 - ↳ A message is displayed informing you whether the data record is valid.
11. Confirm prompt (clean sensor): **OK.**
 - ↳ Decide if you wish to activate the calibrated data record.

Only set points can be changed in the case of activated data records. It is then no longer possible to delete measuring points.

Activating a data record at a later time

1. **Menu/Setup/Inputs/TU/Application:** Select application.
2. If the application is selected correctly:
Select data record.

Duplicating a data record

1. **Duplicate dataset:** Start function.
2. **Copy from:** Select source data record.
3. **Copy to:** Select target data record.
4. **Dataset name:** Enter a name for the duplicated record.
5. **Duplicate dataset.**

Editing a data record

You can apply a factor or an offset to the active data record. This factor or offset is determined by means of a reference measurement. In addition, the active table can be also edited or extended to include additional calibration points.

Editing options:

- Factor/Offset
 - Data input (offset)
 - Data input (factor)
- Edit table
 - Add calibration points

► **Factor/Offset**

1. ► **Data input (offset)**
2. **Offset:** Enter offset from reference measurement.
3. ▷ **Accept calibration data.**

1. ► **Data input (factor)**
2. **Cal. factor:** Enter the factor calculated from the measured value and reference value.
3. ▷ **Accept calibration data.**

► **Calibration table**

1. ▷ **Edit table**
 - ↳ You will receive a warning if the data record is the one that is currently active. Take note of this warning before continuing.
2. **OK:** Adjust values.
3. **SAVE.**

Adding a calibration point

1. ▷ **Add calibration points**
 - ↳ You will receive a warning if the data record is the one currently active for the measurement. Adding calibration points can result in invalid data.
2. **OK:** Add additional calibration points.
3. Immerse the sensor in the calibration solution, and wait for the measured value to stabilize.
4. Enter set point.
5. Add additional points or ▷ **Accept calibration data.**

Calibration points can also be added to the table by entering data for target and actual values (**INSERT**).

Assembly adjustment

Both the optical design of sensor CUS52D and flow assemblies CUA252 and CUA262 are optimized to minimize measuring errors caused by wall effects in assemblies or pipes (measuring error in CUA252 < 0.02 FNU).

You can use the **Assembly adjustment** function to automatically compensate for any remaining measuring errors caused by wall effects. The underlying functionality is based on formazine measurements and may thus require a calibration downstream in order to adapt the measurement to the corresponding application or to the medium.

Adjustment	Description
PE100	Adjustment to flow assembly CUA252 (material = polyethylene)
1.4404 / 316L	Adjustment to flow assembly CUA262 (material = stainless steel 1.4404)

Adjustment	Description
Customized	Adjustment to any pipe/assembly
Customized advanced	Adjustment only recommended for Endress+Hauser service personnel

- **PE100 and 1.4404 / 316L**

All of the parameters are assigned default values in the firmware and cannot be changed.

- **Customized**

It is possible to select the material, surface (matte/shiny) and the internal diameter of the assembly in which the sensor is installed.

- **Customized advanced**

For special adjustments, the following table provides recommendations. Alternatively, adjustments can be performed by the manufacturer's service department.

Assembly/pipe built-in adapter	Zero adjustment	Upper Limit	Adjustment characteristic
CUA250 ¹⁾	0.14	33	1.001
CYA251 ¹⁾	0.075	25	1.5
VARIVENT N DN 65	1.28	500	6
VARIVENT N DN 80	0.75	500	6
VARIVENT N DN 100	0.35	500	6
VARIVENT N DN 125	0.20	500	6

1) Sensor adapter required to fit CUS52D in this assembly, see Operating Instructions for the sensor

Performing an assembly adjustment

1. Launch function: .../TU/Assembly adjustment.
2. Select adjustment.
3. ▷ Accept calibration data.

Editing the name of the sample set

1. **Dataset name:** Enter the desired name.
2. ▷ Accept calibration data.

17.10.3 Absorption sensor for turbidity and solids measurement (CUS50D)

The "Absorption" and "Formazine" applications are calibrated at the factory. The absorption factory calibration is used as the basis for precalibrating additional applications and optimizing them for the different media characteristics.

Application	Specified operating range
Factory calibration for absorption	0.000 to 5.000 AU or 0.000 to 10.000 OD
Factory calibration for formazine	40 to 4,000 FAU
Application: Kaolin	0 to 60 g/l
Application: Sludge	0 to 25 g/l
Application: Auto sludge	0 to 25 g/l
Product loss	0 to 100%

To adapt to a specific application, customer calibrations can be carried out with up to 10 points.

Factory calibration for the formazine application is carried out with the formazine turbidity standard. Sensor readings in the unit [FAU] are comparable to the measured values of any other sensor, e.g. scattered light sensor with the unit [FNU] or [NTU], only in this standard medium. In any other medium, the measured values will be different to those obtained when measuring with another scattered light sensor.

The absorption and formazine applications are calibrated at the factory. All other applications are merely precalibrated and must therefore be adapted to the corresponding application or to the medium.

The sensor has 8 data records. Six of these are prepopulated at the factory with sample data records, i.e. typical settings, for all available applications:

- Absorption
- Formazine
- Kaolin
- Sludge
- Auto sludge
- Product loss

The required data record is activated by selecting the application in question and can be adapted to that application using the following options:

- Calibration (1 to 10 points)
- Entering of a factor (multiplication of measured values by a constant factor)
- Entering of an offset (addition/subtraction of a constant factor to/from the measured values)
- Duplication of factory calibration data records

 Further data records can be created in the sensor and adapted to the application by means of calibration or by entering a factor or offset. Two free, unused data records are available for this. The number of free data records can be increased if necessary by deleting (sample) data records that are not required. The sample data records are restored to factory status when the sensor is reset.

 Operating Instructions Turbimax CUS50D, BA01846C

All information regarding the range of applications, recommended calibration types, sampling, handling and use of the sensor during calibration and reference measurement can be found in the Operating Instructions for the sensor.

Opening the calibration menu

1. Press **CAL**.
2. <Channel no.>: Select **TU/AU**.

Single-point or multi-point calibration for data records already created

If possible, start the calibration at the same time as the sampling procedure and enter the laboratory value of the sample as the set point. If no laboratory value is available during calibration, enter an approximate value as the set point. As soon as the laboratory value is available, amend the set point on the transmitter.

From Liquiline-software version 01.06.04:

1. Select sample data record (e.g. **Absorption**).
2. **Calibration table**: Select table.
3. **Add calibration points**: Select function.
4. Confirm prompts (start calibration, clean sensor): **OK**.
5. Enter reference value (set point).
6. Where necessary, select **Calibrate next assay**.

7. Once you have determined the last measuring point:
Accept calibration data.
↳ A message is displayed informing you whether the data record is valid.
8. Confirm prompt (clean sensor): **OK.**
↳ Decide if you wish to activate the calibrated data record.

Only set points can be changed in the case of activated data records. It is then no longer possible to delete measuring points.

Single-point or multi-point calibration for empty data records

1. Select empty data record (identified by empty box before the name, e.g. **Dataset7**).
2. **Dataset name:** Assign a name to the data record.
3. **Basic application:** Select application.
4. **Measurement path:** Select path length.
5. **Unit:** Select unit.
6. **Calibration table:** Select table.
7. **Add calibration points:** Select function.
8. Confirm prompts (start calibration, clean sensor): **OK.**
9. Enter reference value (set point).
10. Where necessary, select **Calibrate next assay.**
11. Once you have determined the last measuring point:
Accept calibration data.
↳ A message is displayed informing you whether the data record is valid.
12. Confirm prompt (clean sensor): **OK.**
↳ Decide if you wish to activate the calibrated data record.

Once you have activated the data record you can only change the set points. It is then no longer possible to delete measuring points.

Activating a data record at a later time

1. Select application: **Menu/Setup/Inputs/TU/AU/Application.**
2. If the application is selected correctly:
Select data record.

Duplicating a data record

1. **Duplicate dataset:** Start function.
2. **Copy from:** Select source data record.
3. **Copy to:** Select target data record.
4. **Dataset name:** Enter a name for the duplicated record.
5. **Duplicate dataset.**

Editing a data record

You can apply a factor or an offset to the active data record. This factor or offset is determined by means of a reference measurement. In addition, the active table can be also edited or extended to include additional calibration points.

Editing options:

- Factor/Offset
 - Data input (offset)
 - Data input (factor)
- Edit table
 - Add calibration points

► **Factor/Offset**

1. ► **Data input (offset)**
2. **Offset:** Enter offset from reference measurement.
3. ▷ **Accept calibration data.**

1. ► **Data input (factor)**
2. **Cal. factor:** Enter the factor calculated from the measured value and reference value.
3. ▷ **Accept calibration data.**

► **Calibration table**

1. ▷ **Edit table**
 - ↳ You will receive a warning if the data record is the one that is currently active. Take note of this warning before continuing.
2. **OK:** Adjust values.
3. **SAVE.**

Adding a calibration point

1. ▷ **Add calibration points**
 - ↳ You will receive a warning if the data record is the one currently active for the measurement. Adding calibration points can result in invalid data.
2. **OK:** Add additional calibration points.
3. Immerse the sensor in the calibration solution, and wait for the measured value to stabilize.
4. Enter set point.
5. Add additional points or ▷ **Accept calibration data.**

Calibration points can also be added to the table by entering data for target and actual values (**INSERT**).

Measured value filter

Measured value filter	Description
Weak	Low filtering, high sensitivity, fast response time
Normal (factory setting)	Medium filtering
Strong	Strong filtering, low sensitivity, slow response to changes

1. **Configuration method:** Select **Standard**.
2. **Filter level:** Select in accordance with the above table.
3. ▷ **Accept calibration data.**

 **Configuration method = Specialist**

The individual parameters for filtering must be entered here. This task should be left to Endress+Hauser Service.

Air bubble trap

In addition to the measured value filter, the sensor also features a filter function to suppress the measured errors caused by air bubbles.

Air bubbles cause the measured value to increase in liquids with low turbidity or with a low solids content. The filter function cuts off these measured value peaks by outputting the minimum value within a specified time interval. The time interval can be configured using a numerical value between 0 and 180 seconds. The air bubble trap is disabled (value 0) by default. Enabling the air bubble trap in the case of liquids with high turbidity or high solids content is not of any benefit. Air bubbles do not cause the measured value to increase in media of this type and thus cannot be eliminated with the minimum filter.

1. **Bubble suppression filter:** Select function.
2. ▷ **Accept calibration data.**

Editing the name of the sample set

1. **Dataset name:** Enter the desired name.
2. ▷ **Accept calibration data.**

17.10.4 Error messages during calibration (all sensors)

Display message	Causes and possible remedial measures
The calibrated dataset is invalid. Do you want to restart the calibration?	Calibration point not plausible <ol style="list-style-type: none"> 1. Repeat calibration 2. Check the position of the sensor in the calibration vessel (fixed position, wall effects etc.) 3. Ensure the medium is mixed thoroughly (e.g. use a magnetic stirrer) 4. Exchange the calibration medium 5. Clean any dirt from the sensor
The stability criterion is not fulfilled. Do you want to repeat the last step?	The measured value or temperature is not stable. As a result, the stability criterion is not met. <ol style="list-style-type: none"> 1. Keep the temperature constant during calibration 2. Check the position of the sensor in the calibration vessel (fixed position, wall effects etc.) 3. Ensure the medium is mixed thoroughly (e.g. use a magnetic stirrer) 4. Clean any dirt from the sensor 5. Adjust stability criteria →  78.
Calibration aborted. Please clean sensor before immersing in process medium. (Hold will be disabled)	The user has aborted the calibration.

17.11 SAC sensor

17.11.1 Types of calibration

In addition to the uneditable factory calibration, the sensor stores six other data records. Each calibration data record can have up to five calibration points.

- Single-point calibration
This causes a change in the slope. This type of calibration is used if the measured value only changes to a limited extent.
- Two-point calibration
This causes a change in the slope and offset. This type of calibration is used if the measured value changes to a large extent.
- Multipoint calibration
Calibration at three or more points always causes the measuring curve to be recalculated.
- Temperature adjustment by entering a reference value

17.11.2 SAC

Factory calibration

The sensor is precalibrated on leaving the factory (calibrated with KHP). Calibration to the customer process is nevertheless advantageous in the majority of cases. Reason: Organic compounds other than KHP react differently in the spectrum.

The factory calibration is based on 20 calibration points and is adjusted at three points during production. The factory calibration cannot be deleted and can be retrieved at any time. Single-point and two-point calibrations - performed as customer calibrations - are referenced to this factory calibration.

Principle of calibration

If you use one or two medium concentrations for calibration, the factory data record is recalculated using these measuring points and saved as a new data record. The original factory calibration is not lost.

If you use three or more concentration values for calibration, a completely new calibration function is calculated that no longer takes the original factory calibration data record into account.

-  Give your calibration data records meaningful and useful names. For example, the name could contain the name of the application on which your data record was originally based. This makes it easier for you to distinguish between different data records.

Determining the reference values in the laboratory

Different methods are available for the calibration:

- Serial dilution of a medium sample
- Serial calibration with standard solutions (KHP = potassium hydrogen phthalate)
- Combination of both (medium sample with added standard)

1. Take a representative sample of the medium.
2. Take suitable measures to ensure that the process of biological and chemical reduction in the sample does not progress any further.
3. Determine the measured values of your sample array using the laboratory method (for example, by colorimetric means using a cuvette test).

Calibration and adjustment of the sensor

To calibrate the sensor, use the same medium sample or sample array that you used to determine the laboratory measured values. The sample array can also be pure standard solutions.

The general sequence of a calibration is as follows:

1. Select data record.
2. Place sensor in medium.
3. During calibration, ensure that the medium is well homogenized.
4. Start the calibration for the measuring point.
5. If you wish to calibrate just one point:
End the calibration by accepting the calibration data.
↳ Otherwise continue with the next step.
6. Add parent solution to the sample for the second measuring point and determine its measured value. The reference value is calculated from the laboratory measured value plus the added concentration.
7. Repeat the previous step as often as needed until you have reached the desired number of calibration points (max. 5).

To avoid incorrect calibration from carryover:

- Always go from a low concentration to a high concentration.
- Clean and dry the sensor after each measurement.
- Make sure to remove medium residue in the sensor gap and in the connection opening for the compressed air (e.g. by rinsing with the next calibration solution).

Calibration on the transmitter

1. **CAL**: Select sensor and open its calibration menu.
2. **Dataset**: Select data record. This must not be the active data record (identifiable by a marker in front of the data record name).
3. **Dataset name**: Assign a name to the data record.
4. **Basic application**: Decide which value you want to calibrate. **SAC, COD, TOC, DOC** or **BOD** are available for selection.
↳ Only if **Basic application = SAC**:
The transmitter can determine the derived variables COD, TOC, DOC and BOD from the SAC value. Different calculation factors exist for this depending on the reference method. You can adapt the calculation factor saved at the factory for COD/BOD and TOC/DOC to your application and also enter an SAC offset.
5. **Unit**: Select the unit. Use the unit in which you also obtained the laboratory values.
6. ▷ **Start calibration**: Follow the instructions to record the first measuring point (lowest concentration).
↳ Once a stable measured value has been determined, you will be asked for the set point (=laboratory value) of the sample.
7. Enter set point.
8. Decide whether you want to add another calibration point (**Calibrate next assay**) or whether you want to end the calibration and accept the data for adjustment (**Take over the calibration data?**).
9. Determine all the desired measuring points.
10. Once you have determined the last measuring point:
Accept data.
↳ A message is displayed informing you whether the data record is valid.

11. Respond to the prompt to accept the calibration data for adjustment by selecting **OK**.
 - ↳ You are asked whether you want to activate the data record just recorded. If you select **OK**, the measured values are calculated on the basis of the new calibration function.

You still have the possibility of editing the data record.

Once you have activated the data record you can only change the set points. It is then no longer possible to delete measuring points.

You can cancel the calibration any time by pressing **ESC**. No data are then used to adjust the sensor.

Editing data records

You can apply a factor or an offset to the active data record. This factor or offset is determined by means of a reference measurement. In addition, the active table can be also edited or extended to include additional calibration points.

Editing options:

- Edit offset
- Edit factor
- Edit table
- Start calibration
- Substitute calib. point

▶ Edit offset

1. **Offset:** Enter offset from reference measurement.
2. ▷ **Accept calibration data.**

▶ Edit factor

1. **Cal. factor:** Enter the factor calculated from the measured value and reference value.
2. ▷ **Accept calibration data.**

▷ Edit table

You will receive a warning indicating that the data record is the one that is currently active. Take note of this warning before continuing.

1. **OK:** Adjust values.
2. **SAVE.**

▷ Start calibration

You will receive a warning indicating that the data record is the one currently active for the measurement. Adding calibration points can result in invalid data. If you proceed, the factory calibration automatically becomes active for the current measurement.

1. **OK:** Add additional calibration points.
2. Immerse sensor in calibration solution, and wait for the measured value to stabilize.
3. Enter set point.
4. Add additional points or ▷ **Accept calibration data.**

▷ Substitute calib. point

You can replace a calibration point if is regarded as valid.

1. Respond to prompt asking if calibration should be started by selecting **OK**.
2. Immerse sensor in calibration solution, and wait for the measured value to stabilize.
3. Select the point to be replaced.
4. ▷ **Accept calibration data.**

Duplicating data records

This function makes it possible to edit an existing calibration data record, such as the factory calibration, for example.

By entering appropriate data you can then configure an offset for the copied data record or change the nominal values using a table. This provides a quick and easy way to react to modified conditions in your process which you are aware of without the need for calibration.

1. **Duplicate dataset:** Start function.
2. Select data record to be duplicated.
3. Select memory location and enter a name for the duplicated record.
 - ↳ You can only duplicate a record if you have not yet used all the available space for data records. If no more room is available you must first delete a data record.

You can now:

- Configure an offset for the new data record
 - Change the nominal values of the individual calibration points via the function **Edit table**.
4. If you want to use the modified data record as the active data record:
Open the menu **Setup/Inputs**.
 5. Select the new data record under **Application**.

17.11.3 Temperature adjustment

1. Determine the temperature of the process medium with an alternative measurement, such as a precision thermometer.
2. Open the menu: **CAL/<Sensor type>/Temperature adjustment**.
3. **Leave the sensor in the process medium** and keep clicking **OK** until temperature measurement is started via the sensor.
4. Enter the reference temperature from the alternative measurement. You can either enter the absolute value or an offset for this purpose.
5. Then keep clicking **OK** until the new data have been accepted.
 - ↳ This completes the temperature adjustment.

17.11.4 Error messages when performing the calibration

Display message	Causes and possible remedial measures
The calibrated dataset is invalid. Do you want to restart the calibration?	Calibration point not plausible <ol style="list-style-type: none"> 1. Repeat calibration 2. Check the position of the sensor in the calibration vessel (fixed position, wall effects, air bubbles, etc.) 3. Ensure the medium is mixed thoroughly (e.g. use a magnetic stirrer) 4. Exchange the calibration medium 5. Clean any dirt from the sensor
The stability criterion is not fulfilled. Do you want to repeat the last step?	The measured value or temperature is not stable. As a result, the stability criterion is not met. <ol style="list-style-type: none"> 1. Keep the temperature constant during calibration 2. Check the position of the sensor in the calibration vessel (fixed position, wall effects, air bubbles, etc.) 3. Ensure the medium is mixed thoroughly (e.g. use a magnetic stirrer) 4. Clean any dirt from the sensor 5. Adjust stability criteria → 86.
Calibration aborted. Please clean sensor before immersing in process medium. (Hold will be disabled)	The user has aborted the calibration.

17.12 Nitrate sensors

Processes with nitrate values > 0.1 mg/l

1. Take sample and determine nitrate concentration in the laboratory.
2. Calibrate and adjust the sensor using the laboratory value.

Processes with very different nitrate values

1. At time A, take a sample with a high concentration, and measure and calibrate the sample.
2. At time B - which can be a few days later - take a sample with a low concentration, and measure and calibrate the second value.

Calibration with the addition of standard

If the sludge parameters tend to be constant, you can perform the calibration with a sample with a low concentration of nitrate and then add standard to the sample.

1. Take a larger sample (bucket) and analyze some of it by colorimetric means.
2. Calibrate the value of the calorimetric measurement in the sensor.
3. Add standard to the sample and determine the laboratory value.
4. Calibrate the laboratory value of the sample with added standard in the sensor.

Avoid incorrect measurements.

- ▶ Drinking water may contain higher concentrations of nitrate and is not suitable as a blank value. Use fully deionized water as a blank value.
- ▶ During calibration, make sure the sample is homogeneous.

- ▶ When calibrating, start with a low concentration and increase the concentrations gradually to prevent nitrate carryover.
- ▶ Clean and dry the sensor after a calibration. Ensure that there is no medium residue in the cuvette gap. In this way, you avoid mixing the different samples and changing the nitrate concentrations.

17.12.1 Types of calibration

In addition to the uneditable factory calibration, the sensor stores six other data records. Each calibration data record can have up to five calibration points.

- Single-point calibration
This causes a change in the slope. This type of calibration is used if the measured value only changes to a limited extent.
- Two-point calibration
This causes a change in the slope and offset. This type of calibration is used if the measured value changes to a large extent.
- Multipoint calibration
Calibration at three or more points always causes the measuring curve to be recalculated.
- Temperature adjustment by entering a reference value

17.12.2 Nitrate

Factory calibration

The sensor is precalibrated on leaving the factory.

As such, it can be used in a wide range of clear water measurements without the need for additional calibration.

The factory calibration is based on 20 calibration points and is adjusted at three points during production. The factory calibration cannot be deleted and can be retrieved at any time. Single-point and two-point calibrations - performed as customer calibrations - are referenced to this factory calibration.

Principle of calibration

If you use one or two medium concentrations for calibration, the factory data record is recalculated using these measuring points and saved as a new data record. The original factory calibration is not lost.

If you use three or more concentration values for calibration, a completely new calibration function is calculated that no longer takes the original factory calibration data record into account.

-  Give your calibration data records meaningful and useful names. For example, the name could contain the name of the application on which your data record was originally based. This makes it easier for you to distinguish between different data records.

Determining the reference values in the laboratory

1. Take a representative sample of the medium.
2. Take suitable measures to ensure that the process of nitrate reduction in the sample does not progress any further, such as immediate filtration (0.45 µm) of the sample as per DIN 38402.
3. Determine the concentration of nitrate in the sample using the laboratory method (for example, by colorimetric means using a cuvette test - the standard method as per DIN 38405 Part 9).

Calibration and adjustment of the sensor

To calibrate the sensor, use the same medium sample or sample array that you used to determine the laboratory measured values. The sample array can also be pure standard solutions.

The general sequence of a calibration is as follows:

1. Select data record.
2. Place sensor in medium.
3. During calibration, ensure that the medium is well homogenized.
4. Start the calibration for the measuring point.
5. If you wish to calibrate just one point:
End the calibration by accepting the calibration data.
↳ Otherwise continue with the next step.
6. Add parent solution to the sample for the second measuring point and determine its measured value. The reference value is calculated from the laboratory measured value plus the added concentration.
7. Repeat the previous step as often as needed until you have reached the desired number of calibration points (max. 5).

To avoid incorrect calibration from carryover:

- Always go from a low concentration to a high concentration.
- Clean and dry the sensor after each measurement.
- Make sure to remove medium residue in the sensor gap and in the connection opening for the compressed air (e.g. by rinsing with the next calibration solution).

Calibration on the transmitter

1. **CAL:** Select sensor and open its calibration menu.
2. **Dataset:** Select data record. This must not be the active data record (identifiable by a marker in front of the data record name).
3. **Dataset name:** Assign a name to the data record.
4. **Unit:** Select the unit. Use the unit in which you also obtained the laboratory values.
5. ▷ **Start calibration:** Follow the instructions to record the first measuring point (lowest concentration).
↳ Once a stable measured value has been determined, you will be asked for the set point (=laboratory value) of the sample.
6. Enter set point.
7. Decide whether you want to add an additional value (next highest concentration, **Calibrate next assay**) or whether you want to end the calibration and accept the data for adjustment (**Take over the calibration data?**).
8. Determine all the desired measuring points.
9. Once you have determined the last measuring point:
Accept data.
↳ A message is displayed informing you whether the data record is valid.
10. Respond to the prompt to accept the calibration data for adjustment by selecting **OK**.
↳ You are asked whether you want to activate the data record just recorded. If you select **OK**, the measured values are calculated on the basis of the new calibration function.

You still have the possibility of editing the data record.

Once you have activated the data record you can only change the set points. It is then no longer possible to delete measuring points.

You can cancel the calibration any time by pressing **ESC**. No data are then used to adjust the sensor.

Editing data records

You can apply a factor or an offset to the active data record. This factor or offset is determined by means of a reference measurement. In addition, the active table can be also edited or extended to include additional calibration points.

Editing options:

- Edit offset
- Edit factor
- Edit table
- Start calibration
- Substitute calib. point

► Edit offset

1. **Offset**: Enter offset from reference measurement.
2. ▷ **Accept calibration data**.

► Edit factor

1. **Cal. factor**: Enter the factor calculated from the measured value and reference value.
2. ▷ **Accept calibration data**.

▷ Edit table

You will receive a warning indicating that the data record is the one that is currently active. Take note of this warning before continuing.

1. **OK**: Adjust values.
2. **SAVE**.

▷ Start calibration

You will receive a warning indicating that the data record is the one currently active for the measurement. Adding calibration points can result in invalid data. If you proceed, the factory calibration automatically becomes active for the current measurement.

1. **OK**: Add additional calibration points.
2. Immerse sensor in calibration solution, and wait for the measured value to stabilize.
3. Enter set point.
4. Add additional points or ▷ **Accept calibration data**.

▷ Substitute calib. point

You can replace a calibration point if is regarded as valid.

1. Respond to prompt asking if calibration should be started by selecting **OK**.
2. Immerse sensor in calibration solution, and wait for the measured value to stabilize.
3. Select the point to be replaced.
4. ▷ **Accept calibration data**.

Duplicating data records

This function makes it possible to edit an existing calibration data record, such as the factory calibration, for example.

By entering appropriate data you can then configure an offset for the copied data record or change the nominal values using a table. This provides a quick and easy way to react to

modified conditions in your process which you are aware of without the need for calibration.

1. **Duplicate dataset:** Start function.
2. Select data record to be duplicated.
3. Select memory location and enter a name for the duplicated record.
 - ↳ You can only duplicate a record if you have not yet used all the available space for data records. If no more room is available you must first delete a data record.

You can now:

- Configure an offset for the new data record
 - Change the nominal values of the individual calibration points via the function **Edit table**.
4. If you want to use the modified data record as the active data record:
Open the menu **Setup/Inputs**.
 5. Select the new data record under **Application**.

17.12.3 Temperature adjustment

1. Determine the temperature of the process medium with an alternative measurement, such as a precision thermometer.
2. Open the menu: **CAL/<Sensor type>/Temperature adjustment**.
3. **Leave the sensor in the process medium** and keep clicking **OK** until temperature measurement is started via the sensor.
4. Enter the reference temperature from the alternative measurement. You can either enter the absolute value or an offset for this purpose.
5. Then keep clicking **OK** until the new data have been accepted.
 - ↳ This completes the temperature adjustment.

17.12.4 Error messages when performing the calibration

Display message	Causes and possible remedial measures
The calibrated dataset is invalid. Do you want to restart the calibration?	Calibration point not plausible <ol style="list-style-type: none"> 1. Repeat calibration 2. Check the position of the sensor in the calibration vessel (fixed position, wall effects, air bubbles, etc.) 3. Ensure the medium is mixed thoroughly (e.g. use a magnetic stirrer) 4. Exchange the calibration medium 5. Clean any dirt from the sensor
The stability criterion is not fulfilled. Do you want to repeat the last step?	The measured value or temperature is not stable. As a result, the stability criterion is not met. <ol style="list-style-type: none"> 1. Keep the temperature constant during calibration 2. Check the position of the sensor in the calibration vessel (fixed position, wall effects, air bubbles, etc.) 3. Ensure the medium is mixed thoroughly (e.g. use a magnetic stirrer) 4. Clean any dirt from the sensor 5. Adjust stability criteria →  86.
Calibration aborted. Please clean sensor before immersing in process medium. (Hold will be disabled)	The user has aborted the calibration.

17.13 Calibration accessories

17.13.1 Memobase Plus

Memobase Plus CYZ71D

- PC software to support laboratory calibration
- Visualization and documentation of sensor management
- Sensor calibrations stored in database
- Product Configurator on the product page: www.endress.com/cyz71d



Technical Information TI00502C

17.13.2 pH calibration buffer

High-quality buffer solutions from Endress+Hauser - CPY20

The secondary buffer solutions have been referenced to primary reference material of the PTB (German Federal Physico-technical Institute) or to standard reference material of NIST (National Institute of Standards and Technology) according to DIN 19266 by a laboratory accredited by the DAkkS (German accreditation body) according to DIN 17025. Product Configurator on the product page: www.endress.com/cpy20

17.13.3 ORP buffer

Technical buffer solutions for ORP electrodes

- +220 mV, pH 7, 250 ml; order no. CPY3-4
- +468 mV, pH 0.1, 250 ml; order no. CPY3-5

17.13.4 Conductivity calibration solutions

Conductivity calibration solutions CLY11

Precision solutions referenced to SRM (Standard Reference Material) by NIST for qualified calibration of conductivity measuring systems in accordance with ISO 9000
CLY11-B, 149.6 $\mu\text{S}/\text{cm}$ (reference temperature 25 °C (77 °F)), 500 ml (16.9 fl.oz)
Order No. 50081903

 Technical Information TI00162C

17.13.5 Oxygen

COY8

Zero-point gel for oxygen and disinfection sensors

- Oxygen-free and chlorine-free gel for the verification, zero point calibration and adjustment of oxygen and disinfection measuring points
- Product Configurator on the product page: www.endress.com/coy8

 Technical Information TI01244C

Calibration vessel

- For COS61D/61
- Order No.: 51518599

17.13.6 Chlorine

Photometer

- Photometer for determining chlorine and pH value
- Order no.: 71257946

17.13.7 ISE and nitrate

CAY40

- Standard solutions for ammonium, nitrate, potassium and chloride
- Ordering information: www.endress.com/cas40d under "Accessories/spare parts"

17.13.8 Nitrate

Nitrate standard solutions, 1 liter

- 5 mg/l $\text{NO}_3\text{-N}$, order number: CAY342-V10C05AAE
- 10 mg/l $\text{NO}_3\text{-N}$, order number: CAY342-V10C10AAE
- 15 mg/l $\text{NO}_3\text{-N}$, order number: CAY342-V10C15AAE
- 20 mg/l $\text{NO}_3\text{-N}$, order number: CAY342-V20C10AAE
- 30 mg/l $\text{NO}_3\text{-N}$, order number: CAY342-V20C30AAE
- 40 mg/l $\text{NO}_3\text{-N}$, order number: CAY342-V20C40AAE
- 50 mg/l $\text{NO}_3\text{-N}$, order number: CAY342-V20C50AAE

17.13.9 SAC

KHP standard solution

CAY451-V10C01AAE, 1000 ml parent solution 5 000 mg/l TOC

Index

A

Accessories	190
Air set	153

C

Calibration	
Conductivity	152
Disinfection	162
ISE	166
Nitrate	185
ORP	150
Oxygen	155
pH	145
SAC	181
Turbidity and solids	171
Calibration settings	
Disinfection	57
Drinking water turbidity	69
ISE	106
Nitrate	93
Oxygen	43
pH/ORP	14
SAC	85
Turbidity and solids	78
Cell constant	25, 152
Chlorine	
Calibration accessories	191
Calibration settings	57
Diagnostics settings	58
Process errors without messages	120
Conductivity	
Advanced setup	31
Basic settings	24
Calibration	152
Diagnostics settings	32
Limits operating hours	33
Process errors without messages	118
Unit	28
Conductivity calibration solutions	191
D	
Device-specific diagnostics messages	124
Diagnostics messages	
Device-specific	124
Possible settings	138
Sensor-specific	124
Diagnostics settings	
Conductivity	32
Disinfection	58
Drinking water turbidity	70
Interface	114
ISE	100
Nitrate	94
Oxygen	44
pH/ORP	16
SAC	86

Turbidity and solids	79
Disinfection	
Advanced setup	54
Basic settings	53
Calibration	162
Calibration settings	57
Diagnostics settings	58
Limits operating hours	61
Medium and temperature compensation	55
Polarization	163
Reference measurement	164
Types of calibration	163
Unit	54
Documentation	5
Drinking water turbidity	
Advanced setup	67
Basic settings	66
Calibration settings	69
Diagnostics settings	70
Limits operating hours	71
Unit	68

E

Electrolyte counter	50
-------------------------------	----

F

Fermenter scaling	160
Flash rate	84, 92

I

Impedance monitoring	16
Inputs	
Conductivity	24
Disinfection	53
Drinking water turbidity	66
General	10
Interface	110
ISE	99
Nitrate	91
Oxygen	38
pH/ORP	11
SAC	83
Turbidity and solids	75
Installation factor	25, 153
Interface	
Advanced setup	113
Basic settings	110
Diagnostics settings	114
Tank configuration	110
ISE	
Advanced setup	100
Basic settings	99
Calibration	166
Calibration accessories	191
Calibration settings	106
Diagnostics settings	100
Limits operating hours	101

Measured variable	103	Process check system (PCS)	19
Process errors without messages	121	Process errors without messages	117
L		R	
Limits operating hours		Residual coupling	153
Cap	49	S	
Conductivity	33	SAC	
Disinfection	61	Advanced setup	84
Drinking water turbidity	71	Basic settings	83
ISE	101	Calibration	181
Nitrate	95	Calibration accessories	191
Oxygen	48	Calibration settings	85
pH/ORP	19	Diagnostics settings	86
SAC	87	Limits operating hours	87
Turbidity and solids	80	Process errors without messages	122
M		Unit	84
Maintenance	141	Sample calibration	
Measured variable ISE	103	Oxygen	160
N		Sensor Check System (SCS)	16
Nitrate		Sensor Condition Check (SCC)	18
Advanced setup	92	Sensor information	140
Basic settings	91	Sensor-specific diagnostics messages	124
Calibration	185	Slope calibration	
Calibration accessories	191	Disinfection	164
Calibration settings	93	Oxygen	157
Diagnostics settings	94	Symbols	4
Limits operating hours	95	T	
Process errors without messages	122	Tank configuration Interface	110
Unit	92	Turbidity and solids	
O		Advanced setup	76
Operating mode	25	Basic settings	75
ORP buffer	190	Calibration	171
Oxygen		Calibration settings	78
Advanced setup	39	Diagnostics settings	79
Basic settings	38	Limits operating hours	80
Calibration	155	Process errors without messages	122
Calibration accessories	191	Unit	77
Calibration settings	43	W	
Diagnostics settings	44	Warnings	4
Electrolyte counter	50	Z	
Limits operating hours	48, 49	Zero point calibration	
Process errors without messages	119	Disinfection	164
Unit	39	Oxygen	159
P			
pH buffer	190		
pH/ORP			
Advanced setup	12		
Basic settings	11		
Calibration	145		
Calibration settings	14		
Diagnostics settings	16		
Limits operating hours	19		
Process errors without messages	117		
Pharmaceutical water	35		
Point at oxygen	157		
Polarization compensation	34		



71431514

www.addresses.endress.com
