

# Technical Information

## Proline Prosonic Flow E 100

Ultrasonic time-of-flight flowmeter



Cost-efficient ultrasonic time-of-flight flowmeter with integrated temperature measurement

### Application

- The measuring principle is independent of pressure, density, temperature and conductivity
- Bidirectional measuring of demineralized water for Utilities, e.g. in boiler condensate return lines

### Device properties

- Measurement accuracy up to 0.5 % for flow and  $\pm 2.0$  °C ( $\pm 3.6$  °F) for temperature
- Process temperatures up to 150 °C (302 °F)
- Entire sensor housing made of stainless steel
- 4-20 mA HART, pulse/frequency output
- Local display for reading and monitoring available
- Robust transmitter housing

### Your benefits

- Long-term stability – reliable, robust sensor
- Reducing further measuring point – multivariable device
- Dependable flow measurement – high turndown (200:1)
- Time-saving local operation without additional software and hardware – integrated web server
- Extended calibration intervals – integrated device verification due to Heartbeat Technology
- Easy commissioning – brief parameter explanations

## Table of contents

<b>About this document</b> . . . . .	<b>3</b>	Thermal insulation . . . . .	22
Symbols used . . . . .	3	<b>Mechanical construction</b> . . . . .	<b>22</b>
<b>Function and system design</b> . . . . .	<b>4</b>	Dimensions in SI units . . . . .	22
Measuring principle . . . . .	4	Dimensions in US units . . . . .	25
Measuring system . . . . .	4	Weight . . . . .	27
Safety . . . . .	5	Materials . . . . .	27
<b>Input</b> . . . . .	<b>5</b>	Process connections . . . . .	28
Measured variable . . . . .	5	<b>Operability</b> . . . . .	<b>28</b>
Measuring range . . . . .	5	Operating concept . . . . .	28
Operable flow range . . . . .	6	Local display . . . . .	29
<b>Output</b> . . . . .	<b>6</b>	Remote operation . . . . .	29
Output signal . . . . .	6	Service interface . . . . .	29
Signal on alarm . . . . .	8	<b>Certificates and approvals</b> . . . . .	<b>30</b>
Low flow cut off . . . . .	9	CE mark . . . . .	30
Protocol-specific data . . . . .	9	C-Tick symbol . . . . .	30
<b>Power supply</b> . . . . .	<b>11</b>	HART certification . . . . .	30
Terminal assignment . . . . .	11	Pressure Equipment Directive . . . . .	30
Supply voltage . . . . .	12	Other standards and guidelines . . . . .	31
Power consumption . . . . .	12	<b>Ordering information</b> . . . . .	<b>31</b>
Current consumption . . . . .	12	<b>Application packages</b> . . . . .	<b>31</b>
Power supply failure . . . . .	12	Heartbeat Technology . . . . .	32
Electrical connection . . . . .	13	<b>Accessories</b> . . . . .	<b>32</b>
Potential equalization . . . . .	14	Communication-specific accessories . . . . .	32
Terminals . . . . .	14	Service-specific accessories . . . . .	33
Cable entries . . . . .	14	System components . . . . .	33
Cable specification . . . . .	14	<b>Supplementary documentation</b> . . . . .	<b>33</b>
<b>Performance characteristics</b> . . . . .	<b>15</b>	Standard documentation . . . . .	34
reference operating conditions . . . . .	15	Supplementary device-dependent documentation . . . . .	34
Maximum measured error . . . . .	15	<b>Registered trademarks</b> . . . . .	<b>34</b>
Repeatability . . . . .	16		
Influence of ambient temperature . . . . .	16		
<b>Installation</b> . . . . .	<b>16</b>		
Mounting location . . . . .	16		
Orientation . . . . .	16		
Inlet and outlet runs . . . . .	17		
<b>Environment</b> . . . . .	<b>18</b>		
Ambient temperature range . . . . .	18		
Storage temperature . . . . .	18		
Degree of protection . . . . .	18		
Shock resistance . . . . .	18		
Vibration resistance . . . . .	18		
Electromagnetic compatibility (EMC) . . . . .	18		
<b>Process</b> . . . . .	<b>18</b>		
Medium temperature range . . . . .	18		
Pressure-temperature ratings . . . . .	18		
Flow limit . . . . .	21		
Pressure loss . . . . .	21		
System pressure . . . . .	21		

## About this document

### Symbols used

#### Electrical symbols

Symbol	Meaning
	Direct current
	Alternating current
	Direct current and alternating current
	<b>Ground connection</b> A grounded terminal which, as far as the operator is concerned, is grounded via a grounding system.
	<b>Protective Earth (PE)</b> A terminal which must be connected to ground prior to establishing any other connections.  The ground terminals are situated inside and outside the device: <ul style="list-style-type: none"> <li>▪ Inner ground terminal: Connects the protective earth to the mains supply.</li> <li>▪ Outer ground terminal: Connects the device to the plant grounding system.</li> </ul>

#### Symbols for certain types of information

Symbol	Meaning
	<b>Permitted</b> Procedures, processes or actions that are permitted.
	<b>Preferred</b> Procedures, processes or actions that are preferred.
	<b>Forbidden</b> Procedures, processes or actions that are forbidden.
	<b>Tip</b> Indicates additional information.
	Reference to documentation.
	Reference to page.
	Reference to graphic.
	Visual inspection.

#### Symbols in graphics

Symbol	Meaning
1, 2, 3, ...	Item numbers
<b>1</b> , <b>2</b> , <b>3</b> , ...	Series of steps
A, B, C, ...	Views
A-A, B-B, C-C, ...	Sections
	Hazardous area
	Safe area (non-hazardous area)
	Flow direction

## Function and system design

### Measuring principle

The measuring device measures the flow velocity in the measuring tube based on an offset arrangement of ultrasonic sensors downstream. The design is non-invasive and does not have any moving parts.

The flow signal is established by alternating an acoustic signal between the sensor pairs and measuring the transit time of each transmission. Then utilizing the fact that sound travels faster with the flow versus against the flow, this differential time ( $\Delta T$ ) can be used to determine the fluids velocity between the sensors.

The volume flow rate is established by combining all the flow velocities determined by the sensor pairs with the cross sectional area of the meter body and extensive knowledge about fluid flow dynamics. The design of the sensors and their position ensures that only a short straight run of pipe upstream of the meter is required after typical flow obstructions such as bends in one or two planes.

Advance digital signal processing facilitates constant validation of the flow measurement reducing susceptibility to multiphase flow conditions and increases the reliability of the measurement.

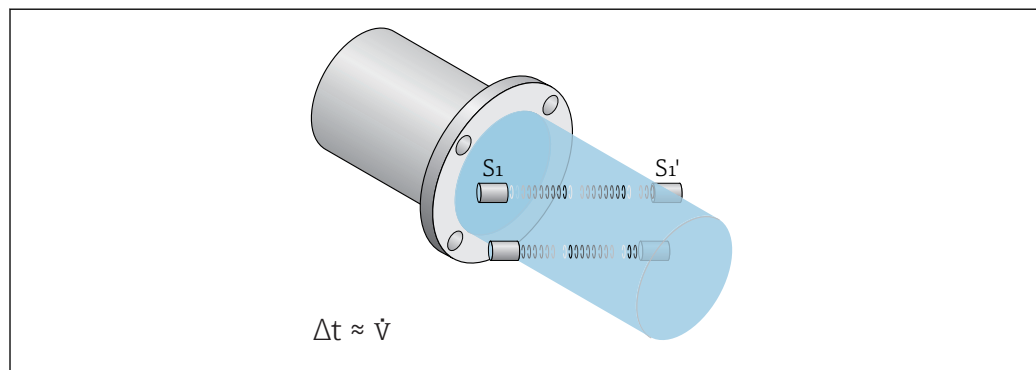

### Measuring system

The device consists of a transmitter and a sensor.

The device is available as a compact version:  
The transmitter and sensor form a mechanical unit.

#### Transmitter

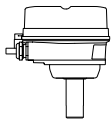
<p><b>Prosonic Flow 100</b></p>  <p style="text-align: right; font-size: small;">A0034558</p>	<p>Device versions and materials: Compact, aluminum, coated: Aluminum, AlSi10Mg, coated</p> <p>Configuration:</p> <ul style="list-style-type: none"> <li>■ Via operating tools (e.g. FieldCare, DeviceCare)</li> <li>■ Also for device version with 4-20 mA HART, pulse/frequency/switch output: Via Web browser (e.g. Microsoft Internet Explorer)</li> </ul>
--	--

**Sensor**

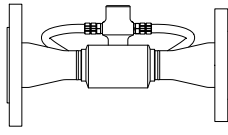
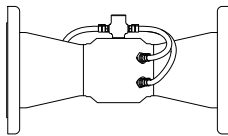
<p><b>Prosonic Flow E</b></p> <p><i>Single-path version: DN 50 to 80(2 to 3")</i></p>  <p style="text-align: right; font-size: small;">A0034556</p>	<ul style="list-style-type: none"> <li>■ Designed exclusively to measure:                             <ul style="list-style-type: none"> <li>- Water</li> <li>- Hot water</li> </ul> </li> <li>■ Range of nominal diameter: DN 50 to 150 (2 to 6")</li> <li>■ Materials:                             <ul style="list-style-type: none"> <li>- Measuring tube: Stainless steel, 1.4301 (F304)</li> <li>- Cones: Stainless steel, 1.4301 (F304)</li> <li>- Ultrasonic sensors: Stainless steel: 1.4301 (F304)</li> <li>- Smooth flange: Stainless steel: 1.4571 (316Ti)</li> <li>- Slip-on flange: Stainless steel: 1.4404 (F316L)</li> <li>- Lap joint flange: Steel: 1.0038 (S235JR) Stainless steel: 1.4306 (F304L), 1.4307 (F304L)</li> <li>- Lap joint flange: Steel: A105 Stainless steel: 1.4404 (F316L)</li> <li>- Lap joint flange, stamped plate: Steel: 1.0038 (S235JR) Stainless steel: 1.4301 (F304)</li> </ul> </li> </ul>
<p><i>Two-path version: DN 100 to 150(4 to 6")</i></p>  <p style="text-align: right; font-size: small;">A0034557</p>	

**Safety**

**IT security**

We only provide a warranty if the device is installed and used as described in the Operating Instructions. The device is equipped with security mechanisms to protect it against any inadvertent changes to the device settings.

IT security measures in line with operators' security standards and designed to provide additional protection for the device and device data transfer must be implemented by the operators themselves.

**Input**

**Measured variable**

**Direct measured variables**

- Flow velocity
- Medium temperature
- Sound velocity

**Calculated measured variables**

- Volume flow
- Mass flow

**Measuring range**

Typically  $v = 0$  to 5 m/s (0 to 16.4 ft/s) with the specified accuracy



*Flow characteristic values in SI units*

Nominal diameter		Recommended flow min./max. full scale value	Factory settings		
			Full scale value current output	Pulse value	Low flow cut off ( $v \sim 0.1$ m/s)
[mm]	[in]	[dm <sup>3</sup> /min]	[dm <sup>3</sup> /min]	[dm <sup>3</sup> /pulse]	[dm <sup>3</sup> /min]
50	2	0 to 720	720	3	14.4
65	2 ½	0 to 1200	1200	4	24.0
80	3	0 to 1680	1680	6	33.6

Nominal diameter		Recommended flow min./max. full scale value	Factory settings		
			Full scale value current output	Pulse value	Low flow cut off (v ~ 0.1 m/s)
[mm]	[in]	[dm <sup>3</sup> /min]	[dm <sup>3</sup> /min]	[dm <sup>3</sup> /pulse]	[dm <sup>3</sup> /min]
100	4	0 to 2880	2880	10	57.6
150	6	0 to 6360	6360	25	127.2

Flow characteristic values in US units

Nominal diameter		Recommended flow min./max. full scale value	Factory settings		
			Full scale value current output	Pulse value	Low flow cut off (v ~ 0.1 m/s)
[in]	[mm]	[gal/min]	[gal/min]	[gal/pulse]	[gal/min]
2	50	0 to 190	190	0.8	3.8
2 ½	65	0 to 317	317	1.1	6.3
3	80	0 to 444	444	1.6	8.9
4	100	0 to 761	761	2.6	15.2
6	150	0 to 1680	1680	6.6	33.6

 To calculate the measuring range, use the *Applicator* sizing tool →  33

#### Recommended measuring range

"Flow limit" section →  21

Operable flow range

Over 200:1

## Output

Output signal

HART current output

Current output	4-20 mA HART (active)
Maximum output values	<ul style="list-style-type: none"> <li>■ DC 24 V (no flow)</li> <li>■ 22.5 mA</li> </ul>
Load	0 to 700 Ω
Resolution	0.38 μA

<b>Damping</b>	Adjustable: 0.07 to 999 s
<b>Assignable measured variables</b>	<ul style="list-style-type: none"> <li>▪ Volume flow</li> <li>▪ Mass flow</li> <li>▪ Sound velocity</li> <li>▪ Flow velocity</li> <li>▪ Temperature</li> <li>▪ Acceptance rate <sup>1)</sup></li> <li>▪ Signal strength <sup>1)</sup></li> <li>▪ Signal to noise ratio <sup>1)</sup></li> <li>▪ Turbulence <sup>1)</sup></li> <li>▪ Signal asymmetry <sup>2)</sup></li> </ul> <p> The range of options increases if the measuring device has one or more application packages.</p>

- 1) Only with Heartbeat (Monitoring)  
 2) Only with Heartbeat (Monitoring) and dual path version

**Pulse/frequency/switch output**

<b>Function</b>	Can be set to pulse, frequency or switch output
<b>Version</b>	Passive, open collector
<b>Maximum input values</b>	<ul style="list-style-type: none"> <li>▪ DC 30 V</li> <li>▪ 25 mA</li> </ul>
<b>Voltage drop</b>	For 25 mA: ≤ DC 2 V
<b>Pulse output</b>	
<b>Pulse width</b>	Adjustable: 0.05 to 2 000 ms
<b>Maximum pulse rate</b>	10 000 Impulse/s
<b>Pulse value</b>	Adjustable
<b>Assignable measured variables</b>	<ul style="list-style-type: none"> <li>▪ Volume flow</li> <li>▪ Mass flow</li> </ul>
<b>Frequency output</b>	
<b>Output frequency</b>	Adjustable: 0 to 10 000 Hz
<b>Damping</b>	Adjustable: 0 to 999 s
<b>Pulse/pause ratio</b>	1:1
<b>Assignable measured variables</b>	<ul style="list-style-type: none"> <li>▪ Volume flow</li> <li>▪ Mass flow</li> <li>▪ Sound velocity</li> <li>▪ Flow velocity</li> <li>▪ Temperature</li> <li>▪ Acceptance rate <sup>1)</sup></li> <li>▪ Signal strength <sup>1)</sup></li> <li>▪ Signal to noise ratio <sup>1)</sup></li> <li>▪ Turbulence <sup>1)</sup></li> <li>▪ Signal asymmetry <sup>2)</sup></li> </ul>
<b>Switch output</b>	
<b>Switching behavior</b>	Binary, conductive or non-conductive
<b>Switching delay</b>	Adjustable: 0 to 100 s

<b>Number of switching cycles</b>	Unlimited
<b>Assignable functions</b>	<ul style="list-style-type: none"> <li>▪ Off</li> <li>▪ On</li> <li>▪ Diagnostic behavior</li> <li>▪ Limit value: <ul style="list-style-type: none"> <li>- Off</li> <li>- Volume flow</li> <li>- Mass flow</li> <li>- Sound velocity <sup>1)</sup></li> <li>- Flow velocity</li> <li>- Totalizer 1-3</li> <li>- Temperature</li> <li>- Signal strength <sup>1)</sup></li> <li>- Signal to noise ratio <sup>1)</sup></li> <li>- Turbulence <sup>1)</sup></li> <li>- Signal asymmetry <sup>2)</sup></li> <li>- Acceptance rate <sup>1)</sup></li> </ul> </li> <li>▪ Flow direction monitoring</li> <li>▪ Status <ul style="list-style-type: none"> <li>Low flow cut off</li> </ul> </li> </ul> <p> The range of options increases if the measuring device has one or more application packages.</p>

1) Only with Heartbeat (Monitoring)

2) Only with Heartbeat (Monitoring) and dual path version

## Signal on alarm

Depending on the interface, failure information is displayed as follows:

### Current output 4 to 20 mA

4 to 20 mA

<b>Failure mode</b>	Choose from: <ul style="list-style-type: none"> <li>▪ 4 to 20 mA in accordance with NAMUR recommendation NE 43</li> <li>▪ 4 to 20 mA in accordance with US</li> <li>▪ Min. value: 3.59 mA</li> <li>▪ Max. value: 22.5 mA</li> <li>▪ Freely definable value between: 3.59 to 22.5 mA</li> <li>▪ Actual value</li> <li>▪ Last valid value</li> </ul>
---------------------	--

### Pulse/frequency/switch output

<b>Pulse output</b>	
<b>Failure mode</b>	Choose from: <ul style="list-style-type: none"> <li>▪ Actual value</li> <li>▪ No pulses</li> </ul>
<b>Frequency output</b>	
<b>Failure mode</b>	Choose from: <ul style="list-style-type: none"> <li>▪ Actual value</li> <li>▪ 0 Hz</li> <li>▪ Defined value: 0 to 12 500 Hz</li> </ul>
<b>Switch output</b>	
<b>Failure mode</b>	Choose from: <ul style="list-style-type: none"> <li>▪ Current status</li> <li>▪ Open</li> <li>▪ Closed</li> </ul>

**Local display**



<b>Plain text display</b>	With information on cause and remedial measures
<b>Backlight</b>	Red backlighting indicates a device error.

 Status signal as per NAMUR recommendation NE 107

**Interface/protocol**

- Via digital communication:  
HART protocol
- Via service interface  
CDI-RJ45 service interface

<b>Plain text display</b>	With information on cause and remedial measures
---------------------------	---

 Additional information on remote operation →  29

**Web server**

<b>Plain text display</b>	With information on cause and remedial measures
---------------------------	---

---

**Low flow cut off**                      The switch points for low flow cut off are user-selectable.

**Protocol-specific data**

**HART**

<b>Manufacturer ID</b>	0x11
<b>Device type ID</b>	115C
<b>HART protocol revision</b>	7.5
<b>Device description files (DTM, DD)</b>	Information and files under: <a href="http://www.endress.com">www.endress.com</a>
<b>HART load</b>	Min. 250 Ω

<b>Dynamic variables</b>	<p>Read out the dynamic variables: HART command 3 The measured variables can be freely assigned to the dynamic variables.</p> <p><b>Measured variables for PV (primary dynamic variable)</b></p> <ul style="list-style-type: none"> <li>▪ Volume flow</li> <li>▪ Mass flow</li> <li>▪ Sound velocity</li> <li>▪ Flow velocity</li> <li>▪ Temperature</li> <li>▪ Acceptance rate <sup>1)</sup></li> <li>▪ Signal strength <sup>1)</sup></li> <li>▪ Signal to noise ratio <sup>1)</sup></li> <li>▪ Turbulence <sup>1)</sup></li> <li>▪ Signal asymmetry <sup>2)</sup></li> </ul> <p><b>Measured variables for SV, TV, QV (secondary, tertiary and quaternary dynamic variable)</b></p> <ul style="list-style-type: none"> <li>▪ Volume flow</li> <li>▪ Mass flow</li> <li>▪ Sound velocity</li> <li>▪ Flow velocity</li> <li>▪ Temperature</li> <li>▪ Acceptance rate <sup>1)</sup></li> <li>▪ Signal strength <sup>1)</sup></li> <li>▪ Signal to noise ratio <sup>1)</sup></li> <li>▪ Turbulence <sup>1)</sup></li> <li>▪ Signal asymmetry <sup>2)</sup></li> <li>▪ Totalizer 1</li> <li>▪ Totalizer 2</li> <li>▪ Totalizer 3</li> </ul> <p> The range of options increases if the measuring device has one or more application packages.</p>
<b>Device variables</b>	<p>Read out the device variables: HART command 9 The device variables are permanently assigned.</p> <p>A maximum of 8 device variables can be transmitted:</p> <ul style="list-style-type: none"> <li>▪ 0 = volume flow</li> <li>▪ 1 = mass flow</li> <li>▪ 2 = sound velocity</li> <li>▪ 3 = flow velocity</li> <li>▪ 4 = temperature</li> <li>▪ 5 = totalizer 1</li> <li>▪ 6 = totalizer 2</li> <li>▪ 7 = totalizer 3</li> <li>▪ 8 = acceptance rate</li> <li>▪ 9 = turbulence</li> <li>▪ 10 = signal to noise ratio</li> <li>▪ 11 = signal asymmetry</li> <li>▪ 12 = signal strength</li> </ul>

1) Only with Heartbeat (Monitoring)

2) Only with Heartbeat (Monitoring) and dual path version

## Power supply

**Terminal assignment**

**Overview: housing version and connection versions**

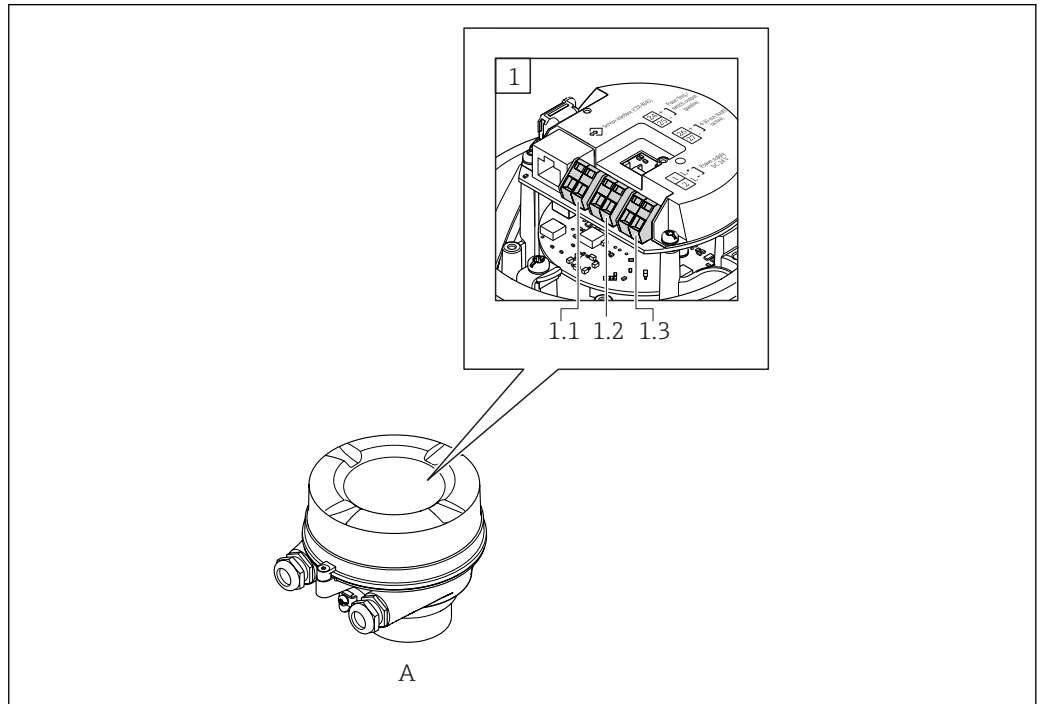

A0033550

- A Housing version: compact, aluminum coated
- 1 Connection version: 4-20 mA HART, pulse/frequency/switch output
- 1.1 Signal transmission: pulse/frequency/switch output
- 1.2 Signal transmission: 4-20 mA HART
- 1.3 Supply voltage

**Transmitter**

Connection version 4-20 mA HART with pulse/frequency/switch output

Order code for "Output", option B

Order code "Housing"	Connection methods available		Possible options for order code "Electrical connection"
	Outputs	Power supply	
Option A	Terminals	Terminals	<ul style="list-style-type: none"> <li>▪ Option A: coupling M20x1</li> <li>▪ Option B: thread M20x1</li> <li>▪ Option C: thread G ½"</li> <li>▪ Option D: thread NPT ½"</li> </ul>
Order code for "Housing": Option A: compact, coated aluminum			

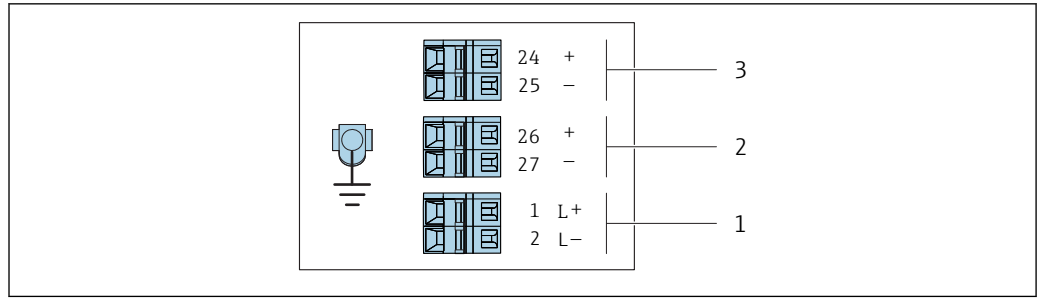

A001688B

1 Terminal assignment 4-20 mA HART with pulse/frequency/switch output

- 1 Power supply: DC 24 V
- 2 Output 1: 4-20 mA HART (active)
- 3 Output 2: pulse/frequency/switch output (passive)

Order code "Output"	Terminal number					
	Power supply		Output 1		Output 2	
	2 (L-)	1 (L+)	27 (-)	26 (+)	25 (-)	24 (+)
Option B	DC 24 V		4-20 mA HART (active)		Pulse/frequency/switch output (passive)	
Order code for "Output": Option B: 4-20 mA HART with pulse/frequency/switch output						

**Supply voltage**

The power unit must be tested to ensure it meets safety requirements (e.g. PELV, SELV).

**Transmitter**

For device version with HART communication type: DC 19.2 to 28.8 V

**Power consumption**

**Transmitter**

Order code for "Output"	Maximum Power consumption
Option B: 4-20 mA HART with pulse/frequency/switch output	3.0 W

**Current consumption**

**Transmitter**

Order code for "Output"	Maximum Current consumption	Maximum switch-on current
Option B: 4-20mA HART, pul./freq./switch output	200 mA	30 A (< 0.275 ms)

**Power supply failure**

Depending on the device version, the configuration is retained in the device memory or in the pluggable data memory (HistoROM DAT).

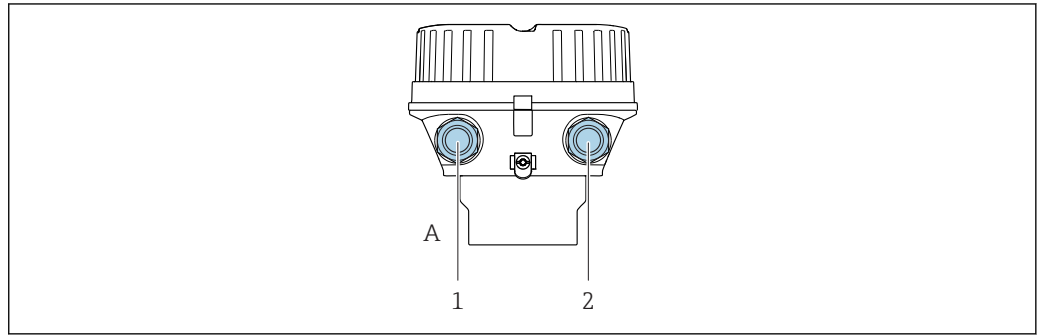

Electrical connection

Connecting the transmitter



A0030221

- A Housing version: compact, aluminum coated
- 1 Cable entry for signal transmission
- 2 Cable entry for supply voltage

 Terminal assignment →  11

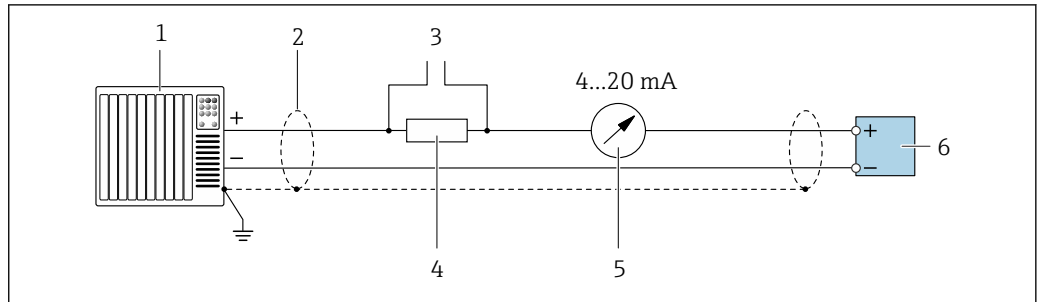

Connection examples

Current output 4 to 20 mA HART



A0029055

 2 Connection example for 4 to 20 mA HART current output (active)

- 1 Automation system with current input (e.g. PLC)
- 2 Cable shield: the cable shield must be grounded at both ends to comply with EMC requirements; observe cable specifications →  14
- 3 Connection for HART operating devices →  29
- 4 Resistor for HART communication ( $\geq 250 \Omega$ ): observe maximum load
- 5 Analog display unit: observe maximum load
- 6 Transmitter

## Pulse/frequency output

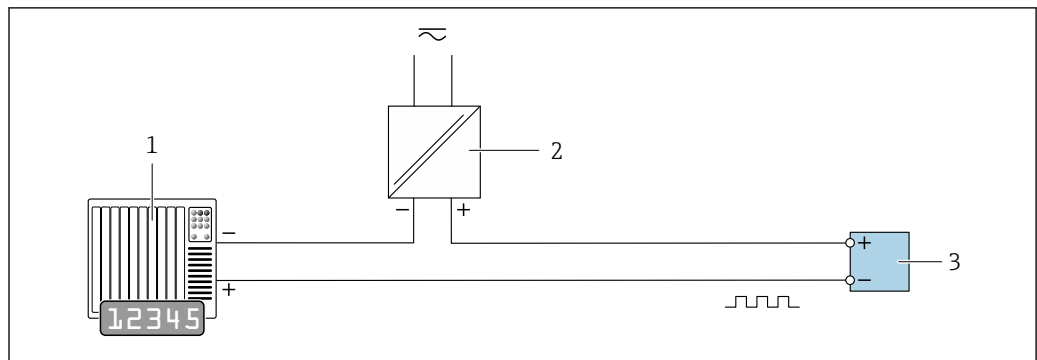

A0028761

3 Connection example for pulse/frequency output (passive)

- 1 Automation system with pulse/frequency input (e.g. PLC)
- 2 Power supply
- 3 Transmitter: Observe input values → 6

## Switch output

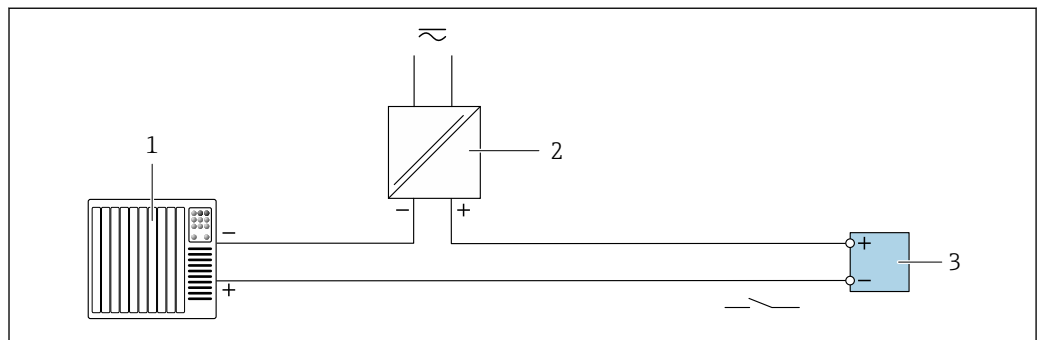

A0028760

4 Connection example for switch output (passive)

- 1 Automation system with switch input (e.g. PLC)
- 2 Power supply
- 3 Transmitter: Observe input values

## Potential equalization

## Requirements

No special measures for potential equalization are required.

## Terminals

## Transmitter

Spring terminals for wire cross-sections 0.5 to 2.5 mm<sup>2</sup> (20 to 14 AWG)

## Cable entries

- Cable gland: M20 × 1.5 with cable Ø 6 to 12 mm (0.24 to 0.47 in)
- Thread for cable entry:
  - M20
  - G ½"
  - NPT ½"

## Cable specification

## Permitted temperature range

- The installation guidelines that apply in the country of installation must be observed.
- The cables must be suitable for the minimum and maximum temperatures to be expected.

## Power supply cable

Standard installation cable is sufficient.

**Signal cable**

*Current output 4 to 20 mA HART*

A shielded cable is recommended. Observe grounding concept of the plant.

*Pulse/frequency/switch output*

Standard installation cable is sufficient.

**Performance characteristics**

**reference operating conditions**

- Error limits following DIN EN 29104, in future ISO 20456
- Water with +15 to +45 °C (+59 to +113 °F) at 2 to 6 bar (29 to 87 psi)
- Data as indicated in the calibration protocol
- Accuracy based on accredited calibration rigs according to ISO 17025

**Maximum measured error**

**Error limits under reference operating conditions**

o.r. = of reading; o.f.s. = of full scale value

**Volume flow**

- $v > 0.5$  m/s (1.64 ft/s):  $\pm 0.5$  % o.r.  $\pm 0.02$  % o.f.s.
- $v \leq 0.5$  m/s (1.64 ft/s):  $\pm 0.07$  % o.f.s.
- of full scale value: 5 m/s (16.4 ft/s)

-  ▪ Fluctuations in the supply voltage do not have any effect within the specified range.
- Temperature accuracy:  $\pm 2$  °C ( $\pm 3.8$  °F)

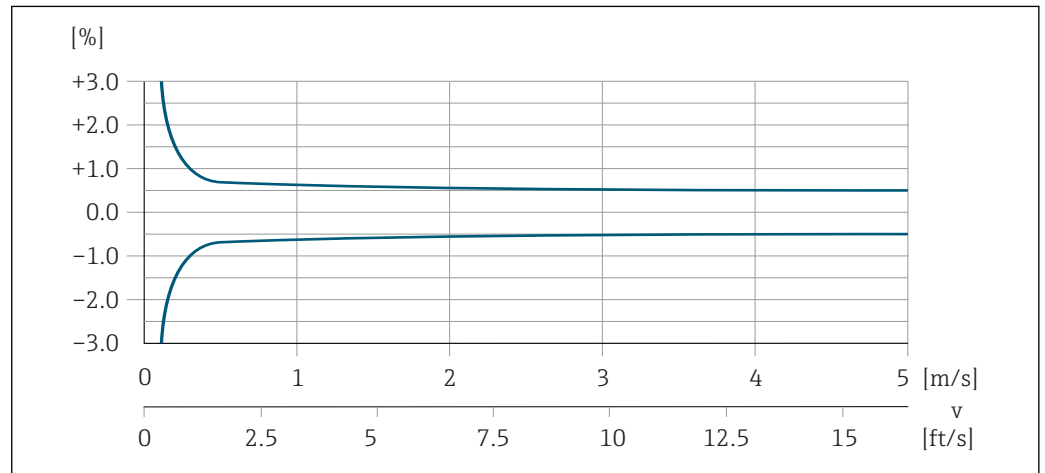

 5 Maximum measured error in % o.r.

**Accuracy of outputs**

 The output accuracy must be factored into the measured error if analog outputs are used, .

The outputs have the following base accuracy specifications.

*Current output*

<b>Accuracy</b>	Max. $\pm 5$ $\mu$ A
-----------------	----------------------

*Pulse/frequency output*

o.r. = of reading

<b>Accuracy</b>	Max. $\pm 50$ ppm o.r. (over the entire ambient temperature range)
-----------------	--

**Repeatability** o.r. = of reading

**Volume flow**  
 $\pm 0.1$  % o.r.

**Influence of ambient temperature**

**Current output**  
o.r. = of reading

<b>Temperature coefficient</b>	Max. $\pm 0.005$ % o.r./°C
--------------------------------	----------------------------

**Pulse/frequency output**

<b>Temperature coefficient</b>	No additional effect. Included in accuracy.
--------------------------------	---

## Installation

No special measures such as supports etc. are necessary. External forces are absorbed by the construction of the device.

**Mounting location**

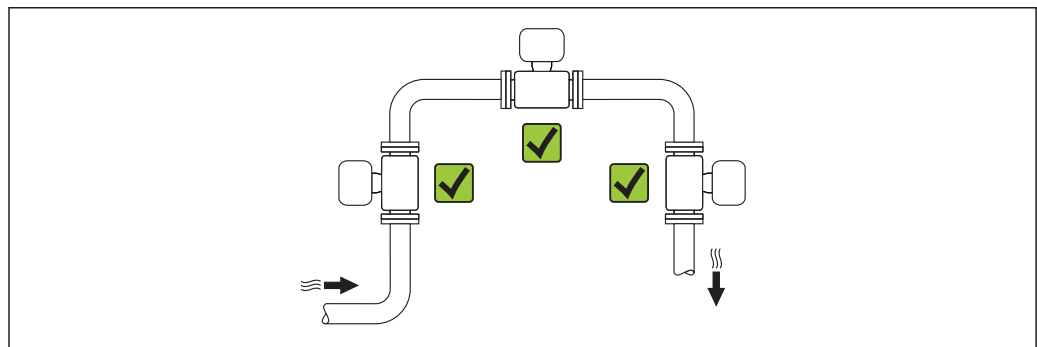

A0015543



**Orientation**

The direction of the arrow on the nameplate helps you to install the sensor according to the flow direction (direction of medium flow through the piping).

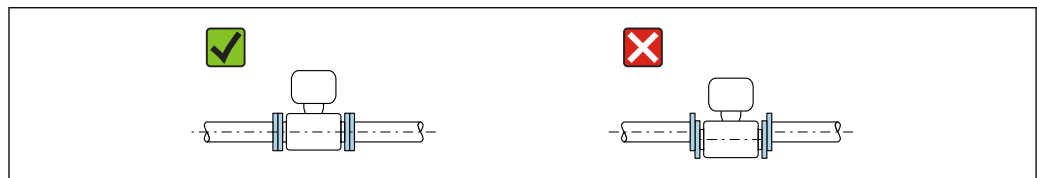
- i** ■ Install the measuring device in a parallel plane free of external mechanical stress.
- The internal diameter of the pipe must match the internal diameter of the sensor.

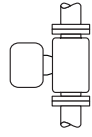
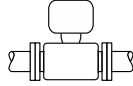
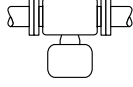

A0015895

Orientation		Compact version	
<b>A</b>	Vertical orientation	 A0015545	☑☑
<b>B</b>	Horizontal orientation, transmitter head up	 A0015589	☑☑
<b>C</b>	Horizontal orientation, transmitter head down	 A0015590	☑
<b>D</b>	Horizontal orientation, transmitter head at side	 A0015592	☒

**Inlet and outlet runs**

If possible, the sensor should be installed upstream from valves, T-pieces, elbows etc. To attain the specified level of accuracy of the measuring device, the below mentioned inlet and outlet runs must be maintained at minimum. If there are several flow disturbances present, the longest specified inlet run must be maintained.

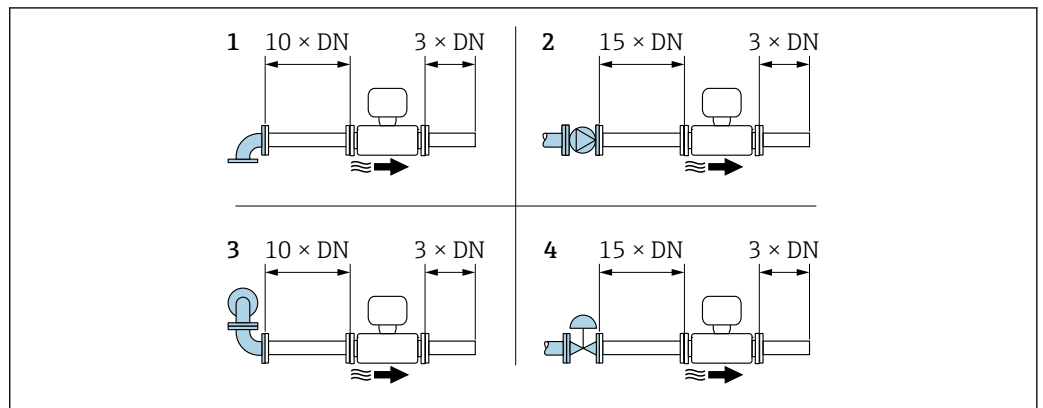

6 Minimum inlet and outlet runs with various flow obstructions

- 1 90° elbow or T-section
- 2 Pump
- 3 2 × 90° elbow, 3-dimensional
- 4 Control valve

**Outlet runs when installing external devices**

If installing an external device, observe the specified distance.

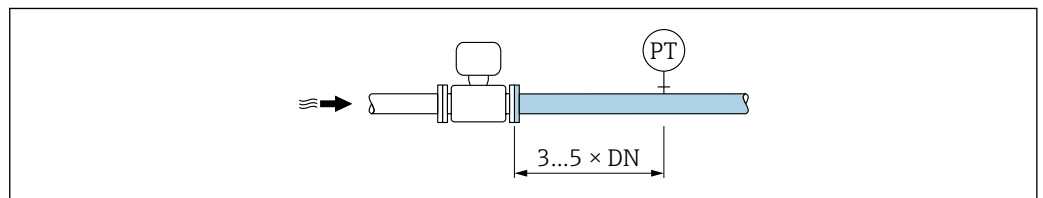

PT Pressure

## Environment

Ambient temperature range	Transmitter	-25 to +60 °C (-13 to +140 °F)
	Local display	-20 to +60 °C (-4 to +140 °F), the readability of the display may be impaired at temperatures outside the temperature range.
	Sensor	-25 to +60 °C (-13 to +140 °F)

- ▶ If operating outdoors:  
Avoid direct sunlight, particularly in warm climatic regions.

**Storage temperature** All components apart from display modules:  
-50 to +80 °C (-58 to +176 °F), preferably at +20 °C (+68 °F)

**Degree of protection** **Transmitter and sensor**

- As standard: IP66/67, type 4X enclosure
- When housing is open: IP20, type 1 enclosure

**Shock resistance** Shock due to rough handling following IEC 60068-2-31

**Vibration resistance**

- Oscillation, sinusoidal, following IEC 60068-2-6
  - 2 to 8.4 Hz, 3.5 mm peak
  - 8.4 to 500 Hz, 1 g peak
- Oscillation, broadband noise following IEC 60068-2-64
  - 10 to 200 Hz, 0.003 g<sup>2</sup>/Hz
  - 200 to 2 000 Hz, 0.001 g<sup>2</sup>/Hz
  - Total: 1.54 g rms

**Electromagnetic compatibility (EMC)**

- As per IEC/EN 61326-1, IEC/EN 61326-2-3 and NAMUR Recommendation 21 (NE 21)
- Complies with emission limits for industry as per EN 55011 (Class A)



Details are provided in the Declaration of Conformity.

## Process

**Medium temperature range** **Sensor**  
+0 to +150 °C (+32 to +302 °F)

**Pressure-temperature ratings** The following pressure/temperature diagrams apply to all pressure-bearing parts of the device and not just the process connection. The diagrams show the maximum permissible medium pressure depending on the specific medium temperature.



Process connections with carbon steel flange material are subject to the following minimum process temperatures:

- As per EN 1092: -10 °C (+14 °F)
- As per ASME: -29 °C (-20 °F)

**Smooth flange DIN EN 1092-1Type 01Shape B1, PN 16/25/40**

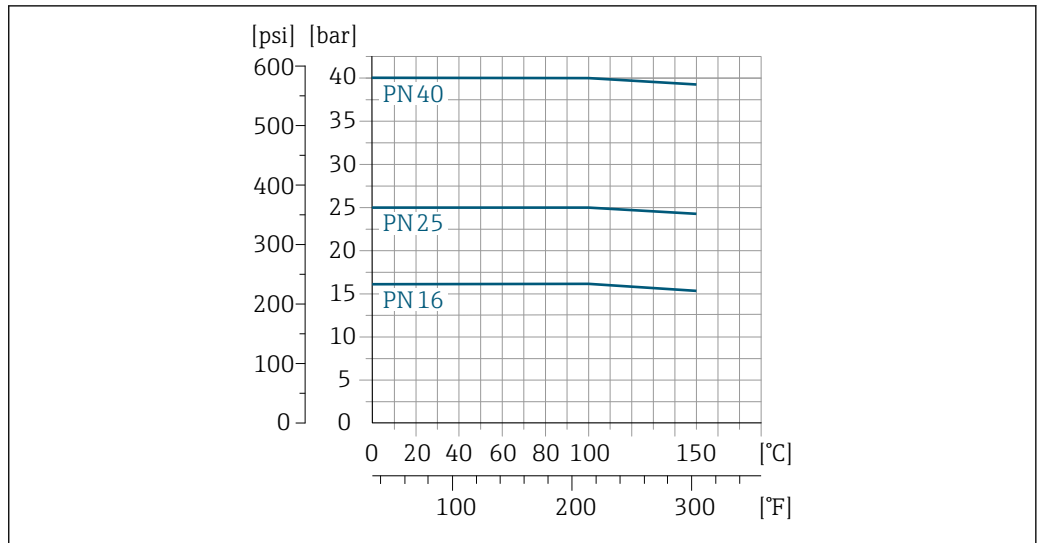

7 With flange material 1.4571 (316Ti)

A0033878-EN

**Slip-on flange following ASME B16.5, class 150**

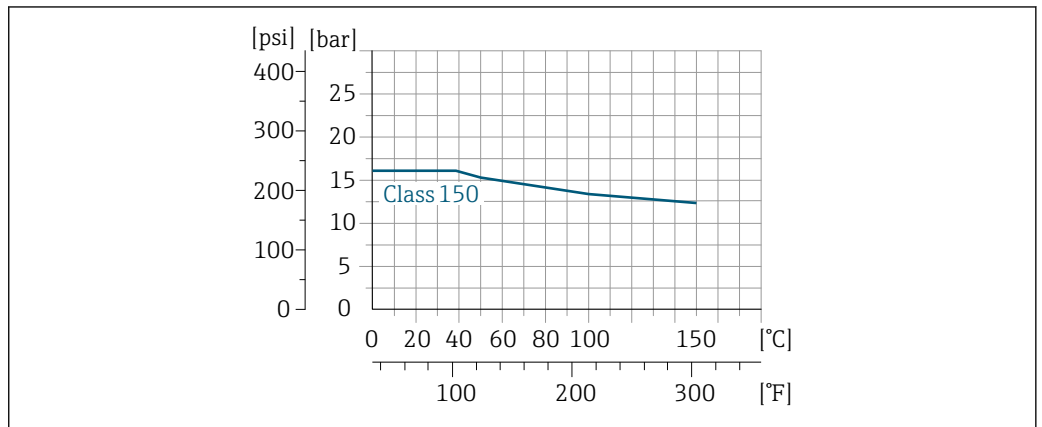

8 With flange material 1.4404 (F316L)

A0033879-EN

**Lap joint flange DIN EN 1092-1Type 02Shape A, PN 16**

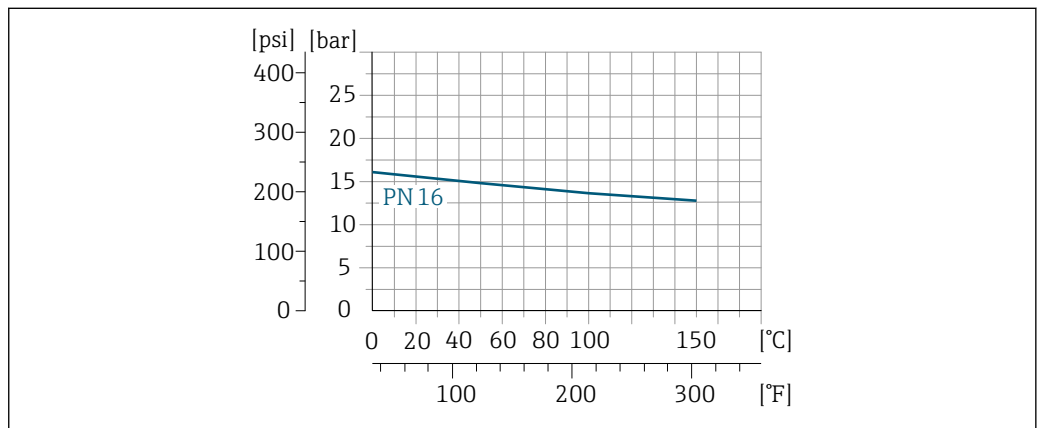

9 With flange material 1.0038 (S235JR); minimum process temperature → 18

A0033880-EN

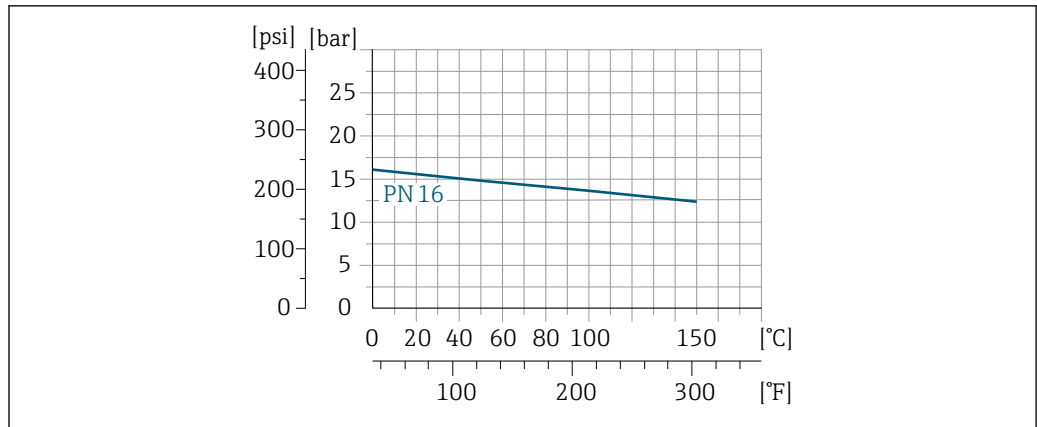

A0034554-EN

10 With flange material 1.4306 (F304L) and 1.4307 (F304L)

**Lap joint flange following ASME B16.5, class 150**

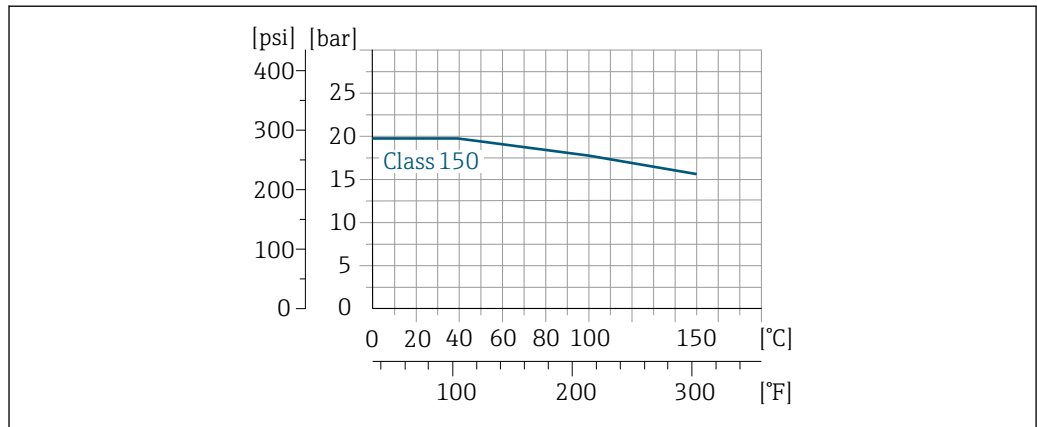

A0034555-EN

11 With flange material A105; minimum process temperature → 18

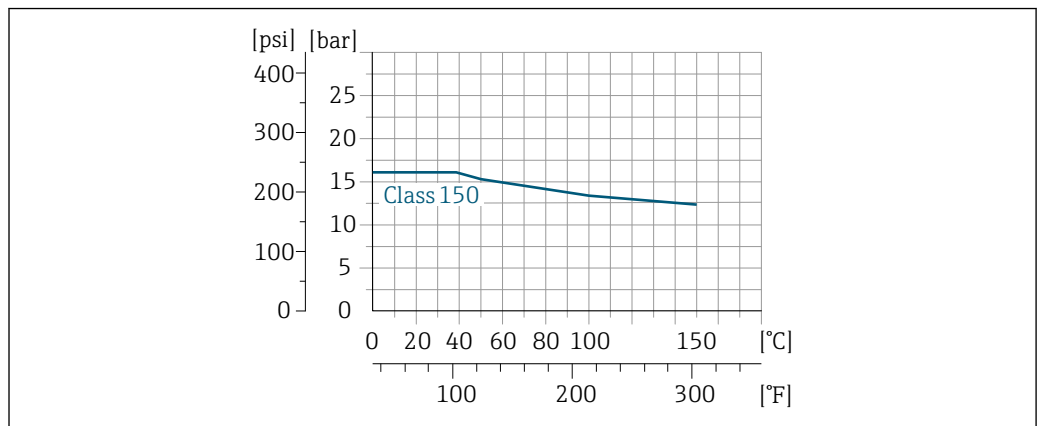

A0033879-EN

12 With flange material 1.4404 (F316L)

Lap joint flange, stamped plate following EN 1092-1(DIN 2501), PN 10

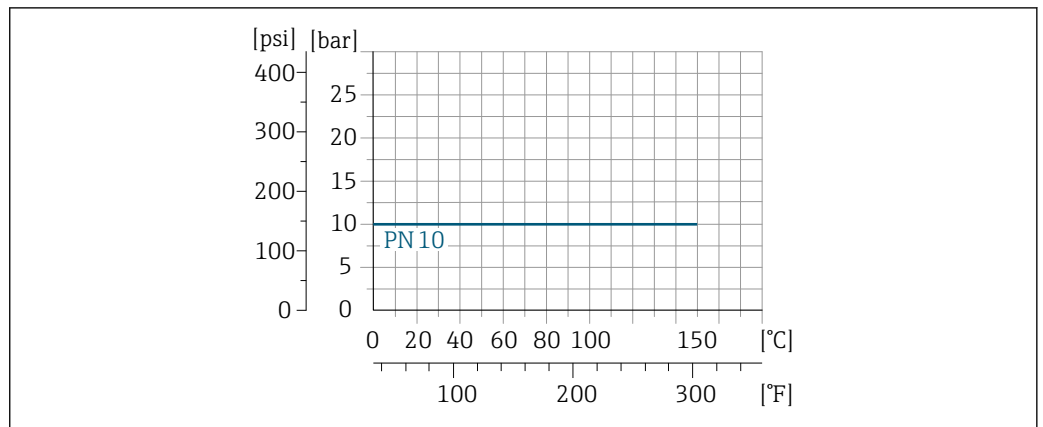

A0033882-EN

13 With flange material 1.0038 (S235JR) and 1.4301 (F304); minimum process temperature → 18

Flow limit

Select the nominal diameter by optimizing between the required flow range and permissible pressure loss.

**i** For an overview of the full scale values for the measuring range, see the "Measuring range" section → 5

- The minimum recommended full scale value is approx. 1/20 of the maximum full scale value.
- In most applications, 10 to 50 % of the maximum full scale value can be considered ideal.

Pressure loss

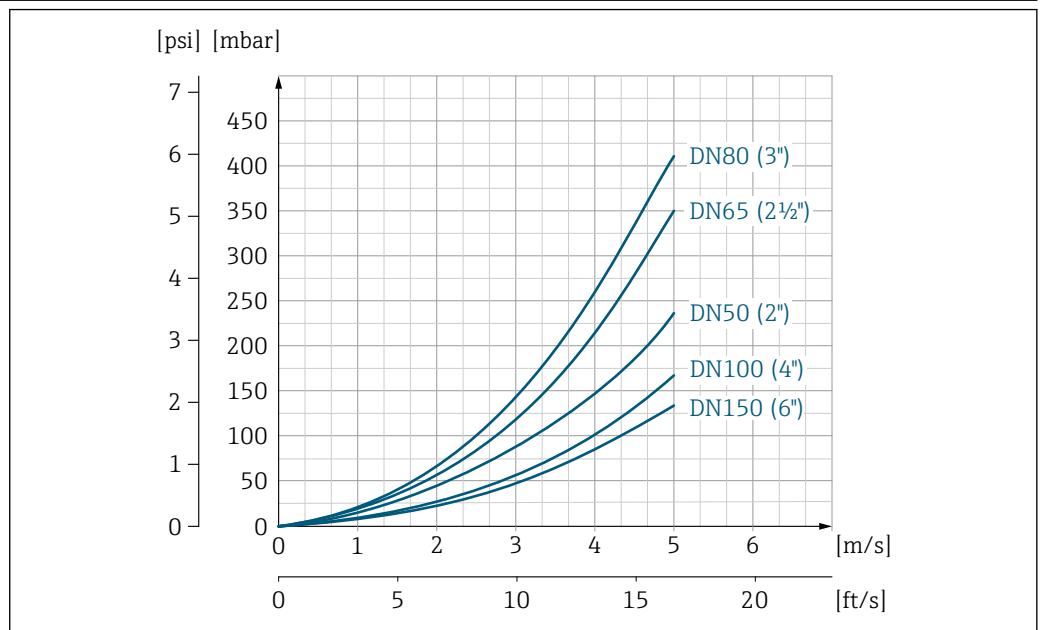

A0033770-EN

14 Pressure loss DN 50 to 150 (2 to 6")

To calculate the pressure loss, use the *Applicator* sizing tool → 33

System pressure

It is important that cavitation does not occur, or that gases entrained in the liquids do not outgas. This is prevented by means of a sufficiently high system pressure.

For this reason, the following mounting locations are recommended:

- At the lowest point in a vertical pipe
- Downstream from pumps (no danger of vacuum)

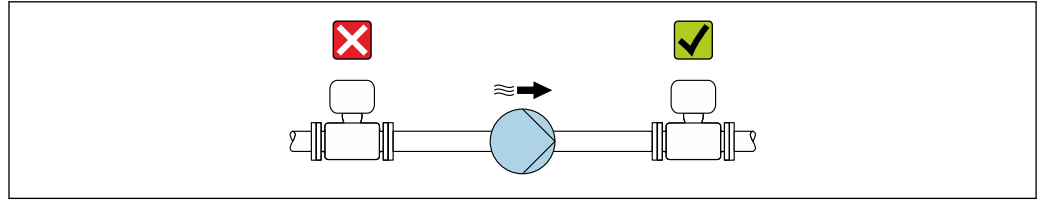

A0028777

**Thermal insulation**

In the case of some fluids, it is important to keep the heat radiated from the sensor to the transmitter to a low level. A wide range of materials can be used for the required insulation.

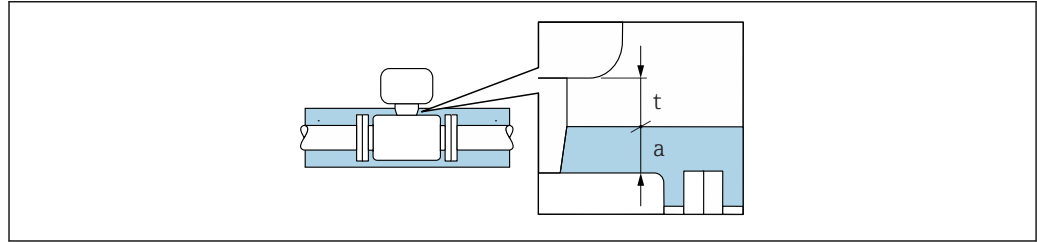

A0034104

t Maximum insulation thickness 2 cm (0.79 in)  
 a Minimum distance from transmitter to insulation

**Mechanical construction**

**Dimensions in SI units**

**Compact version**

Order code for "Housing", options A "Compact, aluminum, coated"

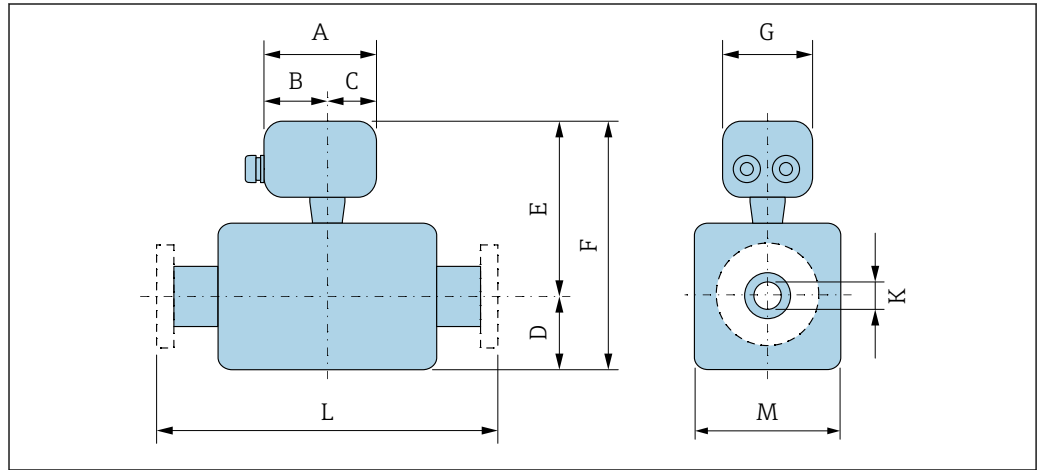

A0033784

DN [mm]	A [mm]	B [mm]	C [mm]	D [mm]	E <sup>1)</sup> [mm]	F <sup>1)</sup> [mm]	G [mm]	K <sup>2)</sup> [mm]	L [mm]	M [mm]
50	136	82	54	82.5	233.5	316	136	35	<sup>3)</sup>	61.5
65	136	82	54	92.5	238	330.5	136	43.8	<sup>3)</sup>	71
80	136	82	54	100	241	341	136	49.3	<sup>3)</sup>	76.5
100	136	82	54	117.5	258.5	376	136	75	<sup>3)</sup>	110
150	136	82	54	150	276.5	426.5	136	110.3	<sup>3)</sup>	145

1) When using a display (order code for "Display; Operation", option B): Values +28 mm

2) Tolerance: ±2 mm

3) Dependent on respective process connection

**Flange connections**

*Fixed flange*

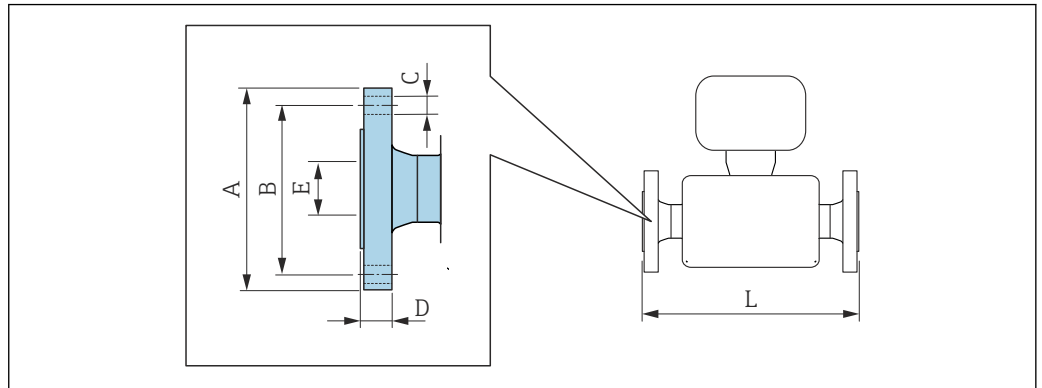

A0015621

**Smooth flange DIN EN 1092-1 Type 01 Shape B1, PN 16/25/40**  
 1.4571 (316Ti): Order code for "Process connection", option D51, D52, D53

DN [mm]	Pressure rating PN	A [mm]	B [mm]	C [mm]	D [mm]	E <sup>1)</sup> [mm]	L [mm]
50	40	165	125	4 × 18	20	56.3	300 <sup>2)</sup>
65	16/25	185	145	8 × 18	20/22	72.1	300 <sup>2)</sup>
80	16/25	200	160	8 × 18	20/24	84.5	350 <sup>3)</sup>
100	16/25	220/235	180/190	8 × 18/22	22/26	110.3	350 <sup>3)</sup>
150	16/25	285/300	240/250	8 × 22/26	24/30	164.3	500 <sup>3)</sup>

- 1) Tolerance: ±2 mm
- 2) Tolerance: 0/-2 mm
- 3) Tolerance: 0/-3 mm

**Slip-on flange following ASME B16.5: Class 150**  
 1.4404 (F316L): Order code for "Process connection", option A1S

DN [mm]	A [mm]	B [mm]	C [mm]	D [mm]	E <sup>1)</sup> [mm]	L [mm]
50	152.4	120.7	4 × 19.1	25.4	56.3	300 <sup>2)</sup>
80	190.5	152.4	4 × 19.1	30.2	84.5	350 <sup>3)</sup>
100	228.6	190.5	8 × 19.1	33.3	110.3	350 <sup>3)</sup>
150	279.4	241.3	8 × 22.4	39.6	164.3	500 <sup>3)</sup>

- 1) Tolerance: ±2 mm
- 2) Tolerance: 0/-2 mm
- 3) Tolerance: 0/-3 mm

## Lap joint flange

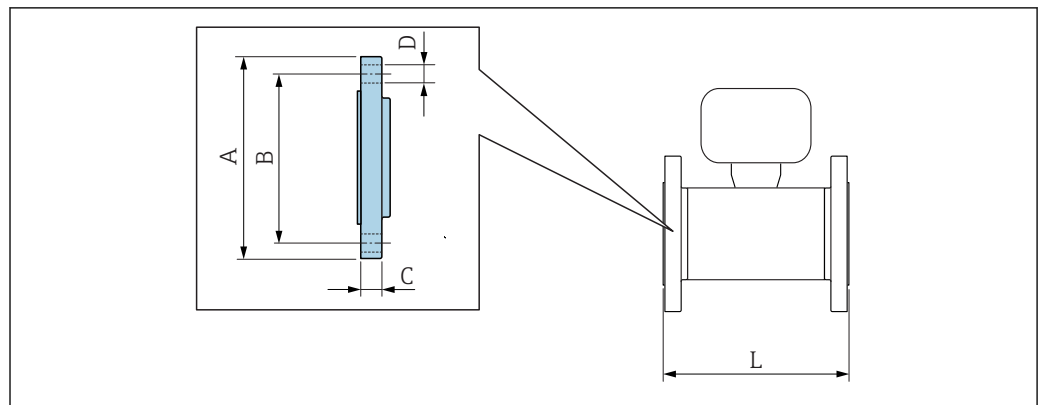

A0015457

**Lap joint flange DIN EN 1092-1 Type 02 Shape A: PN 16**

1.0038 (S235JR): Order code for "Process connection", option D32

1.4306 (F304L), 1.4307 (F304L): Order code for "Process connection", option D34

DN [mm]	A [mm]	B [mm]	C [mm]	D [mm]	L [mm]
50	165	125	20	4 × 18	300 <sup>1)</sup>
65	185	145	20	8 × 18	300 <sup>1)</sup>
80	200	160	20	8 × 18	350 <sup>2)</sup>
100	220	180	22	8 × 18	350 <sup>2)</sup>
150	285	240	24	8 × 22	500 <sup>2)</sup>

1) Tolerance: 0/-2 mm

2) Tolerance: 0/-3 mm

**Lap joint flange following ASME B16.5: Class 150**

A105: order code for "Process connection", option A12

1.4404 (F316L): order code for "Process connection", option A14

DN [mm]	A [mm]	B [mm]	C [mm]	D [mm]	L [mm]
50	152.4	120.7	25.4	4 × 19.1	300 <sup>1)</sup>
80	190.5	152.4	30.2	4 × 19.1	350 <sup>2)</sup>
100	228.6	190.5	33.3	8 × 19.1	350 <sup>2)</sup>
150	279.4	241.3	39.6	8 × 22.4	500 <sup>2)</sup>

1) Tolerance: 0/-2 mm

2) Tolerance: 0/-3 mm

Lap joint flange, stamped plate

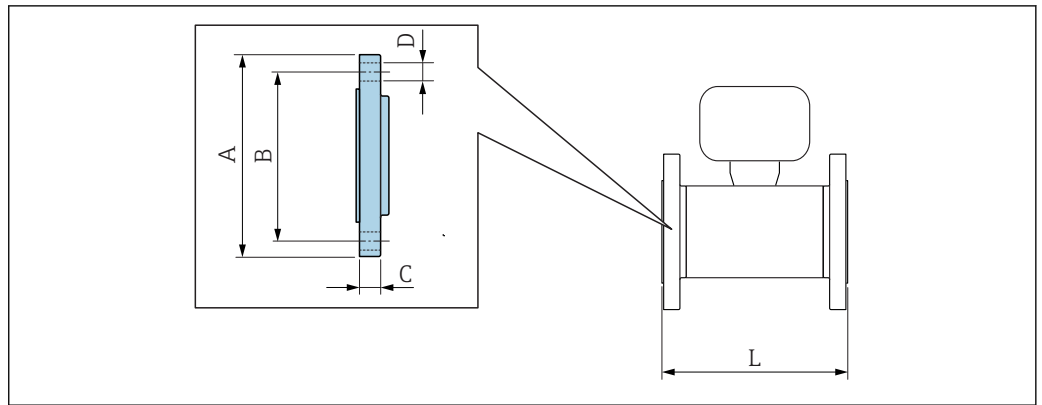

A0015457

Lap joint flange, stamped plate following EN 1092-1 (DIN 2501): PN 10

1.0038 (S235JR): order code for "Process connection", option D21

1.4301 (F304): order code for "Process connection", option D23

DN [mm]	A [mm]	B [mm]	C [mm]	D [mm]	L [mm]
50	165	125	18.5	4 × 17.5	300 <sup>1)</sup>
65	185	145	20.0	4 × 17.5	300 <sup>1)</sup>
80	200	160	23.5	8 × 17.5	350 <sup>2)</sup>
100	220	180	24.5	8 × 17.5	350 <sup>2)</sup>
150	285	240	25.0	8 × 21.5	500 <sup>2)</sup>

1) Tolerance: 0/-2 mm

2) Tolerance: 0/-3 mm

Dimensions in US units

Compact version

Order code for "Housing", options A "Compact, aluminum, coated"

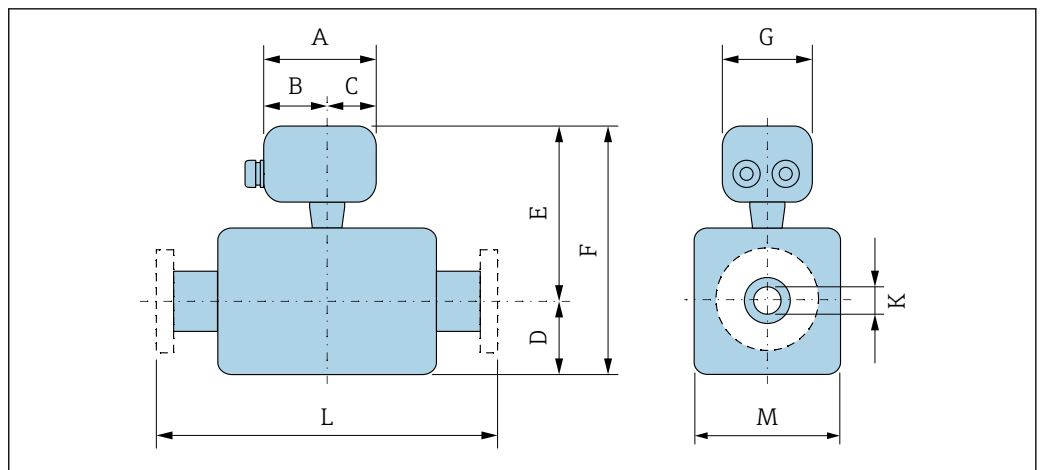

A0033784

DN [in]	A [in]	B [in]	C [in]	D [in]	E <sup>1)</sup> [in]	F <sup>1)</sup> [in]	G [in]	K <sup>2)</sup> [in]	L [in]	M [in]
2	5.35	3.23	2.13	3.25	9.19	12.4	5.35	1.38	<sup>3)</sup>	2.42
2 ½	5.35	3.23	2.13	3.64	9.37	13.0	5.35	1.72	<sup>3)</sup>	2.80
3	5.35	3.23	2.13	3.94	9.49	13.4	5.35	1.94	<sup>3)</sup>	3.01

DN [in]	A [in]	B [in]	C [in]	D [in]	E <sup>1)</sup> [in]	F <sup>1)</sup> [in]	G [in]	K <sup>2)</sup> [in]	L [in]	M [in]
4	5.35	3.23	2.13	4.63	10.2	14.8	5.35	2.95	<sup>3)</sup>	4.33
6	5.35	3.23	2.13	5.91	10.9	16.8	5.35	4.34	<sup>3)</sup>	5.71

- 1) When using a display (order code for "Display; Operation", option B): Values +1.1 in
- 2) Tolerance: ±0.08 in
- 3) Dependent on respective process connection

**Flange connections**

*Fixed flange*

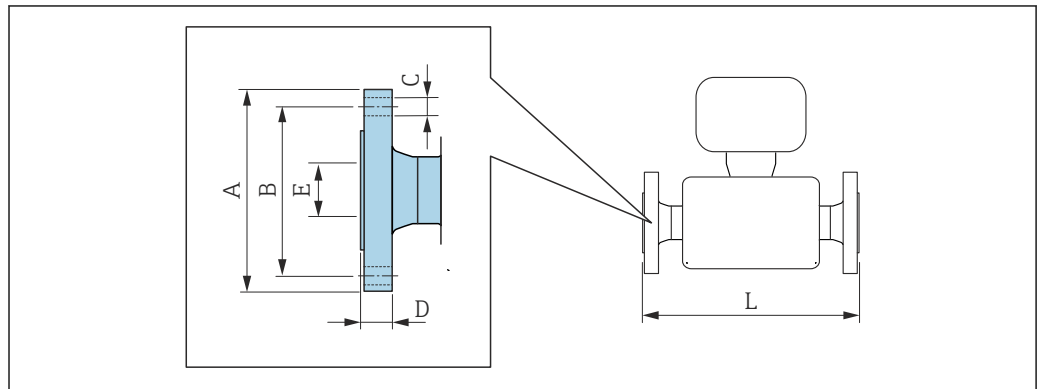

A0015621

<b>Slip-on flange following ASME B16.5: Class 150</b>						
<i>1.4404 (F316L): Order code for "Process connection", option A1S</i>						
DN [in]	A [in]	B [in]	C [in]	D [in]	E <sup>1)</sup> [in]	L [in]
2	6.00	4.75	4 × 0.75	1.00	2.22	11.8 <sup>2)</sup>
3	7.50	6.00	4 × 0.75	1.19	3.33	13.8 <sup>3)</sup>
4	9.00	7.50	8 × 0.75	1.31	4.34	13.8 <sup>3)</sup>
6	11.0	9.50	8 × 0.88	1.56	6.47	19.7 <sup>3)</sup>

- 1) Tolerance: ±0.08 in
- 2) Tolerance: 0/-0.08 in
- 3) Tolerance: 0/-0.12 in

*Lap joint flange*

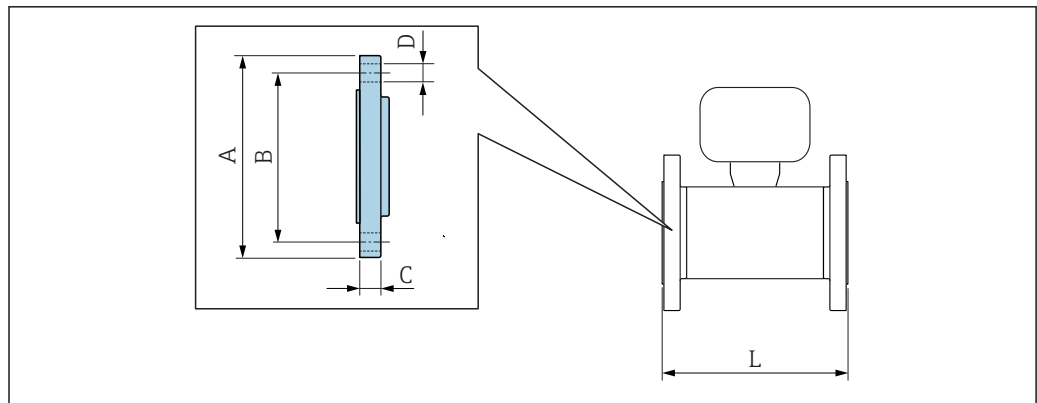

A0015457

**Lap joint flange following ASME B16.5: Class 150**  
*A105: order code for "Process connection", option A12*  
*1.4404 (F316L): order code for "Process connection", option A14*

DN [in]	A [in]	B [in]	C [in]	D [in]	L [in]
2	6.00	4.75	1.00	4 × 0.75	11.8 <sup>1)</sup>
3	7.50	6.00	1.19	4 × 0.75	13.8 <sup>2)</sup>
4	9.00	7.50	1.31	8 × 0.75	13.8 <sup>2)</sup>
6	11.0	9.50	1.56	8 × 0.88	19.7 <sup>2)</sup>

- 1) Tolerance: 0/-0.08 in  
 2) Tolerance: 0/-0.12 in

**Weight** **Weight in SI units**

*Compact version*

*Order code for "Housing", option A "Compact, aluminum, coated"*

Nominal diameter [mm]	Version	Fixed flange		Lap joint flange		Lap joint flange, stamped plate
		EN 1092-1 (DIN 2501) <sup>1)</sup> [kg]	ASME B16.5 <sup>2)</sup> [kg]	EN 1092-1 (DIN 2501) <sup>3)</sup> [kg]	ASME B16.5 <sup>2)</sup> [kg]	EN 1092-1 (DIN 2501) <sup>4)</sup> [kg]
50	Single-path	9.15	8.00	8.90	8.10	7.20
65	Single-path	10.8	-	10.7	-	8.10
80	Single-path	12.2	12.8	12.2	12.9	8.80
100	Two-path	16.1	18.1	16.0	17.9	11.2
150	Two-path	25.4	26.4	22.0	26.2	17.5

- 1) Pressure rating PN 40 (DN 50), PN 16 (DN 65 to 150)  
 2) Pressure rating, class 150  
 3) Pressure rating PN 10/16  
 4) Pressure rating PN 10

**Weight in US units**

*Compact version*

*Order code for "Housing", option A "Compact, aluminum, coated"*

Nominal diameter [in]	Version	Fixed flange ASME B16.5 <sup>1)</sup> [lbs]	Lap joint flange ASME B16.5 <sup>1)</sup> [lbs]
2	Single-path	17.6	17.9
3	Single-path	28.2	28.5
4	Two-path	39.9	39.5
6	Two-path	58.2	57.7

- 1) Pressure rating, class 150

**Materials**

**Transmitter housing**

- Order code for "Housing", option A "Compact, aluminum coated": Aluminum, AlSi10Mg, coated
- Window material for optional local display (→ 29): Order code for "Display; Operation", option B: glass

### Cable entries/cable glands

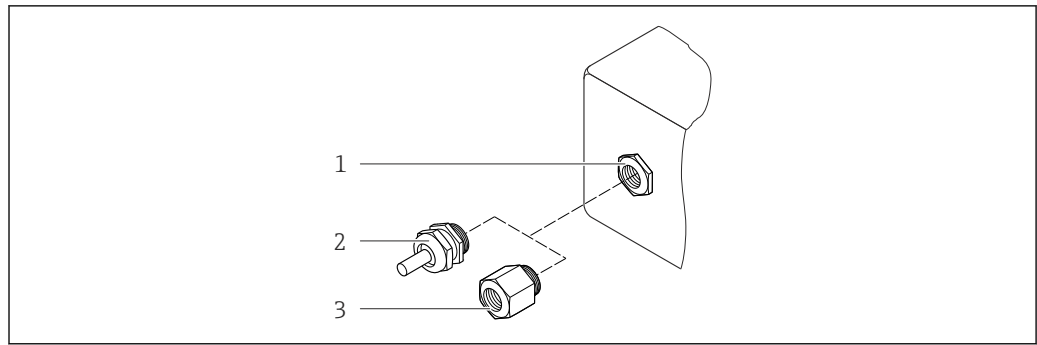

A0020640

#### 15 Possible cable entries/cable glands

- 1 Female thread M20 × 1.5
- 2 Cable gland M20 × 1.5
- 3 Adapter for cable entry with internal thread G ½" or NPT ½"

Order code for "Housing", option A "Compact, aluminum, coated"

Cable entry/cable gland	Material
Cable gland M20 × 1.5	Nickel-plated brass
Adapter for cable entry with internal thread G ½"	
Adapter for cable entry with internal thread NPT ½"	



### Sensor housing

Stainless steel (cold worked):

- 1.4404 (316L)
- 1.4435 (316L)

### Process connections

- Stainless steel:
  - 1.4301 (304)
  - 1.4306 (304L)
  - 1.4404 (316L)
  - 1.4571 (316Ti)
- Steel S235JR (1.0038)
- Carbon steel A105

 List of all available process connections →  28

### Process connections

Flanges:

- EN 1092-1 (DIN 2501)
- ASME B16.5

 For information on the different materials used in the process connections →  28

## Operability

### Operating concept

#### Operator-oriented menu structure for user-specific tasks

- Commissioning
- Operation
- Diagnostics
- Expert level

**Quick and safe commissioning**

- Individual menus for applications
- Menu guidance with brief explanations of the individual parameter functions

**Reliable operation**

- Operation in the following languages:
  - Via "FieldCare", "DeviceCare" operating tool: English, German, French, Spanish, Italian, Chinese, Japanese
  - Via integrated Web browser: English, German, French, Spanish, Italian, Dutch, Portuguese, Polish, Russian, Turkish, Chinese, Japanese, Bahasa (Indonesian), Vietnamese, Czech, Swedish, Korean
- Uniform operating philosophy applied to operating tools and Web browser
- If replacing the electronic module, transfer the device configuration via the plug-in memory (HistoROM DAT) which contains the process and measuring device data and the event logbook. No need to reconfigure.

**Efficient diagnostics increase measurement availability**

- Troubleshooting measures can be called up via the operating tools
- Diverse simulation options
- Status indicated by several light emitting diodes (LEDs) on the electronic module in the housing compartment

**Local display**

The local display is only available with the following device order code:  
 Order code for "Display; operation", option **B**: 4-line; illuminated, via communication

**Display element**

- 4-line liquid crystal display with 16 characters per line.
- White background lighting; switches to red in event of device errors.
- Format for displaying measured variables and status variables can be individually configured.
- Permitted ambient temperature for the display: -20 to +60 °C (-4 to +140 °F). The readability of the display may be impaired at temperatures outside the temperature range.

**Remote operation**

**Via HART protocol**

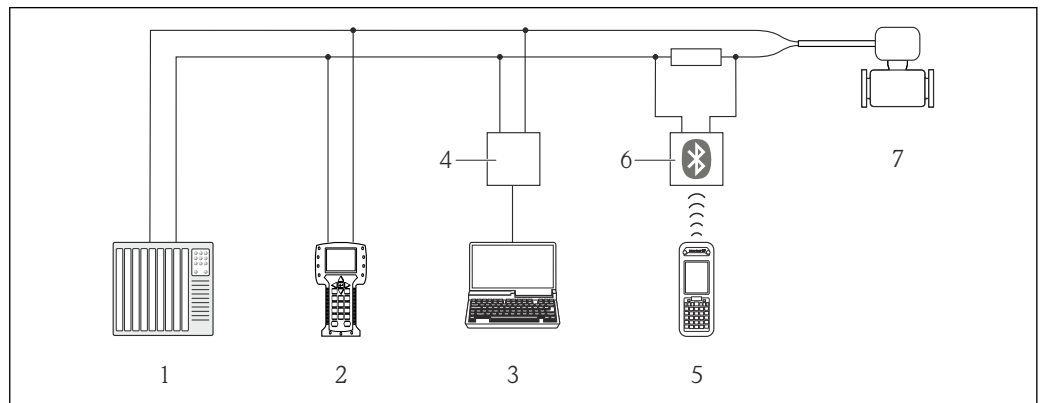

16 Options for remote operation via HART protocol

- 1 Control system (e.g. PLC)
- 2 Field Communicator 475
- 3 Computer with operating tool (e.g. FieldCare, AMS Device Manager, SIMATIC PDM)
- 4 Commubox FXA195 (USB)
- 5 Field Xpert SFX350 or SFX370
- 6 VIATOR Bluetooth modem with connecting cable
- 7 Transmitter

**Service interface**

**Via service interface (CDI-RJ45)**

## HART

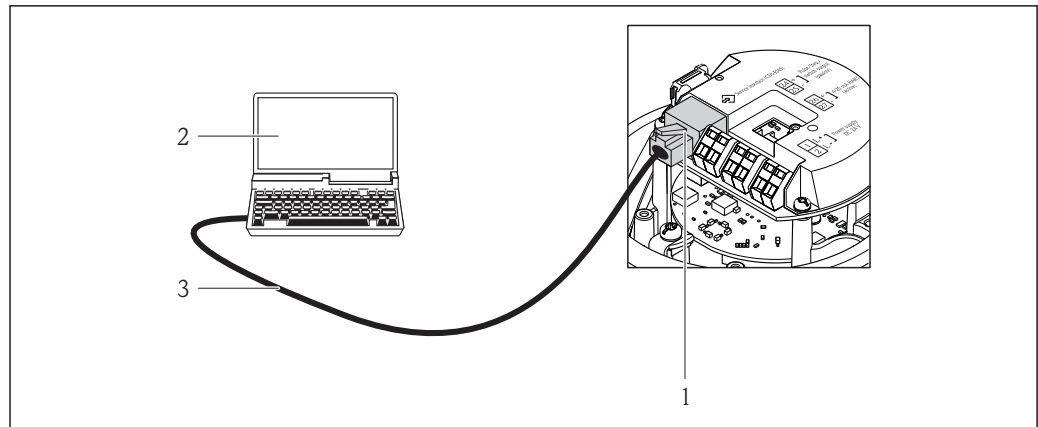

A0016926

■ 17 Connection for the order code for "Output", option B: 4-20 mA HART, pulse/frequency/switch output

- 1 Service interface (CDI -RJ45) of the measuring device with access to the integrated Web server
- 2 Computer with Web browser (e.g. Internet Explorer) for accessing the integrated device Web server or with "FieldCare" operating tool with COM DTM "CDI Communication TCP/IP"
- 3 Standard Ethernet connecting cable with RJ45 plug

## Certificates and approvals

<b>CE mark</b>	<p>The measuring system is in conformity with the statutory requirements of the applicable EU Directives. These are listed in the corresponding EU Declaration of Conformity along with the standards applied.</p> <p>Endress+Hauser confirms successful testing of the device by affixing to it the CE mark.</p>
<b>C-Tick symbol</b>	<p>The measuring system meets the EMC requirements of the "Australian Communications and Media Authority (ACMA)".</p>
<b>HART certification</b>	<p><b>HART interface</b></p> <p>The measuring device is certified and registered by the FieldComm Group. The measuring system meets all the requirements of the following specifications:</p> <ul style="list-style-type: none"> <li>■ Certified according to HART 7.5</li> <li>■ The device can also be operated with certified devices of other manufacturers (interoperability)</li> </ul>
<b>Pressure Equipment Directive</b>	<p>The devices can be ordered with or without a PED approval. If a device with a PED approval is required, this must be explicitly stated in the order.</p> <ul style="list-style-type: none"> <li>■ With the identification PED/G1/x (x = category) on the sensor nameplate, Endress+Hauser confirms conformity with the "Essential Safety Requirements" specified in Appendix I of the Pressure Equipment Directive 2014/68/EC.</li> <li>■ Devices bearing this marking (PED) are suitable for the following types of medium: Media in Group 1 and 2 with a vapor pressure greater than, or smaller and equal to 0.5 bar (7.3 psi)</li> <li>■ Devices not bearing this marking (PED) are designed and manufactured according to good engineering practice. They meet the requirements of Art. 4, Par. 3 of the Pressure Equipment Directive 2014/68/EU. The range of application is indicated in tables 6 to 9 in Annex II of the Pressure Equipment Directive 2014/68/EC.</li> </ul>

## Other standards and guidelines

- EN 60529  
Degrees of protection provided by enclosures (IP code)
- EN 61010-1  
Safety requirements for electrical equipment for measurement, control and laboratory use - general requirements
- IEC/EN 61326  
Emission in accordance with Class A requirements. Electromagnetic compatibility (EMC requirements).
- NAMUR NE 21  
Electromagnetic compatibility (EMC) of industrial process and laboratory control equipment
- NAMUR NE 32  
Data retention in the event of a power failure in field and control instruments with microprocessors
- NAMUR NE 43  
Standardization of the signal level for the breakdown information of digital transmitters with analog output signal.
- NAMUR NE 53  
Software of field devices and signal-processing devices with digital electronics
- NAMUR NE 80  
The application of the pressure equipment directive to process control devices
- NAMUR NE 105  
Specifications for integrating fieldbus devices in engineering tools for field devices
- NAMUR NE 107  
Self-monitoring and diagnosis of field devices
- NAMUR NE 131  
Requirements for field devices for standard applications

## Ordering information

Detailed ordering information is available as follows:

- In the Product Configurator on the Endress+Hauser website: [www.endress.com](http://www.endress.com) -> Click "Corporate" -> Select your country -> Click "Products" -> Select the product using the filters and search field -> Open product page -> The "Configure" button to the right of the product image opens the Product Configurator.
- From your Endress+Hauser Sales Center: [www.addresses.endress.com](http://www.addresses.endress.com)

### **Product Configurator - the tool for individual product configuration**

- Up-to-the-minute configuration data
- Depending on the device: Direct input of measuring point-specific information such as measuring range or operating language
- Automatic verification of exclusion criteria
- Automatic creation of the order code and its breakdown in PDF or Excel output format
- Ability to order directly in the Endress+Hauser Online Shop

## Application packages

Many different application packages are available to enhance the functionality of the device. Such packages might be needed to address safety aspects or specific application requirements.

The application packages can be ordered with the device or subsequently from Endress+Hauser.

Detailed information on the order code in question is available from your local Endress+Hauser sales center or on the product page of the Endress+Hauser website: [www.endress.com](http://www.endress.com).







## Heartbeat Technology



Package	Description
Heartbeat Verification +Monitoring	<p><b>Heartbeat Verification</b> Meets the requirement for traceable verification to DIN ISO 9001:2008 Chapter 7.6 a) "Control of monitoring and measuring equipment".</p> <ul style="list-style-type: none"> <li>■ Functional testing in the installed state without interrupting the process.</li> <li>■ Traceable verification results on request, including a report.</li> <li>■ Simple testing process via local operation or other operating interfaces.</li> <li>■ Clear measuring point assessment (pass/fail) with high test coverage within the framework of manufacturer specifications.</li> <li>■ Extension of calibration intervals according to operator's risk assessment.</li> </ul> <p><b>Heartbeat Monitoring</b> Continuously supplies data, which are characteristic of the measuring principle, to an external condition monitoring system for the purpose of preventive maintenance or process analysis. These data enable the operator to:</p> <ul style="list-style-type: none"> <li>■ Draw conclusions - using these data and other information - about the impact the measuring application has on the measuring performance over time.</li> <li>■ Schedule servicing in time.</li> <li>■ Monitor the process or product quality, e.g. gas pockets.</li> </ul>

## Accessories



Various accessories, which can be ordered with the device or subsequently from Endress+Hauser, are available for the device. Detailed information on the order code in question is available from your local Endress+Hauser sales center or on the product page of the Endress+Hauser website: [www.endress.com](http://www.endress.com).

## Communication-specific accessories

Accessories	Description
Commubox FXA195 HART	For intrinsically safe HART communication with FieldCare via the USB interface.  Technical Information TI00404F
Commubox FXA291	Connects Endress+Hauser field devices with a CDI interface (= Endress+Hauser Common Data Interface) and the USB port of a computer or laptop.  Technical Information TI405C/07
HART Loop Converter HMX50	Is used to evaluate and convert dynamic HART process variables to analog current signals or limit values.  <ul style="list-style-type: none"> <li>■ Technical Information TI00429F</li> <li>■ Operating Instructions BA00371F</li> </ul>
Wireless HART adapter SWA70	Is used for the wireless connection of field devices. The WirelessHART adapter can be easily integrated into field devices and existing infrastructures, offers data protection and transmission safety and can be operated in parallel with other wireless networks with minimum cabling complexity.  Operating Instructions BA00061S
Fieldgate FXA320	Gateway for the remote monitoring of connected 4-20 mA measuring devices via a Web browser.  Technical Information TI00025S Operating Instructions BA00053S
Fieldgate FXA520	Gateway for the remote diagnostics and remote configuration of connected HART measuring devices via a Web browser.  Technical Information TI00025S Operating Instructions BA00051S

Field Xpert SFX350	Field Xpert SFX350 is a mobile computer for commissioning and maintenance. It enables efficient device configuration and diagnostics for HART and FOUNDATION Fieldbus devices and can be used in non-hazardous areas.  Operating Instructions BA01202S
Field Xpert SFX370	Field Xpert SFX370 is a mobile computer for commissioning and maintenance. It enables efficient device configuration and diagnostics for HART and FOUNDATION Fieldbus devices and can be used in the non-hazardous area and in the hazardous area.  Operating Instructions BA01202S

**Service-specific accessories**

Accessories	Description
Applicator	Software for selecting and sizing Endress+Hauser measuring devices: <ul style="list-style-type: none"> <li>▪ Choice of measuring devices for industrial requirements</li> <li>▪ Calculation of all the necessary data for identifying the optimum flowmeter: e.g. nominal diameter, pressure loss, flow velocity and accuracy.</li> <li>▪ Graphic illustration of the calculation results</li> <li>▪ Determination of the partial order code, administration, documentation and access to all project-related data and parameters over the entire life cycle of a project.</li> </ul> Applicator is available: <ul style="list-style-type: none"> <li>▪ Via the Internet: <a href="https://portal.endress.com/webapp/applicator">https://portal.endress.com/webapp/applicator</a></li> <li>▪ As a downloadable DVD for local PC installation.</li> </ul>
W@M	W@M Life Cycle Management Improved productivity with information at your fingertips. Data relevant to a plant and its components is generated from the first stages of planning and during the asset's complete life cycle. W@M Life Cycle Management is an open and flexible information platform with online and on-site tools. Instant access for your staff to current, in-depth data shortens your plant's engineering time, speeds up procurement processes and increases plant uptime. Combined with the right services, W@M Life Cycle Management boosts productivity in every phase. For more information, visit <a href="http://www.endress.com/lifecyclemanagement">www.endress.com/lifecyclemanagement</a>
FieldCare	FDT-based plant asset management tool from Endress+Hauser. It can configure all smart field units in your system and helps you manage them. By using the status information, it is also a simple but effective way of checking their status and condition.  Operating Instructions BA00027S and BA00059S
DeviceCare	Tool to connect and configure Endress+Hauser field devices.  Innovation brochure IN01047S

**System components**

Accessories	Description
Memograph M graphic data manager	The Memograph M graphic data manager provides information on all the relevant measured variables. Measured values are recorded correctly, limit values are monitored and measuring points analyzed. The data are stored in the 256 MB internal memory and also on a SD card or USB stick.  <ul style="list-style-type: none"> <li>▪ Technical Information TI00133R</li> <li>▪ Operating Instructions BA00247R</li> </ul>

## Supplementary documentation

-  For an overview of the scope of the associated Technical Documentation, refer to the following:
- The *W@M Device Viewer* : Enter the serial number from the nameplate ([www.endress.com/deviceviewer](http://www.endress.com/deviceviewer))
  - The *Endress+Hauser Operations App*: Enter the serial number from the nameplate or scan the 2-D matrix code (QR code) on the nameplate.

**Standard documentation****Brief Operating Instructions***Brief Operating Instructions for the sensor*

Measuring device	Documentation code
Proline Prosonic Flow E	KA01329D

*Brief Operating Instructions for transmitter*

Measuring device	Documentation code
	HART
Proline 100	KA01330D

**Operating Instructions**

Measuring device	Documentation code
	HART
Prosonic Flow E 100	BA01769D

**Description of Device Parameters**

Measuring device	Documentation code
	HART
Prosonic Flow 100	GP01124D

**Supplementary device-dependent documentation****Special documentation**

Contents	Documentation code
Information on the Pressure Equipment Directive	SD01614D
RFID TAG	SD01565D

Contents	Documentation code
	HART
Heartbeat Technology	SD02079D

**Installation Instructions**

Contents	Comment
Installation instructions for spare part sets and accessories	Documentation code: specified for each individual accessory .

**Registered trademarks****HART®**

Registered trademark of the FieldComm Group, Austin, Texas, USA

**Microsoft®**

Registered trademark of the Microsoft Corporation, Redmond, Washington, USA

---

[www.addresses.endress.com](http://www.addresses.endress.com)

---