

Operating Instructions

Proline Prosonic Flow E 100

HART

Ultrasonic time-of-flight flowmeter

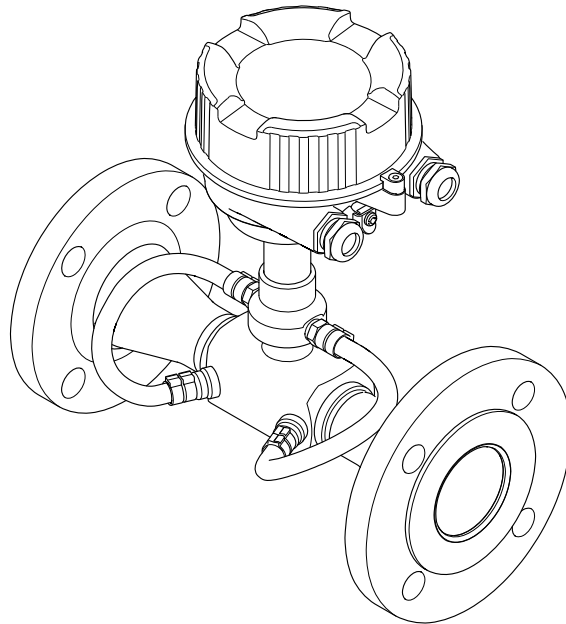

- Make sure the document is stored in a safe place such that it is always available when working on or with the device.
- To avoid danger to individuals or the facility, read the "Basic safety instructions" section carefully, as well as all other safety instructions in the document that are specific to working procedures.
- The manufacturer reserves the right to modify technical data without prior notice. Your Endress+Hauser Sales Center will supply you with current information and updates to these instructions.

Table of contents

1	About this document	5		
1.1	Document function	5		
1.2	Symbols used	5		
1.2.1	Safety symbols	5		
1.2.2	Electrical symbols	5		
1.2.3	Tool symbols	5		
1.2.4	Symbols for certain types of information	6		
1.2.5	Symbols in graphics	6		
1.3	Documentation	6		
1.3.1	Standard documentation	7		
1.3.2	Supplementary device-dependent documentation	7		
1.4	Registered trademarks	7		
2	Basic safety instructions	8		
2.1	Requirements for the personnel	8		
2.2	Designated use	8		
2.3	Workplace safety	9		
2.4	Operational safety	9		
2.5	Product safety	9		
2.6	IT security	10		
3	Product description	11		
3.1	Product design	11		
3.1.1	Device version with HART communication type	11		
4	Incoming acceptance and product identification	12		
4.1	Incoming acceptance	12		
4.2	Product identification	12		
4.2.1	Transmitter nameplate	13		
4.2.2	Sensor nameplate	14		
5	Storage and transport	15		
5.1	Storage conditions	15		
5.2	Transporting the product	15		
5.2.1	Measuring devices without lifting lugs	15		
5.2.2	Measuring devices with lifting lugs . .	16		
5.2.3	Transporting with a fork lift	16		
5.3	Packaging disposal	16		
6	Installation	16		
6.1	Installation conditions	16		
6.1.1	Mounting position	16		
6.1.2	Requirements from environment and process	18		
6.2	Mounting the measuring device	19		
6.2.1	Required tools	19		
6.2.2	Preparing the measuring device	19		
6.2.3	Mounting the measuring device	19		
6.2.4	Turning the display module	20		
6.3	Post-mounting check	20		
7	Electrical connection	21		
7.1	Connection conditions	21		
7.1.1	Required tools	21		
7.1.2	Requirements for connecting cable . .	21		
7.1.3	Terminal assignment	22		
7.1.4	Preparing the measuring device	22		
7.2	Connecting the measuring device	23		
7.2.1	Connecting the transmitter	23		
7.2.2	Ensuring potential equalization	24		
7.3	Special connection instructions	25		
7.3.1	Connection examples	25		
7.4	Ensuring the degree of protection	26		
7.5	Post-connection check	26		
8	Operation options	27		
8.1	Overview of operating options	27		
8.2	Structure and function of the operating menu	28		
8.2.1	Structure of the operating menu	28		
8.2.2	Operating philosophy	29		
8.3	Access to the operating menu via the web browser	30		
8.3.1	Function range	30		
8.3.2	Prerequisites	30		
8.3.3	Establishing a connection	31		
8.3.4	Logging on	32		
8.3.5	User interface	33		
8.3.6	Disabling the Web server	34		
8.3.7	Logging out	34		
8.4	Access to the operating menu via the operating tool	35		
8.4.1	Connecting the operating tool	35		
8.4.2	Field Xpert SFX350, SFX370	36		
8.4.3	FieldCare	36		
8.4.4	DeviceCare	38		
8.4.5	AMS Device Manager	38		
8.4.6	SIMATIC PDM	38		
8.4.7	Field Communicator 475	38		
9	System integration	39		
9.1	Overview of device description files	39		
9.1.1	Current version data for the device . .	39		
9.1.2	Operating tools	39		
9.2	Measured variables via HART protocol	39		
9.3	Other settings	40		
10	Commissioning	43		
10.1	Function check	43		

10.2	Switching on the measuring device	43			
10.3	Setting the operating language	43			
10.4	Configuring the measuring device	43			
	10.4.1 Defining the tag name	43			
	10.4.2 Setting the system units	44			
	10.4.3 Configuring the current output	46			
	10.4.4 Configuring the pulse/frequency/ switch output	47			
	10.4.5 Configuring the output conditioning	54			
	10.4.6 Configuring the low flow cut off	56			
10.5	Advanced settings	57			
	10.5.1 Using the parameter to enter the access code	57			
	10.5.2 Carrying out a sensor adjustment	57			
	10.5.3 Configuring the totalizer	58			
	10.5.4 Configuration management	58			
	10.5.5 Carrying out additional display configurations	60			
	10.5.6 Using parameters for device administration	62			
10.6	Simulation	63			
10.7	Protecting settings from unauthorized access	65			
	10.7.1 Write protection via write protection switch	66			
11	Operation	67			
11.1	Reading the device locking status	67			
11.2	Adjusting the operating language	67			
11.3	Configuring the display	67			
11.4	Reading measured values	67			
	11.4.1 Process variables	67			
	11.4.2 System values	68			
	11.4.3 Output values	69			
	11.4.4 "Totalizer" submenu	69			
11.5	Adapting the measuring device to the process conditions	70			
11.6	Performing a totalizer reset	70			
	11.6.1 Function scope of the "Control Totalizer" parameter	71			
	11.6.2 Function scope of the "Reset all totalizers" parameter	71			
12	Diagnostics and troubleshooting	72			
12.1	General troubleshooting	72			
12.2	Diagnostic information via light emitting diodes	73			
	12.2.1 Transmitter	73			
12.3	Diagnostic information in the Web browser	74			
	12.3.1 Diagnostic options	74			
	12.3.2 Calling up remedy information	75			
12.4	Diagnostic information in FieldCare or DeviceCare	75			
	12.4.1 Diagnostic options	75			
	12.4.2 Calling up remedy information	76			
12.5	Adapting the diagnostic information	76			
	12.5.1 Adapting the diagnostic behavior	76			
	12.5.2 Adapting the status signal	77			
12.6	Overview of diagnostic information	77			
12.7	Pending diagnostic events	80			
12.8	Diagnostic list	81			
12.9	Event logbook	81			
	12.9.1 Reading out the event logbook	81			
	12.9.2 Filtering the event logbook	82			
	12.9.3 Overview of information events	82			
12.10	Resetting the measuring device	83			
	12.10.1 Function scope of the "Device reset" parameter	83			
12.11	Device information	83			
12.12	Firmware history	85			
13	Maintenance	86			
13.1	Maintenance tasks	86			
	13.1.1 Exterior cleaning	86			
13.2	Measuring and test equipment	86			
13.3	Endress+Hauser services	86			
14	Repairs	87			
14.1	General notes	87			
	14.1.1 Repair and conversion concept	87			
	14.1.2 Notes for repair and conversion	87			
14.2	Spare parts	87			
14.3	Endress+Hauser services	87			
14.4	Return	87			
14.5	Disposal	88			
	14.5.1 Removing the measuring device	88			
	14.5.2 Disposing of the measuring device	88			
15	Accessories	89			
15.1	Communication-specific accessories	89			
15.2	Service-specific accessories	90			
15.3	System components	90			
16	Technical data	91			
16.1	Application	91			
16.2	Function and system design	91			
16.3	Input	91			
16.4	Output	92			
16.5	Power supply	94			
16.6	Performance characteristics	95			
16.7	Installation	96			
16.8	Environment	96			
16.9	Process	97			
16.10	Mechanical construction	99			
16.11	Operability	101			
16.12	Certificates and approvals	103			
16.13	Application packages	104			
16.14	Accessories	104			
16.15	Supplementary documentation	104			
	Index	106			





1 About this document

1.1 Document function





These Operating Instructions contain all the information that is required in various phases of the life cycle of the device: from product identification, incoming acceptance and storage, to mounting, connection, operation and commissioning through to troubleshooting, maintenance and disposal.

1.2 Symbols used



1.2.1 Safety symbols

Symbol	Meaning
	DANGER! This symbol alerts you to a dangerous situation. Failure to avoid this situation will result in serious or fatal injury.
	WARNING! This symbol alerts you to a dangerous situation. Failure to avoid this situation can result in serious or fatal injury.
	CAUTION! This symbol alerts you to a dangerous situation. Failure to avoid this situation can result in minor or medium injury.
	NOTE! This symbol contains information on procedures and other facts which do not result in personal injury.













1.2.2 Electrical symbols

Symbol	Meaning
	Direct current
	Alternating current
	Direct current and alternating current
	Ground connection A grounded terminal which, as far as the operator is concerned, is grounded via a grounding system.
	Protective Earth (PE) A terminal which must be connected to ground prior to establishing any other connections. The ground terminals are situated inside and outside the device: <ul style="list-style-type: none"> ▪ Inner ground terminal: Connects the protective earth to the mains supply. ▪ Outer ground terminal: Connects the device to the plant grounding system.





1.2.3 Tool symbols

Symbol	Meaning
	Allen key
	Open-ended wrench

1.2.4 Symbols for certain types of information

Symbol	Meaning
	Permitted Procedures, processes or actions that are permitted.
	Preferred Procedures, processes or actions that are preferred.
	Forbidden Procedures, processes or actions that are forbidden.
	Tip Indicates additional information.
	Reference to documentation.
	Reference to page.
	Reference to graphic.
	Notice or individual step to be observed.
	Series of steps.
	Result of a step.
	Help in the event of a problem.
	Visual inspection.



1.2.5 Symbols in graphics

Symbol	Meaning
1, 2, 3, ...	Item numbers
	Series of steps
A, B, C, ...	Views
A-A, B-B, C-C, ...	Sections
	Hazardous area
	Safe area (non-hazardous area)
	Flow direction

1.3 Documentation

 For an overview of the scope of the associated Technical Documentation, refer to the following:

- The *W@M Device Viewer* : Enter the serial number from the nameplate (www.endress.com/deviceviewer)
- The *Endress+Hauser Operations App*: Enter the serial number from the nameplate or scan the 2-D matrix code (QR code) on the nameplate.

 For a detailed list of the individual documents along with the documentation code
→  104

1.3.1 Standard documentation

Document type	Purpose and content of the document
Technical Information	<p>Planning aid for your device</p> <p>The document contains all the technical data on the device and provides an overview of the accessories and other products that can be ordered for the device.</p>
Sensor Brief Operating Instructions	<p>Guides you quickly to the 1st measured value - Part 1</p> <p>The Sensor Brief Operating Instructions are aimed at specialists with responsibility for installing the measuring device.</p> <ul style="list-style-type: none"> ▪ Incoming acceptance and product identification ▪ Storage and transport ▪ Installation
Transmitter Brief Operating Instructions	<p>Guides you quickly to the 1st measured value - Part 2</p> <p>The Transmitter Brief Operating Instructions are aimed at specialists with responsibility for commissioning, configuring and parameterizing the measuring device (until the first measured value).</p> <ul style="list-style-type: none"> ▪ Product description ▪ Installation ▪ Electrical connection ▪ Operation options ▪ System integration ▪ Commissioning ▪ Diagnostic information
Description of Device Parameters	<p>Reference for your parameters</p> <p>The document provides a detailed explanation of each individual parameter in the Expert operating menu. The description is aimed at those who work with the device over the entire life cycle and perform specific configurations.</p>

1.3.2 Supplementary device-dependent documentation

Additional documents are supplied depending on the device version ordered: Always comply strictly with the instructions in the supplementary documentation. The supplementary documentation is an integral part of the device documentation.

1.4 Registered trademarks

HART®

Registered trademark of the FieldComm Group, Austin, Texas, USA

Microsoft®

Registered trademark of the Microsoft Corporation, Redmond, Washington, USA

2 Basic safety instructions

2.1 Requirements for the personnel

The personnel for installation, commissioning, diagnostics and maintenance must fulfill the following requirements:

- ▶ Trained, qualified specialists must have a relevant qualification for this specific function and task.
- ▶ Are authorized by the plant owner/operator.
- ▶ Are familiar with federal/national regulations.
- ▶ Before starting work, read and understand the instructions in the manual and supplementary documentation as well as the certificates (depending on the application).
- ▶ Follow instructions and comply with basic conditions.

The operating personnel must fulfill the following requirements:

- ▶ Are instructed and authorized according to the requirements of the task by the facility's owner-operator.
- ▶ Follow the instructions in this manual.

2.2 Designated use

Application and media

Depending on the version ordered, the measuring device can also measure potentially explosive, flammable, poisonous and oxidizing media.

Measuring devices for use in hazardous areas, in hygienic applications or where there is an increased risk due to process pressure, are labeled accordingly on the nameplate.

To ensure that the measuring device remains in proper condition for the operation time:

- ▶ Keep within the specified pressure and temperature range.
- ▶ Only use the measuring device in full compliance with the data on the nameplate and the general conditions listed in the Operating Instructions and supplementary documentation.
- ▶ Based on the nameplate, check whether the ordered device is permitted for the intended use in the hazardous area (e.g. explosion protection, pressure vessel safety).
- ▶ Use the measuring device only for media to which the process-wetted materials are sufficiently resistant.
- ▶ If the measuring device is not operated at atmospheric temperature, compliance with the relevant basic conditions specified in the associated device documentation is absolutely essential: "Documentation" section →  6.
- ▶ Protect the measuring device permanently against corrosion from environmental influences.

Incorrect use

Non-designated use can compromise safety. The manufacturer is not liable for damage caused by improper or non-designated use.

WARNING

Danger of breakage due to corrosive or abrasive fluids!

- ▶ Verify the compatibility of the process fluid with the sensor material.
- ▶ Ensure the resistance of all fluid-wetted materials in the process.
- ▶ Keep within the specified pressure and temperature range.

NOTICE**Verification for borderline cases:**

- ▶ For special fluids and fluids for cleaning, Endress+Hauser is glad to provide assistance in verifying the corrosion resistance of fluid-wetted materials, but does not accept any warranty or liability as minute changes in the temperature, concentration or level of contamination in the process can alter the corrosion resistance properties.

Residual risks**⚠ WARNING****The electronics and the medium may cause the surfaces to heat up. This presents a burn hazard!**

- ▶ For elevated fluid temperatures, ensure protection against contact to prevent burns.

2.3 Workplace safety

For work on and with the device:

- ▶ Wear the required personal protective equipment according to federal/national regulations.

For welding work on the piping:

- ▶ Do not ground the welding unit via the measuring device.

If working on and with the device with wet hands:

- ▶ Due to the increased risk of electric shock, gloves must be worn.

2.4 Operational safety

Risk of injury.

- ▶ Operate the device in proper technical condition and fail-safe condition only.
- ▶ The operator is responsible for interference-free operation of the device.

Conversions to the device

Unauthorized modifications to the device are not permitted and can lead to unforeseeable dangers.

- ▶ If, despite this, modifications are required, consult with Endress+Hauser.

Repair

To ensure continued operational safety and reliability,

- ▶ Carry out repairs on the device only if they are expressly permitted.
- ▶ Observe federal/national regulations pertaining to repair of an electrical device.
- ▶ Use original spare parts and accessories from Endress+Hauser only.

2.5 Product safety

This measuring device is designed in accordance with good engineering practice to meet state-of-the-art safety requirements, has been tested, and left the factory in a condition in which it is safe to operate.

It meets general safety standards and legal requirements. It also complies with the EU directives listed in the device-specific EU Declaration of Conformity. Endress+Hauser confirms this by affixing the CE mark to the device.

2.6 IT security

We only provide a warranty if the device is installed and used as described in the Operating Instructions. The device is equipped with security mechanisms to protect it against any inadvertent changes to the device settings.

IT security measures in line with operators' security standards and designed to provide additional protection for the device and device data transfer must be implemented by the operators themselves.

3 Product description

The device consists of a transmitter and a sensor.

The device is available as a compact version:

The transmitter and sensor form a mechanical unit.

3.1 Product design

3.1.1 Device version with HART communication type

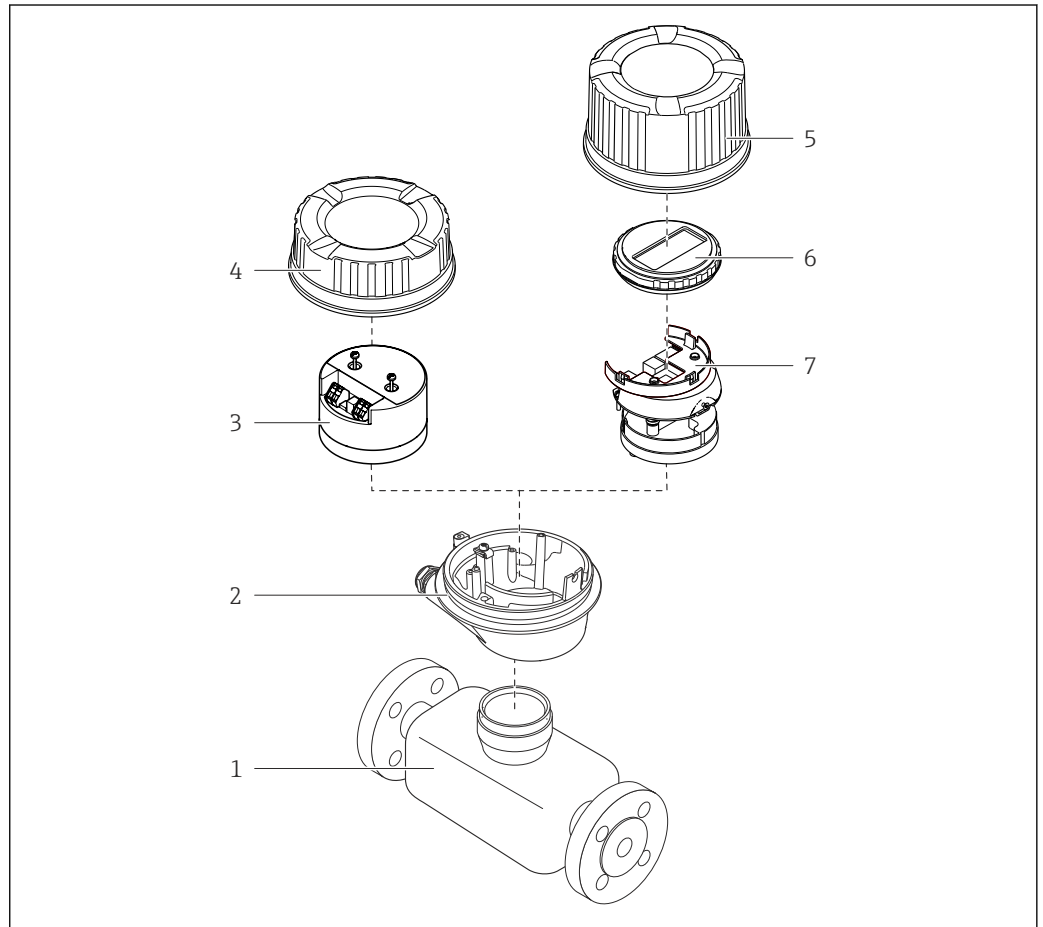

A0023153

1 Important components of a measuring device

- 1 Sensor
- 2 Transmitter housing
- 3 Main electronics module
- 4 Transmitter housing cover
- 5 Transmitter housing cover (version for optional local display)
- 6 Local display (optional)
- 7 Main electronics module (with bracket for optional local display)

4 Incoming acceptance and product identification

4.1 Incoming acceptance



A0028673

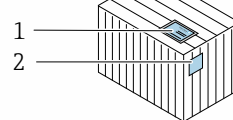
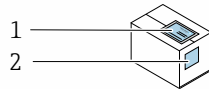

Are the order codes on the delivery note (1) and the product sticker (2) identical?

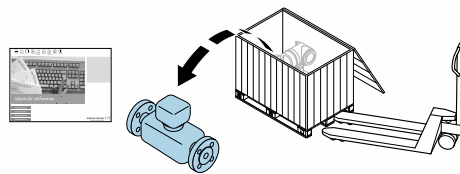

A0028673

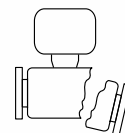
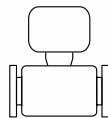

Are the goods undamaged?



A0028673

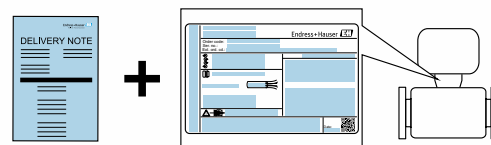



Do the nameplate data match the ordering information on the delivery note?

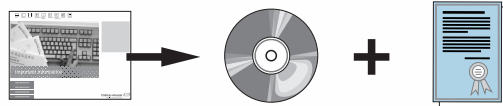

A0028673



Is the CD-ROM with the Technical Documentation (depends on device version) and documents present?



-  If one of the conditions is not satisfied, contact your Endress+Hauser Sales Center.
- Depending on the device version, the CD-ROM might not be part of the delivery! The Technical Documentation is available via the Internet or via the *Endress+Hauser Operations App*, see the "Product identification" section →  13.

4.2 Product identification

The following options are available for identification of the measuring device:

- Nameplate specifications
- Order code with breakdown of the device features on the delivery note
- Enter serial numbers from nameplates in *W@M Device Viewer* (www.endress.com/deviceviewer): All information about the measuring device is displayed.
- Enter the serial number from the nameplates into the *Endress+Hauser Operations App* or scan the 2-D matrix code (QR code) on the nameplate with the *Endress+Hauser Operations App*: all the information for the measuring device is displayed.

For an overview of the scope of the associated Technical Documentation, refer to the following:

- The chapters "Additional standard documentation on the device" →  7 and "Supplementary device-dependent documentation" →  7
- The *W@M Device Viewer*: Enter the serial number from the nameplate (www.endress.com/deviceviewer)
- The *Endress+Hauser Operations App*: Enter the serial number from the nameplate or scan the 2-D matrix code (QR code) on the nameplate.

4.2.1 Transmitter nameplate

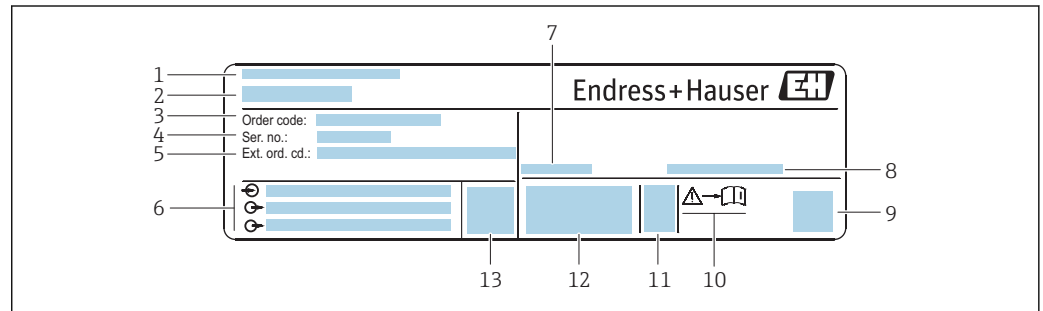

A0030222

 2 Example of a transmitter nameplate

- 1 Manufacturing location
- 2 Name of the transmitter
- 3 Order code
- 4 Serial number (ser. no.)
- 5 Extended order code (Ext. ord. cd.)
- 6 Electrical connection data, e.g. available inputs and outputs, supply voltage
- 7 Permitted ambient temperature (T_a)
- 8 Degree of protection
- 9 2-D matrix code
- 10 Document number of safety-related supplementary documentation
- 11 Manufacturing date: year-month
- 12 CE mark, C-Tick
- 13 Firmware version (FW)

4.2.2 Sensor nameplate

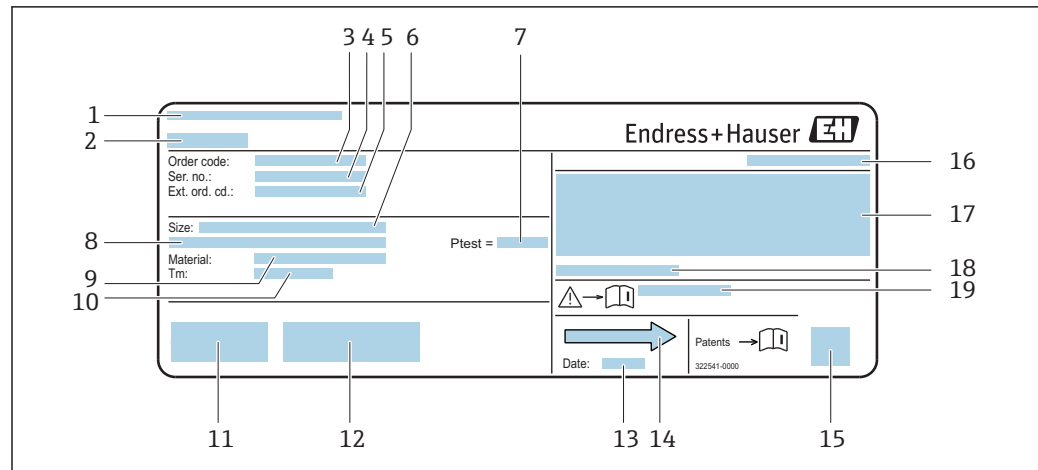

A0013907

3 Example of a sensor nameplate

- 1 Manufacturing location
- 2 Name of the sensor
- 3 Order code
- 4 Serial number (ser. no.)
- 5 Extended order code (Ext. ord. cd.)
- 6 Nominal diameter of sensor
- 7 Test pressure of the sensor
- 8 Flange nominal diameter/nominal pressure
- 9 Material of measuring tube and manifold
- 10 Medium temperature range
- 11 CE mark, C-Tick
- 12 Additional information on version: certificates, approvals
- 13 Manufacturing date: year-month
- 14 Flow direction
- 15 2-D matrix code
- 16 Degree of protection
- 17 Approval information for explosion protection and Pressure Equipment Directive
- 18 Permitted ambient temperature (T_a)
- 19 Document number of safety-related supplementary documentation

Order code

The measuring device is reordered using the order code.

Extended order code

- The device type (product root) and basic specifications (mandatory features) are always listed.
- Of the optional specifications (optional features), only the safety and approval-related specifications are listed (e.g. LA). If other optional specifications are also ordered, these are indicated collectively using the # placeholder symbol (e.g. #LA#).
- If the ordered optional specifications do not include any safety and approval-related specifications, they are indicated by the + placeholder symbol (e.g. XXXXXX-ABCDE +).

5 Storage and transport

5.1 Storage conditions

Observe the following notes for storage:

- ▶ Store in the original packaging to ensure protection from shock.
- ▶ Do not remove protective covers or protective caps installed on process connections. They prevent mechanical damage to the sealing surfaces and contamination in the measuring tube.
- ▶ Protect from direct sunlight to avoid unacceptably high surface temperatures.
- ▶ Store in a dry and dust-free place.
- ▶ Do not store outdoors.

Storage temperature →  96

5.2 Transporting the product

Transport the measuring device to the measuring point in the original packaging.

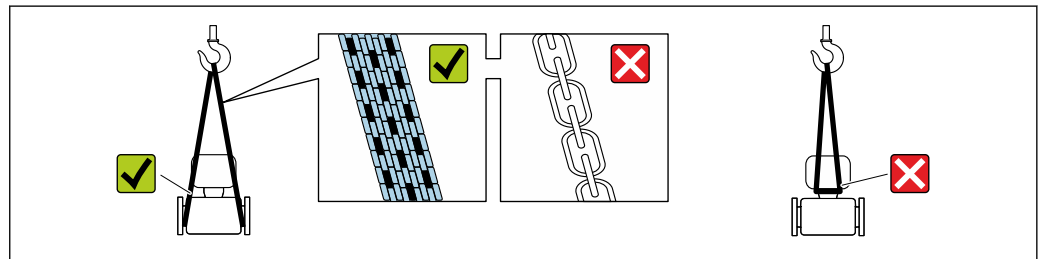

A0029252

-  Do not remove protective covers or caps installed on process connections. They prevent mechanical damage to the sealing surfaces and contamination in the measuring tube.

5.2.1 Measuring devices without lifting lugs

WARNING

Center of gravity of the measuring device is higher than the suspension points of the webbing slings.

Risk of injury if the measuring device slips.

- ▶ Secure the measuring device against slipping or turning.
- ▶ Observe the weight specified on the packaging (stick-on label).

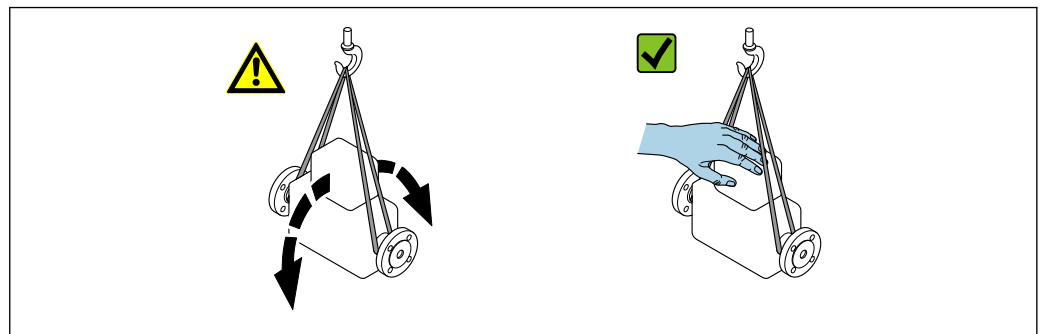

A0029214

5.2.2 Measuring devices with lifting lugs

⚠ CAUTION

Special transportation instructions for devices with lifting lugs

- ▶ Only use the lifting lugs fitted on the device or flanges to transport the device.
- ▶ The device must always be secured at two lifting lugs at least.

5.2.3 Transporting with a fork lift

If transporting in wood crates, the floor structure enables the crates to be lifted lengthwise or at both sides using a forklift.

5.3 Packaging disposal

All packaging materials are environmentally friendly and 100% recyclable:

- Measuring device secondary packaging: polymer stretch film that conforms to EC Directive 2002/95/EC (RoHS).
- Packaging:
 - Wood crate, treated in accordance with ISPM 15 standard, which is confirmed by the affixed IPPC logo.
 - or
 - Carton in accordance with European Packaging Directive 94/62EC; recyclability is confirmed by the affixed RESY symbol.
- Seaworthy packaging (optional): Wood crate, treated in accordance with ISPM 15 standard, which is confirmed by the affixed IPPC logo.
- Carrying and mounting hardware:
 - Disposable plastic pallet
 - Plastic straps
 - Plastic adhesive strips
- Dunnage: Paper cushion

6 Installation

6.1 Installation conditions

No special measures such as supports etc. are necessary. External forces are absorbed by the construction of the device.

6.1.1 Mounting position

Mounting location

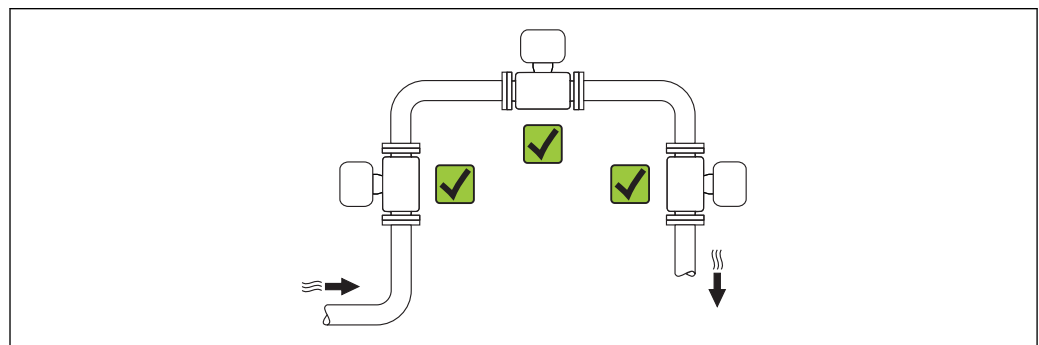

A0015543



Orientation

The direction of the arrow on the nameplate helps you to install the sensor according to the flow direction (direction of medium flow through the piping).

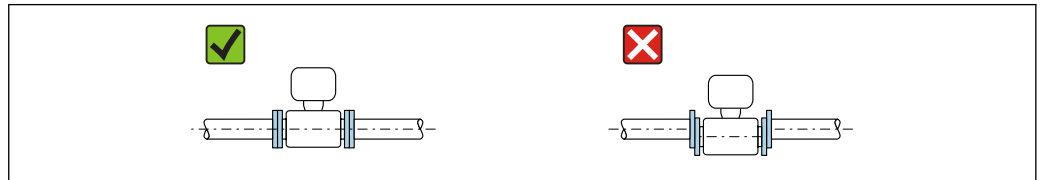
-  ■ Install the measuring device in a parallel plane free of external mechanical stress.
- The internal diameter of the pipe must match the internal diameter of the sensor: see the "Technical Information" device document, "Design and dimensions" section.

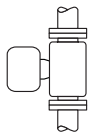
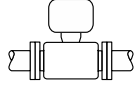
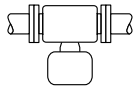

A0015895

Orientation		Compact version
A	Vertical orientation	 A0015545 ✓✓
B	Horizontal orientation, transmitter head up	 A0015589 ✓✓
C	Horizontal orientation, transmitter head down	 A0015590 ✓
D	Horizontal orientation, transmitter head at side	 A0015592 ✗

Inlet and outlet runs

If possible, the sensor should be installed upstream from valves, T-pieces, elbows etc. To attain the specified level of accuracy of the measuring device, the below mentioned inlet and outlet runs must be maintained at minimum. If there are several flow disturbances present, the longest specified inlet run must be maintained.

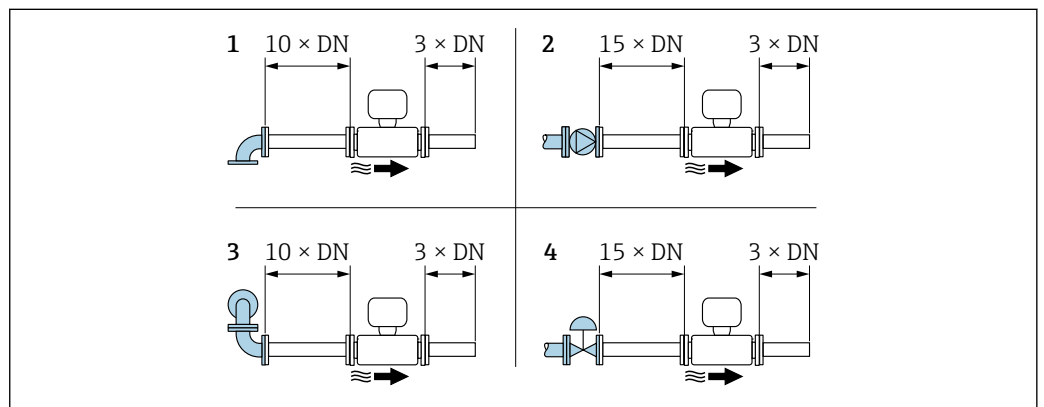

A0033877

 4 Minimum inlet and outlet runs with various flow obstructions

- 1 90 ° elbow or T-section
- 2 Pump
- 3 2 × 90 ° elbow, 3-dimensional
- 4 Control valve

Outlet runs when installing external devices

If installing an external device, observe the specified distance.

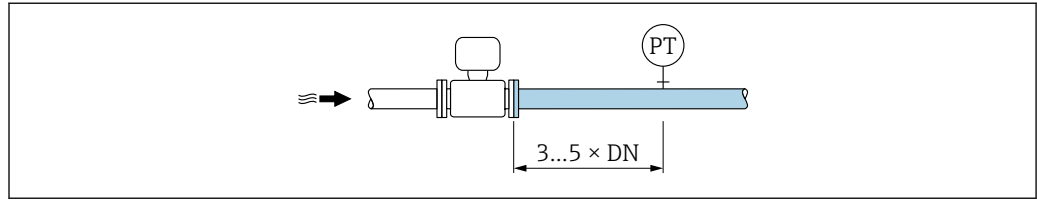

A0015901

PT Pressure

Installation dimensions



For the dimensions and installation lengths of the device, see the "Technical Information" document, "Mechanical construction" section.

6.1.2 Requirements from environment and process

Ambient temperature range

Transmitter	-25 to +60 °C (-13 to +140 °F)
Local display	-20 to +60 °C (-4 to +140 °F), the readability of the display may be impaired at temperatures outside the temperature range.
Sensor	-25 to +60 °C (-13 to +140 °F)

- ▶ If operating outdoors:
Avoid direct sunlight, particularly in warm climatic regions.

System pressure

It is important that cavitation does not occur, or that gases entrained in the liquids do not outgas.

Cavitation is caused if the pressure drops below the vapor pressure:
In suction lines

- ▶ Ensure the system pressure is sufficiently high to prevent cavitation and outgassing.

For this reason, the following mounting locations are recommended:

- At the lowest point in a vertical pipe
- Downstream from pumps (no danger of vacuum)

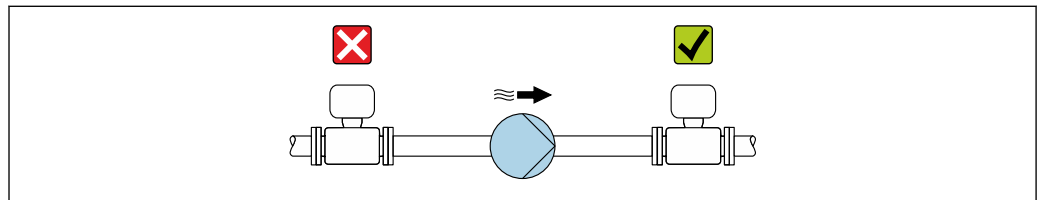

A0028777

Thermal insulation

In the case of some fluids, it is important to keep the heat radiated from the sensor to the transmitter to a low level. A wide range of materials can be used for the required insulation.

NOTICE**Electronics overheating on account of thermal insulation!**

- ▶ Observe maximum permitted insulation height of the transmitter neck so that the transmitter head is completely free.

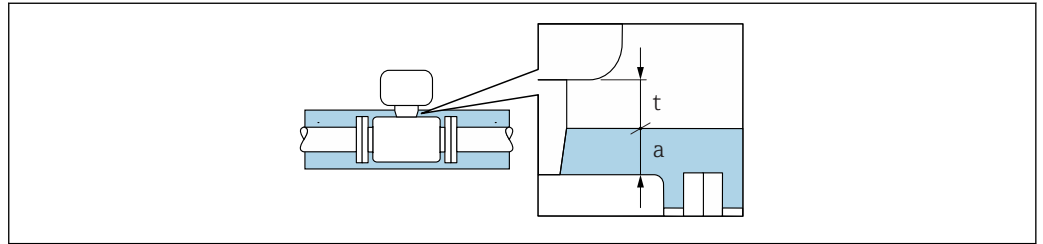

A0034104

- t* Maximum insulation thickness 2 cm (0.79 in)
a Minimum distance from transmitter to insulation

6.2 Mounting the measuring device

6.2.1 Required tools

For sensor

For flanges and other process connections: Corresponding mounting tools

6.2.2 Preparing the measuring device

1. Remove all remaining transport packaging.
2. Remove any protective covers or protective caps present from the sensor.
3. Remove stick-on label on the electronics compartment cover.

6.2.3 Mounting the measuring device

⚠ WARNING

Danger due to improper process sealing!

- ▶ Ensure that the inside diameters of the gaskets are greater than or equal to that of the process connections and piping.
- ▶ Ensure that the gaskets are clean and undamaged.
- ▶ Install the gaskets correctly.

1. Ensure that the direction of the arrow on the sensor matches the flow direction of the medium.
2. Install the measuring device or turn the transmitter housing so that the cable entries do not point upwards.

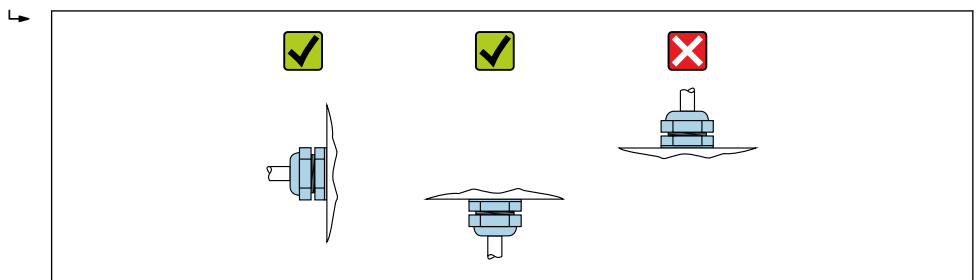

A0029263

6.2.4 Turning the display module

The local display is only available with the following device version:
 Order code for "Display; Operation", option **B**: 4-line; lit, via communication

The display module can be turned to optimize display readability.

Aluminum housing version, AlSi10Mg, coated

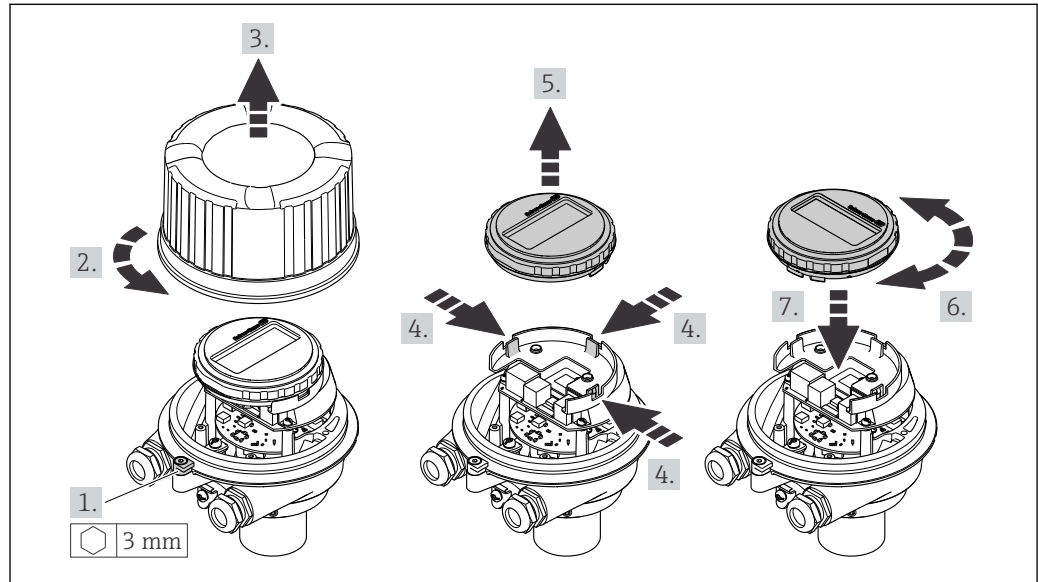

A0023192

6.3 Post-mounting check

Is the device undamaged (visual inspection)?	<input type="checkbox"/>
Does the measuring device conform to the measuring point specifications? For example: <ul style="list-style-type: none"> ▪ Process temperature ▪ Process pressure (refer to the section on "Pressure-temperature ratings" in the "Technical Information" document) ▪ Ambient temperature range ▪ Measuring range 	<input type="checkbox"/>
Has the correct orientation for the sensor been selected → 17? <ul style="list-style-type: none"> ▪ According to sensor type ▪ According to medium temperature ▪ According to medium properties (outgassing, with entrained solids) 	<input type="checkbox"/>
Does the arrow on the sensor match the direction of flow of the medium through the piping → 17?	<input type="checkbox"/>
Are the measuring point identification and labeling correct (visual inspection)?	<input type="checkbox"/>
Is the device adequately protected from precipitation and direct sunlight?	<input type="checkbox"/>
Are the securing screw and securing clamp tightened securely?	<input type="checkbox"/>

7 Electrical connection

NOTICE

The measuring device does not have an internal circuit breaker.

- ▶ For this reason, assign the measuring device a switch or power-circuit breaker so that the power supply line can be easily disconnected from the mains.
- ▶ Although the measuring device is equipped with a fuse, additional overcurrent protection (maximum 16 A) should be integrated into the system installation.

7.1 Connection conditions

7.1.1 Required tools

- For cable entries: Use corresponding tools
- For securing clamp (on aluminum housing): Allen screw 3 mm
- For securing screw (for stainless steel housing): open-ended wrench 8 mm
- Wire stripper
- When using stranded cables: crimper for wire end ferrule

7.1.2 Requirements for connecting cable

The connecting cables provided by the customer must fulfill the following requirements.

Electrical safety

In accordance with applicable federal/national regulations.

Permitted temperature range

- The installation guidelines that apply in the country of installation must be observed.
- The cables must be suitable for the minimum and maximum temperatures to be expected.

Power supply cable

Standard installation cable is sufficient.

Signal cable

Current output 4 to 20 mA HART

A shielded cable is recommended. Observe grounding concept of the plant.

Pulse/frequency/switch output

Standard installation cable is sufficient.

Cable diameter

- Cable glands supplied:
M20 × 1.5 with cable \varnothing 6 to 12 mm (0.24 to 0.47 in)
- Spring terminals:
Wire cross-sections 0.5 to 2.5 mm² (20 to 14 AWG)

7.1.3 Terminal assignment

Transmitter

Connection version 4-20 mA HART with pulse/frequency/switch output

Order code for "Output", option B

Order code "Housing"	Connection methods available		Possible options for order code "Electrical connection"
	Outputs	Power supply	
Option A	Terminals	Terminals	<ul style="list-style-type: none"> ■ Option A: coupling M20x1 ■ Option B: thread M20x1 ■ Option C: thread G 1/2" ■ Option D: thread NPT 1/2"
Order code for "Housing": Option A: compact, coated aluminum			

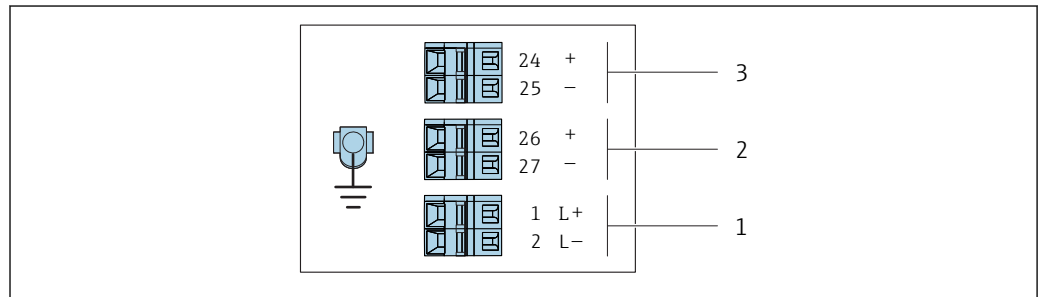

A0016888

5 Terminal assignment 4-20 mA HART with pulse/frequency/switch output

- 1 Power supply: DC 24 V
- 2 Output 1: 4-20 mA HART (active)
- 3 Output 2: pulse/frequency/switch output (passive)

Order code "Output"	Terminal number					
	Power supply		Output 1		Output 2	
	2 (L-)	1 (L+)	27 (-)	26 (+)	25 (-)	24 (+)
Option B	DC 24 V		4-20 mA HART (active)		Pulse/frequency/switch output (passive)	
Order code for "Output": Option B: 4-20 mA HART with pulse/frequency/switch output						

7.1.4 Preparing the measuring device

NOTICE

Insufficient sealing of the housing!

Operational reliability of the measuring device could be compromised.

- Use suitable cable glands corresponding to the degree of protection.

1. Remove dummy plug if present.
2. If the measuring device is supplied without cable glands:
Provide suitable cable gland for corresponding connecting cable.
3. If the measuring device is supplied with cable glands:
Observe requirements for connecting cables → 21.

7.2 Connecting the measuring device

NOTICE

Limitation of electrical safety due to incorrect connection!

- ▶ Have electrical connection work carried out by appropriately trained specialists only.
- ▶ Observe applicable federal/national installation codes and regulations.
- ▶ Comply with local workplace safety regulations.
- ▶ The power unit must be tested to ensure it meets safety requirements (e.g. PELV, SELV).

7.2.1 Connecting the transmitter

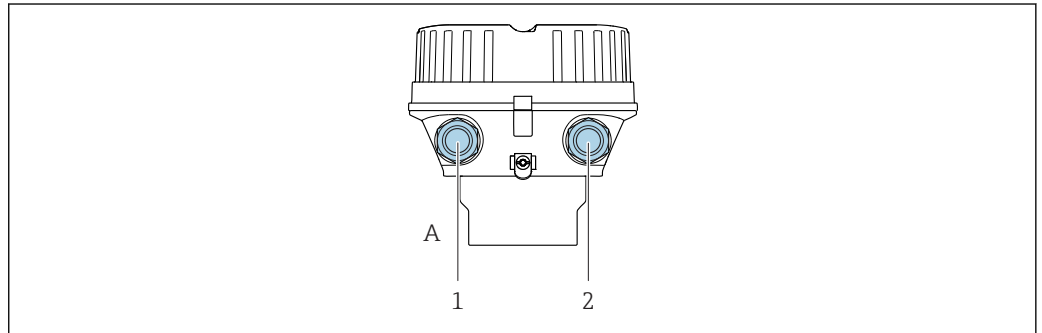

A0030221

- A *Compact, coated aluminum*
1 *Cable entry for signal transmission*
2 *Cable entry for supply voltage*

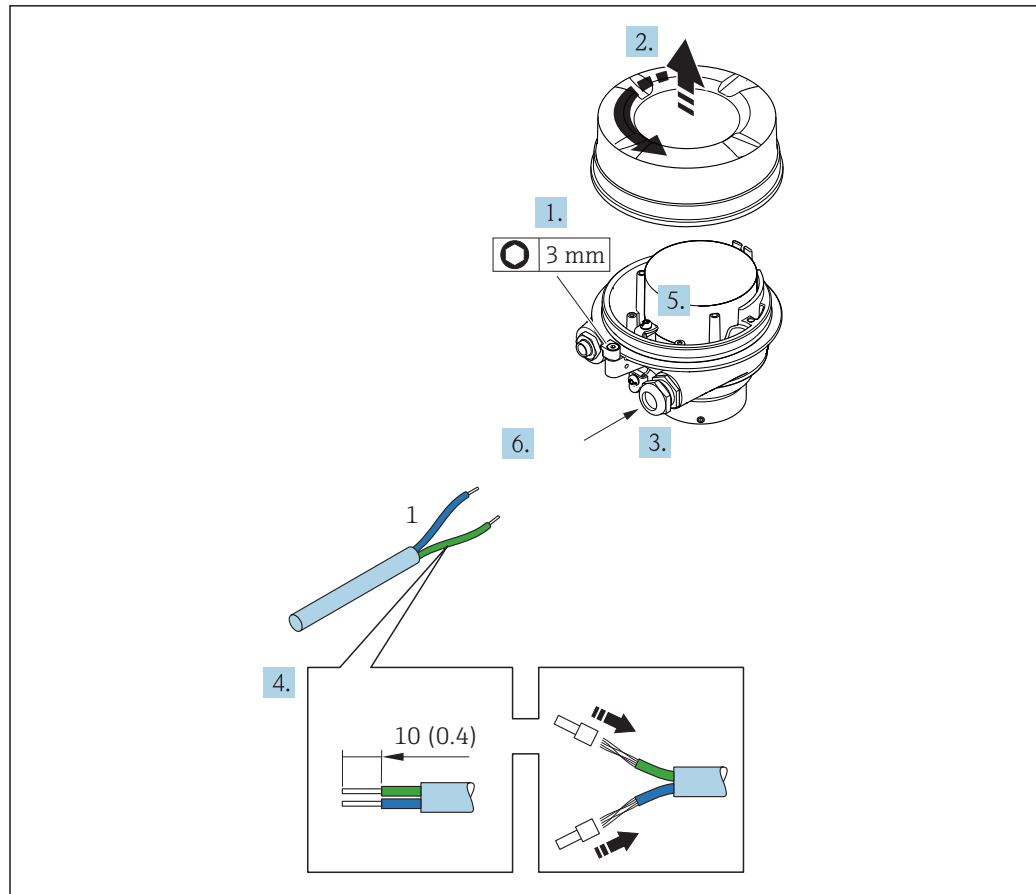

A0033696

6 Device version with connection example

1 Cable

i Disconnect the local display from the main electronics module: Operating Instructions for the device .

► Connect the cable in accordance with the terminal assignment .

7.2.2 Ensuring potential equalization

Requirements

No special measures for potential equalization are required.

7.3 Special connection instructions

7.3.1 Connection examples

Current output 4 to 20 mA HART

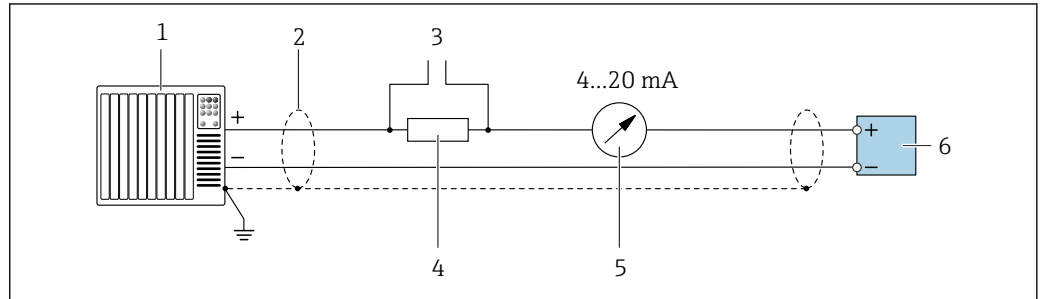

A0029055

7 Connection example for 4 to 20 mA HART current output (active)

- 1 Automation system with current input (e.g. PLC)
- 2 Cable shield: the cable shield must be grounded at both ends to comply with EMC requirements; observe cable specifications
- 3 Connection for HART operating devices → 35
- 4 Resistor for HART communication ($\geq 250 \Omega$): observe maximum load
- 5 Analog display unit: observe maximum load
- 6 Transmitter

Pulse/frequency output

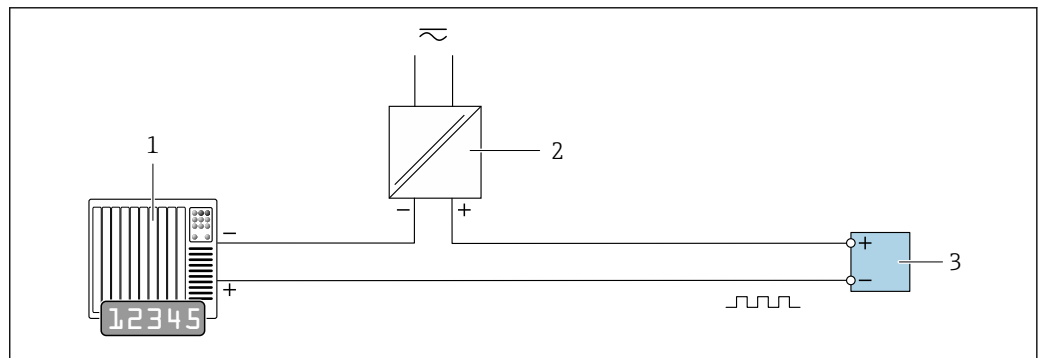

A0028761

8 Connection example for pulse/frequency output (passive)

- 1 Automation system with pulse/frequency input (e.g. PLC)
- 2 Power supply
- 3 Transmitter: Observe input values

Switch output

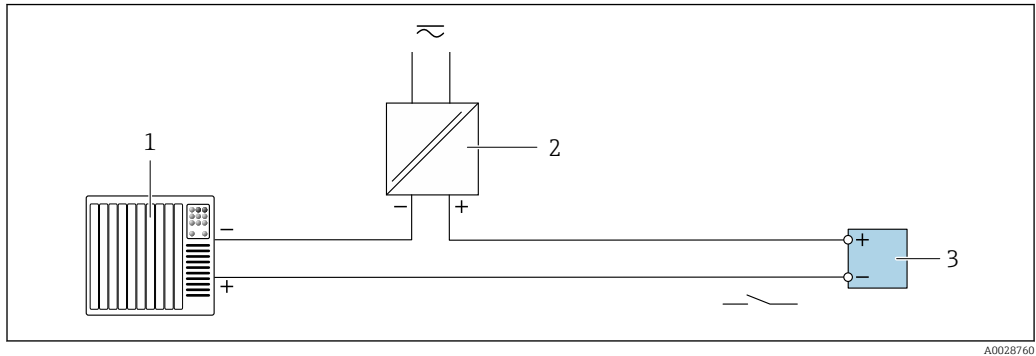

9 Connection example for switch output (passive)

- 1 Automation system with switch input (e.g. PLC)
- 2 Power supply
- 3 Transmitter: Observe input values

7.4 Ensuring the degree of protection

The measuring device fulfills all the requirements for the IP66/67 degree of protection, Type 4X enclosure.

To guarantee IP66/67 degree of protection, Type 4X enclosure, carry out the following steps after the electrical connection:

1. Check that the housing seals are clean and fitted correctly.
2. Dry, clean or replace the seals if necessary.
3. Tighten all housing screws and screw covers.
4. Firmly tighten the cable glands.
5. To ensure that moisture does not enter the cable entry:
Route the cable so that it loops down before the cable entry ("water trap").

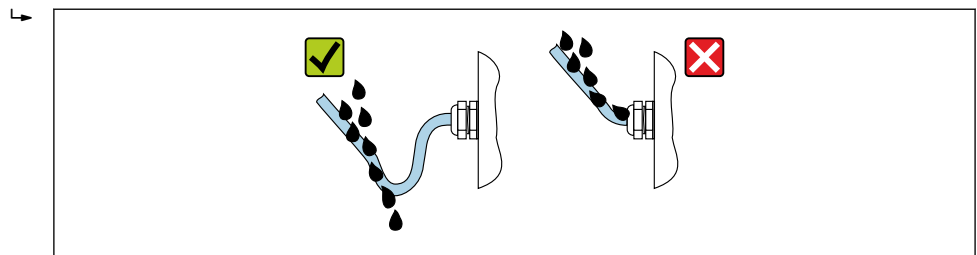

6. Insert dummy plugs into unused cable entries.

7.5 Post-connection check

Are cables or the device undamaged (visual inspection)?	<input type="checkbox"/>
Do the cables used meet the requirements → 21?	<input type="checkbox"/>
Do the cables have adequate strain relief?	<input type="checkbox"/>
Are all the cable glands installed, firmly tightened and leak-tight? Cable run with "water trap" → 26?	<input type="checkbox"/>
Does the supply voltage match the specifications on the transmitter nameplate → 94?	<input type="checkbox"/>
If supply voltage is present, is the power LED on the electronics module of the transmitter lit green → 11?	<input type="checkbox"/>
Depending on the device version, is the securing clamp or fixing screw firmly tightened?	<input type="checkbox"/>

8 Operation options

8.1 Overview of operating options

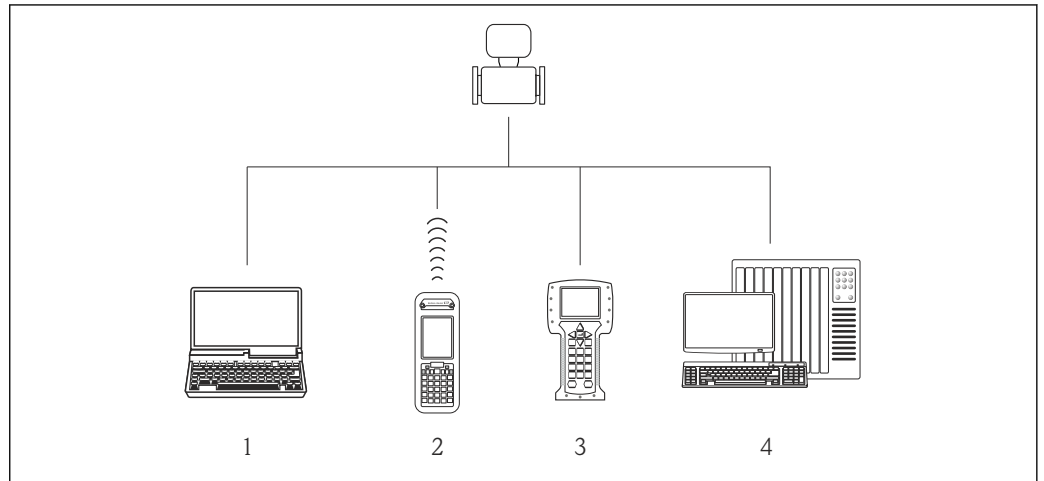

A0019598

- 1 Computer with Web browser (e.g. Internet Explorer) or with operating tool (e.g. FieldCare, AMS Device Manager, SIMATIC PDM)
- 2 Field Xpert SFX350 or SFX370
- 3 Field Communicator 475
- 4 Control system (e.g. PLC)

8.2 Structure and function of the operating menu

8.2.1 Structure of the operating menu

 For an overview of the operating menu for experts: "Description of Device Parameters" document supplied with the device

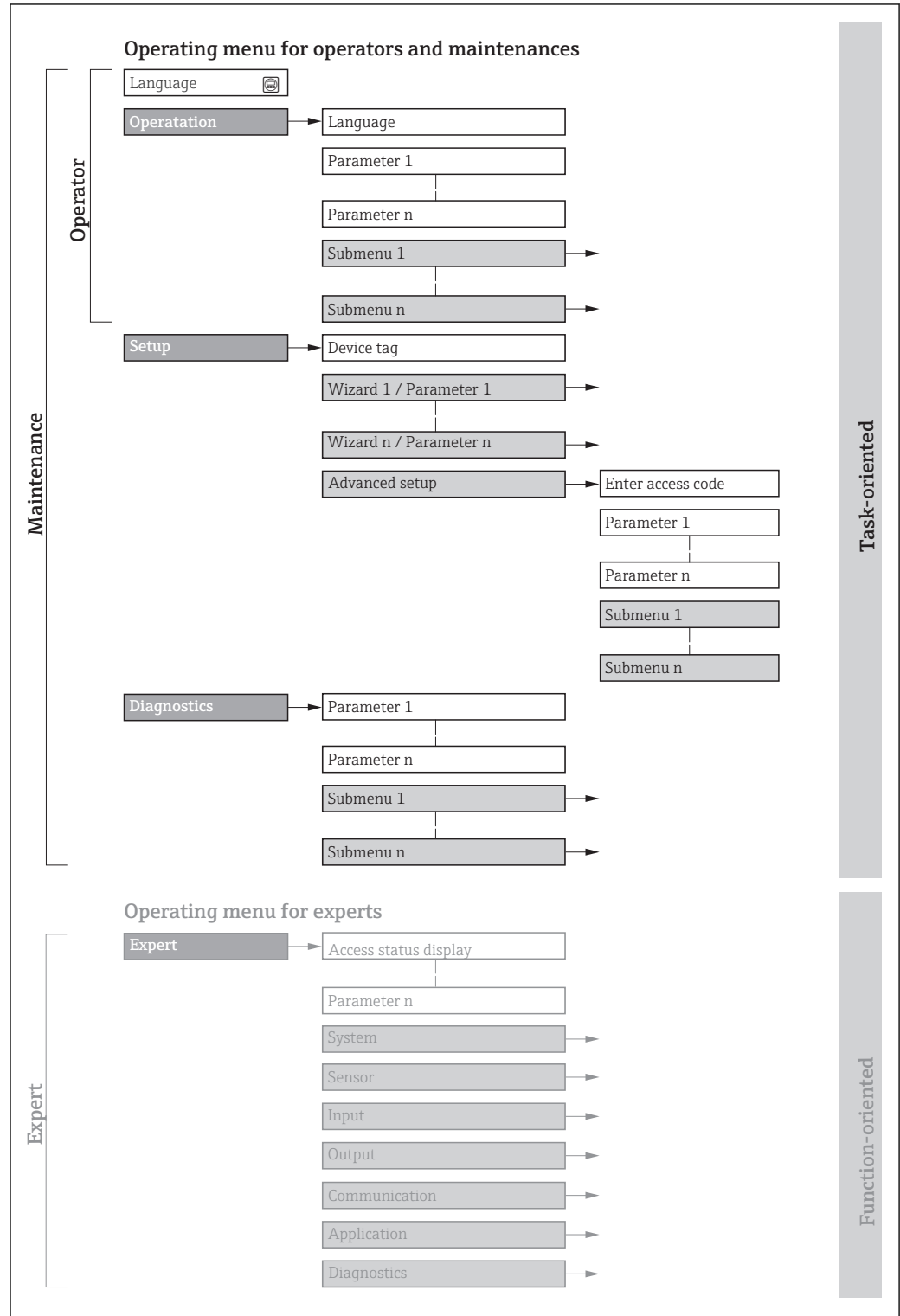

A0018237-EN

 10 Schematic structure of the operating menu

8.2.2 Operating philosophy

The individual parts of the operating menu are assigned to certain user roles (operator, maintenance etc.). Each user role contains typical tasks within the device lifecycle.

Menu/parameter		User role and tasks	Content/meaning
Language	task-oriented	Role "Operator", "Maintenance" Tasks during operation: <ul style="list-style-type: none"> ▪ Configuring the operational display ▪ Reading measured values 	<ul style="list-style-type: none"> ▪ Defining the operating language ▪ Defining the Web server operating language ▪ Resetting and controlling totalizers
Operation			<ul style="list-style-type: none"> ▪ Configuring the operational display (e.g. display format, display contrast) ▪ Resetting and controlling totalizers
Setup		"Maintenance" role Commissioning: <ul style="list-style-type: none"> ▪ Configuration of the measurement ▪ Configuration of the outputs 	Submenus for fast commissioning: <ul style="list-style-type: none"> ▪ Set the system units ▪ Configure the outputs ▪ Configuring the operational display ▪ Define the output conditioning ▪ Set the low flow cut off Advanced setup <ul style="list-style-type: none"> ▪ For more customized configuration of the measurement (adaptation to special measuring conditions) ▪ Configuration of totalizers ▪ Configure the WLAN settings ▪ Administration (define access code, reset measuring device)
Diagnostics		"Maintenance" role Fault elimination: <ul style="list-style-type: none"> ▪ Diagnostics and elimination of process and device errors ▪ Measured value simulation 	Contains all parameters for error detection and analyzing process and device errors: <ul style="list-style-type: none"> ▪ Diagnostic list Contains up to 5 currently pending diagnostic messages. ▪ Event logbook Contains event messages that have occurred. ▪ Device information Contains information for identifying the device. ▪ Measured values Contains all current measured values. ▪ Heartbeat The functionality of the device is checked on demand and the verification results are documented. ▪ Simulation Is used to simulate measured values or output values.
Expert	function-oriented	Tasks that require detailed knowledge of the function of the device: <ul style="list-style-type: none"> ▪ Commissioning measurements under difficult conditions ▪ Optimal adaptation of the measurement to difficult conditions ▪ Detailed configuration of the communication interface ▪ Error diagnostics in difficult cases 	Contains all the parameters of the device and makes it possible to access these parameters directly using an access code. The structure of this menu is based on the function blocks of the device: <ul style="list-style-type: none"> ▪ System Contains all higher-order device parameters which do not concern the measurement or the communication interface. ▪ Sensor Configuration of the measurement. ▪ Output Configuring of the analog current outputs as well as the pulse/frequency and switch output. ▪ Communication Configuration of the digital communication interface and the Web server. ▪ Application Configure the functions that go beyond the actual measurement (e.g. totalizer). ▪ Diagnostics Error detection and analysis of process and device errors and for device simulation and Heartbeat Technology.

8.3 Access to the operating menu via the web browser

8.3.1 Function range

Thanks to the integrated Web server, the device can be operated and configured via a Web browser and via a service interface (CDI-RJ45) . In addition to the measured values, status information on the device is also displayed and allows the user to monitor the status of the device. Furthermore the device data can be managed and the network parameters can be configured.

 For additional information on the Web server, refer to the Special Documentation for the device

8.3.2 Prerequisites

Computer hardware

Interface	The computer must have an RJ45 interface.
Connection	Standard Ethernet cable with RJ45 connector.
Screen	Recommended size: ≥12" (depends on the screen resolution)

Computer software













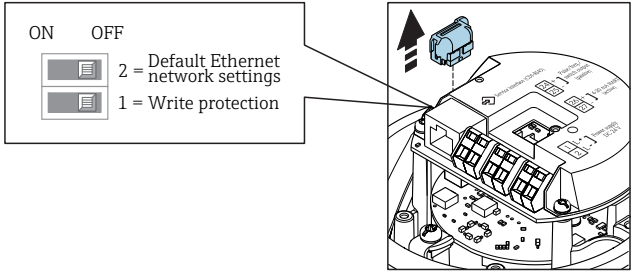

Recommended operating systems	Microsoft Windows 7 or higher.  Microsoft Windows XP is supported.
Web browsers supported	<ul style="list-style-type: none"> ▪ Microsoft Internet Explorer 8 or higher ▪ Microsoft Edge ▪ Mozilla Firefox ▪ Google Chrome ▪ Safari

Computer settings

User rights	Appropriate user rights (e.g. administrator rights) for TCP/IP and proxy server settings are necessary (for adjusting the IP address, subnet mask etc.).
Proxy server settings of the Web browser	The Web browser setting <i>Use a Proxy Server for Your LAN</i> must be deselected .
JavaScript	JavaScript must be enabled.  If JavaScript cannot be enabled: enter <code>http://XXX.XXX.X.XXX/basic.html</code> in the address line of the Web browser, e.g. <code>http://192.168.1.212/basic.html</code> . A fully functional but simplified version of the operating menu structure starts in the Web browser.
Network connections	Only the active network connections to the measuring device should be used. Switch off all other network connections such as WLAN.

 In the event of connection problems: →  72

Measuring device: Via CDI-RJ45 service interface

Device	CDI-RJ45 service interface									
Measuring device	The measuring device has an RJ45 interface.									
Web server	Web server must be enabled; factory setting: ON  For information on enabling the Web server →  34									
IP address	<p>Default settings:</p> <ul style="list-style-type: none"> IP address: 192.168.1.212 Set DIP switch No. 2 = OFF <p>If the IP address was changed manually or the address assigned via DHCP, the address can no longer be read from the device. To ensure however that a connection can still be established with the measuring device, DIP switch no. 2 must be set from OFF → ON and the device restarted. The IP address is now temporarily 192.168.1.212 once again.</p> <p>If the original setting is to be restored, DIP switch no. 2 must be set from ON → OFF and the device restarted.</p> <div style="display: flex; align-items: center;"> <div style="border: 1px solid black; padding: 5px; margin-right: 20px;"> <table style="width: 100%; border-collapse: collapse;"> <tr> <td style="text-align: center;">ON</td> <td style="text-align: center;">OFF</td> <td></td> </tr> <tr> <td style="text-align: center;"></td> <td style="text-align: center;"></td> <td style="text-align: center;">2 = Default Ethernet network settings</td> </tr> <tr> <td style="text-align: center;"></td> <td style="text-align: center;"></td> <td style="text-align: center;">1 = Write protection</td> </tr> </table> </div>  </div>	ON	OFF				2 = Default Ethernet network settings			1 = Write protection
ON	OFF									
		2 = Default Ethernet network settings								
		1 = Write protection								

8.3.3 Establishing a connection

Via service interface (CDI-RJ45)

Preparing the measuring device

Configuring the Internet protocol of the computer

The following information refers to the default Ethernet settings of the device.

IP address of the device: 192.168.1.212 (factory setting)

1. Switch on the measuring device.
2. Connect to the computer using a cable →  102.
3. If a 2nd network card is not used, close all the applications on the notebook.
 - ↳ Applications requiring Internet or a network, such as e-mail, SAP applications, Internet or Windows Explorer.
4. Close any open Internet browsers.
5. Configure the properties of the Internet protocol (TCP/IP) as defined in the table:

IP address	192.168.1.XXX; for XXX all numerical sequences except: 0, 212 and 255 → e.g. 192.168.1.213
Subnet mask	255.255.255.0
Default gateway	192.168.1.212 or leave cells empty

Starting the Web browser

1. Start the Web browser on the computer.

2. Enter the IP address of the Web server in the address line of the Web browser:
192.168.1.212
↳ The login page appears.

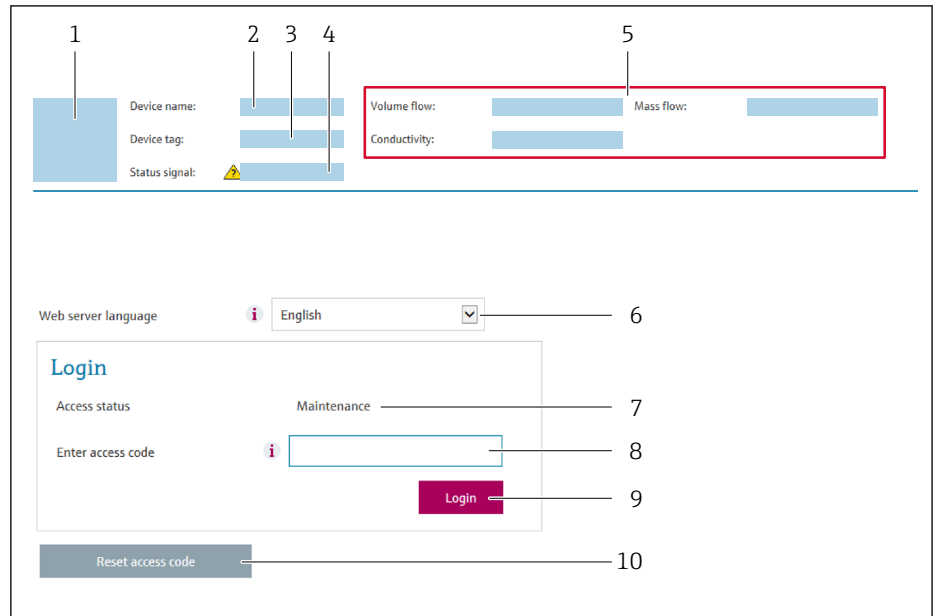

A0029417

- 1 Picture of device
- 2 Device name
- 3 Device tag (→ 44)
- 4 Status signal
- 5 Current measured values
- 6 Operating language
- 7 User role
- 8 Access code
- 9 Login
- 10 Reset access code (→ 63)

i If a login page does not appear, or if the page is incomplete → 72

8.3.4 Logging on

1. Select the preferred operating language for the Web browser.
2. Enter the user-specific access code.
3. Press **OK** to confirm your entry.

Access code	0000 (factory setting); can be changed by customer
-------------	--

i If no action is performed for 10 minutes, the Web browser automatically returns to the login page.

8.3.5 User interface

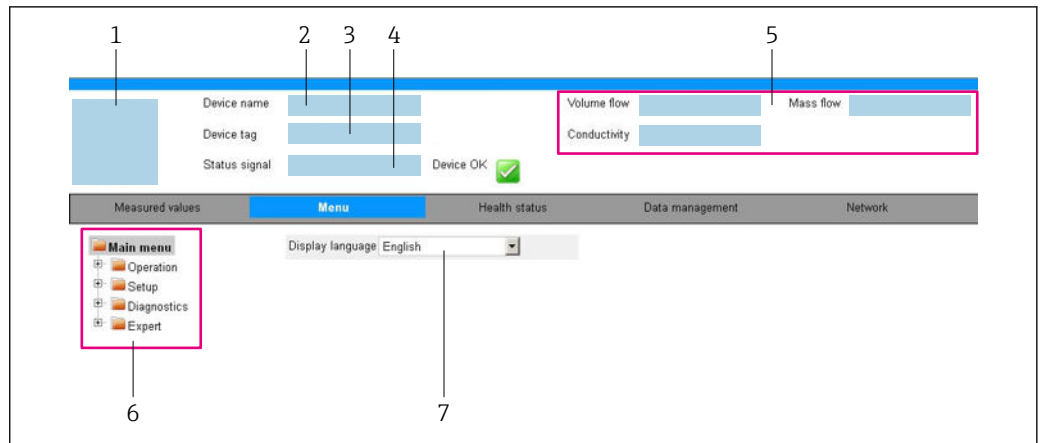

A0032879

- 1 Picture of device
- 2 Device name
- 3 Device tag
- 4 Status signal
- 5 Current measured values
- 6 Navigation area
- 7 Local display language

Header

The following information appears in the header:

- Device name
- Device tag
- Device status with status signal → 74
- Current measured values

Function row

Functions	Meaning
Measured values	Displays the measured values of the measuring device
Menu	<ul style="list-style-type: none"> ■ Access to the operating menu from the measuring device ■ The structure of the operating menu is the same as for the operating tools For detailed information on the structure of the operating menu, see the Operating Instructions for the measuring device
Device status	Displays the diagnostic messages currently pending, listed in order of priority
Data management	Data exchange between PC and measuring device: <ul style="list-style-type: none"> ■ Device configuration: <ul style="list-style-type: none"> - Load settings from the device (XML format, save configuration) - Save settings to the device (XML format, restore configuration) ■ Logbook - Export Event logbook (.csv file) ■ Documents - Export documents: <ul style="list-style-type: none"> - Export backup data record (.csv file, create documentation of the measuring point configuration) - Verification report (PDF file, only available with the "Heartbeat Verification" application package)
Network configuration	Configuration and checking of all the parameters required for establishing the connection to the measuring device: <ul style="list-style-type: none"> ■ Network settings (e.g. IP address, MAC address) ■ Device information (e.g. serial number, firmware version)
Logout	End the operation and call up the login page

Navigation area

If a function is selected in the function bar, the submenus of the function open in the navigation area. The user can now navigate through the menu structure.

Working area

Depending on the selected function and the related submenus, various actions can be performed in this area:

- Configuring parameters
- Reading measured values
- Calling up help text
- Starting an upload/download

8.3.6 Disabling the Web server

The Web server of the measuring device can be switched on and off as required using the **Web server functionality** parameter.

Navigation

"Expert" menu → Communication → Web server

Parameter overview with brief description

Parameter	Description	Selection	Factory setting
Web server functionality	Switch the Web server on and off.	<ul style="list-style-type: none"> ▪ Off ▪ HTML Off ▪ On 	On

Function scope of the "Web server functionality" parameter

Option	Description
Off	<ul style="list-style-type: none"> ▪ The web server is completely disabled. ▪ Port 80 is locked.
HTML Off	The HTML version of the web server is not available.
On	<ul style="list-style-type: none"> ▪ The complete functionality of the web server is available. ▪ JavaScript is used. ▪ The password is transferred in an encrypted state. ▪ Any change to the password is also transferred in an encrypted state.

Enabling the Web server

If the Web server is disabled it can only be re-enabled with the **Web server functionality** parameter via the following operating options:

- Via Bedientool "FieldCare"
- Via "DeviceCare" operating tool

8.3.7 Logging out

 Before logging out, perform a data backup via the **Data management** function (upload configuration from device) if necessary.

1. Select the **Logout** entry in the function row.
 - ↳ The home page with the Login box appears.
2. Close the Web browser.

3. If no longer needed:
Reset modified properties of the Internet protocol (TCP/IP) → 31.

8.4 Access to the operating menu via the operating tool

8.4.1 Connecting the operating tool

Via HART protocol

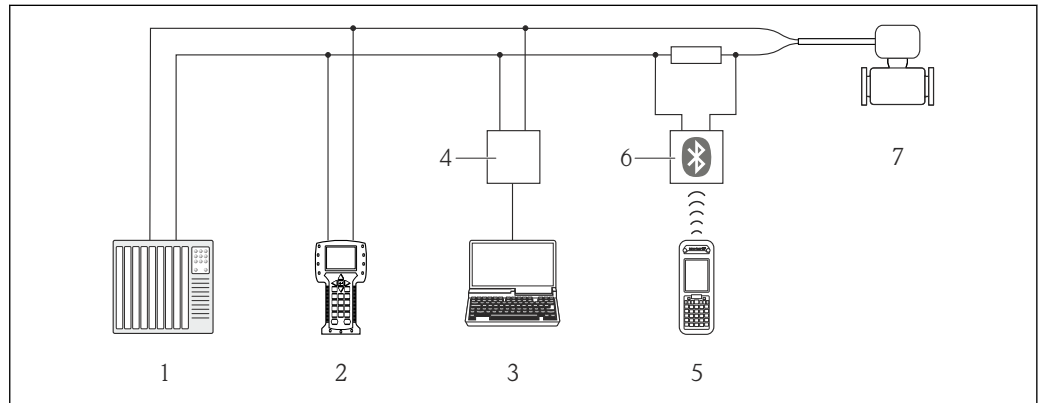

A0016948

11 Options for remote operation via HART protocol

- 1 Control system (e.g. PLC)
- 2 Field Communicator 475
- 3 Computer with operating tool (e.g. FieldCare, AMS Device Manager, SIMATIC PDM)
- 4 Commubox FXA195 (USB)
- 5 Field Xpert SFX350 or SFX370
- 6 VIATOR Bluetooth modem with connecting cable
- 7 Transmitter

Via service interface (CDI)

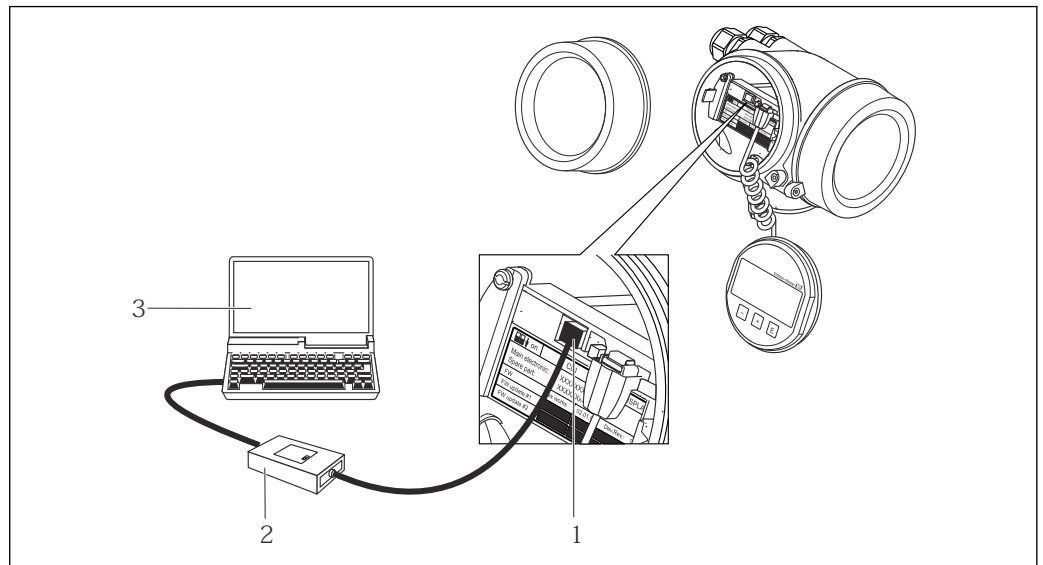

A0014019

- 1 Service interface (CDI = Endress+Hauser Common Data Interface) of the measuring device
- 2 Commubox FXA291
- 3 Computer with FieldCare operating tool with COM DTM CDI Communication FXA291

Via service interface (CDI-RJ45)

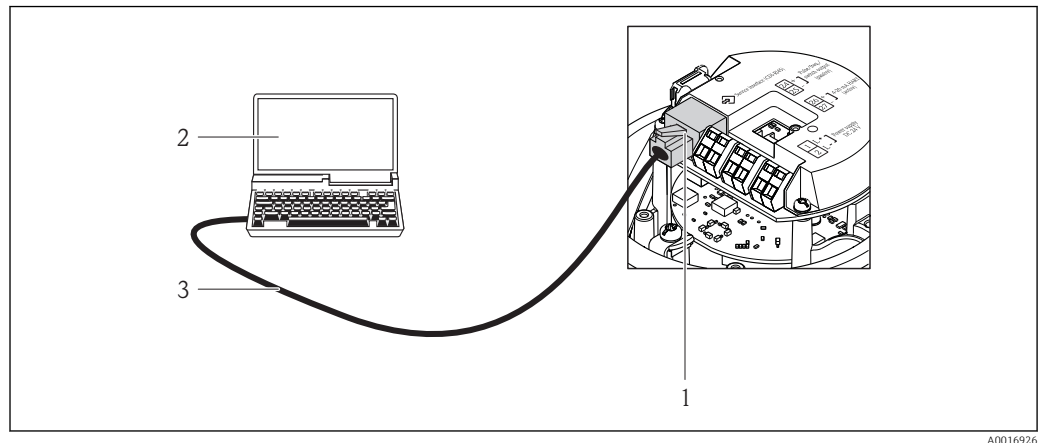
HART

 12 Connection for the order code for "Output", option B: 4-20 mA HART, pulse/frequency/switch output

- 1 Service interface (CDI -RJ45) of the measuring device with access to the integrated Web server
- 2 Computer with Web browser (e.g. Internet Explorer) for accessing the integrated device Web server or with "FieldCare" operating tool with COM DTM "CDI Communication TCP/IP"
- 3 Standard Ethernet connecting cable with RJ45 plug

8.4.2 Field Xpert SFX350, SFX370

Function range

Field Xpert SFX350 and Field Xpert SFX370 are mobile computers for commissioning and maintenance. They enable efficient device configuration and diagnostics for HART and FOUNDATION Fieldbus devices in the **non-hazardous area** (SFX350, SFX370) and **hazardous area** (SFX370).

 For details, see Operating Instructions BA01202S

Source for device description files

See information →  39

8.4.3 FieldCare

Function scope

FDT-based plant asset management tool from Endress+Hauser. It can configure all smart field devices in a system and helps you manage them. By using the status information, it is also a simple but effective way of checking their status and condition.

Access is via:

- HART protocol
- CDI-RJ45 service interface

Typical functions:

- Configuring parameters of transmitters
- Loading and saving device data (upload/download)
- Documentation of the measuring point
- Visualization of the measured value memory (line recorder) and event logbook

 For additional information about FieldCare, see Operating Instructions BA00027S and BA00059S

Source for device description files

See information →  39

Establishing a connection

1. Start FieldCare and launch the project.
2. In the network: Add a device.
 - ↳ The **Add device** window opens.
3. Select the **CDI Communication TCP/IP** option from the list and press **OK** to confirm.
4. Right-click **CDI Communication TCP/IP** and select the **Add device** option in the context menu that opens.
5. Select the desired device from the list and press **OK** to confirm.
 - ↳ The **CDI Communication TCP/IP (Configuration)** window opens.
6. Enter the device address in the **IP address** field and press **Enter** to confirm: 192.168.1.212 (factory setting); if the IP address is not known .
7. Establish the online connection to the device.



For additional information, see Operating Instructions BA00027S and BA00059S

User interface

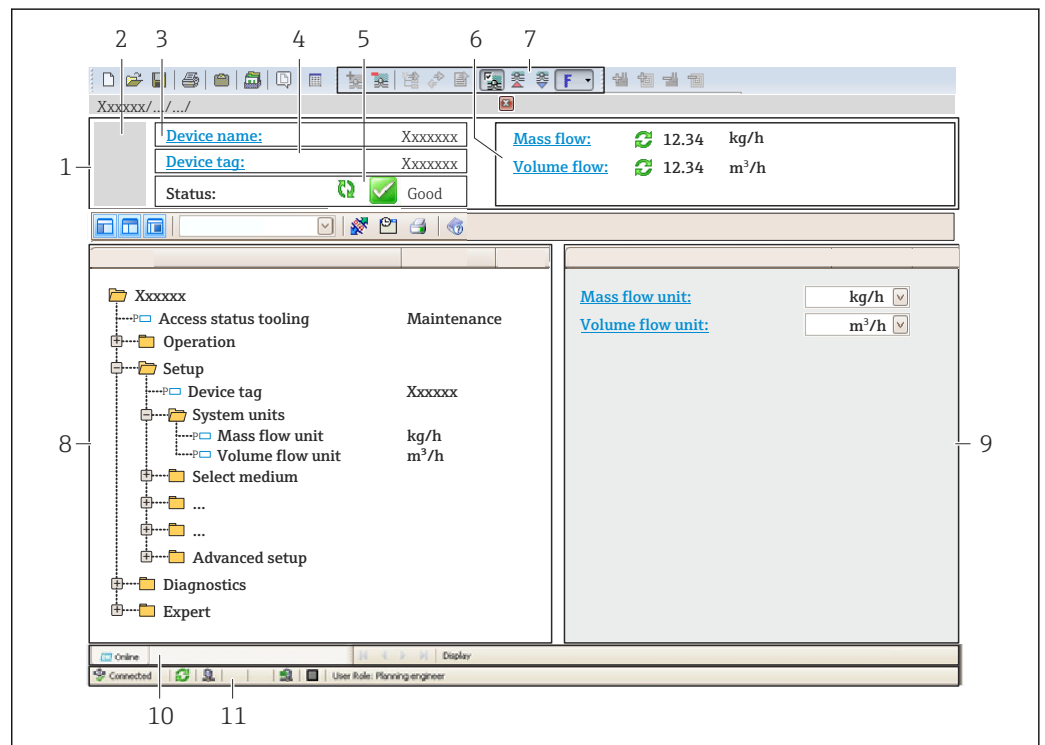

A0021051-EN

- 1 Header
- 2 Picture of device
- 3 Device name
- 4 Tag name
- 5 Status area with status signal → 74
- 6 Display area for current measured values
- 7 Edit toolbar with additional functions such as save/restore, event list and create documentation
- 8 Navigation area with operating menu structure
- 9 Working area
- 10 Range of action
- 11 Status area

8.4.4 DeviceCare

Function scope

Tool to connect and configure Endress+Hauser field devices.

The fastest way to configure Endress+Hauser field devices is with the dedicated "DeviceCare" tool. Together with the device type managers (DTMs) it presents a convenient, comprehensive solution.



For details, see Innovation Brochure IN01047S

Source for device description files

See information →  39

8.4.5 AMS Device Manager

Function scope

Program from Emerson Process Management for operating and configuring measuring devices via HART protocol.

Source for device description files

See data →  39

8.4.6 SIMATIC PDM

Function scope

SIMATIC PDM is a standardized, manufacturer-independent program from Siemens for the operation, configuration, maintenance and diagnosis of intelligent field devices via HART protocol.

Source for device description files

See data →  39

8.4.7 Field Communicator 475

Function scope

Industrial handheld terminal from Emerson Process Management for remote configuration and measured value display via HART protocol.



Source for device description files

See data →  39

9 System integration

9.1 Overview of device description files

9.1.1 Current version data for the device

Firmware version	01.00.zz	<ul style="list-style-type: none"> ▪ On the title page of the Operating Instructions ▪ On the transmitter nameplate →  12 ▪ Firmware version Diagnostics → Device information → Firmware version
Release date of firmware version	12.2017	---
Manufacturer ID	0x11	Manufacturer ID Diagnostics → Device information → Manufacturer ID
Device type ID	0x5c	Device type Diagnostics → Device information → Device type
HART protocol revision	7	---
Device revision	1	<ul style="list-style-type: none"> ▪ On the transmitter nameplate →  12 ▪ Device revision Diagnostics → Device information → Device revision

 For an overview of the different firmware versions for the device →  85

9.1.2 Operating tools

The suitable device description file for the individual operating tools is listed in the table below, along with information on where the file can be acquired.

Operating tool via HART protocol	Sources for obtaining device descriptions
FieldCare	<ul style="list-style-type: none"> ▪ www.endress.com → Download Area ▪ CD-ROM (contact Endress+Hauser) ▪ DVD (contact Endress+Hauser)
DeviceCare	<ul style="list-style-type: none"> ▪ www.endress.com → Download Area ▪ CD-ROM (contact Endress+Hauser) ▪ DVD (contact Endress+Hauser)
<ul style="list-style-type: none"> ▪ Field Xpert SFX350 ▪ Field Xpert SFX370 	Use update function of handheld terminal
AMS Device Manager (Emerson Process Management)	www.endress.com → Download Area
SIMATIC PDM (Siemens)	www.endress.com → Download Area
Field Communicator 475 (Emerson Process Management)	Use update function of handheld terminal

9.2 Measured variables via HART protocol

The following measured variables (HART device variables) are assigned to the dynamic variables at the factory:

Dynamic variables	Measured variables (HART device variables)
Primary dynamic variable (PV)	Volume flow
Secondary dynamic variable (SV)	Totalizer 1
Tertiary dynamic variable (TV)	Totalizer 2
Quaternary dynamic variable (QV)	Totalizer 3

The assignment of the measured variables to the dynamic variables can be modified and assigned as desired via the operating tool using the following parameters:

- Expert → Communication → HART output → Output → Assign PV
- Expert → Communication → HART output → Output → Assign SV
- Expert → Communication → HART output → Output → Assign TV
- Expert → Communication → HART output → Output → Assign QV

The following measured variables can be assigned to the dynamic variables:

Measured variables for PV (primary dynamic variable)

- Off
- Volume flow
- Mass flow
- Sound velocity
- Flow velocity
- Temperature
- Acceptance rate
- Signal strength
- Signal to noise ratio
- Turbulence
- Signal asymmetry

Measured variables for SV, TV, QV (secondary, tertiary and quaternary dynamic variable)

- Volume flow
- Mass flow
- Flow velocity
- Sound velocity
- Temperature
- Signal strength
- Signal to noise ratio
- Turbulence
- Acceptance rate
- Signal asymmetry
- Totalizer 1
- Totalizer 2
- Totalizer 3

9.3 Other settings

Burst mode functionality in accordance with HART 7 Specification:

Navigation

"Expert" menu → Communication → HART output → Burst configuration → Burst configuration 1 to n

▶ Burst configuration

▶ Burst configuration 1 to n

Burst mode 1 to n	→ 41
Burst command 1 to n	→ 41
Burst variable 0	→ 42
Burst variable 1	→ 42
Burst variable 2	→ 42
Burst variable 3	→ 42
Burst variable 4	→ 42
Burst variable 5	→ 42
Burst variable 6	→ 42
Burst variable 7	→ 42
Burst trigger mode	→ 42
Burst trigger level	→ 42
Min. update period	→ 42
Max. update period	→ 42

Parameter overview with brief description

Parameter	Description	Selection / User entry	Factory setting
Burst mode 1 to n	Activate the HART burst mode for burst message X.	<ul style="list-style-type: none"> ■ Off ■ On 	Off
Burst command 1 to n	Select the HART command that is sent to the HART master.	<ul style="list-style-type: none"> ■ Command 1 ■ Command 2 ■ Command 3 ■ Command 9 ■ Command 33 ■ Command 48 	Command 2



Parameter	Description	Selection / User entry	Factory setting
Burst variable 0	For HART command 9 and 33: select the HART device variable or the process variable.	<ul style="list-style-type: none"> ■ Volume flow ■ Mass flow ■ Flow velocity ■ Temperature ■ Sound velocity ■ Signal asymmetry * ■ Acceptance rate * ■ Turbulence * ■ Signal strength * ■ Signal to noise ratio * ■ Totalizer 1 ■ Totalizer 2 ■ Totalizer 3 ■ Percent of range ■ Measured current ■ Primary variable (PV) ■ Secondary variable (SV) ■ Tertiary variable (TV) ■ Quaternary variable (QV) ■ Not used 	Volume flow
Burst variable 1	For HART command 9 and 33: select the HART device variable or the process variable.	See the Burst variable 0 parameter.	Not used
Burst variable 2	For HART command 9 and 33: select the HART device variable or the process variable.	See the Burst variable 0 parameter.	Not used
Burst variable 3	For HART command 9 and 33: select the HART device variable or the process variable.	See the Burst variable 0 parameter.	Not used
Burst variable 4	For HART command 9: select the HART device variable or the process variable.	See the Burst variable 0 parameter.	Not used
Burst variable 5	For HART command 9: select the HART device variable or the process variable.	See the Burst variable 0 parameter.	Not used
Burst variable 6	For HART command 9: select the HART device variable or the process variable.	See the Burst variable 0 parameter.	Not used
Burst variable 7	For HART command 9: select the HART device variable or the process variable.	See the Burst variable 0 parameter.	Not used
Burst trigger mode	Select the event that triggers burst message X.	<ul style="list-style-type: none"> ■ Continuous ■ Window ■ Rising ■ Falling ■ On change 	Continuous
Burst trigger level	Enter the burst trigger value. Together with the option selected in the Burst trigger mode parameter the burst trigger value determines the time of burst message X.	Signed floating-point number	–
Min. update period	Enter the minimum time span between two burst commands of burst message X.	Positive integer	1 000 ms
Max. update period	Enter the maximum time span between two burst commands of burst message X.	Positive integer	2 000 ms

* Visibility depends on order options or device settings

10 Commissioning



10.1 Function check

Before commissioning the measuring device:

- ▶ Make sure that the post-installation and post-connection checks have been performed.
- "Post-installation check" checklist →  20
- "Post-connection check" checklist →  26

10.2 Switching on the measuring device

- ▶ After a successful function check, switch on the measuring device.
 - ↳ After a successful startup, the local display switches automatically from the startup display to the operational display.

 If nothing appears on the local display or a diagnostic message is displayed, refer to the section on "Diagnostics and troubleshooting" →  72.

10.3 Setting the operating language

Factory setting: English or ordered local language

The operating language can be set in FieldCare, DeviceCare or via the Web server:
Operation → Display language

10.4 Configuring the measuring device

The **Setup** menu with its submenus contains all the parameters needed for standard operation.

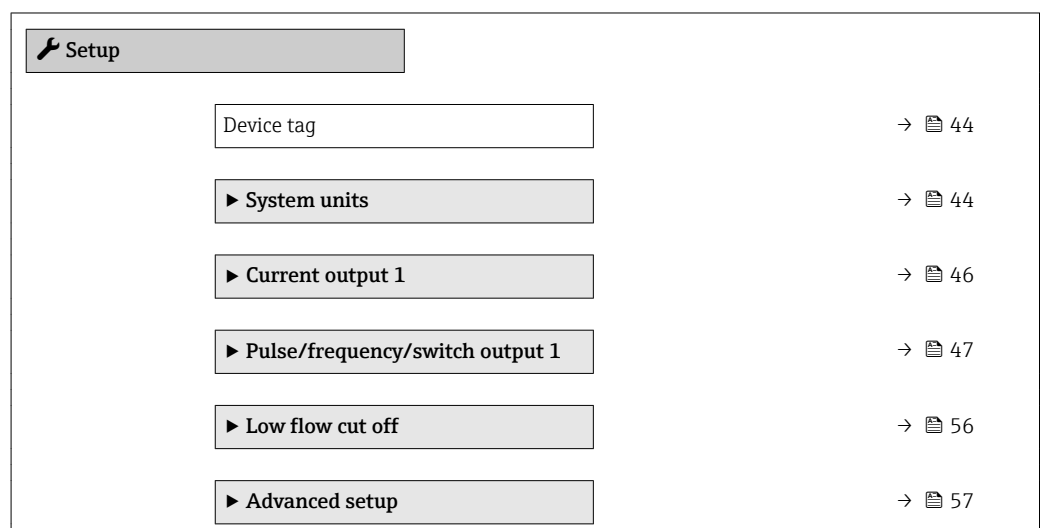

10.4.1 Defining the tag name

To enable fast identification of the measuring point within the system, you can enter a unique designation using the **Device tag** parameter and thus change the factory setting.

 Enter the tag name in the "FieldCare" operating tool →  37

Navigation

"Setup" menu → Device tag

Parameter overview with brief description

Parameter	Description	User entry	Factory setting
Device tag	Enter the name for the measuring point.	Max. 32 characters, such as letters, numbers or special characters (e.g. @, %, /).	Prosonic Flow E 100

10.4.2 Setting the system units

In the **System units** submenu the units of all the measured values can be set.

Navigation

"Setup" menu → System units

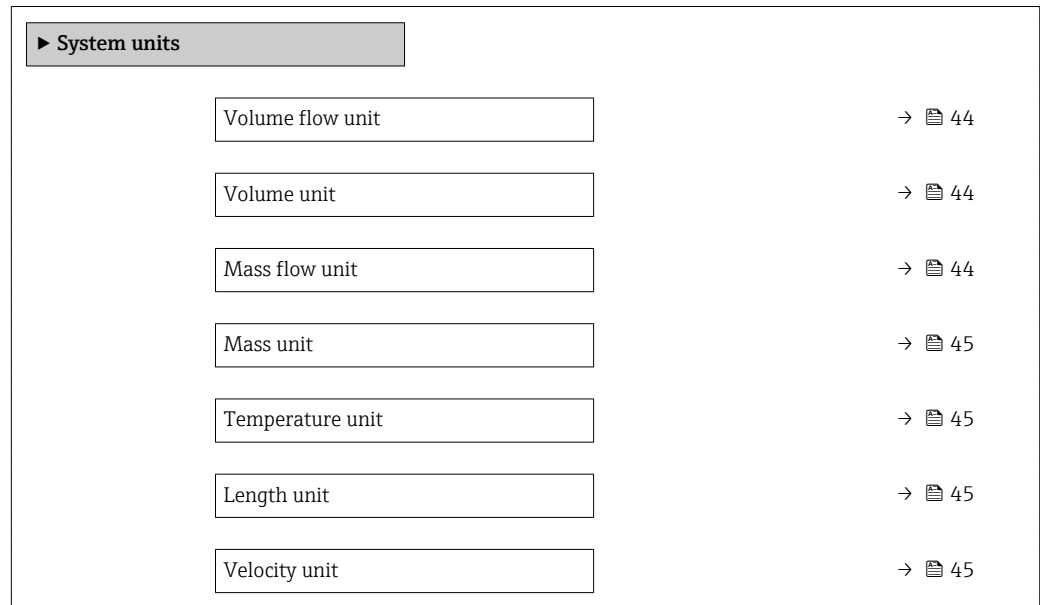

Parameter overview with brief description

Parameter	Description	Selection	Factory setting
Volume flow unit	Select volume flow unit. <i>Result</i> The selected unit applies for: <ul style="list-style-type: none"> ▪ Output ▪ Low flow cut off ▪ Simulation process variable 	Unit choose list	Country-specific: <ul style="list-style-type: none"> ▪ m³/h ▪ ft³/min
Volume unit	Select volume unit.	Unit choose list	Country-specific: <ul style="list-style-type: none"> ▪ dm³ ▪ ft³
Mass flow unit	Select mass flow unit. <i>Result</i> The selected unit applies for: <ul style="list-style-type: none"> ▪ Output ▪ Low flow cut off ▪ Simulation process variable 	Unit choose list	Country-specific: <ul style="list-style-type: none"> ▪ kg/h ▪ lb/min

Parameter	Description	Selection	Factory setting
Mass unit	Select mass unit.	Unit choose list	Country-specific: <ul style="list-style-type: none"> ■ kg ■ lb
Temperature unit	Select temperature unit. <i>Result</i> The selected unit applies for: <ul style="list-style-type: none"> ■ Temperature ■ Maximum value ■ Minimum value ■ Maximum value ■ Minimum value 	Unit choose list	Country-specific: <ul style="list-style-type: none"> ■ °C ■ °F
Length unit	Select length unit for nominal diameter.	Unit choose list	Country-specific: <ul style="list-style-type: none"> ■ mm ■ in
Velocity unit	Select velocity unit. <i>Result</i> The selected unit applies for: <ul style="list-style-type: none"> ■ Flow velocity ■ Sound velocity ■ Maximum value ■ Minimum value ■ Maximum value ■ Minimum value 	Unit choose list	Country-specific: <ul style="list-style-type: none"> ■ m/s ■ ft/s

10.4.3 Configuring the current output

The **Current output** submenu guides you systematically through all the parameters that have to be set for configuring the current output.

Navigation

"Setup" menu → Current output 1

Structure of the submenu

▶ Current output 1		
Assign current output 1	→	📖 46
Current span	→	📖 46
0/4 mA value	→	📖 46
20 mA value	→	📖 47
Fixed current	→	📖 47
Damping output 1	→	📖 47
Failure mode	→	📖 47
Failure current	→	📖 47

Parameter overview with brief description

Parameter	Prerequisite	Description	Selection / User entry	Factory setting
Assign current output 1	–	Select process variable for current output.	<ul style="list-style-type: none"> ▪ Off ▪ Volume flow ▪ Mass flow ▪ Sound velocity ▪ Flow velocity ▪ Temperature * ▪ Acceptance rate * ▪ Signal strength * ▪ Signal to noise ratio * ▪ Turbulence * ▪ Signal asymmetry * 	Volume flow
Current span	–	Select current range for process value output and upper/lower level for alarm signal.	<ul style="list-style-type: none"> ▪ 4...20 mA NAMUR ▪ 4...20 mA US ▪ 4...20 mA ▪ 0...20 mA ▪ Fixed current 	Country-specific: <ul style="list-style-type: none"> ▪ 4...20 mA NAMUR ▪ 4...20 mA US
0/4 mA value	One of the following options is selected in the Current span parameter (→ 📖 46): <ul style="list-style-type: none"> ▪ 4...20 mA NAMUR ▪ 4...20 mA US ▪ 4...20 mA ▪ 0...20 mA 	Enter 4 mA value.	Signed floating-point number	0 l/h

Parameter	Prerequisite	Description	Selection / User entry	Factory setting
20 mA value	One of the following options is selected in the Current span parameter (→ 46): <ul style="list-style-type: none"> ▪ 4...20 mA NAMUR ▪ 4...20 mA US ▪ 4...20 mA ▪ 0...20 mA 	Enter 20 mA value.	Signed floating-point number	Depends on country and nominal diameter
Fixed current	The Fixed current option is selected in the Current span parameter (→ 46).	Defines the fixed output current.	0 to 22.5 mA	22.5 mA
Damping output 1	One of the following options is selected in the Assign current output parameter (→ 46): <ul style="list-style-type: none"> ▪ Volume flow ▪ Mass flow ▪ Sound velocity ▪ Flow velocity ▪ Temperature * ▪ Acceptance rate * ▪ Signal strength * ▪ Signal to noise ratio * ▪ Turbulence * ▪ Signal asymmetry * One of the following options is selected in the Current span parameter (→ 46): <ul style="list-style-type: none"> ▪ 4...20 mA NAMUR ▪ 4...20 mA US ▪ 4...20 mA ▪ 0...20 mA 	Set reaction time for output signal to fluctuations in the measured value.	0.0 to 999.9 s	1.0 s
Failure mode	One of the following options is selected in the Assign current output parameter (→ 46): <ul style="list-style-type: none"> ▪ Volume flow ▪ Mass flow ▪ Sound velocity ▪ Flow velocity ▪ Temperature * ▪ Acceptance rate * ▪ Signal strength * ▪ Signal to noise ratio * ▪ Turbulence * ▪ Signal asymmetry * One of the following options is selected in the Current span parameter (→ 46): <ul style="list-style-type: none"> ▪ 4...20 mA NAMUR ▪ 4...20 mA US ▪ 4...20 mA ▪ 0...20 mA 	Define output behavior in alarm condition.	<ul style="list-style-type: none"> ▪ Min. ▪ Max. ▪ Last valid value ▪ Actual value ▪ Defined value 	Max.
Failure current	The Defined value option is selected in the Failure mode parameter.	Enter current output value in alarm condition.	0 to 22.5 mA	22.5 mA

* Visibility depends on order options or device settings

10.4.4 Configuring the pulse/frequency/switch output

The **Pulse/frequency/switch output** submenu contains all the parameters that must be configured for the configuration of the selected output type.

Navigation

"Setup" menu → Pulse/frequency/switch output 1

Structure of the "Pulse/frequency/switch output 1" submenu

► Pulse/frequency/switch output 1	
Operating mode	→ 49
Assign pulse output 1	→ 49
Assign frequency output	→ 50
Switch output function	→ 52
Assign diagnostic behavior	→ 53
Assign limit	→ 53
Assign flow direction check	→ 53
Assign status	→ 53
Value per pulse	→ 49
Pulse width	→ 49
Failure mode	→ 49
Minimum frequency value	→ 50
Maximum frequency value	→ 50
Measuring value at minimum frequency	→ 51
Measuring value at maximum frequency	→ 51
Damping output 1	→ 51
Failure mode	→ 52
Failure frequency	→ 52
Switch-on value	→ 53
Switch-on delay	→ 53
Switch-off value	→ 53

Switch-off delay	→ ⓘ 53
Failure mode	→ ⓘ 54
Invert output signal	→ ⓘ 49

Configuring the pulse output

Navigation

"Setup" menu → Pulse/frequency/switch output 1

Parameter overview with brief description

Parameter	Prerequisite	Description	Selection / User entry	Factory setting
Operating mode	–	Define the output as a pulse, frequency or switch output.	<ul style="list-style-type: none"> ■ Pulse ■ Frequency ■ Switch 	Pulse
Assign pulse output 1	The Pulse option is selected in the Operating mode parameter.	Select process variable for pulse output.	<ul style="list-style-type: none"> ■ Off ■ Volume flow ■ Mass flow 	Off
Value per pulse	In the Operating mode parameter, the Pulse option is selected, and one of the following options is selected in the Assign pulse output parameter (→ ⓘ 49): <ul style="list-style-type: none"> ■ Volume flow ■ Mass flow 	Enter measured value at which a pulse is output.	Signed floating-point number	Depends on country and nominal diameter
Pulse width	In the Operating mode parameter, the Pulse option is selected, and one of the following options is selected in the Assign pulse output parameter (→ ⓘ 49): <ul style="list-style-type: none"> ■ Volume flow ■ Mass flow 	Define time width of the output pulse.	0.05 to 2000 ms	100 ms
Failure mode	In the Operating mode parameter, the Pulse option is selected, and one of the following options is selected in the Assign pulse output parameter (→ ⓘ 49): <ul style="list-style-type: none"> ■ Volume flow ■ Mass flow 	Define output behavior in alarm condition.	<ul style="list-style-type: none"> ■ Actual value ■ No pulses 	No pulses
Invert output signal	–	Invert the output signal.	<ul style="list-style-type: none"> ■ No ■ Yes 	No



Configuring the frequency output

Navigation

"Setup" menu → Pulse/frequency/switch output 1

Parameter overview with brief description

Parameter	Prerequisite	Description	Selection / User entry	Factory setting
Operating mode	–	Define the output as a pulse, frequency or switch output.	<ul style="list-style-type: none"> ▪ Pulse ▪ Frequency ▪ Switch 	Pulse
Assign frequency output	The Frequency option is selected in the Operating mode parameter (→ 49) parameter.	Select process variable for frequency output.	<ul style="list-style-type: none"> ▪ Off ▪ Volume flow ▪ Mass flow ▪ Sound velocity ▪ Flow velocity ▪ Temperature ▪ Acceptance rate ▪ Signal strength ▪ Signal to noise ratio ▪ Turbulence ▪ Signal asymmetry 	Off
Minimum frequency value	In the Operating mode parameter, the Frequency option is selected, and one of the following options is selected in the Assign frequency output parameter (→ 50): <ul style="list-style-type: none"> ▪ Volume flow ▪ Mass flow ▪ Sound velocity ▪ Flow velocity ▪ Temperature ▪ Acceptance rate ▪ Signal strength ▪ Signal to noise ratio ▪ Turbulence ▪ Signal asymmetry 	Enter minimum frequency.	0.0 to 10 000.0 Hz	0.0 Hz
Maximum frequency value	In the Operating mode parameter, the Frequency option is selected, and one of the following options is selected in the Assign frequency output parameter (→ 50): <ul style="list-style-type: none"> ▪ Volume flow ▪ Mass flow ▪ Sound velocity ▪ Flow velocity ▪ Temperature ▪ Acceptance rate ▪ Signal strength ▪ Signal to noise ratio ▪ Turbulence ▪ Signal asymmetry 	Enter maximum frequency.	0.0 to 10 000.0 Hz	10 000.0 Hz

Parameter	Prerequisite	Description	Selection / User entry	Factory setting
Measuring value at minimum frequency	In the Operating mode parameter, the Frequency option is selected, and one of the following options is selected in the Assign frequency output parameter (→  50): <ul style="list-style-type: none"> ▪ Volume flow ▪ Mass flow ▪ Sound velocity ▪ Flow velocity ▪ Temperature ▪ Acceptance rate ▪ Signal strength ▪ Signal to noise ratio ▪ Turbulence ▪ Signal asymmetry 	Enter measured value for minimum frequency.	Signed floating-point number	Depends on country and nominal diameter
Measuring value at maximum frequency	In the Operating mode parameter, the Frequency option is selected, and one of the following options is selected in the Assign frequency output parameter (→  50): <ul style="list-style-type: none"> ▪ Volume flow ▪ Mass flow ▪ Sound velocity ▪ Flow velocity ▪ Temperature ▪ Acceptance rate ▪ Signal strength ▪ Signal to noise ratio ▪ Turbulence ▪ Signal asymmetry 	Enter measured value for maximum frequency.	Signed floating-point number	Depends on country and nominal diameter
Damping output 1	In the Operating mode parameter, the Frequency option is selected, and one of the following options is selected in the Assign frequency output parameter (→  50): <ul style="list-style-type: none"> ▪ Volume flow ▪ Mass flow ▪ Sound velocity ▪ Flow velocity ▪ Temperature * ▪ Acceptance rate * ▪ Signal strength * ▪ Signal to noise ratio * ▪ Turbulence * ▪ Signal asymmetry * 	Set reaction time for output signal to fluctuations in the measured value.	0 to 999.9 s	0.0 s

Parameter	Prerequisite	Description	Selection / User entry	Factory setting
Failure mode	In the Operating mode parameter, the Frequency option is selected, and one of the following options is selected in the Assign frequency output parameter (→ 50): <ul style="list-style-type: none"> ▪ Volume flow ▪ Mass flow ▪ Sound velocity ▪ Flow velocity ▪ Temperature ▪ Acceptance rate ▪ Signal strength ▪ Signal to noise ratio ▪ Turbulence ▪ Signal asymmetry 	Define output behavior in alarm condition.	<ul style="list-style-type: none"> ▪ Actual value ▪ Defined value ▪ 0 Hz 	0 Hz
Failure frequency	In the Operating mode parameter, the Frequency option is selected, and one of the following options is selected in the Assign frequency output parameter (→ 50): <ul style="list-style-type: none"> ▪ Volume flow ▪ Mass flow ▪ Sound velocity ▪ Flow velocity ▪ Temperature ▪ Acceptance rate ▪ Signal strength ▪ Signal to noise ratio ▪ Turbulence ▪ Signal asymmetry 	Enter frequency output value in alarm condition.	0.0 to 12 500.0 Hz	0.0 Hz
Invert output signal	–	Invert the output signal.	<ul style="list-style-type: none"> ▪ No ▪ Yes 	No

* Visibility depends on order options or device settings

Configuring the switch output

Navigation

"Setup" menu → Pulse/frequency/switch output 1

Parameter overview with brief description

Parameter	Prerequisite	Description	Selection / User entry	Factory setting
Operating mode	–	Define the output as a pulse, frequency or switch output.	<ul style="list-style-type: none"> ▪ Pulse ▪ Frequency ▪ Switch 	Pulse
Switch output function	The Switch option is selected in the Operating mode parameter.	Select function for switch output.	<ul style="list-style-type: none"> ▪ Off ▪ On ▪ Diagnostic behavior ▪ Limit ▪ Flow direction check ▪ Status 	Off

Parameter	Prerequisite	Description	Selection / User entry	Factory setting
Assign diagnostic behavior	<ul style="list-style-type: none"> ▪ In the Operating mode parameter, the Switch option is selected. ▪ In the Switch output function parameter, the Diagnostic behavior option is selected. 	Select diagnostic behavior for switch output.	<ul style="list-style-type: none"> ▪ Alarm ▪ Alarm or warning ▪ Warning 	Alarm
Assign limit	<ul style="list-style-type: none"> ▪ The Switch option is selected in the Operating mode parameter. ▪ The Limit option is selected in the Switch output function parameter. 	Select process variable for limit function.	<ul style="list-style-type: none"> ▪ Off ▪ Volume flow ▪ Mass flow ▪ Sound velocity ▪ Flow velocity ▪ Temperature ▪ Signal strength ▪ Signal to noise ratio ▪ Turbulence ▪ Signal asymmetry ▪ Acceptance rate ▪ Totalizer 1 ▪ Totalizer 2 ▪ Totalizer 3 	Volume flow
Assign flow direction check	<ul style="list-style-type: none"> ▪ The Switch option is selected in the Operating mode parameter. ▪ The Flow direction check option is selected in the Switch output function parameter. 	Select process variable for flow direction monitoring.	<ul style="list-style-type: none"> ▪ Off ▪ Volume flow ▪ Mass flow ▪ Flow velocity 	Volume flow
Assign status	<ul style="list-style-type: none"> ▪ The Switch option is selected in the Operating mode parameter. ▪ The Status option is selected in the Switch output function parameter. 	Select device status for switch output.	<ul style="list-style-type: none"> ▪ Off ▪ Low flow cut off 	Low flow cut off
Switch-on value	<ul style="list-style-type: none"> ▪ In the Operating mode parameter, the Switch option is selected. ▪ In the Switch output function parameter, the Limit option is selected. 	Enter measured value for the switch-on point.	Signed floating-point number	Country-specific: <ul style="list-style-type: none"> ▪ 0 m³/h ▪ 0 ft³/h
Switch-on delay	<ul style="list-style-type: none"> ▪ The Switch option is selected in the Operating mode parameter. ▪ The Limit option is selected in the Switch output function parameter. 	Define delay for the switch-on of status output.	0.0 to 100.0 s	0.0 s
Switch-off value	<ul style="list-style-type: none"> ▪ In the Operating mode parameter, the Switch option is selected. ▪ In the Switch output function parameter, the Limit option is selected. 	Enter measured value for the switch-off point.	Signed floating-point number	Country-specific: <ul style="list-style-type: none"> ▪ 0 m³/h ▪ 0 ft³/h
Switch-off delay	<ul style="list-style-type: none"> ▪ The Switch option is selected in the Operating mode parameter. ▪ The Limit option is selected in the Switch output function parameter. 	Define delay for the switch-off of status output.	0.0 to 100.0 s	0.0 s

Parameter	Prerequisite	Description	Selection / User entry	Factory setting
Failure mode	–	Define output behavior in alarm condition.	<ul style="list-style-type: none"> ▪ Actual status ▪ Open ▪ Closed 	Open
Invert output signal	–	Invert the output signal.	<ul style="list-style-type: none"> ▪ No ▪ Yes 	No

10.4.5 Configuring the output conditioning

The **Output conditioning** submenu contains all the parameters that must be configured for the configuration of output conditioning.

Navigation

"Setup" menu → Output conditioning

Structure of the "Output conditioning" submenu

► Output conditioning	
Assign current output	→ 55
Damping output 1	→ 55
Measuring mode output 1	→ 55
Assign frequency output	→ 55
Damping output 1	→ 55
Measuring mode output 1	→ 55
Assign pulse output	→ 55
Measuring mode output 1	→ 55
Operating mode totalizer 1	→ 55

Parameter overview with brief description

Parameter	Prerequisite	Description	Selection / User entry	Factory setting
Assign current output	–	Select process variable for current output.	<ul style="list-style-type: none"> ■ Off ■ Volume flow ■ Mass flow ■ Sound velocity ■ Flow velocity * ■ Temperature * ■ Acceptance rate * ■ Signal strength * ■ Signal to noise ratio * ■ Turbulence * ■ Signal asymmetry * 	Volume flow
Damping output 1	–	Set reaction time for output signal to fluctuations in the measured value.	0 to 999.9 s	1 s
Measuring mode output 1	–	Select measuring mode for output.	<ul style="list-style-type: none"> ■ Forward flow ■ Forward/Reverse flow ■ Reverse flow compensation 	Forward flow
Assign frequency output	The Frequency option is selected in the Operating mode parameter (→ 49) parameter.	Select process variable for frequency output.	<ul style="list-style-type: none"> ■ Off ■ Volume flow ■ Mass flow ■ Sound velocity ■ Flow velocity ■ Temperature ■ Acceptance rate ■ Signal strength ■ Signal to noise ratio ■ Turbulence ■ Signal asymmetry 	Off
Damping output 1	–	Set reaction time for output signal to fluctuations in the measured value.	0 to 999.9 s	1 s
Measuring mode output 1	–	Select measuring mode for output.	<ul style="list-style-type: none"> ■ Forward flow ■ Forward/Reverse flow ■ Reverse flow ■ Reverse flow compensation 	Forward flow
Assign pulse output	The Pulse option is selected in the Operating mode parameter parameter.	Select process variable for pulse output.	<ul style="list-style-type: none"> ■ Off ■ Volume flow ■ Mass flow 	Off
Measuring mode output 1	–	Select measuring mode for output.	<ul style="list-style-type: none"> ■ Forward flow ■ Forward/Reverse flow ■ Reverse flow ■ Reverse flow compensation 	Forward flow
Operating mode totalizer	–	Select totalizer calculation mode.	<ul style="list-style-type: none"> ■ Net flow total ■ Forward flow total ■ Reverse flow total 	Net flow total

* Visibility depends on order options or device settings

10.4.6 Configuring the low flow cut off

The **Low flow cut off** submenu contains the parameters that must be set in order to configure the low flow cut off.

Structure of the wizard

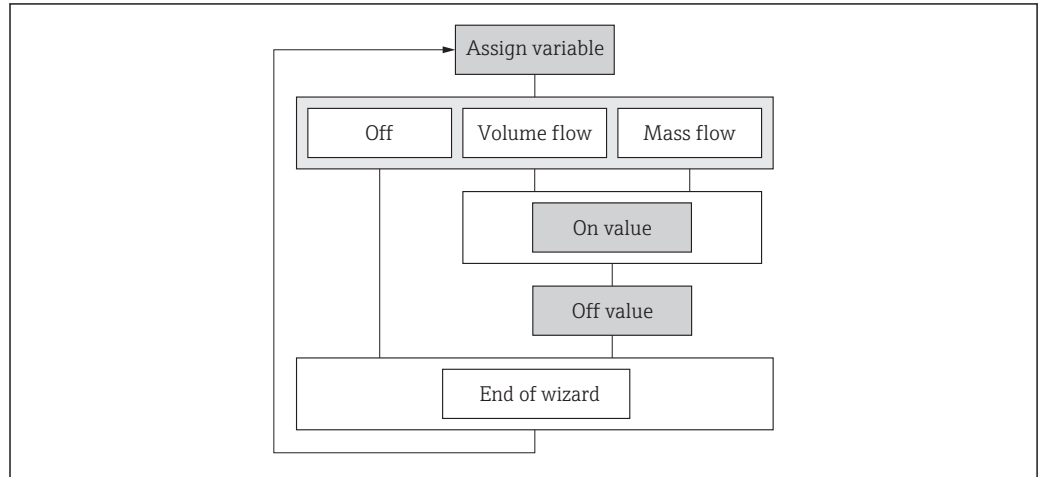

13 "Low flow cutoff" wizard in the "Setup" menu

Navigation

"Setup" menu → Low flow cut off

▶ **Low flow cut off**

Assign process variable → 56

On value low flow cutoff → 56

Off value low flow cutoff → 56

Parameter overview with brief description

Parameter	Prerequisite	Description	Selection / User entry	Factory setting
Assign process variable	–	Select process variable for low flow cut off.	<ul style="list-style-type: none"> ▪ Off ▪ Volume flow ▪ Mass flow 	Off
On value low flow cutoff	In the Assign process variable parameter (→ 56), one of the following options is selected: <ul style="list-style-type: none"> ▪ Volume flow ▪ Mass flow 	Enter on value for low flow cut off.	Positive floating-point number	Depends on country and nominal diameter
Off value low flow cutoff	In the Assign process variable parameter (→ 56), one of the following options is selected: <ul style="list-style-type: none"> ▪ Volume flow ▪ Mass flow 	Enter off value for low flow cut off.	0 to 100.0 %	50 %

10.5 Advanced settings

The **Advanced setup** submenu together with its submenus contains parameters for specific settings.

 The number of submenus can vary depending on the device version. Some submenus are not dealt with in the Operating Instructions. These submenus and the parameters they contain are explained in the Special Documentation for the device.

Navigation

"Setup" menu → Advanced setup

▶ **Advanced setup**

Enter access code →  57

▶ **Sensor adjustment** →  57

▶ **Totalizer 1 to n** →  58

▶ **Display** →  60

▶ **Heartbeat setup**

▶ **Administration** →  62

10.5.1 Using the parameter to enter the access code

Navigation

"Setup" menu → Advanced setup

Parameter overview with brief description

Parameter	Description	User entry
Enter access code	Enter access code to disable write protection of parameters.	0 to 9999

10.5.2 Carrying out a sensor adjustment

The **Sensor adjustment** submenu contains parameters that pertain to the functionality of the sensor.

Navigation

"Setup" menu → Advanced setup → Sensor adjustment

▶ **Sensor adjustment**

Installation direction →  58

Parameter overview with brief description

Parameter	Description	Selection	Factory setting
Installation direction	Set sign of flow direction to match the direction of the arrow on the sensor.	<ul style="list-style-type: none"> ▪ Flow in arrow direction ▪ Flow against arrow direction 	Flow in arrow direction

10.5.3 Configuring the totalizer

In the "Totalizer 1 to n" submenu the individual totalizer can be configured.

Navigation

"Setup" menu → Advanced setup → Totalizer 1 to n

▶ Totalizer 1 to n	
Assign process variable	→ ⓘ 58
Unit totalizer 1 to n	→ ⓘ 58
Totalizer operation mode	→ ⓘ 58
Failure mode	→ ⓘ 58

Parameter overview with brief description

Parameter	Prerequisite	Description	Selection	Factory setting
Assign process variable	–	Select process variable for totalizer.	<ul style="list-style-type: none"> ▪ Off ▪ Volume flow ▪ Mass flow 	Volume flow
Unit totalizer 1 to n	One of the following options is selected in the Assign process variable parameter (→ ⓘ 58) of the Totalizer 1 to n submenu: <ul style="list-style-type: none"> ▪ Volume flow ▪ Mass flow 	Select process variable totalizer unit.	Unit choose list	Country-specific: <ul style="list-style-type: none"> ▪ m³ ▪ ft³
Totalizer operation mode	One of the following options is selected in the Assign process variable parameter (→ ⓘ 58) of the Totalizer 1 to n submenu: <ul style="list-style-type: none"> ▪ Volume flow ▪ Mass flow 	Select totalizer calculation mode.	<ul style="list-style-type: none"> ▪ Net flow total ▪ Forward flow total ▪ Reverse flow total 	Net flow total
Failure mode	One of the following options is selected in the Assign process variable parameter (→ ⓘ 58) of the Totalizer 1 to n submenu: <ul style="list-style-type: none"> ▪ Volume flow ▪ Mass flow 	Define totalizer behavior in alarm condition.	<ul style="list-style-type: none"> ▪ Stop ▪ Actual value ▪ Last valid value 	Stop

10.5.4 Configuration management

After commissioning, you can save the current device configuration or restore the previous device configuration.

You can do so using the **Configuration management** parameter and the related options found in the .

Navigation

"Setup" menu → Advanced setup → Configuration backup display

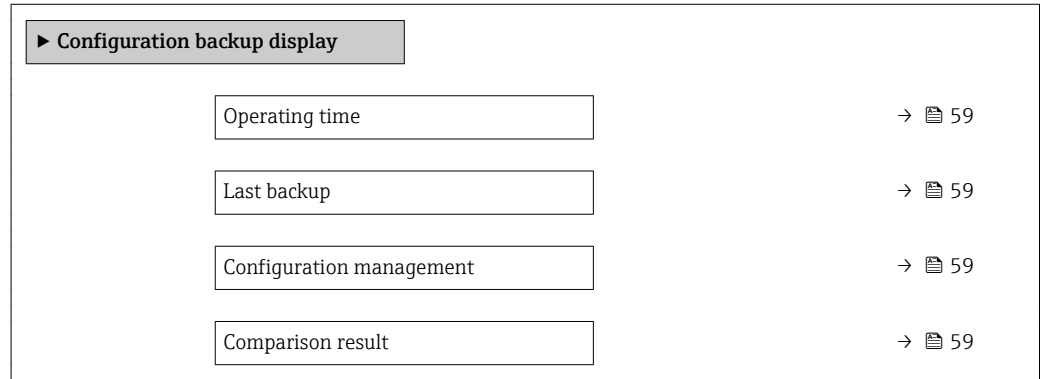

Parameter overview with brief description

Parameter	Prerequisite	Description	User interface / Selection	Factory setting
Operating time	–	Indicates how long the device has been in operation.	Days (d), hours (h), minutes (m) and seconds (s)	–
Last backup	A local display is provided.	Indicates when the last data backup was saved to the display module.	Days (d), hours (h), minutes (m) and seconds (s)	–
Configuration management	A local display is provided.	Select action for managing the device data in the display module.	<ul style="list-style-type: none"> ▪ Cancel ▪ Execute backup ▪ Restore ▪ Duplicate ▪ Compare ▪ Clear backup data 	Cancel
Comparison result	A local display is provided.	Comparison between present device data and display backup.	<ul style="list-style-type: none"> ▪ Settings identical ▪ Settings not identical ▪ No backup available ▪ Backup settings corrupt ▪ Check not done ▪ Dataset incompatible 	Check not done

Function scope of the "Configuration management" parameter

Options	Description
Cancel	No action is executed and the user exits the parameter.
Compare	The device configuration saved in the is compared with the current device configuration of the HistoROM backup.
Clear backup data	The backup copy of the device configuration is deleted of the device.

While this action is in progress, the configuration cannot be edited via the local display and a message on the processing status appears on the display.

10.5.5 Carrying out additional display configurations

In the **Display** submenu you can set all the parameters associated with the configuration of the local display.

Navigation

"Setup" menu → Advanced setup → Display

► Display	
Format display	→ 61
Value 1 display	→ 61
0% bargraph value 1	→ 61
100% bargraph value 1	→ 61
Decimal places 1	→ 61
Value 2 display	→ 61
Decimal places 2	→ 61
Value 3 display	→ 61
0% bargraph value 3	→ 61
100% bargraph value 3	→ 61
Decimal places 3	→ 61
Value 4 display	→ 61
Decimal places 4	→ 62
Display language	→ 62
Display interval	→ 62
Display damping	→ 62
Header	→ 62
Header text	→ 62
Separator	→ 62
Backlight	→ 62

Parameter overview with brief description

Parameter	Prerequisite	Description	Selection / User entry	Factory setting
Format display	A local display is provided.	Select how measured values are shown on the display.	<ul style="list-style-type: none"> ■ 1 value, max. size ■ 1 bargraph + 1 value ■ 2 values ■ 1 value large + 2 values ■ 4 values 	1 value, max. size
Value 1 display	A local display is provided.	Select the measured value that is shown on the local display.	<ul style="list-style-type: none"> ■ Mass flow ■ Sound velocity ■ Flow velocity ■ Temperature * ■ Volume flow ■ Current output 1 ■ Acceptance rate * ■ Signal asymmetry * ■ Turbulence * ■ Signal strength * ■ Current output 1 ■ Signal to noise ratio * ■ Totalizer 1 ■ Totalizer 2 ■ Totalizer 3 	Volume flow
0% bargraph value 1	A local display is provided.	Enter 0% value for bar graph display.	Signed floating-point number	Country-specific: <ul style="list-style-type: none"> ■ 0 m³/h ■ 0 ft³/h
100% bargraph value 1	A local display is provided.	Enter 100% value for bar graph display.	Signed floating-point number	Depends on country and nominal diameter
Decimal places 1	A measured value is specified in the Value 1 display parameter.	Select the number of decimal places for the display value.	<ul style="list-style-type: none"> ■ x ■ x.x ■ x.xx ■ x.xxx ■ x.xxxx 	x.xx
Value 2 display	A local display is provided.	Select the measured value that is shown on the local display.	For the picklist, see the Value 1 display parameter	None
Decimal places 2	A measured value is specified in the Value 2 display parameter.	Select the number of decimal places for the display value.	<ul style="list-style-type: none"> ■ x ■ x.x ■ x.xx ■ x.xxx ■ x.xxxx 	x.xx
Value 3 display	A local display is provided.	Select the measured value that is shown on the local display.	For the picklist, see the Value 1 display parameter (→  61)	None
0% bargraph value 3	A selection was made in the Value 3 display parameter.	Enter 0% value for bar graph display.	Signed floating-point number	Country-specific: <ul style="list-style-type: none"> ■ 0 m³/h ■ 0 ft³/h
100% bargraph value 3	A selection was made in the Value 3 display parameter.	Enter 100% value for bar graph display.	Signed floating-point number	0
Decimal places 3	A measured value is specified in the Value 3 display parameter.	Select the number of decimal places for the display value.	<ul style="list-style-type: none"> ■ x ■ x.x ■ x.xx ■ x.xxx ■ x.xxxx 	x.xx
Value 4 display	A local display is provided.	Select the measured value that is shown on the local display.	For the picklist, see the Value 1 display parameter (→  61)	None

Parameter	Prerequisite	Description	Selection / User entry	Factory setting
Decimal places 4	A measured value is specified in the Value 4 display parameter.	Select the number of decimal places for the display value.	<ul style="list-style-type: none"> ▪ x ▪ x.x ▪ x.xx ▪ x.xxx ▪ x.xxxx 	x.xx
Display language	A local display is provided.	Set display language.	<ul style="list-style-type: none"> ▪ English ▪ Deutsch * ▪ Français * ▪ Español * ▪ Italiano * ▪ Nederlands * ▪ Portuguesa * ▪ Polski * ▪ русский язык (Russian) * ▪ Svenska * ▪ Türkçe * ▪ 中文 (Chinese) * ▪ 日本語 (Japanese) * ▪ 한국어 (Korean) * ▪ العربية (Arabic) * ▪ Bahasa Indonesia * ▪ ภาษาไทย (Thai) * ▪ tiếng Việt (Vietnamese) * ▪ čeština (Czech) * 	English (alternatively, the ordered language is preset in the device)
Display interval	A local display is provided.	Set time measured values are shown on display if display alternates between values.	1 to 10 s	5 s
Display damping	A local display is provided.	Set display reaction time to fluctuations in the measured value.	0.0 to 999.9 s	0.0 s
Header	A local display is provided.	Select header contents on local display.	<ul style="list-style-type: none"> ▪ Device tag ▪ Free text 	Device tag
Header text	In the Header parameter, the Free text option is selected.	Enter display header text.	Max. 12 characters such as letters, numbers or special characters (e.g. @, %, /)	-----
Separator	A local display is provided.	Select decimal separator for displaying numerical values.	<ul style="list-style-type: none"> ▪ . (point) ▪ , (comma) 	. (point)
Backlight	–	Switch the local display backlight on and off.	<ul style="list-style-type: none"> ▪ Disable ▪ Enable 	Enable

* Visibility depends on order options or device settings

10.5.6 Using parameters for device administration

The **Administration** submenu systematically guides the user through all the parameters that can be used for device administration purposes.

Navigation

"Setup" menu → Advanced setup → Administration

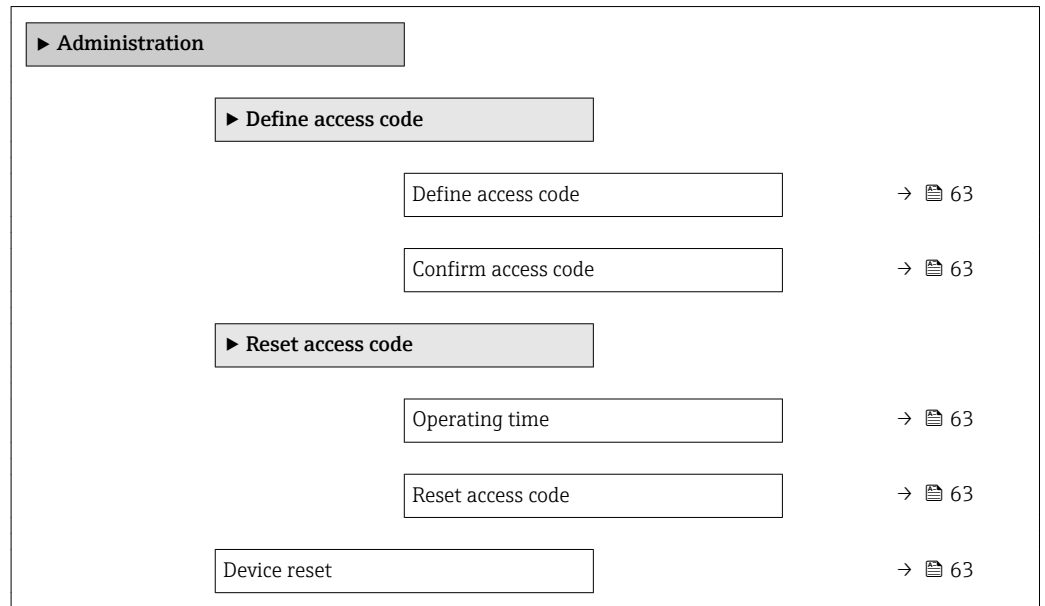

Parameter overview with brief description

Parameter	Description	User entry / User interface / Selection	Factory setting
Define access code	Restrict write-access to parameters to protect the configuration of the device against unintentional changes.	Max. 16-digit character string comprising numbers, letters and special characters	-
Confirm access code	Confirm the entered access code.	Max. 16-digit character string comprising numbers, letters and special characters	-
Operating time	Indicates how long the device has been in operation.	Days (d), hours (h), minutes (m) and seconds (s)	-
Reset access code	Reset access code to factory settings.  For a reset code, contact your Endress+Hauser service organization. The reset code can only be entered via: <ul style="list-style-type: none"> ▪ Web browser ▪ DeviceCare, FieldCare (via service interface CDI-RJ45) ▪ Fieldbus 	Character string comprising numbers, letters and special characters	0x00
Device reset	Reset the device configuration - either entirely or in part - to a defined state.	<ul style="list-style-type: none"> ▪ Cancel ▪ To delivery settings ▪ Restart device ▪ Restore S-DAT backup 	Cancel

10.6 Simulation

The **Simulation** submenu enables you to simulate, without a real flow situation, various process variables in the process and the device alarm mode and to verify downstream signal chains (switching valves or closed-control loops).





Navigation

"Diagnostics" menu → Simulation

► Simulation	
Assign simulation process variable	→ 64
Process variable value	→ 64
Current output 1 simulation	→ 64
Value current output 1	→ 65
Frequency output simulation 1	→ 65
Frequency value 1	→ 65
Pulse output simulation 1	→ 65
Pulse value 1	→ 65
Switch output simulation 1	→ 65
Switch status 1	→ 65
Device alarm simulation	→ 65
Diagnostic event category	→ 65
Diagnostic event simulation	→ 65

Parameter overview with brief description

Parameter	Prerequisite	Description	Selection / User entry	Factory setting
Assign simulation process variable	–	Select a process variable for the simulation process that is activated.	<ul style="list-style-type: none"> ▪ Off ▪ Volume flow ▪ Mass flow ▪ Sound velocity ▪ Flow velocity ▪ Temperature 	Off
Process variable value	In the Assign simulation process variable parameter (→ 64), one of the following options is selected: <ul style="list-style-type: none"> ▪ Volume flow ▪ Mass flow ▪ Sound velocity ▪ Flow velocity ▪ Temperature* 	Enter the simulation value for the selected process variable.	Depends on the process variable selected	0
Current output 1 simulation	–	Switch the simulation of the current output on and off.	<ul style="list-style-type: none"> ▪ Off ▪ On 	Off

Parameter	Prerequisite	Description	Selection / User entry	Factory setting
Value current output 1	In the Current output simulation parameter, the On option is selected.	Enter the current value for simulation.	3.59 to 22.5 mA	3.59 mA
Frequency output simulation 1	In the Operating mode parameter, the Frequency option is selected.	Switch the simulation of the frequency output on and off.	<ul style="list-style-type: none"> ▪ Off ▪ On 	Off
Frequency value 1	In the Frequency output simulation parameter, the On option is selected.	Enter the frequency value for the simulation.	0.0 to 12 500.0 Hz	0.0 Hz
Pulse output simulation 1	In the Operating mode parameter, the Pulse option is selected.	Set and switch off the pulse output simulation.  For Fixed value option: Pulse width parameter (→  49) defines the pulse width of the pulses output.	<ul style="list-style-type: none"> ▪ Off ▪ Fixed value ▪ Down-counting value 	Off
Pulse value 1	In the Pulse output simulation parameter (→  65), the Down-counting value option is selected.	Enter the number of pulses for simulation.	0 to 65 535	0
Switch output simulation 1	In the Operating mode parameter, the Switch option is selected.	Switch the simulation of the switch output on and off.	<ul style="list-style-type: none"> ▪ Off ▪ On 	Off
Switch status 1	In the Switch output simulation parameter (→  65) Switch output simulation 1 to n parameter Switch output simulation 1 to n parameter, the On option is selected.	Select the status of the status output for the simulation.	<ul style="list-style-type: none"> ▪ Open ▪ Closed 	Open
Device alarm simulation	–	Switch the device alarm on and off.	<ul style="list-style-type: none"> ▪ Off ▪ On 	Off
Diagnostic event category	–	Select a diagnostic event category.	<ul style="list-style-type: none"> ▪ Sensor ▪ Electronics ▪ Configuration ▪ Process 	Process
Diagnostic event simulation	–	Select a diagnostic event to simulate this event.	<ul style="list-style-type: none"> ▪ Off ▪ Diagnostic event picklist (depends on the category selected) 	Off

* Visibility depends on order options or device settings

10.7 Protecting settings from unauthorized access

The following options exist for protecting the configuration of the measuring device from unintentional modification after commissioning:

- Write protection via access code for Web browser
- Write protection via write protection switch →  66

10.7.1 Write protection via write protection switch

The write protection switch makes it possible to block write access to the entire operating menu with the exception of the following parameters:

- External pressure
- External temperature
- Reference density
- All parameters for configuring the totalizer

The parameter values are now read only and cannot be edited any more:

- Via service interface (CDI)
- Via HART protocol

1. Depending on the housing version, loosen the securing clamp or fixing screw of the housing cover.
2. Depending on the housing version, unscrew or open the housing cover and disconnect the local display from the main electronics module where necessary
→  101.

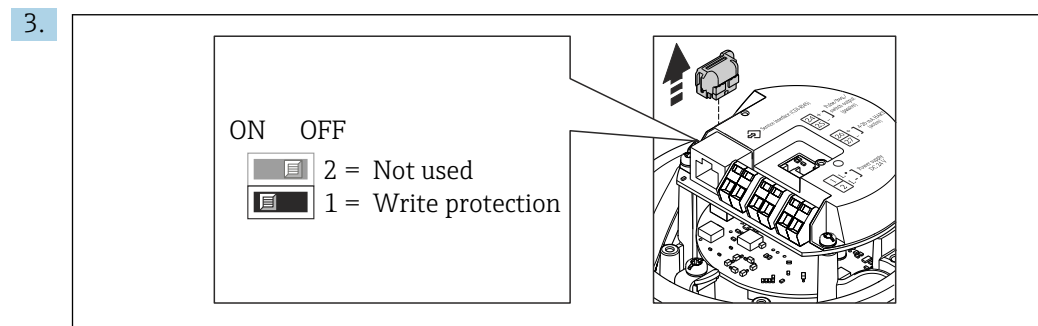

Disconnect the T-DAT from the main electronics module.

4. Setting the write protection switch on the main electronics module to the **ON** position enables the hardware write protection. Setting the write protection switch on the main electronics module to the **OFF** position (factory setting) disables the hardware write protection.
 - ↳ If hardware write protection is enabled: the **Locking status** parameter displays the **Hardware locked** option ; if disabled, the **Locking status** parameter does not display any option .
5. Reverse the removal procedure to reassemble the transmitter.

11 Operation

11.1 Reading the device locking status

Device active write protection: **Locking status** parameter

Navigation



"Operation" menu → Locking status

Function scope of "Locking status" parameter

Options	Description
Hardware locked	The locking switch (DIP switch) for locking the hardware is activated on the main electronic module. This prevents write access to the parameters .
Temporarily locked	Write access to the parameters is temporarily locked on account of internal processes running in the device (e.g. data upload/download, reset etc.). Once the internal processing has been completed, the parameters can be changed once again.

11.2 Adjusting the operating language

 Detailed information:

- To configure the operating language →  43
- For information on the operating languages supported by the measuring device →  102

11.3 Configuring the display

Detailed information:

On the advanced settings for the local display →  60

11.4 Reading measured values



With the **Measured values** submenu, it is possible to read all the measured values.

11.4.1 Process variables

The **Process variables** submenu contains all the parameters needed to display the current measured values for each process variable.

Navigation

"Diagnostics" menu → Measured values → Process variables

► Process variables	
Volume flow	→  68
Mass flow	→  68
Sound velocity	→  68

Flow velocity	→ 68
Temperature	→ 68

Parameter overview with brief description

Parameter	Description	User interface
Volume flow	Displays the volume flow currently measured. <i>Dependency</i> The unit is taken from the Volume flow unit parameter (→ 44).	Signed floating-point number
Mass flow	Displays the mass flow currently calculated. <i>Dependency</i> The unit is taken from the Mass flow unit parameter (→ 44).	Signed floating-point number
Sound velocity	Displays the sound velocity currently measured. <i>Dependency</i> The unit is taken from the Velocity unit parameter.	Signed floating-point number
Flow velocity	Displays the flow velocity currently measured. <i>Dependency</i> The unit is taken from the Velocity unit parameter.	Signed floating-point number
Temperature	Displays the temperature currently measured. <i>Dependency</i> The unit is taken from the Temperature unit parameter.	Signed floating-point number

11.4.2 System values

The **System values** submenu contains all the parameters needed to display the current measured values for every system value.

Diagnostics → Measured values → System values

Navigation

"Diagnostics" menu → Measured values → System values

▶ System values	
Signal strength	→ 69
Asymmetry	→ 69
Signal to noise ratio	→ 69
Turbulence	→ 69

Parameter overview with brief description

Parameter	Prerequisite	Description	User interface	Factory setting
Signal strength	-	Displays the current signal strength.	Signed floating-point number	-
Asymmetry	The Dual path sensor option is selected in the Path configuration parameter parameter.	Displays the asymmetry of the measured values between signal path 1 and signal path 2.	Signed floating-point number	0 %
Signal to noise ratio	-	Displays the current signal-to-noise ratio.	Signed floating-point number	-
Turbulence	-	Displays the current turbulence.	Signed floating-point number	-

11.4.3 Output values

The **Output values** submenu contains all the parameters needed to display the current measured values for every output.

Navigation

"Diagnostics" menu → Measured values → Output values

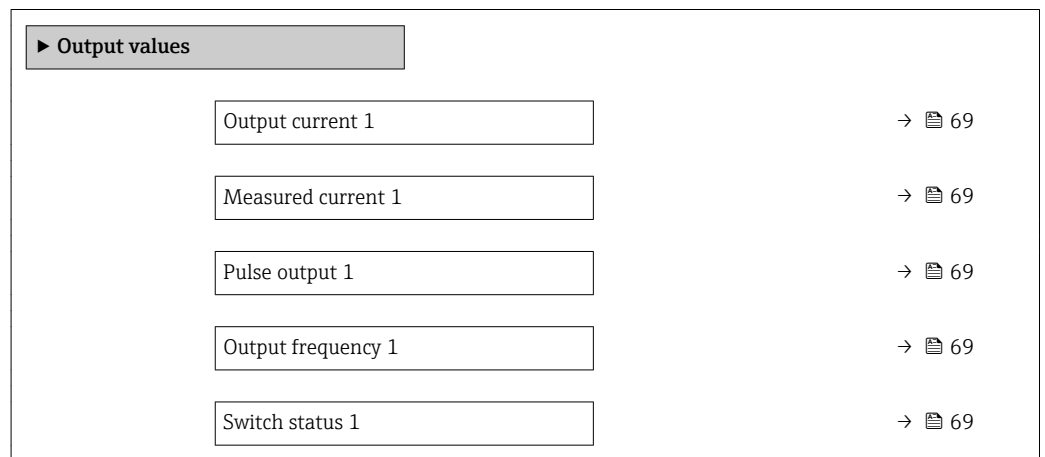

Parameter overview with brief description

Parameter	Prerequisite	Description	User interface
Output current 1	-	Displays the current value currently calculated for the current output.	3.59 to 22.5 mA
Measured current 1	-	Displays the current value currently measured for the current output.	0 to 30 mA
Pulse output 1	The Pulse option is selected in the Operating mode parameter parameter.	Displays the pulse frequency currently output.	Positive floating-point number
Output frequency 1	In the Operating mode parameter, the Frequency option is selected.	Displays the value currently measured for the frequency output.	0.0 to 12 500.0 Hz
Switch status 1	The Switch option is selected in the Operating mode parameter.	Displays the current switch output status.	<ul style="list-style-type: none"> ■ Open ■ Closed

11.4.4 "Totalizer" submenu

The **Totalizer** submenu contains all the parameters needed to display the current measured values for every totalizer.

Navigation

"Diagnostics" menu → Measured values → Totalizer

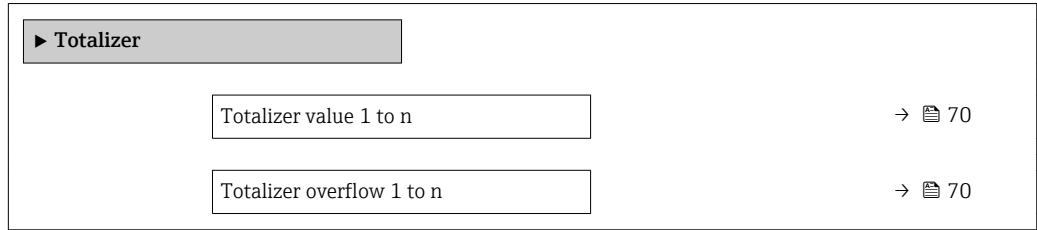

Parameter overview with brief description

Parameter	Prerequisite	Description	User interface
Totalizer value 1 to n	One of the following options is selected in the Assign process variable parameter (→ 58) of the Totalizer 1 to n submenu: <ul style="list-style-type: none"> ▪ Volume flow ▪ Mass flow 	Displays the current totalizer counter value.	Signed floating-point number
Totalizer overflow 1 to n	One of the following options is selected in the Assign process variable parameter (→ 58) of the Totalizer 1 to n submenu: <ul style="list-style-type: none"> ▪ Volume flow ▪ Mass flow 	Displays the current totalizer overflow.	Integer with sign

11.5 Adapting the measuring device to the process conditions

The following are available for this purpose:

- Basic settings using the **Setup** menu (→ 43)
- Advanced settings using the **Advanced setup** submenu (→ 57)

11.6 Performing a totalizer reset

The totalizers are reset in the **Operation** submenu:

- Control Totalizer
- Reset all totalizers

Navigation

"Operation" menu → Totalizer handling

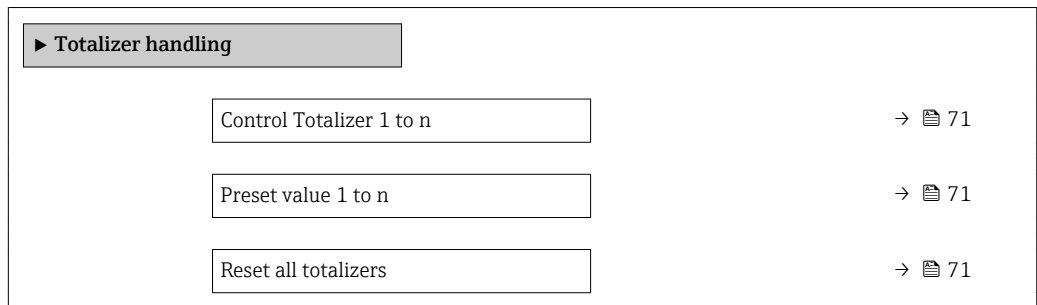

Parameter overview with brief description

Parameter	Prerequisite	Description	Selection / User entry	Factory setting
Control Totalizer 1 to n	One of the following options is selected in the Assign process variable parameter (→ 58) of the Totalizer 1 to n submenu: <ul style="list-style-type: none"> ▪ Volume flow ▪ Mass flow 	Control totalizer value.	<ul style="list-style-type: none"> ▪ Totalize ▪ Reset + hold ▪ Preset + hold ▪ Reset + totalize ▪ Preset + totalize ▪ Hold 	Totalize
Preset value 1 to n	One of the following options is selected in the Assign process variable parameter (→ 58) of the Totalizer 1 to n submenu: <ul style="list-style-type: none"> ▪ Volume flow ▪ Mass flow 	Specify start value for totalizer. <i>Dependency</i>  The unit of the selected process variable is specified for the totalizer in the Unit totalizer parameter (→ 58).	Signed floating-point number	Country-specific: <ul style="list-style-type: none"> ▪ 0 m³ ▪ 0 ft³
Reset all totalizers	–	Reset all totalizers to 0 and start.	<ul style="list-style-type: none"> ▪ Cancel ▪ Reset + totalize 	Cancel

11.6.1 Function scope of the "Control Totalizer" parameter

Options	Description
Totalize	The totalizer is started or continues running.
Reset + hold	The totaling process is stopped and the totalizer is reset to 0.
Preset + hold	The totaling process is stopped and the totalizer is set to its defined start value from the Preset value parameter.
Reset + totalize	The totalizer is reset to 0 and the totaling process is restarted.
Preset + totalize	The totalizer is set to the defined start value from the Preset value parameter and the totaling process is restarted.

11.6.2 Function scope of the "Reset all totalizers" parameter

Options	Description
Cancel	No action is executed and the user exits the parameter.
Reset + totalize	Resets all totalizers to 0 and restarts the totaling process. This deletes all the flow values previously totalized.

12 Diagnostics and troubleshooting

12.1 General troubleshooting

For local display





Error	Possible causes	Solution
Local display dark and no output signals	Supply voltage does not match the value indicated on the nameplate.	Apply the correct supply voltage → 23.
Local display dark and no output signals	The polarity of the supply voltage is wrong.	Correct the polarity.
Local display dark and no output signals	No contact between connecting cables and terminals.	Check the connection of the cables and correct if necessary.
Local display dark and no output signals	Terminals are not plugged into the I/O electronics module correctly.	Check terminals.
Local display dark and no output signals	I/O electronics module is defective.	Order spare part → 87.
Local display is dark, but signal output is within the valid range	Display is set too bright or too dark.	<ul style="list-style-type: none"> ▪ Set the display brighter by simultaneously pressing \square + \square. ▪ Set the display darker by simultaneously pressing \square + \square.
Local display is dark, but signal output is within the valid range	The cable of the display module is not plugged in correctly.	Insert the plug correctly into the main electronics module and display module.
Local display is dark, but signal output is within the valid range	Display module is defective.	Order spare part → 87.
Backlighting of local display is red	Diagnostic event with "Alarm" diagnostic behavior has occurred.	Take remedial measures
Message on local display: "Communication Error" "Check Electronics"	Communication between the display module and the electronics is interrupted.	<ul style="list-style-type: none"> ▪ Check the cable and the connector between the main electronics module and display module. ▪ Order spare part → 87.

For output signals

Error	Possible causes	Solution
Green power LED on the main electronics module of the transmitter is dark	Supply voltage does not match the value indicated on the nameplate.	Apply the correct supply voltage → 23.
Device measures incorrectly.	Configuration error or device is operated outside the application.	<ol style="list-style-type: none"> 1. Check and correct parameter configuration. 2. Observe limit values specified in the "Technical Data".

For access

Error	Possible causes	Solution
No write access to parameters	Hardware write protection enabled	Set the write protection switch on main electronics module to the OFF position → 66.
No connection via HART protocol	Communication resistor missing or incorrectly installed.	Install the communication resistor (250 Ω) correctly. Observe the maximum load .

Error	Possible causes	Solution
No connection via HART protocol	Commubox <ul style="list-style-type: none"> Connected incorrectly Configured incorrectly Drivers not installed correctly USB interface on computer configured incorrectly 	Observe the documentation for the Commubox.  FXA195 HART: Document "Technical Information" TI00404F
Not connecting to Web server	Web server disabled	Using the "FieldCare" or "DeviceCare" operating tool, check whether the Web server of the measuring device is enabled, and enable it if necessary →  34.
	Incorrect setting for the Ethernet interface of the computer	1. Check the properties of the Internet protocol (TCP/IP) →  31. 2. Check the network settings with the IT manager.
Not connecting to Web server	Incorrect IP address	Check the IP address: 192.168.1.212 →  31
Web browser frozen and operation no longer possible	Data transfer active	Wait until data transfer or current action is finished.
	Connection lost	1. Check cable connection and power supply. 2. Refresh the Web browser and restart if necessary.
Content of Web browser incomplete or difficult to read	Not using optimum version of Web server.	1. Use the correct Web browser version →  30. 2. Clear the Web browser cache and restart the Web browser.
	Unsuitable view settings.	Change the font size/display ratio of the Web browser.
No or incomplete display of contents in the Web browser	<ul style="list-style-type: none"> JavaScript not enabled JavaScript cannot be enabled 	1. Enable JavaScript. 2. Enter http://XXX.XXX.X.XXX/basic.html as the IP address.
Operation with FieldCare or DeviceCare via CDI-RJ45 service interface (port 8000)	Firewall of computer or network is preventing communication	Depending on the settings of the firewall used on the computer or in the network, the firewall must be adapted or disabled to allow FieldCare/DeviceCare access.
Flashing of firmware with FieldCare or DeviceCare via CDI-RJ45 service interface (via port 8000 or TFTP ports)	Firewall of computer or network is preventing communication	Depending on the settings of the firewall used on the computer or in the network, the firewall must be adapted or disabled to allow FieldCare/DeviceCare access.

12.2 Diagnostic information via light emitting diodes

12.2.1 Transmitter

Different LEDs in the transmitter provide information on the device status.

LED	Color	Meaning
Supply voltage	Off	Supply voltage is off or too low
	Green	Supply voltage is ok
Link/Activity	Orange	Link available but no activity
	Flashing orange	Activity present
Communication	Flashing white	HART communication is active.

12.3 Diagnostic information in the Web browser

12.3.1 Diagnostic options

Any faults detected by the measuring device are displayed in the Web browser on the home page once the user has logged on.

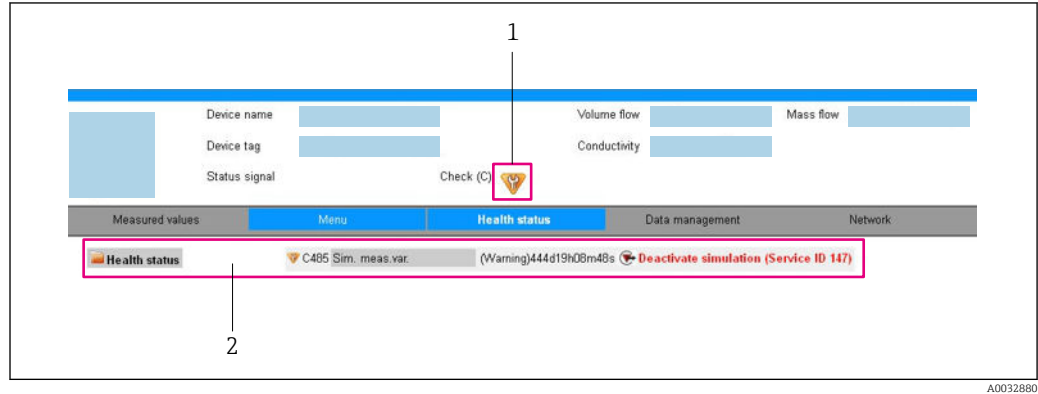

1 Status area with status signal

2 Diagnostic information → 74 and remedial measures with Service ID

i In addition, diagnostic events which have occurred can be shown in the **Diagnostics** menu:

- Via parameter
- Via submenu → 81

Status signals

The status signals provide information on the state and reliability of the device by categorizing the cause of the diagnostic information (diagnostic event).

Symbol	Meaning
	Failure A device error has occurred. The measured value is no longer valid.
	Function check The device is in service mode (e.g. during a simulation).
	Out of specification The device is operated: <ul style="list-style-type: none"> ▪ Outside its technical specification limits (e.g. outside the process temperature range) ▪ Outside of the configuration carried out by the user (e.g. maximum flow in parameter 20 mA value)
	Maintenance required Maintenance is required. The measured value is still valid.

i The status signals are categorized in accordance with VDI/VDE 2650 and NAMUR Recommendation NE 107.

Diagnostic information

The fault can be identified using the diagnostic information. The short text helps you by providing information about the fault.

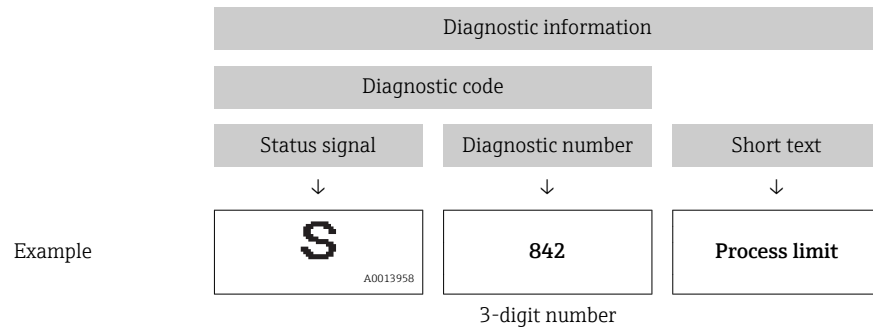

12.3.2 Calling up remedy information

Remedy information is provided for every diagnostic event to ensure that problems can be rectified quickly. These measures are displayed in red along with the diagnostic event and the related diagnostic information.

12.4 Diagnostic information in FieldCare or DeviceCare

12.4.1 Diagnostic options

Any faults detected by the measuring device are displayed on the home page of the operating tool once the connection has been established.

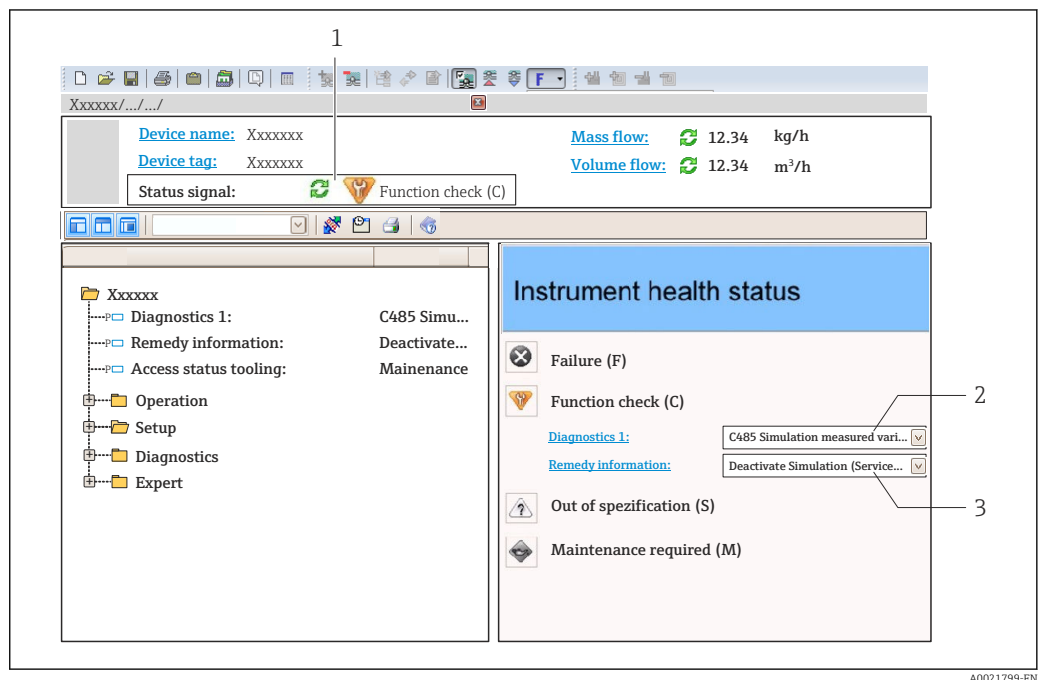

- 1 Status area with status signal
- 2 Diagnostic information → 74
- 3 Remedy information with Service ID

i In addition, diagnostic events which have occurred can be shown in the **Diagnostics** menu:

- Via parameter
- Via submenu → 81

Diagnostic information

The fault can be identified using the diagnostic information. The short text helps you by providing information about the fault.

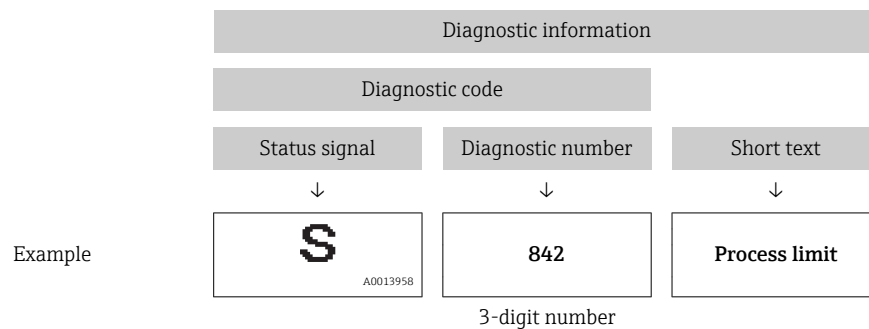

12.4.2 Calling up remedy information

Remedy information is provided for every diagnostic event to ensure that problems can be rectified quickly:

- On the home page
Remedy information is displayed in a separate field below the diagnostics information.
- In the **Diagnostics** menu
Remedy information can be called up in the working area of the user interface.

The user is in the **Diagnostics** menu.

1. Call up the desired parameter.
2. On the right in the working area, mouse over the parameter.
 - ↳ A tool tip with remedy information for the diagnostic event appears.

12.5 Adapting the diagnostic information

12.5.1 Adapting the diagnostic behavior

Each item of diagnostic information is assigned a specific diagnostic behavior at the factory. The user can change this assignment for specific diagnostic information in the **Diagnostic behavior** submenu.

Expert → System → Diagnostic handling → Diagnostic behavior

You can assign the following options to the diagnostic number as the diagnostic behavior:

Options	Description
Alarm	The device stops measurement. The signal outputs and totalizers assume the defined alarm condition. A diagnostic message is generated.
Warning	The device continues to measure. The signal outputs and totalizers are not affected. A diagnostic message is generated.
Logbook entry only	The device continues to measure. The diagnostic message is entered only in the Event logbook submenu (Event list submenu) and is not displayed in alternation with the measured value display.
Off	The diagnostic event is ignored, and no diagnostic message is generated or entered.

12.5.2 Adapting the status signal

Each item of diagnostic information is assigned a specific status signal at the factory. The user can change this assignment for specific diagnostic information in the **Diagnostic event category** submenu.

Expert → Communication → Diagnostic event category

Available status signals

Configuration as per HART 7 Specification (Condensed Status), in accordance with NAMUR NE107.

Symbol	Meaning
F <small>A0013956</small>	Failure A device error is present. The measured value is no longer valid.
C <small>A0013959</small>	Function check The device is in service mode (e.g. during a simulation).
S <small>A0013958</small>	Out of specification The device is being operated: <ul style="list-style-type: none"> ▪ Outside its technical specification limits (e.g. outside the process temperature range) ▪ Outside of the configuration carried out by the user (e.g. maximum flow in parameter 20 mA value)
M <small>A0013957</small>	Maintenance required Maintenance is required. The measured value is still valid.
N <small>A0023076</small>	Has no effect on the condensed status.

12.6 Overview of diagnostic information

 The amount of diagnostic information and the number of measured variables affected increase if the measuring device has one or more application packages.

 In the case of some items of diagnostic information, the status signal and the diagnostic behavior can be changed. Change the diagnostic information →  76

Diagnostic number	Short text	Remedy instructions	Status signal [from the factory]	Diagnostic behavior [from the factory]
Diagnostic of sensor				
022	Temperature sensor defective	1. Replace sensor electronic module (ISEM) 2. Replace device	F	Alarm
082	Data storage	1. Check module connections 2. Contact service	F	Alarm
083	Memory content	1. Restart device 2. Restore HistoROM S-DAT backup ('Device reset' parameter) 3. Replace HistoROM S-DAT	F	Alarm
104	Sensor signal path 1 to n	1. Check process conditions 2. Replace sensor electronic module (ISEM) 3. Replace device	F	Alarm
105	Downstream transducer path 1 to n defective	Replace device	F	Alarm

Diagnostic number	Short text	Remedy instructions	Status signal [from the factory]	Diagnostic behavior [from the factory]
106	Upstream transducer path 1 to n defective	Replace device	F	Alarm
124	Relative signal strength	1. Check or replace connection cable between sensor electronic module (ISEM) and main electronics 2. Check or replace ISEM or main electronics	M	Warning ¹⁾
125	Relative sound velocity	Check process conditions	M	Warning ¹⁾
160	Signal path switched off	Contact service	M	Warning ¹⁾
Diagnostic of electronic				
201	Device failure	1. Restart device 2. Contact service	F	Alarm
222	Electronic drift	Change main electronic module	F	Alarm
242	Software incompatible	1. Check software 2. Flash or change main electronics module	F	Alarm
252	Modules incompatible	1. Check electronic modules 2. Change electronic modules	F	Alarm
261	Electronic modules	1. Restart device 2. Check electronic modules 3. Change I/O Modul or main electronics	F	Alarm
262	Sensor electronic connection faulty	1. Check or replace connection cable between sensor electronic module (ISEM) and main electronics 2. Check or replace ISEM or main electronics	F	Alarm
270	Main electronic failure	Change main electronic module	F	Alarm
271	Main electronic failure	1. Restart device 2. Change main electronic module	F	Alarm
272	Main electronic failure	1. Restart device 2. Contact service	F	Alarm
273	Main electronic failure	Change electronic	F	Alarm
276	I/O module faulty	1. Restart device 2. Change I/O module	F	Alarm
281	Electronic initialization	Firmware update active, please wait!	F	Alarm
283	Memory content	1. Reset device 2. Contact service	F	Alarm
302	Device verification active	Device verification active, please wait.	C	Warning
311	Electronic failure	1. Do not reset device 2. Contact service	M	Warning
372	Sensor electronic (ISEM) faulty	1. Restart device 2. Check if failure recurs 3. Replace sensor electronic module (ISEM)	F	Alarm
373	Sensor electronic (ISEM) faulty	1. Transfer data or reset device 2. Contact service	F	Alarm
375	I/O- communication failed	1. Restart device 2. Check if failure recurs 3. Replace module rack inclusive electronic modules	F	Alarm

Diagnostic number	Short text	Remedy instructions	Status signal [from the factory]	Diagnostic behavior [from the factory]
382	Data storage	1. Insert T-DAT 2. Replace T-DAT	F	Alarm
383	Memory content	1. Restart device 2. Delete T-DAT via 'Reset device' parameter 3. Replace T-DAT	F	Alarm
384	Transmitter circuit	1. Restart device 2. Check if failure recurs 3. Replace sensor electronic module (ISEM)	F	Alarm
385	Amplifier circuit	1. Restart device 2. Check if failure recurs 3. Replace sensor electronic module (ISEM)	F	Alarm
386	Time of flight	1. Restart device 2. Check if failure recurs 3. Replace sensor electronic module (ISEM)	F	Alarm
Diagnostic of configuration				
410	Data transfer	1. Check connection 2. Retry data transfer	F	Alarm
412	Processing download	Download active, please wait	C	Warning
431	Trim 1	Carry out trim	C	Warning
437	Configuration incompatible	1. Restart device 2. Contact service	F	Alarm
438	Dataset	1. Check data set file 2. Check device configuration 3. Up- and download new configuration	M	Warning
441	Current output	1. Check process 2. Check current output settings	S	Warning ¹⁾
442	Frequency output	1. Check process 2. Check frequency output settings	S	Warning ¹⁾
443	Pulse output	1. Check process 2. Check pulse output settings	S	Warning ¹⁾
453	Flow override	Deactivate flow override	C	Warning
484	Failure mode simulation	Deactivate simulation	C	Alarm
485	Measured variable simulation	Deactivate simulation	C	Warning
491	Current output 1 simulation	Deactivate simulation	C	Warning
492	Simulation frequency output	Deactivate simulation frequency output	C	Warning
493	Simulation pulse output	Deactivate simulation pulse output	C	Warning
494	Switch output simulation	Deactivate simulation switch output	C	Warning
495	Diagnostic event simulation	Deactivate simulation	C	Warning
537	Configuration	1. Check IP addresses in network 2. Change IP address	F	Warning



Diagnostic number	Short text	Remedy instructions	Status signal [from the factory]	Diagnostic behavior [from the factory]
Diagnostic of process				
803	Current loop	1. Check wiring 2. Change I/O module	F	Alarm
832	Electronic temperature too high	Reduce ambient temperature	S	Warning ¹⁾
833	Electronic temperature too low	Increase ambient temperature	S	Warning ¹⁾
834	Process temperature too high	Reduce process temperature	S	Warning ¹⁾
835	Process temperature too low	Increase process temperature	S	Warning ¹⁾
840	Sensor range	Check flow velocity	S	Warning ¹⁾
842	Process limit	Low flow cut off active! 1. Check low flow cut off configuration	S	Warning
881	Sensor signal path 1 to n	1. Check process conditions 2. Replace sensor electronic module (ISEM) 3. Replace device	M	Warning ¹⁾
882	Input signal	1. Check input configuration 2. Check external device or process conditions	F	Alarm



1) Diagnostic behavior can be changed.

12.7 Pending diagnostic events

The **Diagnostics** menu allows the user to view the current diagnostic event and the previous diagnostic event separately.





 To call up the measures to rectify a diagnostic event:

- Via Web browser →  75
- Via "FieldCare" operating tool →  76
- Via "DeviceCare" operating tool →  76

 Other pending diagnostic events can be displayed in the **Diagnostic list** submenu →  81

Navigation

"Diagnostics" menu

 Diagnostics	
Actual diagnostics	→  81
Previous diagnostics	→  81
Operating time from restart	→  81
Operating time	→  81

Parameter overview with brief description

Parameter	Prerequisite	Description	User interface
Actual diagnostics	A diagnostic event has occurred.	Shows the current occurred diagnostic event along with its diagnostic information.  If two or more messages occur simultaneously, the message with the highest priority is shown on the display.	Symbol for diagnostic behavior, diagnostic code and short message.
Previous diagnostics	Two diagnostic events have already occurred.	Shows the diagnostic event that occurred prior to the current diagnostic event along with its diagnostic information.	Symbol for diagnostic behavior, diagnostic code and short message.
Operating time from restart	–	Shows the time the device has been in operation since the last device restart.	Days (d), hours (h), minutes (m) and seconds (s)
Operating time	–	Indicates how long the device has been in operation.	Days (d), hours (h), minutes (m) and seconds (s)

12.8 Diagnostic list



Up to 5 currently pending diagnostic events can be displayed in the **Diagnostic list** submenu along with the associated diagnostic information. If more than 5 diagnostic events are pending, the events with the highest priority are shown on the display.

Navigation path

Diagnostics → Diagnostic list



To call up the measures to rectify a diagnostic event:

- Via Web browser →  75
- Via "FieldCare" operating tool →  76
- Via "DeviceCare" operating tool →  76

12.9 Event logbook

12.9.1 Reading out the event logbook



A chronological overview of the event messages that have occurred is provided in the **Events list** submenu.

Navigation path

Diagnostics menu → **Event logbook** submenu → Event list

A maximum of 20 event messages can be displayed in chronological order.



The event history includes entries for:

- Diagnostic events →  77
- Information events →  82

In addition to the operation time of its occurrence, each event is also assigned a symbol that indicates whether the event has occurred or is ended:

- Diagnostic event
 - ☺: Occurrence of the event
 - ☹: End of the event
- Information event
 - ☺: Occurrence of the event

 To call up the measures to rectify a diagnostic event:

- Via Web browser →  75
- Via "FieldCare" operating tool →  76
- Via "DeviceCare" operating tool →  76

 For filtering the displayed event messages →  82

12.9.2 Filtering the event logbook

Using the **Filter options** parameter you can define which category of event message is displayed in the **Events list** submenu.

Navigation path

Diagnostics → Event logbook → Filter options

Filter categories

- All
- Failure (F)
- Function check (C)
- Out of specification (S)
- Maintenance required (M)
- Information (I)

12.9.3 Overview of information events

Unlike a diagnostic event, an information event is displayed in the event logbook only and not in the diagnostic list.

Info number	Info name
I1000	----- (Device ok)
I1079	Sensor changed
I1089	Power on
I1090	Configuration reset
I1091	Configuration changed
I1092	HistoROM backup deleted
I1137	Electronic changed
I1151	History reset
I1155	Reset electronic temperature
I1157	Memory error event list
I1184	Display connected
I1256	Display: access status changed
I1264	Safety sequence aborted
I1278	I/O module reset detected
I1327	Zero point adjust failed signal path
I1335	Firmware changed
I1361	Web server: login failed

Info number	Info name
I1397	Fieldbus: access status changed
I1398	CDI: access status changed
I1444	Device verification passed
I1445	Device verification failed
I1459	I/O module verification failed
I1461	Sensor verification failed
I1462	Sensor electronic module verific. failed
I1512	Download started
I1513	Download finished
I1514	Upload started
I1515	Upload finished
I1624	Reset all totalizers
I1627	Web server: login successful
I1629	CDI: login successful
I1631	Web server access changed
I1633	CDI: login failed
I1634	Reset to factory settings
I1635	Reset to delivery settings
I1649	Hardware write protection activated
I1650	Hardware write protection deactivated
I1725	Sensor electronic module (ISEM) changed

12.10 Resetting the measuring device

Using the **Device reset** parameter (→  63) it is possible to reset the entire device configuration or some of the configuration to a defined state.

12.10.1 Function scope of the "Device reset" parameter

Options	Description
Cancel	No action is executed and the user exits the parameter.
To delivery settings	Every parameter for which a customer-specific default setting was ordered is reset to this customer-specific value. All other parameters are reset to the factory setting.  This option is not visible if no customer-specific settings have been ordered.
Restart device	The restart resets every parameter whose data are in the volatile memory (RAM) to the factory setting (e.g. measured value data). The device configuration remains unchanged.

12.11 Device information



The **Device information** submenu contains all parameters that display different information for device identification.



Navigation

"Diagnostics" menu → Device information



► Device information	
Device tag	→ 84
Serial number	→ 84
Firmware version	→ 84
Device name	→ 84
Order code	→ 84
Extended order code 1	→ 85
Extended order code 2	→ 85
Extended order code 3	→ 85
ENP version	→ 85
Device revision	→ 85
Device ID	→ 85
Device type	→ 85
Manufacturer ID	→ 85

Parameter overview with brief description

Parameter	Description	User interface	Factory setting
Device tag	Shows name of measuring point.	Max. 32 characters, such as letters, numbers or special characters (e.g. @, %, /).	Prosonic Flow E 100
Serial number	Shows the serial number of the measuring device.	Max. 11-digit character string comprising letters and numbers.	–
Firmware version	Shows the device firmware version installed.	Character string in the format xx.yy.zz	–
Device name	Shows the name of the transmitter.  The name can be found on the nameplate of the transmitter.	Max. 32 characters such as letters or numbers.	Pros.Flow E 100
Order code	Shows the device order code.  The order code can be found on the nameplate of the sensor and transmitter in the "Order code" field.	Character string composed of letters, numbers and certain punctuation marks (e.g. /).	–

Parameter	Description	User interface	Factory setting
Extended order code 1	Shows the 1st part of the extended order code.  The extended order code can also be found on the nameplate of the sensor and transmitter in the "Ext. ord. cd." field.	Character string	–
Extended order code 2	Shows the 2nd part of the extended order code.  The extended order code can also be found on the nameplate of the sensor and transmitter in the "Ext. ord. cd." field.	Character string	–
Extended order code 3	Shows the 3rd part of the extended order code.  The extended order code can also be found on the nameplate of the sensor and transmitter in the "Ext. ord. cd." field.	Character string	–
ENP version	Shows the version of the electronic nameplate (ENP).	Character string	2.02.00
Device revision	Shows the device revision with which the device is registered with the HART Communication Foundation.	2-digit hexadecimal number	0x01
Device ID	Shows the device ID for identifying the device in a HART network.	6-digit hexadecimal number	–
Device type	Shows the device type with which the measuring device is registered with the HART Communication Foundation.	2-digit hexadecimal number	0x5c (for Prosonic Flow E 100)
Manufacturer ID	Shows the manufacturer ID device is registered with the HART Communication Foundation.	2-digit hexadecimal number	0x11 (for Endress+Hauser)

12.12 Firmware history

-  It is possible to flash the firmware to the current version or the previous version using the service interface.
-  For the compatibility of the firmware version with the previous version, the installed device description files and operating tools, observe the information about the device in the "Manufacturer's information" document.
-  The manufacturer's information is available:
 - In the Download Area of the Endress+Hauser web site: www.endress.com → Downloads
 - Specify the following details:
 - Product root, e.g. 9E1B
The product root is the first part of the order code: see the nameplate on the device.
 - Text search: Manufacturer's information
 - Media type: Documentation – Technical Documentation

13 Maintenance

13.1 Maintenance tasks

No special maintenance work is required.

13.1.1 Exterior cleaning

When cleaning the exterior of measuring devices, always use cleaning agents that do not attack the surface of the housing or the seals.

13.2 Measuring and test equipment

Endress+Hauser offers a wide variety of measuring and test equipment, such as W@M or device tests.

 Your Endress+Hauser Sales Center can provide detailed information on the services.

List of some of the measuring and testing equipment: →  89

13.3 Endress+Hauser services

Endress+Hauser offers a wide variety of services for maintenance such as recalibration, maintenance service or device tests.

 Your Endress+Hauser Sales Center can provide detailed information on the services.

14 Repairs

14.1 General notes

14.1.1 Repair and conversion concept

The Endress+Hauser repair and conversion concept provides for the following:

- The measuring devices have a modular design.
- Spare parts are grouped into logical kits with the associated Installation Instructions.
- Repairs are carried out by Endress+Hauser Service or by appropriately trained customers.
- Certified devices can only be converted to other certified devices by Endress+Hauser Service or at the factory.

14.1.2 Notes for repair and conversion

For repair and modification of a measuring device, observe the following notes:

- ▶ Use only original Endress+Hauser spare parts.
- ▶ Carry out the repair according to the Installation Instructions.
- ▶ Observe the applicable standards, federal/national regulations, Ex documentation (XA) and certificates.
- ▶ Document every repair and each conversion and enter them into the *W@M* life cycle management database.

14.2 Spare parts

W@M Device Viewer (www.endress.com/deviceviewer):

All the spare parts for the measuring device, along with the order code, are listed here and can be ordered. If available, users can also download the associated Installation Instructions.



Measuring device serial number:

- Is located on the nameplate of the device.
- Can be read out via the **Serial number** parameter (→  84) in the **Device information** submenu.

14.3 Endress+Hauser services

Endress+Hauser offers a wide range of services.



Your Endress+Hauser Sales Center can provide detailed information on the services.

14.4 Return

The measuring device must be returned if it is need of repair or a factory calibration, or if the wrong measuring device has been delivered or ordered. Legal specifications require Endress+Hauser, as an ISO-certified company, to follow certain procedures when handling products that are in contact with the medium.

To ensure safe, swift and professional device returns, please refer to the procedure and conditions for returning devices provided on the Endress+Hauser website at

<http://www.endress.com/support/return-material>

14.5 Disposal

14.5.1 Removing the measuring device

1. Switch off the device.

⚠ WARNING

Danger to persons from process conditions.

- ▶ Beware of hazardous process conditions such as pressure in the measuring device, high temperatures or aggressive fluids.

2. Carry out the mounting and connection steps from the "Mounting the measuring device" and "Connecting the measuring device" sections in reverse order. Observe the safety instructions.

14.5.2 Disposing of the measuring device

⚠ WARNING

Danger to personnel and environment from fluids that are hazardous to health.

- ▶ Ensure that the measuring device and all cavities are free of fluid residues that are hazardous to health or the environment, e.g. substances that have permeated into crevices or diffused through plastic.









Observe the following notes during disposal:

- ▶ Observe valid federal/national regulations.
- ▶ Ensure proper separation and reuse of the device components.



15 Accessories

Various accessories, which can be ordered with the device or subsequently from Endress+Hauser, are available for the device. Detailed information on the order code in question is available from your local Endress+Hauser sales center or on the product page of the Endress+Hauser website: www.endress.com.



15.1 Communication-specific accessories

Accessories	Description
Commubox FXA195 HART	For intrinsically safe HART communication with FieldCare via the USB interface.  Technical Information TI00404F
Commubox FXA291	Connects Endress+Hauser field devices with a CDI interface (= Endress+Hauser Common Data Interface) and the USB port of a computer or laptop.  Technical Information TI405C/07
HART Loop Converter HMX50	Is used to evaluate and convert dynamic HART process variables to analog current signals or limit values.  <ul style="list-style-type: none"> ▪ Technical Information TI00429F ▪ Operating Instructions BA00371F
Wireless HART adapter SWA70	Is used for the wireless connection of field devices. The WirelessHART adapter can be easily integrated into field devices and existing infrastructures, offers data protection and transmission safety and can be operated in parallel with other wireless networks with minimum cabling complexity.  Operating Instructions BA00061S
Fieldgate FXA320	Gateway for the remote monitoring of connected 4-20 mA measuring devices via a Web browser.  Technical Information TI00025S Operating Instructions BA00053S
Fieldgate FXA520	Gateway for the remote diagnostics and remote configuration of connected HART measuring devices via a Web browser.  Technical Information TI00025S Operating Instructions BA00051S
Field Xpert SFX350	Field Xpert SFX350 is a mobile computer for commissioning and maintenance. It enables efficient device configuration and diagnostics for HART devices and can be used in non-hazardous areas.  Operating Instructions BA01202S
Field Xpert SFX370	Field Xpert SFX370 is a mobile computer for commissioning and maintenance. It enables efficient device configuration and diagnostics for HART devices and can be used in the non-hazardous area and in the hazardous area.  Operating Instructions BA01202S

15.2 Service-specific accessories

Accessories	Description
Applicator	<p>Software for selecting and sizing Endress+Hauser measuring devices:</p> <ul style="list-style-type: none"> Choice of measuring devices for industrial requirements Calculation of all the necessary data for identifying the optimum flowmeter: e.g. nominal diameter, pressure loss, flow velocity and accuracy. Graphic illustration of the calculation results Determination of the partial order code, administration, documentation and access to all project-related data and parameters over the entire life cycle of a project. <p>Applicator is available:</p> <ul style="list-style-type: none"> Via the Internet: https://portal.endress.com/webapp/applicator As a downloadable DVD for local PC installation.
W@M	<p>W@M Life Cycle Management</p> <p>Improved productivity with information at your fingertips. Data relevant to a plant and its components is generated from the first stages of planning and during the asset's complete life cycle.</p> <p>W@M Life Cycle Management is an open and flexible information platform with online and on-site tools. Instant access for your staff to current, in-depth data shortens your plant's engineering time, speeds up procurement processes and increases plant uptime.</p> <p>Combined with the right services, W@M Life Cycle Management boosts productivity in every phase. For more information, visit www.endress.com/lifecyclemanagement</p>
FieldCare	<p>FDT-based plant asset management tool from Endress+Hauser.</p> <p>It can configure all smart field units in your system and helps you manage them. By using the status information, it is also a simple but effective way of checking their status and condition.</p> <p> Operating Instructions BA00027S and BA00059S</p>
DeviceCare	<p>Tool to connect and configure Endress+Hauser field devices.</p> <p> Innovation brochure IN01047S</p>

15.3 System components

Accessories	Description
Memograph M graphic data manager	<p>The Memograph M graphic data manager provides information on all the relevant measured variables. Measured values are recorded correctly, limit values are monitored and measuring points analyzed. The data are stored in the 256 MB internal memory and also on a SD card or USB stick.</p> <ul style="list-style-type: none">  Technical Information TI00133R  Operating Instructions BA00247R

16 Technical data

16.1 Application

Depending on the version ordered, the measuring device can also measure potentially explosive, flammable, poisonous and oxidizing media.

To ensure that the device remains in proper operating condition for its service life, use the measuring device only for media against which the process-wetted materials are sufficiently resistant.

16.2 Function and system design

Measuring principle	Proline Prosonic Flow uses a measurement method based on the transit time difference.
Measuring system	<p>The device consists of a transmitter and a sensor.</p> <p>The device is available as a compact version: The transmitter and sensor form a mechanical unit.</p> <p>For information on the structure of the device →  11</p>

16.3 Input

Measured variable	<p>Direct measured variables</p> <ul style="list-style-type: none"> ▪ Flow velocity ▪ Medium temperature ▪ Sound velocity <p>Calculated measured variables</p> <ul style="list-style-type: none"> ▪ Volume flow ▪ Mass flow
Measuring range	Typically $v = 0$ to 5 m/s (0 to 16.4 ft/s) with the specified accuracy

Flow characteristic values in SI units

Nominal diameter		Recommended flow min./max. full scale value	Factory settings		
[mm]	[in]		Full scale value current output [dm ³ /min]	Pulse value [dm ³ /pulse]	Low flow cut off ($v \sim 0.1$ m/s) [dm ³ /min]
50	2	0 to 720	720	3	14.4
65	2 ½	0 to 1200	1200	4	24.0
80	3	0 to 1680	1680	6	33.6
100	4	0 to 2880	2880	10	57.6
150	6	0 to 6360	6360	25	127.2

Flow characteristic values in US units

Nominal diameter		Recommended flow min./max. full scale value	Factory settings		
			Full scale value current output	Pulse value	Low flow cut off (v ~ 0.1 m/s)
[in]	[mm]	[gal/min]	[gal/min]	[gal/pulse]	[gal/min]
2	50	0 to 190	190	0.8	3.8
2 ½	65	0 to 317	317	1.1	6.3
3	80	0 to 444	444	1.6	8.9
4	100	0 to 761	761	2.6	15.2
6	150	0 to 1680	1680	6.6	33.6

Recommended measuring range

"Flow limit" section → 97

Operable flow range Over 200:1

16.4 Output

Output signal

Current output

Current output	4-20 mA HART (active)
Maximum output values	<ul style="list-style-type: none"> ▪ DC 24 V (no flow) ▪ 22.5 mA
Load	0 to 700 Ω
Resolution	0.38 µA
Damping	Adjustable: 0.07 to 999 s
Assignable measured variables	<ul style="list-style-type: none"> ▪ Volume flow ▪ Mass flow ▪ Temperature

Pulse/frequency/switch output

Function	Can be set to pulse, frequency or switch output
Version	Passive, open collector
Maximum input values	<ul style="list-style-type: none"> ▪ DC 30 V ▪ 25 mA
Voltage drop	For 25 mA: ≤ DC 2 V
Pulse output	
Pulse width	Adjustable: 0.05 to 2 000 ms
Maximum pulse rate	10 000 Impulse/s
Pulse value	Adjustable
Assignable measured variables	<ul style="list-style-type: none"> ▪ Volume flow ▪ Mass flow
Frequency output	
Output frequency	Adjustable: 0 to 10 000 Hz

Damping	Adjustable: 0 to 999 s
Pulse/pause ratio	1:1
Assignable measured variables	<ul style="list-style-type: none"> ▪ Volume flow ▪ Mass flow ▪ Temperature
Switch output	
Switching behavior	Binary, conductive or non-conductive
Switching delay	Adjustable: 0 to 100 s
Number of switching cycles	Unlimited
Assignable functions	<ul style="list-style-type: none"> ▪ Off ▪ On ▪ Diagnostic behavior ▪ Limit value <ul style="list-style-type: none"> - Volume flow - Mass flow - Temperature - Totalizer 1-3 ▪ Flow direction monitoring ▪ Status <ul style="list-style-type: none"> Low flow cut off

Signal on alarm

Depending on the interface, failure information is displayed as follows:

Current output 4 to 20 mA

4 to 20 mA

Failure mode	Choose from: <ul style="list-style-type: none"> ▪ 4 to 20 mA in accordance with NAMUR recommendation NE 43 ▪ 4 to 20 mA in accordance with US ▪ Min. value: 3.59 mA ▪ Max. value: 22.5 mA ▪ Freely definable value between: 3.59 to 22.5 mA ▪ Actual value ▪ Last valid value
---------------------	--

Pulse/frequency/switch output

Pulse output	
Failure mode	Choose from: <ul style="list-style-type: none"> ▪ Actual value ▪ No pulses
Frequency output	
Failure mode	Choose from: <ul style="list-style-type: none"> ▪ Actual value ▪ 0 Hz ▪ Defined value: 0 to 12 500 Hz
Switch output	
Failure mode	Choose from: <ul style="list-style-type: none"> ▪ Current status ▪ Open ▪ Closed

Local display

Plain text display	With information on cause and remedial measures
Backlight	Red backlighting indicates a device error.

 Status signal as per NAMUR recommendation NE 107

Interface/protocol

- Via digital communication:
HART protocol
- Via service interface
CDI-RJ45 service interface

Plain text display	With information on cause and remedial measures
--------------------	---

Web server

Plain text display	With information on cause and remedial measures
--------------------	---

Low flow cut off The switch points for low flow cut off are user-selectable.

Galvanic isolation The following connections are galvanically isolated from each other:

- Outputs
- Power supply

Protocol-specific data **Protocol-specific data**

- For information on the device description files
- For information on the dynamic variables and measured variables (HART device variables) →  39

16.5 Power supply

Terminal assignment →  22

Supply voltage The power unit must be tested to ensure it meets safety requirements (e.g. PELV, SELV).

Transmitter
DC 19.2 to 28.8 V

Power consumption

Transmitter

Order code for "Output"	Maximum Power consumption
Option B: 4-20 mA HART with pulse/frequency/switch output	3.0 W

Current consumption

Transmitter

Order code for "Output"	Maximum Current consumption	Maximum switch-on current
Option B: 4-20mA HART, pul./freq./switch output	200 mA	30 A (< 0.275 ms)

Power supply failure

Depending on the device version, the configuration is retained in the device memory or in the pluggable data memory (HistoROM DAT).

Electrical connection

→  23

Potential equalization

→  24

Terminals

Transmitter

Spring terminals for wire cross-sections 0.5 to 2.5 mm² (20 to 14 AWG)

Cable entries

- Cable gland: M20 × 1.5 with cable Ø 6 to 12 mm (0.24 to 0.47 in)
- Thread for cable entry:
 - M20
 - G ½"
 - NPT ½"

Cable specification

→  21

16.6 Performance characteristics

reference operating conditions

- Error limits following DIN EN 29104, in future ISO 20456
- Water with +15 to +45 °C (+59 to +113 °F) at 2 to 6 bar (29 to 87 psi)
- Data as indicated in the calibration protocol
- Accuracy based on accredited calibration rigs according to ISO 17025

Maximum measured error

Error limits under reference operating conditions

o.r. = of reading; o.f.s. = of full scale value

Volume flow

- $v > 0.5$ m/s (1.64 ft/s): ±0.5 % o.r. ±0.02 % o.f.s.
- $v \leq 0.5$ m/s (1.64 ft/s): ±0.07 % o.f.s.
- of full scale value: 5 m/s (16.4 ft/s)



- Fluctuations in the supply voltage do not have any effect within the specified range.
- Temperature accuracy: ±2 °C (±3.8 °F)

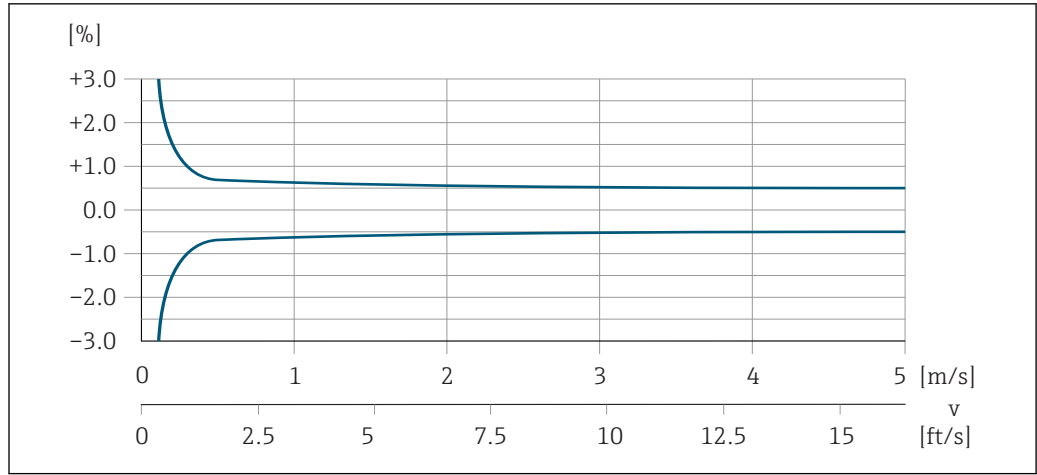

14 Maximum measured error in % o.r.

Repeatability

o.r. = of reading

Volume flow

±0.1 % o.r.

Influence of ambient temperature

Current output

o.r. = of reading

Temperature coefficient	Max. ±0.005 % o.r./°C
-------------------------	-----------------------

Pulse/frequency output

Temperature coefficient	No additional effect. Included in accuracy.
-------------------------	---

16.7 Installation

"Mounting requirements" → 16

16.8 Environment

Ambient temperature range

Transmitter	-25 to +60 °C (-13 to +140 °F)
Local display	-20 to +60 °C (-4 to +140 °F), the readability of the display may be impaired at temperatures outside the temperature range.
Sensor	-25 to +60 °C (-13 to +140 °F)



- ▶ If operating outdoors:
Avoid direct sunlight, particularly in warm climatic regions.

Storage temperature

All components apart from display modules:
-50 to +80 °C (-58 to +176 °F), preferably at +20 °C (+68 °F)

Degree of protection	Transmitter and sensor <ul style="list-style-type: none"> ■ As standard: IP66/67, type 4X enclosure ■ When housing is open: IP20, type 1 enclosure
Shock resistance	Shock due to rough handling following IEC 60068-2-31
Vibration resistance	<ul style="list-style-type: none"> ■ Oscillation, sinusoidal, following IEC 60068-2-6 <ul style="list-style-type: none"> - 2 to 8.4 Hz, 3.5 mm peak - 8.4 to 500 Hz, 1 g peak ■ Oscillation, broadband noise following IEC 60068-2-64 <ul style="list-style-type: none"> - 10 to 200 Hz, 0.003 g²/Hz - 200 to 2 000 Hz, 0.001 g²/Hz - Total: 1.54 g rms
Electromagnetic compatibility (EMC)	<ul style="list-style-type: none"> ■ As per IEC/EN 61326-1, IEC/EN 61326-2-3 and NAMUR Recommendation 21 (NE 21) ■ Complies with emission limits for industry as per EN 55011 (Class A) <p> Details are provided in the Declaration of Conformity.</p>

16.9 Process

Medium temperature range	Sensor +0 to +150 °C (+32 to +302 °F)
Pressure-temperature ratings	 An overview of the pressure-temperature ratings for the process connections is provided in the "Technical Information" document
Flow limit	Select the nominal diameter by optimizing between the required flow range and permissible pressure loss. <p> For an overview of the full scale values for the measuring range, see the "Measuring range" section →  91</p> <ul style="list-style-type: none"> ■ The minimum recommended full scale value is approx. 1/20 of the maximum full scale value. ■ In most applications, 10 to 50 % of the maximum full scale value can be considered ideal.

Pressure loss

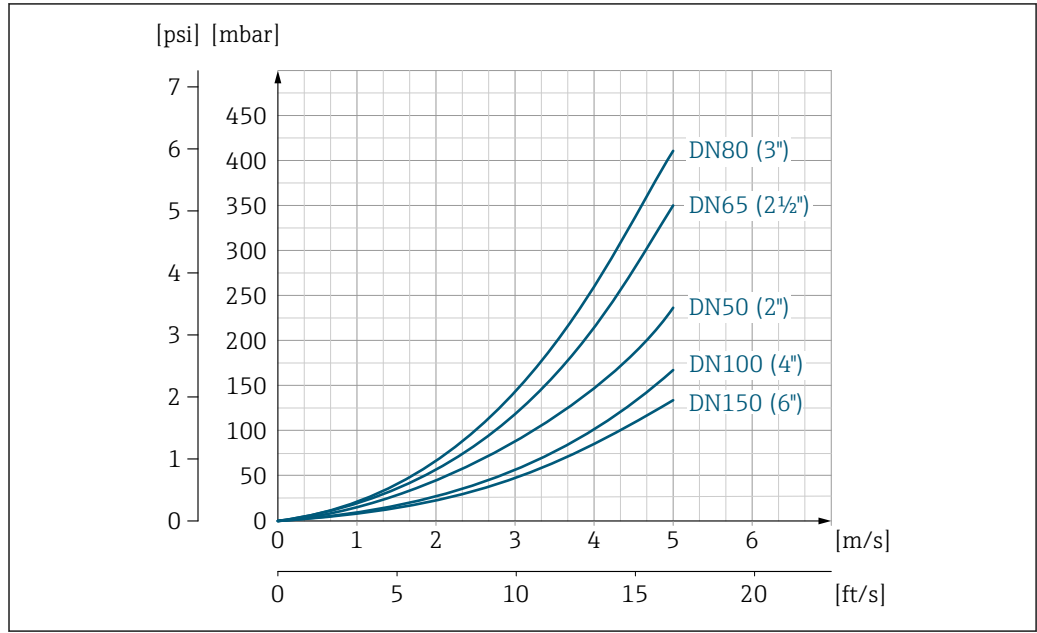

15 Pressure loss DN 50 to 150 (2 to 6")

A0033770-EN

To calculate the pressure loss, use the *Applicator* sizing tool → 90

System pressure

It is important that cavitation does not occur, or that gases entrained in the liquids do not outgas.

Cavitation is caused if the pressure drops below the vapor pressure:
In suction lines

- Ensure the system pressure is sufficiently high to prevent cavitation and outgassing.

For this reason, the following mounting locations are recommended:

- At the lowest point in a vertical pipe
- Downstream from pumps (no danger of vacuum)

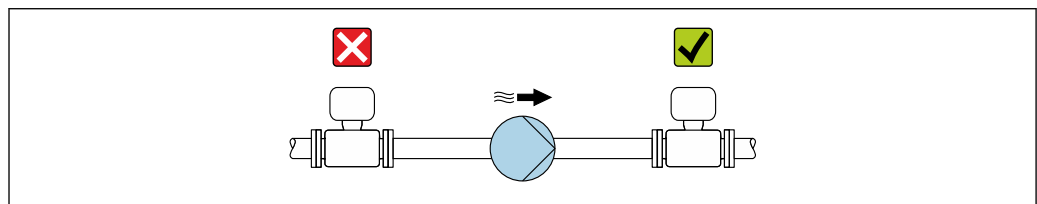

A0028777

Thermal insulation

In the case of some fluids, it is important to keep the heat radiated from the sensor to the transmitter to a low level. A wide range of materials can be used for the required insulation.

NOTICE

Electronics overheating on account of thermal insulation!

- Observe maximum permitted insulation height of the transmitter neck so that the transmitter head is completely free.

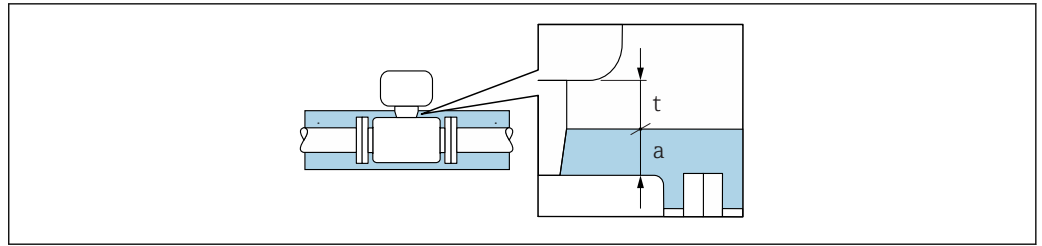

A0034104

- t* Maximum insulation thickness 2 cm (0.79 in)
a Minimum distance from transmitter to insulation

16.10 Mechanical construction

Design, dimensions



For the dimensions and installation lengths of the device, see the "Technical Information" document, "Mechanical construction" section.

Weight

Weight in SI units

Compact version

Order code for "Housing", option A "Compact, aluminum, coated"

Nominal diameter [mm]	Version	Fixed flange		Lap joint flange		Lap joint flange, stamped plate
		EN 1092-1 (DIN 2501) ¹⁾ [kg]	ASME B16.5 ²⁾ [kg]	EN 1092-1 (DIN 2501) ³⁾ [kg]	ASME B16.5 ²⁾ [kg]	EN 1092-1 (DIN 2501) ⁴⁾ [kg]
50	Single-path	9.15	8.00	8.90	8.10	7.20
65	Single-path	10.8	–	10.7	–	8.10
80	Single-path	12.2	12.8	12.2	12.9	8.80
100	Two-path	16.1	18.1	16.0	17.9	11.2
150	Two-path	25.4	26.4	22.0	26.2	17.5

- 1) Pressure rating PN 40 (DN 50), PN 16 (DN 65 to 150)
 2) Pressure rating, class 150
 3) Pressure rating PN 10/16
 4) Pressure rating PN 10

Weight in US units

Compact version

Order code for "Housing", option A "Compact, aluminum, coated"

Nominal diameter [in]	Version	Fixed flange ASME B16.5 ¹⁾ [lbs]	Lap joint flange ASME B16.5 ¹⁾ [lbs]
2	Single-path	17.6	17.9
3	Single-path	28.2	28.5
4	Two-path	39.9	39.5
6	Two-path	58.2	57.7

- 1) Pressure rating, class 150

Materials

Transmitter housing

- Order code for "Housing", option **A** "Compact, aluminum coated":
Aluminum, AlSi10Mg, coated
- Window material for optional local display (→  101):
Order code for "Display; Operation", option **B**: glass

Cable entries/cable glands

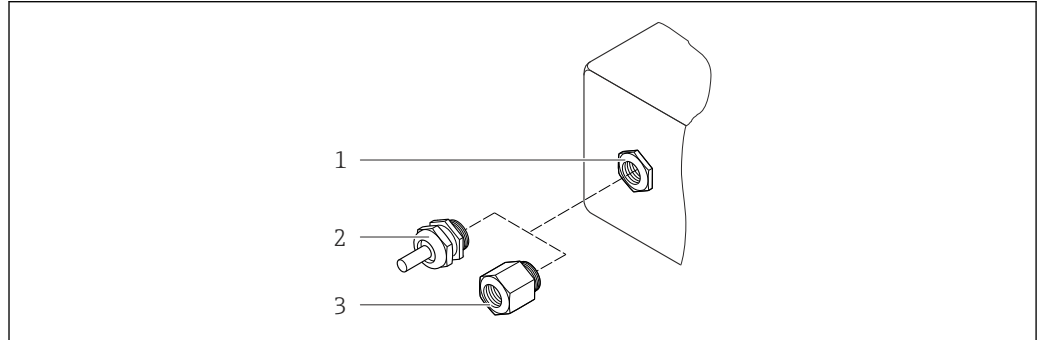

A0020640

 16 Possible cable entries/cable glands

- 1 Female thread M20 × 1.5
- 2 Cable gland M20 × 1.5
- 3 Adapter for cable entry with internal thread G ½" or NPT ½"

Order code for "Housing", option A "Compact, aluminum, coated"

Cable entry/cable gland	Material
Cable gland M20 × 1.5	Nickel-plated brass
Adapter for cable entry with internal thread G ½"	
Adapter for cable entry with internal thread NPT ½"	

Sensor housing

- Stainless steel (cold worked):
- 1.4404 (316L)
 - 1.4435 (316L)

Process connections

- Stainless steel:
 - 1.4301 (304)
 - 1.4306 (304L)
 - 1.4404 (316L)
 - 1.4571 (316Ti)
- Steel S235JR (1.0038)
- Carbon steel A105

 List of all available process connections →  100

Process connections

- Flanges:
- EN 1092-1 (DIN 2501)
 - ASME B16.5

 For information on the different materials used in the process connections →  100

16.11 Operability

Local display

The local display is only available with the following device order code:
Order code for "Display; operation", option **B**: 4-line; illuminated, via communication

Display element

- 4-line liquid crystal display with 16 characters per line.
- White background lighting; switches to red in event of device errors.
- Format for displaying measured variables and status variables can be individually configured.
- Permitted ambient temperature for the display: -20 to $+60$ °C (-4 to $+140$ °F). The readability of the display may be impaired at temperatures outside the temperature range.

Disconnecting the local display from the main electronics module

 In the case of the "Compact, aluminum coated" housing version, the local display must only be disconnected manually from the main electronics module. In the case of the "Compact, hygienic, stainless" and "Ultra-compact, hygienic, stainless" housing versions, the local display is integrated in the housing cover and is disconnected from the main electronics module when the housing cover is opened.

"Compact, aluminum coated" housing version

The local display is plugged onto the main electronics module. The electronic connection between the local display and main electronics module is established via a connecting cable.

For some work performed on the measuring device (e.g. electrical connection), it is advisable to disconnect the local display from the main electronics module:

1. Press in the side latches of the local display.
2. Remove the local display from the main electronics module. Pay attention to the length of the connecting cable when doing so.

Once the work is completed, plug the local display back on.

Remote operation

Via HART protocol

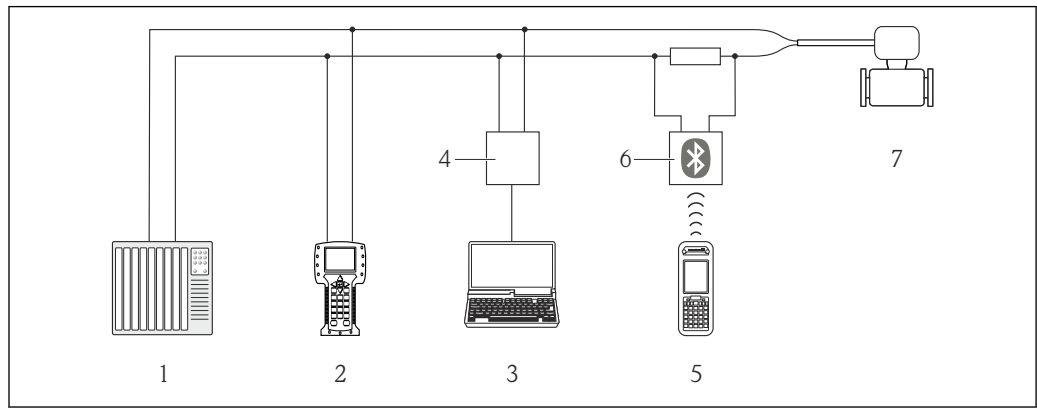

A0016948

17 Options for remote operation via HART protocol

- 1 Control system (e.g. PLC)
- 2 Field Communicator 475
- 3 Computer with operating tool (e.g. FieldCare, AMS Device Manager, SIMATIC PDM)
- 4 Commubox FXA195 (USB)
- 5 Field Xpert SFX350 or SFX370
- 6 VIATOR Bluetooth modem with connecting cable
- 7 Transmitter

Service interface

Via service interface (CDI-RJ45)

HART

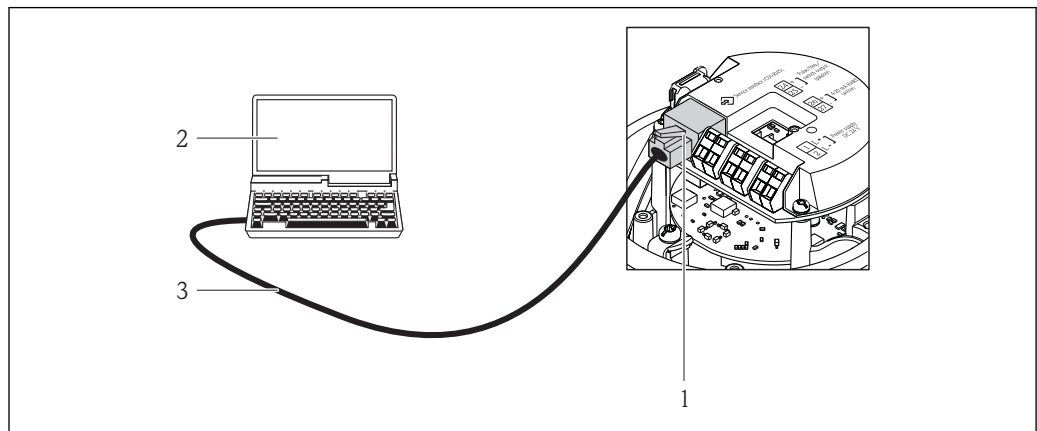

A0016926

18 Connection for the order code for "Output", option B: 4-20 mA HART, pulse/frequency/switch output

- 1 Service interface (CDI -RJ45) of the measuring device with access to the integrated Web server
- 2 Computer with Web browser (e.g. Internet Explorer) for accessing the integrated device Web server or with "FieldCare" operating tool with COM DTM "CDI Communication TCP/IP"
- 3 Standard Ethernet connecting cable with RJ45 plug

Languages

Can be operated in the following languages:

- Via "FieldCare" operating tool: English, German, French, Spanish, Italian, Chinese, Japanese
- Via Web browser: English, German, French, Spanish, Italian, Dutch, Portuguese, Polish, Russian, Turkish, Chinese, Japanese, Bahasa (Indonesian), Vietnamese, Czech, Swedish, Korean

16.12 Certificates and approvals

CE mark	<p>The measuring system is in conformity with the statutory requirements of the applicable EU Directives. These are listed in the corresponding EU Declaration of Conformity along with the standards applied.</p> <p>Endress+Hauser confirms successful testing of the device by affixing to it the CE mark.</p>
C-Tick symbol	<p>The measuring system meets the EMC requirements of the "Australian Communications and Media Authority (ACMA)".</p>
HART certification	<p>HART interface</p> <p>The measuring device is certified and registered by the FieldComm Group. The measuring system meets all the requirements of the following specifications:</p> <ul style="list-style-type: none"> ■ Certified according to HART 7.5 ■ The device can also be operated with certified devices of other manufacturers (interoperability)
Pressure Equipment Directive	<ul style="list-style-type: none"> ■ With the identification PED/G1/x (x = category) on the sensor nameplate, Endress+Hauser confirms conformity with the "Essential Safety Requirements" specified in Appendix I of the Pressure Equipment Directive 2014/68/EC. ■ Devices not bearing this marking (PED) are designed and manufactured according to good engineering practice. They meet the requirements of Art. 4, Par. 3 of the Pressure Equipment Directive 2014/68/EU. The range of application is indicated in tables 6 to 9 in Annex II of the Pressure Equipment Directive 2014/68/EC.
Other standards and guidelines	<ul style="list-style-type: none"> ■ EN 60529 Degrees of protection provided by enclosures (IP code) ■ EN 61010-1 Safety requirements for electrical equipment for measurement, control and laboratory use - general requirements ■ IEC/EN 61326 Emission in accordance with Class A requirements. Electromagnetic compatibility (EMC requirements). ■ NAMUR NE 21 Electromagnetic compatibility (EMC) of industrial process and laboratory control equipment ■ NAMUR NE 32 Data retention in the event of a power failure in field and control instruments with microprocessors ■ NAMUR NE 43 Standardization of the signal level for the breakdown information of digital transmitters with analog output signal. ■ NAMUR NE 53 Software of field devices and signal-processing devices with digital electronics ■ NAMUR NE 80 The application of the pressure equipment directive to process control devices ■ NAMUR NE 105 Specifications for integrating fieldbus devices in engineering tools for field devices ■ NAMUR NE 107 Self-monitoring and diagnosis of field devices ■ NAMUR NE 131 Requirements for field devices for standard applications

16.13 Application packages



Many different application packages are available to enhance the functionality of the device. Such packages might be needed to address safety aspects or specific application requirements.

The application packages can be ordered with the device or subsequently from Endress+Hauser. Detailed information on the order code in question is available from your local Endress+Hauser sales center or on the product page of the Endress+Hauser website: www.endress.com.

Heartbeat Technology

Package	Description
Heartbeat Verification +Monitoring	<p>Heartbeat Verification Meets the requirement for traceable verification to DIN ISO 9001:2008 Chapter 7.6 a) "Control of monitoring and measuring equipment".</p> <ul style="list-style-type: none"> Functional testing in the installed state without interrupting the process. Traceable verification results on request, including a report. Simple testing process via local operation or other operating interfaces. Clear measuring point assessment (pass/fail) with high test coverage within the framework of manufacturer specifications. Extension of calibration intervals according to operator's risk assessment. <p>Heartbeat Monitoring Continuously supplies data, which are characteristic of the measuring principle, to an external condition monitoring system for the purpose of preventive maintenance or process analysis. These data enable the operator to:</p> <ul style="list-style-type: none"> Draw conclusions - using these data and other information - about the impact the measuring application has on the measuring performance over time. Schedule servicing in time. Monitor the process or product quality, e.g. gas pockets.

16.14 Accessories

 Overview of accessories available for order →  89

16.15 Supplementary documentation

 For an overview of the scope of the associated Technical Documentation, refer to the following:

- The *W@M Device Viewer* : Enter the serial number from the nameplate (www.endress.com/deviceviewer)
- The *Endress+Hauser Operations App*: Enter the serial number from the nameplate or scan the 2-D matrix code (QR code) on the nameplate.

Standard documentation

Brief Operating Instructions

Brief Operating Instructions for the sensor

Measuring device	Documentation code
Proline Prosonic Flow E	KA01329D

Brief Operating Instructions for transmitter

Measuring device	Documentation code
Proline 100	HART KA01330D

Technical Information

Measuring device	Documentation code
Prosonic Flow E 100	TI01345D

Description of Device Parameters



Measuring device	Documentation code
Prosonic Flow 100	GP01124D

Supplementary device-
dependent documentation**Special documentation**

Contents	Documentation code
Information on the Pressure Equipment Directive	SD01614D
RFID TAG	SD01565D

Contents	Documentation code
Heartbeat Technology	SD02079D

Installation Instructions

Contents	Comment
Installation instructions for spare part sets and accessories	<ul style="list-style-type: none"> ▪ Access the overview of all the available spare part sets via <i>W@MDevice Viewer</i> →  87 ▪ Accessories available for order with Installation Instructions →  89

Index

A

Adapting the diagnostic behavior	76
Adapting the status signal	77
Ambient temperature	
Influence	96
Ambient temperature range	18, 96
AMS Device Manager	38
Function	38
Application	91
Application packages	104
Applicator	91
Approvals	103

B

Burst Mode	40
----------------------	----

C

C-Tick symbol	103
Cable entries	
Technical data	95
Cable entry	
Degree of protection	26
CE mark	9, 103
Certificates	103
Check	
Post-mounting	20
Checklist	
Post-connection check	26
Post-mounting check	20
Cleaning	
Exterior cleaning	86
Commissioning	43
Advanced settings	57
Configuring the measuring device	43
Communication-specific data	39
Connecting cable	21
Connecting the measuring device	23
Connection	
see Electrical connection	
Connection preparations	22
Connection tools	21
Current consumption	95

D

Declaration of Conformity	9
Degree of protection	26, 97
Design	
Measuring device	11
Designated use	8
Device components	11
Device description files	39
Device documentation	
Supplementary documentation	7
Device locking, status	67
Device name	
Sensor	14

Transmitter	13
Device repair	87
Device revision	39
Device type ID	39
DeviceCare	38
Device description file	39
Diagnostic information	
Design, description	74, 76
DeviceCare	75
FieldCare	75
Light emitting diodes	73
Overview	77
Remedial measures	77
Web browser	74
Diagnostic list	81
DIP switches	
see Write protection switch	
Disabling write protection	65
Display values	
For locking status	67
Disposal	88
Document	
Function	5
Symbols used	5
Document function	5

E

Electrical connection	
Commubox FXA195 (USB)	35, 102
Commubox FXA291	35
Degree of protection	26
Field Communicator 475	35, 102
Field Xpert SFX350/SFX370	35, 102
Measuring device	21
Operating tool (e.g. FieldCare, AMS Device Manager, SIMATIC PDM)	35, 102
Operating tools	
Via HART protocol	35, 102
Via service interface (CDI-RJ45)	35, 102
Via service interface (CDI)	35
VIATOR Bluetooth modem	35, 102
Web server	35, 102
Electromagnetic compatibility	97
Enabling write protection	65
Endress+Hauser services	
Maintenance	86
Repair	87
Environment	
Shock resistance	97
Storage temperature	96
Vibration resistance	97
Error messages	
see Diagnostic messages	
Event list	81
Event logbook	81

- Extended order code
 - Sensor 14
 - Transmitter 13
- Exterior cleaning 86
- F**
- Field Communicator
 - Function 38
- Field Communicator 475 38
- Field of application
 - Residual risks 9
- Field Xpert
 - Function 36
- Field Xpert SFX350 36
- FieldCare 36
 - Device description file 39
 - Establishing a connection 37
 - Function 36
 - User interface 37
- Filtering the event logbook 82
- Firmware
 - Release date 39
 - Version 39
- Firmware history 85
- Flow direction 17, 19
- Flow limit 97
- Function check 43
- Function range
 - Field Xpert 36
- Function scope
 - AMS Device Manager 38
 - Field Communicator 38
 - Field Communicator 475 38
 - SIMATIC PDM 38
- Functions
 - see Parameter
- G**
- Galvanic isolation 94
- H**
- Hardware write protection 66
- HART certification 103
- HART protocol
 - Device variables 39
 - Measured variables 39
 - Revision 39
- HistoROM 58
- I**
- I/O electronics module 11, 23
- Identifying the measuring device 12
- Incoming acceptance 12
- Influence
 - Ambient temperature 96
- Information on the document 5
- Inlet runs 17
- Input 91
- Inspection
 - Received goods 12
- Inspection check
 - Connection 26
- Installation 16
- Installation conditions
 - Inlet and outlet runs 17
 - Installation dimensions 18
 - Mounting location 16
 - Orientation 17
 - System pressure 18, 98
 - Thermal insulation 18, 98
- Installation dimensions 18
- L**
- Languages, operation options 102
- Low flow cut off 94
- M**
- Main electronics module 11
- Maintenance 86
- Maintenance tasks 86
- Managing the device configuration 58
- Manufacturer ID 39
- Manufacturing date 13, 14
- Materials 100
- Maximum measured error 95
- Measured values
 - Calculated 91
 - Direct 91
 - see Process variables
- Measuring and test equipment 86
- Measuring device
 - Configuration 43
 - Conversion 87
 - Design 11
 - Disposal 88
 - Integrating via HART protocol 39
 - Mounting the sensor 19
 - Preparing for electrical connection 22
 - Preparing for mounting 19
 - Removing 88
 - Repairs 87
 - Switch-on 43
- Measuring principle 91
- Measuring range 91
- Measuring range, recommended 97
- Measuring system 91
- Menu
 - Diagnostics 80
 - Operation 67
 - Setup 43
- Menus
 - For measuring device configuration 43
 - For specific settings 57
- Mounting dimensions
 - see Installation dimensions
- Mounting location 16
- Mounting preparations 19
- Mounting tools 19

N

Nameplate	
Sensor	14
Transmitter	13

O

Operable flow range	92
Operating menu	
Menus, submenus	28
Structure	28
Submenus and user roles	29
Operating philosophy	29
Operation	67
Operation options	27
Operational safety	9
Order code	12, 13, 14
Orientation (vertical, horizontal)	17
Outlet runs	17
Output	92
Output signal	92

P

Packaging disposal	16
Parameter settings	
Administration (Submenu)	62
Advanced setup (Submenu)	57
Burst configuration 1 to n (Submenu)	40
Configuration backup display (Submenu)	58
Current output 1 (Submenu)	46
Device information (Submenu)	83
Diagnostics (Menu)	80
Display (Submenu)	60
Low flow cut off (Submenu)	56
Output conditioning (Wizard)	54
Output values (Submenu)	69
Process variables (Submenu)	67
Pulse/frequency/switch output 1 (Submenu)	49, 52
Sensor adjustment (Submenu)	57
Setup (Menu)	43
Simulation (Submenu)	63
System units (Submenu)	44
System values (Submenu)	68
Totalizer (Submenu)	69
Totalizer 1 to n (Submenu)	58
Totalizer handling (Submenu)	70
Web server (Submenu)	34
Performance characteristics	95
Post-connection check (checklist)	26
Post-installation check	43
Post-mounting check (checklist)	20
Potential equalization	24
Power consumption	94
Power supply failure	95
Pressure Equipment Directive	103
Pressure loss	98
Pressure-temperature ratings	97
Process connections	100
Product safety	9
Protecting parameter settings	65

R

Reading measured values	67
Recalibration	86
reference operating conditions	95
Registered trademarks	7
Remote operation	102
Repair of a device	87
Repairs	87
Notes	87
Repeatability	96
Replacement	
Device components	87
Requirements for personnel	8
Return	87

S

Safety	8
Sensor	
Medium temperature range	97
Mounting	19
Serial number	13, 14
Setting the operating language	43
Settings	
Adapting the measuring device to the process conditions	70
Administration	62
Advanced display configurations	60
Current output	46
Device reset	83
Device tag	43
Low flow cut off	56
Managing the device configuration	58
Operating language	43
Output conditioning	54
Pulse output	49
Pulse/frequency/switch output	47, 49
Resetting the totalizer	70
Sensor adjustment	57
Simulation	63
Switch output	52
System units	44
Totalizer	58
Totalizer reset	70
Shock resistance	97
Signal on alarm	93
SIMATIC PDM	38
Function	38
Software release	39
Spare part	87
Spare parts	87
Special connection instructions	25
Standards and guidelines	103
Status signals	74
Storage conditions	15
Storage temperature	15
Storage temperature range	96
Structure	
Operating menu	28

Submenu	
Administration	62
Advanced setup	57
Burst configuration 1 to n	40
Configuration backup display	58
Current output 1	46
Device information	83
Display	60
Event list	81
Low flow cut off	56
Output values	69
Overview	29
Process variables	67
Pulse/frequency/switch output 1	47, 49, 52
Sensor adjustment	57
Simulation	63
System units	44
System values	68
Totalizer	69
Totalizer 1 to n	58
Totalizer handling	70
Web server	34
Supplementary documentation	104
Supply voltage	94
System design	
Measuring system	91
see Measuring device design	
System integration	39
System pressure	18, 98
T	
Technical data, overview	91
Temperature range	
Ambient temperature	18, 96
Medium temperature	97
Storage temperature	15
Terminal assignment	22, 23
Terminals	95
Thermal insulation	18, 98
Tools	
Electrical connection	21
For mounting	19
Transport	15
Transmitter	
Connecting the signal cables	23
Turning the display module	20
Transporting the measuring device	15
Troubleshooting	
General	72
Turning the display module	20
U	
Use of the measuring device	
Borderline cases	8
Incorrect use	8
see Designated use	
User interface	
Current diagnostic event	80
Previous diagnostic event	80
User roles	29
V	
Version data for the device	39
Vibration resistance	97
W	
W@M	86, 87
W@M Device Viewer	12, 87
Weight	
SI units	99
Transport (notes)	15
US units	99
Wizard	
Low flow cut off	56
Output conditioning	54
Workplace safety	9
Write protection	
Via write protection switch	66
Write protection switch	66

www.addresses.endress.com
