

Operating Instructions

Field Xpert SMT50

Universal, high-performance tablet PC for device configuration



Revision history

Product version	Operating Instructions	Changes	Comments
1.05.xx	BA02053S/04/EN/ 01.20	-	-

Table of contents

1	About this document	4	8.3	Information and software settings	28
1.1	Document function	4	8.4	Additional information about the software	33
1.2	Symbols	4	8.5	Fieldgate PAM SFG600 HART via PROFINET	35
1.3	Acronyms used	6	8.6	Automatic DTM update	37
1.4	Documentation	7	8.7	Netilion Library	38
1.5	Registered trademarks	7	8.8	Scanner App	42
2	Basic safety instructions	7	8.9	Uploading a Heartbeat Verification report to the Netilion Library	43
2.1	Requirements for the personnel	7	8.10	RFID	45
2.2	Designated use	8	9	Maintenance	46
2.3	Workplace safety	8	9.1	Replacing the battery	46
2.4	Operational safety	8	10	Repair	47
2.5	Product safety	8	10.1	General notes	47
2.6	IT security	9	10.2	Spare parts	47
3	Product description	9	10.3	Return	47
3.1	Product design	12	10.4	Disposal	47
3.2	Application	12	11	Accessories	49
3.3	License model	12	12	Technical data	49
4	Incoming acceptance and product identification	14			
4.1	Incoming acceptance	14			
4.2	Product identification	14			
4.3	Storage and transport	15			
5	Installation	15			
5.1	System requirements	15			
5.2	Installing the software	15			
5.3	Updating the software	15			
5.4	Removing the software	16			
6	Operation	16			
6.1	Shutting down the tablet PC	16			
6.2	Switching off the tablet PC	17			
6.3	Security screen	17			
7	Commissioning	17			
7.1	Inserting the battery	18			
7.2	Charging the battery	19			
7.3	Switching on the tablet PC	19			
7.4	Connecting the AC adapter	19			
8	Operation	19			
8.1	How to start	20			
8.2	Establishing a connection to the device	20			

1 About this document

1.1 Document function

These Operating Instructions contain all the information that is required in various phases of the life cycle of the device: from product identification, incoming acceptance and storage, to mounting, connection, operation and commissioning through to troubleshooting, maintenance and disposal.

1.2 Symbols

1.2.1 Safety symbols

DANGER

This symbol alerts you to a dangerous situation. Failure to avoid this situation will result in serious or fatal injury.

WARNING

This symbol alerts you to a dangerous situation. Failure to avoid this situation can result in serious or fatal injury.







CAUTION





This symbol alerts you to a dangerous situation. Failure to avoid this situation can result in minor or medium injury.

NOTICE



This symbol contains information on procedures and other facts which do not result in personal injury.

















1.2.2 Symbols for certain types of information

Symbol	Meaning
	Permitted Procedures, processes or actions that are permitted.
	Preferred Procedures, processes or actions that are preferred.
	Forbidden Procedures, processes or actions that are forbidden.
	Tip Indicates additional information.
	Reference to documentation.
	Reference to page.
	Reference to graphic.

Symbol	Meaning
	Notice or individual step to be observed.
	Series of steps.
	Result of a step.
	Help in the event of a problem.
	Visual inspection.

1.2.3 Field Xpert icons

Symbol	Meaning
	Switch tablet on and off.
	Windows button
	Wireless communication (WLAN, WWAN, GPS, Bluetooth)
	Battery
	Scanner App
	Open the home screen of the device configuration software.
	Jump back to the last page opened.
	Information and software settings.
	Additional information about the software.
	Minimize the program.
	Enable full screen.
	Disable full screen.
	Close the program.
	Scroll up

Symbol	Meaning
	Scroll down
	Updating
	Expand information.
	Collapse information.
	Connect automatically
	Connect with wizard (manual connection)
	Connect with Endress+Hauser WLAN and Bluetooth devices
	RFID
	Cloud
	Favorites
	Keypad
	Camera
	Link to Netilion Library
	Attach photos and PDFs to an asset in Netilion Library
	Start
	Trash

1.3 Acronyms used

Acronyms	Explanation
DFS	Dynamic Frequency Selection
FCC	Federal Communications Commission
HF	High frequency [RF = radio frequency]

Acronyms	Explanation
SD	Secure Digital
WWAN	Wireless Wide Area Network

1.4 Documentation

Field Xpert SMT50

Technical Information TI01555S/04/EN

1.5 Registered trademarks

Windows 10 IoT Enterprise® is a registered trademark of Microsoft Corporation, Redmond, Washington, USA.

Intel® Core™ is a registered trademark of Intel Corporation, Santa Clara, USA.

FOUNDATION™ Fieldbus is the trademark of the FieldComm Group, Austin, TX 78759, USA.

HART®, WirelessHART® is the registered trademark of the FieldComm Group, Austin, TX 78759, USA.

PROFIBUS® is a registered trademark of the PROFIBUS User Organization, Karlsruhe/Germany.

Modbus is the registered trademark of Modicon, Incorporated.

IO-Link® is a registered trademark of the IO-Link Community c/o PROFIBUS User Organization, (PNO) Karlsruhe/Germany - www.io-link.com

All other brand and product names are trademarks or registered trademarks of the companies and organizations in question.

2 Basic safety instructions



The Operating Instructions supplied with the device and containing the safety instructions of the tablet PC manufacturer must be observed.

2.1 Requirements for the personnel

The personnel for installation, commissioning, diagnostics and maintenance must fulfill the following requirements:

- ▶ Trained, qualified specialists must have a relevant qualification for this specific function and task.
- ▶ Are authorized by the plant owner/operator.
- ▶ Are familiar with federal/national regulations.
- ▶ Before starting work, read and understand the instructions in the manual and supplementary documentation as well as the certificates (depending on the application).
- ▶ Follow instructions and comply with basic conditions.

The operating personnel must fulfill the following requirements:

- ▶ Are instructed and authorized according to the requirements of the task by the facility's owner-operator.
- ▶ Follow the instructions in this manual.

2.2 Designated use

The tablet PC for device configuration enables mobile plant asset management. It is suitable for commissioning and maintenance staff to manage field instruments with a digital communication interface and to record progress. This tablet PC is designed as a complete solution and is an easy-to-use, touch-enabled tool which can be used to manage field instruments during their entire life cycle. It provides extensive, pre-installed driver libraries and offers access to the "Industrial Internet of Things" as well as to information and documentation during the entire life cycle of the device. The tablet PC offers a modern software user interface and the option of online updates based on a secure Microsoft Windows 10 multi-functional environment.

2.3 Workplace safety

The tablet PC is used for device configuration. Incorrect configurations may lead to unwanted or hazardous situations in a plant. The device configuration software is already installed on the tablet PC upon delivery. These Operating Instructions describe how to commission and operate the tablet PC.



- Commissioning
- Operation

2.4 Operational safety

Risk of injury!

- ▶ Operate the device in proper technical condition and fail-safe condition only.
- ▶ The operator is responsible for interference-free operation of the device.

Modifications to the device

Unauthorized modifications to the device are not permitted and can lead to unforeseeable dangers:

- ▶ If, despite this, modifications are required, consult with Endress+Hauser.

Repair

To ensure continued operational safety and reliability:

- ▶ Carry out repairs on the device only if they are expressly permitted.
- ▶ Observe federal/national regulations pertaining to repair of an electrical device.
- ▶ Use only original spare parts and accessories from the manufacturer.

2.5 Product safety

The tablet PC is designed in accordance with good engineering practice to meet state-of-the-art safety requirements, has been tested, and left the factory in a condition in which it is safe to operate.

It fulfills general safety requirements and legal requirements. It also conforms to the EC directives listed in the device-specific EC Declaration of Conformity. The manufacturer confirms this by affixing the CE mark to the device.

2.6 IT security

Our warranty is valid only if the device is installed and used as described in the Operating Instructions. The device is equipped with security mechanisms to protect it against any inadvertent changes to the settings.

IT security measures, which provide additional protection for the device and associated data transfer, must be implemented by the operators themselves in line with their security standards.

3 Product description

With an ultra-compact form factor, the tablet PC meets the most demanding requirements, such as ingress protection (IP65) and shock resistance (MIL-STD 810G). The additional screen protector offers complete protection in harsh working environments. The tablet PC's good ergonomic features also protect workers' health, keeping physical strain to a minimum.

With the increasing popularity of 4G/LTE connectivity, the tablet PC ensures swift and seamless access to data. However, in situations where not even WLAN is available, the optional docking station with an Ethernet interface gives the tablet PC the necessary flexibility to link into existing network infrastructures. In addition, the latest Bluetooth standards are also supported.

After use in the field, the tablet PC can be used as an office PC with the optional office docking station, allowing the tablet to be seamlessly integrated into the office and business networks.

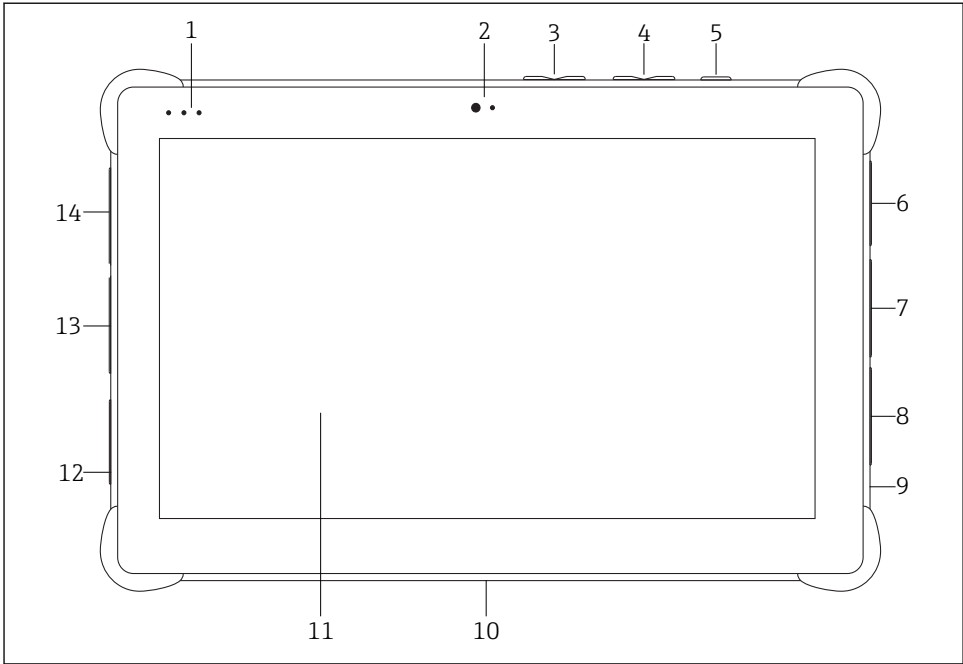

1 Front view of tablet PC

- 1 Status LEDs: (power/charge indicator/WLAN)
- 2 Front camera
- 3 Programmable buttons P1/P2
- 4 Volume buttons
- 5 On/off button
- 6 USB 2.0
- 7 DB-9 serial COM 2: RS-485 fixed (Pin1: D+/Pin2: D-/Pin5: GND)
- 8 DB-9 serial COM 1: RS-232 fixed (Standard)
- 9 Slot for Kensington lock
- 10 Dock connector
- 11 Corning® Gorilla® Glass
- 12 LAN/DC socket
- 13 USB 3.0/USB 2.0
- 14 Audio out 3.5mm/USB type C/mini HDMI

Component	Description
Programmable buttons	Go to user-defined program
Front camera	For video recordings (e.g. at video conferences)
DC socket	For connecting the power adapter
Dock connector	For connecting the tablet PC to a docking station
Slot for Kensington lock	For connecting a Kensington-compatible security lock

Component	Description
Volume buttons	For setting the volume
On/off button	For switching the tablet PC on or off

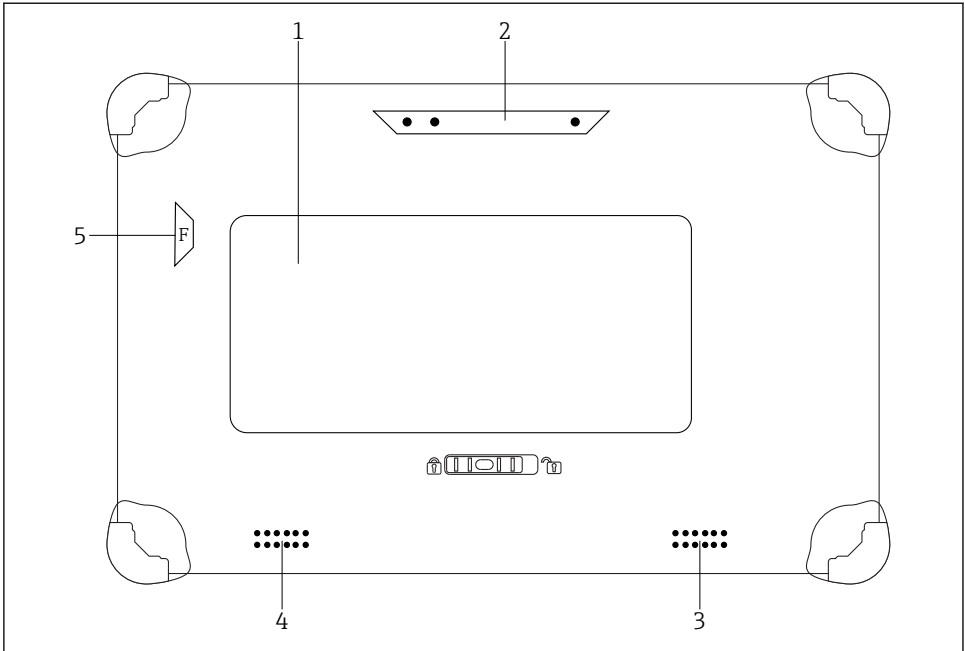

2 Rear view of tablet PC

- 1 Replaceable battery (SIM and SD card slot are located below the battery)
- 2 Rear camera
- 3 Loudspeaker, left side
- 4 Loudspeaker, right side
- 5 Button F: Torch

Component	Description
Camera flash	For additional lighting in poor light - press button F.
Camera	For taking pictures.
Battery compartment	Contains the battery.
Button to unlock the battery compartment	Press down the button and hold to unlock the battery compartment.
Loudspeaker	For sound.

Component	Description
SIM card slot	For inserting a SIM card for WWAN (LTE+GPS).
Memory card slot	For inserting Micro SD memory cards, and SD, SDXC, SDHC memory cards using an adapter.

3.1 Product design

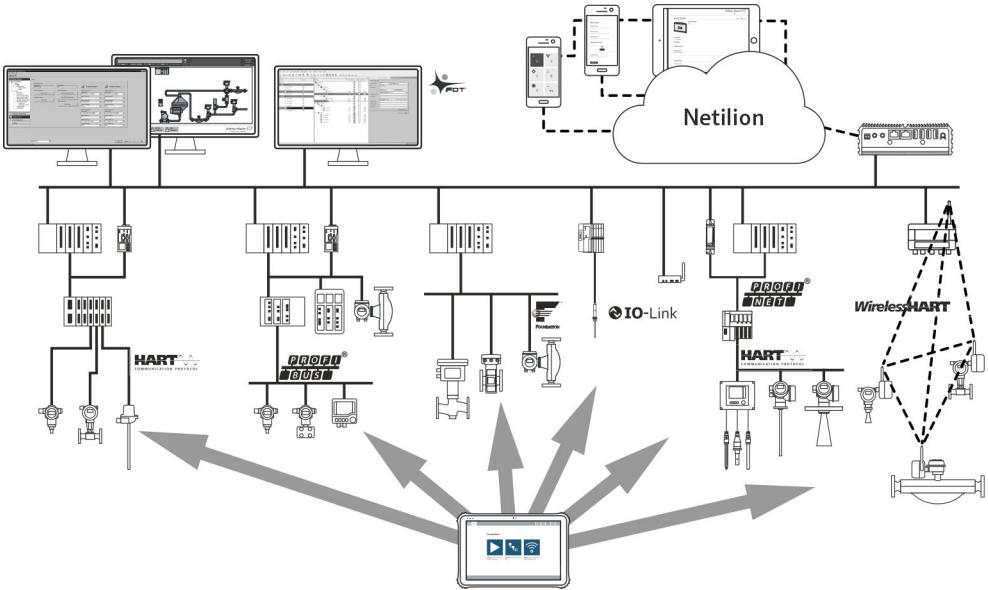

3 Network architecture

3.2 Application

The tablet PC for device configuration enables mobile plant asset management. It is suitable for commissioning and maintenance staff to manage field instruments with a digital communication interface and to record progress. This tablet PC is designed as a complete solution and is an easy-to-use, finger-operated tool which can be used to manage field instruments during their entire life cycle. It provides pre-installed driver libraries and offers access to the "Industrial Internet of Things" as well as to information and documentation during the entire life cycle of the device. The tablet PC offers a modern software user interface and the option of online updates based on a secure Microsoft Windows 10 multi-functional environment.

3.3 License model

The device configuration software is already installed on the tablet PC upon delivery.

To use the software as designated, the software must be activated. A user account is required in the Endress+Hauser software portal for this purpose. This account might first need to be created via the "Create account" function.

Activating the device configuration software package

1. Double-click **Field Xpert** on the start screen.
 - ↳ The software licensing page opens.

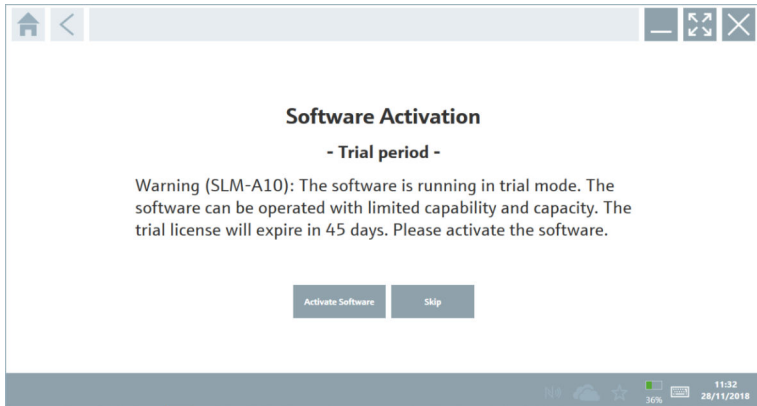

2. Click **Activate Software**.
 - ↳ The dialog box where you can enter the software portal data opens.

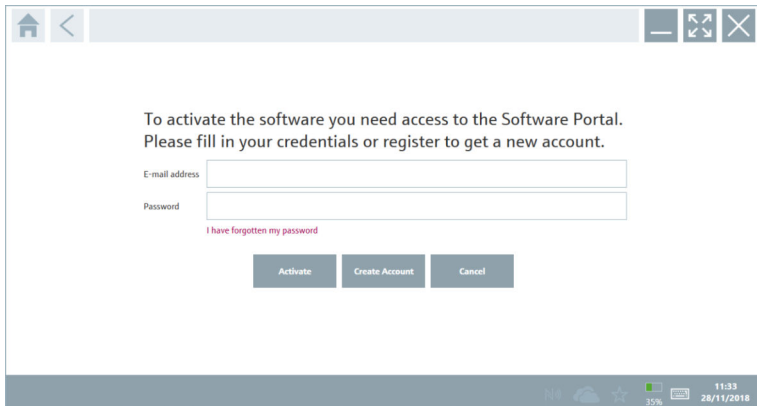

3. Enter the **e-mail address** and **password** and click **Activate**.
 - ↳ The dialog box opens containing the message "The application has been activated successfully".
4. Click **Show license**.
 - ↳ The dialog box with the licensing information opens.

5. Click **Close**.

The home screen of the device configuration software program opens.

4 Incoming acceptance and product identification

4.1 Incoming acceptance

Visual inspection

- Check the packaging for visible damage arising from transportation
- Open the packaging carefully
- Check the contents for visible damage
- Check that the delivery is complete and nothing is missing
- Retain all the accompanying documents



The device may not be put into operation if the contents are found to be damaged beforehand. In this case, please contact your Endress+Hauser Sales Center:

www.addresses.endress.com

Return the device to Endress+Hauser in the original packaging where possible.

Scope of delivery

- Field Xpert SMT50 tablet PC
- AC charger with device cable as per order
- Software and interfaces/modem as per order
- Operating Instructions with safety instructions from Bressner

4.2 Product identification

4.2.1 Nameplate

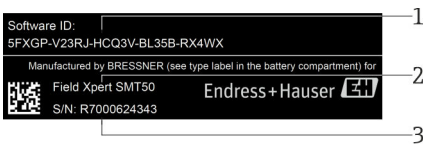

- 1 *Endress+Hauser software ID*
- 2 *Endress+Hauser product name*
- 3 *Endress+Hauser serial number*

4.2.2 Manufacturer address

Hardware

Bressner Technology GmbH

Industriestrasse 51D

82194 Grobenzell

Germany

www.bressner.de

Software

Endress+Hauser Process Solutions AG

Christoph Merian-Ring 12

4153 Reinach

Switzerland

www.endress.com

4.3 Storage and transport



Always use the original packaging when transporting the product.

4.3.1 Storage temperature

-20 to 60 °C (-4 to 140 °F)

5 Installation

5.1 System requirements



The software is already installed on the tablet PC upon delivery.

5.2 Installing the software

The device configuration software is already installed on the tablet PC upon delivery. The device configuration software must be activated.



Licensing model →  12

5.3 Updating the software

1. Click the  icon on the home screen of the device configuration software.
 - ↳ The dialog box with the licensing information opens.

2. Click the **Update** tab.

- ↳ The dialog box with the update information opens.

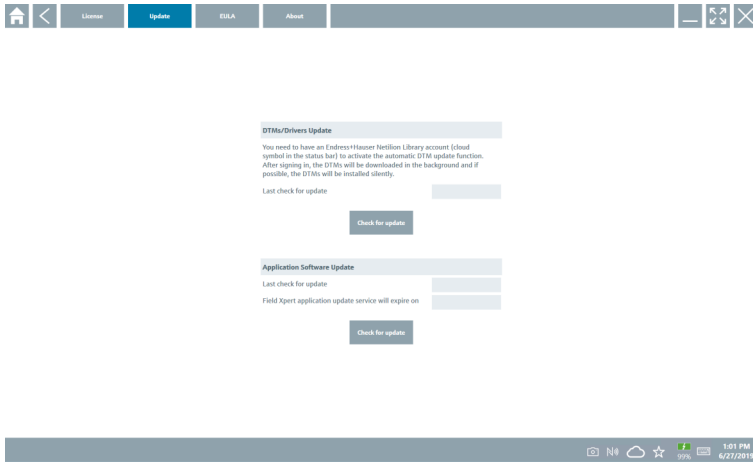

3. Click **Check for updates**.

- ↳ The device configuration software searches for updates.

5.4 Removing the software



The device configuration software may not be uninstalled.

6 Operation

Avoid damage to the housing and components:

- ▶ Always place the device on a stable surface.
- ▶ Do not cover the ventilation opening, or block it by other objects.
- ▶ Keep the device away from liquids.
- ▶ Do not expose the device to direct sunshine or very dusty conditions.
- ▶ Do not expose the device to excess heat or humidity.

6.1 Shutting down the tablet PC



Make sure you shut down the tablet PC properly, as this is the only way to avoid losing unsaved data.

- ▶ Tap the **Windows icon** →  → **Shut down**.

The tablet PC shuts down.



Do not disconnect the power source until the tablet PC is switched off completely.

6.2 Switching off the tablet PC

- ▶ Press and hold the  button until the power LED flashes.

The tablet PC is in sleep mode.

6.3 Security screen

1. Press key combination Ctrl +Alt+Del
 - ↳ Windows security screen appears

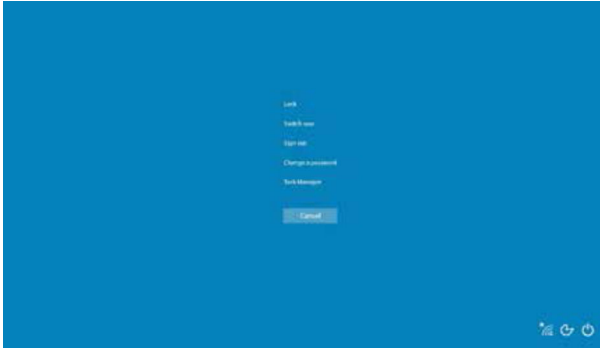

2. Select an action.

Possible actions:

- Lock device
- Change to another user
- Logout
- Change password
- Open Task Manager
- Shut down or restart the device

7 Commissioning

The tablet PC can be powered by the AC adapter or the lithium ion battery.

7.1 Inserting the battery

1.

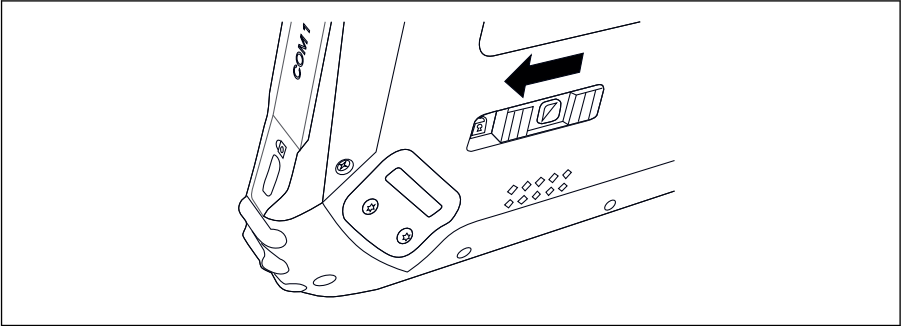

Release the lock on the battery cover by pressing the slide control on the rear of the tablet to the left.

2.

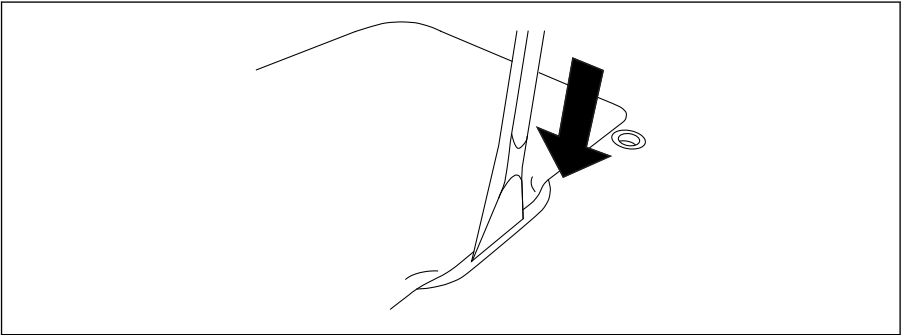

Take the enclosed plastic lever and use it to open the battery cover.

3.

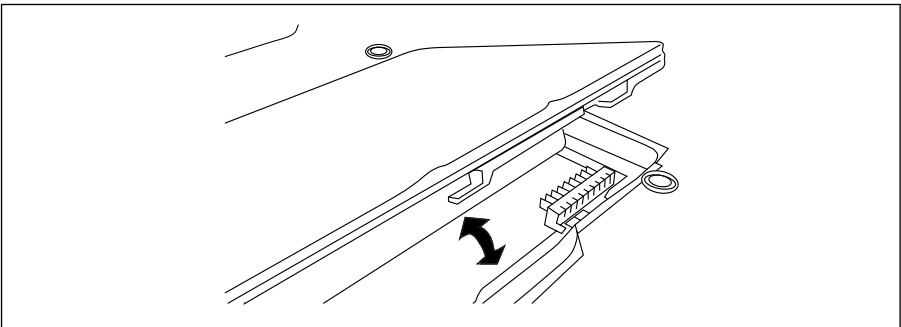

Insert the battery, fit the battery cover back on and close the lock by pressing the slide control to the right.

The battery is inserted.

7.2 Charging the battery



Due to transport safety regulations, the lithium ion battery is not fully charged when purchased.

1. The battery must be inserted.
Connect the AC adapter to the DC socket of the tablet PC.
2. Connect the AC adapter to the power cable.
3. Connect the power cable to a power outlet.

7.3 Switching on the tablet PC

- ▶ Press and hold the  button until the power LED is lit.

The tablet PC starts.

7.4 Connecting the AC adapter

The AC adapter powers the tablet PC and charges the battery.



When using the AC adapter:

Place the device sufficiently close to a power outlet that the power cable can still reach the outlet.

Only operate the device with the type of power source indicated on the device nameplate.

Disconnect the AC adapter from the power outlet if the device will not be used for an extended period.

1. Connect the AC adapter to the DC socket of the tablet PC.
2. Connect the AC adapter to the power cable.
3. Connect the power cable to a power outlet.



The tablet PC may only be used with the corresponding AC adapter.

If the tablet PC is connected to a socket and the battery is inserted, the tablet PC is powered via the socket.

8 Operation

NOTICE

The use of unsuitable objects to operate the device can damage the screen.

- ▶ Do not use pointed objects for the screen.

8.1 How to start

-  The user must accept the terms of use the first time the device configuration software is started.



- ▶ Double-click **Field Xpert** on the start screen.
 - ↳ The device configuration software starts.

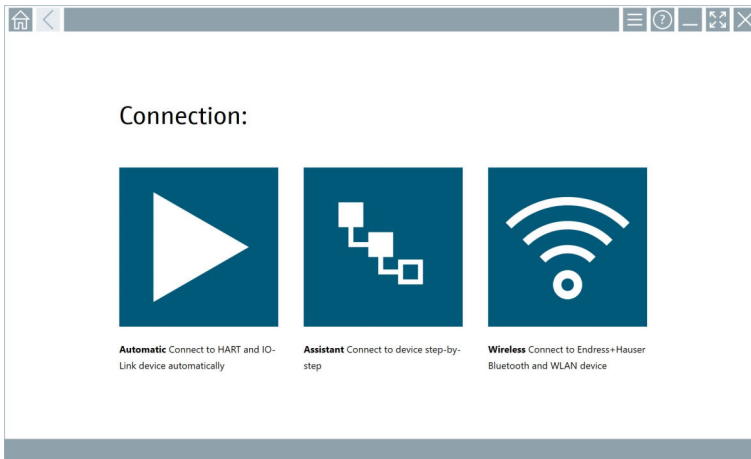

















8.2 Establishing a connection to the device



















A connection can be established in one of three ways:

- Automatic
- Using a wizard (manually)
- Via Wi-Fi and Bluetooth



Connect the desired modem or interface. Wait until the modem or interface has been detected (e.g. USB icon).

The following modems/interfaces are supported by the tablet PC:

Communication protocol	Connection	Modems/interfaces
HART	 	Commubox FXA195 4 to 20 mA
	 	MACTek Bluetooth modem 4 to 20 mA
		Memograph RSG45 (4 to 20 mA)
	 	MACTek USB modem (4 to 20 mA)
	 	FieldPort SFP50
		Fieldgate SFG250
		Tank Scanner NXA820
	WirelessHART	
		WirelessHART adapter SWG70
HART via PROFINET	  The Remote Wizard connection is visible in combination with the Fieldgate PAM SFG600.	Fieldgate PAM SFG600
PROFIBUS		Softing PROFiusb
		Softing PBpro USB

Communication protocol	Connection	Modems/interfaces
		FieldPort SFP50
		Fieldgate SFG500
FOUNDATION Fieldbus		NI USB
		FieldPort SFP50
		Softing FFusb
Modbus		Modbus serial
Endress+Hauser service interfaces		Commubox FXA291 CDI
		
		Commubox FXA291 IPC, ISS, PCP
		Commubox FXA193 IPC, ISS
		TXU10 V2 CDI
		TXU10 V2 PCP
		
		TXU10 V1 PCP, CDI
		CDI USB
		
		CDI TCP/IP
Bluetooth		Endress+Hauser Bluetooth devices

A0041855

Communication protocol	Connection	Modems/interfaces
Wi-Fi	 <small>A0041855</small>	Endress+Hauser Wi-Fi devices
IO-Link	 	FieldPort SFP20

"Automatic" connection

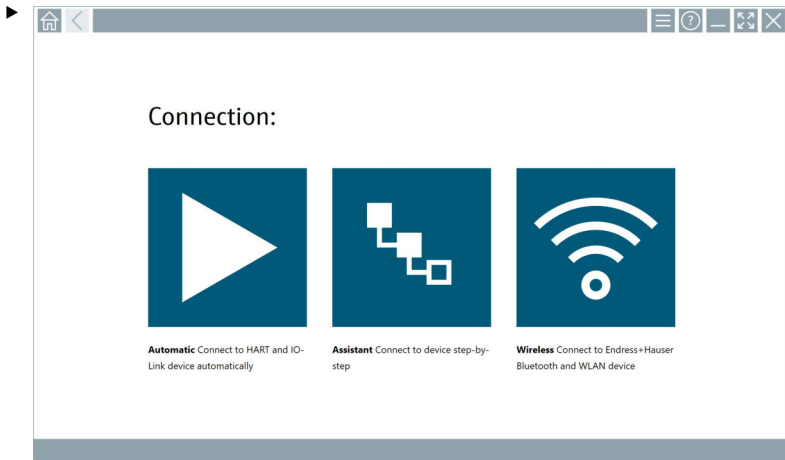

Click the  icon.

↳ The device configuration software establishes a connection to the connected device.

"Wizard" connection

1.

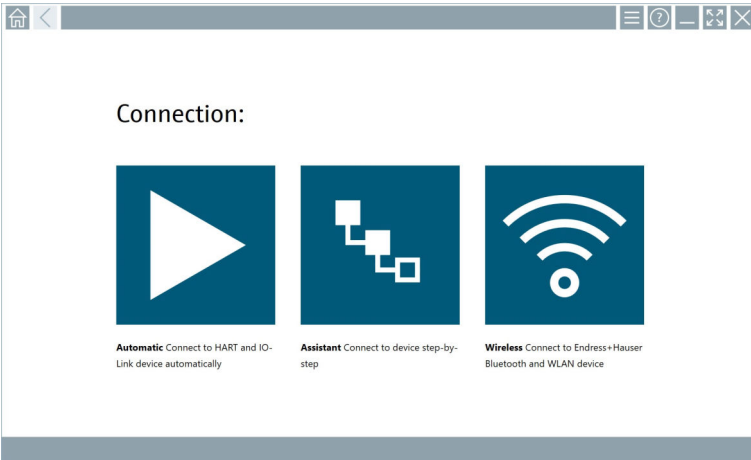

Click the  icon.

↳ An overview of all the protocols available opens.

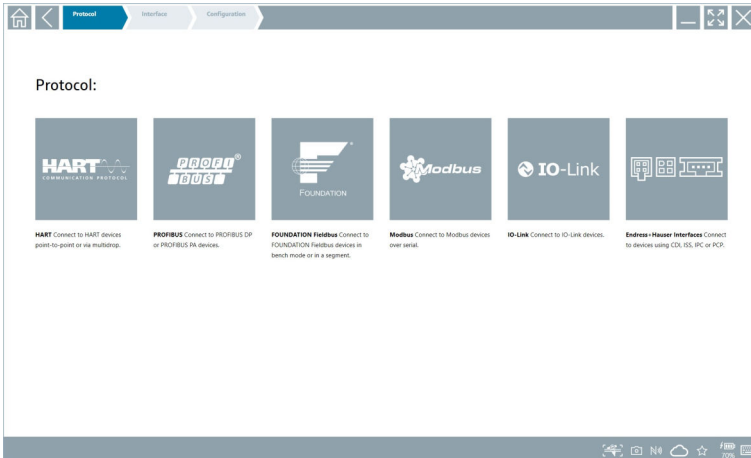

2. Select a communication protocol.

- ↳ An overview of all the modems available opens.

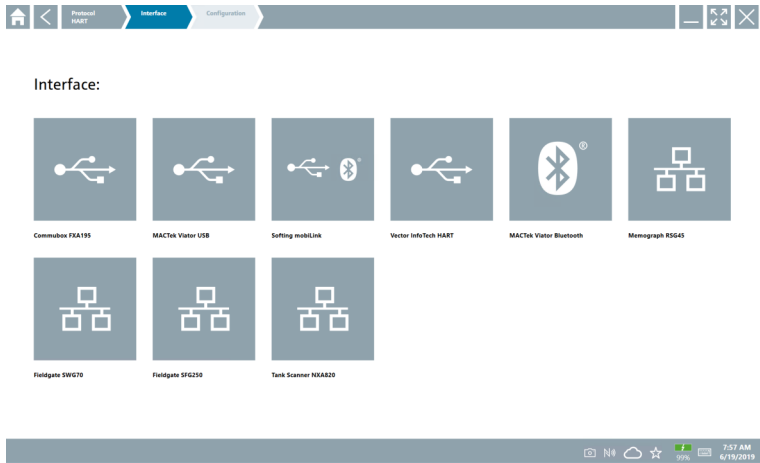

3. Select a modem.

- ↳ The device can now be configured.

"Wireless" connection

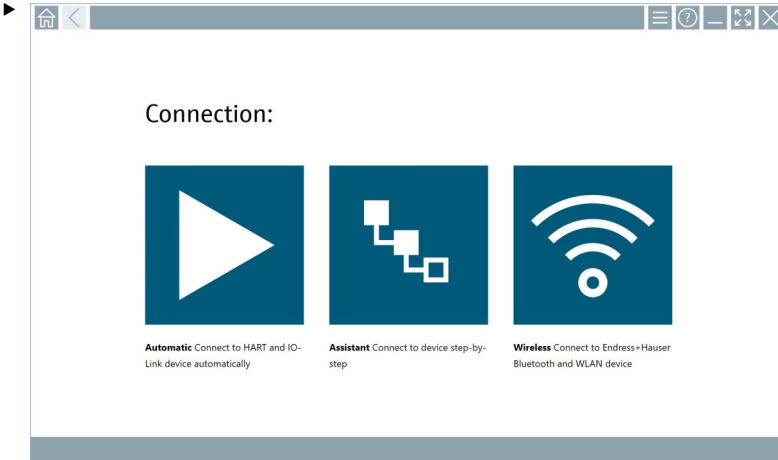

Click the  icon.

- ↳ The live list appears with all available Endress+Hauser Wi-Fi and Bluetooth devices. This list can be filtered for Wi-Fi and Bluetooth devices.

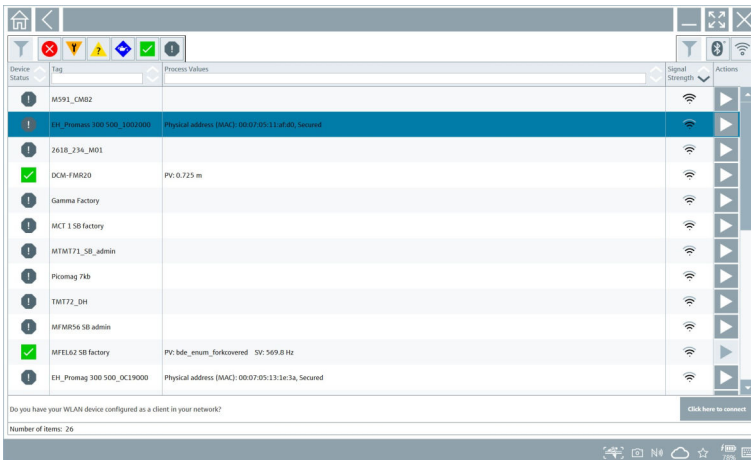

"Bluetooth" connection

1. Click the  icon to filter for Bluetooth devices.

2. Click the ▶ icon beside the device that should be configured.
 - ↳ The Login dialog box appears.

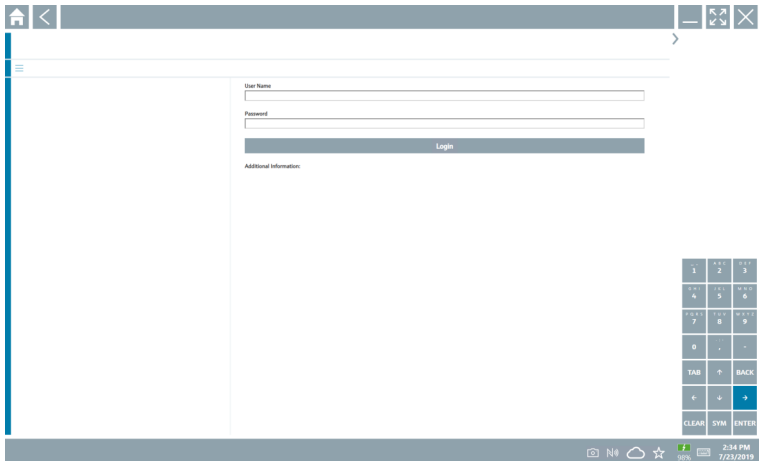

3. Enter "admin" for the **username** and the **password** and click **Login**.
 - ↳ The dialog box for initial commissioning opens.





The initial password corresponds to the serial number of the device.

"WLAN" connection

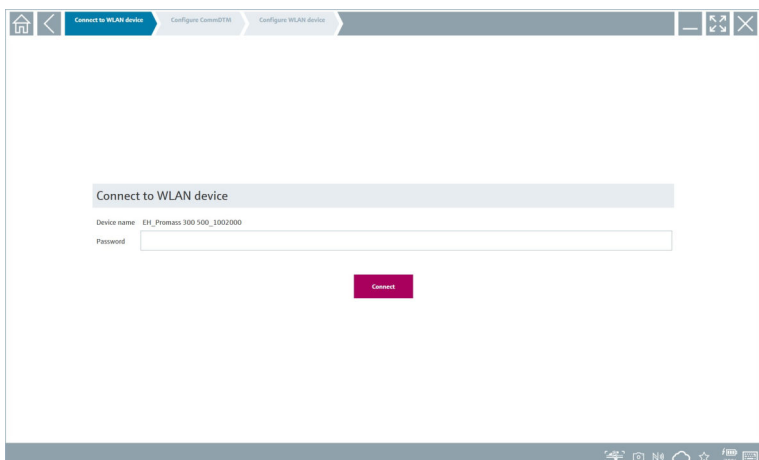
1. Click the 📶 icon to filter for WLAN devices.
2. Click the ▶ icon beside the device that should be configured.
 - ↳ The Connect to WLAN device dialog box appears.



3. Enter the **password** and click **Connect**.
 - ↳ The connection window opens.
4. Do not change the IP address - leave it as is.
5. Click the  icon.
6. Click **Vendor specific**.
7. The DeviceDTM opens and the device can be configured.

 The initial password corresponds to the serial number of the device.

 Tap [Click here to connect](#) to establish the connection directly via an IP address.

8.3 Information and software settings

- ▶ Click the  icon in the main menu.
 - ↳ An overview of all the information and settings opens.

8.3.1 DTM catalog

- ▶ Click the **DTM catalog** tab.
 - ↳ An overview of all the DTMs available opens.

Item	DTM Device Type	Location	Manufacturer	Date	Protocol	Status
	Piscuit C16	L09	Laborn	2018-01-10	HART	New
	_DD-MID-Dx12.FF Rev 1	DD Rev 0x4	Pepperl+Fuchs GmbH (DTM)	2017-01-03	Fieldbus FF H1	OK
	000000004 Name not available Rev 1	DD Rev 0x1	Manufacturer Expansion (DTM)	2019-05-14	HART	OK
	00603E004 Name not available Rev 1	DD Rev 0x1	Power-Genes Ltd. (DTM)	2019-05-14	HART	OK
	0990 Fieldbus Switch Bus Rev 4	DD Rev 0x1	EL-Q-MATIC BV (DTM)	2000-09-01	Fieldbus FF H1	OK
	1000 Rev 1	DD Rev 0x1	ROSEMOUNT ANALYTICAL DIVISION (DTM)	2001-05-09	Fieldbus FF H1	OK
	1056 Rev 1	DD Rev 0x1	Rosemount Analytic (DTM)	2019-05-14	HART	OK
	1056 Rev 2	DD Rev 0x1	Rosemount Analytic (DTM)	2019-05-14	HART	OK
	1066 Rev 1	DD Rev 0x1	Rosemount Analytic (DTM)	2019-05-14	HART	OK
	1066 Rev 2	DD Rev 0x1	Rosemount Analytic (DTM)	2019-05-14	HART	OK
	1066 C/F-FF Conductivity Analyser Rev 1	DD Rev 0x3	ROSEMOUNT ANALYTICAL INC. (DTM)	2011-12-16	Fieldbus FF H1	OK
	1066-00-CL-02-FF Amperometric Analyser Rev 1	DD Rev 0x3	ROSEMOUNT ANALYTICAL INC. (DTM)	2012-01-18	Fieldbus FF H1	OK
	1066 P-FF Fieldbus Transmitter Rev 1	DD Rev 0x5	ROSEMOUNT ANALYTICAL INC. (DTM)	2010-12-21	Fieldbus FF H1	OK
	1151 Rev 1	DD Rev 0x1	Rosemount (DTM)	2019-05-14	HART	OK
	1151 Rev 2	DD Rev 0x1	Rosemount (DTM)	2019-05-14	HART	OK

Total: 3119

Device driver offline view

- ▶ Double-click the desired device driver.

The offline view of the device driver opens.



This function is only possible if the device driver supports the offline view.



If other device drivers (DTMs) are required, they can be installed additionally. After an automatic or manual  update, these drivers appear in the DTM catalog.

8.3.2 Event log

- ▶ Click the **Event log** tab or the gray status bar.
 - ↳ An overview of all the events opens.

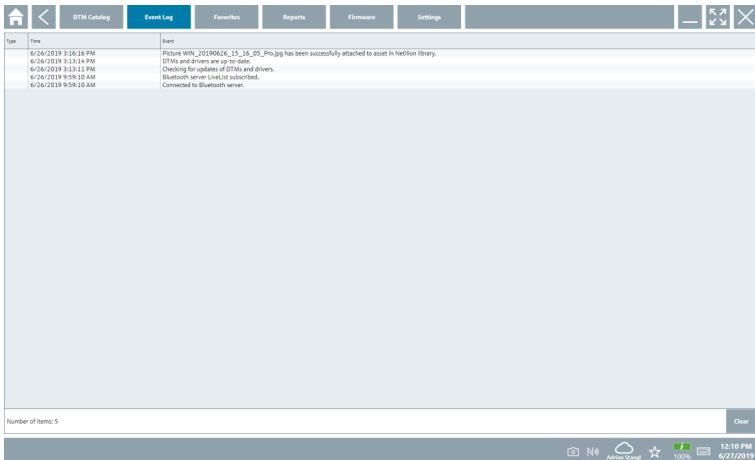

If event logs are already listed, they can be deleted using the **Delete** button.

8.3.3 Favorites

- ▶ Click the **Favorites** tab or the ☆ icon.
 - ↳ An overview of all the favorites opens.

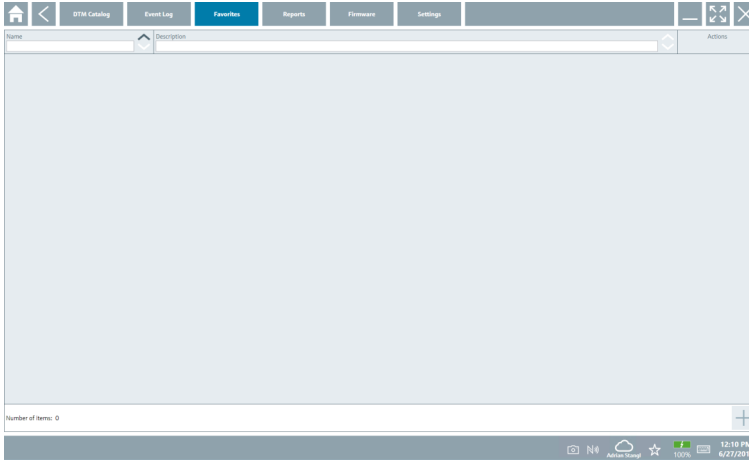

8.3.4 Managing reports

1. Click the **Manage reports** tab.
 - ↳ An overview with the "Manage saved device reports" folder opens.

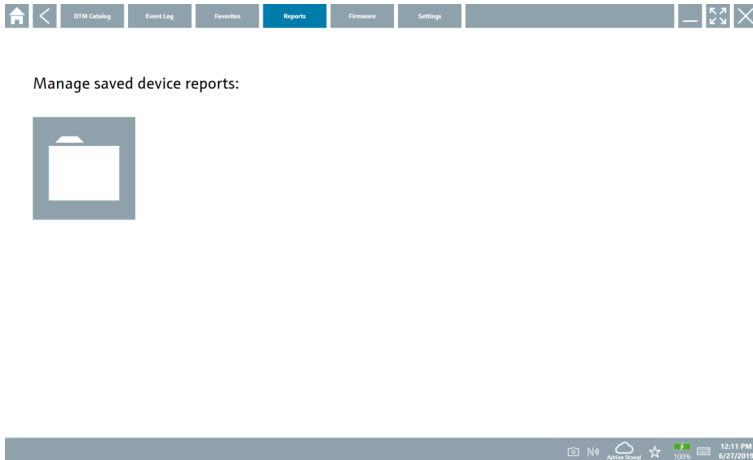

2. Click the "Manage saved device reports" folder.
 - ↳ An overview of all the saved device reports opens.

8.3.5 Firmware

- ▶ Click the **Firmware** tab.
- ↳ An overview of the firmware opens.

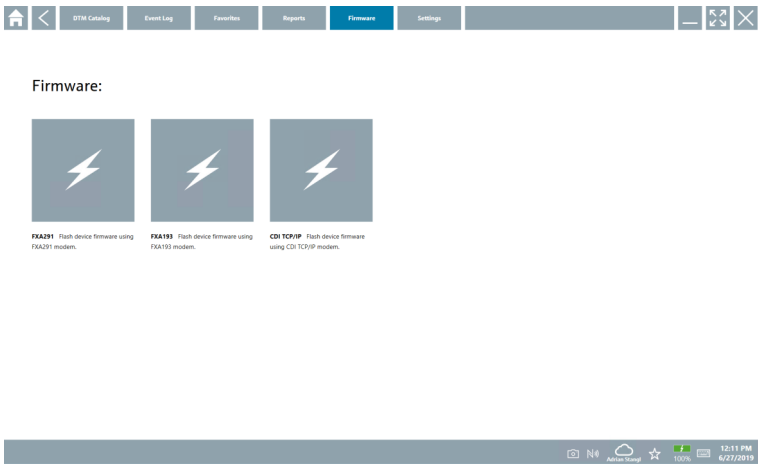

8.3.6 Settings

Language

1. Click the **Settings** tab.
- ↳ The **Language** tab opens with an overview of all the languages available.

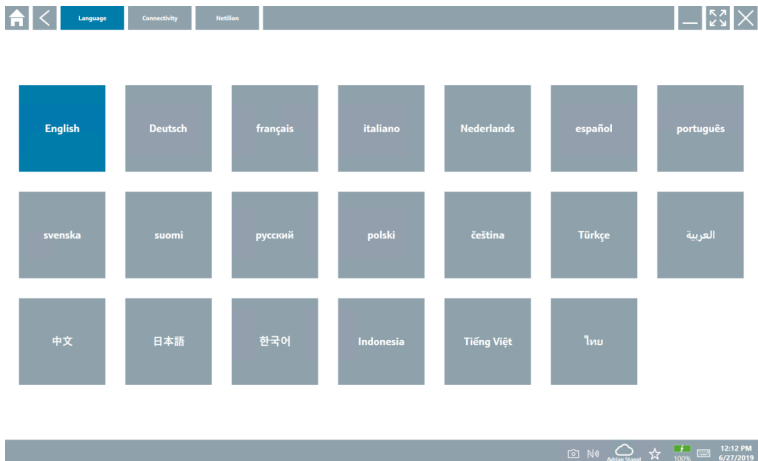



2. Click the desired **language**.

3. Click the  icon.
 - ↳ The device configuration software closes.
4. Restart the device configuration software.
 - ↳ The selected language is saved.

Connection

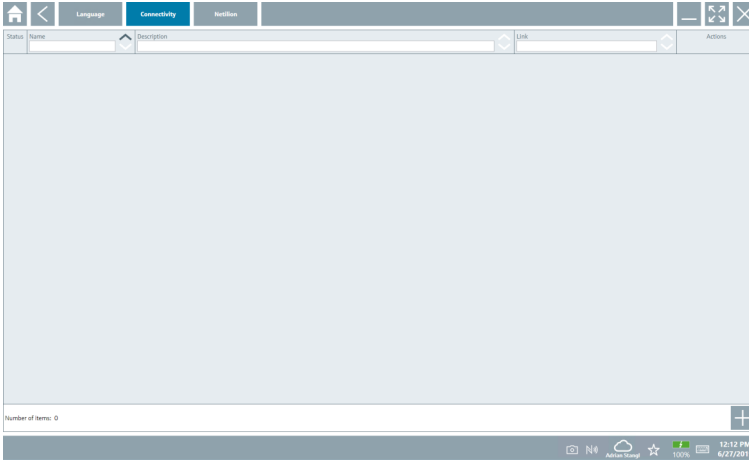
- ▶ Click the **Connection** tab.
 - ↳ An overview of all the connections opens.



-  The "Connectivity" tab is relevant only in conjunction with the Fieldgate PAM SFG600 HART via PROFINET .

Netilion

- ▶ Click the **Netilion** tab.
 - ↳ An overview of data storage settings opens.

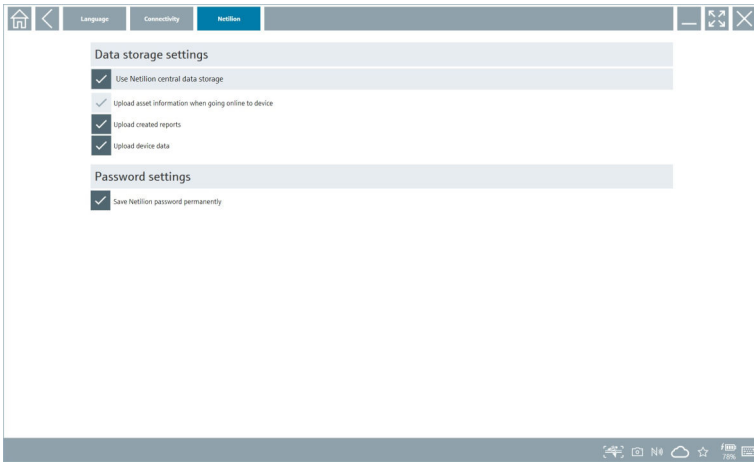

8.4 Additional information about the software

- ▶ Click the **?** icon.
 - ↳ An overview of all the additional information opens.

8.4.1 License

- ▶ Click the **License** tab.
 - ↳ The dialog box with the licensing information opens.

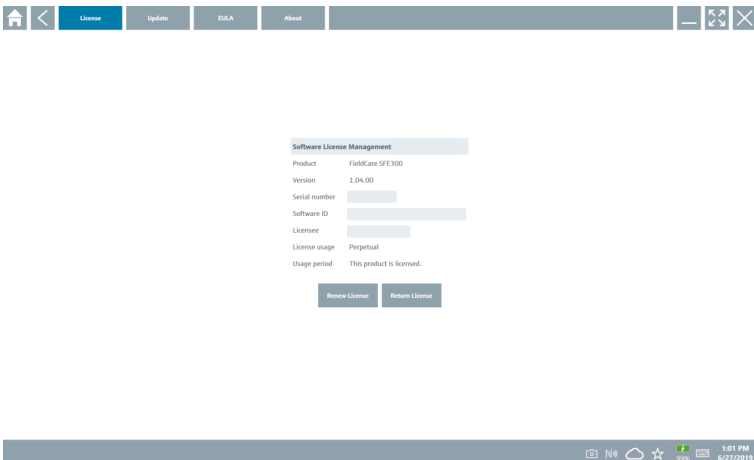

Renewing the license

 Field Xpert SMT71 must be ordered when the maintenance contract has expired. The customer receives a notification in the Field Xpert software upon successful completion of the order.

8.4.2 Updating

- ▶ Click the **Update** tab.
 - ↳ The window with the updates opens.

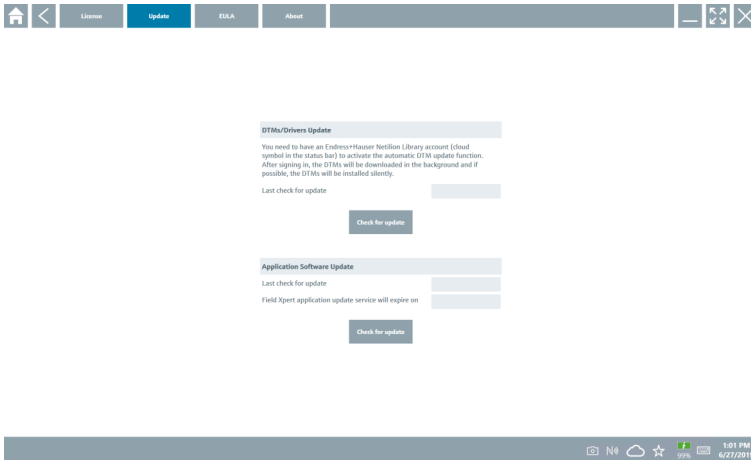

8.4.3 EULA

- ▶ Click the **EULA** tab.
 - ↳ The window with the Endress+Hauser Terms and Licensing Conditions opens.

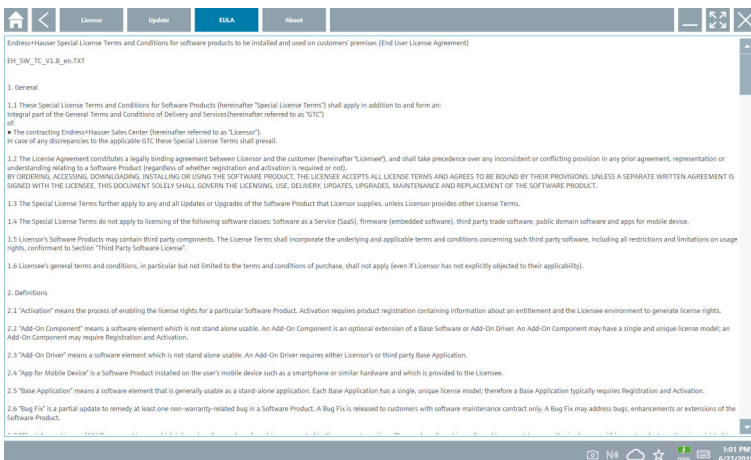

8.4.4 Info

This tab contains information about the software currently installed, the manufacturer and the software source text.

1. Click the **About** tab.

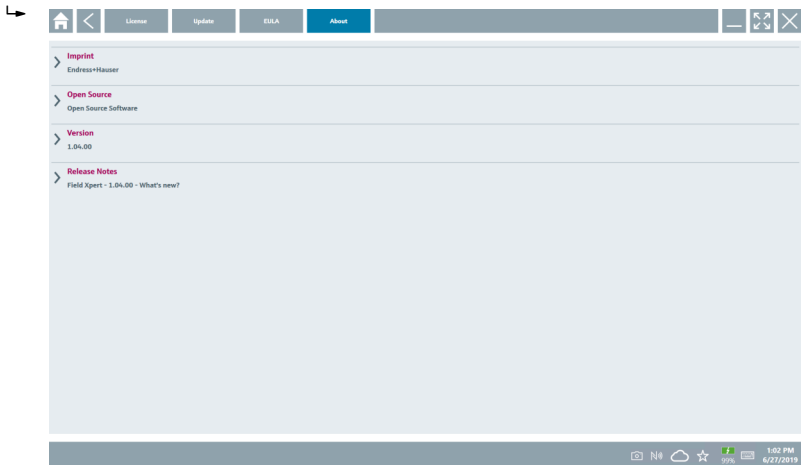

An overview of all the information opens.

2. Click the  icon to view the information.

8.5 Fieldgate PAM SFG600 HART via PROFINET

The Fieldgate PAM SFG600 is a device configuration management gateway and supports HART devices via PROFINET networks. The HART devices must have a unique device TAG. Also, the devices must be in operation with a PROFINET controller and operated via the Siemens assembly ET200SP IM 155-6PN HF with the 4XI 2-wire HART analog modules with HART capabilities.



For detailed information on "Fieldgate PAM SFG600", see the Brief Operating Instructions





Click the  icon.

↳ The **Communication server** overview opens.

8.6 Automatic DTM update

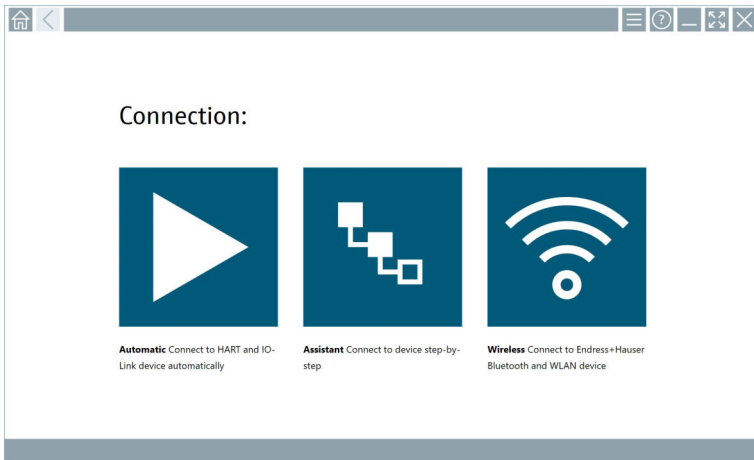
1.



Click the  icon in the status bar.

↳ The "Sign in to Netilion Library" dialog box opens.

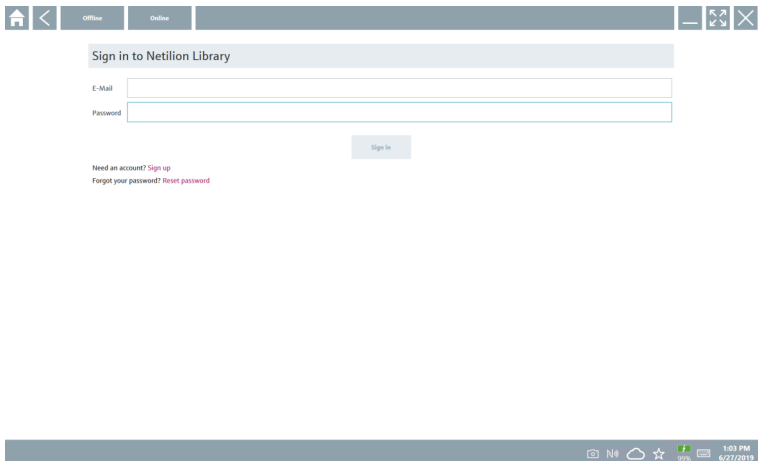

2. Click **Sign up**.

3. Choose subscription (Basic/Plus/Premium).

4. Sign in with the Netilion data.

↳ The tablet searches for DTMs in the background, and they are downloaded.

5. Confirm download.

↳ Installation starts.

8.7 Netilion Library

8.7.1 Uploading a device report to the Netilion Library

 This function is possible with HART, PROFIBUS, FOUNDATION Fieldbus and IO-Link devices as well as via the Endress+Hauser Service interface (CDI).

1.

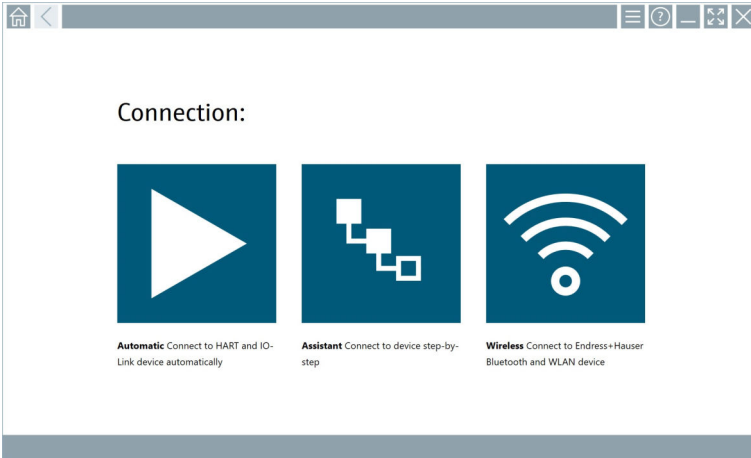

Click the  icon in the status bar.

↳ The "Sign in to Netilion Library" dialog box opens.

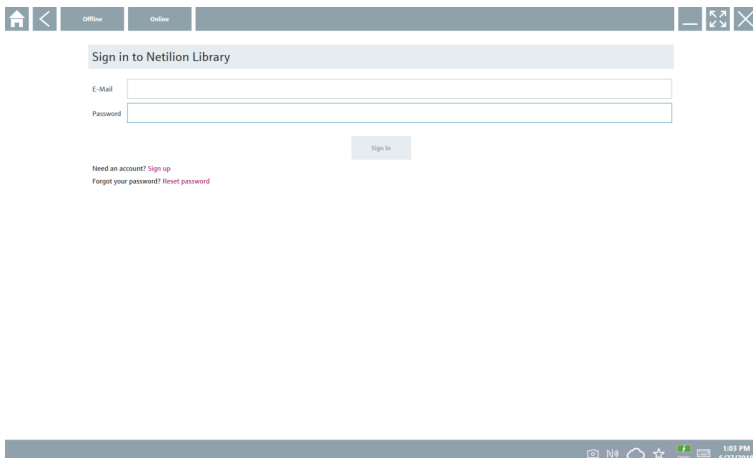

2. Click **Sign up**.

3. Choose subscription (Basic/Plus/Premium).

4. Connect device and open DTM.
 - ↳ Device is automatically stored in the Netilion Library.
5. Click "Save device report".
 - ↳ The device report is appended to the device in the Netilion Library.

8.7.2 Uploading a photo to the Netilion Library

1. Establish a connection to the device and open the DTM.
Click the  icon.
 - ↳ The camera opens.
2. Create a device photo.
 - ↳ The "New image found" dialog box opens.
3. Click **Yes**.
 - ↳ The photo is uploaded to the Netilion Library for the existing asset.

Uploading a photo from Camera Roll

1. Establish a connection to the device and open the DTM.
Click the  icon.
 - ↳ The dialog box opens.
2. Select the file type.
3. Select the photo from a directory in Field Xpert.
4. Click **Yes**.
 - ↳ The photo is uploaded to the Netilion Library for the existing asset.

8.7.3 Uploading a PDF to the Netilion Library

1. Establish a connection to the device and open the DTM.
Click the  icon.
 - ↳ The dialog box opens.
2. Select the file type.
3. Select the PDF from a directory in Field Xpert.
4. Click **Yes**.
 - ↳ The PDF is uploaded to the Netilion Library for the existing asset.

8.7.4 Uploading parameter data records to the Netilion Library

1. In the status bar, click the  icon and sign in.
2. Connect device and open DTM.
3. In the **Program functions** menu, click **Save device data**.
 - ↳ The parameter data records are uploaded to the Netilion Library for the existing asset.

8.7.5 Offline use case

i Scanned devices, new photos, device reports (PDF) and parameter records are automatically saved in the offline cache. They are uploaded automatically once a new Internet connection is established.

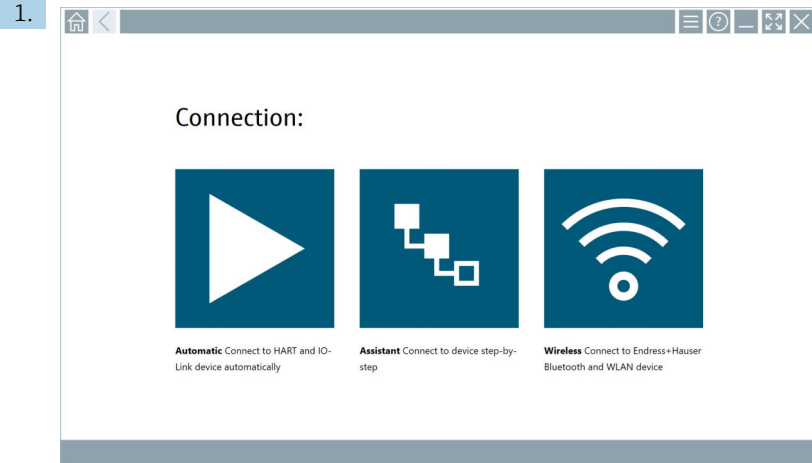

Click the ☁ icon in the status bar.

➔ The "Sign in to Netilion Library" dialog box opens.

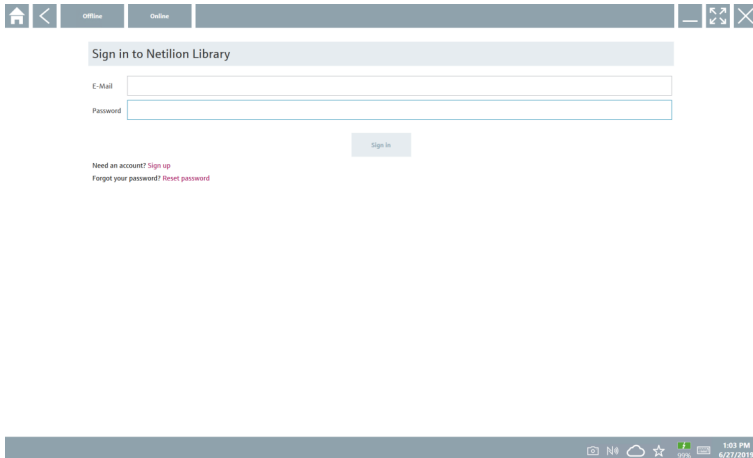

2. Click the **Offline** tab.

- ↳ The "Offline data storage information" dialog box opens.

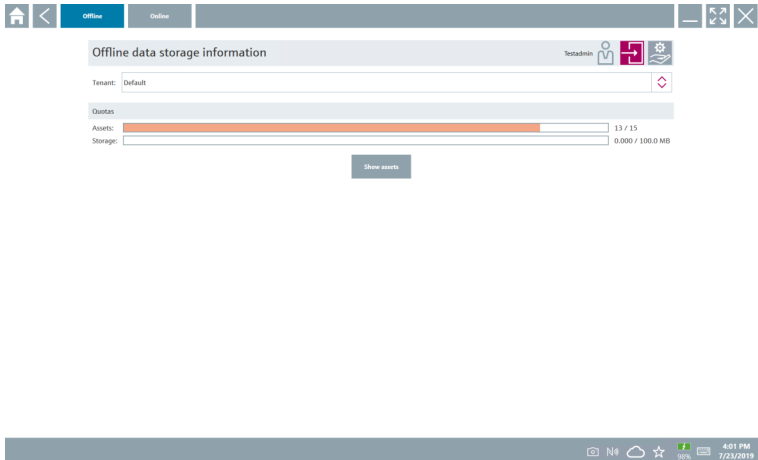

3. Click **Show assets**.

- ↳ An overview of all assets and documents appears.

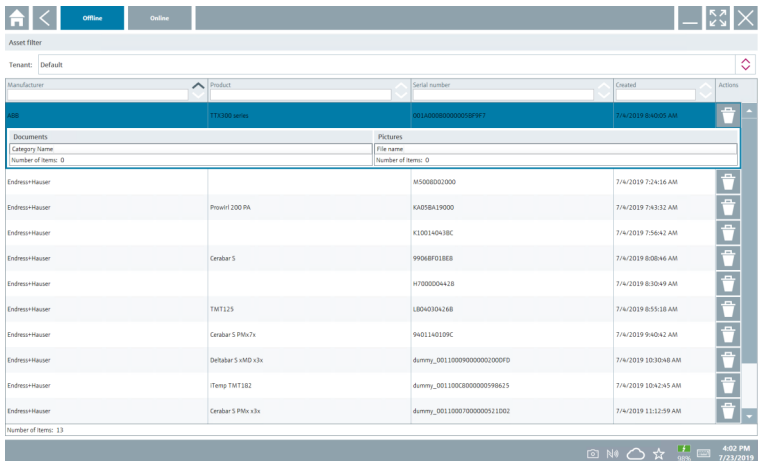

4. Click the icon to remove assets and documents.

5. Click the **Online** tab and sign in.

6. Click **Upload asset data**.

- ↳ The dialog box with all of the data to upload opens.

7. Click **Upload**.

8.7.6 Link to Netilion Library

1. Click the  icon in the status bar.
 - ↳ The Netilion Library dialog box opens.
2. Sign in to the Netilion Library.

8.8 Scanner App

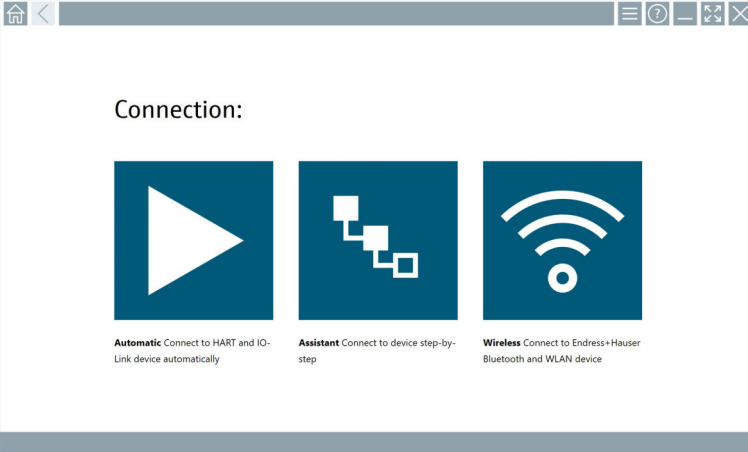
1. 

Click the  icon in the status bar.

↳ The wizard to create a device in the Netilion Library is started.

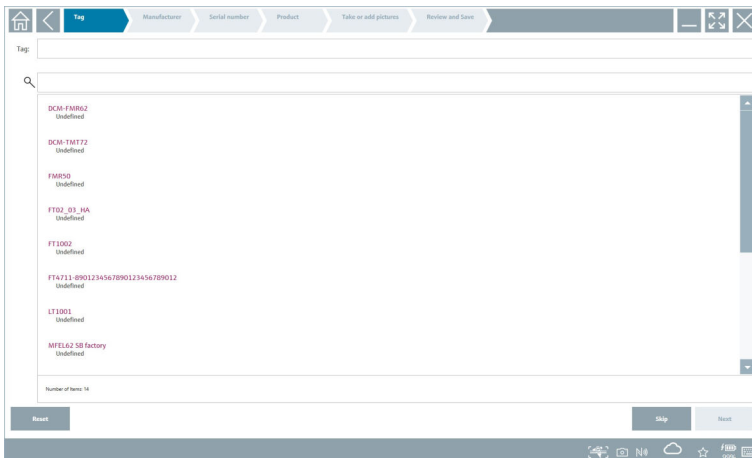

2. Follow the instructions of the wizard and enter or select the data step by step.

3. Click **Save**.

↳ The device is stored in the Netilion Library.

4. When the wizard has completed all the steps, it starts again automatically so that another device can be entered.



The Scanner App also works in offline mode. Data already saved in the Netilion Library are not available offline.

8.9 Uploading a Heartbeat Verification report to the Netilion Library

1.

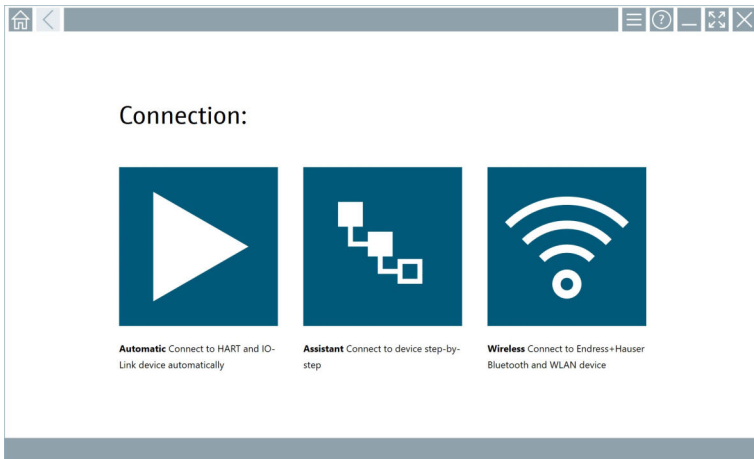

Click the  icon.

↳ A connection to the desired device is established.

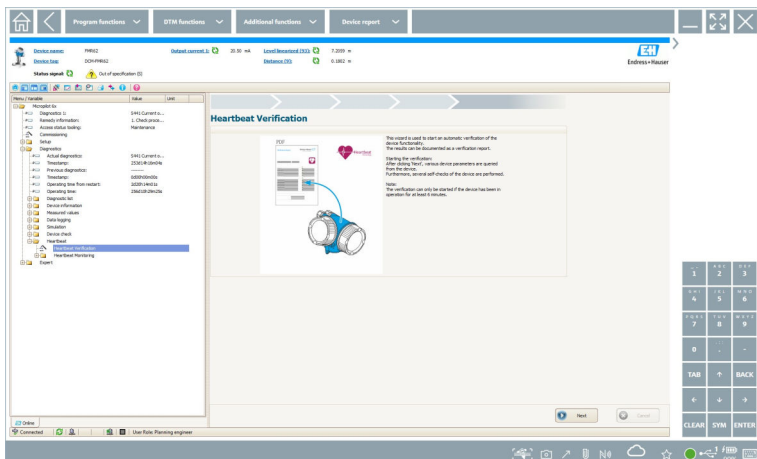

2. Start the Heartbeat wizard.
3. Follow the Heartbeat wizard and start a Heartbeat Verification.
4. When the Heartbeat Verification is finished, save the result as a PDF.
 - ↳ A dialog appears where you can select the storage location for the PDF file.
5. Select the storage location and click **Save**.
 - ↳ A dialog for saving in the Netilion Library appears.
6. Click **Yes**.
 - ↳ A dialog appears where you can select the document type.
7. Select Heartbeat Verification Report and click **Yes**.
 - ↳ The Heartbeat Verification Report is uploaded to the Netilion Library for the existing asset.

8.10 RFID

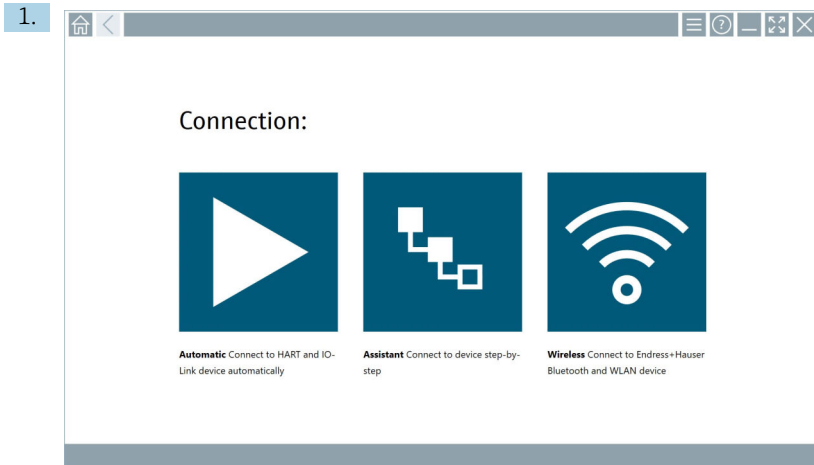

Click the  icon in the status bar.

↳ The "RFID TAG Editor" dialog box opens.

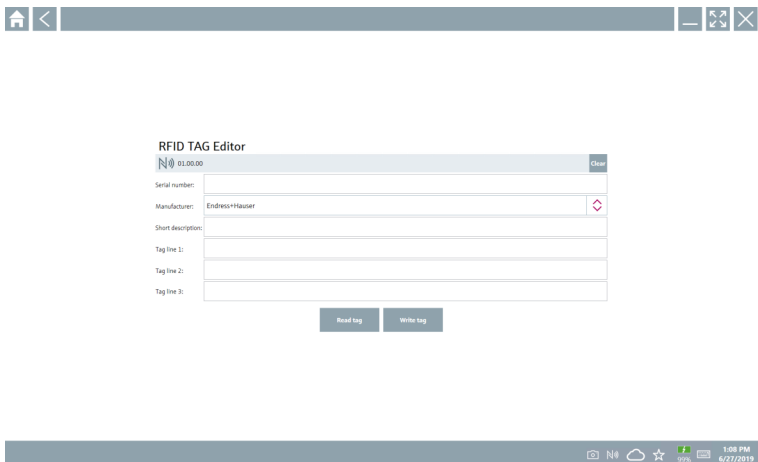

2. Plug in the RFID scanner.
3. Click **Read tag**.
4. Place the RFID tag on the scanner, and click **Device Viewer**.
 - ↳ The Device Viewer opens in Internet Explorer.
5. Change tag or serial numbers and click **Write tag**.
 - ↳ The RFID tag is changed.

9 Maintenance

9.1 Replacing the battery

⚠ DANGER

Incorrect replacement of the battery can cause an explosion.

- ▶ Always replace the battery with an identical battery or an equivalent type of battery recommended by the manufacturer.

i The battery capacity gradually diminishes over time, depending on how the battery is used. The battery can be replaced after 18 to 24 months.

Dispose of used batteries in accordance with the manufacturer's instructions.

Replacing the battery

1.

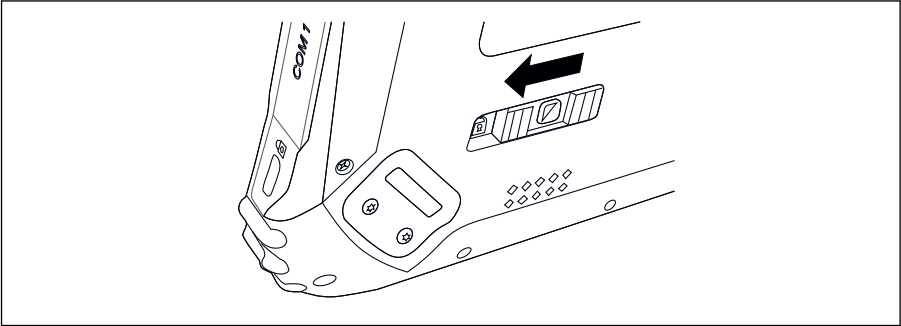

Release the lock on the battery cover by pressing the slide control on the rear of the tablet to the left.

2.

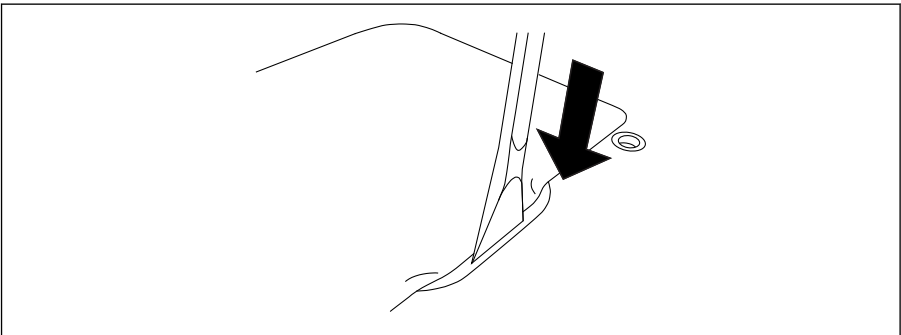

Take the enclosed plastic lever and use it to open the battery cover.

3.

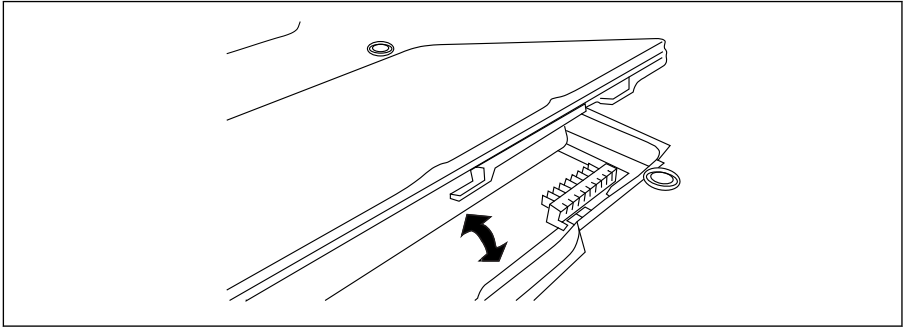

Replace the battery, fit the battery cover back on and close the lock by pressing the slide control to the right.

10 Repair

10.1 General notes

NOTICE

Never disassemble or repair the device yourself, as this will render the warranty invalid.

- ▶ If the device is in need of repair, always contact your Endress+Hauser Sales Center:
www.addresses.endress.com

10.2 Spare parts

Detailed information about spare parts is available from the Endress+Hauser Sales Center:
www.addresses.endress.com or at www.endress.com/smt50

10.3 Return

The device must be returned if the wrong device has been ordered or delivered, or if the device is in need of repair. As an ISO-certified company and also due to legal regulations, Endress+Hauser is obliged to follow certain procedures when handling any returned products.

To ensure safe, swift and professional device returns, please refer to the procedure and conditions for returning devices provided on the Endress+Hauser website
<http://www.endress.com/support/return-material>

10.4 Disposal

When disposing of consumables and waste material, follow the current regulations for waste disposal.

The tablet PC can be handed in directly to the place of purchase free of charge, where it will be disposed of in an environmentally friendly manner on your behalf.

10.4.1 Battery disposal

This product contains a lithium-ion battery or a nickel-metal hydride battery. These batteries must be disposed of in the correct manner. Please contact your local environmental protection authority for information on recycling and disposal schemes in your country.

11 Accessories

Optional accessories:

- X-strap
- Shoulder strap
- Leather case
- Office docking station (2 x USB, 1 x 1 Gbit Ethernet, 1 x RS232)
- Battery charger
- Device cable EU, US, UK, CH, IT, AU

Please contact your Endress+Hauser Sales Center for detailed information on accessories:
www.addresses.endress.com or at www.endress.com/smt50

12 Technical data



For detailed information on the "technical data": see the Technical Information

www.addresses.endress.com
