

Operating Instructions

Deltabar FMD71, FMD72

Level measurement with electronic differential pressure
Electronic differential pressure transmitter with ceramic
and metal sensors

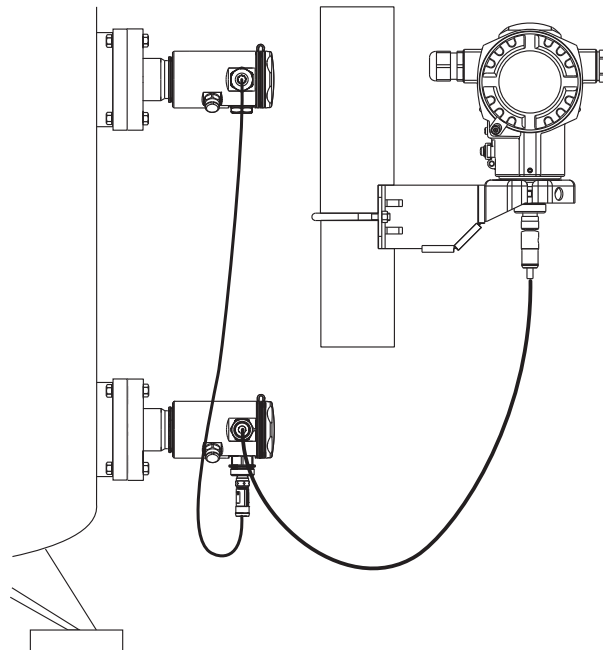

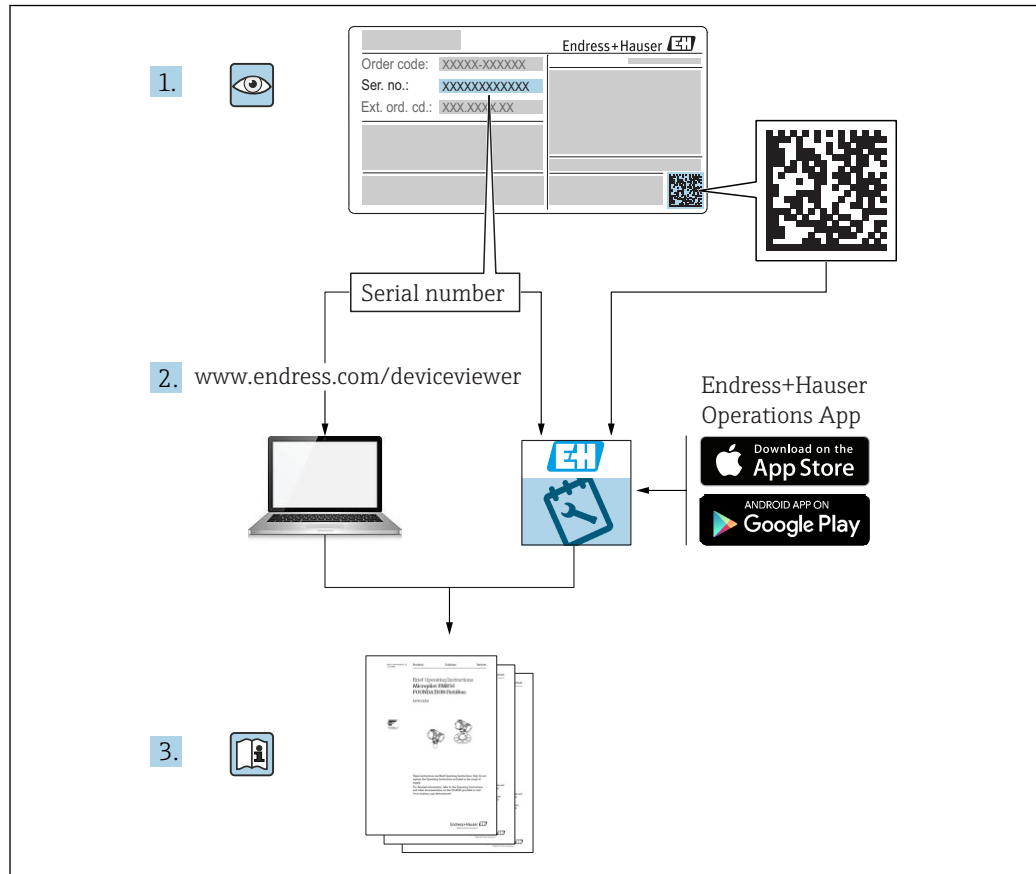

A0023555

- Make sure the document is stored in a safe place such that it is always available when working on or with the device.
- To avoid danger to individuals or the facility, read the "Basic safety instructions" section carefully, as well as all other safety instructions in the document that are specific to working procedures.
- The manufacturer reserves the right to modify technical data without prior notice. Your Endress+Hauser distributor will supply you with current information and updates to these Instructions.

Table of contents

1	Document information	5	7	Operation options	30
1.1	Document function	5	7.1	Operation without operating menu	30
1.2	Symbols used	5	7.2	Operation with an operating menu	32
1.3	Documentation	6	7.3	Structure of the operating menu	32
1.4	Terms and abbreviations	8	7.4	Operating options	33
1.5	Turn down calculation	9	7.5	Operating the device using onsite display (optional)	33
1.6	Registered trademarks	9	7.6	Operation using Endress+Hauser operating program	36
2	Basic safety instructions	10	7.7	Direct access to parameters	37
2.1	Requirements concerning the staff	10	7.8	Locking/unlocking operation	37
2.2	Designated use	10	7.9	Resetting to factory settings (reset)	38
2.3	Workplace safety	11	8	Integrating transmitter via HART® protocol	40
2.4	Operational safety	11	8.1	HART process variables and measured values	40
2.5	Product safety	11	8.2	Device variables and measured values	41
3	Product description	12	9	Commissioning	42
3.1	Product design	12	9.1	Post-installation check and function check ...	42
3.2	Function	13	9.2	Unlocking/locking configuration	42
4	Incoming acceptance and product identification	14	9.3	Commissioning without an operating menu ..	42
4.1	Incoming acceptance	14	9.4	Commissioning with an operating menu	45
4.2	Product identification	15	9.5	Language selection	45
4.3	Nameplates	15	9.6	Measuring mode selection	46
4.4	Storage and transport	17	9.7	Selecting the high-pressure side	46
5	Installation	18	9.8	Pressure unit selection	47
5.1	Mounting dimensions	18	9.9	Pos. zero adjust	47
5.2	Mounting location	18	9.10	Configuring level measurement	48
5.3	Orientation	18	9.11	Linearization	58
5.4	General installation instructions	18	9.12	Configuring pressure measurement	61
5.5	Thermal insulation - FMD71 high- temperature version	19	9.13	Backing up or duplicating the device data ...	63
5.6	Installing the sensor modules	20	9.14	Configuring the local display	64
5.7	Mounting sensor modules with PVDF installation coupling	20	9.15	Protecting settings from unauthorized access	64
5.8	Installing the transmitter	21	10	Diagnostics and troubleshooting ...	65
5.9	Closing the housing cover	22	10.1	Troubleshooting	65
5.10	Seal for flange mounting	23	10.2	Diagnostic events	65
5.11	Post-installation check	23	10.3	Response of output to errors	69
6	Electrical connection	24	10.4	Firmware history	70
6.1	Connecting the sensor module LP to the sensor module HP	24	10.5	Disposal	70
6.2	Connecting the sensor module HP to the transmitter	25	11	Maintenance	71
6.3	Connecting the measuring unit	26	11.1	Information on cleaning	71
6.4	Connection conditions	27	11.2	Exterior cleaning	71
6.5	Connection data	28	12	Repairs	72
6.6	Post-connection check	29	12.1	General notes	72
			12.2	Spare parts	73

12.3	Return	73
13	Overview of the operating menu	74
14	Description of Device Parameters ...	78
14.1	Language	78
14.2	Display/operat.	78
14.3	Setup	80
14.4	Setup → Extended Setup	85
14.5	Setup → Extended Setup → Level ("Level" measuring mode)	86
14.6	Setup → Extended Setup → Linearization	91
14.7	Setup → Extended Setup → Current output ...	93
14.8	Diagnostics	97
14.9	Diagnosis → Sensor HP	97
14.10	Diagnosis → Sensor LP	99
14.11	Diagnostic → Diagnostic list	100
14.12	Diagnosis → Event logbook	100
14.13	Diagnosis → Instrument info	101
14.14	Diagnosis → Sens. limit HP	104
14.15	Diagnosis → Sens. limit LP	104
14.16	Diagnosis → Measured Values	105
14.17	Diagnosis → Simulation	107
14.18	Diagnosis → Reset	110
15	Technical data	112
15.1	Input	112
15.2	Output	115
15.3	Performance characteristics of ceramic process isolating diaphragm	118
15.4	Performance characteristics of metallic process isolating diaphragm	123
15.5	Environment	128
15.6	Process	129
15.7	Additional technical data	130
Index		131





1 Document information

1.1 Document function





These Operating Instructions contain all the information that is required in various phases of the life cycle of the device: from product identification, incoming acceptance and storage, to mounting, connection, operation and commissioning through to troubleshooting, maintenance and disposal.

1.2 Symbols used



1.2.1 Safety symbols



Symbol	Meaning
	DANGER! This symbol alerts you to a dangerous situation. Failure to avoid this situation will result in serious or fatal injury.
	WARNING! This symbol alerts you to a dangerous situation. Failure to avoid this situation can result in serious or fatal injury.
	CAUTION! This symbol alerts you to a dangerous situation. Failure to avoid this situation can result in minor or medium injury.
	NOTE! This symbol contains information on procedures and other facts which do not result in personal injury.

1.2.2 Electrical symbols





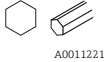



Symbol	Meaning
	Direct current
	Alternating current
	Direct current and alternating current
	Ground connection A grounded terminal which, as far as the operator is concerned, is grounded via a grounding system.
	Protective Earth (PE) A terminal which must be connected to ground prior to establishing any other connections. The ground terminals are situated inside and outside the device: <ul style="list-style-type: none"> ▪ Inner ground terminal: Connects the protective earth to the mains supply. ▪ Outer ground terminal: Connects the device to the plant grounding system.

1.2.3 Tool symbols

Symbol	Meaning
 A0011220	Flat blade screwdriver
 A0011219	Phillips head screwdriver

Symbol	Meaning
 A0011221	Allen key
 A0011222	Open-ended wrench

1.2.4 Symbols for certain types of information

Symbol	Meaning
	Permitted Procedures, processes or actions that are permitted.
	Preferred Procedures, processes or actions that are preferred.
	Forbidden Procedures, processes or actions that are forbidden.
	Tip Indicates additional information.
	Reference to documentation
	Reference to page
	Reference to graphic
	Visual inspection

1.2.5 Symbols in graphics

Symbol	Meaning
1, 2, 3 ...	Item numbers
1., 2., 3. ...	Series of steps
A, B, C, ...	Views
A-A, B-B, C-C, ...	Sections

1.3 Documentation

 The document types listed are available:
In the Download Area of the Endress+Hauser Internet site: www.endress.com → Download

1.3.1 Technical Information (TI): planning aid for your device

TI01033P:

The document contains all the technical data on the device and provides an overview of the accessories and other products that can be ordered for the device.

1.3.2 Brief Operating Instructions (KA): getting the 1st measured value quickly

KA01105P:

The Brief Operating Instructions contain all the essential information from incoming acceptance to initial commissioning.

1.3.3 Description of Device Parameters (GP): reference for your parameters

GP01013P:

The document provides a detailed explanation of each individual parameter in the operating menu. The description is aimed at those who work with the device over the entire life cycle and perform specific configurations.

1.3.4 Safety Instructions (XA)

Safety Instructions (XA) are supplied with the device depending on the approval. These instructions are an integral part of the Operating Instructions.

Device	Directive	Documentation	Option ¹⁾
FMD71, FMD72	ATEX II 1/2G Ex ia IIC T6 Ga/Gb	XA00619P	BA
FMD71, FMD72	ATEX II 1/2G Ex d [ia] IIC T6 Ga/Gb	XA00620P	BC
FMD71, FMD72	ATEX II 3G Ex nA IIC T6 GC	XA00621P	BD
FMD71, FMD72	IEC Ex ia IIC T6 Ga/Gb	XA00622P	IA
FMD71, FMD72	IEC Ex d [ia] IIC T6 Ga/Gb	XA00623P	IB
FMD71, FMD72	CSA General Purpose	-	CD
FMD71, FMD72	NEPSI Ex ia IIC T4/T6 Ga/Gb	XA01352P	NA
FMD71, FMD72	NEPSI Ex d [ia] IIC T4/T6 Ga/Gb	XA01353P	NB
FMD71, FMD72	INMETRO Ex ia IIC T6...T4 Ga/Gb	XA01378P	MA
FMD71, FMD72	INMETRO Ex d [ia] IIC T6...T4 Ga/Gb	XA01379P	MC
FMD71, FMD72	EAC Ga/Gb Ex ia IIC T6...T4	XA01594P	GA
FMD71, FMD72	EAC Ga/Gb Ex d [ia] IIC T6...T4 X	XA01595P	GB
FMD71	FM C/US IS Cl.I Div.1 Gr.A-D, AEx ia, Zone 0,1,2	XA00628P	FA
FMD71	FM C/US XP AIS Cl.I Div.1 Gr.A-D, Exd [ia] Zone 0,1,2	XA00629P	FB
FMD71	CSA C/US XP Cl.I Div.1 Gr.A-D, Ex d [ia], Zone 0,1,2	XA00631P	CB
FMD71	FM C/US NI Cl.I Div.2 Gr.A-D, Zone 2	XA00668P	FD
FMD71	CSA C/US NI, Cl.I Div. 2, Gr.A-D Cl.I, Zone 2, IIC	XA00670P	CC
FMD71	CSA C/US IS Cl.I Div.1 Gr.A-D, Ex ia Zone 0,1,2	XA00630P	CA
FMD72	CSA C/US IS Cl.I Div.1 Gr.A-D, Ex ia Zone 0,1,2	XA00626P	CA
FMD72	CSA C/US XP Cl.I Div.1 Gr.A-D, Ex d [ia], Zone 0,1,2	XA00627P	CB
FMD72	CSA C/US NI, Cl.I Div.2 Gr.A-D, Zone 2	XA00671P	CC
FMD72	FM C/US IS Cl.I Div.1 Gr.A-D, AEx ia, Zone 0,1,2	XA00624P	FA
FMD72	FM C/US XP AIS Cl.I Div.1 Gr.A-D, Exd [ia] Zone 0,1,2	XA00625P	FB
FMD72	FM C/US NI Cl.I Div.2 Gr.A-D, Zone 2	XA00669P	FD

1) Product Configurator order code for "Approval"

 The nameplate provides information on the Safety Instructions (XA) that are relevant for the device.

1.4 Terms and abbreviations

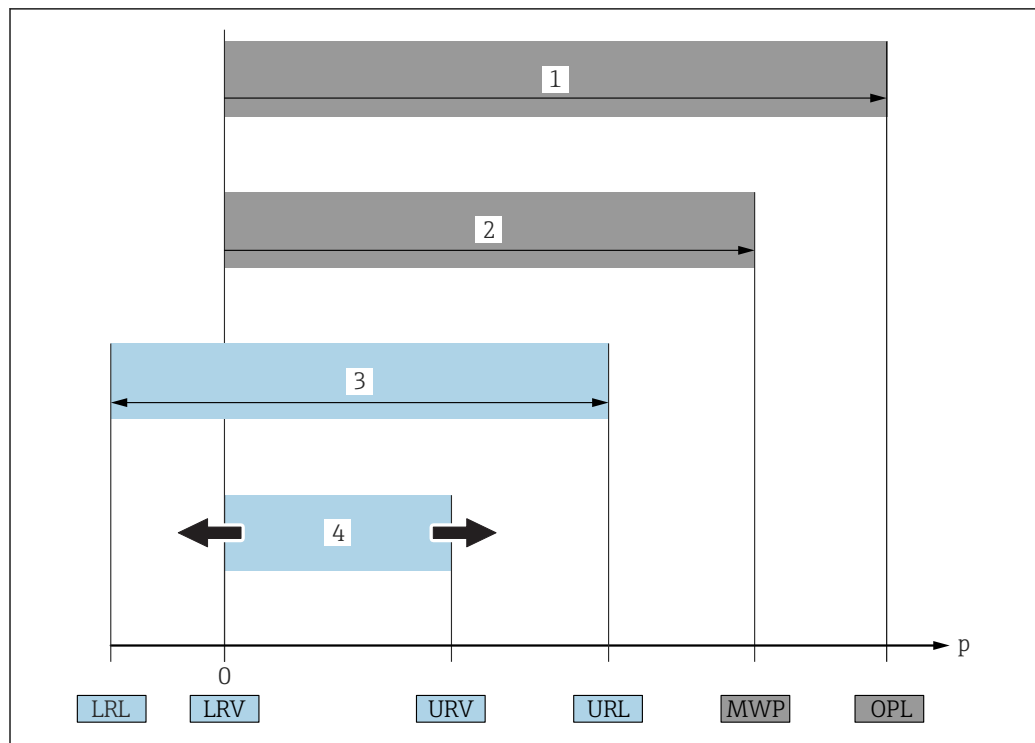

A0029505

Position	Term/ abbreviation	Explanation
1	OPL	The OPL (over pressure limit = sensor overload limit) for the measuring device depends on the lowest-rated element, with regard to pressure, of the selected components, i.e. the process connection has to be taken into consideration in addition to the measuring cell. Also observe pressure-temperature dependency. For the relevant standards and additional notes, see the "Pressure specifications" section → 130. The OPL may only be applied for a limited period of time.
2	MWP	The MWP (maximum working pressure) for the sensors depends on the lowest-rated element, with regard to pressure, of the selected components, i.e. the process connection has to be taken into consideration in addition to the measuring cell. Also observe pressure-temperature dependency. For the relevant standards and additional notes, see the "Pressure specifications" section → 130. The MWP may be applied at the device for an unlimited period. The MWP can also be found on the nameplate.
3	Maximum sensor measuring range	Span between LRL and URL This sensor measuring range is equivalent to the maximum calibratable/ adjustable span.
4	Calibrated/ adjusted span	Span between LRV and URV Factory setting: 0 to URL Other calibrated spans can be ordered as customized spans.
p	-	Pressure
-	LRL	Lower range limit
-	URL	Upper range limit
-	LRV	Lower range value
-	URV	Upper range value
-	TD (Turn down)	Turn down Example - see the following section.

1.5 Turn down calculation

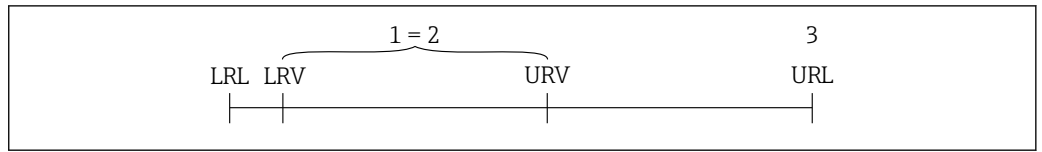

A0029545

- 1 Calibrated/adjusted span
- 2 Zero point-based span
- 3 URL sensor

Example

- Sensor: 10 bar (150 psi)
- Upper range value (URL) = 10 bar (150 psi)
- Lower range value (LRV) = 0 bar (0 psi)
- Upper range value (URV) = 5 bar (75 psi)
- Calibrated/adjusted span: 0 to 5 bar (0 to 75 psi)

Turn down (TD):

$$TD = \frac{URL}{|URV - LRV|}$$

$$TD = \frac{10 \text{ bar (150 psi)}}{|5 \text{ bar (75 psi)} - 0 \text{ bar (0 psi)}|} = 2$$

In this example, the TD is 2:1.
This span is based on the zero point.

1.6 Registered trademarks

1.6.1 HART®

Registered trademark of the FieldComm Group, Austin, USA

2 Basic safety instructions

2.1 Requirements concerning the staff

The personnel for installation, commissioning, diagnostics and maintenance must fulfill the following requirements:

- ▶ Trained, qualified specialists: must have a relevant qualification for this specific function and task
- ▶ Are authorized by the plant owner/operator
- ▶ Are familiar with federal/national regulations
- ▶ Before beginning work, the specialist staff must have read and understood the instructions in the Operating Instructions and supplementary documentation as well as in the certificates (depending on the application)
- ▶ Following instructions and basic conditions

The operating personnel must fulfill the following requirements:

- ▶ Being instructed and authorized according to the requirements of the task by the facility's owner-operator
- ▶ Following the instructions in these Operating Instructions

2.2 Designated use

2.2.1 Application and media

The Deltabar FMD72 is a differential pressure transmitter for measuring differential pressure and level in pressurized tanks. The device has two sensor modules, which measure the operating pressure (High Pressure HP and Low Pressure LP). The differential pressure/hydrostatic level is calculated in the transmitter unit. The sensor signal is transmitted digitally. In addition, sensor temperatures and the individual process pressures present at the respective sensor modules can be individually evaluated and transmitted. If the limit values specified in the "Technical Data" and the conditions listed in the instructions and additional documentation are observed, the measuring device may be used for the following measurements (process variables):

Measured process variables

- Pressure HP and Pressure LP
- Sensor temperature HP and sensor temperature LP
- Transmitter temperature

Calculated process variables

- Differential pressure
- Level (level, volume or mass)

2.2.2 Incorrect use

The manufacturer is not liable for damage caused by improper or non-designated use.

Verification for borderline cases:

- ▶ For special fluids and fluids for cleaning, Endress+Hauser is glad to provide assistance in verifying the corrosion resistance of fluid-wetted materials, but does not accept any warranty or liability.

2.2.3 Residual risks

Due to heat transfer from the process as well as power loss in the electronics, the temperature of the electronics housing and the assemblies contained therein (e.g. display

module, main electronics module and I/O electronics module) may rise up to 80 °C (176 °F). When in operation, the sensor can reach a temperature close to the medium temperature.

Danger of burns from contact with surfaces!

- ▶ For elevated fluid temperature, ensure protection against contact to prevent burns.

2.3 Workplace safety

For work on and with the device:

- ▶ Wear the required personal protective equipment according to federal/national regulations.
- ▶ Switch off the supply voltage before connecting the device.

2.4 Operational safety

Risk of injury!

- ▶ Operate the device in proper technical condition and fail-safe condition only.
- ▶ The operator is responsible for interference-free operation of the device.

Modifications to the device

Unauthorized modifications to the device are not permitted and can lead to unforeseeable dangers.

- ▶ If, despite this, modifications are required, consult with Endress+Hauser.

Repairs

To ensure continued operational safety and reliability,

- ▶ Carry out repairs on the device only if they are expressly permitted.
- ▶ Observe federal/national regulations pertaining to repair of an electrical device.
- ▶ Use original spare parts and accessories from Endress+Hauser only.

Hazardous area

To eliminate danger to persons or the facility when the device is used in the approval-related area (e.g. explosion protection, pressure vessel safety):

- ▶ Check the nameplate to verify if the device ordered can be put to its intended use in the approval-related area.
- ▶ Observe the specifications in the separate supplementary documentation that is an integral part of these Instructions.

2.5 Product safety

This measuring device is designed in accordance with good engineering practice to meet state-of-the-art safety requirements, has been tested, and left the factory in a condition in which it is safe to operate.

It meets general safety standards and legal requirements. It also complies with the EC directives listed in the device-specific EC Declaration of Conformity. Endress+Hauser confirms this by affixing the CE mark to the device.

3 Product description

3.1 Product design

Level measurement (level, volume and mass) with Deltabar:

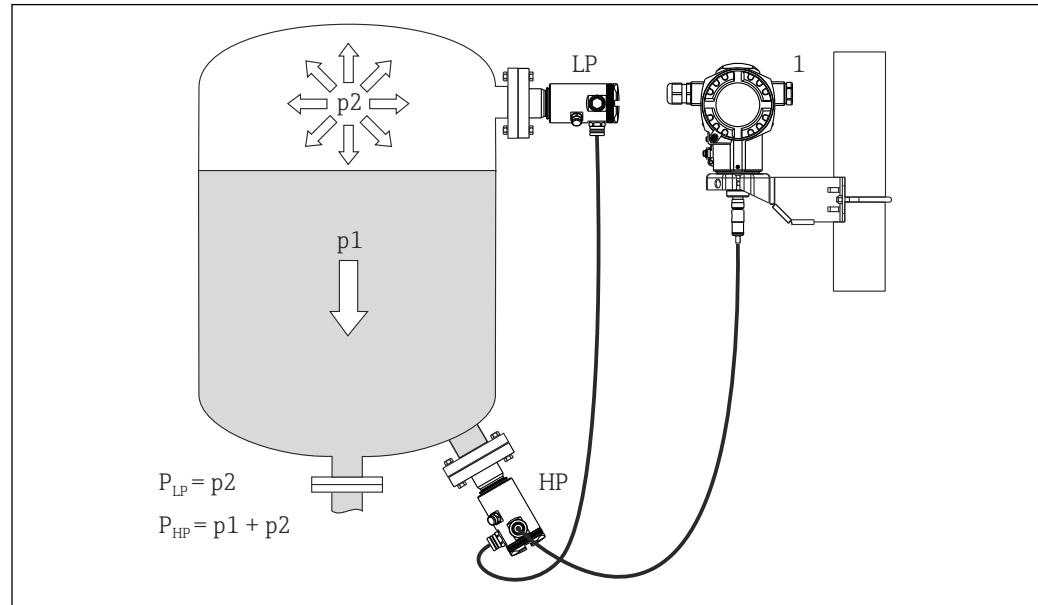

- LP* Sensor module LP (low pressure)
HP Sensor module HP (high pressure)
p2 Head pressure
p1 Hydrostatic pressure
1 Transmitter

The FMD71/FMD72 is best suited to level measurement in vessels with pressure overlay or in vacuum vessels and tanks, high distillation columns and other vessels with changing ambient temperatures.

The sensor module HP is mounted on the lower measuring connection and the sensor module LP is mounted above the maximum level. The transmitter can be mounted on pipes or walls with the mounting bracket.

The sensor signal is transmitted digitally. In addition, sensor temperatures and the individual process pressures present at the respective sensor modules can be individually evaluated and transmitted.

NOTICE

Incorrect sizing/order of sensor modules

- ▶ In a closed system, please note that the sensor module is affected by the superimposed head pressure (p2) in addition to the hydrostatic pressure (p1). This must be taken into account when sizing the sensor module on the high-pressure side (HP).

3.2 Function

3.2.1 Differential pressure generation

The measurement chain for the calculation of the differential pressure can be represented by the following diagram:

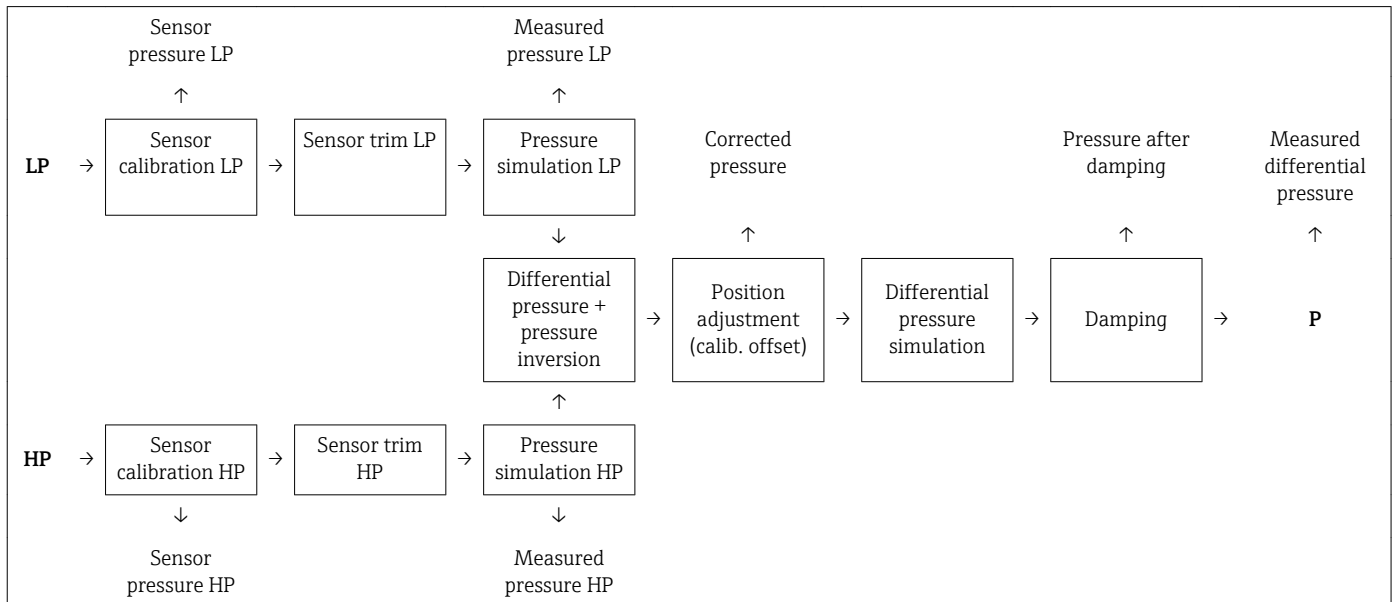

All the process values represented on the diagram are updated in a measurement cycle. The sensor module allocation is determined by the configuration when setting up the device. The connection to the transmitter defines the corresponding sensor module as the master. After commissioning, the second sensor module is detected as the slave. This configuration can be modified as desired. However, a modification must take place with the unit disconnected from the power supply.

The sensor modules have a designation independent of the master/slave configuration. This indicates where the sensor module is typically installed:

- Sensor module LP
LP = Low pressure; top
- Sensor module HP
HP = High pressure; bottom

For identical sensor module ranges, this assignment can likewise be changed, but this then has to be configured in the menu.

 If you change both sensor modules or the electronics, this allocation must likewise be carried out. See the "Transm. connect. (286)" parameter .

4 Incoming acceptance and product identification

4.1 Incoming acceptance

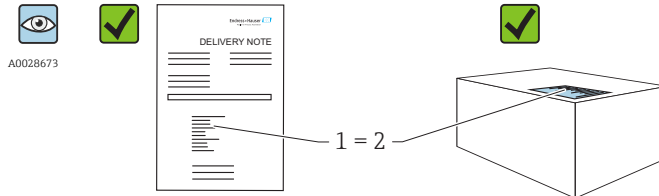

A0016870

Is the order code on the delivery note (1) identical to the order code on the product sticker (2)?

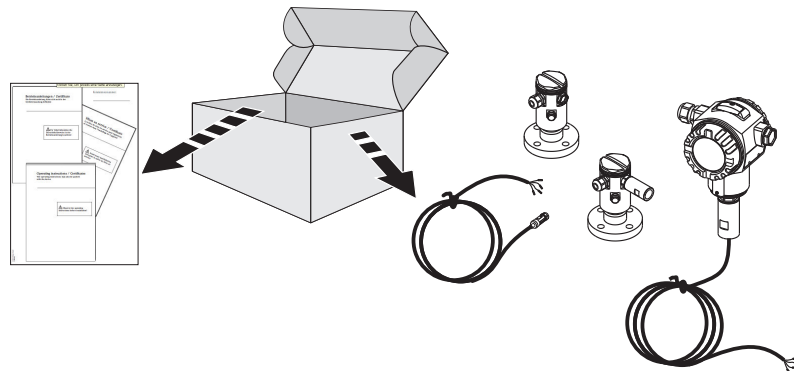

A0016052

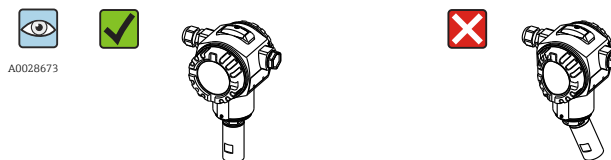

A0016053

Are the goods undamaged?

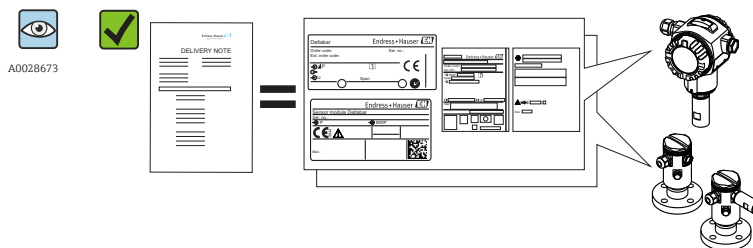

A0016054

Do the data on the nameplate correspond to the order specifications and the delivery note?

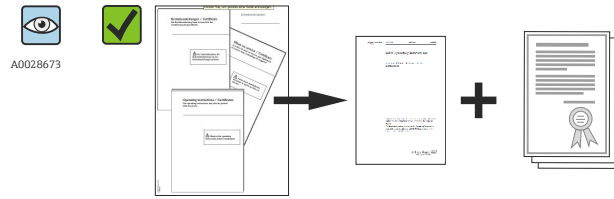

A0022106

Is the documentation provided?
 If required (see nameplate): Are the safety instructions (XA) present?

i If one of these conditions is not fulfilled, please contact your Endress+Hauser sales office.

4.2 Product identification

The following options are available for identification of the measuring device:

- Nameplate specifications
- Order code with breakdown of the device features on the delivery note
- Enter serial numbers from nameplates in *W@M Device Viewer* (www.endress.com/deviceviewer): All information about the measuring device is displayed.

For an overview of the technical documentation provided, enter the serial number from the nameplates in *W@M Device Viewer* (www.endress.com/deviceviewer)

4.2.1 Manufacturer address

Endress+Hauser GmbH+Co. KG
 Hauptstraße 1
 79689 Maulburg, Germany
 Address of the manufacturing plant: See nameplate.

4.3 Nameplates

4.3.1 Nameplates of the T14 transmitter housing

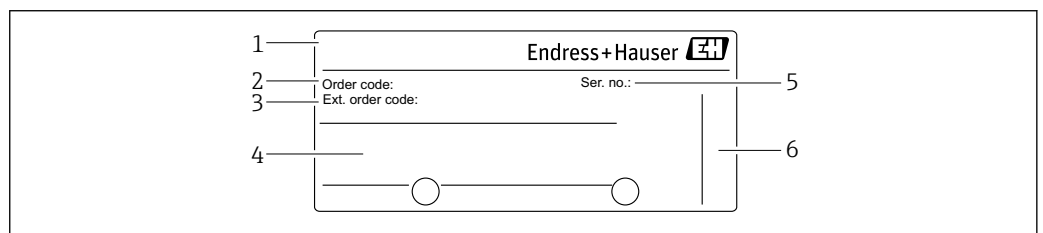

A0016056

- 1 Device name
- 2 Order code (for re-orders)
- 3 Extended order code (complete)
- 4 Technical data
- 5 Serial number (for identification)
- 6 Manufacturer address

Additional nameplate for devices with Ex approval

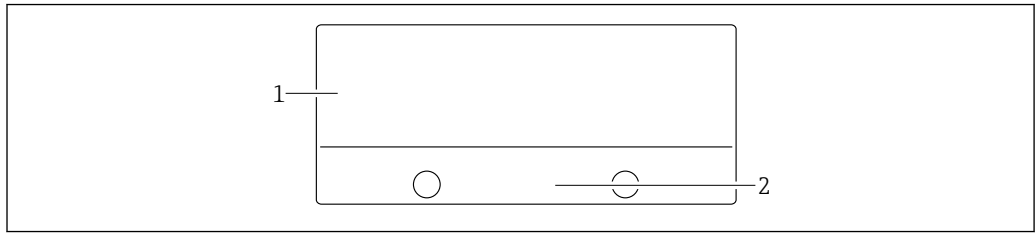

A0021222

- 1 Approval-specific information
- 2 Document number of Safety Instructions or drawing number

Additional nameplate for devices with PVDF process connection

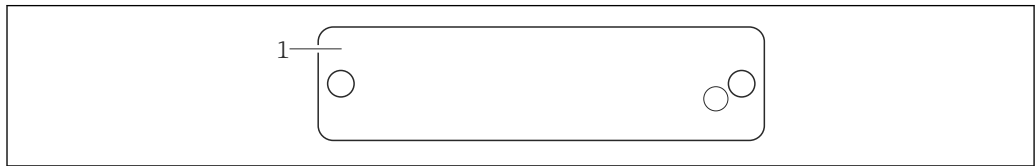

A0022683

- 1 application limits

4.3.2 Nameplates of the T17 transmitter housing

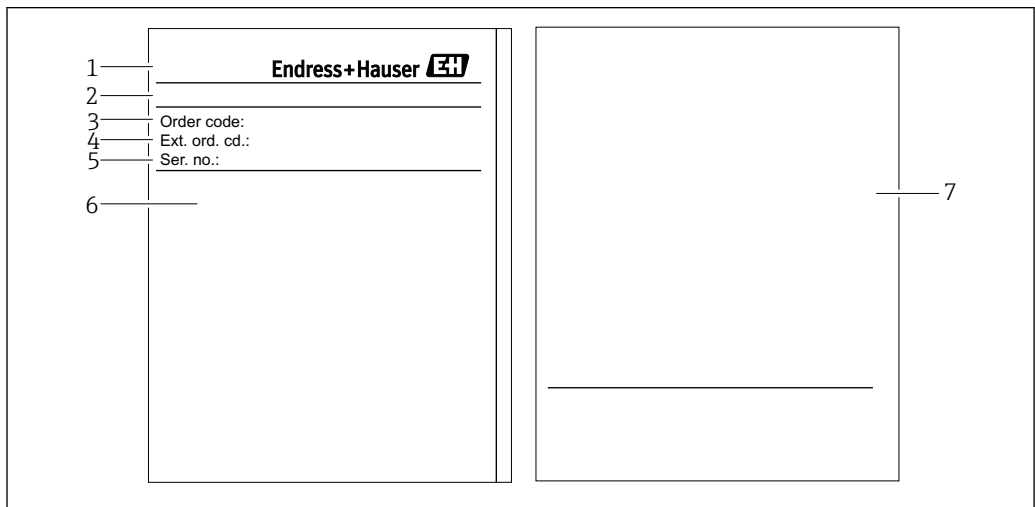

A0021552

- 1 Device name
- 2 Manufacturer address
- 3 Order code (for re-orders)
- 4 Extended order code (complete)
- 5 Serial number (for identification)
- 6 Technical data
- 7 Approval-related information and document number of Safety Instructions or drawing number

4.3.3 Nameplate of the sensor housing

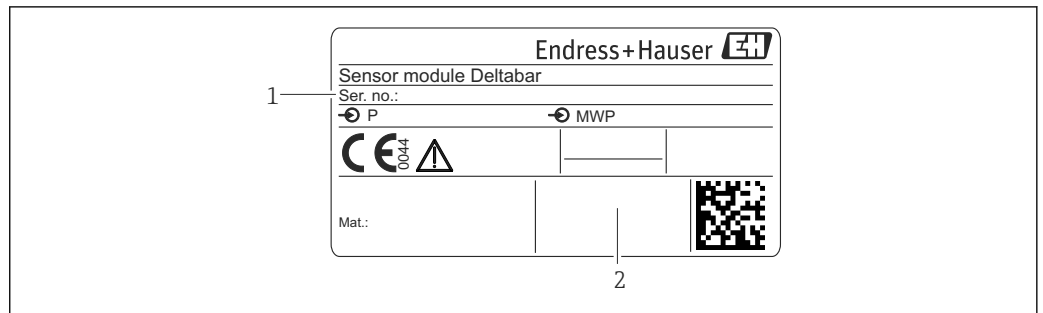

A0021224

- 1 Sensor serial number
- 2 Identification of sensor type (HP/LP)

4.4 Storage and transport

4.4.1 Storage conditions

Use original packaging.

Store the measuring device in clean and dry conditions and protect from damage caused by shocks (EN 837-2).

Storage temperature range

-40 to +80 °C (-40 to +176 °F)

4.4.2 Transporting the product to the measuring point

⚠ WARNING

Incorrect transport!

Housing and diaphragm may become damaged, and there is a risk of injury!

- ▶ Transport the measuring device to the measuring point in its original packaging or by the process connection.
- ▶ Follow the safety instructions and transport conditions for devices weighing more than 18 kg (39.6 lbs).

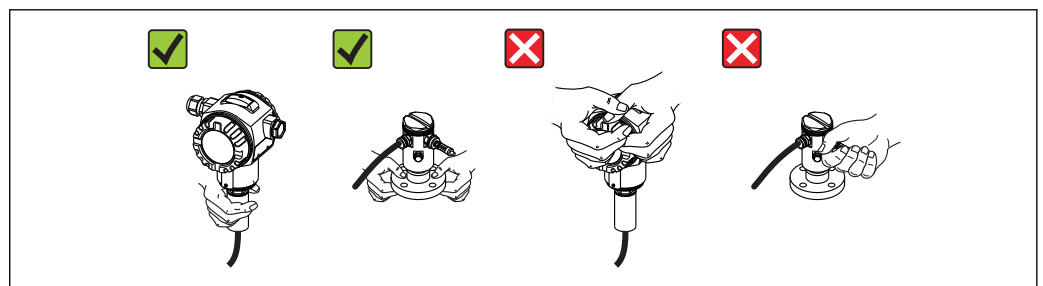

A0016058

5 Installation

- Moisture must not penetrate the housing when mounting the device, establishing the electrical connection and during operation.
- When measuring in media containing solids, such as dirty liquids, installing separators and drain valves is useful for capturing and removing sediment.
- Do not clean or touch process isolating diaphragms with hard and/or pointed objects.
- Do not remove process isolating diaphragm protection until shortly before installation.
- Always firmly tighten the housing cover and the cable entries.
- Point the cable and connector downwards where possible to prevent moisture from entering (e.g. rain or condensation water).

5.1 Mounting dimensions

For dimensions, see the "Mechanical construction" section in the Technical Information.

5.2 Mounting location

The FMD71/FMD72 is best suited to level measurement in vessels with pressure overlay or in vacuum vessels and tanks, high distillation columns and other vessels with changing ambient temperatures.

The sensor module HP is mounted on the lower measuring connection and the sensor module LP is mounted above the maximum level. The transmitter can be mounted on pipes or walls with the mounting bracket.

5.3 Orientation

- Transmitter: Any orientation.
- Sensor modules: The orientation can cause a zero point shift .
This position-dependent zero point shift can be corrected directly at the device via the operating key, and also in hazardous areas in the case of devices with external operation (position adjustment).

5.4 General installation instructions

Mounting the sensor modules and transmitter is very easy

- The housings of the sensor modules can be rotated up to 360°.
- The transmitter is freely rotatable in the mounting bracket.

The sensor modules and transmitter can be easily aligned when mounted.

Your benefits

- Easy mounting due to optimum alignment of housing
- Easily accessible device operation
- Optimum readability of the onsite display (optional)
- Easy pipe installation due to optional alignment of the modules.

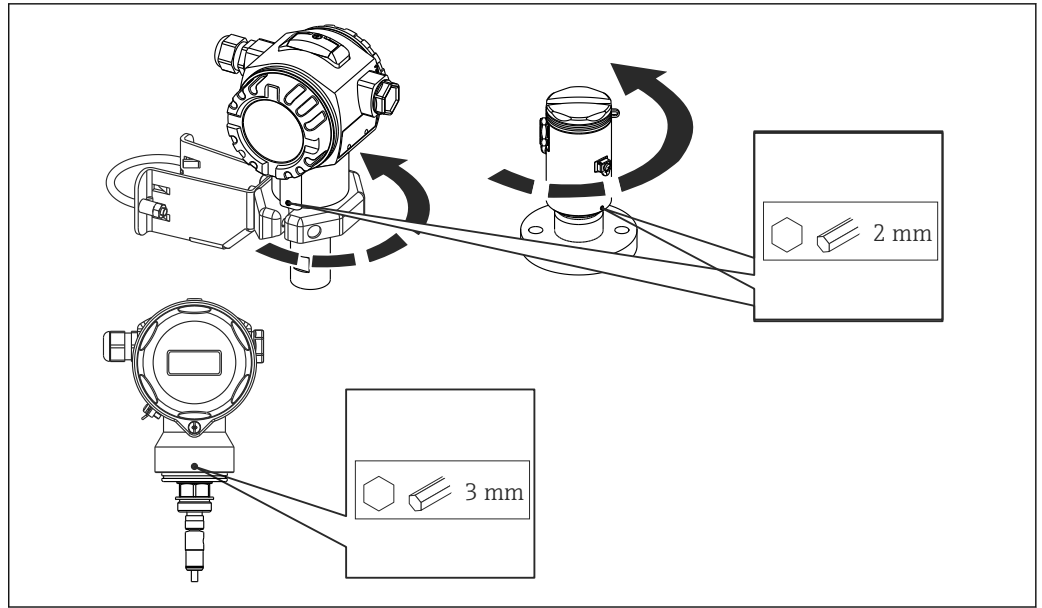

A0017506

5.5 Thermal insulation - FMD71 high-temperature version

The FMD71 high-temperature version may only be insulated up to a certain height. The maximum permitted insulation height is indicated on the devices and applies to an insulation material with a heat conductivity $\leq 0.04 \text{ W}/(\text{m} \times \text{K})$ and to the maximum permitted ambient and process temperature. The insulation height is not indicated on hygienic connections.

- Ambient temperature (T_A): $\leq 70 \text{ }^\circ\text{C}$ (158 °F)
- Process temperature (T_P): $\leq 150 \text{ }^\circ\text{C}$ (302 °F)

The data were determined under the most critical application "quiescent air".

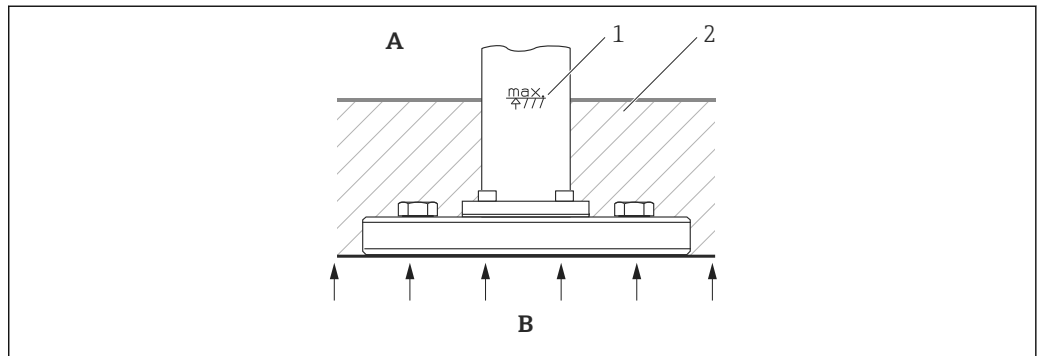

A0021075

- A Ambient temperature
- B Process temperature
- 1 Insulation height
- 2 Insulation material

5.6 Installing the sensor modules

5.6.1 General installation instructions

- The nameplate on the sensor module specifies where the sensor module is typically installed:
HP (bottom)
LP (top)
For further information, see the "Function" section → [13](#).
- Due to the orientation of the sensor modules, there may be a shift in the zero point, i.e. when the vessel is empty or partially full, the measured value does not display zero. You can correct this zero point shift: see the "Commissioning without an operating menu" → [42](#) or the "Position adjustment" → [47](#) section.
- Always install the sensor module HP below the lowest measuring point.
- Always install the sensor module LP above the highest measuring point.
- Do not mount the sensor modules in the filling curtain or at a point in the tank which could be affected by pressure pulses from an agitator.
- Do not mount the sensor modules in the suction area of a pump.
- The adjustment and functional test can be carried out more easily if you mount the sensor modules downstream of a shutoff device.
- If a heated sensor module is cooled during the cleaning process (e.g. by cold water), a vacuum develops for a short time, whereby moisture can penetrate the sensor through the pressure compensation (3). If this is the case, mount the sensor with the pressure compensation (3) pointing downwards.
- Keep the pressure compensation and GORE-TEX® filter (3) free from contamination.
- Do not clean or touch process isolating diaphragms with hard or pointed objects.

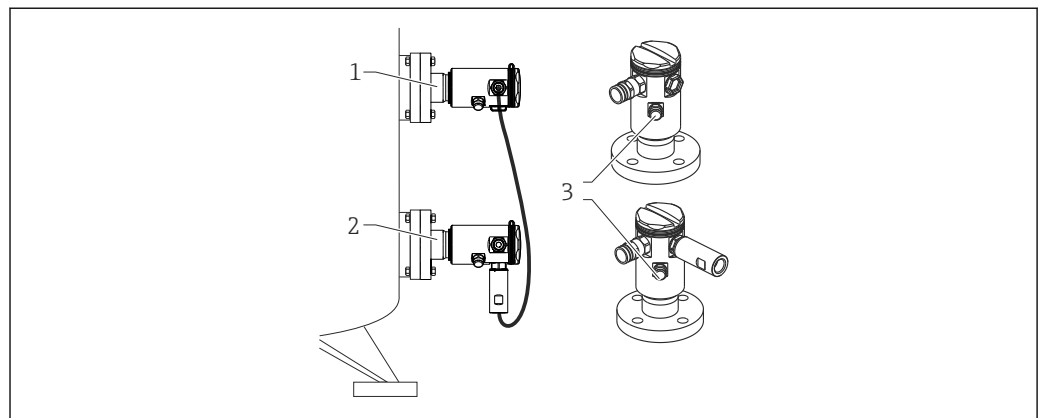

A0017512

5.7 Mounting sensor modules with PVDF installation coupling

⚠ WARNING

Risk of damage to process connection!

Risk of injury!

- ▶ Sensor modules with PVDF process connections with threaded connection must be installed with the mounting bracket provided!

⚠ WARNING**Material fatigue from pressure and temperature!**

Risk of injury due to bursting of parts! The thread can become loose if exposed to high pressure and temperature loads.

- ▶ The integrity of the thread must be checked regularly and the thread may need to be retightened with the maximum tightening torque of 7 Nm (5.16 lbf ft). Teflon tape is recommended for sealing the 1/2" NPT thread.

The mounting bracket can be installed on pipes with a diameter of 1 1/4" to 2" or on walls.

In the case of pipe mounting, the nuts on the bracket must be tightened uniformly with a torque of at least 5 Nm (3.69 lbf ft).

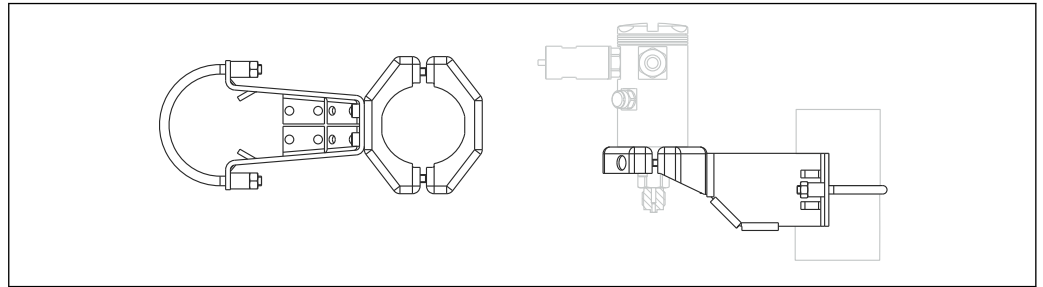

A0017514

- The mounting bracket is included in the delivery.
- Ordering information:
Product Configurator order code for "Enclosed accessories", option "PA" or as a separate accessory (part no.: 71102216).

5.8 Installing the transmitter

The transmitter is installed with the mounting bracket supplied. The mounting bracket can be installed on pipes with a diameter of 1 1/4" to 2" or on walls.

In the case of pipe mounting, the nuts on the bracket must be tightened uniformly with a torque of at least 5 Nm (3.69 lbf ft).

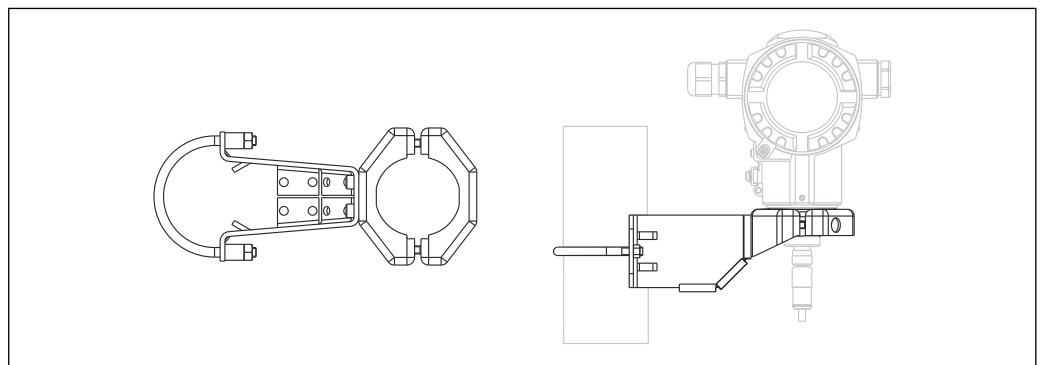

A0021145

The mounting bracket is included in the delivery.

5.8.1 Turning the display module

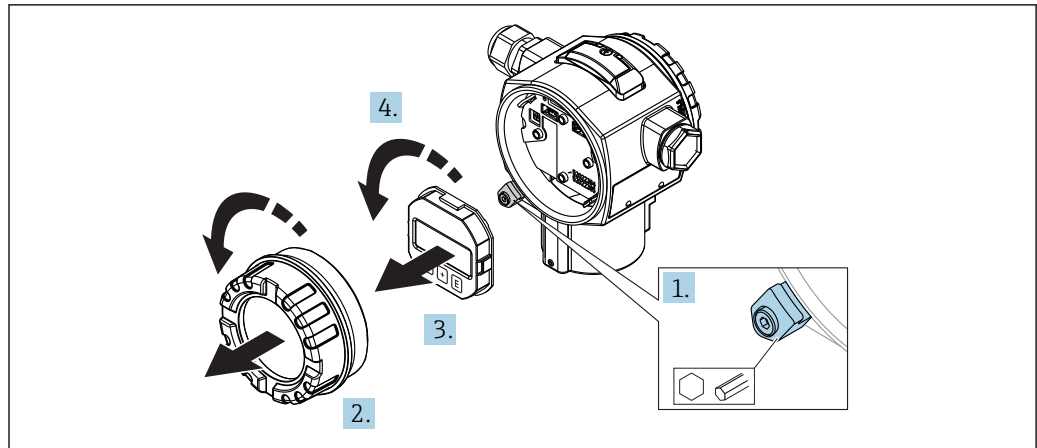

A0017524

⚠ WARNING

Supply voltage switched off?

Risk of electric shock and/or explosion!

- ▶ Switch off the supply voltage before connecting the device.

1. If present (i.e. in devices with Ex d and Ex na approval), release the securing clamp of the electronics compartment cover with an Allen key.
2. Unscrew the electronics compartment cover from the transmitter housing.
3. Pull out the display module with a gentle rotational movement.
4. Rotate the display module into the desired position: max. $4 \times 90^\circ$ in each direction.
5. Fit the display module on the electronics compartment in the desired position until it clicks into place.
6. Screw the electronics compartment cover back onto the transmitter housing.
7. If present (i.e. in devices with Ex d and Ex na approval), tighten the securing clamp with an Allen key (1 Nm (0.225 lbf)).

5.9 Closing the housing cover

NOTICE

The housing cover can no longer be closed.

Damaged thread!

- ▶ When closing the housing cover, please ensure that the thread of the cover and housing are free from dirt, e.g. sand. If you feel any resistance when closing the cover, check the thread on both again to ensure that they are free from dirt.

5.9.1 Closing the covers on the hygienic stainless steel housing (T17)

The covers for the terminal compartment and electronics compartment are hooked into the housing and closed with a screw in each case. These screws must be tightened finger-tight (2 Nm (1.48 lbf ft)) to the stop to ensure that the covers are securely seated and leak-tight.

5.10 Seal for flange mounting

NOTICE

Distorted measurement results.

The seal is not allowed to press against the process isolating diaphragm as this could affect the measurement result.

- ▶ Ensure that the seal is not touching the process isolating diaphragm.

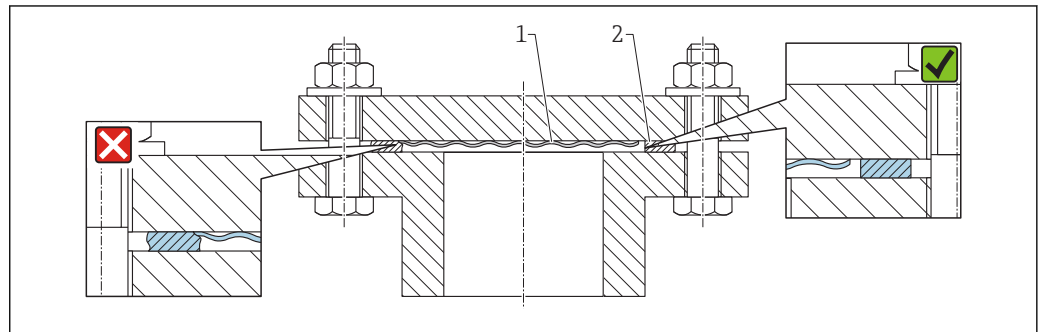

- 1 Process isolating diaphragm
- 2 Seal

5.11 Post-installation check

<input type="checkbox"/>	Is the device undamaged (visual inspection)?
<input type="checkbox"/>	Does the device comply with the measuring point specifications? For example: <ul style="list-style-type: none"> ▪ Process temperature ▪ Process pressure ▪ Ambient temperature ▪ Measuring range
<input type="checkbox"/>	Are the measuring point identification and labeling correct (visual inspection)?
<input type="checkbox"/>	Is the device adequately protected against precipitation and direct sunlight?
<input type="checkbox"/>	Are the securing screw and securing clamp tightened securely?

6 Electrical connection

⚠ WARNING

If the operating voltage is > 35 VDC: Dangerous contact voltage at terminals.
Risk of electric shock!

- ▶ In a wet environment, do not open the cover if voltage is present.

i The sensor modules have a designation independent of the master/slave configuration. This indicates where the sensor module is typically installed:

- Sensor module LP
LP = Low pressure; top
- Sensor module HP
HP = High pressure; bottom

For further information, see the "Function" section →  13.

6.1 Connecting the sensor module LP to the sensor module HP

⚠ WARNING

Supply voltage might be connected!
Risk of electric shock and/or explosion!

- ▶ Switch off the supply voltage before connecting the device.
- Screw on the housing cover of the terminal compartment of the sensor module LP.
- Guide the cable of the sensor module HP through the cable gland of the sensor module LP. Use the shielded 4-wire cable that is provided. The wire ends are color-coded to match the corresponding terminal.
- Connect device in accordance with the following diagrams.
- Screw down housing cover.

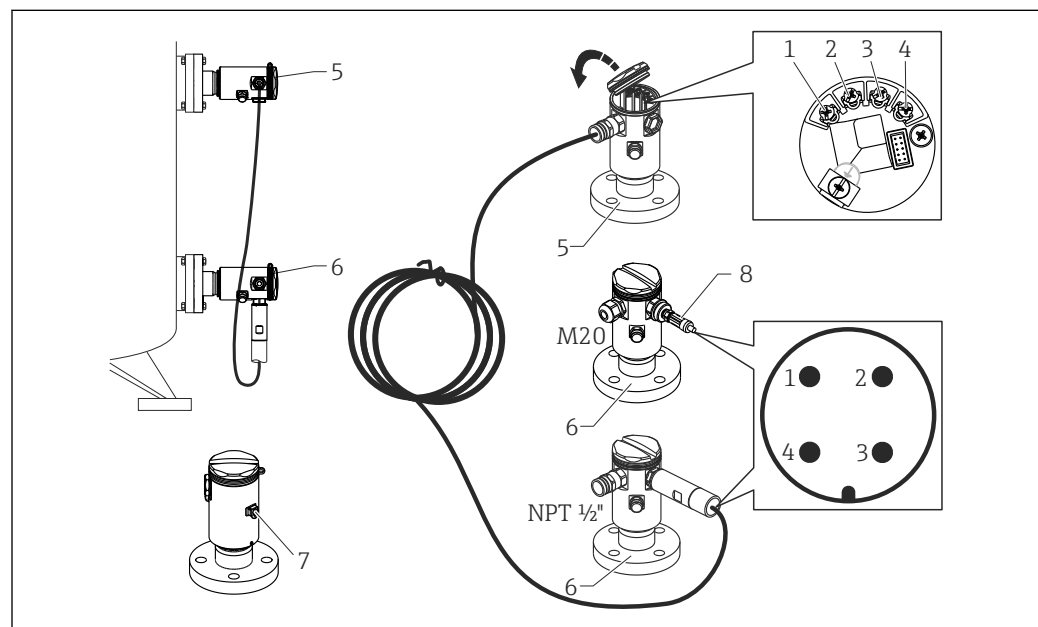

- 1 BK (black)
- 2 BU (blue)
- 3 WH (white)
- 4 BN (brown)
- 5 Sensor module LP
- 6 Sensor module HP
- 7 Ground terminal
- 8 Torque 0.4 Nm

A0017528

6.1.1 Screening with cable shield

Screening with cable shield is described in the associated documentation SD00354P. The documentation is provided with the connecting cables.

6.2 Connecting the sensor module HP to the transmitter

⚠ WARNING

Supply voltage might be connected!

Risk of electric shock and/or explosion!

► Switch off the supply voltage before connecting the device.

- Screw on the housing cover of the terminal compartment of the sensor module HP.
- Guide the cable of the transmitter through the cable gland of the sensor module HP. Use the shielded 4-wire cable that is provided. The wire ends are color-coded to match the corresponding terminal.
- Connect device in accordance with the following diagram.
- Screw down housing cover.

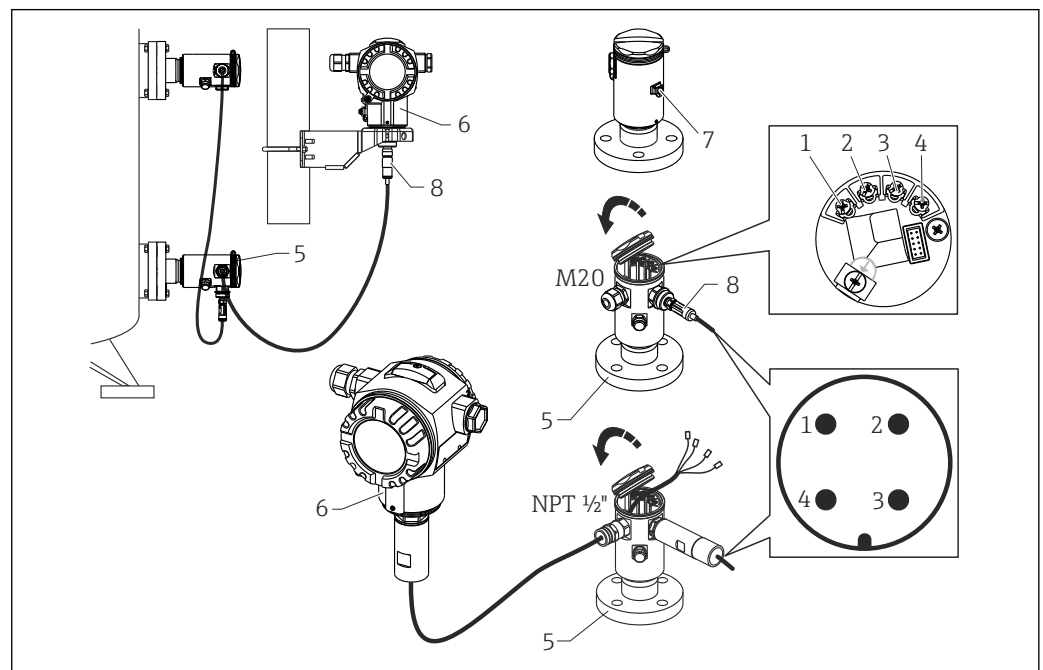

A0017529

- 1 BK (black)
- 2 BU (blue)
- 3 WH (white)
- 4 BN (brown)
- 5 Sensor module HP
- 6 Transmitter
- 7 Ground terminal
- 8 Torque 0.4 Nm

6.2.1 Screening with cable shield

Screening with cable shield is described in the associated documentation SD00354P. The documentation is provided with the connecting cables.

6.3 Connecting the measuring unit

6.3.1 Terminal assignment

⚠ WARNING

Supply voltage might be connected!

Risk of electric shock and/or explosion!

- ▶ Switch off the supply voltage before connecting the device.

⚠ WARNING

Electrical safety is compromised by an incorrect connection!

- ▶ In accordance with IEC/EN61010 a separate circuit breaker must be provided for the device .
- ▶ When using the measuring device in hazardous areas, installation must comply with the corresponding national standards and regulations and the Safety Instructions or Installation or Control Drawings.
- ▶ All explosion protection data are given in separate documentation which is available upon request. The Ex documentation is supplied as standard with all devices approved for use in explosion hazardous areas.
- ▶ Devices with integrated overvoltage protection must be grounded.
- ▶ Protective circuits against reverse polarity, HF influences and overvoltage peaks are integrated.

Connect the device in the following order:

1. Check whether the supply voltage matches the supply voltage indicated on the nameplate.
2. Remove the housing cover.
3. Guide cable through the gland.
4. Connect device in accordance with the following diagram.
5. Screw down housing cover.

Switch on supply voltage.

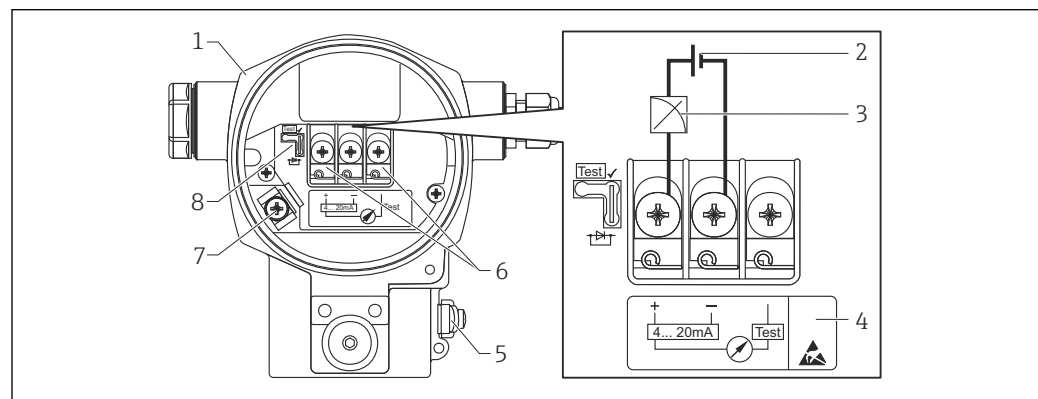

A0019989

- 1 Housing
- 2 Supply voltage
- 3 4 to 20 mA
- 4 Devices with integrated overvoltage protection are labeled "OVP" (overvoltage protection) here.
- 5 External ground terminal
- 6 4 to 20 mA test signal between positive and test terminal
- 7 Internal ground terminal, minimum supply voltage = 12 V DC, jumper is set as illustrated in the diagram.
- 8 Jumper for 4 to 20 mA test signal,

6.3.2 Supply voltage

⚠ WARNING

Supply voltage might be connected!

Risk of electric shock and/or explosion!

- ▶ When using the measuring device in hazardous areas, installation must comply with the corresponding national standards and regulations as well as the Safety Instructions.
- ▶ All explosion protection data are given in separate documentation which is available upon request. The Ex documentation is supplied as standard with all devices approved for use in explosion hazardous areas.

Electronic version	Jumper for 4 to 20 mA test signal in "Test" position (delivery status)	Jumper for 4 to 20 mA test signal in "Non-test" position
4 to 20 mA HART, version for non-hazardous areas	13 to 45 V DC	12 to 45 V DC

Measuring a 4 to 20 mA test signal

A 4 to 20 mA test signal may be measured via the positive and test terminal without interrupting the measurement. The minimum supply voltage of the device can be reduced by simply changing the position of the jumper. As a result, operation is also possible with a lower supply voltage. To keep the measured error below 0.1 %, the current measuring device should exhibit an internal resistance of <0.7Ω. Observe the position of the jumper in accordance with the following table.

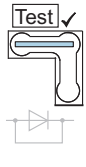
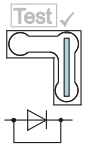
Jumper position for test signal	Description
 <p style="text-align: right; font-size: small;">A0019992</p>	<ul style="list-style-type: none"> ▪ Measurement of 4 to 20 mA test signal via the positive and test terminal: possible. (Thus, the output current can be measured without interruption via the diode.) ▪ Delivery status ▪ Minimum supply voltage: 13 V DC
 <p style="text-align: right; font-size: small;">A0019993</p>	<ul style="list-style-type: none"> ▪ Measurement of 4 to 20 mA test signal via positive and test terminal: not possible. ▪ Minimum supply voltage: 12 V DC

6.4 Connection conditions

6.4.1 Cable specification

Preferably use twisted, screened two-wire cable.

6.4.2 Cable specification for transmitter connection

- Endress+Hauser recommends using twisted, shielded two-wire cables.
- Terminals for core cross-sections 0.5 to 2.5 mm² (20 to 14 AWG)
- The cable outer diameter depends on the cable entry used.

6.4.3 Cable entries

Explosion protection	Cable gland	Permitted cable diameter	Permitted wire cross-sections
<ul style="list-style-type: none"> ▪ Standard ▪ Ex ia ▪ Ex ic 	Plastic M20x1.5	5 to 10 mm (0.2 to 0.39 in)	0.5 to 2.5 mm ² (20 to 14 AWG)
<ul style="list-style-type: none"> ▪ Ex tD ▪ Ex nA ▪ FM approval ▪ CSA approval 	Metal M20 x 1.5	7 to 10.5 mm (0.28 to 0.41 in)	

6.4.4 Overvoltage protection

Standard version

The standard version of the pressure instruments does not contain any special elements to protect against overvoltage ("wire to ground"). Nevertheless the requirements of the applicable EMC standard EN 61000-4-5 (testing voltage 1kV EMC wire/ground) are met.

Optional overvoltage protection

Devices showing version "NA" in feature 610 "Accessory Mounted" in the order code are equipped with overvoltage protection.

- Overvoltage protection:
 - Nominal functioning DC voltage: 600 V
 - Nominal discharge current: 10 kA
- Surge current check $\hat{i} = 20$ kA satisfied as per DIN EN 60079-14: 8/20 μ s
- Arrester AC current check $I = 10$ A satisfied

NOTICE

Device could be destroyed!

- ▶ Devices with integrated overvoltage protection must be grounded.

6.5 Connection data

6.5.1 Maximum load

In order to guarantee sufficient terminal voltage in two-wire devices, a maximum load resistance R (including line resistance) must not be exceeded depending on the supply voltage U_0 of the supply unit.

In the following load diagrams, observe the position of the jumper and the explosion protection:

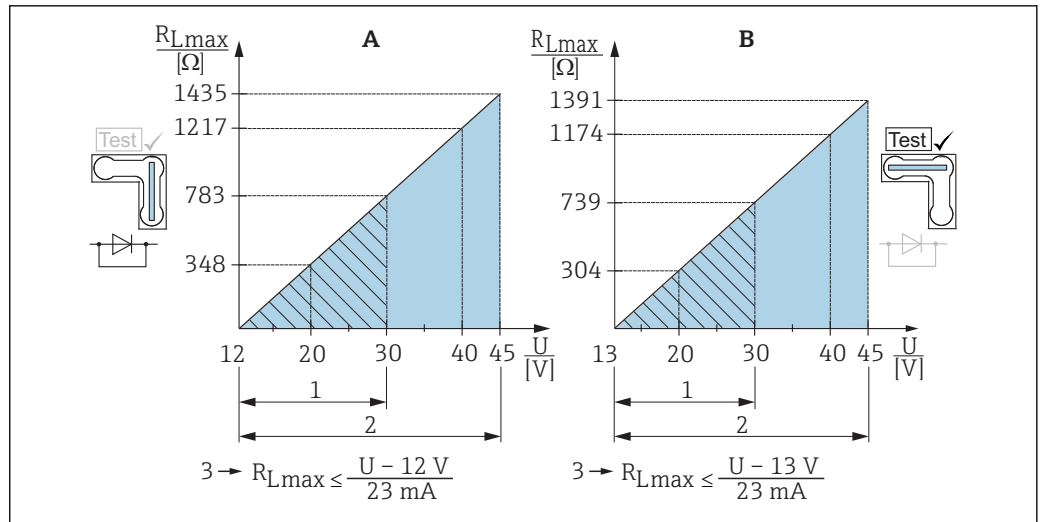

- A Jumper for 4 to 20 mA test signal set to "Non-test" position
- B Jumper for 4 to 20 mA test signal set to "Test" position
- 1 Power supply for II 1/2 G Ex ia, FM IS, CSA IS
- 2 Power supply for devices for the non-hazardous area, 2 G Ex d, 3 G Ex nA, FM XP, FM NI, CSA XP, CSA dust ignition-proof
- 3 R_{Lmax} maximum load resistance
- U Supply voltage

i When operating via a handheld terminal or via a PC with an operating program, a minimum communication resistance of 250 Ω must be taken into account.

6.5.2 Shielding

You achieve optimum shielding against disturbances if the shielding is connected on both sides (in the cabinet and on the device). If potential equalization currents are expected in the plant, only ground shielding on one side, preferably at the transmitter.

When using in hazardous areas, you must observe the applicable regulations. Separate Ex documentation with additional technical data and instructions is included with all Ex systems as standard.

6.6 Post-connection check

<input type="checkbox"/>	Is the device or cable undamaged (visual inspection)?
<input type="checkbox"/>	Do the cables comply with the requirements?
<input type="checkbox"/>	Do the mounted cables have adequate strain relief?
<input type="checkbox"/>	Are all the cable glands installed, tightened and sealed?
<input type="checkbox"/>	Does the supply voltage match the specifications on the nameplate?
<input type="checkbox"/>	Is the terminal assignment correct ?
<input type="checkbox"/>	If required: Has protective ground connection been established?
<input type="checkbox"/>	If supply voltage is present, is the device ready for operation and do values appear on the display module?
<input type="checkbox"/>	Are all the housing covers installed and tightened?
<input type="checkbox"/>	Is the securing clamp tightened correctly?

7 Operation options

7.1 Operation without operating menu

7.1.1 Position of operating elements

Operating keys on the exterior of the device

With the T14 housing (aluminum or stainless steel), the operating keys are located either outside of the housing, under the protection cap or inside on the electronic insert. In addition, devices with an onsite display and a 4 to 20 mA HART electronic insert have operating keys on the onsite display.

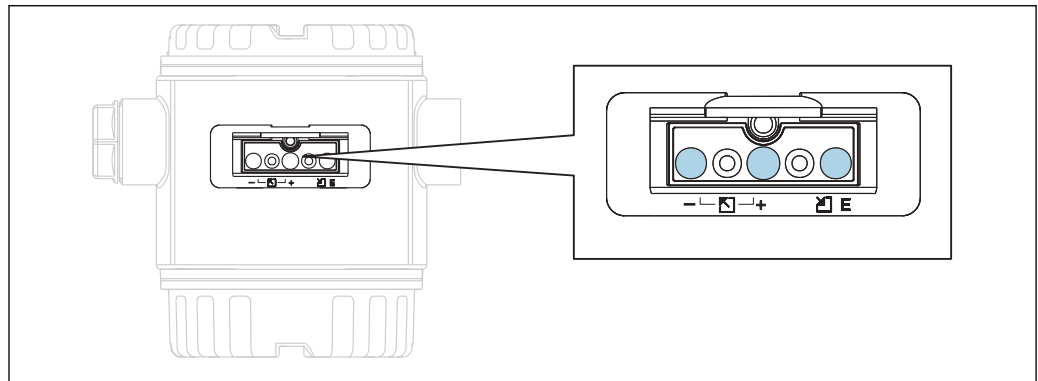

A0016499

The operating keys on the outside of the device make it unnecessary to open the housing. This guarantees:

- Complete protection against environmental influences such as moisture and contamination
- Simple operation without any tools
- No wear.

Operating keys and elements located internally on the electronic insert

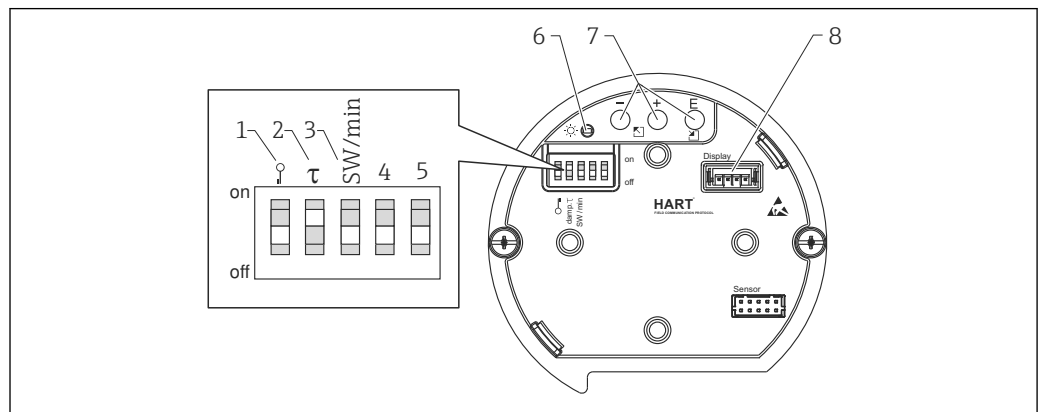

A0016500











- 1 DIP switch for locking/unlocking parameters relevant to the measured value
- 2 DIP switch for switching damping on/off
- 3 DIP switch for alarm current SW/Alarm min (3.6 mA)
- 4...5 Not assigned
- 6 Green LED to indicate value being accepted
- 7 Operating keys
- 8 Slot for optional display

Function of the DIP switches

Switch	Symbol/ labeling	Switch position	
		"off"	"on"
1	 A0011978	The device is unlocked. Parameters relevant to the measured value can be modified.	The device is locked. Parameters relevant to the measured value cannot be modified.
2	damping τ	Damping is switched off. The output signal follows measured value changes without any delay.	Damping is switched on. The output signal follows measured value changes with the delay time τ . ¹⁾
3	SW/Alarm min	The alarm current is defined by the setting in the operating menu. ("Setup" → "Extended setup" → "Current output" → "Output fail mode") ²⁾	The alarm current is 3.6 mA (min), regardless of the setting in the operating menu.

- 1) The value for the delay time can be configured via the operating menu ("Setup" → "Damping"). Factory setting: $\tau = 2$ s or as per order specifications.
- 2) Factory setting: 22 mA

Function of the operating elements

	Operating key(s)	Meaning
 A0017535	Press for at least 3 seconds	Adopt lower range value. A reference pressure is present at the device. For a detailed description, see also "Pressure measuring mode" section, →  42 or "Level measuring mode" →  43 section.
 A0017536	Press for at least 3 seconds	Adopt upper range value. A reference pressure is present at the device. For a detailed description, see also "Pressure measuring mode" section, →  42 or "Level measuring mode" →  43 section.
 A0017537	Press for at least 3 seconds	Position adjustment
 and  and  A0017535 A0017536 A0017537	Press for at least 6 seconds	Reset all parameters. The reset via operating keys corresponds to the software reset code 7864.

7.2 Operation with an operating menu

7.2.1 Operation concept

Operation with an operating menu is based on an operation concept with "user roles" .

User role	Meaning
Operator	Operators are responsible for the devices during normal "operation". This is usually limited to reading process values either directly at the device or in a control room. If the work with the devices extends beyond value read-off tasks, the tasks involve simple, applicationspecific functions that are used in operation. Should an error occur, these users simply forward the information on the errors but do not intervene themselves.
Maintenance	Service engineers usually work with the devices in the phases following device commissioning. They are primarily involved in maintenance and troubleshooting activities for which simple settings have to be made at the device. Technicians work with the devices over the entire life cycle of the product. Thus, commissioning and advanced settings and configurations are some of the tasks they have to carry out.
Expert	Experts work with the devices over the entire life cycle of the device, but, at times, have high device requirements. Individual parameters/functions from the overall functionality of the devices are required for this purpose time and again. In addition to technical, process-oriented tasks, experts can also perform administrative tasks (e.g. user administration). "Experts" can access the entire parameter set.

7.3 Structure of the operating menu

User role	Submenu	Meaning/use
Operator	Language	Only consists of the "Language" parameter (000) where the operating language for the device is specified. The language can always be changed even if the device is locked.
Operator	Display/ operat.	Contains parameters that are needed to configure the measured value display (selecting the values displayed, display format, display contrast, etc.). With this submenu, users can change the measured value display without affecting the actual measurement.
Maintenance	Setup	Contains all the parameters that are needed to commission measuring operations. This submenu has the following structure: <ul style="list-style-type: none"> ▪ Standard setup parameters A wide range of parameters, which can be used to configure a typical application, is available at the start. The measuring mode selected determines which parameters are available. After making settings for all these parameters, the measuring operation should be completely configured in the majority of cases. ▪ "Extended setup" submenu The "Extended setup" submenu contains additional parameters for more indepth configuration of the measurement operation to convert the measured value and to scale the output signal. This menu is split into additional submenus depending on the measuring mode selected.

User role	Submenu	Meaning/use
Maintenance	Diagnosis	<p>Contains all the parameters that are needed to detect and analyze operating errors. This submenu has the following structure:</p> <ul style="list-style-type: none"> ▪ Diagnostic list Contains up to 10 error messages currently pending. ▪ Event logbook Contains the last 10 error messages (no longer pending). ▪ Instrument info Contains information on the device identification. ▪ Measured values Contains all the current measured values ▪ Simulation Is used to simulate pressure, level, current and alarm/warning. ▪ Reset ▪ Sensor LP ▪ Sensor HP
Expert	Expert	<p>Contains all the parameters of the device (including those in one of the submenus). The "Expert" submenu is structured by the function blocks of the device. It thus contains the following submenus:</p> <ul style="list-style-type: none"> ▪ System Contains all the device parameters that neither affect measurement nor integration into a distributed control system. ▪ Measurement Contains all the parameters for configuring the measurement. ▪ Output Contains all the parameters for configuring the current output. ▪ Communication contains all parameters for configuring the HART interface. ▪ Diagnosis Contains all the parameters that are needed to detect and analyze operating errors.

7.4 Operating options

7.4.1 Local operation

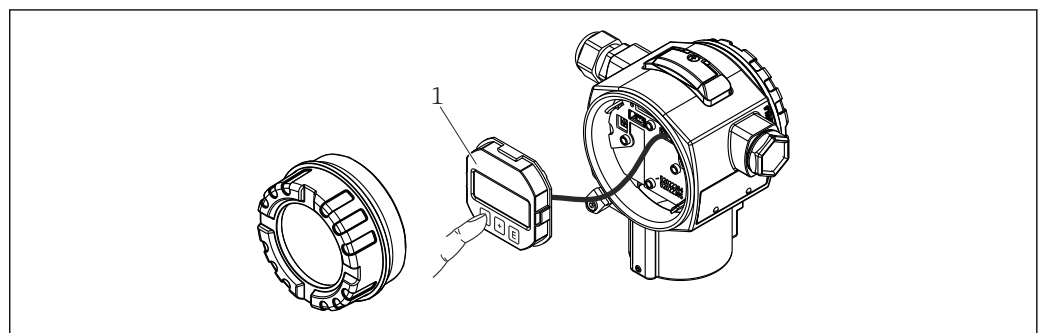

1 Display and operating module with push buttons. Cover must be opened for operation.

7.5 Operating the device using onsite display (optional)

A 4-line liquid crystal display (LCD) is used for display and operation. The onsite display shows measured values, dialog text as well as fault and notice messages in plain text, thereby supporting the user in every stage of operation.

The display can be removed for easy operation.

The device display can be turned in 90° steps.

Depending on the installation position of the device, this makes it easy to operate the device and read the measured value.

Functions:

- 8-digit measured value display including sign and decimal point, bargraph for 4 to 20 mA HART as current display.
- Simple and complete menu guidance due to breakdown of parameters into several levels and groups.
- Each parameter is given a 3-digit ID number for easy navigation.
- Option for configuring the display according to individual requirements and preferences, such as language, alternating display, display of other measured values such as sensor temperature, contrast setting.
- Comprehensive diagnostic functions (fault and warning message, peak-hold indicators, etc.).
- Quick and safe commissioning

7.5.1 Overview

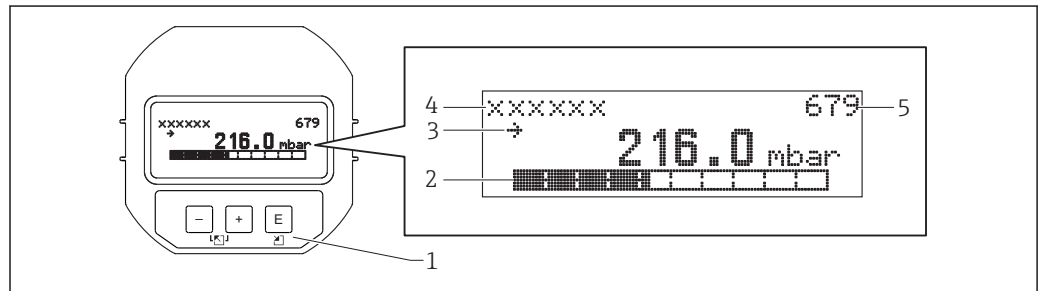

A0016498

- 1 Operating keys
- 2 Bargraph
- 3 Symbol
- 4 Header
- 5 Parameter ID number

7.5.2 Setting the contrast on the display module

- **+** and **⏏** (press simultaneously): increases the contrast.
- **-** and **⏏** (press simultaneously): decreases the contrast.

7.5.3 Symbols on the onsite display

The following tables show the icons that can be used on the local display. Four symbols may appear at the same time.

Error symbols

Symbol	Meaning
S <small>A0012088</small>	Error message "Out of specification" The device is being operated outside its technical specifications (e.g. during startup or cleaning).
C <small>A0012100</small>	Error message "Service mode" The device is in service mode (e.g. during a simulation).
M <small>A0012101</small>	Error message "Maintenance required" Maintenance is required. The measured value remains valid.
F <small>A0012086</small>	Error message "Failure detected" An operating error has occurred. The measured value is no longer valid.

Display symbols for locking status









Symbol	Meaning
	Lock symbol The operation of the device is locked. To unlock device, see "Unlocking/locking configuration" section →  42.

Display symbols for communication

Symbol	Meaning
	Communication symbol Data transfer via communication





7.5.4 Navigation and selection from list

The operating keys are used to navigate through the operating menu and to select an option from a picklist.

Operating key(s)	Meaning
	<ul style="list-style-type: none"> ▪ Navigate downwards in the picklist ▪ Edit the numerical values and characters within a function
	<ul style="list-style-type: none"> ▪ Navigate upwards in the picklist ▪ Edit the numerical values and characters within a function
	<ul style="list-style-type: none"> ▪ Confirm entry ▪ Jump to the next item ▪ Selection of a menu item and activation of edit mode
 and 	Contrast setting of onsite display: darker
 and 	Contrast setting of onsite display: brighter
 and 	ESC functions: <ul style="list-style-type: none"> ▪ Exit edit mode for a parameter without saving the changed value. ▪ You are in a menu at a selection level. Each time you press the keys simultaneously, you go up a level in the menu.

7.5.5 Navigation examples

Parameters with a picklist

	Language	000	Software operation
1	✓ German Spanish		"English" is set as the menu language (default value). A ✓ in front of the menu text indicates the option that is currently active.
2	German ✓ Spanish		Select the menu language "Spanish" using  or  .
3	✓ Spanish German		Confirm your selection with  . A ✓ in front of the menu text indicates the option that is currently active ("Spanish" is the language selected). Use  to exit edit mode for the parameter.

Accepting the pressure present

Example: setting position adjustment.

Menu path: Main menu → Setup → Pos. zero adjust

	Pos. zero adjust 007	Software operation
1	✓ Cancel Confirm	The pressure for position adjustment is present at the device.
2	Cancel ✓ Confirm	Use \leftarrow or \rightarrow to switch to the "Confirm" option. The active option is highlighted in black.
3	Adjustment has been accepted!	Use the \leftarrow key to accept the applied pressure as a position adjustment. The device confirms the adjustment and goes back to the "Pos. zero adjust" parameter.
4	✓ Cancel Confirm	Use \leftarrow to exit edit mode for the parameter.

User-definable parameters

Example: setting parameter "Set URV (014)" from 100 mbar (1.5 psi) to 50 mbar (0.75 psi).

Menu path: Setup → Extended setup → Current output → Set URV

	Set URV 014	Software operation
1	<input type="text" value="1 0 0 . 0 0 0"/> mbar	The onsite display shows the parameter to be changed. The "mbar" unit is defined in another parameter and cannot be changed here.
2	<input type="text" value="1 0 0 . 0 0 0"/> mbar	Press \leftarrow or \rightarrow to get to edit mode. The first digit is highlighted in black.
3	<input type="text" value="5 0 0 . 0 0 0"/> mbar	Use the \leftarrow key to change "1" to "5". Press the \rightarrow key to confirm "5". Cursor jumps to the next position. Use the \rightarrow key to confirm (second position).
4	<input type="text" value="5 0 0 . 0 0 0"/> mbar	The third digit is highlighted in black and can now be edited.
5	<input type="text" value="5 0 ↵ . 0 0 0"/> mbar	Use the \rightarrow key to change to the "↵" symbol. Use \rightarrow to save the new value and exit edit mode. See next graphic.
6	<input type="text" value="5 0 . 0 0 0"/> mbar	The new value for the full scale value is 50.0 mbar (0.75 psi). Use \rightarrow to exit edit mode for the parameter. Use \leftarrow or \rightarrow to return to edit mode.

7.6 Operation using Endress+Hauser operating program

The FieldCare operating program is an Endress+Hauser asset management tool based on FDT technology. With FieldCare, you can configure all Endress+Hauser devices as well as devices from other manufacturers that support the FDT standard.

Hardware and software requirements can be found on the Internet:

www.de.endress.com → Search: FieldCare → FieldCare → Technical data.

FieldCare supports the following functions:

- Configuration of transmitters in online/offline mode
- Loading and saving device data (upload/download)
- Documentation of the measuring point

7.7 Direct access to parameters

The parameters can only be accessed directly via the "Expert" user role.

Direct access (119)

Navigation	 Expert → Direct access
Read permission	Operator/Service engineers/Expert
Write permission	Expert
Description	Enter the direct access code to go directly to a parameter.
User entry	Enter the desired parameter code.
Factory setting	0
Note	For direct access, it is not necessary to enter leading zeros.

7.8 Locking/unlocking operation

Once you have entered all the parameters, you can lock your entries against unauthorized and undesired access.

You have the following options for locking/unlocking operation:

- Via the DIP switch on the electronic insert, locally at the device.
- Via the local display (optional)
- Via communication e.g. FieldCare and HART handheld device.

The  symbol on the onsite display indicates that operation is locked. Parameters which refer to how the display appears, e.g. "Language" and "Display contrast", can still be altered.

 If operation is locked by means of the DIP switch, you can only unlock operation again by means of the DIP switch. If operation is locked by means of the onsite display or remote operation e.g. FieldCare, you can unlock operation either using the onsite display or remote operation.

The "Operator code" parameter is used to lock/unlock the device.

The parameters can only be accessed directly via the "Expert" user role.

Operator code (021)

Navigation	 Setup → Extended setup → Operator code
Read permission	Operator/Service engineers/Expert
Write permission	Operator/Service engineers/Expert

Description	Use this function to enter a code to lock or unlock operation.
User entry	<ul style="list-style-type: none"> ■ To lock: Enter a number ≠ the release code (value range: 1 to 9999). ■ To unlock: Enter the release code.
Factory setting	0
Note	<p>The release code is "0" in the order configuration. Another release code can be defined in the "Code definition" parameter. If the user has forgotten the release code, the release code can be made visible by entering the number "5864".</p> <p>The release code is defined in the "Code definition" parameter.</p>

Code definition (023)

Navigation	 Setup → Extended setup → Code definition
Read permission	Operator/Service engineers/Expert
Write permission	Operator/Service engineers/Expert
Description	Use this function to enter a release code with which the device can be unlocked.
User entry	A number from 0 to 9999
Factory setting	0

7.9 Resetting to factory settings (reset)

 By entering a certain code, you can completely or partially reset the entries for the parameters to the factory settings ¹⁾. Enter the code via the "Reset" parameter (menu path: "Diagnosis" → "Reset").

There are various reset codes for the device. The following table illustrates which parameters are reset by the particular reset codes. To perform a reset, operation must be unlocked (see "Locking/unlocking operation" section). →  37

Any customer-specific configuration carried out at the factory is not affected by a reset (customer-specific configuration remains). If you want to change the customer-specific configuration carried out at the factory, please contact Endress+Hauser Service.

1) . The factory setting for the individual parameters is specified in the parameter description

Reset code ¹⁾	Description and effect
62	PowerUp reset (warm start) <ul style="list-style-type: none"> ■ The device is restarted. ■ Data is read back anew from the EEPROM (process is reinitialized). ■ Any simulation which may be running is ended.
333	User reset <ul style="list-style-type: none"> ■ This code resets all the parameters apart from: <ul style="list-style-type: none"> - Device tag (022) - Linearization table - Operating hours (162) - Event logbook - Curr. trim 4 mA (135) - Curr. trim 20 mA (136) - Lo trim sensor (131) - Hi trim sensor (132) - Lo trim sensor (277) - Hi trim sensor (278) ■ Any simulation which may be running is ended. ■ The device is restarted.
7864	Total reset <ul style="list-style-type: none"> ■ This code resets all the parameters apart from: <ul style="list-style-type: none"> - Operating hours (162) - Event logbook - Lo trim sensor (131) - Hi trim sensor (132) - Lo trim sensor (277) - Hi trim sensor (278) ■ Any simulation which may be running is ended. ■ The device is restarted.

1) To be entered in "System" → "Management" → "Reset" (124)

 After a "Total reset" in FieldCare you have to press the "refresh" button in order to ensure that the measuring units are also reset.

8 Integrating transmitter via HART® protocol

Version data for the device

Firmware version	01.00.zz	<ul style="list-style-type: none"> ▪ On the title page of the Operating instructions ▪ On the nameplate → 15 ▪ Firmware Version parameter Diagnosis → Instrument info → Firmware Version
Manufacturer ID	17 (0x11)	Manufacturer Id parameter Diagnosis → Instrument info → Manufacturer ID
Device type code	39 (0x27)	Device type code parameter Diagnosis → Instrument info → Device type code
HART protocol revision	6.0	---
Device revision	1	<ul style="list-style-type: none"> ▪ On the transmitter nameplate → 15 ▪ Device revision parameter Diagnosis → Instrument info → Device revision

The suitable device description file (DD) for the individual operating tools is listed in the table below, along with information on where the file can be acquired.

Operating tools

Operating tool	Reference sources for device descriptions (DD and DTM)
FieldCare	<ul style="list-style-type: none"> ▪ www.endress.com → Download-Area ▪ CD-ROM (contact Endress+Hauser) ▪ DVD (contact Endress+Hauser)
AMS Device Manager (Emerson Process Management)	www.endress.com → Download-Area
SIMATIC PDM (Siemens)	www.endress.com → Download-Area
Field Communicator 375, 475 (Emerson Process Management)	Use update function of handheld terminal

8.1 HART process variables and measured values

The following numbers are assigned to the process variables in the factory:

Process variable	Pressure	Level	
		Linear	Table active
First process variable (Primary Variable (PV))	0 (Measured differential pressure)	8 (Level before linearization)	9 (Tank content)
Second process variable (Secondary Variable (SV))	2 (Measured pressure HP)	0 (Measured differential pressure)	8 (Level before linearization)

Process variable	Pressure	Level	
		Linear	Table active
Third process variable (Tertiary Variable (TV))	5 (Measured pressure LP)	2 (Measured pressure HP)	2 (Measured pressure HP)
Fourth process variable (Quaternary Variable (QV))	4 (Sensor temperature HP)	5 (Measured pressure LP)	5 (Measured pressure LP)

 The assignment of the device variables to the process variable is displayed in the **Expert → Communication → HART output** menu.

The assignment of the device variables to the process variable can be changed using HART command 51.

All four process variables must be assigned (PV, SV, TV, QV).

Sample data entry "Data (hex): 00010407"

- 00 = PV = Differential pressure measured (cannot be changed)
- 01 = SV = Corrected pressure
- 04 = TV = Sensor temperature HP
- 07 = QV = Sensor temperature LP

An overview of the possible device variables can be found in the following section.

8.2 Device variables and measured values

The following measured values are assigned to the individual device variables:

Device variable code	Measured value
0	Measured differential pressure
1	Corrected pressure
2	Measured pressure HP
3	Sensor pressure HP
4	Sensor temperature HP
5	Measured pressure LP
6	Sensor pressure LP
7	Sensor temperature LP
8	Level before linearization
9	Tank content
10	Process density
11	Electronic temperature
12	HART input value

 The device variables can be queried by a HART® master using HART® command 9 or 33.

9 Commissioning



NOTICE

If a pressure smaller than the minimum permitted pressure or greater than the maximum permitted pressure is present at the device, the following messages are output in succession:

- ▶ "S140 Working range P LP/HP" or "F140 Working range P LP/HP" (depending on the setting in the "Alarm behav. P" (050) parameter)
- ▶ "S841 Sensor range LP/HP" or "F841 Sensor range LP/HP" (depending on the setting in the "Alarm behav. P" (050) parameter)
- ▶ "S945/F945 Pressure limit LP"
- ▶ "S971 Calibration"

9.1 Post-installation check and function check

Before commissioning your measuring point, ensure that the post-installation and post-connection check have been performed:

- "Post-installation check" checklist →  23
- "Post-connection check" checklist →  29

9.2 Unlocking/locking configuration

If the device is locked to prevent configuration, it must first be unlocked.

9.2.1 Locking/unlocking hardware

If the device is locked via the hardware (write protection switch) and an attempt is made to write to a parameter, the message "HW lock state is ON" appears.

In addition, the key symbol appears in the measured value display. To unlock, toggle the write protection switch, which is located below the display module →  30.

9.2.2 Locking/unlocking software



If the device is locked via the software (device access code), the key symbol appears in the measured value display. If an attempt is made to write to a parameter, a prompt for the device access code appears. To unlock, enter the user-defined device access code →  37.

9.3 Commissioning without an operating menu

9.3.1 Pressure measuring mode

If no local display is connected, the following functions are possible via the three keys on the electronic insert or externally on the device:

- Position adjustment (zero point correction)
- Setting lower range value and upper range value
- To reset the device, see "Function of the operating elements" section, table →  31.

-  ▪ The pressure applied must be within the nominal pressure limits of the respective sensor module. See information on the nameplate.
- Operation must be unlocked, see "Unlocking/locking configuration" section →  42.
- The device is configured for the "Level" measuring mode as standard. The measuring mode can be changed using the "Measuring mode" parameter, see "Commissioning with an operating menu" section →  45.

⚠ WARNING

Changing the measuring mode affects the span (URV)

This situation can result in product overflow.

- ▶ If the measuring mode is changed, the setting for the span (URV) must be checked and readjusted if necessary.

Perform position adjustment (see information at the start of "Commissioning" section.)	
1	Device is installed. Process pressure is not present.
2	<input type="checkbox"/> Press key for at least 3 s.
3	Does the LED on the electronic insert light up briefly?
4	Yes No
5	Applied pressure for position adjustment has been accepted. Applied pressure for position adjustment has not been accepted. Observe the input limits.

Setting lower range value.	
1	Desired pressure for lower range value is present at device.
2	<input type="checkbox"/> Press key for at least 3 s.
3	Does the LED on the electronic insert light up briefly?
4	Yes No
5	Applied pressure for lower range value has been accepted. Applied pressure for lower range value has not been accepted. Observe the input limits.

Setting upper range value.	
1	Desired pressure for upper range value is present at device.
2	<input type="checkbox"/> Press key for at least 3 s.
3	Does the LED on the electronic insert light up briefly?
4	Yes No
5	Applied pressure for upper range value has been accepted. Applied pressure for upper range value has not been accepted. Observe the input limits.

9.3.2 Level measuring mode

If no local display is connected, the following functions are possible via the three keys on the electronic insert or externally on the device:

- Position adjustment (zero point correction)
 - Setting the lower and upper pressure value and assigning to the lower or upper level value
 - To reset the device, see "Function of the operating elements" section, table .
- i**
- The pressure applied must be within the nominal pressure limits of the respective sensor module. See information on the nameplate.
 - Operation must be unlocked, see "Unlocking/locking configuration" section → 42.
 - The and keys have a function only in the case of the "Calibration mode wet" setting. The keys have no function in other settings.
 - "Overview of level measurement" → 49
 - The device is configured for the "Level" measuring mode as standard. You can change the measuring mode using the "Measuring mode" parameter, see "Commissioning with an operating menu" section. → 45
- The following parameters are set to the following values at the factory: → 45.
- "Level selection": In pressure
 - "Calibration Mode": Wet
 - "Unit before lin." or "Linear range limit": %
 - "Empty calib.": 0.0 (corresponds to 4 mA value)
 - "Full calib.": 100.0 (corresponds to 20 mA value)
 - "Empty pressure": 0.0
 - "Full pressure": 100.0
- These parameters can be changed only via the local display or remote control, such as FieldCare.
- "Calibration mode", "Level type", "Empty calib.", "Full calib.", "Empty pressure" and "Full pressure" are parameter names that are used for the local display or remote control, such as FieldCare.

⚠ WARNING

Changing the measuring mode affects the span (URV)

This situation can result in product overflow.

- ▶ If the measuring mode is changed, the setting for the span (URV) must be checked and readjusted if necessary.

Perform position adjustment (see information at the start of "Commissioning" section.)	
1	Device is installed. Process pressure is not present.
2	<input type="checkbox"/> Press key for at least 3 s.
3	Does the LED on the electronic insert light up briefly?
4	Yes No
5	Applied pressure for position adjustment has been accepted. Applied pressure for position adjustment has not been accepted. Observe the input limits.

Set the lower pressure value.	
1	Desired pressure for lower pressure value ("Empty pressure") is present at the device.
2	<input type="checkbox"/> Press key for at least 3 s.
3	Does the LED on the electronic insert light up briefly?
4	Yes No
5	Applied pressure was saved as the lower pressure value ("Empty pressure") and assigned to the lower level value ("Empty calib."). The pressure present was not saved as the lower pressure value. Observe the input limits.

Set the upper pressure value.			
1	Desired pressure for upper pressure value ("Full pressure") is present at device.		
2	Press key for at least 3 s.		
3	Does the LED on the electronic insert light up briefly?		
4	<table border="1" style="width: 100%;"> <tr> <td style="text-align: center;">Yes</td> <td style="text-align: center;">No</td> </tr> </table>	Yes	No
Yes	No		
5	<table border="1" style="width: 100%;"> <tr> <td style="width: 50%;">Applied pressure was saved as the upper pressure value ("Full pressure") and assigned to the upper level value ("Full calib.).</td> <td style="width: 50%;">The pressure present was not saved as the upper pressure value. Observe the input limits.</td> </tr> </table>	Applied pressure was saved as the upper pressure value ("Full pressure") and assigned to the upper level value ("Full calib.).	The pressure present was not saved as the upper pressure value. Observe the input limits.
Applied pressure was saved as the upper pressure value ("Full pressure") and assigned to the upper level value ("Full calib.).	The pressure present was not saved as the upper pressure value. Observe the input limits.		

9.4 Commissioning with an operating menu

Commissioning comprises the following steps:

- Function check → 42
- Selecting the language, measuring mode, high-pressure side, and pressure engineering unit → 46
- Position adjustment → 47
- Configuring measurement:
 - Pressure measurement → 61
 - Level measurement → 48

9.5 Language selection

9.5.1 Configure language via onsite display

Language (000)

Navigation	Main menu → Language
Write permission	Operator/Service engineers/Expert
Description	Select the menu language for the local display.
Options	<ul style="list-style-type: none"> ▪ English ▪ Another language (as selected when ordering the device) ▪ Possibly a third language (language of the manufacturing plant)
Factory setting	English

9.5.2 Configuring language via operating tool (FieldCare)

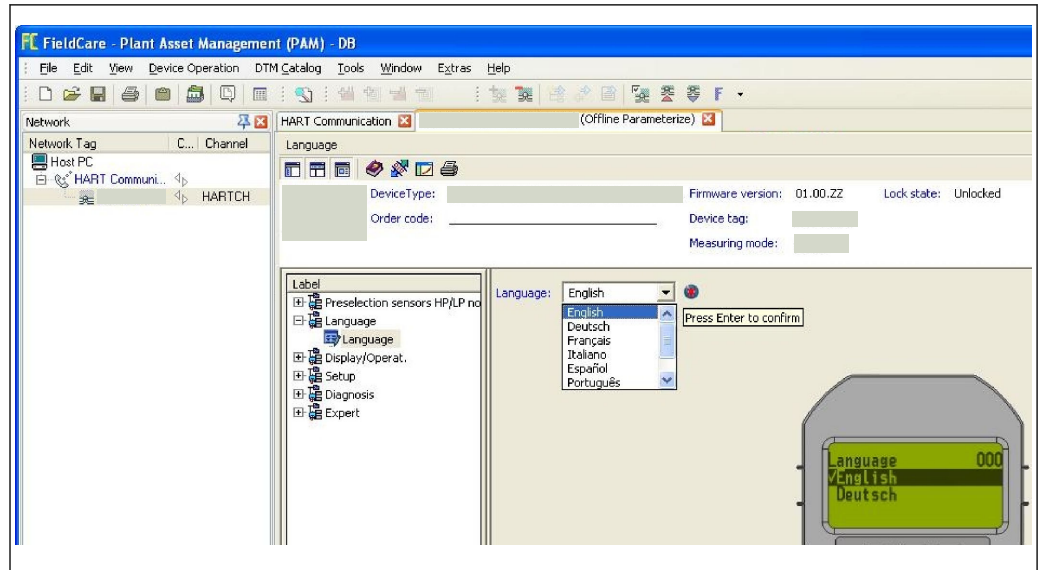

A0017654-EN

9.6 Measuring mode selection

⚠ WARNING

Changing the measuring mode affects the span (URV)

This situation can result in product overflow.

- ▶ If the measuring mode is changed, the setting for the span (URV) must be checked in the "Setup" operating menu and readjusted if necessary.

Measuring mode (005)

Navigation	🏠 📄 Setup → Measuring mode
Write permission	Operator/Service engineers/Expert
Description	Select the measuring mode. The operating menu is structured differently depending on the measuring mode selected.
Options	<ul style="list-style-type: none"> ▪ Pressure ▪ Level
Factory setting	Level

9.7 Selecting the high-pressure side

9.7.1 Defining the high-pressure side

High press. side (183)

Navigation	🏠 📄 Setup → High press. side
-------------------	------------------------------

Write permission	Operator/Service engineers/Expert
Description	Define which sensor module corresponds to the high-pressure side.
Options	<ul style="list-style-type: none"> ■ Sensor module HP ■ Sensor module LP
Factory setting	Sensor module HP

9.8 Pressure unit selection

Press. eng. unit (125)

Navigation	 Setup → Press. eng. unit
Write permission	Operators/Service engineers/Expert
Description	Select the pressure engineering unit. If a new pressure engineering unit is selected, all pressure-specific parameters are converted and displayed with the new unit.
Options	<ul style="list-style-type: none"> ■ mbar, bar ■ mmH2O, mH2O ■ in H2O, ftH2O ■ Pa, kPa, MPa ■ psi ■ mmHg, inHg ■ kgf/cm²
Factory setting	mbar, bar or psi depending on the sensor module nominal measuring range, or as per order specifications.



9.9 Pos. zero adjust

The pressure resulting from the orientation of the device can be corrected here.

Corrected press. (172)

Navigation	 Setup → Corrected press.
Write permission	Operators/Service engineers/Expert
Description	Displays the measured pressure after the differential pressure buildup and position adjustment.
Note	If this value is not equal to "0", it can be corrected to "0" by the position adjustment.

Pos. zero adjust (007)

Navigation	  Setup → Pos. zero adjust
Write permission	Operators/Service engineers/Expert
Description	Position adjustment – the pressure difference between zero (set point) and the measured differential pressure need not be known.
Options	<ul style="list-style-type: none"> ▪ Confirm ▪ Cancel
Example	<ul style="list-style-type: none"> ▪ Measured value = 2.2 mbar (0.033 psi) ▪ You correct the measured value via the "Pos. zero adjust" parameter with the "Confirm" option. This means that you are assigning the value 0.0 to the pressure present. ▪ Measured value (after pos. zero adjust) = 0.0 mbar ▪ The current value is also corrected.
Factory setting	Cancel

9.10 Configuring level measurement

9.10.1 Information on level measurement

 You have a choice of two methods for calculating the level: "In pressure" and "In height". The table in the "Overview of level measurement" section that follows provides you with an overview of these two measuring tasks.

- The limit values are not checked, i.e. the values entered must be appropriate for the sensor module and the measuring task for the device to be able to measure correctly.
- Customer-specific units are not possible.
- There is no unit conversion.
- The values entered for "Empty calib./Full calib.", "Empty pressure/Full pressure", "Empty height/Full height" and "Set LRV/Set URV" must be at least 1% apart. The value will be rejected, and a warning message displayed, if the values are too close together.

9.10.2 Overview of level measurement

Measuring task	Level selection	Measured variable options	Description	Measured value display
Calibration is performed by entering two pressure-level value pairs.	"In pressure"	Via the "Unit before lin. (025)" parameter → 86: %, level, volume or mass units.	<ul style="list-style-type: none"> Calibration with reference pressure (wet calibration) → 49 Calibration without reference pressure (dry calibration), → 51 	The measured value display and the "Level before lin (019)" parameter → 84 show the measured value.
Calibration is performed by entering the density and two height-level value pairs.	"In height"		<ul style="list-style-type: none"> Calibration with reference pressure (wet calibration) → 53 Calibration without reference pressure (dry calibration), → 54 	

9.10.3 "In pressure" level selection Calibration with reference pressure (wet calibration)

Example:

In this example, the level in a tank should be measured in "m". The maximum level is 3 m (9.8 ft).

The pressure range is derived from the level and the density of the medium. In this situation, the device sets the pressure range to 0 to 300 mbar (4.5 psi).

Prerequisite:

- The measured variable is in direct proportion to the pressure.
- The tank can be filled and emptied.

i The values entered for "Empty calib./Full calib.", "Set LRV/Set URV", and the applied pressures must be at least 1% apart. The value will be rejected, and a warning message displayed, if the values are too close together. Further limit values are not checked, i.e. the values entered must be appropriate for the sensor module and the measuring task for the device to be able to measure correctly.

Description	
1	Perform a "position adjustment" → 81.
2	Select the "Level" measuring mode via the "Measuring mode (005)" parameter. Menu path: Setup → Measuring mode
3	Select a pressure engineering unit via the "Press eng. unit (125)" parameter, here "mbar" for example. Menu path: Setup → Press. eng. unit
4	Select the "In pressure" level mode via the "Level selection (024)" parameter. Menu path: Setup → Extended setup → Level → Level selection
5	Select a level unit via the "Unit before lin. (025)" parameter, here "m" for example. Menu path: Setup → Extended setup → Level → Unit before lin.

A See table, step 7.

B See table, step 8.

A0017661

Description	
6	Select the "Wet" option via the " Calibration mode (027) " parameter. Menu path: Setup → Extended setup → Level → Calibration mode
7	The vessel is filled to the lower calibration point. The pressure here is 0 mbar (0 psi), for example. Select the " Empty calib. (028) " parameter. Menu path: Setup → Extended setup → Level → Empty calib. Enter the level value, here 0 m for example. The pressure value present is assigned to the lower level value by confirming the value.
8	The vessel is filled to the upper calibration point. The pressure here is 300 mbar (4.35 psi), for example. Select the " Full Calib. (031) " parameter. Menu path: Setup → Extended setup → Level → Full calib. Enter the level value, here 3 m (9.8 ft) for example. The pressure value present is assigned to the upper level value by confirming the value.
9	If calibration is performed with a medium other than the process medium, enter the density of the calibration medium in " Adjust density (034) ". Menu path: Setup → Extended setup → Level → Adjust density
10	Use the " Set LRV (166) " parameter to set the level value for the lower current value (4 mA) (0 m (0 ft)). Menu path: Setup → Extended setup → Current output → Set LRV
11	Use the " Set URV (167) " parameter to set the level value for the upper current value (20 mA) (3 m (9.8 ft)). Menu path: Setup → Extended setup → Current output → Set URV
12	If the process uses a medium other than that on which the calibration was based, the new density must be specified in the " Process density (035) " parameter. Menu path: Setup → Extended setup → Level → Process density
13	Result: The measuring range is configured for 0 to 3 m (0 to 9.8 ft).

A0034735

C See table, step 7.
D See table, step 8.
E See table, step 10.
F See table, step 11.
h Height
i Current value
p Pressure

i For this level mode, the measured variables %, level, volume and mass are available, see "**Unit before lin. (025)**" → 86.



9.10.4 "In pressure" level selection Calibration without reference pressure (dry calibration)

Example:

In this example, the volume in a tank should be measured in liters. The maximum volume of 1 000 l (264 gal) corresponds to a pressure of 450 mbar (6.53 psi).

The minimum volume of 0 liters corresponds to a pressure of 50 mbar (0.73 psi) since the device is mounted below the start of the level measuring range.

Prerequisite:

- The measured variable is in direct proportion to the pressure.
- This is a theoretical calibration i.e. the pressure and volume values for the lower and upper calibration point must be known.
-  ■ The values entered for "Empty calib./Full calib.", "Empty pressure/Full pressure" and "Set LRV/Set URV" must be at least 1% apart. The value will be rejected, and a warning message displayed, if the values are too close together. Further limit values are not checked, i.e. the values entered must be appropriate for the sensor module and the measuring task for the device to be able to measure correctly.
- Due to the orientation of the device, there may be pressure shifts in the measured value, i.e. when the vessel is empty or partly filled, the measured value is not zero. For information on how to perform position adjustment, see →  81.

Description	
1	Select the "Level" measuring mode via the "Measuring mode (005)" parameter. Menu path: Setup → Measuring mode
2	Select a pressure engineering unit via the "Press eng. unit (125)" parameter, here "mbar" for example. Menu path: Setup → Press. eng. unit
3	Select the "In pressure" level mode via the "Level selection (024)" parameter. Menu path: Setup → Extended setup → Level → Level selection
4	Select a volume unit via the "Unit before lin. (025)" parameter, here "l" (liters) for example. Menu path: Setup → Extended setup → Level → Unit before lin.

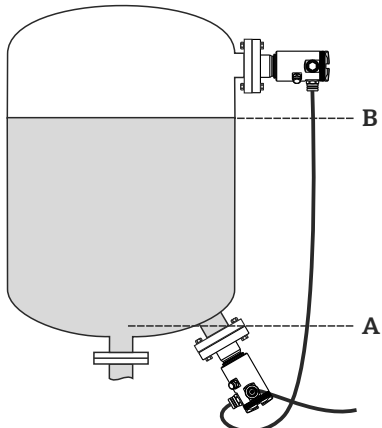

A See table, steps 6 and 7.

B See table, steps 8 and 9.

A0017661

Description	
5	Select the "Dry" option via the " Calibration mode (027) " parameter. Menu path: Setup → Extended setup → Level → Calibration mode
6	Enter the volume value for the lower calibration point via the " Empty calib. (028) " parameter, here 0 liters for example. Menu path: Setup → Extended setup → Level → Empty calib.
7	Enter the pressure value for the lower calibration point via the " Empty pressure (029) " parameter, here 50 mbar (0.73 psi) for example. Menu path: Setup → Extended setup → Level → Empty pressure
8	Enter the volume value for the upper calibration point via the " Full calib. (031) " parameter, here 1000 l (264 gal) for example. Menu path: Setup → Extended setup → Level → Full calib.
9	Enter the pressure value for the upper calibration point via the " Full pressure (032) " parameter, here 450 mbar (6.53 psi) for example. Menu path: Setup → Extended setup → Level → Full pressure
10	" Adjust density (034) " contains the factory setting 1.0, but this value can be changed if required. Menu path: Setup → Extended setup → Level → Adjust density
11	Set the volume value for the lower current value (4 mA) via the " Set LRV (166) " parameter (0 l). Menu path: Setup → Extended setup → Current output → Set LRV
12	Set the volume value for the upper current value (20 mA) via the " Set URV (167) " parameter (1000 l (264 gal)). Menu path: Setup → Extended setup → Current output → Set URV
13	If the process uses a medium other than that on which the calibration was based, the new density must be specified in the " Process Density " parameter. Menu path: Setup → Extended setup → Current output → Process density.
14	Result: The measuring range is configured for 0 to 1000 l (0 to 264 gal).

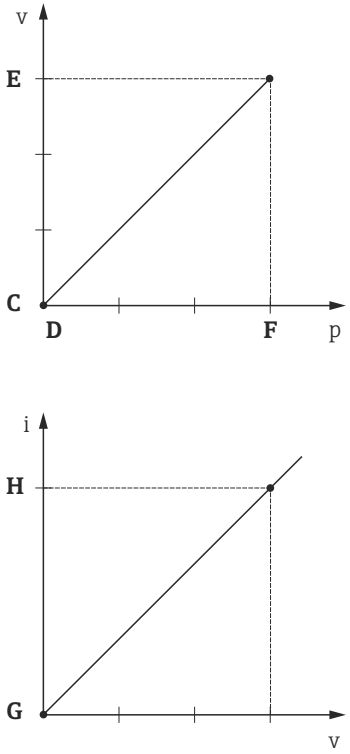

C See table, step 6.
D See table, step 7.
E See table, step 8.
F See table, step 9.
G See table, step 11
H See table, step 12
i Current value
p Pressure
v Volume

A0034736

For this level mode, the measured variables %, level, volume and mass are available, see "Unit before lin. (025)" → 86.

9.10.5 "In height" level selection Calibration with reference pressure (wet calibration)

Example:

In this example, the volume in a tank should be measured in liters. The maximum volume of 1 000 l (264 gal) corresponds to a level of 4.5 m (15 ft).

The minimum volume of 0 liters corresponds to a level of 0.5 m (1.6 ft) since the device is mounted below the start of the level measuring range. The density of the fluid is 1 g/cm³ (1 SGU).

Prerequisite:

- The measured variable is in direct proportion to the pressure.
- The tank can be filled and emptied.

i The values entered for "Empty Calib./Full Calib.", "Set LRV/Set URV", and the applied pressure values must be at least 1% apart. The value will be rejected, and a warning message displayed, if the values are too close together. Further limit values are not checked, i.e. the values entered must be appropriate for the sensor module and the measuring task for the device to be able to measure correctly.

Description	
1	Select the "Level" measuring mode via the "Measuring mode (005)" parameter. Menu path: Setup → Measuring mode
2	Select a pressure engineering unit via the "Press eng. unit (125)" parameter, here "mbar" for example. Menu path: Setup → Press. eng. unit
3	Select the "In height" level mode via the "Level selection (024)" parameter. Menu path: Setup → Extended setup → Level → Level selection
4	Select a volume unit via the "Unit before lin. (025)" parameter, here "l" (liters) for example. Menu path: Setup → Extended setup → Level → Unit before lin.

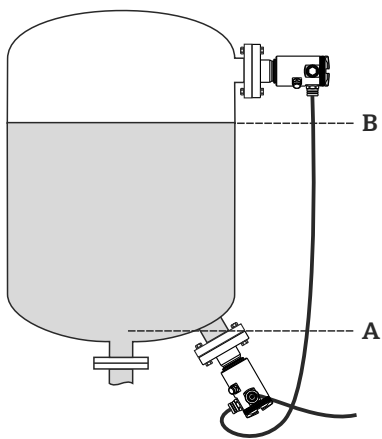

A See table, step 8.

B See table, step 9.

A0017661

Description	
5	Select a level unit via the "Height unit (026)" parameter, here "m" for example. Menu path: Setup → Extended setup → Level → Height unit
6	Select the "Wet" option via the "Calibration mode (027)" parameter. Menu path: Setup → Extended setup → Level → Calibration mode
7	Vessel is filled up to 0.5 m (1.6 ft), (49 mbar (0.72 psi)). Enter the volume value for the lower calibration point via the "Empty calib. (028)" parameter, here 0 liters for example. Menu path: Setup → Extended setup → Level → Empty calib.
8	Vessel is filled up to 4.5 m (15 ft), (441 mbar (6.40 psi)). Enter the volume value for the upper calibration point via the "Full calib. (031)" parameter, here 1000 l (264 gal) for example. Menu path: Setup → Extended setup → Level → Full calib.
9	Enter the density of the calibration medium in "Adjust density (034)", here 1 g/cm ³ (1 SGU), for example. Menu path: Setup → Extended setup → Level → Adjust density
10	Set the volume value for the lower current value (4 mA) via the "Set LRV (166)" parameter (0 l). Menu path: Setup → Extended setup → Current output → Set LRV
11	Set the volume value for the upper current value (20 mA) via the "Set URV (167)" parameter 1000 l (264 gal). Menu path: Setup → Extended setup → Current output → Set URV
12	If the process uses a medium other than that on which the calibration was based, the new density must be specified in the "Process density (035)" parameter. Menu path: Setup → Extended setup → Level → Process density
13	Result: The measuring range is configured for 0 to 1000 l (0 to 264 gal).

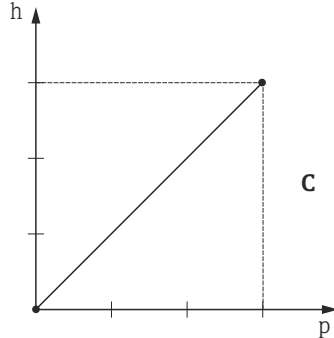
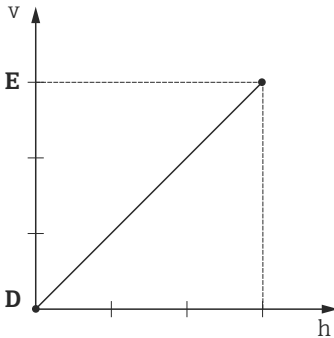
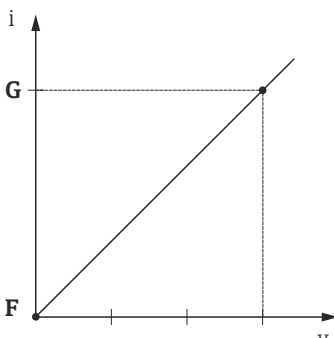
C See table, step 10.
 D See table, step 8.
 E See table, step 9.
 F See table, step 11.
 G See table, step 12.
 h Height
 i Current value
 p Pressure
 v Volume

i For this level mode, the measured variables %, level, volume and mass are available, see "Unit before lin. (025)" → 86.

9.10.6 "In height" level selection Calibration without reference pressure (dry calibration)

Example:

In this example, the volume in a tank should be measured in liters. The maximum volume of 1000 l (264 gal) corresponds to a level of 4.5 m (15 ft). The minimum volume of 0

liters corresponds to a level of 0.5 m (1.6 ft) since the device is mounted below the start of the level measuring range.

Prerequisite:

- The measured variable is in direct proportion to the pressure.
- This is a theoretical calibration i.e. the height and volume values for the lower and upper calibration point must be known.
- The values entered for "Empty calib./Full calib.", "Empty height/Full height" and "Set LRV/Set URV" must be at least 1% apart. The value will be rejected, and a warning message displayed, if the values are too close together. Further limit values are not checked, i.e. the values entered must be appropriate for the sensor module and the measuring task for the device to be able to measure correctly.
- Due to the orientation of the device, there may be pressure shifts in the measured value, i.e. when the vessel is empty or partly filled, the measured value is not zero. For information on how to perform position adjustment, see → 81.

Description	
1	Select the "Level" measuring mode via the "Measuring mode (005)" parameter. Menu path: Setup → Measuring mode
2	Select a pressure engineering unit via the "Press eng. unit (125)" parameter, here "mbar" for example. Menu path: Setup → Press. eng. unit
3	Select the "In height" level mode via the "Level selection (024)" parameter. Menu path: Setup → Extended setup → Level → Level selection
4	Select a volume unit via the "Unit before lin. (025)" parameter, here "l" (liters) for example. Menu path: Setup → Extended setup → Level → Unit before lin.
5	Select a level unit via the "Height unit (026)" parameter, here "m" for example. Menu path: Setup → Extended setup → Level → Height unit

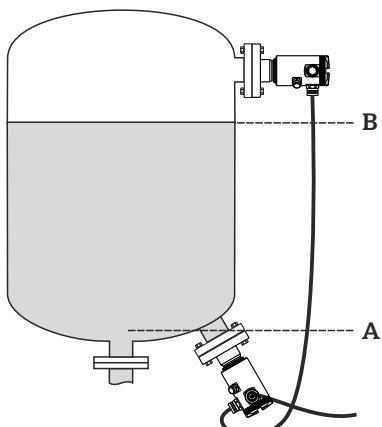

A See table, steps 7 and 8.

B See table, steps 9 and 10.

A0017661

Description	
6	Select the "Dry" option via the "Calibration mode (027)" parameter. Menu path: Setup → Extended setup → Level → Calibration mode
7	Enter the volume value for the lower calibration point via the "Empty calib. (028)" parameter, here 0 liters for example. Menu path: Setup → Extended setup → Level → Empty calib.
8	Enter the height value for the lower calibration point via the "Empty height (030)" parameter, here 0.5 m (1.6 ft) for example. Menu path: Setup → Extended setup → Level → Empty height
9	Enter the volume value for the upper calibration point via the "Full calib. (031)" parameter, here 1 000 l (264 gal) for example. Menu path: Setup → Extended setup → Level → Full calib.
10	Enter the height value for the upper calibration point via the "Full height (033)" parameter, here 4.5 m (15 ft) for example. Menu path: Setup → Extended setup → Level → Full height
11	Enter the density of medium via the "Adjust density (034)" parameter, here "1 g/cm ³ " (1 SGU) for example. Menu path: Setup → Extended setup → Level → Adjust density
12	Set the volume value for the lower current value (4 mA) via the "Set LRV (166)" parameter (0 l). Menu path: Setup → Extended setup → Current output → Set LRV
13	Set the volume value for the upper current value (20 mA) via the "Set URV (167)" parameter (1 000 l (264 gal)). Menu path: Setup → Extended setup → Current output → Set URV
13	If the process uses a medium other than that on which the calibration was based, the new density must be specified in the "Process density" parameter. Menu path: Setup → Extended setup → Current output → Process density.
14	Result: The measuring range is configured for 0 to 1 000 l (0 to 264 gal).

C See table, step 11.
D See table, step 7.
E See table, step 9.
F See table, step 12.
G See table, step 13.
h Height
i Current value
p Pressure
v Volume

A0034737

i For this level mode, the measured variables %, level, volume and mass are available, see "Unit before lin. (025)" → 86.

9.10.7 Calibration with partially filled vessel (wet calibration)

Example:

This example explains a wet calibration for cases in which it is not possible to empty the vessel and then fill it to 100%.

During this wet calibration, a level of 20% is used as the calibration point for "Empty" and a level of "80%" is used as the calibration point for "Full".

The calibration is then extended to 0% to 100% and lower range-value (LRV)/upper range-value (URV) are adapted accordingly.

Prerequisite:

- The default value in level mode for the calibration mode is "Wet".
- This value can be adjusted: Menu path: Setup → Extended setup → Level → Calibration mode

Description	
1	Select the "Level" measuring mode via the "Measuring mode (005)" parameter. Menu path: Setup → Measuring mode
2	Select a unit via the "Unit before lin. (025)" parameter, here "%" for example. Menu path: Setup → Extended setup → Level → Unit before lin.
3	20% of the vessel is full. Enter the level value for the lower calibration value via the "Empty calib. (028)" parameter, here 20% for example. Menu path: Setup → Extended setup → Level → Empty calib.
4	80% of the vessel is full. Enter the level value for the upper calibration value via the "Full calib. (031)" parameter, here 80% for example. Menu path: Setup → Extended setup → Level → Full calib.
5	The pressure values for full/empty calibration are automatically recorded and applied. The upper range value (URV) and lower range value (LRV) automatically accept the values that were entered in "Empty calib. (028)" and "Full calib. (031)". These automatically entered values can be edited if necessary and, for example, changed to a value ranging from 0 to 100%.

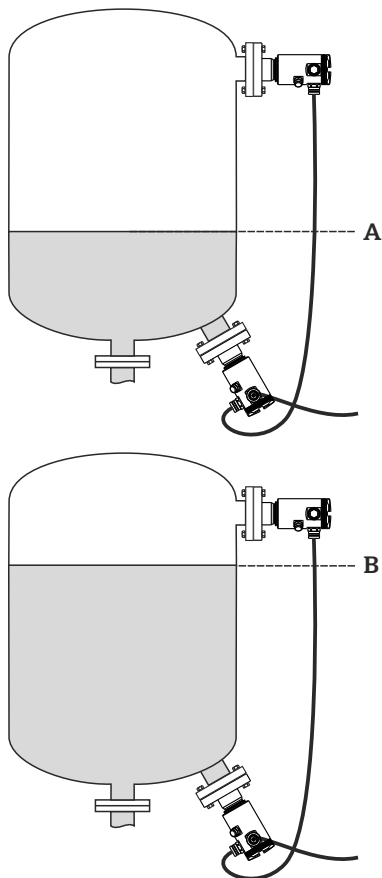

A See table, step 3

B See table, step 4

A0017668

i If the process uses a medium other than that on which the calibration was based, the new density must be specified in the "Process density (035)" parameter. In this case, you have to enter the various densities via the following menu path:

- Setup → Extended setup → Level → Adjust density (034) e.g. 1.0 kg/l for water)
- Setup → Extended setup → Level → Process density (035) e.g. 0.8 kg/l for oil)

9.11 Linearization

9.11.1 Manual entry of a linearization table

Example:

In this example, the volume in a tank with a conical outlet should be measured in m^3 .

Prerequisite:

- This is a theoretical calibration, i.e. the points for the linearization table are known.
- The "Level" measuring mode has been selected.
- A level calibration has been performed.
- The linearization characteristic must rise or fall continuously.
- For a description of the parameters mentioned, →  78 "Description of parameters".

WARNING

Changing the measuring mode affects the span (URV)

This situation can result in product overflow.

- ▶ If the measuring mode is changed, the setting for the span (URV) must be checked in the "Setup" operating menu and readjusted if necessary.

Description	
1	Select the "Manual entry" option via the "Lin. mode (037)" parameter. Menu path: Setup → Extended setup → Linearization → Lin. mode
2	Select using the "Unit after lin. (038)" parameter, e.g. m^3 . Menu path: Setup → Extended setup → Linearization → Unit after lin.

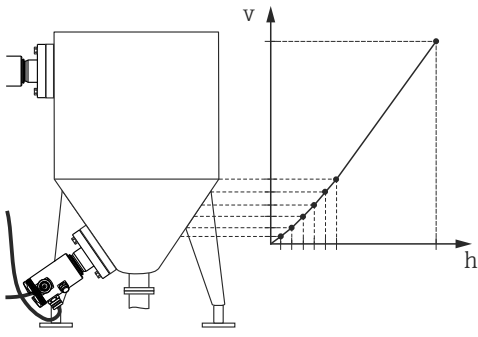

h Height

v Volume

A0017669

Description	
3	<p>Enter the number of the point in the table using the "Line number (039)" parameter e.g. 1. Menu path: Setup → Extended setup → Linearization → Line numb.</p> <p>The level is entered via the "X-value (040)" parameter, here 0 m for example. Confirm your entry. Menu path: Setup → Extended setup → Linearization → X-value</p> <p>Using the "Y-val. (041)" parameter, enter the corresponding volume value, here 0 m³ for example, and confirm the value. Menu path: Setup → Extended setup → Linearization → Y-value</p>
4	<p>To enter another point in the table, select the "Next point" option via the "Edit table (042)" parameter. Enter the next point as explained in Step 3. Menu path: Setup → Extended setup → Linearization → Edit table</p>
5	<p>Once all the points have been entered in the table, select the "Activate table" option via the "Lin. mode (037)" parameter. Menu path: Setup → Extended setup → Linearization → Lin. mode</p>
6	<p>Result: Result: The measured value after linearization is displayed.</p>

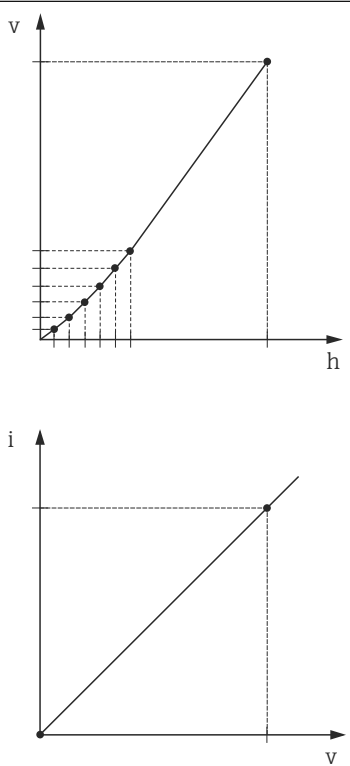

h Height
i Current value
v Volume

A0017670

- i Error message F510 "Linearization" and alarm current as long as the table is being entered and until the table is activated.
- Error message F511/F512 "Linearization" and alarm current as long as the linearization table consists of fewer than 2 points.
- The lower range value (= 4mA) is defined by the smallest point in the table. The upper range value (= 20mA) is defined by the greatest point in the table.
- Using the parameters "Set LRV" and "Set URV", you can change the allocation of the volume/mass values to the current values.

9.11.2 Manual entry of a linearization table via operating tool

With an operating tool based on FDT technology (e.g. FieldCare), it is possible to enter linearization via a module that has been specially designed for this. This provides you with an overview of the selected linearization, even during entry. In addition, it is possible to configure different tank shapes in FieldCare ("Device operation" → "Device functions" → "Additional functions" → "Linearization table" menu).

i The linearization table may also be entered manually point by point in the operating tool menu (see section → 78).

9.11.3 Semi-automatic entry of a linearization table

Example:

In this example, the volume in a tank with a conical outlet should be measured in m³.

Prerequisite:

- The tank can be filled or emptied. The linearization characteristic must rise or fall continuously.
- The "Level" measuring mode has been selected.
- A level calibration has been performed.
- For a description of the parameters mentioned, →  78 "Description of parameters".

⚠ WARNING

Changing the measuring mode affects the span (URV)

This situation can result in product overflow.

- ▶ If the measuring mode is changed, the setting for the span (URV) must be checked in the "Setup" operating menu and readjusted if necessary.

Description	
1	<p>Select the "Semiautom. entry" option via the "Lin. mode (037)" parameter. Menu path: Setup → Extended setup → Linearization → Lin. mode</p>
2	<p>Select using the "Unit after lin. (038)" parameter, e.g. m³. Menu path: Setup → Extended setup → Linearization → Unit after lin.</p>
3	<p>Enter the number of the point in the table using the "Line number (039)" parameter e.g. 1. Menu path: Setup → Extended setup → Linearization → Line numb.</p> <p>The level at the current time is displayed using the "X-value (040)" parameter. Menu path: Setup → Extended setup → Linearization → X-value</p> <p>Using the "Y-val. (041)" parameter, enter the corresponding volume value, here 0 m³ for example, and confirm the value. Menu path: Setup → Extended setup → Linearization → Y-value</p>
4	<p>To enter another point in the table, continue filling the tank and select the "Next point" option. via the "Edit table (042)" parameter. Enter the next point as explained in Step 3. Menu path: Setup → Extended setup → Linearization → Edit table</p>

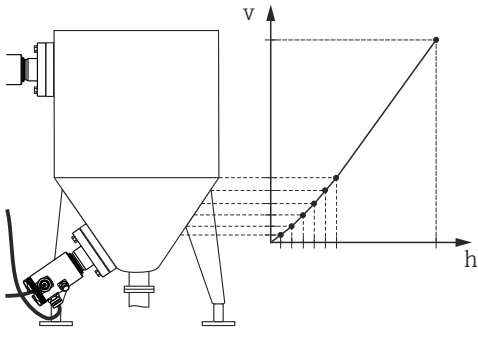

A0017669

h Height
v Volume

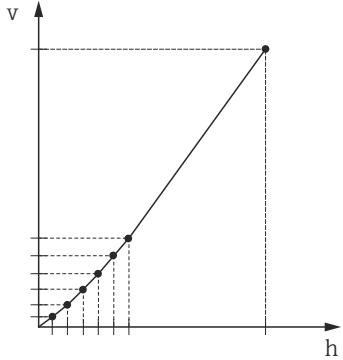

h Height
i Current value
v Volume

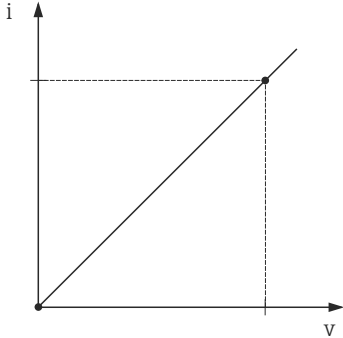

A0017670

Description	
5	Once all the points have been entered in the table, select the "Activate table" option via the "Lin. mode (037)" parameter. Menu path: Setup → Extended setup → Linearization → Lin. mode
6	Result: Result: The measured value after linearization is displayed.

-  Error message F510 "Linearization" and alarm current as long as the table is being entered and until the table is activated.
- The lower range value (= 4mA) is defined by the smallest point in the table. The upper range value (= 20mA) is defined by the greatest point in the table.
- Using the parameters "Set LRV" and "Set URV", you can change the allocation of the volume/mass values to the current values.

9.12 Configuring pressure measurement



9.12.1 Calibration without reference pressure (dry calibration)

Example:

In this example, a device with a 400 mbar (6 psi) sensor module is configured for the 0 to +300 mbar (4.4 psi) measuring range, i.e. the 4 mA value and the 20 mA value are assigned 0 mbar and 300 mbar (4.4 psi) respectively.

Prerequisite:

This is a theoretical calibration, i.e. the pressure values for the lower and upper range are known. It is not necessary to apply pressure.

-  Due to the orientation of the device, there may be pressure shifts in the measured value, i.e. the measured value is not zero in a pressureless condition. For information on how to perform position adjustment, see "Position adjustment" section →  47.

Description	
1	Select the "Pressure" measuring mode via the "Measuring mode (005)" parameter. Menu path: Setup → Measuring mode
2	Select a pressure engineering unit via the "Press eng. unit (125)" parameter, here "mbar" for example. Menu path: Setup → Press. eng. unit
3	Select "Set LRV (013)" parameter. Menu path: Setup → Set LRV Enter and confirm the value (here 0 mbar (0 psi)) for the "Set LRV" parameter. This pressure value is assigned to the lower current value (4 mA).
4	Select the "Set URV (014)" parameter. Menu path: Setup → Set URV

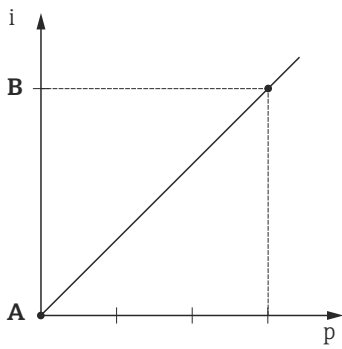

A See table, step 3.

B See table, step 4.

i Current value

p Pressure

A0017671

Description	
	Enter and confirm the value (here 300 mbar (4.5 psi)) for the "Set URV (014)" parameter. This pressure value is assigned to the upper current value (20 mA).
5	Result: The measuring range is configured for 0 to +300 mbar (4.5 psi).

9.12.2 Calibration with reference pressure (wet calibration)

Example:

In this example, a device with a 400 mbar (6 psi) sensor module is configured for the 0 to +300 mbar (4.4 psi) measuring range, i.e. the 4 mA value and the 20 mA value are assigned 0 mbar and 300 mbar (4.4 psi) respectively.

Prerequisite:

The pressure values 0 mbar and 300 mbar (4.4 psi) can be specified. The device is already mounted, for example.

 For a description of the parameters mentioned, →  78"Description of parameters".

Description	
1	Perform position adjustment →  81.
2	Select the "Pressure" measuring mode via the "Measuring mode (005)" parameter. Menu path: Setup → Measuring mode
3	Select a pressure engineering unit via the "Press Eng. Unit (125)" parameter, here "mbar" for example. Menu path: Setup → Press. eng. unit
4	The pressure for the LRV (4 mA value) is present at the device, here 0 mbar (0 psi) for example.
	Select the "Get LRV (015)" parameter. Menu path: Setup → Extended setup → Current output → Get LRV.
	Confirm the value present by selecting "Apply". The pressure value present is assigned to the lower current value (4 mA).
5	The pressure for the URV (20 mA value) is present at the device, here 300 mbar (4.4 psi) for example.
	Select the "Get URV (016)" parameter. Menu path: Setup → Extended setup → Current output → Get URV.
	Confirm the value present by selecting "Apply". The pressure value present is assigned to the upper current value (20 mA).
6	Result: The measuring range is configured for 0 to +300 mbar (4.5 psi).

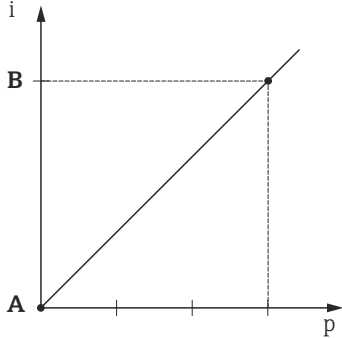

A See table, step 4.
B See Table, Step 5.
i Current value
p Pressure

A0017671

9.13 Backing up or duplicating the device data

The following options are available to you with an operating tool that is based on FDT technology (e.g. FieldCare):

- Storage/recovery of configuration data.
- Duplication of device parameters.
- Transfer of all relevant parameters when replacing electronic inserts.

Use the following parameter for this:

Download select. (visible only in FieldCare)

Navigation	 Expert → System → Management → Download select.
Write permission	Operators/Service engineers/Expert
Description	Selection of data packages for up/download function in Fieldcare and PDM.
Prerequisite	DIP switch set to "SW" and "Damping" set to "on". If you download using the factory setting "Configuration copy", all parameters required for a measurement will be downloaded. The functionality of the "Electronics replace" setting is reserved for Endress+Hauser Service and can be accessed only if the correct device access code is entered.
Options	<ul style="list-style-type: none">▪ Configuration copy: This option overwrites general configuration parameters with the exception of the serial number, order number, calibration, pos. zero adjust, application and day information.▪ Device replacement: This option overwrites general configuration parameters with the exception of the serial number, order number, calibration and position adjustment.▪ Electronics replace: This option overwrites general configuration parameters.
Factory setting	Copy configuration

9.14 Configuring the local display



9.14.1 Adjusting the local display

The local display can be adjusted in the following menu:

Display/operat. →  74

9.15 Protecting settings from unauthorized access





The settings can be protected from unauthorized access in two ways:

- Locking via write protection switch (hardware locking) →  30
- Locking via parameter (software locking) →  37

10 Diagnostics and troubleshooting

10.1 Troubleshooting

General errors

Problem	Possible cause	Solution
Device is not responding.	Supply voltage does not match the value indicated on the nameplate.	Apply correct voltage.
	The polarity of the supply voltage is wrong.	Correct the polarity.
	Connecting cables are not in contact with the terminals.	Check the connection of the cables and correct if necessary.
No display	Onsite display is set too bright or too dark.	<ul style="list-style-type: none"> ▪ Set the onsite display brighter by simultaneously pressing  and . ▪ Set the onsite display darker by simultaneously pressing  and .
	Connector for onsite display is not properly connected.	Connect the plug correctly.
	Onsite display is defective.	Replace onsite display.
Output current < 3.6 mA	Signal line is not wired correctly. Electronics unit is defective.	Check wiring. Replace electronics.
Device measures incorrectly.	Configuration error.	Check and correct parameter configuration (see below).
HART communication is not working.	Communication resistor missing or incorrectly installed.	Install the communication resistor (250 Ω) correctly.
	Commubox is connected incorrectly.	Connect Commubox correctly.
	Commubox is not set to "HART".	Set Commubox selector switch to "HART".

10.2 Diagnostic events

10.2.1 Diagnostic message

Faults detected by the self-monitoring system of the measuring device are displayed as a diagnostic message in alternation with the measured value display.

Status signals

The table →  66 lists the messages that may occur. The ALARM STATUS parameter shows the message with the highest priority. The device has four different status information codes according to NAMUR NE107:

F A0013956	"Failure" A device error has occurred. The measured value is no longer valid.
M A0013957	"Maintenance required" Maintenance is required. The measured value remains valid.
C A0013959	"Function check" The device is in service mode (e.g. during a simulation).
S A0013958	"Out of specification" The device is operated: <ul style="list-style-type: none"> ▪ Outside its technical specifications (e.g. during warm-up or cleaning). ▪ Outside of the configuration carried out by the user (e.g. level outside configured span)

Diagnostic event and event text

The fault can be identified by means of the diagnostic event.

The event text helps you by providing information on the fault.

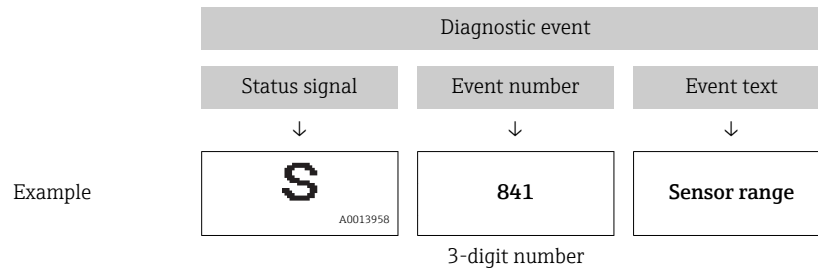

If two or more diagnostic events are pending simultaneously, only the diagnostic message with the highest priority is shown.

Other diagnostic messages that are pending can be viewed in the **Diagnostic list** submenu → 100.

Past diagnostic messages that are no longer pending are shown in the **Event logbook** submenu → 100.

10.2.2 List of diagnostic events

General messages

Diagnostic event		Cause	Corrective measure
Code	Description		
0	No error	-	-

"F" messages

Diagnostic event		Cause	Corrective measure
Code	Description		
F002	Sens. unknown LP/HP	Sensor module does not suit the device (electronic sensor module nameplate).	Contact Endress+Hauser Service
F062	Sensor conn.	<ul style="list-style-type: none"> ▪ Electromagnetic effects are greater than specifications in the technical data. This message appears for a short time only. ▪ Sensor module defective. ▪ Cable connection between sensor module and main electronics disconnected. 	<ul style="list-style-type: none"> ▪ Contact Endress+Hauser Service ▪ Replace electronics ▪ Check the sensor module cable
F081	Initialization	<ul style="list-style-type: none"> ▪ Electromagnetic effects are greater than specifications in the technical data. This message appears for a short time only. ▪ Sensor module defective. ▪ Cable connection between sensor module and main electronics disconnected. 	<ul style="list-style-type: none"> ▪ Contact Endress+Hauser Service ▪ Check sensor cable ▪ Perform a reset
F083	Permanent mem. LP/HP	<ul style="list-style-type: none"> ▪ Electromagnetic effects outside the permitted range. This message appears for a short time only. ▪ Sensor module defective. 	<ul style="list-style-type: none"> ▪ Contact Endress+Hauser Service ▪ Restart device
F140	Working range P LP/HP	<ul style="list-style-type: none"> ▪ Overpressure and low pressure present. ▪ Electromagnetic effects outside the permitted range. ▪ Sensor module defective. 	<ul style="list-style-type: none"> ▪ Check the process pressure ▪ Check sensor module range

Diagnostic event		Cause	Corrective measure
Code	Description		
F162	Sensor conn.	<ul style="list-style-type: none"> ▪ Sensor module defective (master). ▪ Electromagnetic effects outside the permitted range. This message appears for a short time only. 	<ul style="list-style-type: none"> ▪ Check the sensor module cable ▪ Replace sensor module ▪ Contact Endress+Hauser Service
F162	Sensor conn. HP Sensor conn. LP	<ul style="list-style-type: none"> ▪ Electromagnetic effects outside the permitted range. This message appears for a short time only. ▪ Sensor module defective. 	<ul style="list-style-type: none"> ▪ Check the sensor module cable ▪ Replace sensor module ▪ Contact Endress+Hauser Service
F163	Sensor conn.	<ul style="list-style-type: none"> ▪ Cable connection between sensor modules HP and LP interrupted. ▪ Sensor module defective (slave). ▪ Electromagnetic effects outside the permitted range. This message appears for a short time only. 	<ul style="list-style-type: none"> ▪ Restart device ▪ Check the sensor module cable ▪ Contact Endress+Hauser Service
F164	Sensor sync.	<ul style="list-style-type: none"> ▪ The sensor modules cannot be synchronized with each other. ▪ Electromagnetic effects outside the permitted range. This message appears for a short time only. ▪ Sensor module(s) defective. 	<ul style="list-style-type: none"> ▪ Restart device ▪ Replace sensor module ▪ Contact Endress+Hauser Service
F165	Sensor assignment	The assignment of the transmitter to sensor module LP or HP is unknown (e.g. after changing the sensor module). See also "Replacing sensor modules".	<ul style="list-style-type: none"> ▪ Connect transm. set. ▪ Restart device ▪ Contact Endress+Hauser Service
F261	Electronics module	<ul style="list-style-type: none"> ▪ Main electronics defective. ▪ Fault in the main electronics. ▪ Sensor module defective. 	<ul style="list-style-type: none"> ▪ Restart device ▪ Replace electronics
F282	Memory	<ul style="list-style-type: none"> ▪ Main electronics defective. ▪ Fault in the main electronics. 	<ul style="list-style-type: none"> ▪ Replace electronics ▪ Restart device
F283	Memory content	<ul style="list-style-type: none"> ▪ Main electronics defective. ▪ Electromagnetic effects are greater than specifications in the technical data. ▪ The supply voltage is disconnected when writing. ▪ An error occurred when writing. 	<ul style="list-style-type: none"> ▪ Perform a reset ▪ Replace electronics
F411	Up-/Download	<ul style="list-style-type: none"> ▪ The file is defective. ▪ During the download, the data are not correctly transmitted to the processor, e.g. because of open cable connections, spikes (ripple) on the supply voltage or electromagnetic effects. 	<ul style="list-style-type: none"> ▪ Download again ▪ Use another file ▪ Perform a reset
F510	Linearization	The linearization table is being edited.	<ul style="list-style-type: none"> ▪ Conclude entries ▪ Select "linear"
F511	Linearization	The linearization table consists of less than 2 points.	<ul style="list-style-type: none"> ▪ Table too small ▪ Corr. table ▪ Accept the table
F512	Linearization	The linearization table is not monotonic increasing or decreasing.	<ul style="list-style-type: none"> ▪ Tab. not monotonic ▪ Corr. table ▪ Accept the table
F841	Sensor range	<ul style="list-style-type: none"> ▪ Overpressure or low pressure present. ▪ Sensor module defective. 	<ul style="list-style-type: none"> ▪ Check the pressure value ▪ Contact Endress+Hauser Service
F882	Input signal	External measured value is not received or displays a failure status.	<ul style="list-style-type: none"> ▪ Check the bus ▪ Check source device ▪ Check the setting
F945	Pressure limit LP	<ul style="list-style-type: none"> ▪ The configured overpressure or underpressure limit of sensor module LP is exceeded. ▪ Sensor module LP defective. 	<ul style="list-style-type: none"> ▪ Check the pressure value ▪ Change pressure limit value ▪ Contact Endress+Hauser Service

"M" messages

Diagnostic event		Cause	Corrective measure
Code	Description		
M002	Sens. unknown	Sensor module does not suit the device (electronic sensor module nameplate). Device continues measuring.	Contact Endress+Hauser Service
M283	Memory content	<ul style="list-style-type: none"> ▪ Cause as indicated for F283. ▪ Correct measurement can continue as long as you do not need the peakhold indicator function. 	<ul style="list-style-type: none"> ▪ Perform a reset ▪ Replace electronics
M431	Adjustment	The adjustment performed would cause the sensor nominal range to be exceeded or undershot.	<ul style="list-style-type: none"> ▪ Check the measuring range ▪ Check position adjustment ▪ Check the setting
M434	Scaling	<ul style="list-style-type: none"> ▪ Values for adjustment (e.g. lower range value and upper range value) are too close together. ▪ Lower-range value and/or upper-range value exceed or fall below the range limits of the sensor. ▪ The sensor was replaced and the customer-specific configuration does not suit the sensor module. ▪ Unsuitable download carried out. 	<ul style="list-style-type: none"> ▪ Check the measuring range ▪ Check the setting ▪ Contact Endress+Hauser Service
M438	Data set	<ul style="list-style-type: none"> ▪ The supply voltage is disconnected when writing. ▪ An error occurred when writing. 	<ul style="list-style-type: none"> ▪ Check the setting ▪ Restart device ▪ Replace electronics

"C" messages

Diagnostic event		Cause	Corrective measure
Code	Description		
C412	Backup in prog.	Downloading.	Wait for download to complete.
C482	Simul. output	Simulation of the current output is switched on, i.e. the device is not measuring at present.	End the simulation
C484	Error simul.	Fault state simulation is switched on, i.e. the device is not measuring at present.	End the simulation
C824	Process pressure	<ul style="list-style-type: none"> ▪ Electromagnetic effects outside the permitted range. This message appears for a short time only. ▪ Overpressure or low pressure present. 	<ul style="list-style-type: none"> ▪ Check the pressure value ▪ Restart device ▪ Perform a reset



"S" messages

Diagnostic event		Cause	Corrective measure
Code	Description		
S110	Operational range T	<ul style="list-style-type: none"> ▪ Electromagnetic effects outside the permitted range. ▪ Sensor module defective. 	<ul style="list-style-type: none"> ▪ Check the process pressure ▪ Check the temperature range
S140	Working range P LP/HP	<ul style="list-style-type: none"> ▪ Overpressure or low pressure present. ▪ Electromagnetic effects outside the permitted range. ▪ Sensor module defective. 	<ul style="list-style-type: none"> ▪ Check the process pressure ▪ Check the pressure value
S822	Process temp. LP/HP	<ul style="list-style-type: none"> ▪ The temperature measured in the sensor module is greater than the upper nominal temperature of the sensor module. ▪ The temperature measured in the sensor module is smaller than the lower nominal temperature of the sensor module. 	<ul style="list-style-type: none"> ▪ Check temperature ▪ Check the setting

Diagnostic event		Cause	Corrective measure
Code	Description		
S841	Sensor range	<ul style="list-style-type: none"> ▪ Overpressure or low pressure present. ▪ Sensor module defective. 	<ul style="list-style-type: none"> ▪ Check the pressure value ▪ Contact Endress+Hauser Service
S945	Pressure limit LP	<ul style="list-style-type: none"> ▪ The configured overpressure or underpressure limit of the sensor module LP is exceeded. ▪ Sensor module LP defective. 	<ul style="list-style-type: none"> ▪ Check the pressure value ▪ Change pressure limit value ▪ Contact Endress+Hauser Service
S971	Adjustment	<ul style="list-style-type: none"> ▪ The current is outside the permitted range 3.8 to 20.5 mA. ▪ The present pressure value is outside the configured measuring range (but within the sensor module range, if applicable). 	<ul style="list-style-type: none"> ▪ Check the pressure value ▪ Check the measuring range ▪ Check the setting

10.3 Response of output to errors

The response of the current output to errors is defined in the following parameters:

- "Alarm behav. P (050)" →  93
- "Output fail mode (190)" →  94
- "High alarm curr. (052)" →  94

10.4 Firmware history

Date	Firmware version	Modifications	Documentation	
			Operating Instructions	Description of Device Parameters
01.2012	01.00.00	Original firmware. Can be operated via FieldCare from version 2.08.00	BA01044P/00/EN/01.12	GP01013P/00/EN/01.12
			BA01044P/00/EN/02.12	GP01013P/00/EN/02.12
			BA01044P/00/EN/03.12	GP01013P/00/EN/03.12
			BA01044P/00/EN/04.12	GP01013P/00/EN/04.12
			BA01044P/00/EN/05.17	GP01013P/00/EN/05.17

10.5 Disposal

When disposing, separate and recycle the device components based on the materials.

11 Maintenance

No special maintenance work is required.

Keep the pressure compensation and GORE-TEX® filter (1) free from contamination.

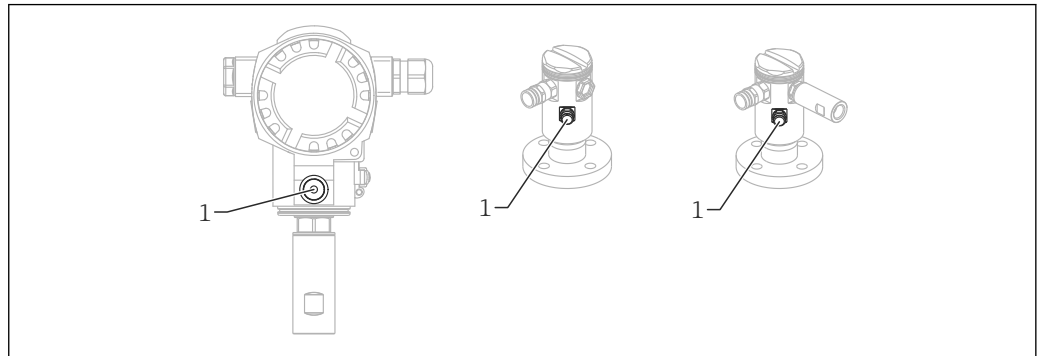

11.1 Information on cleaning

Endress+Hauser provides flushing rings as an accessory to enable cleaning of the process isolating diaphragm without removing the transmitter from the process.

For further information please contact your local Endress+Hauser Sales Center.

11.2 Exterior cleaning

Please note the following points when cleaning the device:

- The cleaning agents used should not corrode the surface and the seals.
- Mechanical damage to the process isolating diaphragm, e.g. due to sharp objects, must be avoided.
- Observe the degree of protection of the device. See the nameplate if necessary → 15.

12 Repairs

12.1 General notes

12.1.1 Repair concept

The Endress+Hauser repair concept requires for devices to have a modular design and for repairs to be carried out by Endress+Hauser Service or by properly trained customers.

Spare parts are grouped into logical kits with the associated replacement instructions.

For more information on service and spare parts, please contact Endress+Hauser Service.

12.1.2 Repair of Ex-certified devices

When repairing Ex-certified devices, please also note the following:

- Only specialist personnel or Endress+Hauser-Service can carry out repairs to Ex certified devices.
- Relevant standards and national regulations as well as safety instructions (XA) and certificates must be observed.
- Only genuine Endress+Hauser spare parts may be used.
- When ordering spare parts, please check the device designation on the nameplate. Identical parts may only be used as replacements.
- Carry out repairs according to the instructions. Following a repair, the device must fulfill the requirements of the individual tests specified for that device.
- A certified device may be converted to another certified device version by Endress +Hauser Service only.
- All repairs and modifications must be documented.

12.1.3 Replacing sensor modules or main electronics

Once both sensor modules or the main electronics have been replaced, the sensor module that is connected to the transmitter must be selected. To do this, follow these steps:

1. Switch off the supply voltage
2. Replacing the sensor module or main electronics
3. Switch on the supply voltage.
4. Select sensor module LP or sensor module HP: Menu path: Expert → System → Management → Transm. connect. (286)"

For additional information, see "Function" →  13 section.

12.1.4 Replacing a device

Once a complete device has been replaced, the parameters can be transferred back into the device using FieldCare:

Prerequisite: The configuration of the old device was saved previously to the computer using FieldCare.

You can continue to measure without performing a new calibration.

12.2 Spare parts

- Some replaceable measuring device components are identified by means of a spare part nameplate. This contains information about the spare part.
- All the spare parts for the measuring device along with the order code are listed in the *W@M Device Viewer* (www.endress.com/deviceviewer) and can be ordered. If available, users can also download the associated Installation Instructions.



Measuring device serial number:

- Located on the device and spare part nameplate.
- Can be read out via the "Serial number" parameter in the "Instrument info" submenu.

12.3 Return

The measuring device must be returned in the event of a factory calibration, or if the wrong device has been ordered or delivered.

As an ISO-certified company and due to legal requirements,

Endress+Hauser is required to follow certain procedures when handling returned products that have been in contact with a medium. To ensure swift, safe and professional device returns, please read the return procedures and conditions on the Endress+Hauser website at www.services.endress.com/return-material

► Select country.

- ↳ The web site of the responsible sales office opens with all of the relevant information relating to returns.

1. If the desired country is not listed:

Click on the "Choose your location" link.

- ↳ An overview of Endress+Hauser sales offices and representatives opens.









2. Contact your Endress+Hauser sales office or representative.







13 Overview of the operating menu

i Depending on the parameter configuration, not all submenus and parameters are available. Information on this can be found in the parameter description under "Prerequisite".

		Direct access	Description		
Language		000	→ 78		
Display/operat.	Display mode	001	→ 78		
	2nd disp. value	002	→ 78		
	3rd disp. value	288	→ 79		
	Format 1st Value	004	→ 79		
	HART input form.	157	→ 80		
Setup	Measuring mode	005	→ 80		
	Measuring mode (read only)	182			
	High press. side	183	→ 81		
	Press. eng. unit	125	→ 81		
	Corrected press. (read only)	172	→ 81		
	Pos. zero adjust	007	→ 81		
	Empty calib. ("Level" measuring mode and "Calibration mode" = wet)	028 011	→ 82		
	Full calib. ("Level" measuring mode and "Calibration code" = wet)	031 012	→ 82		
	Set LRV ("Pressure" measuring mode)	013	→ 83		
	Set URV ("Pressure" measuring mode)	014	→ 83		
	Damping switch (read only)	164	→ 83		
	Damping	017	→ 84		
	Damping (read only)	184			
	Level before Lin ("Level" measuring mode)	019	→ 84		
	Meas.Diff.Press. (read only)	020	→ 84		
	Extended setup	Code definition	023	→ 85	
		Device tag	022	→ 85	
		Operator code	021	→ 85	
		Level ("Level" measuring mode)	Level selection	024	→ 86
			Unit before lin.	025	→ 86
Height unit			026	→ 87	
Calibration mode			027	→ 87	
Empty calib.			028	→ 82	
Empty calib. (read only)			011		
Empty pressure			029	→ 88	
Empty pressure (read only)			185		
Empty height			030	→ 88	
Empty height (read only)			186		
Full calib.			031	→ 82	
Full Calib. (read only)			012		
Full pressure	032		→ 89		
Full pressure (read only)	187				
Full height	033	→ 89			
Full height (read only)	188				

		Direct access	Description
	Adjust density	034	→ 90
	Process density	035	→ 90
	Level before Lin (read only)	019	→ 84
Linearization	Lin. mode	037	→ 91
	Unit after lin.	038	→ 91
	Line number:	039	→ 92
	X-value.: (edit mode)	040	→ 92
	X-value: (semi-automatic)	193	
	X-value: (read only)	123	
	Y-value: (edit mode)	041	→ 92
	Y-value: (semi-automatic)	041	
	Y-value: (read only)	194	
	Edit table	042	→ 92
	Tank description	173	→ 93
	Tank content (read only)	043	→ 93
Current output	Alarm behav. P	050	→ 93
	Alarm cur.switch (read only)	165	→ 94
	Output fail mode	190	→ 94
	Output fail mode (read only)	051	
	High alarm curr.	052	→ 94
	Set min. current	053	→ 95
	Output current (read only)	054	→ 95
	Get LRV (only "Pressure")	015	→ 95
	Set LRV	013	→ 83
	Get URV (only "Pressure")	016	→ 96
	Set URV	014	→ 83
Diagnostics	Diagnostic code (read only)	071	→ 97
	Last diag. code (read only)	072	→ 97
Sensor HP	Min. meas.press. (read only)	073	→ 97
	Counter P < Pmin (read only)	262	→ 97
	Max. meas.press. (read only)	074	→ 98
	Counter P > Pmax (read only)	263	→ 98
	Min. meas.Temp. (read only)	264	→ 98
	Max. meas.Temp. (read only)	265	→ 98
Sensor LP	Min. meas.press. (read only)	266	→ 99
	Counter P < Pmin (read only)	267	→ 99
	Max. meas.press. (read only)	268	→ 99
	Counter P > Pmax (read only)	269	→ 99
	Min. meas.Temp. (read only)	270	→ 100
	Max. meas.Temp. (read only)	271	→ 100
Diagnostic list	Diagnostic 1 (read only)	075	→ 100
	Diagnostic 2 (read only)	076	→ 100
	Diagnostic 3 (read only)	077	→ 100
	Diagnostic 4 (read only)	078	→ 100
	Diagnostic 5 (read only)	079	→ 100



		Direct access	Description
	Diagnostic 6 (read only)	080	→  100
	Diagnostic 7 (read only)	081	→  100
	Diagnostic 8 (read only)	082	→  100
	Diagnostic 9 (read only)	083	→  100
	Diagnostic 10 (read only)	084	→  100
Event logbook	Last diag. 1 (read only)	085	→  100
	Last diag. 2 (read only)	086	→  100
	Last Diag. 3 (read only)	087	→  100
	Last diag. 4 (read only)	088	→  100
	Last diag. 5 (read only)	089	→  100
	Last diag. 6 (read only)	090	→  100
	Last diag. 7 (read only)	091	→  100
	Last diag. 8 (read only)	092	→  100
	Last diag. 9 (read only)	093	→  100
	Last diag. 10 (read only)	094	→  100
Instrument info	Firmware version (read only)	095	→  101
	Serial number (read only)	096	→  101
	Ext. order code (read only)	097	→  101
	Order code (read only)	098	→  102
	Cust. tag number	254	→  102
	Device tag	022	→  85
	ENP Version (read only)	099	→  102
	Config. counter (read only)	100	→  103
	Manufacturer ID (read only)	103	→  103
	Device type code (read only)	279	→  103
	Device revision (read only)	108	→  103
	Sens. limit HP		
		LRL sensor (read only)	101 →  104
		URL sensor (read only)	102 →  104
	Sens. limit LP		
		LRL sensor (read only)	272 →  104
		URL sensor (read only)	273 →  104
Measured values	Level before Lin (read only)	019	→  84
	Tank content (read only)	043	→  93
	Meas.Diff.Press. (read only)	020	→  84
	Sensor press. HP (read only)	109	→  106
	Sensor press. LP (read only)	280	→  106
	Meas. press. HP (read only)	281	→  106
	Meas. press. LP (read only)	282	→  106
	Corrected press. (read only)	172	→  81
	Sensor temp. HP (read only)	110	→  107
	Sensor temp. LP (read only)	283	→  107
Simulation	Simulation mode	112	→  107
	Sim. diff.press.	113	→  108
	Sim. press. HP	284	→  109

		Direct access	Description
	Sim. press. LP	285	→  109
	Sim. level	115	→  109
	Sim. tank cont.	116	→  109
	Sim. current	117	→  110
	Sim. error no.	118	→  110
Reset	Reset	124	→  110

14 Description of Device Parameters



14.1 Language

Language (000)



Navigation	  Main menu → Language
Write permission	Operators/Service engineers/Expert
Description	Select the menu language for the local display.
Options	<ul style="list-style-type: none"> ▪ English ▪ Another language (as selected when ordering the device) ▪ Possibly a third language (language of the manufacturing plant)
Factory setting	English

14.2 Display/operat.

Display mode (001)

Navigation	  Display/operat. → Display mode (001)
Write permission	Operators/Service engineers/Expert
Description	Specify the contents for the first line of the local display in measuring mode.
Options	<ul style="list-style-type: none"> ▪ Primary value ▪ External value ▪ All alternating
Factory setting	Primary value

2nd disp. value (002)

Navigation	  Display/Operat. → 2nd disp. value (002)
Write permission	Operators/Service engineers/Expert
Description	Specify the contents for the second value in the alternating display mode in measuring mode.

Options	<ul style="list-style-type: none"> ■ No value ■ Differential pressure ■ Pressure HP ■ Pressure LP ■ Sensor temp. HP ■ Sensor temp. LP ■ Level before linearization ■ Current ■ Main measured value (%) <p>The options depend on the measuring mode chosen.</p>
Factory setting	No value

3rd disp. value (288)

Navigation	 Display/Operat. → 3rd disp. value (288)
Write permission	Operators/Service engineers/Expert
Description	Specify the contents for the third value in the alternating display mode in measuring mode.
Options	<ul style="list-style-type: none"> ■ No value ■ Differential pressure ■ Pressure HP ■ Pressure LP ■ Sensor temp. HP ■ Sensor temp. LP ■ Level before linearization ■ Current ■ Main measured value (%) <p>The options depend on the measuring mode chosen.</p>
Factory setting	No value

Format 1st value (004)

Navigation	 Display/operat. → Format 1st value (004)
Write permission	Operators/Service engineers/Expert
Description	Specify the number of places after the decimal point for the value displayed in the main line.

Options	<ul style="list-style-type: none"> ■ Auto ■ x ■ x.x ■ x.xx ■ x.xxx ■ x.xxxx ■ x.xxxxx
Factory setting	Auto

HART input form. (157)

Navigation	 Display/Operat. → HART input form. (157)
Write permission	Operators/Service engineers/Expert
Description	Number of decimal places of the displayed input value.
Options	<ul style="list-style-type: none"> ■ x.x ■ x.xx ■ x.xxx ■ x.xxxx ■ x.xxxxx
Factory setting	x.x

14.3 Setup

Measuring mode (005/182)

⚠ WARNING



Changing the measuring mode affects the span (URV)

This situation can result in product overflow.



- ▶ If the measuring mode is changed, the setting for the span (URV) must be checked in the "Setup" operating menu and readjusted if necessary.

Navigation	 Setup → Measuring mode (005/182)
Write permission	Operators/Service engineers/Expert
Description	Select the measuring mode. The operating menu is structured differently depending on the measuring mode selected.
Options	<ul style="list-style-type: none"> ■ Pressure ■ Level
Factory setting	Level or according to order specifications





High press. side (183)

Navigation	  Setup → High press. side (183)
Write permission	Operators/Service engineers/Expert
Description	Define which sensor module corresponds to the high-pressure side.
Options	<ul style="list-style-type: none"> ■ Sensor HP ■ Sensor LP
Factory setting	Sensor HP



Press. eng. unit (125)

Navigation	  Setup → Press. eng. unit (125)
Write permission	Operators/Service engineers/Expert
Description	Select the pressure engineering unit. If a new pressure engineering unit is selected, all pressure-specific parameters are converted and displayed with the new unit.
Options	<ul style="list-style-type: none"> ■ mbar, bar ■ mmH2O, mH2O ■ in, H2O, ftH2O ■ Pa, kPa, MPa ■ psi ■ mmHg, inHg ■ kgf/cm²
Factory setting	mbar, bar or psi depending on the sensor module nominal measuring range, or as per order specifications



Corrected press. (172)

Navigation	  Setup → Corrected press. (172)   Diagnosis → Measured values → Corrected press. (172)
Write permission	No write permissions. Parameter is read only.6
Description	Displays the measured differential pressure after position adjustment.



Pos. zero adjust (007)

Navigation	  Setup → Pos. zero adjust (007)
Write permission	Operators/Service engineers/Expert
Description	Position adjustment – the pressure difference between zero (set point) and the measured pressure need not be known.
Example	<ul style="list-style-type: none"> ■ Measured value = 2.2 mbar (0.033 psi) ■ You correct the measured value via the "Pos. zero adjust" parameter with the "Confirm" option. This means that you are assigning the value 0.0 to the pressure present. ■ Measured value (after position adjustment) = 0.0 mbar ■ The current value is also corrected.
Options	<ul style="list-style-type: none"> ■ Confirm ■ Cancel
Factory setting	Cancel

Empty calib. (011/028)

Navigation	  Setup → Extended setup → Level → Empty calib. (011/028)
Write permission	Operators/Service engineers/Expert
Description	Enter the output value for the lower calibration point (vessel empty). The unit defined in "Unit before lin." must be used.
Note	<ul style="list-style-type: none"> ■ In the case of wet calibration, the level (vessel empty) must actually be available. The associated pressure is then automatically recorded by the device. ■ In the case of dry calibration, the level (vessel empty) does not have to be available. For the "In pressure" level selection, the associated pressure must be entered in the "Empty pressure (029)" parameter. The associated height has to be entered in the "Empty height" (030) parameter for the "In height" level selection.
Factory setting	0.0





Full calib. (012/031)

Navigation	  Setup → Extended setup → Level → Full calib. (012/031)
Write permission	Operators/Service engineers/Expert
Description	Enter the output value for the upper calibration point (vessel full). The unit defined in "Unit before lin." must be used.





Note	<ul style="list-style-type: none"> ■ In the case of wet calibration, the level (vessel full) must actually be available. The associated pressure is then automatically recorded by the device. ■ In the case of dry calibration, the level (vessel full) does not have to be available. For the "In pressure" level selection, the associated pressure must be entered in the "Full pressure" parameter. The associated height has to be entered in the "Full height" parameter for the "In height" level selection.
-------------	--

Factory setting 100.0



Set LRV (013, 056, 166, 168)

Navigation	  Setup → Set LRV (013, 056, 166, 168)   Setup → Extended setup → Current output → Set LRV (013, 056, 166, 168)
Write permission	Operators/Service engineers/Expert
Description	Set the pressure value, level or content for the lower current value (4 mA).
Factory setting	<ul style="list-style-type: none"> ■ 0.0 % in Level measuring mode ■ 0.0 mbar/bar or in accordance with ordering information in Pressure measuring mode

Set URV (014, 057, 167, 169)

Navigation	  Setup → Set URV (014, 057, 167, 169)   Setup → Extended setup → Current output → Set URV (014, 057, 167, 169)
Write permission	Operators/Service engineers/Expert
Description	Set the pressure value, level or content for the upper current value (20 mA).
Factory setting	<ul style="list-style-type: none"> ■ 100.0 % in Level measuring mode ■ URL Sensor or according to ordering information in Pressure measuring mode

Damping switch (164)

Navigation	  Setup → Damping switch (164)
Write permission	No write permissions. Parameter is read only.
Description	Displays the switch position of DIP switch 2 which is used to switch the damping of the output signal on and off.

Display	<ul style="list-style-type: none"> ▪ Off The output signal is not damped. ▪ On The output signal is damped. The attenuation constant is specified in the "Damping" (017) (184) parameter
----------------	--

Factory setting On

Damping (017)/(184)

Navigation   Setup → Damping (017)/(184)







Write permission Operators/Service engineers/Expert
(if the "Damping" DIP switch is set to "on")

Description Enter damping time (time constant τ) ("Damping" DIP switch set to "on")
Display damping time (time constant τ) ("Damping" DIP switch set to "off").
The damping affects the speed at which the measured value reacts to changes in pressure.

Input range 0.0 to 999.0 s

Factory setting 2.0 sec. or according to order specifications





Level before lin. (019)

Navigation   Setup → Level before lin. (019)
  Setup → Extended setup → Level → Level before lin. (019)
  Diagnosis → Measured values → Level before lin. (019)

Write permission No write permissions. Parameter is read only.

Description Displays the level value prior to linearization.

Meas.Diff.Press. (020)

Navigation   Setup → Meas.Diff.Press. (020)
  Diagnosis → Measured values → Meas.Diff.Press. (020)

Write permission No write permissions. Parameter is read only.

Description Displays the measured differential pressure after sensor trim, position adjustment and damping.

Sensor pressure LP	Measured pressure LP
↑	↑

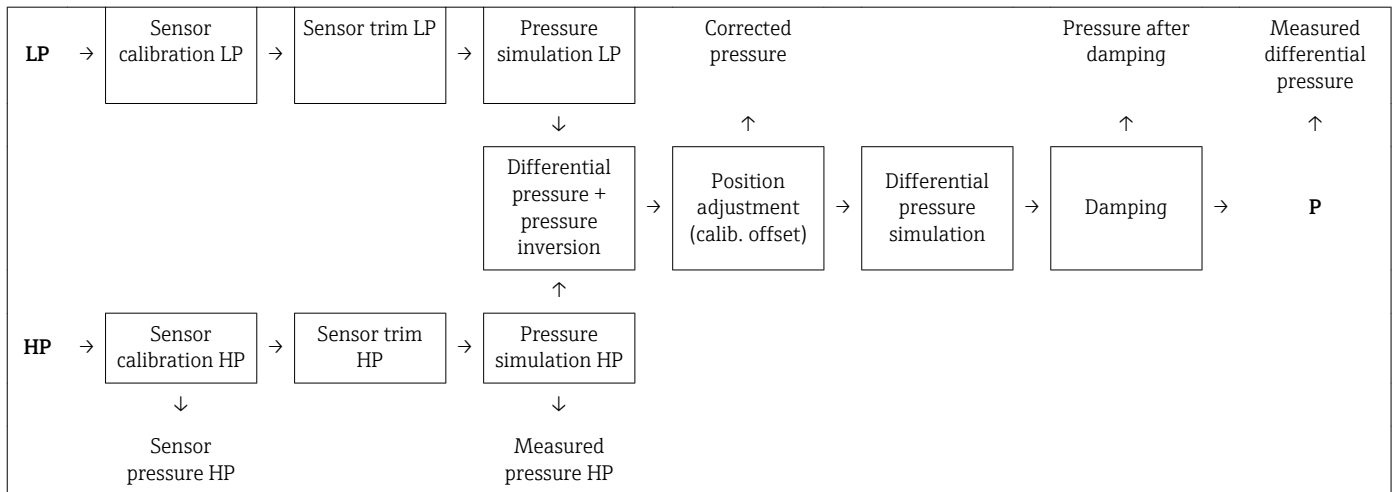

14.4 Setup → Extended Setup

Code definition (023)

Navigation	Setup → Extended setup → Code definition (023)
Write permission	Operators/Service engineers/Expert
Description	Use this function to enter a release code with which the device can be unlocked.
Options	A number from 0 to 9999
Factory setting	0

Device tag (022)

Navigation	Setup → Extended setup → Device tag (022)
Write permission	Operators/Service engineers/Expert
Description	Enter the device tag e.g. TAG number (max. 32 alphanumeric characters).
Factory setting	No entry or according to order specifications

Operator code (021)

Navigation	Setup → Extended setup → Operator code (021)
-------------------	--

Write permission	Operators/Service engineers/Expert
Description	Use this function to enter a code to lock or unlock operation.
User entry	<ul style="list-style-type: none"> ■ To lock: Enter a number ≠ the release code (value range: 1 to 9999). ■ To unlock: Enter the release code.
Note	The release code is "0" in the order configuration. Another release code can be defined in the "Code definition" parameter. If the user has forgotten the release code, the release code can be visible by entering the number "5864".
Factory setting	0

14.5 Setup → Extended Setup → Level ("Level" measuring mode)

Level selection (024)



Navigation	 Setup → Extended setup → Level → Level selection (024)
Write permission	Operators/Service engineers/Expert
Description	Select the method for calculating the level
Options	<ul style="list-style-type: none"> ■ In pressure If this option is selected, specify two pressure/level value pairs. The level value is displayed directly in the unit that you select via the "Unit before lin." parameter. ■ In height If this option is selected, specify two height/level value pairs. From the measured pressure, the device first calculates the height using the density. This information is then used to calculate the level in the "Unit before lin." selected using the two value pairs specified.
Factory setting	In pressure

Unit before lin. (025)



Navigation	 Setup → Extended setup → Level → Unit before lin. (025)
Write permission	Operators/Service engineers/Expert
Description	Select the unit for the measured value display for the level before linearization.
Example	<ul style="list-style-type: none"> ■ Current measured value: 0.3 ft ■ New output unit: m ■ New measured value: 0.3 m

Options	<ul style="list-style-type: none"> ■ % ■ mm, cm, dm, m ■ ft, in ■ m³, in³ ■ l, hl ■ ft³ ■ gal, lgal ■ kg, t ■ lb
Note	The unit selected is only used to describe the measured value. This means that when selecting a new output unit, the measured value is not converted.
Factory setting	%

Height unit (026)

Navigation	  Setup → Extended setup → Level → Height unit (026)
Write permission	Operators/Service engineers/Expert
Description	Select the height unit. The measured pressure is converted to the selected height unit using the "Adjust Density" parameter.
Prerequisite	"Level selection" = "In height"
Options	<ul style="list-style-type: none"> ■ mm ■ m ■ in ■ ft
Factory setting	m

Calibration mode (027)

Navigation	  Setup → Extended setup → Level → Calibration mode (027)
Write permission	Operators/Service engineers/Expert
Description	Select the calibration mode.
Options	<ul style="list-style-type: none"> ■ Wet Wet calibration takes place by filling and emptying the vessel. In the case of two different levels, the level, volume, mass or percentage value entered is assigned to the pressure measured at this point in time ("Empty calib." and "Full calib." parameters). ■ Dry Dry calibration is a theoretical calibration. For this calibration, you specify two pressure-level value pairs or height-level value pairs via the following parameters: "Empty calib.", "Empty pressure", "Empty height", "Full calib.", "Full pressure", "Full height".

Factory setting Wet

Empty calib. (011/028)

Navigation   Setup → Extended setup → Level → Empty calib. (011/028)

Write permission Operators/Service engineers/Expert

Description Enter the output value for the lower calibration point (vessel empty). The unit defined in "Unit before lin." must be used.

Note

- In the case of wet calibration, the level (vessel empty) must actually be available. The associated pressure is then automatically recorded by the device.
- In the case of dry calibration, the level (vessel empty) does not have to be available. For the "In pressure" level selection, the associated pressure must be entered in the "Empty pressure (029)" parameter. The associated height has to be entered in the "Empty height" (030) parameter for the "In height" level selection.

Factory setting 0.0

Empty pressure (029)/(185)

Navigation   Setup → Extended setup → Level → Empty pressure (029)/(185)

Write permission Operators/Service engineers/Expert

Description Enter the pressure value for the lower calibration point (vessel empty). See also "Empty calib. (028)".

Prerequisite

- "Level selection" = In pressure
- "Calibration mode" = Dry -> entry
- "Calibration mode" = Wet -> display

Factory setting 0.0

Empty height (030)/(186)

Navigation   Setup → Extended setup → Level → Empty height (030)/(186)

Write permission Operators/Service engineers/Expert



Description Enter the height value for the lower calibration point (vessel empty). The unit is selected via the "Height unit (026)" parameter.

Prerequisite

- "Level selection" = "In height"
- "Calibration mode" = Dry -> entry
- "Calibration mode" = Wet -> display

Factory setting 0.0

Full calib. (012/031)

Navigation   Setup → Extended setup → Level → Full calib. (012/031)

Write permission Operators/Service engineers/Expert

Description Enter the output value for the upper calibration point (vessel full). The unit defined in "Unit before lin." must be used.

Note

- In the case of wet calibration, the level (vessel full) must actually be available. The associated pressure is then automatically recorded by the device.
- In the case of dry calibration, the level (vessel full) does not have to be available. For the "In pressure" level selection, the associated pressure must be entered in the "Full pressure" parameter. The associated height has to be entered in the "Full height" parameter for the "In height" level selection.

Factory setting 100.0

Full pressure (032)/(187)

Navigation   Setup → Extended setup → Level → Full pressure (032)/(187)

Write permission Operators/Service engineers/Expert

Description Enter the pressure value for the upper calibration point (vessel full). See also "Full calib.".

Prerequisite

- "Level selection" = In pressure
- "Calibration mode" = Dry -> entry
- "Calibration mode" = Wet -> display

Factory setting URL of the sensor module

Full height (033)/(188)

Navigation   Setup → Extended setup → Level → Full height (033)/(188)



Write permission Operators/Service engineers/Expert

Description Enter the height value for the upper calibration point (vessel full). The unit is selected via the "Height unit" parameter.

Prerequisite	<ul style="list-style-type: none"> ■ "Level selection" = "In height" ■ "Calibration mode" = Dry -> entry ■ "Calibration mode" = Wet -> display
---------------------	---

Factory setting	URL is converted to a level unit
------------------------	----------------------------------

Adjust density (034)



Navigation	  Setup → Extended setup → Level → Adjust density (034)
-------------------	---

Write permission	Operators/Service engineers/Expert
-------------------------	------------------------------------

Description	Enter the density of the medium used to perform the calibration. The measured pressure is converted to a height using the "Height unit" and "Adjust density" parameters.
--------------------	--

Factory setting	1.0
------------------------	-----

Process density (035)

Navigation	  Setup → Extended setup → Level → Process density (035)
-------------------	--







Write permission	Operators/Service engineers/Expert
-------------------------	------------------------------------

Description	Enter a new density value for density correction. The calibration was carried out with the medium water, for example. Now the vessel is to be used for another medium with another density. The calibration is corrected appropriately by entering the new density value in the "Process Density" parameter.
--------------------	--

Note	If you change to dry calibration after completing a wet calibration using the "Calibration mode" parameter, the density for the "Adjust density" and "Process density" parameters must be entered correctly before changing the calibration mode.
-------------	---

Factory setting	1.0
------------------------	-----

Level before lin. (019)

Navigation	  Setup → Level before lin. (019)   Setup → Extended setup → Level → Level before lin. (019)   Diagnosis → Measured values → Level before lin. (019)
-------------------	--

Write permission	No write permissions. Parameter is read only.
-------------------------	---

Description	Displays the level value prior to linearization.
--------------------	--

14.6 Setup → Extended Setup → Linearization



Lin. mode (037)

Navigation	 Setup → Extended setup → Linearization → Lin. mode (037)
Write permission	Operators/Service engineers/Expert
Description	Select the linearization mode.
Options	<ul style="list-style-type: none"> ■ Linear The level is output without being converted beforehand. "Level before lin" is output. ■ Erase table The existing linearization table is deleted. ■ Manual entry (sets the table to edit mode, an alarm is output): The value pairs of the table (X-value (193/040) and Y-value (041)) are entered manually. ■ Semi-automatic entry (sets the table to edit mode, an alarm is output): The vessel is emptied or filled in stages in this entry mode. The device automatically records the level value (X-value (193/040)). The associated volume, mass or % value is entered manually (Y-value (041)). ■ Activate table The table entered is activated and checked with this option. The device shows the level after linearization.
Factory setting	Linear



Unit after lin. (038)

Navigation	 Setup → Extended Setup → Linearization → Unit after lin. (038)
Write permission	Operators/Service engineers/Expert
Description	Select volume unit, mass, height or % (unit of the Y-value).
Options	<ul style="list-style-type: none"> ■ % ■ cm, dm, m, mm ■ hl ■ in³, ft³, m³, ■ l ■ in, ft ■ kg, t ■ lb ■ gal ■ lgal
Factory setting	%



Line number (039)

Navigation	  Setup → Extended setup → Linearization → Line number (039)
Write permission	Operators/Service engineers/Expert
Description	Enter the number of the current point in the table. The subsequent entries in "X-value" and "Y-value" refer to this point.
Input range	1 to 32



X-value (040)/(123)/(193)

Navigation	  Setup → Extended setup → Linearization → X-value (040)/(123)/(193)
Write permission	Operators/Service engineers/Expert
Description	Enter the X-value (level before linearization) for the specific point in the table and confirm.
Note	<ul style="list-style-type: none"> ▪ If "Lin. mode" = "Manual", the level value must be entered. ▪ If "Lin. mode" = "Semiautomatic", the level value is displayed and has to be confirmed by entering the paired Y-value.

Y-value (041)/(194)

Navigation	  Setup → Extended setup → Linearization → Y-value (041)/(194)
Write permission	Operators/Service engineers/Expert
Description	Enter the Y-value (value after linearization) for the specific point in the table. The unit is determined by "Unit after lin.".
Note	The linearization table must be monotonic (increasing or decreasing).

Edit table (042)



Navigation	  Setup → Extended setup → Linearization → Edit table (042)
Write permission	Operators/Service engineers/Expert
Description	Select the function for entering the table.

Options	<ul style="list-style-type: none"> ■ Next point: Enter the next point. ■ Current point: Stay on the current point to correct a mistake, for example. ■ Last point: Skip back to the previous point to correct a mistake, for example. ■ Insert point: Insert an additional point (see example below). ■ Delete point: Delete the current point (see example below).
Example	<p>Add point, in this case between the 4th and 5th point for example</p> <ul style="list-style-type: none"> ■ Select point 5 via the "Line number" parameter. ■ Select the "Insert point" option via the "Edit table" parameter. ■ Point 5 is displayed for the "Line number" parameter. Enter new values for the "X-value" and "Y-value" parameters. <p>Delete point, in this case the 5th point for example</p> <ul style="list-style-type: none"> ■ Select point 5 via the "Line number" parameter. ■ Select the "Delete point" option via the "Edit table" parameter. ■ The 5th point is deleted. All of the following points are pushed up one number i.e. following deletion, the 6th point becomes Point 5.
Factory setting	Current point

Tank description (173)

Navigation	 Setup → Extended setup → Linearization → Tank description (173)
Write permission	Operators/Service engineers/Expert
Description	Enter tank description (max. 32 alphanumeric characters).

Tank content (043)

Navigation	 Setup → Extended setup → Linearization → Tank content (043)  Diagnosis → Measured values → Tank content (043)
Write permission	Operators/Service engineers/Expert
Description	Displays the level value after linearization.



14.7 Setup → Extended Setup → Current output

Alarm behav. P (050)



Navigation	 Setup → Extended setup → Current output → Alarm behav. P (050)
Write permission	Operators/Service engineers/Expert

Description	Set current output if sensor module limits are exceeded or not reached.
Options	<ul style="list-style-type: none"> ▪ Warning The device continues to measure. An error message is displayed. ▪ Alarm The output signal assumes a value that can be defined by the "Output fail mode (190)/(051)" function. ▪ Special <ul style="list-style-type: none"> - The lower sensor module limit is undershot (sensor module LP or HP or complete system): Current output = 3.6 mA - The upper sensor module limit is overshoot (sensor module LP or HP or complete system): Current output assumes a value of 21 - 23 mA, depending on the setting of the "High alarm curr." (052) parameter.
Factory setting	Warning



Alarm cur. switch (165)

Navigation	  Setup → Extended setup → Current output → Alarm cur.switch (165)
Write permission	No write permissions. Parameter is read only.
Description	Displays the switching state of DIP switch 3 "SW/Alarm min."
Display	<ul style="list-style-type: none"> ▪ SW setting The alarm current has the value defined in "Output fail mode" (051). ▪ Alarm min. The alarm current is 3.6 mA, regardless of the software setting.



Output fail mode (051)/(190)

Navigation	  Setup → Extended setup → Current output → Output fail mode (051)/(190)
Write permission	Operators/Service engineers/Expert
Description	Select Output fail mode. In case of an alarm, the current and the bargraph assume the current value specified with this parameter.
Options	<ul style="list-style-type: none"> ▪ Max: can be set from 21 to 23 mA ▪ Hold: last measured value is held. ▪ Min: 3.6 mA
Factory setting	Max (22 mA)



High. alarm curr. (052)

Navigation	  Setup → Extended setup → Current output → High alarm curr. (052)
Write permission	Operators/Service engineers/Expert
Description	Enter the current value for maximum alarm current. See also "Output fail mode".
Input range	21 to 23 mA
Factory setting	22 mA



Set min. current (053)

Navigation	  Setup → Extended setup → Current output → Set min. current (053)
Write permission	Operators/Service engineers/Expert
Description	Enter lower current limit. Some switching units accept no current smaller than 4.0 mA.
Options	<ul style="list-style-type: none"> ■ 3.8 mA ■ 4.0 mA
Factory setting	3.8 mA

Output current (054)





Navigation	  Setup → Extended setup → Current output → Output current (054)
Write permission	Operators/Service engineers/Expert
Description	Displays the current current value.

Get LRV (015)

Navigation	  Setup → Extended . setup → Current output → Get LRV (015)
Write permission	Operators/Service engineers/Expert
Description	Setting lower range value. The pressure for the lower current value (4 mA) is present at the device. Use the "Confirm" option to assign the lower current value to the applied pressure value.
Prerequisite	Pressure measuring mode
Options	<ul style="list-style-type: none"> ■ Cancel ■ Confirm

Factory setting Cancel

Set LRV (013, 056, 166, 168)

Navigation   Setup → Set LRV (013, 056, 166, 168)
  Setup → Extended setup → Current output → Set LRV (013, 056, 166, 168)

Write permission Operators/Service engineers/Expert

Description Set the pressure value, level or content for the lower current value (4 mA).

Factory setting

- 0.0 % in Level measuring mode
- 0.0 mbar/bar or in accordance with ordering information in Pressure measuring mode

Get URV (016)

Navigation   Setup → Extended setup → Current output → Get URV (016)

Write permission Operators/Service engineers/Expert

Description Setting upper range value. The pressure for the upper current value (20 mA) is present at the device. Use the "Confirm" option to assign the applied pressure value to the upper current value.





Prerequisite Pressure measuring mode

Options

- Cancel
- Confirm

Factory setting Cancel

Set URV (014, 057, 167, 169)

Navigation   Setup → Set URV (014, 057, 167, 169)
  Setup → Extended setup → Current output → Set URV (014, 057, 167, 169)

Write permission Operators/Service engineers/Expert

Description Set the pressure value, level or content for the upper current value (20 mA).

Factory setting

- 100.0 % in Level measuring mode
- URL Sensor or according to ordering information in Pressure measuring mode

14.8 Diagnostics

Diagnostic code (071)

Navigation	 Diagnosis → Diagnostic code (071)
Write permission	No write permissions. Parameter is read only.
Description	Displays the diagnostic message with the highest priority currently present.

Last diag. code (072)

Navigation	 Diagnosis → Last diag. code (072)
Write permission	No write permissions. Parameter is read only.
Description	Displays the last diagnostic message that occurred and was rectified.
Note	<ul style="list-style-type: none"> ▪ Digital communication: the last message is displayed. ▪ Use the "Reset logbook" parameter to clear the messages listed in the parameter "Last diag. code".

14.9 Diagnosis → Sensor HP

Min. meas. press. (073)

Navigation	 Diagnosis → Sensor HP → Min. meas. press. (073)
Write permission	No write permissions. Parameter is read only.
Description	Displays the lowest pressure value measured (peakhold indicator). You can reset this indicator by means of the "Reset peakhold" parameter.

COUNTER P < Pmin (262)

Navigation	 Diagnosis → Sensor HP → Counter P < Pmin (262)
Write permission	No write permissions. Parameter is read only.
Description	Displays the negative pressure counter for the respective sensor module. The counter is incremented each time error 841 occurs. You can reset this value using the "Reset peakhold (161)" parameter.

Max. meas. press. (074)

Navigation	 Diagnosis → Sensor HP → Max. meas. press. (074)
Write permission	No write permissions. Parameter is read only.
Description	Displays the highest pressure value measured (peakhold indicator). You can reset this indicator by means of the "Reset peakhold" parameter.

Counter P > Pmax (263)

Navigation	 Diagnosis → Sensor HP → Counter P > Pmax (263)
Write permission	No write permissions. Parameter is read only.
Description	Displays the overpressure counter for the respective sensor module. The limit value is: upper sensor module nominal value + 10% of upper sensor module nominal value. You can reset this value using the "Reset peakhold (161)" parameter.

Min. meas.temp. (264)

Navigation	 Diagnosis → Sensor HP → Min. meas.temp. (264)
Write permission	No write permissions. Parameter is read only.
Description	Displays the smallest temperature measured in the sensor module. You can reset this value using the "Reset peakhold (161)" parameter.

Max. meas. temp. (265)

Navigation	 Diagnosis → Sensor HP → Max. meas. temp. (265)
Write permission	No write permissions. Parameter is read only.
Description	Displays the largest temperature measured in the sensor module. You can reset this value using the "Reset peakhold (161)" parameter.

14.10 Diagnosis → Sensor LP

Min. meas. press. (266)

Navigation	 Diagnosis → Sensor LP → Min. meas. press. (266)
Write permission	No write permissions. Parameter is read only.
Description	Displays the lowest pressure value measured (peakhold indicator). You can reset this indicator by means of the "Reset peakhold" parameter.

Counter P < Pmin (267)

Navigation	 Diagnosis → Sensor LP → Counter P < Pmin (267)
Write permission	No write permissions. Parameter is read only.
Description	Displays the negative pressure counter for the respective sensor module. The counter is incremented each time error 841 occurs. You can reset this value using the "Reset peakhold (161)" parameter.



Max. meas. press. (268)

Navigation	 Diagnosis → Sensor LP → Max. meas. press. (268)
Write permission	No write permissions. Parameter is read only.
Description	Displays the highest pressure value measured (peakhold indicator). You can reset this peak indicator via the "Reset peakhold (161)" parameter.



Counter P > Pmax (269)

Navigation	 Diagnosis → Sensor LP → Counter P > Pmax (269)
Write permission	No write permissions. Parameter is read only.
Description	Displays the overpressure counter for the respective sensor module. The limit value is: upper sensor module nominal value + 10% of upper sensor module nominal value. You can reset this value using the "Reset peakhold (161)" parameter.

Min. meas.temp. (270)

Navigation	  Diagnosis → Sensor LP → Min. meas.temp. (270)
Write permission	No write permissions. Parameter is read only.
Description	Displays the smallest temperature measured in the sensor module. You can reset this value using the "Reset peakhold (161)" parameter.



Max. meas. temp. (271)

Navigation	  Diagnosis → Sensor LP → Max. meas. temp. (271)
Write permission	No write permissions. Parameter is read only.
Description	Displays the largest temperature measured in the sensor module. You can reset this value using the "Reset peakhold (161)" parameter.

14.11 Diagnostic → Diagnostic list

Diagnostic list

Diagnostic 1 (075)
 Diagnostic 2 (076)
 Diagnostic 3 (077)
 Diagnostic 4 (078)
 Diagnostic 5 (079)
 Diagnostic 6 (080)
 Diagnostic 7 (081)
 Diagnostic 8 (082)
 Diagnostic 9 (083)
 Diagnostic 10 (084)

Navigation	  Diagnosis → Diagnostic list
Write permission	No write permissions. Parameter is read only.
Description	This parameter contains up to ten diagnosis messages that are currently pending, arranged in order of priority.

14.12 Diagnosis → Event logbook

Event logbook

Last diag. 1 (085)
 Last diag. 2 (086)
 Last diag. 3 (087)
 Last diag. 4 (088)
 Last diag. 5 (089)
 Last diag. 6 (090)
 Last diag. 7 (091)
 Last diag. 8 (092)
 Last diag. 9 (093)
 Last diag. 10 (094)



Navigation   Diagnosis → Event logbook

Write permission No write permissions. Parameter is read only.

Description This parameter contains the last 10 diagnosis messages to occur and be rectified. They can be reset using the "Reset logbook" parameter. Errors which have occurred multiple times are displayed once only.
 Errors may also appear multiple times if another error has occurred in the meantime. The messages are displayed in chronological order.

14.13 Diagnosis → Instrument info



Firmware version (095)

Navigation   Diagnosis → Instrument info → Firmware version (095)

Write permission No write permissions. Parameter is read only.

Description Displays the firmware version.



Serial number (096)

Navigation   Diagnosis → Instrument info → Serial number (096)

Write permission Parameter is read only. Only Endress+Hauser Service has write permission.

Description Displays the serial number of the device (11 alphanumeric characters).

Ext. order code (097)



Navigation   Diagnosis → Instrument info → Ext. order code (097)

Write permission Parameter is read only. Only Endress+Hauser Service has write permission.

Description Displays extended order number.

Factory setting According to order specifications

Order code (098)



Navigation   Diagnosis → Instrument info → Order code (098)

Write permission Parameter is read only. Only Endress+Hauser Service has write permission.

Description Displays the order identifier.

Factory setting According to order specifications

Cust. tag number (254)

Navigation   Diagnosis → Instrument info → Cust. tag number (254)

Write permission Operators/Service engineers/Expert

Description Enter the device tag e.g. TAG number (max. 8 alphanumeric characters).

Factory setting No entry or according to order specifications

Device tag (022)



Navigation   Setup → Extended setup → Device tag (022)

Write permission Operators/Service engineers/Expert

Description Enter the device tag e.g. TAG number (max. 32 alphanumeric characters).

Factory setting No entry or according to order specifications



ENP version (099)

Navigation   Diagnosis → Instrument info → ENP version (099)

Write permission Operators/Service engineers/Expert

Description Displays the ENP version
(ENP = electronic nameplate)



Config. counter (100)

Navigation   Diagnosis → Instrument info → Config. counter (100)

Write permission Operators/Service engineers/Expert

Description Displays the configuration counter.
This counter is increased by one every time a parameter or group is changed. The counter counts up to 65535 and then starts again at zero.



Manufacturer ID (103)

Navigation   Diagnosis → Instrument info → Manufacturer ID (103)

Write permission No write permissions. Parameter is read only.

Description Displays the HART manufacturer ID in a decimal digit format.
Here: 17



Device type code (279)

Navigation   Diagnosis → Instrument info → Device type code(279)

Write permission No write permissions. Parameter is read only.

Description Display of the numerical ID of the device
39

Device revision (108)

Navigation   Diagnosis → Instrument info → Device revision (108)

Write permission No write permissions. Parameter is read only.

Description Display of device revision (e.g. 1)

14.14 Diagnosis → Sens. limit HP

LRL sensor (101)

Navigation	 Diagnosis → Instrument info → Sens. limit HP → LRL sensor (101)
Write permission	No write permissions. Parameter is read only.
Description	Displays the lower-range limit of the sensor module.

URL sensor (102)

Navigation	 Diagnosis → Instrument info → Sens. limit HP → URL sensor (102)
Write permission	No write permissions. Parameter is read only.
Description	Displays the upper-range limit of the sensor module.

14.15 Diagnosis → Sens. limit LP

LRL sensor (272)

Navigation	 Diagnosis → Instrument info → Sens. limit LP → LRL sensor (272)
Write permission	No write permissions. Parameter is read only.
Description	Displays the lower-range limit of the sensor module.

URL sensor (273)

Navigation	 Diagnosis → Instrument info → Sens. limit LP → URL sensor (273)
Write permission	No write permissions. Parameter is read only.
Description	Displays the upper-range limit of the sensor module.

14.16 Diagnosis → Measured Values

Level before lin. (019)

Navigation

- 🖨️ 📄 Setup → Level before lin. (019)
- 🖨️ 📄 Setup → Extended setup → Level → Level before lin. (019)
- 🖨️ 📄 Diagnosis → Measured values → Level before lin. (019)

Write permission

No write permissions. Parameter is read only.

Description

Displays the level value prior to linearization.

Tank content (043)

Navigation

- 🖨️ 📄 Setup → Extended setup → Linearization → Tank content (043)
- 🖨️ 📄 Diagnosis → Measured values → Tank content (043)

Write permission

Operators/Service engineers/Expert

Description

Displays the level value after linearization.

Meas.Diff.Press. (020)

Navigation

- 🖨️ 📄 Setup → Meas.Diff.Press. (020)
- 🖨️ 📄 Diagnosis → Measured values → Meas.Diff.Press. (020)

Write permission

No write permissions. Parameter is read only.

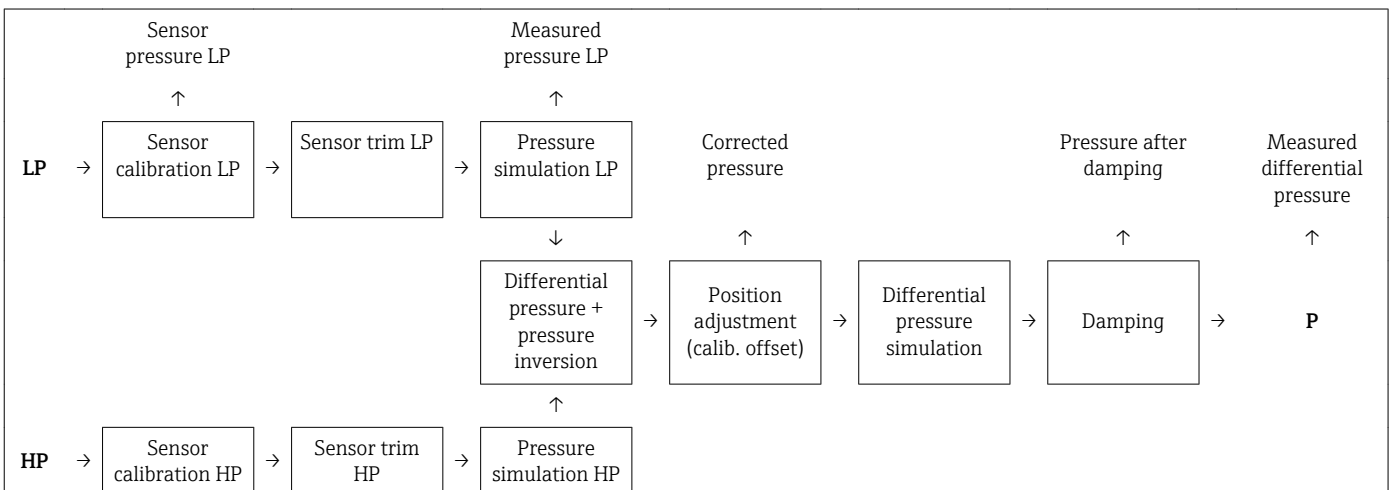

Description

Displays the measured differential pressure after sensor trim, position adjustment and damping.





↓ Sensor pressure HP	↓ Measured pressure HP
----------------------------	------------------------------



Sensor pressure HP (109)

Navigation	  Diagnosis → Measured Values → Sensor press. HP (109)
Write permission	No write permissions. Parameter is read only.
Description	Displays the measured pressure before the sensor trim.



Sensor press. LP (280)

Navigation	  Diagnosis → Measured values → Sensor press. LP (280)
Write permission	No write permissions. Parameter is read only.
Description	Displays the measured pressure before the sensor trim.





Meas. press. HP (281)

Navigation	  Diagnosis → Measured values → Meas. press. HP (281)
Write permission	No write permissions. Parameter is read only.
Description	Displays the measured HP pressure after sensor trim and simulation.



Meas. press. LP (282)

Navigation	  Diagnosis → Measured values → Meas. press. LP (282)
Write permission	No write permissions. Parameter is read only.
Description	Displays the measured LP pressure after sensor trim and simulation.



Corrected press. (172)

Navigation	  Setup → Corrected press. (172)   Diagnosis → Measured values → Corrected press. (172)
Write permission	No write permissions. Parameter is read only.
Description	Displays the measured differential pressure after position adjustment.

Sensor temp. HP (110)



Navigation	  Diagnosis → Measured values → Sensor temp. HP (110)
Write permission	No write permissions. Parameter is read only.
Description	Displays the temperature currently measured in the sensor module. This can deviate from the process temperature.

Sensor temp. LP (283)

Navigation	  Diagnosis → Measured values → Sensor temp. LP (283)
Write permission	No write permissions. Parameter is read only.
Description	Displays the temperature currently measured in the sensor module. This can deviate from the process temperature.

14.17 Diagnosis → Simulation

Simulation mode (112)

Navigation	  Diagnosis → Simulation → Simulation mode (112)
Write permission	Operators/Service engineers/Expert
Description	Switch on simulation and select the simulation mode. When changing the measuring mode or the level type (Lin. mode (037)) or when the device is restarted, any simulation running is switched off.
Options	<ul style="list-style-type: none"> ■ None ■ Differential pressure, → see this table, "Sim. press." parameter ■ Level, → see this table, "Sim. level" parameter ■ Press. HP, → see this table, "Sim. press. HP" parameter ■ Press. LP, → see this table, "Sim. press. LP" parameter ■ Tank content, →see this table, "Sim. tank cont." parameter ■ Current, → see this table, "Sim. current" parameter ■ Alarm/warning, → see this table, "Sim. error no."

Factory setting None

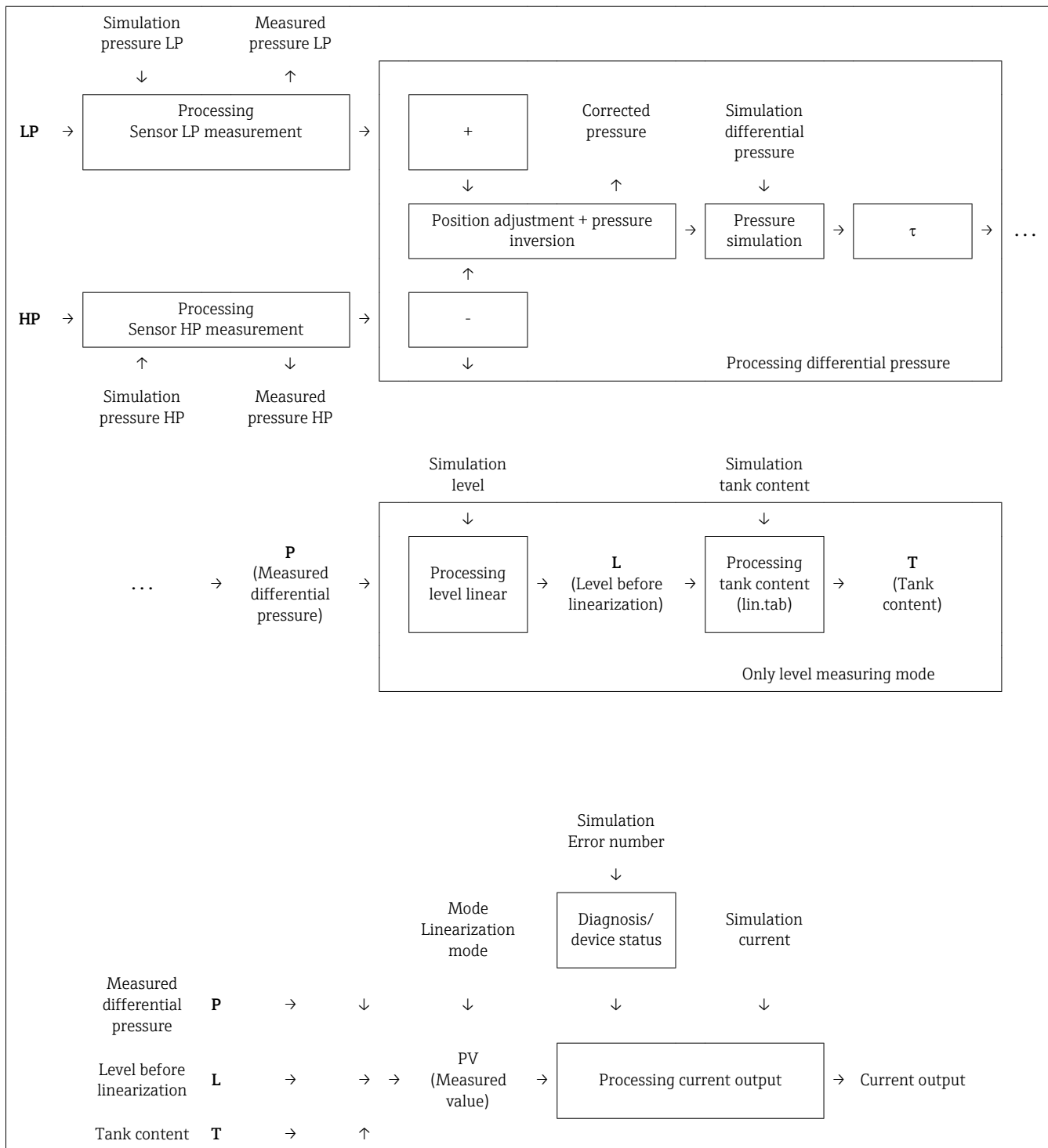

Sim. diff.press. (113)

Navigation



Diagnosis → Simulation → Sim.diff.press. (113)

Write permission



Operators/Service engineers/Expert

Description	Enter the simulation value. See also "Simulation mode".
Prerequisite	"Simulation mode" = Differential pressure
Value at switch-on	Current differential pressure measured value



Sim. press. HP (284)

Navigation	  Diagnosis → Simulation → Sim. press. HP (284)
Write permission	Operators/Service engineers/Expert
Description	Enter the simulation value. See also "Simulation mode".
Prerequisite	"Simulation mode" = Pressure HP
Value at switch-on	Current pressure measured value

Sim. press. LP (285)

Navigation	  Diagnosis → Simulation → Sim. press. LP (285)
Write permission	Operators/Service engineers/Expert
Description	Enter the simulation value. See also "Simulation mode".
Prerequisite	"Simulation mode" = Pressure LP
Value at switch-on	Current pressure measured value

Sim. level (115)

Navigation	  Diagnosis → Simulation → Sim. level (115)
Write permission	Operators/Service engineers/Expert
Description	Enter the simulation value. See also "Simulation mode".
Prerequisite	"Measuring mode" = Level and "Simulation mode" = Level
Value at switch-on	Current level measured value

Sim. tank cont. (116)

Navigation	 Diagnosis → Simulation → Sim. tank cont. (116)
Write permission	Operators/Service engineers/Expert
Description	Enter the simulation value. See also "Simulation mode".
Prerequisite	"Measuring Mode" = level, Lin mode "Activate table" and "Simulation Mode" = Tank content
Value at switch-on	Current tank content

Sim. current (117)



Navigation	 Diagnosis → Simulation → Sim. current (117)
Write permission	Operators/Service engineers/Expert
Description	Enter the simulation value. See also "Simulation mode".
Prerequisite	"Simulation mode"= Current value
Value at switch-on	Current value of the current

Sim. error no. (118)

Navigation	 Diagnosis → Simulation → Sim. error no. (118)
Write permission	Operators/Service engineers/Expert
Description	Enter the diagnostic message number. See also "Simulation mode".
Prerequisite	"Simulation Mode" = Alarm/Warning
Value at switch-on	484 (Simulation active)

14.18 Diagnosis → Reset

Enter reset code (124)

Navigation	 Diagnosis → Reset → Reset (124)
Write permission	Operators/Service engineers/Expert
Description	Reset parameters completely or partially to the factory values or order configuration by entering a reset code, see "Resetting to factory settings (reset)" section →  38.

Factory setting 0

15 Technical data

15.1 Input

15.1.1 Measured variable

Measured process variables

- Pressure HP and Pressure LP
- Sensor temperature HP and sensor temperature LP
- Transmitter temperature

Calculated process variables

- Differential pressure
- Level (level, volume or mass)

15.1.2 FMD71: measuring range of individual sensors

 The maximum span of the differential pressure corresponds to the URL of the HP sensor.

Gauge pressure

Sensor	Maximum sensor measuring range		MWP	OPL	Vacuum resistance	Option ¹⁾
	lower (LRL)	upper (URL)				
	[bar (psi)]	[bar (psi)]				
100 mbar (1.5 psi)	-0.1 (-1.5)	+0.1 (+1.5)	2.7 (40.5)	4 (60)	0.7 (10.5)	1C
250 mbar (4 psi)	-0.25 (-4)	+0.25 (+4)	3.3 (49.5)	5 (75)	0.5 (7.5)	1E
400 mbar (6 psi)	-0.4 (-6)	+0.4 (+6)	5.3 (79.5)	8 (120)	0	1F
1 bar (15 psi)	-1 (-15)	+1 (+15)	6.7 (100.5)	10 (150)	0	1H
2 bar (30 psi)	-1 (-15)	+2 (+30)	12 (180)	18 (270)	0	1K
4 bar (60 psi)	-1 (-15)	+4 (+60)	16.7 (250.5)	25 (375)	0	1M
10 bar (150 psi)	-1 (-15)	+10 (+150)	26.7 (400.5)	40 (600)	0	1P
40 bar (600 psi)	-1 (-15)	+40 (+600)	40 (600)	60 (900)	0	1S

1) Product Configurator order code for "Sensor range"

Absolute pressure

Sensor	Maximum sensor measuring range		MWP	OPL	Vacuum resistance	Option ¹⁾
	lower (LRL)	upper (URL)				
	[bar _{abs} (psi _{abs})]	[bar _{abs} (psi _{abs})]				
100 mbar (1.5 psi)	0	+0.1 (+1.5)	2.7 (40.5)	4 (60)	0	2C
250 mbar (4 psi)	0	+0.25 (+4)	3.3 (49.5)	5 (75)	0	2E
400 mbar (6 psi)	0	+0.4 (+6)	5.3 (79.5)	8 (120)	0	2F
1 bar (15 psi)	0	+1 (+15)	6.7 (100.5)	10 (150)	0	2H
2 bar (30 psi)	0	+2 (+30)	12 (180)	18 (270)	0	2K
4 bar (60 psi)	0	+4 (+60)	16.7 (250.5)	25 (375)	0	2M

Sensor	Maximum sensor measuring range		MWP	OPL	Vacuum resistance	Option ¹⁾
	lower (LRL)	upper (URL)				
	[bar _{abs} (psi _{abs})]	[bar _{abs} (psi _{abs})]	[bar _{abs} (psi _{abs})]	[bar _{abs} (psi _{abs})]	[bar _{abs} (psi _{abs})]	
10 bar (150 psi)	0	+10 (+150)	26.7 (400.5)	40 (600)	0	2P
40 bar (600 psi)	0	+40 (+600)	40 (600)	60 (900)	0	2S

1) Product Configurator order code for "Sensor range"

15.1.3 FMD72: measuring range of individual sensors

 The maximum span of the differential pressure corresponds to the URL of the HP sensor.

Gauge pressure

Sensor	Maximum sensor measuring range		MWP	OPL	Vacuum resistance ¹⁾	Option ²⁾
	lower (LRL)	upper (URL)			silicone oil	
	[bar (psi)]	[bar (psi)]			[bar _{abs} (psi _{abs})]	
400 mbar (6 psi)	-0.4 (-6)	+0.4 (+6)	4 (60)	6 (90)	0.01 (0.15)	1F
1 bar (15 psi)	-1 (-15)	+1 (+15)	6.7 (100)	10 (150)	0.01 (0.15)	1H
2 bar (30 psi)	-1 (-15)	+2 (+30)	13.3 (200)	20 (300)	0.01 (0.15)	1K
4 bar (60 psi)	-1 (-15)	+4 (+60)	18.7 (280.5)	28 (420)	0.01 (0.15)	1M
10 bar (150 psi)	-1 (-15)	+10 (+150)	26.7 (400.5)	40 (600)	0.01 (0.15)	1P
40 bar (600 psi)	-1 (-15)	+40 (+600)	100 (1500)	160 (2400)	0.01 (0.15)	1S

1) The vacuum resistance applies for the measuring cell under reference operating conditions. (see "Reference operating conditions" section)

2) Product Configurator order code for "Sensor range"

Absolute pressure

Sensor	Maximum sensor measuring range		MWP	OPL	Vacuum resistance ¹⁾	Option ²⁾
	lower (LRL)	upper (URL)			silicone oil	
	[bar _{abs} (psi _{abs})]	[bar _{abs} (psi _{abs})]			[bar _{abs} (psi _{abs})]	
1 bar (15 psi)	0	+1 (+15)	6.7 (100)	10 (150)	0.01 (0.15)	2H
2 bar (30 psi)	0	+2 (+30)	13.3 (200)	20 (300)	0.01 (0.15)	2K
4 bar (60 psi)	0	+4 (+60)	18.7 (280.5)	28 (420)	0.01 (0.15)	2M
10 bar (150 psi)	0	+10 (+150)	26.7 (400.5)	40 (600)	0.01 (0.15)	2P
40 bar (600 psi)	0	+40 (+600)	100 (1500)	160 (2400)	0.01 (0.15)	2S

1) The vacuum resistance applies for the measuring cell under reference operating conditions. (see "Reference operating conditions" section)

2) Product Configurator order code for "Sensor range"

15.2 Output

15.2.1 Output Signal

4 to 20 mA with superimposed digital communication protocol HART 6.0, 2-wire

15.2.2 Signal range 4 to 20 mA

3.8 mA to 20.5 mA

15.2.3 Signal on alarm 4 to 20 mA

As per NAMUR NE43

- Max. alarm: (factory setting: 22 mA) can be set from 21 to 23 mA
- Hold measured value: last measured value is held
- Min. alarm: 3.6 mA

15.2.4 Maximum load

In order to guarantee sufficient terminal voltage in two-wire devices, a maximum load resistance R (including line resistance) must not be exceeded depending on the supply voltage U_0 of the supply unit. In the following load diagrams, observe the position of the jumper and the explosion protection:

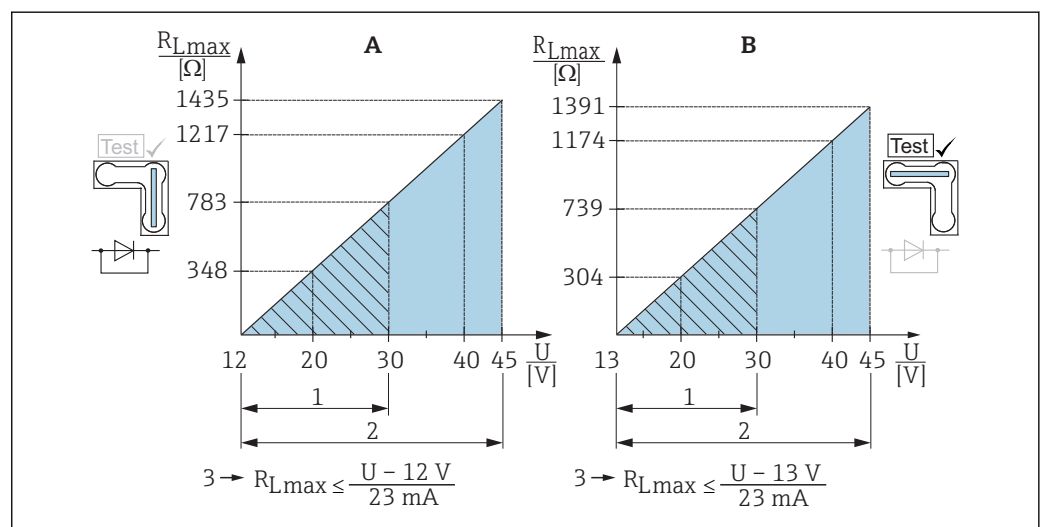

A0017533

A Jumper for 4 to 20 mA test signal set to "Non-test" position

B Jumper for 4 to 20 mA test signal set to "Test" position

1 Power supply for II 1/2 G Ex ia, FM IS, CSA IS

2 Power supply for devices for the non-hazardous area, 2 G Ex d, 3 G Ex nA, FM XP, FM NI, CSA XP, CSA dust ignition-proof

3 R_{Lmax} maximum load resistance

U Supply voltage

i When operating via a handheld terminal or via a PC with an operating program, a minimum communication resistance of 250 Ω must be taken into account.

15.2.5 Dead time, Time constant

Presentation of the dead time and the time constant:

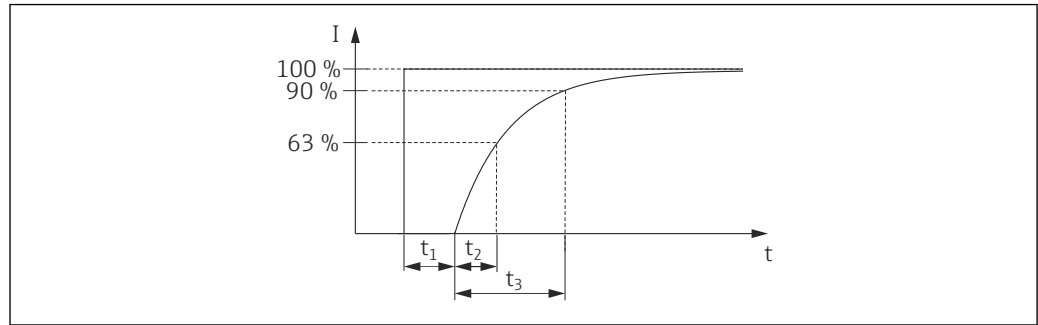

A0019786

15.2.6 Dynamic behavior, current output

	Dead time (t ₁) [ms]	Time constant (T63), t ₂	Time constant (T90), t ₃
max.	120	120	280

15.2.7 Dynamic behavior, HART

	Dead time (t ₁) [ms]	Dead time (t ₁) [ms] + Time constant T63 (= t ₂) [ms]	Dead time (t ₁) [ms] + Time constant T90 (= t ₃) [ms]
min.	280	400	560
max.	1100	1220	1380

Reading cycle

- Acyclic: max. 3/s, typical 1/s (depends on command # and number of preambles)
- Cyclic (Burst): max. 3/s, typical 2/s

The Deltabar FMD71/FMD72 offers BURST MODE functionality for cyclical value transmission via the HART communication protocol.

Cycle time (update time)

Cyclic (burst): min. 300 ms

Response time

- Acyclic: min. 330 ms, typically 590 ms (depending on command # and number of preambles)
- Cyclic (burst): min. 160 ms, typically 350 ms (depending on command # and number of preambles)

15.2.8 alarm current setting

Adjusted min. alarm current: Product configurator order code for "Service", option "IA"

15.2.9 Firmware version

Description	Option ¹⁾
01.00.zz, HART, DevRev01	78

1) Product Configurator, order code for "Firmware version"

15.2.10 Protocol-specific data

Manufacturer ID	17 (0x11)
Device type ID	39 (0x27)
HART specification	6.0
Device description files (DTM, DD)	Information and files can be found: <ul style="list-style-type: none"> ▪ www.endress.com ▪ www.fieldcommgroup.org
HART device variables	<p>Measured values for PV (primary variable)</p> <ul style="list-style-type: none"> ▪ Differential pressure ▪ Level linear (before lin.) ▪ Level after linearization table <p>Measured values for SV, TV, QV (second, third and fourth variable)</p> <ul style="list-style-type: none"> ▪ Measured differential pressure ▪ Corrected pressure ▪ Measured pressure HP ▪ Sensor pressure HP ▪ Sensor temperature HP ▪ Measured pressure LP ▪ Sensor pressure LP ▪ Sensor temperature LP ▪ Level before linearization ▪ Tank content ▪ Electronic temperature
Supported functions	<ul style="list-style-type: none"> ▪ Burst mode ▪ Additional transmitter status

15.3 Performance characteristics of ceramic process isolating diaphragm

15.3.1 Reference operating conditions

- As per IEC 60770
- Ambient temperature T_A = constant, in the range of: +21 to +33 °C (+70 to +91 °F)
- Humidity φ = constant, in the range of: 5 to 80 % RH
- Ambient pressure p_A = constant, in the range of: 860 to 1 060 mbar (12.47 to 15.37 psi)
- Position of measuring cell = constant, in range: horizontal $\pm 1^\circ$ (see also "Influence of the installation position" section → 118)
- Input of Lo Trim Sensor and Hi Trim Sensor for lower range value and upper range value
- Zero based span
- Material of process isolating diaphragm: Al_2O_3 (aluminum-oxide ceramic, Ceraphire®)
- Supply voltage: 24 V DC ± 3 V DC
- Load with HART: 250 Ω

15.3.2 Influence of the installation position depending on sensor

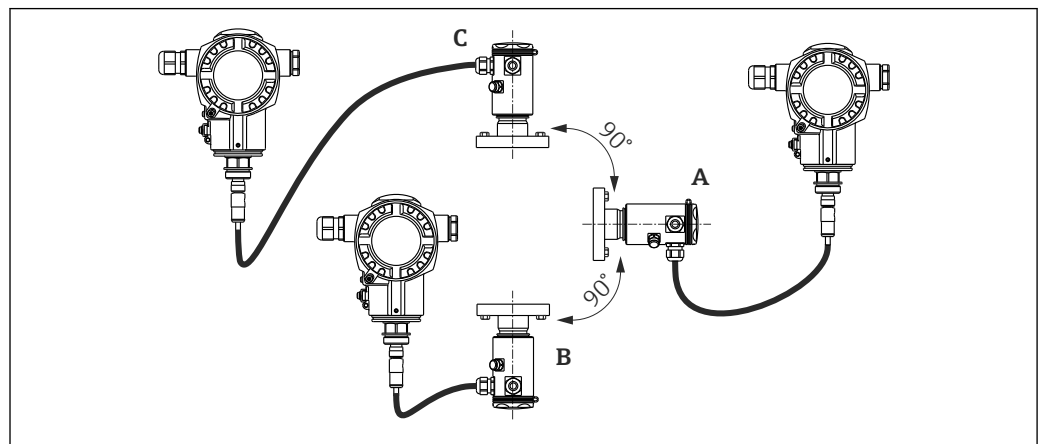

A0016465

Process isolating diaphragm axis is horizontal (A)	Process isolating diaphragm pointing upwards (B)	Process isolating diaphragm pointing downwards (C)
Calibration position, no measuring error	< +0.2 mbar (+0.003 psi)	< -0.2 mbar (-0.003 psi)

This effect can be corrected using the function to adjust the position (position adjustment) for the differential pressure. Additional position adjustments for individual pressure signals are not available.

i A position-dependent zero shift can be corrected on the device.

15.3.3 Resolution

- Current output: 1 μ A
- Display: can be set (factory setting: presentation of the maximum accuracy of the transmitter)

15.3.4 Vibration effects

Test standard	Vibration effects
IEC 61298-3	≤ Reference accuracy up to 10 to 60 Hz: ± 0.35 mm (± 0.01 in); 60 to 500 Hz: 2 g

15.3.5 Application limits

A high ratio between the level and head pressure or between the differential pressure and static pressure can result in large measured errors. A maximum ratio of 1:10 is recommended. For calculation purposes, please use the free "Applicator" calculation tool, which is available online at "www.endress.com/applicator" or on CD-ROM.

15.3.6 Reference accuracy

The reference accuracy contains the non-linearity [DIN EN 61298-2 3.11] including the pressure hysteresis [DIN EN 61298-23.13] and non-repeatability [DIN EN 61298-2 3.11] in accordance with the limit point method as per [DIN EN 60770].

Measuring cell	Sensor	Reference accuracy (A) [%URL for every sensor]		Calculated reference accuracy (A _{Diff}) of the differential pressure
		Standard	Platinum	
100 mbar (1.5 psi)	Gauge pressure	A = ±0.075 A = ±0.15 ¹⁾	-	Calculation (mbar, bar or psi): $A_{Diff} = \sqrt{\left(\frac{A_{HP} \cdot URL_{HP}}{100}\right)^2 + \left(\frac{A_{LP} \cdot URL_{LP}}{100}\right)^2}$ A0016468
250 mbar (3.75 psi)	Gauge pressure	A = ±0.075 A = ±0.15 ¹⁾	-	
400 mbar (6 psi)	Gauge pressure	A = ±0.075 A = ±0.15 ¹⁾	-	
1 bar (15 psi) 2 bar (30 psi) 4 bar (60 psi) 10 bar (150 psi) 40 bar (600 psi)	Gauge pressure/ Absolute pressure	A = ±0.075 A = ±0.15 ¹⁾	A = ±0.05 ±0.075 ¹⁾	Percentage calculation of URL dP: $A_{Diff} [\%] = \frac{A_{Diff} \cdot 100}{P_{Diff}}$ A0016469

1) For hygienic process connections

15.3.7 Thermal change in the zero output and the output span

Standard version

Measuring cell	-10 °C (+14 °F) to ≤ +60 °C (+140 °F)	-20 to -10 °C (-4 to +14 °F) > +60 to +125 °C (+140 to +257 °F)	Calculated thermal change (T _{Diff}) of the differential pressure
	% of the set span for every sensor		
100 mbar (1.5 psi) 250 mbar (4 psi) 400 mbar (6 psi)	T _{total} = ±0.176	T _{total} = ±0.276	Calculation (mbar, bar or psi): $T_{Diff} = \sqrt{\left(\frac{T_{HP} \cdot URL_{HP}}{100}\right)^2 + \left(\frac{T_{LP} \cdot URL_{LP}}{100}\right)^2}$ A0016474 Percentage calculation of URL dP: $T_{Diff} [\%] = \frac{T_{Diff} \cdot 100}{P_{Diff}}$ A0016475
1 bar (15 psi) 2 bar (30 psi) 4 bar (60 psi) 10 bar (150 psi) 40 bar (600 psi)	T _{total} = ±0.092	T _{total} = ±0.250	

High temperature version and hygienic version

Measuring cell	Sensor	-10 °C (+14 °F) to ≤ +60 °C (+140 °F)	> +60 to +150 °C (140 to +302 °F)	Calculated thermal change (T _{Diff}) of the differential pressure
		% of the set span for every sensor		
100 mbar (1.5 psi) 250 mbar (4 psi) 400 mbar (6 psi)	Gauge pressure	T _{total} = ±0.176 T _{total} = ±0.352 ¹⁾	T = ±0.75 T = ±1.25 ¹⁾	Calculation (mbar, bar or psi): $T_{Diff} = \sqrt{\left(\frac{T_{HP} \cdot URL_{HP}}{100}\right)^2 + \left(\frac{T_{LP} \cdot URL_{LP}}{100}\right)^2}$ A0016474 Percentage calculation of URL dP:
1 bar (15 psi) 2 bar (30 psi) 4 bar (60 psi) 10 bar (150 psi) 40 bar (600 psi)	Gauge pressure	T _{total} = ±0.092 T _{total} = ±0.184 ¹⁾	T = ±0.5 T = ±0.75 ¹⁾	

Measuring cell	Sensor	-10 °C (+14 °F) to ≤ +60 °C (+140 °F)	> +60 to +150 °C (140 to +302 °F)	Calculated thermal change (T _{Diff}) of the differential pressure
		% of the set span for every sensor		
1 bar (15 psi) 2 bar (30 psi) 4 bar (60 psi) 10 bar (150 psi)	Absolute pressure	T _{total} = ±0.092 T _{total} = ±0.184 ¹⁾	T = ±0.75 T = ±1.25 ¹⁾	$T_{Diff} [\%] = \frac{T_{Diff} \cdot 100}{P_{Diff}}$
40 bar (600 psi)	Absolute pressure	T _{total} = ±0.092 T _{total} = ±0.184 ¹⁾	T = ±0.5 T = ±0.75 ¹⁾	

1) For hygienic process connections

15.3.8 Total performance

The "Total performance" specification comprises the non-linearity including hysteresis, non-reproducibility as well as the thermal change in the zero point. All specifications apply to the temperature range -10 to +60 °C (+14 to +140 °F).

Measuring cell	% of URL for every sensor - standard version	% of URL for every sensor - high-temperature version	% of URL for every sensor - hygienic version	Calculated total performance (TP _{Diff}) of the differential pressure
100 mbar (1.5 psi) 250 mbar (4 psi) 400 mbar (6 psi)	TP = ±0.2	TP = ±0.46	TP = ±0.575	Calculation (mbar, bar or psi): $TP_{Diff} = \sqrt{\left(\frac{TP_{HP} \cdot URL_{HP}}{100}\right)^2 + \left(\frac{TP_{LP} \cdot URL_{LP}}{100}\right)^2}$ Percentage calculation of URL dP: $TP_{Diff} [\%] = \frac{TP_{Diff} \cdot 100}{P_{Diff}}$
1 bar (15 psi) 2 bar (30 psi) 4 bar (60 psi) 10 bar (150 psi) 40 bar (600 psi)	TP = ±0.15	TP = ±0.46	TP = ±0.5	



The "Applicator Sizing Electronic dp" selection tool, available free of charge on the Endress+Hauser web site (www.endress.com/applicator), enables detailed calculations for your respective applications.

15.3.9 Long-term stability

Measuring ranges	Sensor	Standard version		Calculated long-term stability (L _{Diff}) of the differential pressure
		1 year	10 years	
		% of URL for every sensor		
100 mbar (1.5 psi) 250 mbar (4 psi) 400 mbar (6 psi)	Gauge pressure	L = ±0.1 L = ±0.25 ¹⁾	L = ±0.2 L = ±0.45 ¹⁾	Calculation (mbar, bar or psi): $L_{Diff} = \sqrt{\left(\frac{L_{HP} \cdot URL_{HP}}{100}\right)^2 + \left(\frac{L_{LP} \cdot URL_{LP}}{100}\right)^2}$ Percentage calculation of URL dP/year: $L_{Diff} [\%] = \frac{L_{Diff} \cdot 100}{P_{Diff}}$
	Absolute pressure		L = ±0.3 L = ±0.55 ¹⁾	

Measuring ranges	Sensor	Standard version		Calculated long-term stability (L _{Diff}) of the differential pressure
		1 year	10 years	
		% of URL for every sensor		
1 bar (15 psi) 2 bar (30 psi) 4 bar (60 psi) 10 bar (150 psi) 40 bar (600 psi)	Gauge pressure Absolute pressure	L = ±0.05 L = ±0.1 ¹⁾	L = ±0.2 L = ±0.3	

1) For hygienic process connections

15.3.10 Total error

The total error comprises the total performance and long-term stability. All specifications apply to the temperature range -10 to +60 °C (+14 to +140 °F).

Measuring cell	% of URL for every sensor - standard version	% of URL for every sensor - high-temperature version	% of URL for every sensor - hygienic version	Calculated total error (TE _{Diff}) of the differential pressure
100 mbar (1.5 psi) 250 mbar (4 psi) 400 mbar (6 psi)	TE = ±0.25	TE = ±0.51	TE = ±0.925	Calculation (mbar, bar or psi): $TE_{Diff} = \sqrt{\left(\frac{TE_{HP} \cdot URL_{HP}}{100}\right)^2 + \left(\frac{TE_{LP} \cdot URL_{LP}}{100}\right)^2}$ <small>A0016472</small> Percentage calculation of URL dP: $TE_{Diff} [\%] = \frac{TE_{Diff} \cdot 100}{P_{Diff}}$ <small>A0016473</small>
1 bar (15 psi) 2 bar (30 psi) 4 bar (60 psi) 10 bar (150 psi) 40 bar (600 psi)	TE = ±0.2	TE = ±0.51	TE = ±0.7	

15.3.11 Warm-up period

4 to 20 mA HART: < 10 s

15.4 Performance characteristics of metallic process isolating diaphragm

15.4.1 Reference operating conditions

- As per IEC 60770
- Ambient temperature T_U = constant, in the range of +21 to +33 °C (+70 to +91 °F)
- Humidity ϕ = constant, in the range of 5 to 80 % rH
- Ambient pressure p_A = constant, in the range of 860 to 1 060 mbar (12.47 to 15.37 psi)
- Position of the measuring cell = constant, in the range of horizontal $\pm 1^\circ$ (see also "Influence of the installation position" section → 123)
- Input of Lo Trim Sensor and Hi Trim Sensor for lower range value and upper range value
- Zero based span
- Process isolating diaphragm material: AISI 316L (1.4435)
- Filling oil: silicone oil
- Supply voltage: 24 V DC ± 3 V DC
- Load with HART: 250 Ω

15.4.2 Influence of the installation position depending on sensor

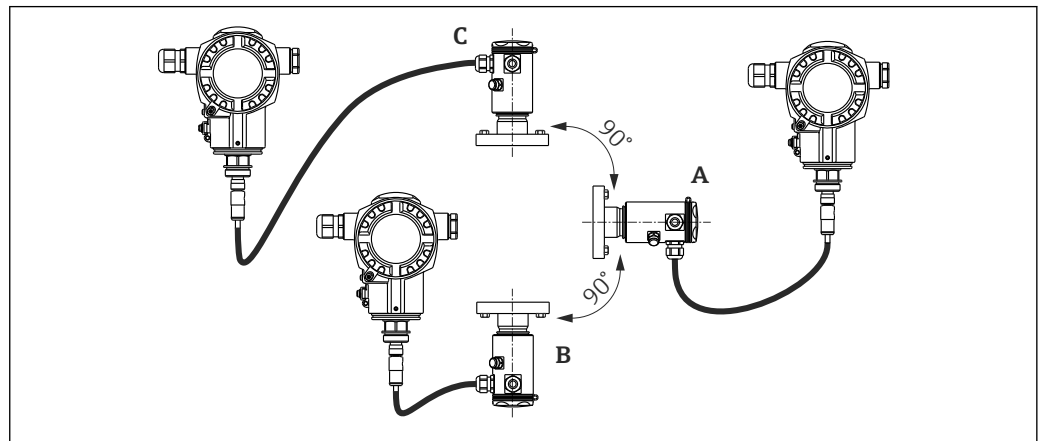

A0016465

	Process isolating diaphragm axis is horizontal (A)	Process isolating diaphragm pointing upwards (B)	Process isolating diaphragm pointing downwards (C)
Sensor with 1/2" thread and silicone oil	Calibration position, no measurement error	< +4 mbar (+0.06 psi)	< -4 mbar (-0.06 psi)
Sensor with thread > 1/2" and flanges		< +10 mbar (+0.145 psi) The value is doubled for inert oil.	< -10 mbar (-0.145 psi) The value is doubled for inert oil.

This effect can be corrected using the function to adjust the position (position adjustment) for the differential pressure. Additional position adjustments for individual pressure signals are not available.

 A position-dependent zero shift can be corrected on the device .

15.4.3 Resolution

- Current output: 1 μ A
- Display: can be set (factory setting: presentation of the maximum accuracy of the transmitter)

15.4.4 Vibration effects

Test standard	Vibration effects
IEC 61298-3	≤ Reference accuracy up to 10 to 60 Hz: ±0.35 mm (±0.01 in); 60 to 500 Hz: 2 g

15.4.5 Application limits

A high ratio between the level and head pressure or between the differential pressure and static pressure can result in large measured errors. A maximum ratio of 1:10 is recommended. For calculation purposes, please use the free "Applicator" calculation tool, which is available online at "www.endress.com/applicator" or on CD-ROM.

15.4.6 Reference accuracy

The reference accuracy contains the non-linearity [DIN EN 61298-2 3.11] including the pressure hysteresis [DIN EN 61298-23.13] and non-repeatability [DIN EN 61298-2 3.11] in accordance with the limit point method as per [DIN EN 60770].

Measuring cell	Sensor	Reference accuracy (A) [%URL for every sensor]		Calculated reference accuracy (A _{Diff}) of the differential pressure
		Standard	Platinum	
400 mbar (6 psi)	Gauge pressure	A = ±0.15 ±0.3 ¹⁾	-	Calculation (mbar, bar or psi): $A_{Diff} = \sqrt{\left(\frac{A_{HP} \cdot URL_{HP}}{100}\right)^2 + \left(\frac{A_{LP} \cdot URL_{LP}}{100}\right)^2}$ Percentage calculation of URL dP: $A_{Diff} [\%] = \frac{A_{Diff} \cdot 100}{P_{Diff}}$
1 bar (15 psi) 2 bar (30 psi) 4 bar (60 psi) 10 bar (150 psi) 40 bar (600 psi)	Gauge pressure/ Absolute pressure	A = ±0.075 A = ±0.15 ¹⁾	A = ±0.05 A = ±0.075 ¹⁾	A0016468 A0016469

1) For hygienic process connections

15.4.7 Thermal change of the zero output and the output span

Measuring cell	-10 to +60 °C (+14 to +140 °F)	-40 to -10 °C (-40 to +14 °F) +60 to +80 °C (+140 to +176 °F)	Calculated thermal change (T _{Diff}) of the differential pressure
	% of the set span for every sensor		
400 mbar (6 psi)	T _{total} = ±0.215 T _{span} = ±0.2 T _{zero point} = ±0.015	T _{total} = ±0.43 T _{span} = ±0.4 T _{zero point} = ±0.03	Calculation (mbar, bar or psi): $T_{Diff} = \sqrt{\left(\frac{T_{HP} \cdot URL_{HP}}{100}\right)^2 + \left(\frac{T_{LP} \cdot URL_{LP}}{100}\right)^2}$ Percentage calculation of URL dP: $T_{Diff} [\%] = \frac{T_{Diff} \cdot 100}{P_{Diff}}$
1 bar (15 psi) 2 bar (30 psi) 4 bar (60 psi) 10 bar (150 psi) 40 bar (600 psi)	T _{total} = ±0.101 T _{span} = ±0.1 T _{zero point} = ±0.01	T _{total} = ±0.42 T _{span} = ±0.4 T _{zero point} = ±0.02	A0016474 A0016475

15.4.8 Total performance

The "Total performance" specification comprises the non-linearity including hysteresis, non-reproducibility as well as the thermal change of the zero point. All specifications apply to the temperature range -10 to +60 °C (+14 to +140 °F).

Measuring cell	% of URL for every sensor	Calculated total performance (TP _{Diff}) of the differential pressure
400 mbar (6 psi)	TP = ±0.25 TP = ±0.34 ¹⁾	Calculation (mbar, bar or psi):
1 bar (15 psi) 2 bar (30 psi) 4 bar (60 psi) 10 bar (150 psi) 40 bar (600 psi)	TP = ±0.15 TP = ±0.25 ¹⁾	$TP_{Diff} = \sqrt{\left(\frac{TP_{HP} \cdot URL_{HP}}{100}\right)^2 + \left(\frac{TP_{LP} \cdot URL_{LP}}{100}\right)^2}$ <p>Percentage calculation of URL dP:</p> $TP_{Diff} [\%] = \frac{TP_{Diff} \cdot 100}{P_{Diff}}$

1) For hygienic process connections

 The "Applicator Sizing Electronic dp" selection tool, available free of charge on the Endress+Hauser web site (www.endress.com/applicator), enables detailed calculations for your respective applications.

15.4.9 Long-term stability

Measuring ranges	1 year	5 years	10 years	Calculated long-term stability (L _{Diff}) of the differential pressure
	% of URL for every sensor			
400 mbar (6 psi)	L = ±0.035 L = ±0.25 ¹⁾	L = ±0.14	L = ±0.32	Calculation (mbar, bar or psi):
1 bar (15 psi)	L = ±0.020 L = ±0.1 ¹⁾	L = ±0.08	L = ±0.180	$L_{Diff} = \sqrt{\left(\frac{L_{HP} \cdot URL_{HP}}{100}\right)^2 + \left(\frac{L_{LP} \cdot URL_{LP}}{100}\right)^2}$
2 bar (30 psi) 4 bar (60 psi) 10 bar (150 psi)	L = ±0.025 L = ±0.1 ¹⁾	L = ±0.05	L = ±0.075	Percentage calculation of URL dP/year:
40 bar (600 psi)	L = ±0.025 L = ±0.1 ¹⁾	L = ±0.075	L = ±0.100	$L_{Diff} [\%] = \frac{L_{Diff} \cdot 100}{P_{Diff}}$

1) For hygienic process connections

15.4.10 Total error

The total error comprises the total performance and long-term stability. All specifications apply to the temperature range -10 to +60 °C (+14 to +140 °F).

Measuring cell	% of URL/year for every sensor	Calculated total error (TE _{Diff}) of the differential pressure
400 mbar (6 psi)	TE = ±0.30	Calculation (mbar, bar or psi): $TE_{Diff} = \sqrt{\left(\frac{TE_{HP} \cdot URL_{HP}}{100}\right)^2 + \left(\frac{TE_{LP} \cdot URL_{LP}}{100}\right)^2}$ Percentage calculation of URL dP: $TE_{Diff} [\%] = \frac{TE_{Diff} \cdot 100}{P_{Diff}}$
1 bar (15 psi) 2 bar (30 psi) 4 bar (60 psi) 10 bar (150 psi) 40 bar (600 psi)	TE = ±0.20	

A0016472

A0016473

15.4.11 Warm-up period

4 to 20 mA HART : < 10 s

15.5 Environment

15.5.1 Ambient temperature range

- Without onsite display: -40 to +80 °C (-40 to +176 °F)
- With onsite display: -20 to +70 °C (-4 to +158 °F)
 Extended temperature operation range with limitations in optical properties, such as display speed and contrast. -40 to +80 °C (-40 to +176 °F)

For devices for use in hazardous areas, see Safety Instructions .

The device can be used in this temperature range. The values of the specification, such as thermal change, may be exceeded.

15.5.2 Storage temperature range

-40 to +80 °C (-40 to +176 °F)

15.5.3 Climate class

Class 4K4H (air temperature: -20 to +55 °C (-4 to +131 °F), relative humidity: 4 to 100 %) fulfilled as per DIN EN 60721-3-4 (condensation possible)

15.5.4 Degree of protection

IP66/68 NEMA 4x/6P

Degree of protection IP 68: 1.83 mH₂O for 24 h

15.5.5 Vibration resistance

Housing	Test standard	Vibration resistance
Aluminum and steel housing	IEC 61298-3	guaranteed for: 10 to 60 Hz: ±0.15 mm (±0.0059 in); 60 to 500 Hz: 2 g in all 3 planes

15.5.6 Electromagnetic compatibility

- Electromagnetic compatibility as per EN 61326 Appendix A and NAMUR Recommendation EMC (NE21). For details, refer to the Declaration of Conformity.
- Maximum deviation: < 0.5 % of span
- All EMC measurements were performed with a turn down (TD) = 2:1.

15.6 Process

15.6.1 Process temperature range for devices with ceramic process isolating diaphragm FMD71

- Thread and flanges: -25 to +125 °C (-13 to +257 °F)
- Hygienic connections: -25 to +130 °C (-13 to +266 °F) , 150 °C (302 °F) for a maximum of 60 minutes
- High-temperature version: -15 to +150 °C (+5 to +302 °F); see ordering information, feature 610, option "NB".
- For saturated steam applications, use a device with a metal process isolating diaphragm, or provide a siphon for temperature isolation when installing.
- Pay attention to the process temperature range of the seal. See also the following table.

Seal	Notes	Process temperature range		Option ¹⁾
		Threaded connection or flange	Hygienic process connections	
FKM Viton	-	-25 to +125 °C (-13 to +257 °F)/ 150 °C (302 °F) ²⁾	-	A
FKM Viton	FDA ³⁾ , 3A Class I, USP Class VI	-5 to +125 °C (+23 to +257 °F)	-5 to +150 °C (+23 to +302 °F)	B
FFKM Perlast G75LT	-	-20 to +125 °C (-4 to +257 °F)	-20 to +150 °C (-4 to +302 °F)	C
Kalrez, Compound 4079	-	+5 to +125 °C (+41 to +257 °F)/ 150 °C (302 °F) ²⁾	-	D
NBR	FDA ³⁾	-10 to +100 °C (+14 to +212 °F)	-	F
NBR, Low temperature	-	-40 to +100 °C (-40 to +212 °F)	-	H
HNBR ⁴⁾	FDA ³⁾ , 3A Class II, KTW, AFNOR, BAM	-25 to +125 °C (-13 to +257 °F)/ 150 °C (302 °F) ²⁾	-20 to +125 °C (-4 to +257 °F)	G
EPDM 70	FDA ³⁾	-40 to +125 °C (-40 to +257 °F)	-	J
EPDM 291 ⁴⁾	FDA ³⁾ , 3A Class II, USP Class VI, DVGW, KTW, W270, WRAS, ACS, NSF61	-15 to +125 °C (+5 to +257 °F)/ 150 °C (302 °F) ²⁾	-15 to +150 °C (+5 to +302 °F)	K
FFKM Kalrez 6375	-	+5 to +125 °C (+41 to +257 °F)	-	L
FFKM Kalrez 7075	-	+5 to +125 °C (+41 to +257 °F)	-	M
FFKM Kalrez 6221	FDA ³⁾ , USP Class VI	-5 to +125 °C (+23 to +257 °F)	-5 to +150 °C (+23 to +302 °F)	N
Fluoroprene XP40	FDA ³⁾ , USP Class VI, 3A Class I	+5 to +125 °C (+41 to +257 °F)/ 150 °C (302 °F) ²⁾	+5 to +150 °C (+41 to +302 °F)	P
VMQ Silicone	FDA ³⁾	-35 to +85 °C (-31 to +185 °F)	-20 to +85 °C (-4 to +185 °F)	S

The process temperature ranges indicated here refer to the permanent operation of the FMD71. In the case of devices with hygienic process connections, a higher temperature (max. 150 °C (302 °F)) may be applied for a short period (max. 60 min.) for cleaning purposes.

- 1) Product Configurator order code for "Seal"
- 2) 150 °C (302 °F) for high-temperature version
- 3) Food-safe FDA 21 CFR 177.2600
- 4) These seals are used for devices with 3A-approved process connections.

Applications with jumps in temperature

Frequent extreme changes in temperatures can temporarily cause measuring errors. Temperature compensation takes effect after several minutes. Internal temperature compensation is faster the smaller the jump in temperature and the longer the time interval involved.

15.6.2 Process temperature range for devices with metallic process isolating diaphragm FMD72

Device	Limits
Process connections with internal process isolating diaphragm	-40 to +125 °C (-40 to +257 °F)
Process connections with flush-mounted process isolating diaphragm	-40 to +100 °C (-40 to +212 °F)
Hygienic process connections with flush-mounted process isolating diaphragm	-40 to +130 °C (-40 to +266 °F) For a maximum of 60 minutes: +150 °C (+302 °F)

15.6.3 Pressure specifications

⚠ WARNING

The maximum pressure for the measuring device depends on the lowest-rated element with regard to pressure.

- ▶ For pressure specifications, see the "Measuring range" section and "Mechanical construction" section in the Technical Information.
- ▶ MWP (maximum working pressure): The MWP (maximum working pressure) is specified on the nameplate. This value refers to a reference temperature of +20 °C (+68 °F) and may be applied to the device for an unlimited time. Observe temperature dependency of the MWP. The pressure values permitted at higher temperatures can be found in the standards EN 1092-1: 2001 Tab. 18 (With regard to their stability-temperature property, the materials 1.4435 and 1.4404 are grouped together under 13EO in EN 1092-1 Tab. 18. The chemical composition of the two materials can be identical.), ASME B 16.5a – 1998 Tab. 2-2.2 F316, ASME B 16.5a – 1998 Tab. 2.3.8 N10276, JIS B 2220.
- ▶ The test pressure corresponds to the overload limit of the individual sensors (overpressure limit OPL = 1.5 x MWP (formula does not apply to the FMD72 with a 40 bar (600 psi) measuring cell)) and may be applied for a limited period only to ensure that no lasting damage occurs.
- ▶ The Pressure Equipment Directive (EC Directive 97/23/EC) uses the abbreviation "PS". The abbreviation "PS" corresponds to the MWP (maximum working pressure) of the measuring device.
- ▶ In the case of sensor range and process connections where the over pressure limit (OPL) of the process connection is smaller than the nominal value of the sensor, the device is set at the factory, at the very maximum, to the OPL value of the process connection. If you want to use the entire sensor range, select a process connection with a higher OPL value (1.5 x PN; MWP = PN).
- ▶ Devices with ceramic process isolating diaphragm: Avoid steam hammering! Steam hammering can cause zero point drifts. Recommendation: Residue (such as condensation or drops of water) can remain at the process isolating diaphragm after CIP cleaning and lead to local steam hammering if immediately steam is introduced. In practice, drying the process isolating diaphragm (e.g. by blowing) has proved to prevent steam hammering.

15.7 Additional technical data

See Technical Information.

Index

0 ... 9

2nd disp. value (002)	78
3rd disp. value (288)	79

A

Adjust density (034)	90
Alarm behav. P (050)	93
Alarm cur. switch (165)	94
Application	10

C

Calibration mode (027)	87
CE mark (declaration of conformity)	11
Cleaning	71
Code definition (023)	85
Config. counter (100)	103
Configuration of a level measurement	48
Configuration of a pressure measurement	61
Configure high-pressure side	46
Configure language	45
Configure measuring mode	46
Configure pressure engineering unit	47
Configuring level measurement	48
Configuring pressure measurement	61
Corrected press. (172)	81, 106
Counter P < Pmin (262)	97
Counter P < Pmin (267)	99
Counter P > Pmax (263)	98
Counter P > Pmax (269)	99
Cust. tag number (254)	102

D

Damping (017)/(184)	84
Damping switch (164)	83
Declaration of Conformity	11
Designated use	10
Device replacement	72
Device revision (108)	103
Device tag (022)	85, 102
Device type code (279)	103
Diagnostic 1 (075)	100
Diagnostic 2 (076)	100
Diagnostic 3 (077)	100
Diagnostic 4 (078)	100
Diagnostic 5 (079)	100
Diagnostic 6 (080)	100
Diagnostic 7 (081)	100
Diagnostic 8 (082)	100
Diagnostic 9 (083)	100
Diagnostic 10 (084)	100
Diagnostic code (071)	97
Diagnostic event	66
Diagnostic events	65
Diagnostic message	65
Diagnostics	
Symbols	65

Display mode (001)	78
Display module contrast	34
Disposal	70

E

Edit table (042)	92
Empty calib. (011/028)	82, 88
Empty height (030)/(186)	88
Empty pressure (029)/(185)	88
ENP version (099)	102
Enter reset code (124)	110
Error symbols	34
Event text	66
Ext. order code (097)	101
Exterior cleaning	71

F

Field of application	
Residual risks	10
Firmware version (095)	101
Format 1st value (004)	79
Full calib. (012/031)	82, 89
Full height (033)/(188)	89
Full pressure (032)/(187)	89

G

Get LRV (015)	95
Get URV (016)	96

H

HART input form. (157)	80
HART® protocol	
Operating tools	40
Process variables	40
Version data for the device	40
Height unit (026)	87
High press. side (183)	81
High. alarm curr. (052)	94

L

Last diag. 1 (085)	101
Last diag. 2 (086)	101
Last diag. 3 (087)	101
Last diag. 4 (088)	101
Last diag. 5 (089)	101
Last diag. 6 (090)	101
Last diag. 7 (091)	101
Last diag. 8 (092)	101
Last diag. 9 (093)	101
Last diag. 10 (094)	101
Last diag. code (072)	97
Level before lin. (019)	84, 90, 105
Level selection (024)	86
Lin. mode (037)	91
Line number (039)	92
Locking status	35
LRL sensor (101)	104

LRL sensor (272) 104

M

Maintenance 71
 Manufacturer ID (103) 103
 Max. meas. press. (074) 98
 Max. meas. press. (268) 99
 Max. meas. temp. (265) 98
 MAX. MEAS. TEMP. (271) 100
 Meas. press. HP (281) 106
 Meas. press. LP (282) 106
 Meas.Diff.Press. (020) 84, 105
 Measuring mode (005/182) 80
 Media 10
 Menu
 Description of device parameters 78
 Overview 74
 Min. meas. press. (073) 97
 Min. meas. press. (266) 99
 Min. meas.temp. (264) 98
 Min. meas.temp. (270) 100

N

Nameplate 15

O

Onsite display
 see Diagnostic message
 see In alarm condition
 Operating menu
 Description of device parameters 78
 Overview 74
 Operational safety 11
 Operator code (021) 85
 Order code (098) 102
 Output current (054) 95
 Output fail mode (051)/(190) 94

P

Pos. zero adjust (007) 81
 Press. eng. unit (125) 81
 Process density (035) 90
 Product safety 11

R

Repair concept 72
 Replacing a device 72

S

Safety Instructions
 Basic 10
 Safety Instructions (XA) 7
 Sensor press. LP (280) 106
 Sensor pressure HP (109) 106
 Sensor temp. HP (110) 107
 Sensor temp. LP (283) 107
 Serial number (096) 101
 Set LRV (013, 056, 166, 168) 83, 96
 Set min. current (053) 95
 Set URV (014, 057, 167, 169) 83, 96

Sim. current (117) 110
 Sim. diff.press. (113) 108
 Sim. error no. (118) 110
 Sim. level (115) 109
 Sim. press. HP (284) 109
 Sim. press. LP (285) 109
 Sim. tank cont. (116) 109
 Simulation mode (112) 107
 Spare parts 73
 Nameplate 73
 Staff
 Requirements 10
 Status signals 65

T

Tank content (043) 93, 105
 Tank description (173) 93
 Transmitter
 Turning the display module 22
 Troubleshooting 65
 Turning the display module 22

U

Unit after lin. (038) 91
 Unit before lin. (025) 86
 URL sensor (102) 104
 URL sensor (273) 104
 Use of the measuring device
 see Designated use
 Use of the measuring devices
 Borderline cases 10
 Incorrect use 10

W

W@M Device Viewer 73
 Workplace safety 11

X

X-value (040)/(123)/(193) 92

Y

Y-value (041)/(194) 92



71376028

www.addresses.endress.com
