

Operating Instructions

Levelflex FMP53

HART

Guided wave radar

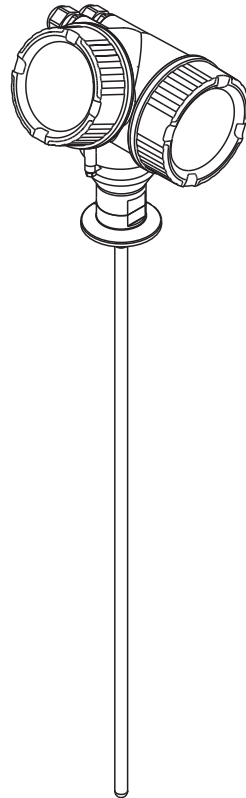

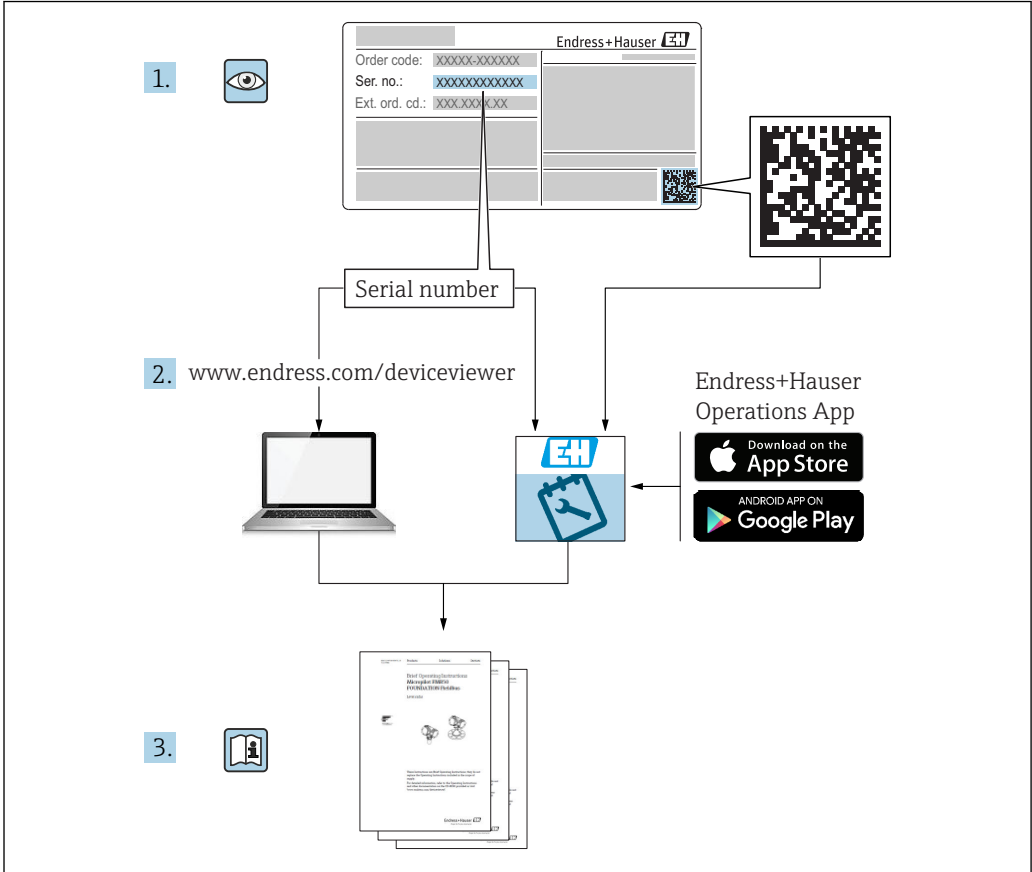

A0023555

Table of contents

1	Important document information	5		
1.1	Document function	5		
1.2	Document conventions	5		
1.2.1	Safety symbols	5		
1.2.2	Electrical symbols	5		
1.2.3	Tool symbols	6		
1.2.4	Symbols for certain types of information and graphics	6		
1.3	Documentation	7		
1.3.1	Technical Information (TI)	7		
1.3.2	Brief Operating Instructions (KA)	7		
1.3.3	Safety Instructions (XA)	7		
1.4	Terms and abbreviations	7		
1.5	Registered trademarks	8		
2	Basic safety instructions	9		
2.1	Requirements for the personnel	9		
2.2	Designated use	9		
2.3	Occupational safety	10		
2.4	Operational safety	10		
2.5	Product safety	10		
2.5.1	CE mark	10		
2.5.2	EAC conformity	11		
3	Product description	12		
3.1	Product design	12		
3.1.1	Levelflex FMP53	12		
3.1.2	Electronics housing	13		
4	Incoming acceptance and product identification	14		
4.1	Incoming acceptance	14		
4.2	Product identification	14		
4.2.1	Nameplate	15		
5	Storage, transport	16		
5.1	Storage temperature	16		
5.2	Transporting the product to the measuring point	16		
6	Installation	17		
6.1	Installation conditions	17		
6.1.1	Suitable mounting position	17		
6.1.2	Mounting under confined conditions	19		
6.1.3	Notes on the mechanical load of the probe	21		
6.1.4	Special installation situations	22		
6.2	Mounting the measuring device	28		
6.2.1	Tools list	28		
6.2.2	Mounting the "Sensor, remote" version	28		
6.2.3	Turning the transmitter housing	29		
6.2.4	Turning the display	30		
6.3	Post-installation check	31		
7	Electrical connection	32		
7.1	Connection conditions	32		
7.1.1	Terminal assignment	32		
7.1.2	Cable specification	38		
7.1.3	Device plugs	39		
7.1.4	Power supply	40		
7.1.5	Overvoltage protection	43		
7.2	Connecting the measuring device	43		
7.2.1	Opening connection compartment cover	44		
7.2.2	Connecting	44		
7.2.3	Plug-in spring-force terminals	45		
7.2.4	Closing connection compartment cover	45		
7.3	Post-connection check	46		
8	Operation options	47		
8.1	Overview	47		
8.1.1	Local operation	47		
8.1.2	Operation with remote display and operating module FHX50	48		
8.1.3	Operation via Bluetooth® wireless technology	49		
8.1.4	Remote operation	50		
8.2	Structure and function of the operating menu	51		
8.2.1	Structure of the operating menu	51		
8.2.2	User roles and related access authorization	53		
8.2.3	Data access - Security	53		
8.3	Display and operating module	58		
8.3.1	Display appearance	58		
8.3.2	Operating elements	61		
8.3.3	Enter numbers and text	62		
8.3.4	Opening the context menu	64		
8.3.5	Envelope curve display on the display and operating module	65		
9	Device integration via the HART protocol	66		
9.1	Overview of the Device Description files (DD)	66		
9.2	HART device variables and measuring values	66		

10	Commissioning via SmartBlue (App)	67		
10.1	Requirements	67		
10.2	SmartBlue App	67		
10.3	Envelope curve display in SmartBlue	67		
11	Commissioning using the Commissioning Wizard	69		
12	Commissioning via operating menu	70		
12.1	Function check	70		
12.2	Setting the operating language	70		
12.3	Configuring level measurement	71		
12.4	Recording the reference envelope curve	73		
12.5	Configuring the local display	74		
12.5.1	Factory setting of local display for level measurements	74		
12.5.2	Adjusting the local display	74		
12.6	Configuring the current outputs	75		
12.6.1	Factor setting of current outputs for level measurements	75		
12.6.2	Adjusting the current outputs	75		
12.7	Configuration management	76		
12.8	Protecting settings from unauthorized access	77		
13	Diagnostics and troubleshooting ...	78		
13.1	General troubleshooting	78		
13.1.1	General errors	78		
13.1.2	Error - SmartBlue operation	80		
13.1.3	Parameter configuration errors	81		
13.2	Diagnostic information on local display	82		
13.2.1	Diagnostic message	82		
13.2.2	Calling up remedial measures	84		
13.3	Diagnostic event in the operating tool	85		
13.4	Diagnostic list	86		
13.5	List of diagnostic events	87		
13.6	Event logbook	89		
13.6.1	Event history	89		
13.6.2	Filtering the event logbook	89		
13.6.3	Overview of information events	89		
13.7	Firmware history	91		
14	Maintenance	92		
14.1	Exterior cleaning	92		
14.2	Cleaning the probe	92		
14.2.1	Cleaning the probe in the tank	92		
14.2.2	Cleaning the probe outside the tank	93		
15	Repair	94		
15.1	General notes	94		
15.1.1	Repair concept	94		
15.1.2	Repair of Ex-certified devices	94		
15.1.3	Replacing electronics modules	94		
15.1.4	Replacing a device	94		
15.2	Spare parts	95		
15.3	Return	95		
15.4	Disposal	95		
16	Accessories	96		
16.1	Device-specific accessories	96		
16.1.1	Weather protection cover	96		
16.1.2	Mounting bracket for electronics housing	97		
16.1.3	Weld-in adapter	97		
16.1.4	Protective cover	98		
16.1.5	Calibration kit	98		
16.1.6	Remote display FHX50	99		
16.1.7	Overvoltage protection	100		
16.1.8	Bluetooth module for HART devices	101		
16.2	Communication-specific accessories	102		
16.3	Service-specific accessories	103		
16.4	System components	103		
17	Operating menu	104		
17.1	Overview of the operating menu (SmartBlue)	104		
17.2	Overview of the operating menu (display module)	109		
17.3	Overview of the operating menu (operating tool)	116		
17.4	"Setup" menu	123		
17.4.1	"Mapping" wizard	131		
17.4.2	"Advanced setup" submenu	132		
17.5	"Diagnostics" menu	180		
17.5.1	"Diagnostic list" submenu	182		
17.5.2	"Event logbook" submenu	183		
17.5.3	"Device information" submenu	184		
17.5.4	"Measured values" submenu	187		
17.5.5	"Data logging" submenu	189		
17.5.6	"Simulation" submenu	192		
17.5.7	"Device check" submenu	197		
17.5.8	"Heartbeat" submenu	199		
	Index	200		

1 Important document information

1.1 Document function

These Operating Instructions provide all of the information that is required in various phases of the life cycle of the device including:

- Product identification
- Incoming acceptance
- Storage
- Installation
- Connection
- Operation
- Commissioning
- Troubleshooting
- Maintenance
- Disposal

1.2 Document conventions

1.2.1 Safety symbols

DANGER

This symbol alerts you to a dangerous situation. Failure to avoid this situation will result in serious or fatal injury.

WARNING

This symbol alerts you to a dangerous situation. Failure to avoid this situation can result in serious or fatal injury.

CAUTION

This symbol alerts you to a dangerous situation. Failure to avoid this situation can result in minor or medium injury.

NOTICE

This symbol contains information on procedures and other facts which do not result in personal injury.

1.2.2 Electrical symbols



Alternating current



Direct current and alternating current



Direct current



Ground connection

A grounded terminal which, as far as the operator is concerned, is grounded via a grounding system.

Protective earth (PE)

Ground terminals that must be connected to ground prior to establishing any other connections.

The ground terminals are located on the interior and exterior of the device:

- Interior ground terminal: protective earth is connected to the mains supply.
- Exterior ground terminal: device is connected to the plant grounding system.

1.2.3 Tool symbols



Phillips head screwdriver



Flat blade screwdriver



Torx screwdriver



Allen key



Open-ended wrench

1.2.4 Symbols for certain types of information and graphics



Permitted

Procedures, processes or actions that are permitted



Preferred

Procedures, processes or actions that are preferred



Forbidden

Procedures, processes or actions that are forbidden



Tip

Indicates additional information



Reference to documentation



Reference to graphic



Notice or individual step to be observed

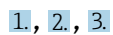

Series of steps



Result of a step



Visual inspection



Operation via operating tool



Write-protected parameter

1, 2, 3, ...

Item numbers

A, B, C, ...

Views



Safety instructions

Observe the safety instructions contained in the associated Operating Instructions



Temperature resistance of the connection cables

Specifies the minimum value of the temperature resistance of the connection cables

1.3 Documentation

The following documentation types are available in the Downloads area of the Endress+Hauser website (www.endress.com/downloads):

-  For an overview of the scope of the associated Technical Documentation, refer to the following:
 - *W@M Device Viewer* (www.endress.com/deviceviewer): Enter the serial number from nameplate
 - *Endress+Hauser Operations App*: Enter the serial number from the nameplate or scan the 2D matrix code (QR code) on the nameplate

1.3.1 Technical Information (TI)

Planning aid

The document contains all the technical data on the device and provides an overview of the accessories and other products that can be ordered for the device.

1.3.2 Brief Operating Instructions (KA)

Guide that takes you quickly to the 1st measured value

The Brief Operating Instructions contain all the essential information from incoming acceptance to initial commissioning.

1.3.3 Safety Instructions (XA)

Depending on the approval, the following Safety Instructions (XA) are supplied with the device. They are an integral part of the Operating Instructions.

-  The nameplate indicates the Safety Instructions (XA) that are relevant to the device.

1.4 Terms and abbreviations

BA

Document type "Operating Instructions"

KA

Document type "Brief Operating Instructions"

TI

Document type "Technical Information"

SD

Document type "Special Documentation"

XA

Document type "Safety Instructions"

PN

Nominal pressure

MWP

MWP (Maximum working pressure/max. process pressure)
The MWP can also be found on the nameplate.

ToF

Time of Flight

FieldCare

Scalable software tool for device configuration and integrated plant asset management solutions

DeviceCare

Universal configuration software for Endress+Hauser HART, PROFIBUS, FOUNDATION Fieldbus and Ethernet field devices

DTM

Device Type Manager

DD

Device Description for HART communication protocol

 ϵ_r (Dk value)

Relative dielectric constant

PLC

Programmable logic controller (PLC)

CDI

Common Data Interface

Operating tool

The term "operating tool" is used in place of the following operating software:

- FieldCare / DeviceCare, for operation via HART communication and PC
- SmartBlue (app), for operation using an Android or iOS smartphone or tablet

BD

Blocking Distance; no signals are analyzed within the BD.

PLC

Programmable logic controller (PLC)

CDI

Common Data Interface

PFS

Pulse Frequency Status (Switch output)

1.5 Registered trademarks

HART®

Registered trademark of the FieldComm Group, Austin, Texas, USA

Bluetooth®

The *Bluetooth*® word mark and logos are registered trademarks owned by the Bluetooth SIG, Inc. and any use of such marks by Endress+Hauser is under license. Other trademarks and trade names are those of their respective owners.

Apple®

Apple, the Apple logo, iPhone, and iPod touch are trademarks of Apple Inc., registered in the U.S. and other countries. App Store is a service mark of Apple Inc.

Android®

Android, Google Play and the Google Play logo are trademarks of Google Inc.

KALREZ®, VITON®

Registered trademarks of DuPont Performance Elastomers L.L.C., Wilmington, DE USA

TEFLON®

Registered trademark of E.I. DuPont de Nemours & Co., Wilmington, USA

TRI-CLAMP®

Registered trademark of Ladish & Co., Inc., Kenosha, USA

2 Basic safety instructions

2.1 Requirements for the personnel

The personnel for installation, commissioning, diagnostics and maintenance must fulfill the following requirements:

- ▶ Trained, qualified specialists must have a relevant qualification for this specific function and task.
- ▶ Are authorized by the plant owner/operator.
- ▶ Are familiar with federal/national regulations.
- ▶ Before starting work, read and understand the instructions in the manual and supplementary documentation as well as the certificates (depending on the application).
- ▶ Follow instructions and comply with basic conditions.

The operating personnel must fulfill the following requirements:

- ▶ Are instructed and authorized according to the requirements of the task by the facility's owner-operator.
- ▶ Follow the instructions in this manual.

2.2 Designated use

Application and media

The measuring device described in this manual is intended only for the level measurement of liquids. Depending on the version ordered, the measuring device can also measure potentially explosive, flammable, poisonous and oxidizing media.

If the limit values specified in the "Technical data" and the conditions listed in the manual and additional documentation are observed, the measuring device may be used for the following measurements only:

- ▶ Measured process variables: level
- ▶ Calculable process variables: volume or mass in any shape of vessel (calculated from the level by the linearization functionality)

To ensure that the measuring device remains in proper condition for the operation time:

- ▶ Use the measuring device only for media to which the process-wetted materials have an adequate level of resistance.
- ▶ Observe the limit values in "Technical data".

Incorrect use

The manufacturer is not liable for damage caused by improper or non-designated use.

Clarification of borderline cases:

- ▶ For special fluids and fluids for cleaning, Endress+Hauser is glad to provide assistance in verifying the corrosion resistance of fluid-wetted materials, but does not accept any warranty or liability.

Residual risks

Due to heat transfer from the process as well as power loss in the electronics, the temperature of the electronics housing and the assemblies contained therein (e.g. display module, main electronics module and I/O electronics module) may rise up to 80 °C (176 °F). When in operation, the sensor may reach a temperature close to the medium temperature.

Danger of burns from contact with surfaces!

- ▶ In the event of elevated medium temperatures, ensure protection against contact to prevent burns.

2.3 Occupational safety

When working on and with the device:

- ▶ Wear the required personal protective equipment according to federal/national regulations.

With divisible probe rods, medium may penetrate the joints between the individual parts of the rod. This medium may escape when the joints are loosened. This can cause injuries in the case of dangerous (e.g., aggressive or toxic) media.

- ▶ When loosening the joints between the individual parts of the probe rod, wear appropriate protective equipment according to the medium.

2.4 Operational safety

Risk of injury!

- ▶ Operate the device only if it is in proper technical condition, free from errors and faults.
- ▶ The operator is responsible for interference-free operation of the device.

Modifications to the device

Unauthorized modifications to the device are not permitted and can lead to unforeseeable dangers:

- ▶ If modifications are nevertheless required, consult with the manufacturer.

Repair

To ensure continued operational safety and reliability:

- ▶ Carry out repairs on the device only if they are expressly permitted.
- ▶ Observe federal/national regulations pertaining to the repair of an electrical device.
- ▶ Use only original spare parts and accessories from the manufacturer.

Hazardous area

To eliminate the risk of danger to persons or the facility when the device is used in the approval-related area (e.g. explosion protection, pressure equipment safety):

- ▶ Check the nameplate to verify if the device ordered can be put to its intended use in the approval-related area.
- ▶ Observe the specifications in the separate supplementary documentation that is an integral part of this manual.

2.5 Product safety

This measuring device is designed in accordance with good engineering practice to meet state-of-the-art safety requirements, has been tested, and left the factory in a condition in which it is safe to operate. It meets general safety standards and legal requirements.

NOTICE

Loss of degree of protection by opening of the device in humid environments

- ▶ If the device is opened in a humid environment, the degree of protection indicated on the nameplate is no longer valid. This may also impair the safe operation of the device.

2.5.1 CE mark

The measuring system meets the legal requirements of the applicable EU Directives. These are listed in the corresponding EU Declaration of Conformity along with the standards applied.

Endress+Hauser confirms successful testing of the device by affixing to it the CE mark.

2.5.2 EAC conformity

The measuring system meets the legal requirements of the applicable EAC guidelines. These are listed in the corresponding EAC Declaration of Conformity together with the standards applied.

Endress+Hauser confirms successful testing of the device by affixing to it the EAC mark.

3 Product description

3.1 Product design

3.1.1 Levelflex FMP53

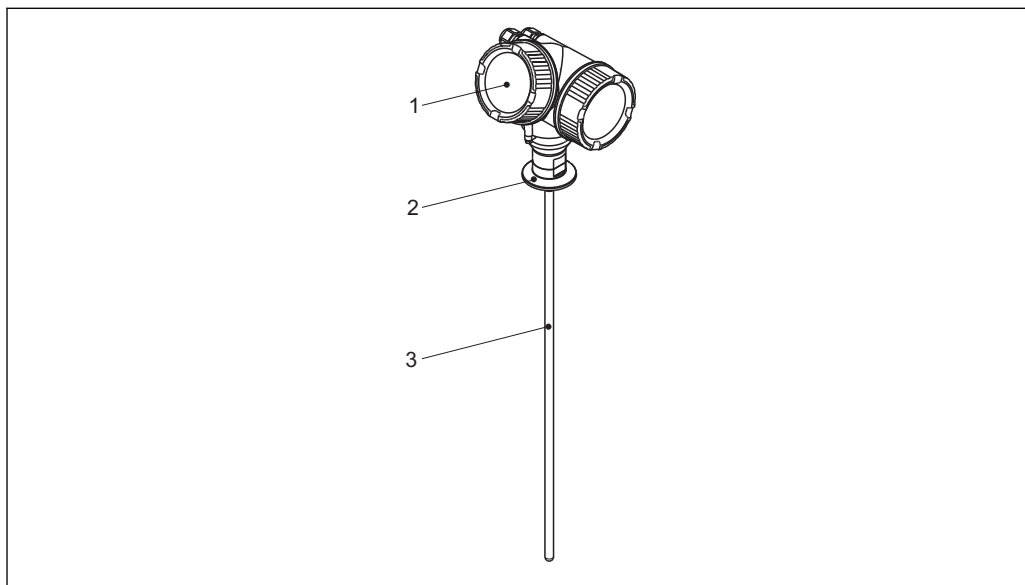

A0013421

1 Design of the Levelflex

- 1 Electronics housing
- 2 Process connection
- 3 Rod probe

3.1.2 Electronics housing

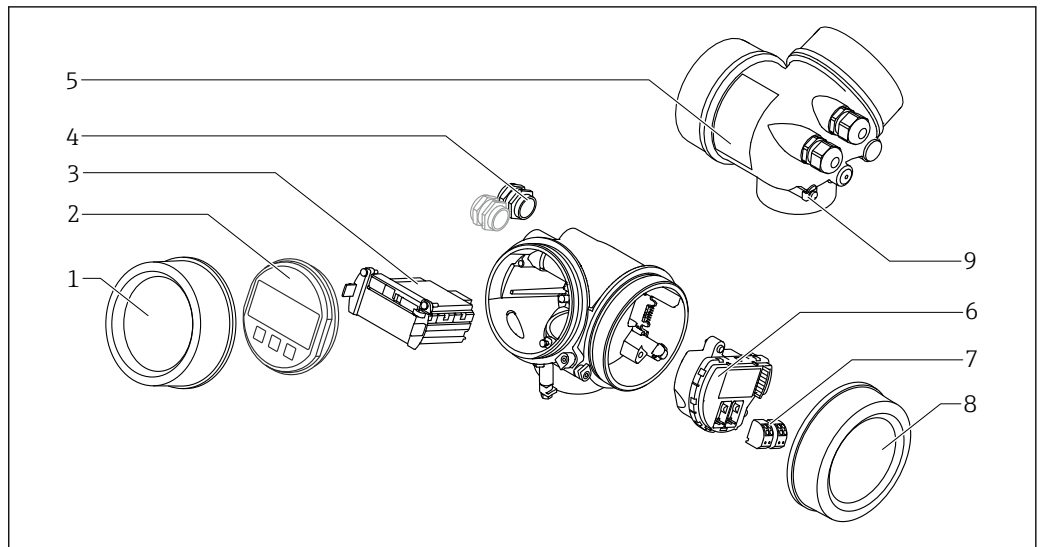

A0012422

2 Design of the electronics housing

- 1 Electronics compartment cover
- 2 Display module
- 3 Main electronics module
- 4 Cable glands (1 or 2, depending on instrument version)
- 5 Nameplate
- 6 I/O electronics module
- 7 Terminals (pluggable spring terminals)
- 8 Connection compartment cover
- 9 Grounding terminal

4 Incoming acceptance and product identification

4.1 Incoming acceptance

Upon receipt of the goods check the following:

- Are the order codes on the delivery note and the product sticker identical?
- Are the goods undamaged?
- Do the nameplate data match the ordering information on the delivery note?
- If required (see nameplate): Are the Safety Instructions (XA) present?



If one of these conditions is not satisfied, contact your Endress+Hauser Sales Center.

4.2 Product identification

The following options are available for identification of the measuring device:

- Nameplate specifications
- Order code with breakdown of the device features on the delivery note
- Enter serial numbers from nameplates in *W@M Device Viewer* (www.endress.com/deviceviewer): All information about the measuring device is displayed.
- Enter the serial number from the nameplates into the *Endress+Hauser Operations App* or scan the 2-D matrix code (QR code) on the nameplate with the *Endress+Hauser Operations App*: all the information for the measuring device is displayed.

4.2.1 Nameplate

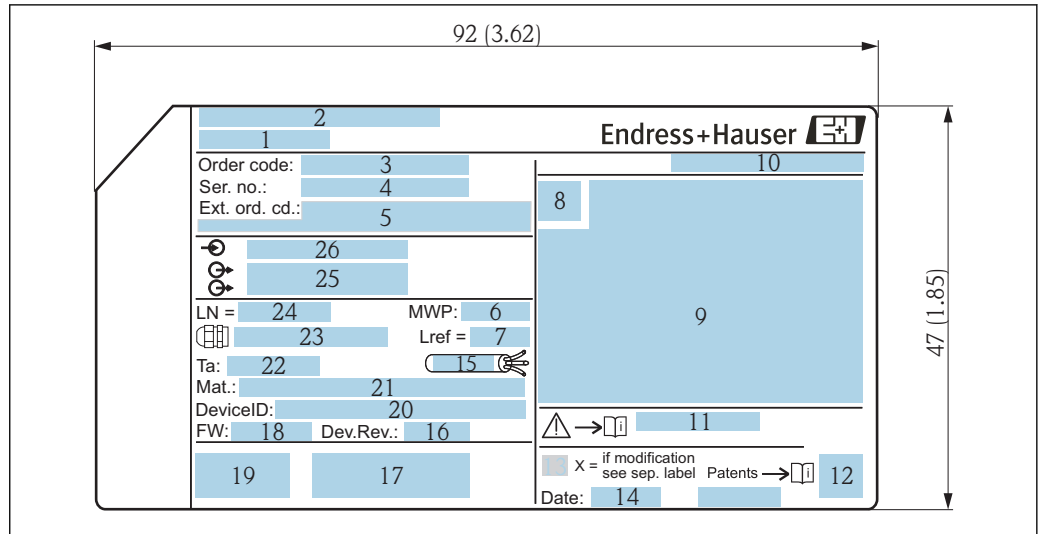

A0010725

3 Nameplate of the Levelflex; Dimensions: mm (in)

- 1 Device name
- 2 Address of manufacturer
- 3 Order code
- 4 Serial number (Ser. no.)
- 5 Extended order code (Ext. ord. cd.)
- 6 Process pressure
- 7 Gas phase compensation: reference distance
- 8 Certificate symbol
- 9 Certificate and approval relevant data
- 10 Degree of protection: e.g. IP, NEMA
- 11 Document number of the Safety Instructions: e.g. XA, ZD, ZE
- 12 2-D matrix code (QR code)
- 13 Modification mark
- 14 Manufacturing date: year-month
- 15 Permitted temperature range for cable
- 16 Device revision (Dev.Rev.)
- 17 Additional information about the device version (certificates, approvals, communication): e.g. SIL, PROFIBUS
- 18 Firmware version (FW)
- 19 CE mark, C-Tick
- 20 DeviceID
- 21 Material in contact with process
- 22 Permitted ambient temperature (T_a)
- 23 Size of the thread of the cable glands
- 24 Length of probe
- 25 Signal outputs
- 26 Operating voltage

i Only 33 digits of the extended order code can be indicated on the nameplate. If the extended order code exceeds 33 digits, the rest will not be shown. However, the complete extended order code can be viewed in the operating menu of the device in the **Extended order code 1 to 3** parameter.

5 Storage, transport

5.1 Storage temperature

- Permitted storage temperature: -40 to $+80$ °C (-40 to $+176$ °F)
- Use original packaging.

5.2 Transporting the product to the measuring point

⚠ WARNING

Housing or rod may become damaged or pull off.

Risk of injury!

- ▶ Transport the measuring device to the measuring point in its original packaging or by the process connection.
- ▶ Always secure lifting equipment (slings, eyes, etc.) at the process connection and never lift the device by the electronic housing or probe. Pay attention to the center of gravity of the device so that it does not tilt or slip unintentionally.
- ▶ Follow the safety instructions and transport conditions for devices weighing more than 18 kg (39.6 lbs) (IEC 61010).

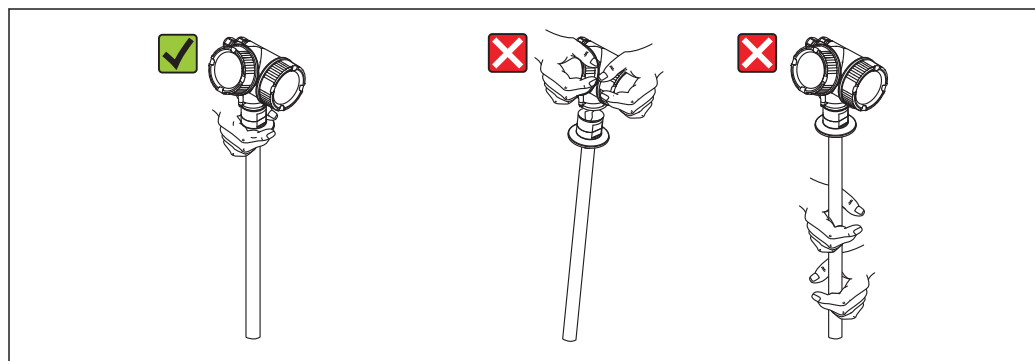

A0014267

6 Installation

6.1 Installation conditions

6.1.1 Suitable mounting position

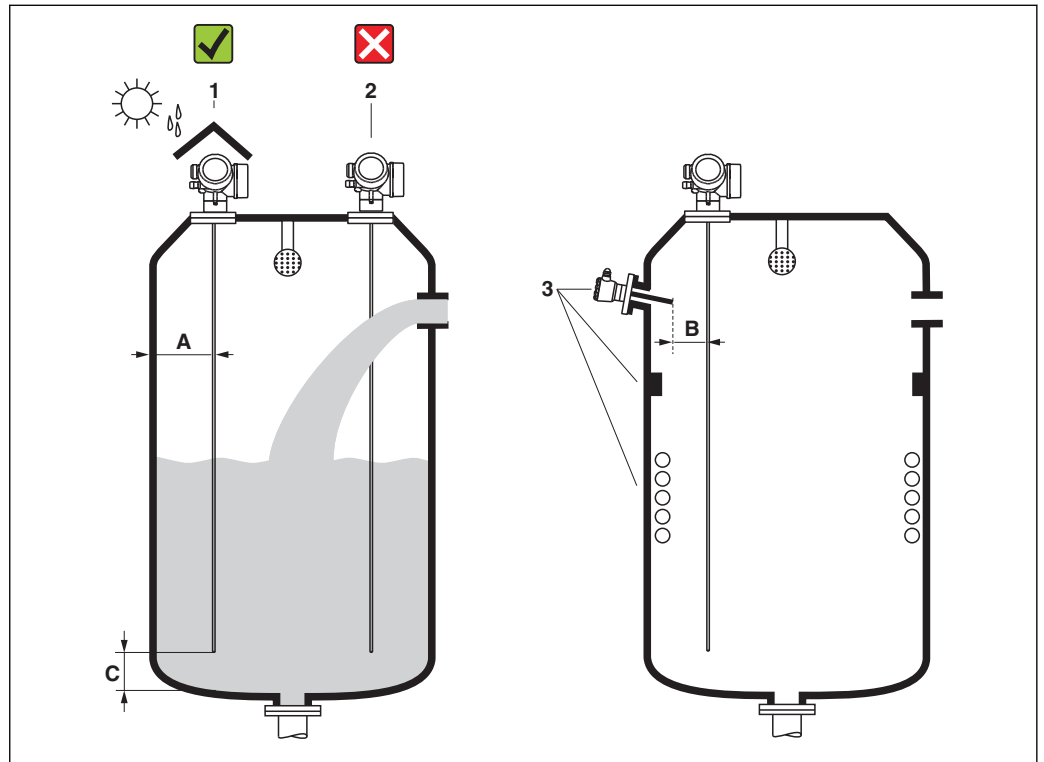

4 Installation conditions for Levelflex

A0014130

Spacing requirements when mounting

- Distance (A) between the vessel wall and rod probes:
 - For smooth metallic walls: > 50 mm (2 in)
 - For plastic walls: > 300 mm (12 in) to metallic parts outside the vessel
- Distance (B) between rod probes and internal fittings (4): > 300 mm (12 in)
- When using more than one Levelflex:
 - Minimum distance between the sensor axes: 100 mm (3.94 in)
- Distance (C) from the end of the probe to the bottom of the vessel: > 10 mm (0.4 in)

Additional conditions

- When mounting outdoors, a weather protection cover (1) can be used to protect the device against extreme weather conditions.
 - Do not mount the probe in the filling curtain (2).
-  When the housing is mounted in a recess (e.g. in a concrete ceiling), observe a minimum distance of 100 mm (4 in) between the cover of the connection compartment/electronics compartment and the wall. Otherwise the connection compartment/electronics compartment will not be accessible after installation.

6.1.2 Mounting under confined conditions

Mounting with remote probe

The device version with a remote probe is suitable for applications with restricted mounting space (product structure: probe design). In this case, the electronics housing is mounted at a separate position from the probe.

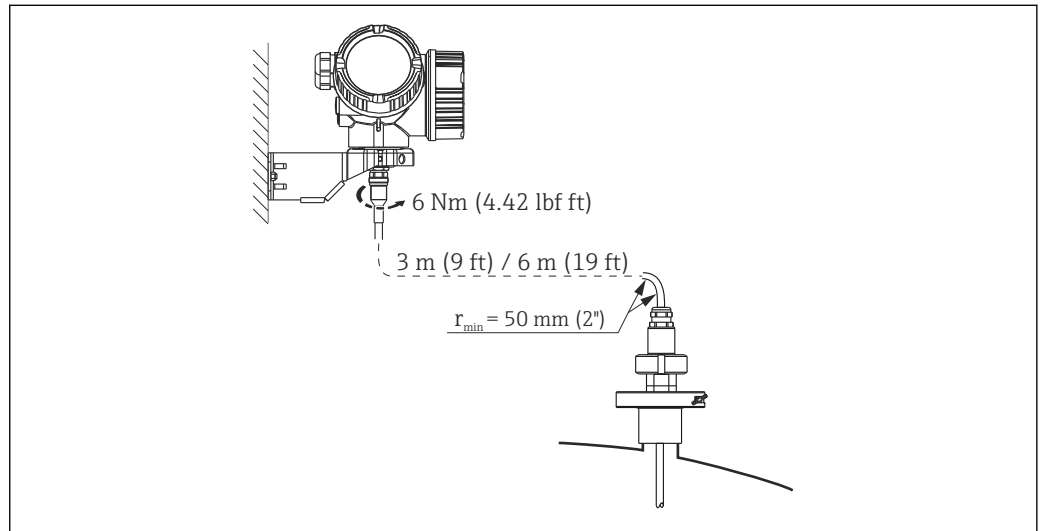

A0015103

- The connecting cable is connected to the probe upon delivery.
 - Length: 3 m (9 ft) or 6 m (18 ft)
 - Minimum bending radius: 50 mm (2 inch)
 - The mounting bracket for the electronics housing is included in the delivery with this version. Mounting options:
 - Wall mounting
 - Mounting on DN32 to DN50 (1-1/4 to 2 inch) post or pipe
- i** The probe with the connection cable and the electronics are mutually compatible and bear a common serial number. Only components with the same serial number may be connected to one another.

Separable probes

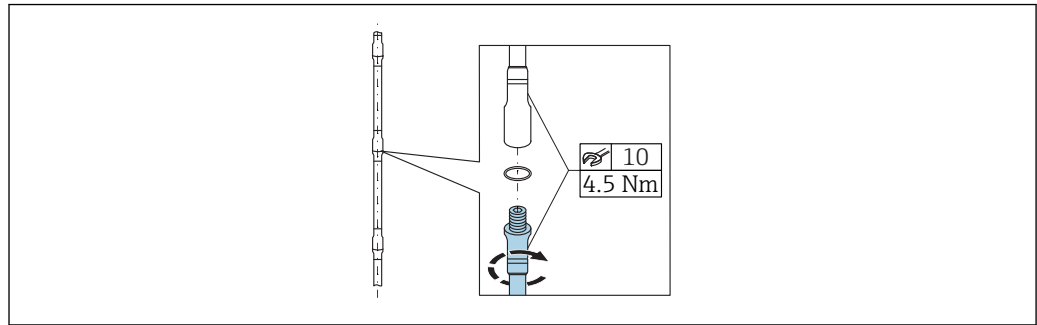

The use of separable rod probes (\varnothing 8 mm) is advisable in confined mounting conditions (limited distance to the ceiling).

- Max. probe length 6 m (19.68 ft)
 - Max. lateral loading capacity 10 Nm
 - Probes can be separated several times, with the individual parts having the following lengths:
 - 500 mm (20 in)
 - 1 000 mm (40 in)
 - The connection points are sealed gap-free by an O-ring.
- i** To avoid damage to the surface of the probe: use fitting pliers with a plastic surface to mount the probe rod.

6.1.3 Notes on the mechanical load of the probe

Lateral loading capacity (flexural strength) of rod probes

FMP53

Rod 8mm (0.31") 316L

10 Nm

Rod 8mm (0.31") 316L separable

10 Nm

Lateral load (bending moment) from flow conditions

The formula for calculating the bending moment M acting on the probe:

$$M = c_w \times \rho / 2 \times v^2 \times d \times L \times (L_N - 0.5 \times L)$$

With:

c_w : coefficient of friction

ρ [kg/m³]: density of the medium

v [m/s]: flow velocity of the medium, perpendicular to the probe rod

d [m]: diameter of the probe rod

L [m]: level

L_N [m]: probe length

Sample calculation

Coefficient of friction c_w	0.9 (assuming turbulent flow - high Reynolds number)
Density ρ [kg/m ³]	1000 (e.g. water)
Probe diameter d [m]	0.008
$L = L_N$	(unfavorable conditions)

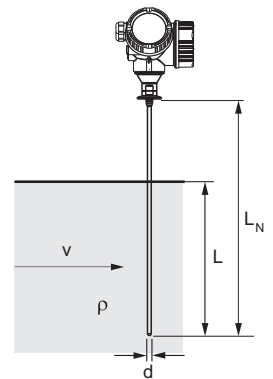

A0014175

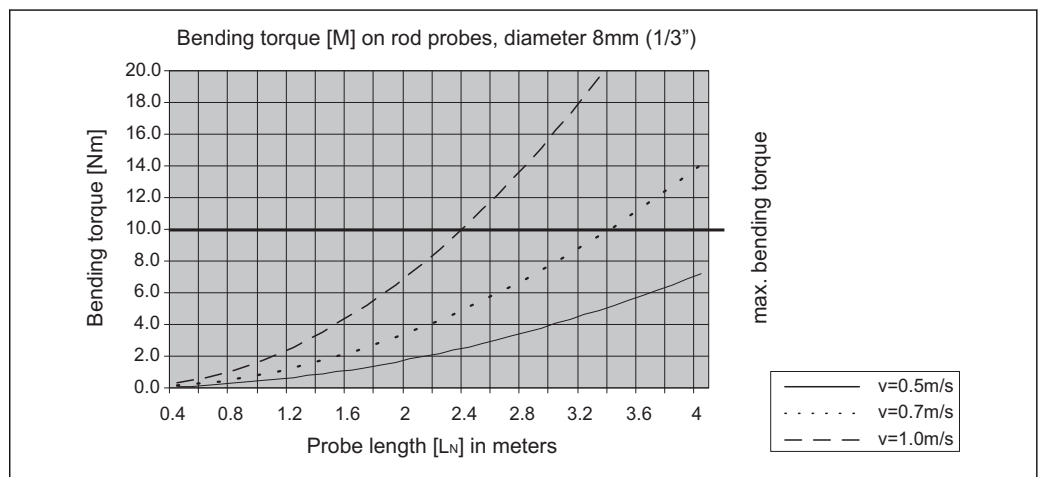

A0014182-EN

6.1.4 Special installation situations

Tanks with spray ball for probe cleaning

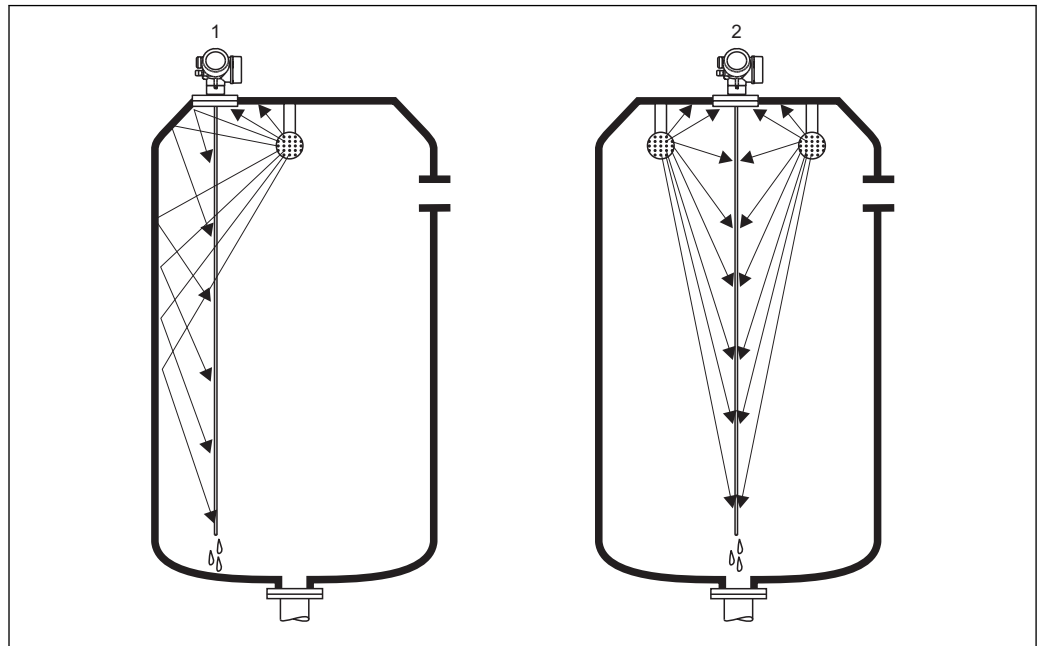

A0014131

Mounting close to vessel wall

Mounting the probe close to the vessel wall improves the cleaning effect when a spray ball is used. The cleaning jet is directed onto the probe via the vessel wall. As a result, the probe is also cleaned in places the spray ball jet would normally not reach. You only require one spray ball for this probe arrangement.

Mounting in the center of the vessel

If the probe is mounted in the center of the vessel, the use of a second spray ball may be necessary. These balls should then be mounted to the left and right of the probe.

Mounting at an angle

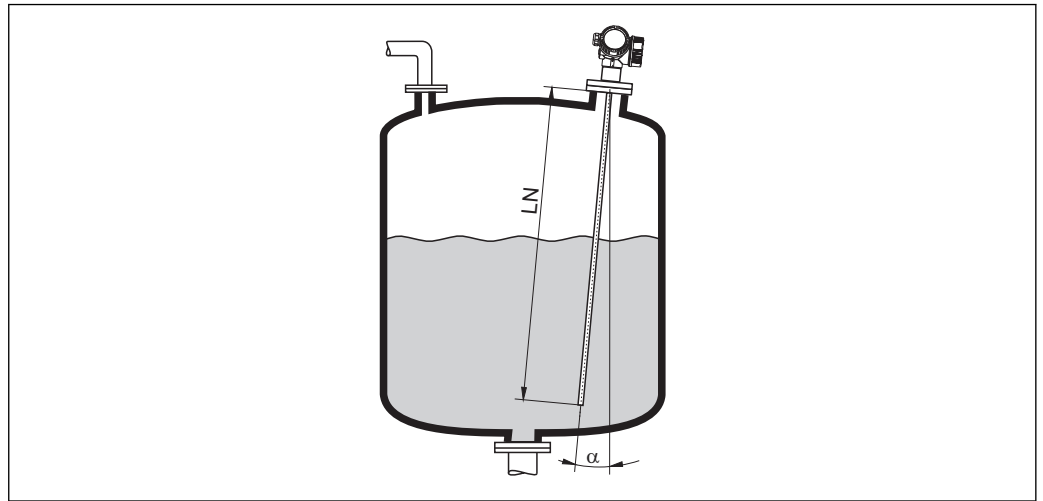

A0014145

- For mechanical reasons, the probe should be installed as vertically as possible.
- If the probe is installed at an angle, the length of the probe must be reduced depending on the angle of installation.
 - α 5°: LN_{max} . 4 m (13.1 ft)
 - α 10°: LN_{max} . 2 m (6.6 ft)
 - α 30°: LN_{max} . 1 m (3.3 ft)

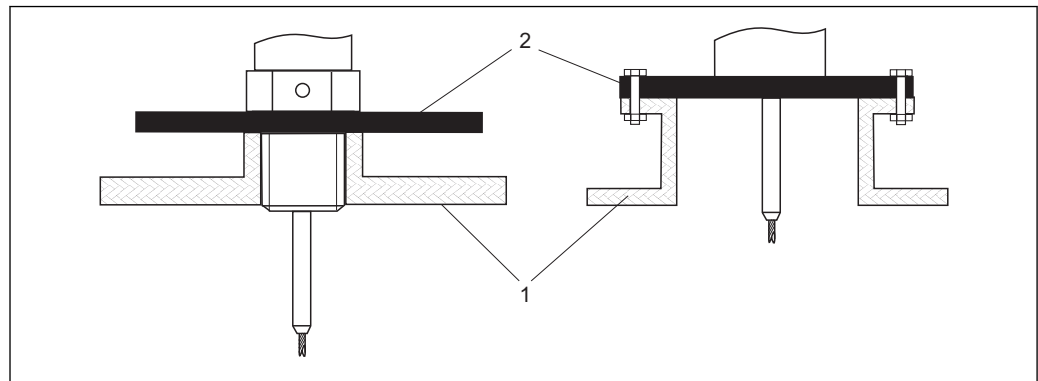
Non-metal vessels

- 1 *Non-metal vessel*
- 2 *Metal sheet or metal flange*

To ensure good measurement results when mounting on non-metal vessels, at the process connection mount a metal sheet with a diameter of at least 200 mm (8 in) at a right angle to the probe.

Plastic and glass vessels: Mounting the probe on the outside wall

In the case of plastic and glass vessels, the probe can also be mounted on the outside wall under certain conditions.

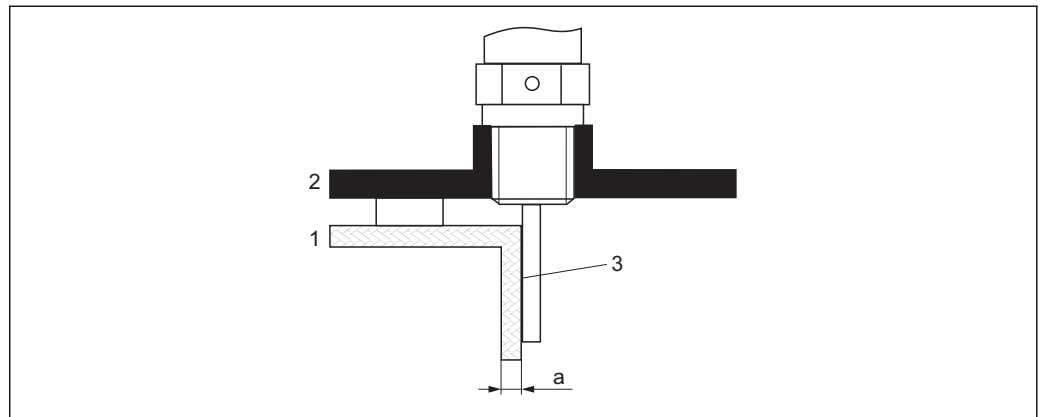

- 1 Plastic or glass vessel
- 2 Metal plate with screw-in sleeve
- 3 No space between vessel wall and probe!

Requirements

- Dielectric constant of the medium: $\epsilon_r > 7$.
- Non-conductive vessel wall.
- Maximum wall thickness (a):
 - Plastic: < 15 mm (0.6 in)
 - Glass: < 10 mm (0.4 in)
- No metal reinforcements on the vessel.

Note the following when mounting the device:

- Mount the probe directly on the vessel wall without any space between the wall and probe.
- To prevent any influence on the measurement, fit a plastic half pipe with a diameter of at least 200 mm (8 in), or a similar protective unit, on the probe.
- For vessel diameters less than 300 mm (12 in):
On the opposite side of the vessel, fit a grounding plate that is conductively connected to the process connection and covers around half of the vessel's circumference.
- For vessel diameters of 300 mm (12 in) and higher:
At the process connection, fit a metal plate with a diameter of at least 200 mm (8 in) at a right angle to the probe (see above).

Adjustment when mounting on the vessel exterior

When the probe is mounted on the outside of the vessel wall, the speed of propagation of the signal is reduced. There are two ways to compensate for this.

Compensation via gas phase compensation factor

The effect of the dielectric wall is comparable to the effect of a dielectric gas phase and can therefore be corrected in the same way. The correction factor is calculated as the quotient of the actual probe length LN and the probe length measured when the vessel is empty.

i The device determines the position of the probe end echo in the differential curve. Therefore, the value of the measured probe length depends on the mapping curve. In order to obtain a more accurate value, it is advisable to determine the measured probe length manually using the envelope curve display in FieldCare.

1. Parameter Expert → Sensor → Gas phase compensation → GPC mode
↳ Select **Const. GPC factor** option.

2. Parameter Expert → Sensor → Gas phase compensation → Const. GPC factor
 - ↳ Quotient: Enter "(actual probe length)/(measured probe length)".

Compensation via the calibration parameters

If it is necessary to actually compensate for a gas phase, the gas phase compensation function is not available for the correction of external mounting. The calibration parameters (**Empty calibration** and **Full calibration**) must be adjusted in this case. Furthermore, a value that is greater than the actual probe length must be entered in the **Present probe length** parameter. In all three cases, the correction factor is the quotient of the probe length measured when the tank is empty and the actual probe LN.

 The device searches for the probe end echo in the differential curve. Therefore, the value of the measured probe length depends on the mapping curve. In order to obtain a more accurate value, it is advisable to determine the measured probe length manually using the envelope curve display in FieldCare.

1. Parameter Setup → Empty calibration
 - ↳ Increase the parameter value by the factor "(measured probe length)/(actual probe length)".
2. Parameter Setup → Full calibration
 - ↳ Increase the parameter value by the factor "(measured probe length)/(actual probe length)".
3. Parameter Setup → Advanced setup → Probe settings → Probe length correction → Confirm probe length
 - ↳ Select **Manual input** option.
4. Parameter Setup → Advanced setup → Probe settings → Probe length correction → Present probe length
 - ↳ Enter the measured probe length.

Vessel with thermal insulation

i If process temperatures are high, the device must be included in normal vessel insulation (1) in order to prevent the electronics heating up as a result of thermal radiation or convection. The insulation may not go beyond the points labeled "MAX" in the drawings.

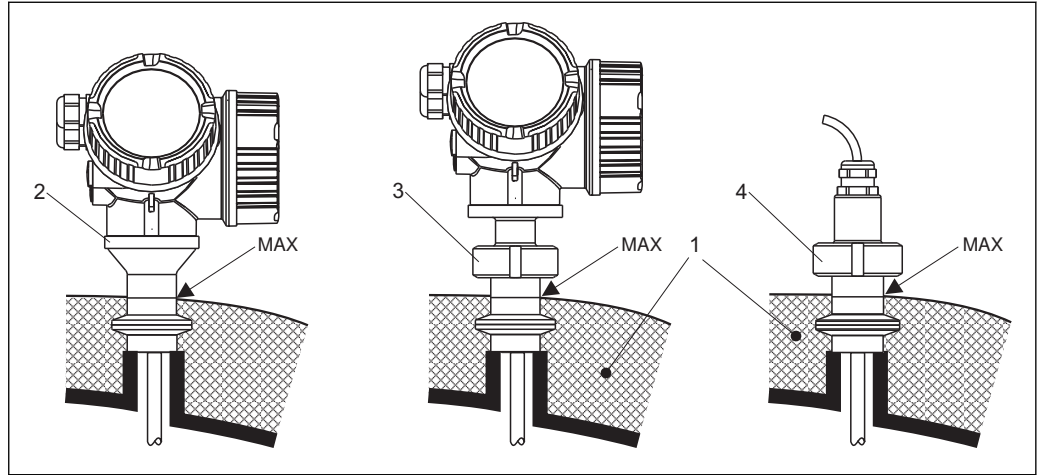

A0015809

5 Hygienic process connections

- 1 Vessel insulation
- 2 Compact device
- 3 Compact device, detachable
- 4 Sensor, remote

6.2 Mounting the measuring device

6.2.1 Tools list

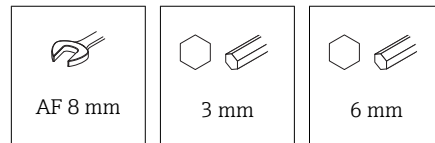

- To shorten rope probes: use a saw or bolt cutters
- To shorten rod or coax probes: use a saw
- For flanges and other process connections, use an appropriate mounting tool

6.2.2 Mounting the "Sensor, remote" version

i This section only applies for devices with the version "Probe design" = "Sensor, remote" (feature 600, version MB or MC).

The following is included in the delivery with the version "Probe design" = "Remote":

- The probe with process connection and connecting cable (3 m (9 ft) or 6 m (18 ft))
- The electronics housing
- The mounting bracket for mounting the electronics housing on a wall or post

i The connecting cable is connected to the probe upon delivery.

i The probe with the connection cable and the electronics are mutually compatible and bear a common serial number. Only components with the same serial number may be connected to one another.

⚠ CAUTION

Mechanical stress can damage the plug of the connection cable or cause it to become loose.

- ▶ Mount the probe and the electronics housing securely before connecting the connecting cable.
- ▶ Lay the connecting cable in such a way that it is not exposed to mechanical stress.
Minimum bending radius: 50 mm (2 in).
- ▶ Torque of the union nut at the plug on the electronics side: 6 Nm
- ▶ Torque of the union nut at the plug on the sensor side: 20 Nm

i In the event of strong vibrations, a locking compound, e.g. Loctite 243, can also be used on the plug on the electronics side.

Mounting the electronics housing

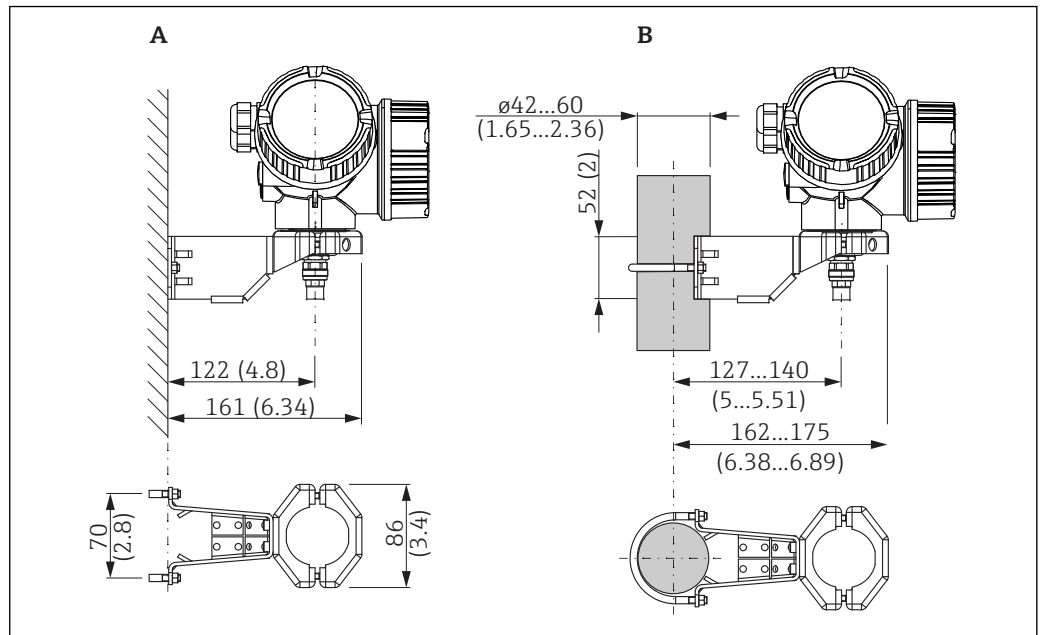

A0034793

6 Mounting the electronics housing with the mounting bracket. Unit of measurement mm (in)

- A Wall mounting
- B Post mounting

Connecting the connecting cable

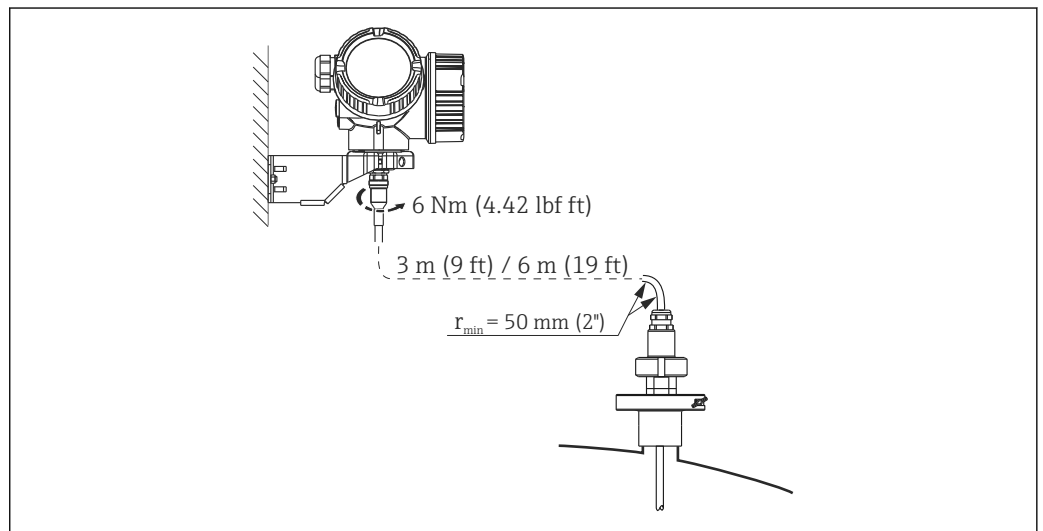
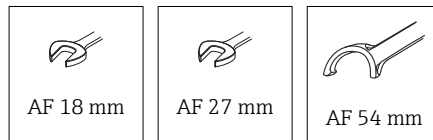

A0015103

6.2.3 Turning the transmitter housing

To provide easier access to the connection compartment or display module, the transmitter housing can be turned:

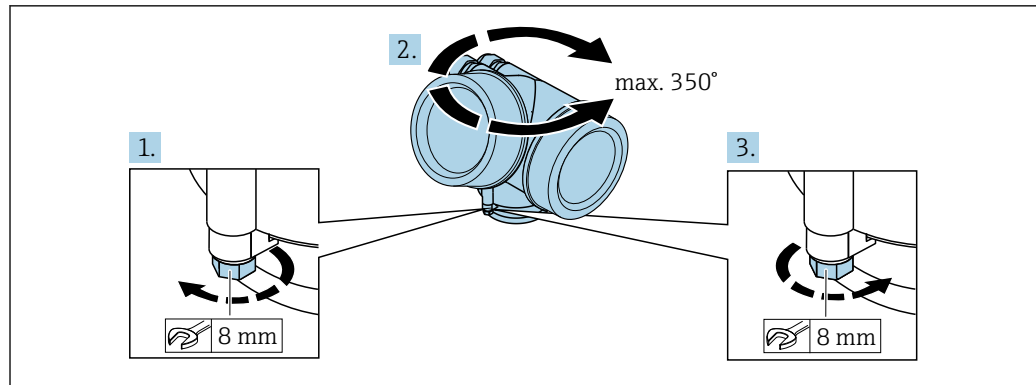

A0032242

1. Unscrew the securing screw using an open-ended wrench.
2. Rotate the housing in the desired direction.
3. Tighten the securing screw (1.5 Nm for plastic housing; 2.5 Nm for aluminum or stainless steel housing).

6.2.4 Turning the display

Opening the cover

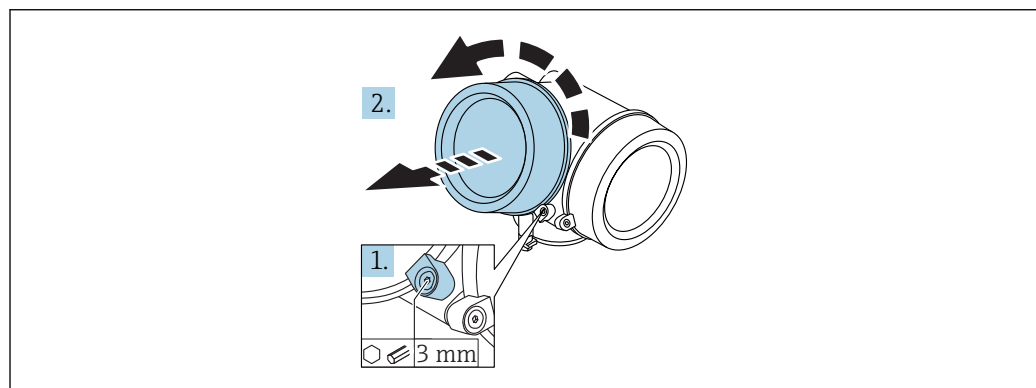

A0021430

1. Loosen the screw of the securing clamp of the electronics compartment cover using an Allen key (3 mm) and turn the clamp 90° counterclockwise.
2. Unscrew the cover and check the cover seal, replace it if necessary.

Turning the display module

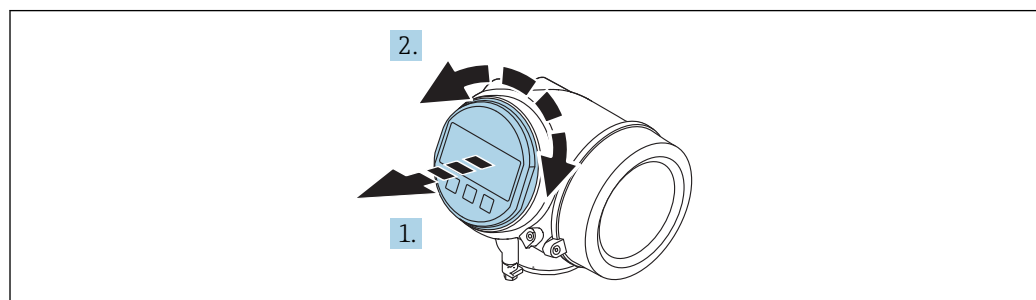

A0036401

1. Pull out the display module with a gentle rotational movement.
2. Turn the display module to the desired position: max. $8 \times 45^\circ$ in each direction.

3. Feed the coiled cable into the gap between the housing and main electronics module and plug the display module into the electronics compartment until it engages.

Closing the cover of the electronics compartment

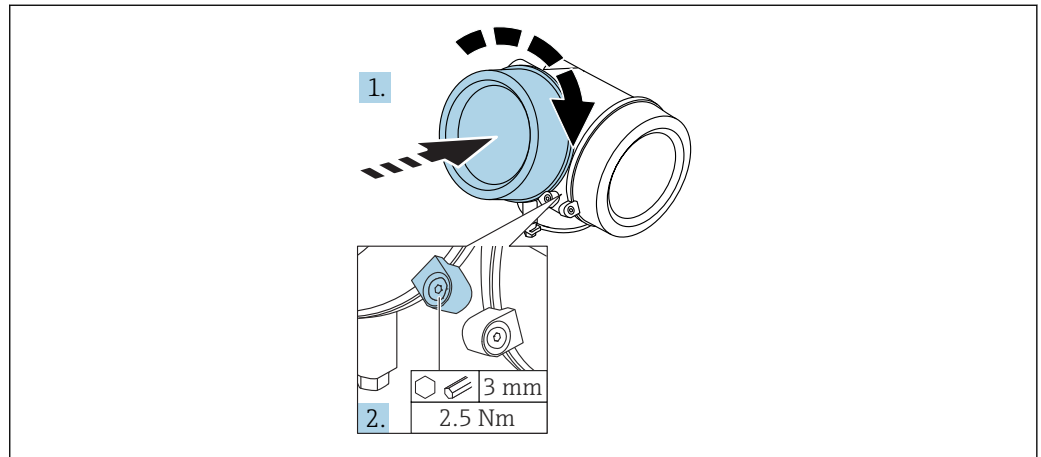

A0021451

1. Screw down the cover of the electronics compartment.
2. Turn the securing clamp 90 ° clockwise and tighten the screw of the securing clamp of the electronics compartment cover with 3 mm using the Allen key (2.5 Nm).

6.3 Post-installation check

- Is the device undamaged (visual inspection)?
- Does the device comply with the measuring point specifications?
 - Process temperature
 - Process pressure
 - Ambient temperature range
 - Measuring range
- Are the measuring point identification and labeling correct (visual inspection)?
- Is the device adequately protected against precipitation and direct sunlight?
- Is the device adequately protected against impact?
- Are all mounting and safety screws securely tightened?
- Is the device properly secured?

7 Electrical connection

7.1 Connection conditions

7.1.1 Terminal assignment

Terminal assignment 2-wire: 4-20 mA HART

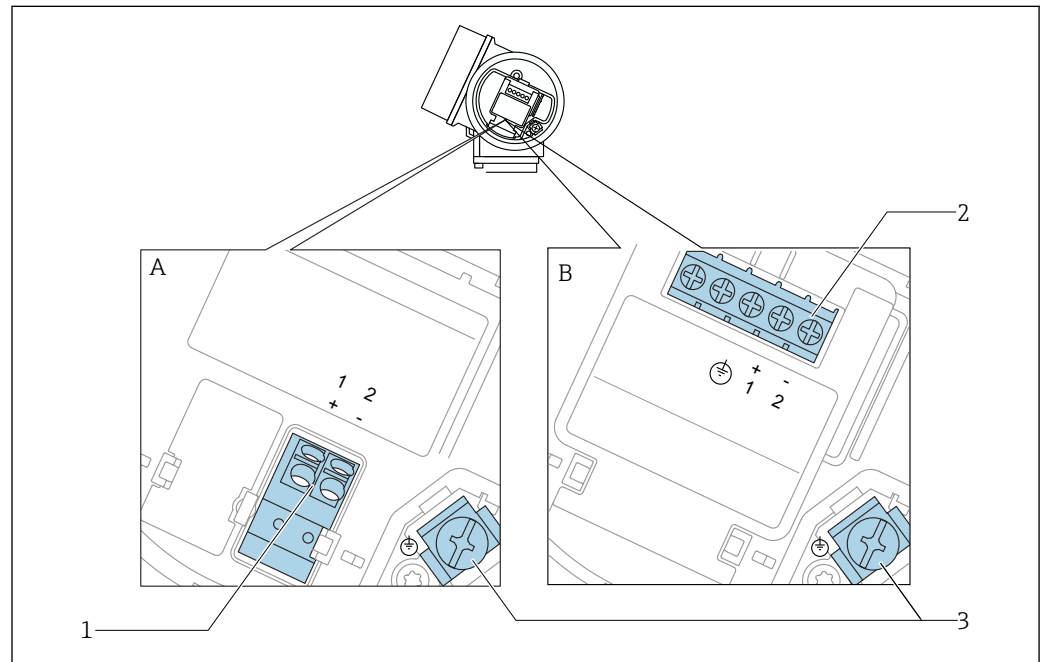

7 Terminal assignment 2-wire: 4-20 mA HART

A Without integrated overvoltage protection

B With integrated overvoltage protection

1 Connection 4-20 mA HART passive: terminals 1 and 2, without integrated overvoltage protection

2 Connection 4-20 mA HART passive: terminals 1 and 2, with integrated overvoltage protection

3 Terminal for cable screen

Block diagram 2-wire: 4-20 mA HART

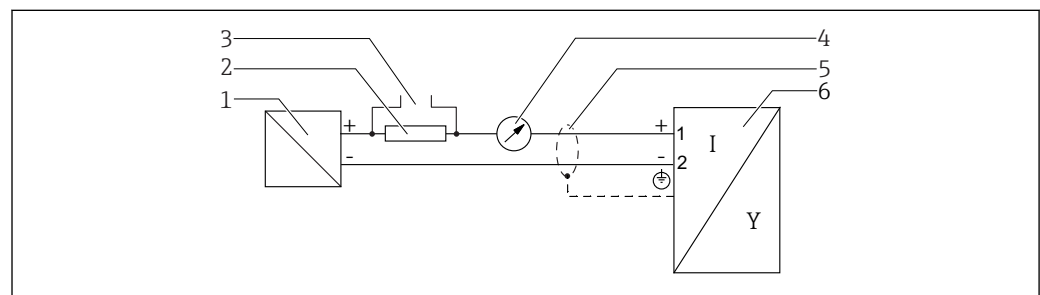

8 Block diagram 2-wire: 4-20 mA HART

1 Active barrier with power supply (e.g. RN221N); observe terminal voltage

2 HART communication resistor ($\geq 250 \Omega$); observe maximum load

3 Connection for Commubox FXA195 or FieldXpert SFX350/SFX370 (via VIATOR Bluetooth modem)

4 Analog display device; observe maximum load

5 Cable screen; observe cable specification

6 Measuring device

Terminal assignment 2-wire: 4-20 mA HART, switch output

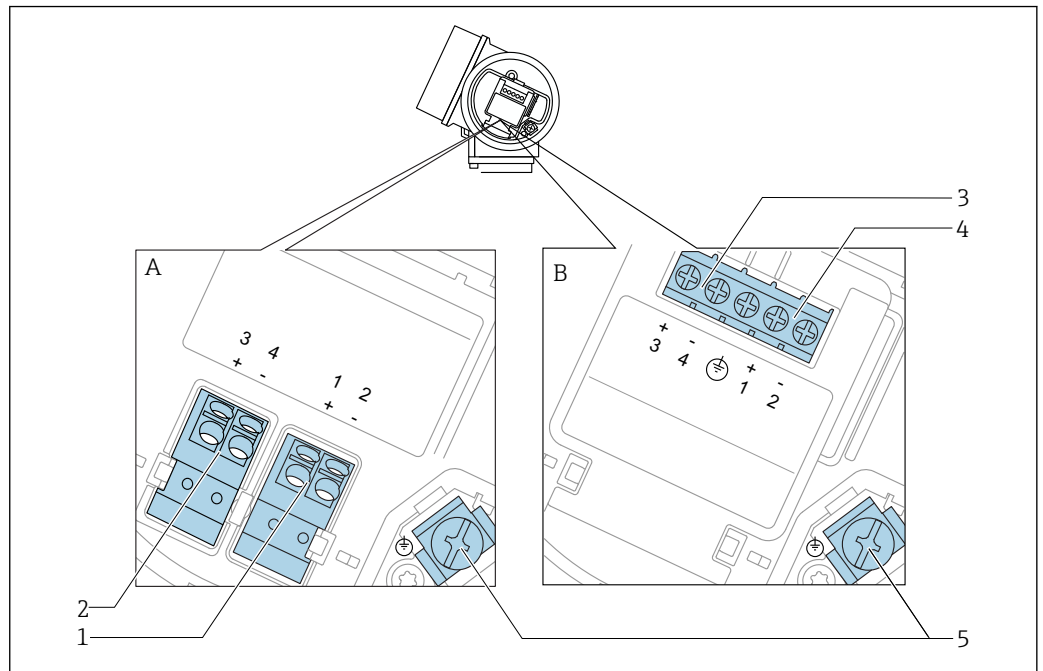

A0036500

9 Terminal assignment 2-wire: 4-20 mA HART, switch output

A Without integrated overvoltage protection

B With integrated overvoltage protection

1 Connection 4-20 mA HART passive: terminals 1 and 2, without integrated overvoltage protection

2 Connection switch output (Open Collector): terminals 3 and 4, without integrated overvoltage protection

3 Connection switch output (Open Collector): terminals 3 and 4, with integrated overvoltage protection

4 Connection 4-20 mA HART passive: terminals 1 and 2, with integrated overvoltage protection

5 Terminal for cable screen

Block diagram 2-wire: 4-20 mA HART, switch output

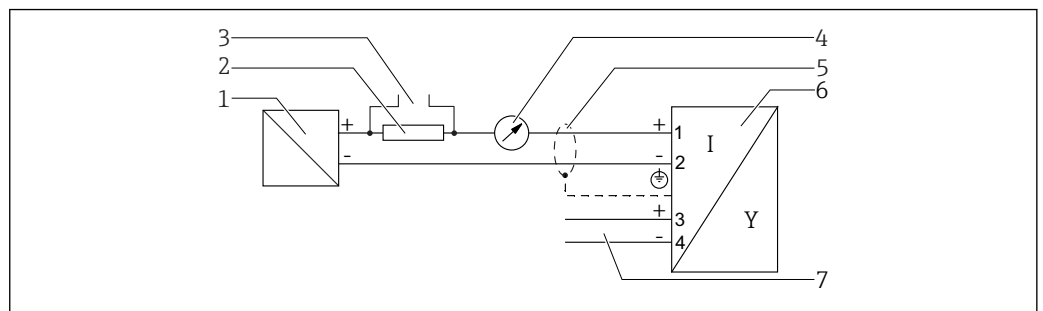

A0036501

10 Block diagram 2-wire: 4-20 mA HART, switch output

1 Active barrier with power supply (e.g. RN221N); observe terminal voltage

2 HART communication resistor ($\geq 250 \Omega$); observe maximum load

3 Connection for Commubox FXA195 or FieldXpert SFX350/SFX370 (via VIATOR Bluetooth modem)

4 Analog display device; observe maximum load

5 Cable screen; observe cable specification

6 Measuring device

7 Switch output (Open Collector)

Terminal assignment 2-wire: 4-20 mA HART, 4-20 mA

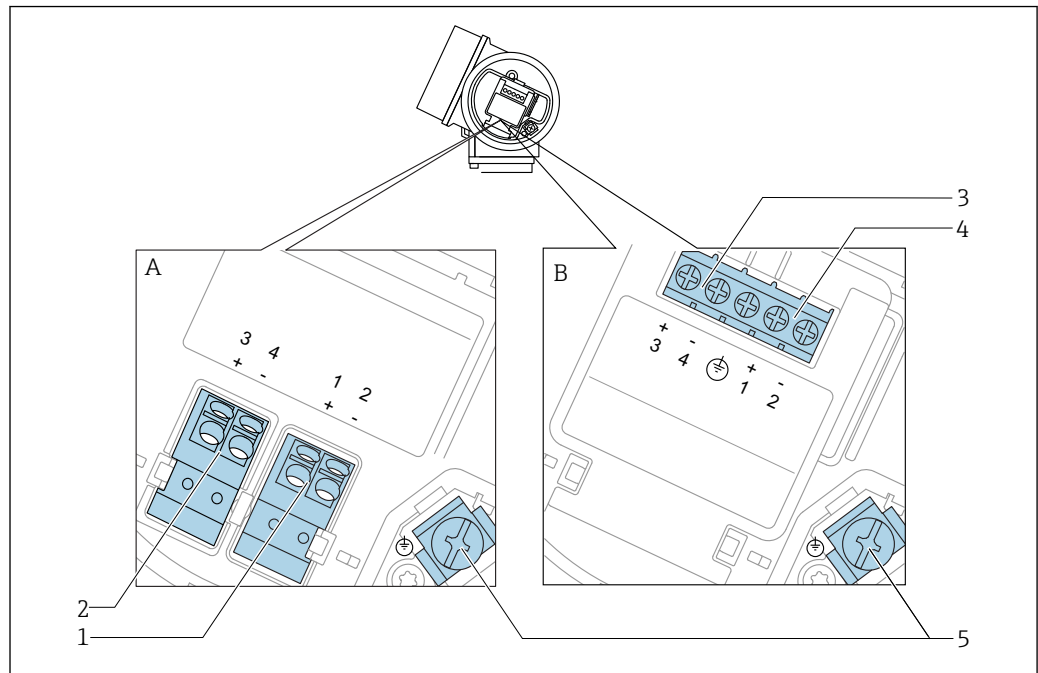

A0036500

11 Terminal assignment 2-wire: 4-20 mA HART, 4-20 mA

- A Without integrated overvoltage protection
- B With integrated overvoltage protection
- 1 Connection current output 1, 4-20 mA HART passive: terminals 1 and 2, without integrated overvoltage protection
- 2 Connection current output 2, 4-20 mA: terminals 3 and 4, without integrated overvoltage protection
- 3 Connection current output 2, 4-20 mA: terminals 3 and 4, with integrated overvoltage protection
- 4 Connection current output 1, 4-20 mA HART passive: terminals 1 and 2, with integrated overvoltage protection
- 5 Terminal for cable screen

Block diagram 2-wire: 4-20 mA HART, 4-20 mA

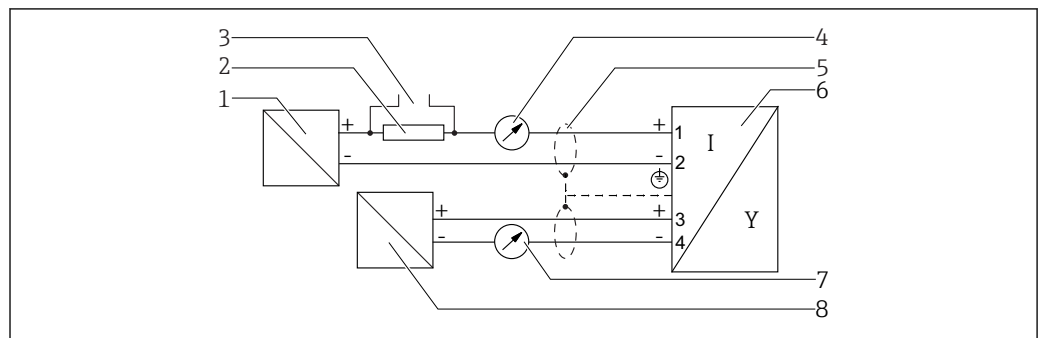

A0036502

12 Block diagram 2-wire: 4-20 mA HART, 4-20 mA

- 1 Active barrier with power supply (e.g. RN221N); observe terminal voltage
- 2 HART communication resistor ($\geq 250 \Omega$); observe maximum load
- 3 Connection for Commubox FXA195 or FieldXpert SFX350/SFX370 (via VIATOR Bluetooth modem)
- 4 Analog display device; observe maximum load
- 5 Cable screen; observe cable specification
- 6 Measuring device
- 7 Analog display device; observe maximum load
- 8 Active barrier with power supply (e.g. RN221N), current output 2; observe terminal voltage

Terminal assignment 4-wire: 4-20 mA HART (10.4 to 48 V_{DC})

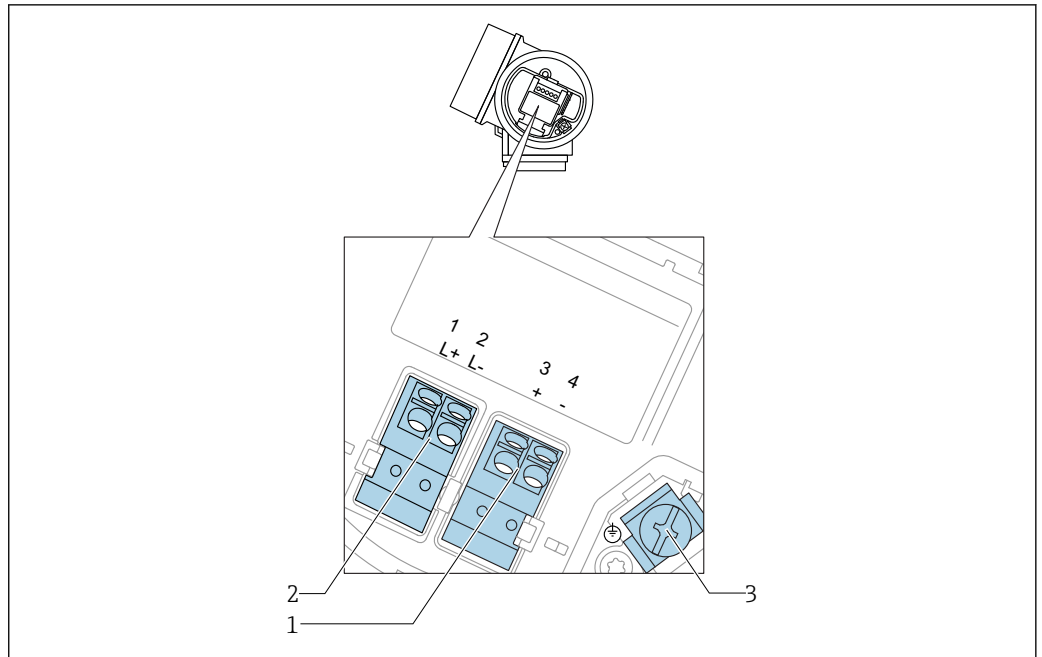

A0036516

13 Terminal assignment 4-wire: 4-20 mA HART (10.4 to 48 V_{DC})

- 1 Connection 4-20 mA HART (active): terminals 3 and 4
- 2 Connection supply voltage: terminals 1 and 2
- 3 Terminal for cable screen

Block diagram 4-wire: 4-20 mA HART (10.4 to 48 V_{DC})

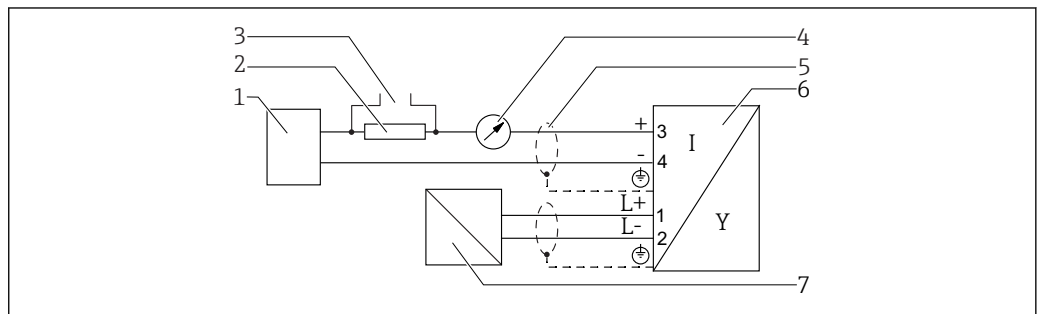

A0036526

14 Block diagram 4-wire: 4-20 mA HART (10.4 to 48 V_{DC})

- 1 Evaluation unit, e.g. PLC
- 2 HART communication resistor ($\geq 250 \Omega$); observe maximum load
- 3 Connection for Commubox FXA195 or FieldXpert SFX350/SFX370 (via VIATOR Bluetooth modem)
- 4 Analog display device; observe maximum load
- 5 Cable screen; observe cable specification
- 6 Measuring device
- 7 Supply voltage; observe terminal voltage, observe cable specification

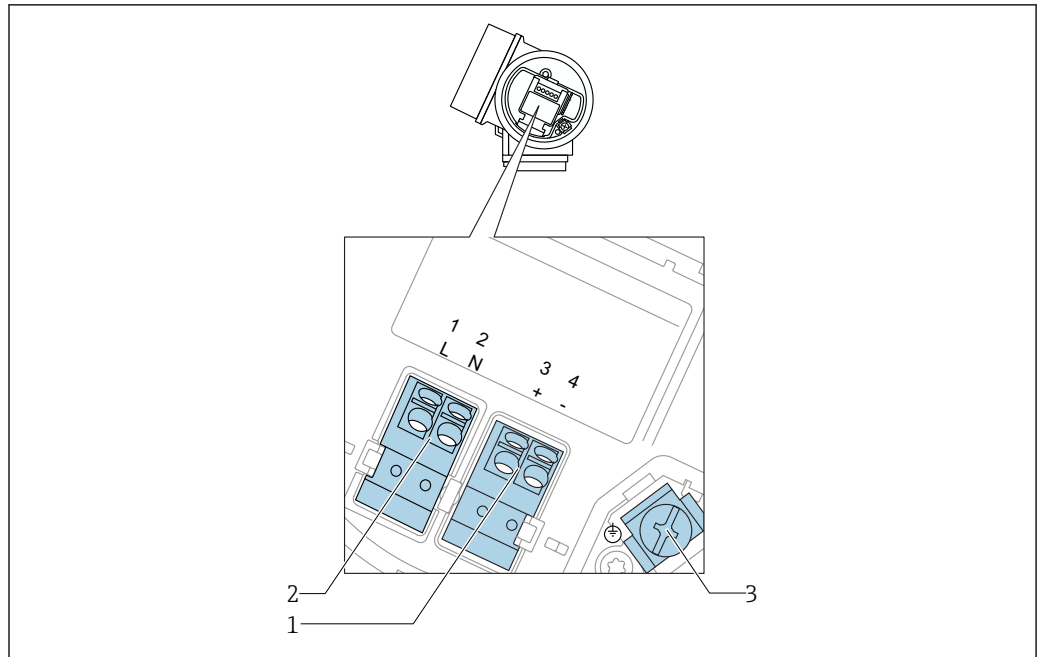
Terminal assignment 4-wire: 4-20 mA HART (90 to 253 V_{AC})

A0036519

15 Terminal assignment 4-wire: 4-20 mA HART (90 to 253 V_{AC})

- 1 Connection 4-20 mA HART (active): terminals 3 and 4
- 2 Connection supply voltage: terminals 1 and 2
- 3 Terminal for cable screen

CAUTION**To ensure electrical safety:**

- ▶ Do not disconnect the protective connection.
- ▶ Disconnect the supply voltage before disconnecting the protective earth.

- i** Connect protective earth to the internal ground terminal (3) before connecting the supply voltage. If necessary, connect the potential matching line to the external ground terminal.
- i** In order to ensure electromagnetic compatibility (EMC): Do **not** only ground the device via the protective earth conductor of the supply cable. Instead, the functional grounding must also be connected to the process connection (flange or threaded connection) or to the external ground terminal.
- i** An easily accessible power switch must be installed in the proximity of the device. The power switch must be marked as a disconnector for the device (IEC/EN61010).

Block diagram 4-wire: 4-20 mA HART (90 to 253 V_{AC})

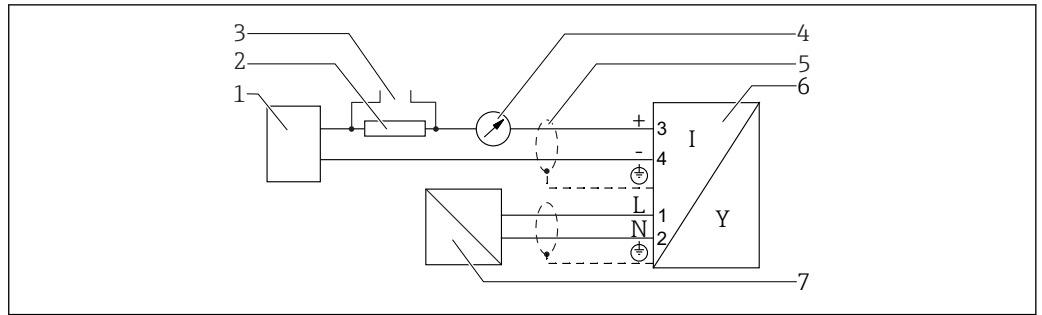

A0036527

16 Block diagram 4-wire: 4-20 mA HART (90 to 253 V_{AC})

- 1 Evaluation unit, e.g. PLC
- 2 HART communication resistor ($\geq 250 \Omega$); observe maximum load
- 3 Connection for Commubox FXA195 or FieldXpert SFX350/SFX370 (via VIATOR Bluetooth modem)
- 4 Analog display device; observe maximum load
- 5 Cable scree; observe cable specification
- 6 Measuring device
- 7 Supply voltage; observe terminal voltage, observe cable specification

Connection examples for the switch output

i For HART devices, the switch output is available as an option.

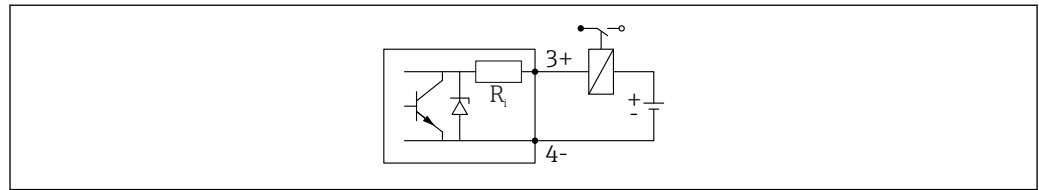

A0015909

17 Connection of a relay

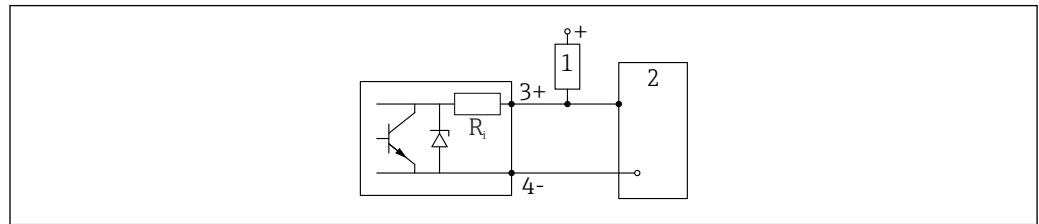

A0015910

18 Connection to a digital input

- 1 Pull-up resistor
- 2 Digital input

i For optimum interference immunity we recommend to connect an external resistor (internal resistance of the relay or pull-up resistor) of $< 1\,000\ \Omega$.

7.1.2 Cable specification

■ Devices without integrated overvoltage protection

Pluggable spring-force terminals for wire cross-sections 0.5 to $2.5\ \text{mm}^2$ (20 to 14 AWG)

■ Devices with integrated overvoltage protection

Screw terminals for wire cross-sections 0.2 to $2.5\ \text{mm}^2$ (24 to 14 AWG)

- For ambient temperature $T_U \geq 60\ ^\circ\text{C}$ ($140\ ^\circ\text{F}$): use cable for temperature $T_U + 20\ \text{K}$.

HART

- A normal device cable suffices if only the analog signal is used.
- A shielded cable is recommended if using the HART protocol. Observe grounding concept of the plant.
- For 4-wire devices: Standard device cable is sufficient for the power line.

7.1.3 Device plugs

 In device versions with a device plug (M12 or 7/8"), it is not necessary to open the housing in order to connect the signal cable.

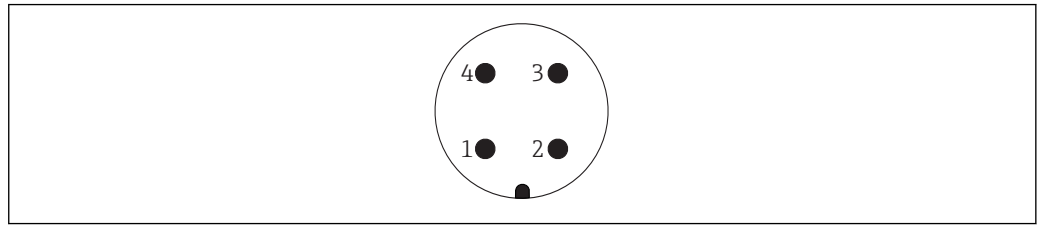

A0011175

 19 Pin assignment of M12 plug

- 1 Signal +
- 2 Not assigned
- 3 Signal -
- 4 Ground

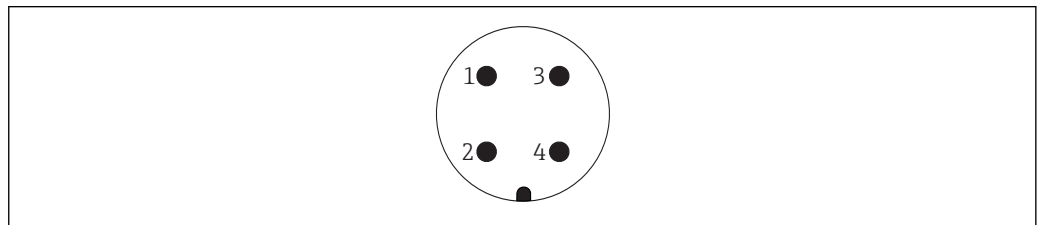

A0011176

 20 Pin assignment of 7/8" plug

- 1 Signal -
- 2 Signal +
- 3 Not assigned
- 4 Shielding

7.1.4 Power supply

2-wire, 4-20mA HART, passive

2-wire; 4-20mA HART¹⁾

"Approval" ²⁾	Terminal voltage U at the device	Maximum load R, depending on the supply voltage U ₀ at the supply unit
<ul style="list-style-type: none"> ■ Non-Ex ■ Ex nA ■ Ex ic ■ CSA GP 	11.5 to 35 V ^{3) 4)}	<p style="text-align: right; font-size: small;">A0035511</p>
Ex ia / IS	11.5 to 30 V ⁴⁾	
<ul style="list-style-type: none"> ■ Ex d / XP ■ Ex ic[ia] ■ Ex tD / DIP 	13.5 to 30 V ^{4) 5)}	<p style="text-align: right; font-size: small;">A0034969</p>

1) Feature 020 of the product structure: option A

2) Feature 010 of the product structure

3) For ambient temperatures $T_a \leq -30\text{ °C}$ (-22 °F) a minimum voltage of 14 V is required for the startup of the device at the minimum error current (3,6 mA). For ambient temperatures $T_a \geq 60\text{ °C}$ (140 °F) a minimum voltage of 12V is required for the sartup of the device at the minimum error current (3,6 mA). The startup current can be parametrized. If the device is operated with a fixed current $I \geq 4,5\text{ mA}$ (HART multidrop mode), a voltage of $U \geq 11,5\text{ V}$ is sufficient throughout the entire range of ambient temperatures.

4) If the Bluetooth modem is used, the minimum supply voltage increases by 2 V.

5) For ambient temperatures $T_a \leq -20\text{ °C}$ (-4 °F) a minimum voltage of 16 V is required for the startup of the device at the minimum error current (3.6 mA).

2-wire; 4-20 mA HART, switch output ¹⁾

"Approval" ²⁾	Terminal voltage U at the device	Maximum load R, depending on the supply voltage U ₀ at the supply unit
<ul style="list-style-type: none"> ▪ Non-Ex ▪ Ex nA ▪ Ex nA[ia] ▪ Ex ic ▪ Ex ic[ia] ▪ Ex d[ia] / XP ▪ Ex ta / DIP ▪ CSA GP 	13.5 to 35 V ^{3) 4)}	<p style="text-align: right; font-size: small;">A0034971</p>
<ul style="list-style-type: none"> ▪ Ex ia / IS ▪ Ex ia + Ex d[ia] / IS + XP 	13.5 to 30 V ^{3) 4)}	

- 1) Feature 020 of the product structure: option B
- 2) Feature 010 of the product structure
- 3) For ambient temperatures $T_a \leq -30\text{ °C}$ (-22 °F) a minimum voltage of 16 V is required for the startup of the device at the minimum error current (3.6 mA).
- 4) If the Bluetooth modem is used, the minimum supply voltage increases by 2 V.

2-wire; 4-20mA HART, 4-20mA ¹⁾

"Approval" ²⁾	Terminal voltage U at the device	Maximum load R, depending on the supply voltage U ₀ at the supply unit
any	Channel 1: 13.5 to 30 V ^{3) 4) 5)}	<p style="text-align: right; font-size: small;">A0034969</p>
	Channel 2: 12 to 30 V	

- 1) Feature 020 of the product structure: option C
- 2) Feature 010 of the product structure
- 3) For ambient temperatures $T_a \leq -30\text{ °C}$ (-22 °F) a minimum voltage of 16 V is required for the startup of the device at the minimum error current (3.6 mA).
- 4) For ambient temperatures $T_a \leq -40\text{ °C}$ (-40 °F), the maximum terminal voltage must be restricted to $U \leq 28\text{ V}$.
- 5) If the Bluetooth modem is used, the minimum supply voltage increases by 2 V.

Polarity reversal protection	Yes
Admissible residual ripple at f = 0 to 100 Hz	$U_{SS} < 1 \text{ V}$
Admissible residual ripple at f = 100 to 10000 Hz	$U_{SS} < 10 \text{ mV}$

4-wire, 4-20mA HART, active

"Power supply; Output" ¹⁾	Terminal voltage	Maximum load R _{max}
K: 4-wire 90-253VAC; 4-20mA HART	90 to 253 V _{AC} (50 to 60 Hz), overvoltage category II	500 Ω
L: 4-wire 10,4-48VDC; 4-20mA HART	10.4 to 48 V _{DC}	

1) Feature 020 of the product structure

7.1.5 Overvoltage protection

If the measuring device is used for level measurement in flammable liquids which requires the use of overvoltage protection according to DIN EN 60079-14, standard for test procedures 60060-1 (10 kA, pulse 8/20 μs), an overvoltage protection module has to be installed.

Integrated overvoltage protection module

An integrated overvoltage protection module is available for 2-wire HART as well as PROFIBUS PA and FOUNDATION Fieldbus devices.

Product structure: Feature 610 "Accessory mounted", option NA "Overvoltage protection".

Technical data	
Resistance per channel	2 × 0.5 Ω max.
Threshold DC voltage	400 to 700 V
Threshold impulse voltage	< 800 V
Capacitance at 1 MHz	< 1.5 pF
Nominal arrest impulse voltage (8/20 μs)	10 kA

External overvoltage protection module

HAW562 or HAW569 from Endress+Hauser are suited as external overvoltage protection.

-  For detailed information please refer to the following documents:
- HAW562: TI01012K
 - HAW569: TI01013K

7.2 Connecting the measuring device



Risk of explosion!

- ▶ Observe applicable national standards.
- ▶ Comply with the specifications in the Safety Instructions (XA).
- ▶ Use specified cable glands only.
- ▶ Check to ensure that the power supply matches the information on the nameplate.
- ▶ Switch off the power supply before connecting the device.
- ▶ Connect the potential matching line to the outer ground terminal before applying the power supply.

Required tools/accessories:

- For devices with a cover lock: Allen key AF3
- Wire stripper
- When using stranded cables: One ferrule for every wire to be connected.

7.2.1 Opening connection compartment cover

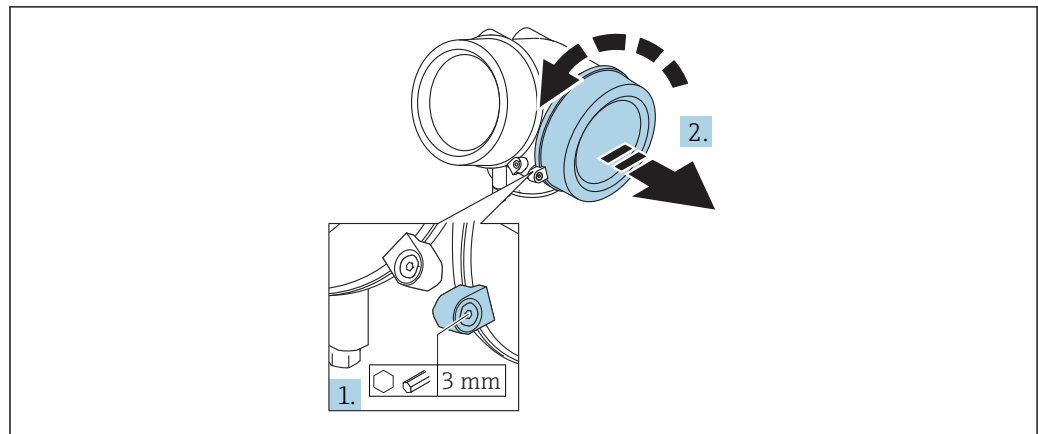

A0021490

1. Loosen the screw of the securing clamp of the connection compartment cover using an Allen key (3 mm) and turn the clamp 90° clockwise.
2. Afterwards unscrew connection compartment cover and check lid gasket, replace if necessary.

7.2.2 Connecting

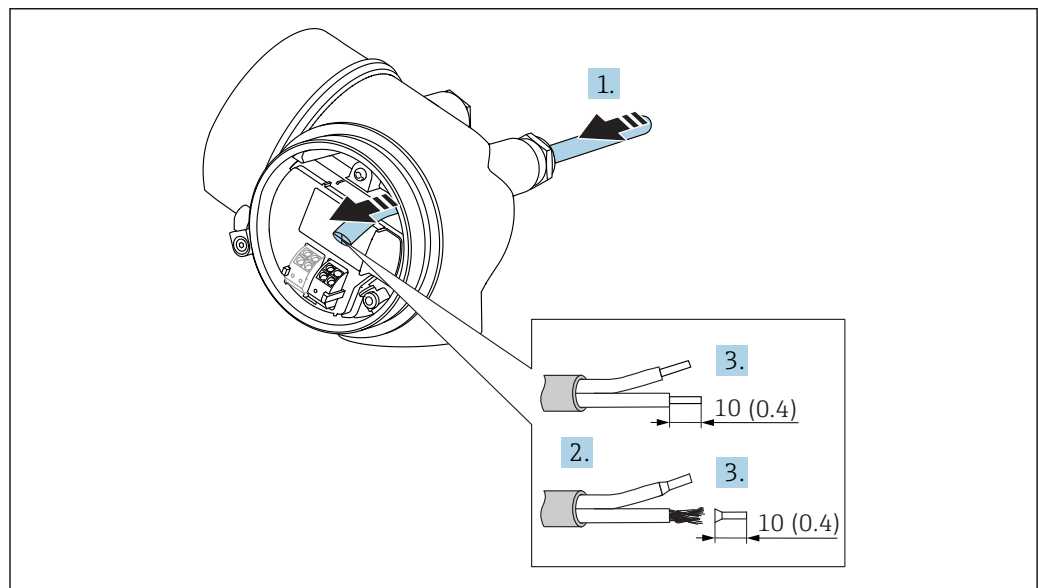

A0036418

21 Dimensions: mm (in)

1. Push the cable through the cable entry . To ensure tight sealing, do not remove the sealing ring from the cable entry.
2. Remove the cable sheath.
3. Strip the cable ends over a length of 10 mm (0.4 in). In the case of stranded cables, also fit ferrules.
4. Firmly tighten the cable glands.

5. Connect the cable in accordance with the terminal assignment.

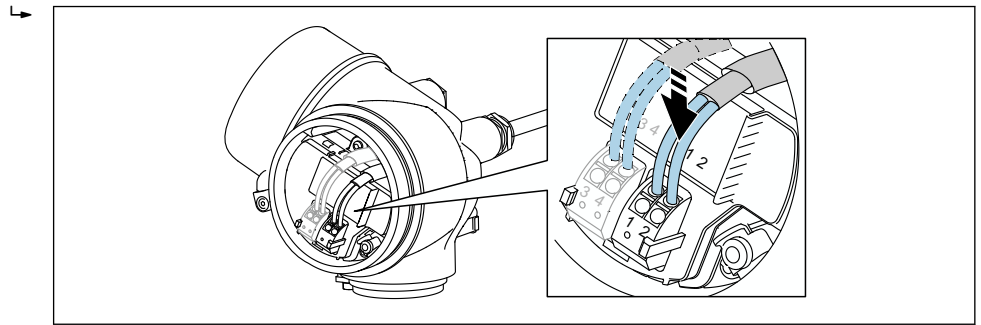

A0034682

6. If using shielded cables: Connect the cable shield to the ground terminal.

7.2.3 Plug-in spring-force terminals

In the case of devices without integrated overvoltage protection, electrical connection is via plug-in spring-force terminals. Rigid conductors or flexible conductors with ferrules can be inserted directly into the terminal without using the lever, and create a contact automatically.

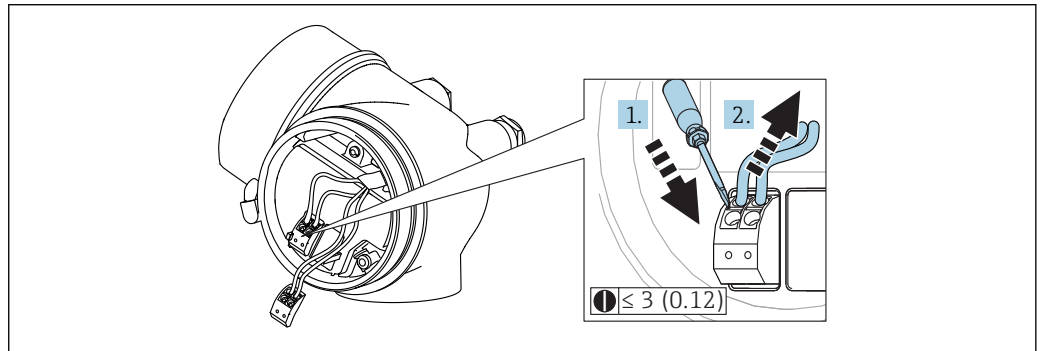

A0013661

☞ 22 Dimensions: mm (in)

To remove cables from the terminal:

1. Using a flat-blade screwdriver ≤ 3 mm, press down on the slot between the two terminal holes
2. while simultaneously pulling the cable end out of the terminal.

7.2.4 Closing connection compartment cover

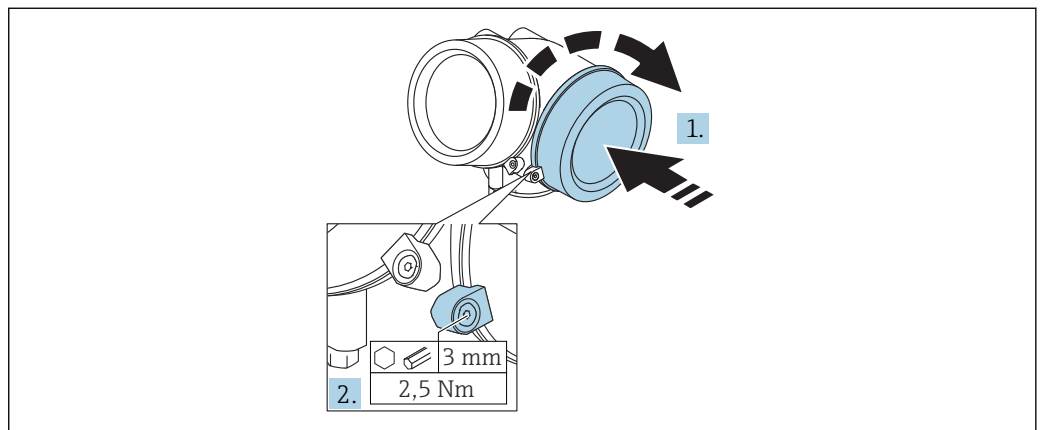

A0021491

1. Screw back firmly connection compartment cover.
2. Turning securing clamp 90 ° counterclockwise and tighten the clamp with 2.5 Nm (1.84 lbf ft) again using the Allen key (3 mm).

7.3 Post-connection check

- Is the device or cable undamaged (visual inspection)?
- Do the cables used comply with the requirements?
- Do the mounted cables have adequate strain relief?
- Are all the cable glands installed, firmly tightened and leak-tight?
- Does the supply voltage match the specifications on the nameplate?
- Is the terminal assignment correct?
- If necessary, has a protective ground connection been established?
- If supply voltage is present, is the device ready for operation and do values appear on the display module?
- Are all the housing covers installed and tightened?
- Is the securing clamp firmly tightened?

8 Operation options

8.1 Overview

8.1.1 Local operation

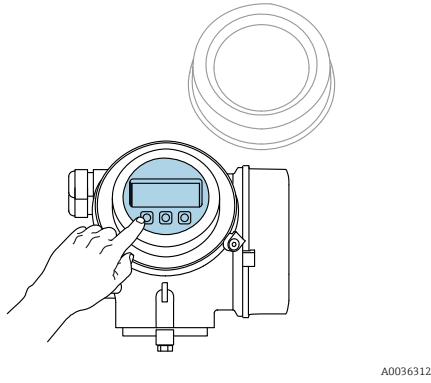
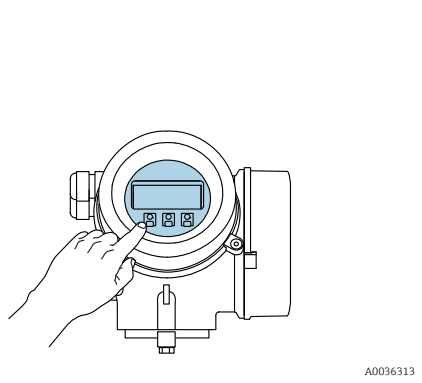
Operation with	Pushbuttons	Touch Control
Order code for "Display; Operation"	Option C "SD02"	Option E "SD03"
		
Display elements	4-line display	4-line display white background lighting; switches to red in event of device error
	Format for displaying measured variables and status variables can be individually configured	
	Permitted ambient temperature for the display: -20 to +70 °C (-4 to +158 °F) The readability of the display may be impaired at temperatures outside the temperature range.	
Operating elements	local operation with 3 push buttons (⊕, ⊖, ⊞)	external operation via touch control; 3 optical keys: ⊕, ⊖, ⊞
	Operating elements also accessible in various hazardous areas	
Additional functionality	Data backup function The device configuration can be saved in the display module.	
	Data comparison function The device configuration saved in the display module can be compared to the current device configuration.	
	Data transfer function The transmitter configuration can be transmitted to another device using the display module.	

8.1.2 Operation with remote display and operating module FHX50

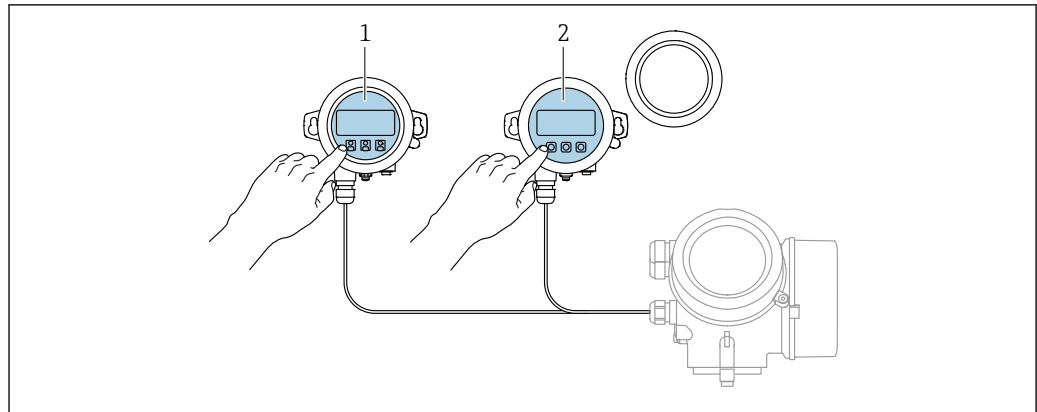

A0036314

23 FHX50 operating options

- 1 Display and operating module SD03, optical keys; can be operated through the glass of the cover
- 2 Display and operating module SD02, push buttons; cover must be removed

8.1.3 Operation via Bluetooth® wireless technology

Requirements

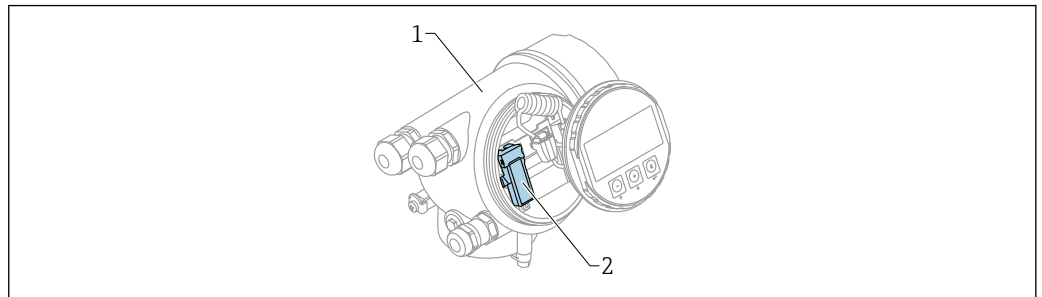

A0036790

24 Device with Bluetooth module

- 1 Electronics housing of the device
- 2 Bluetooth module

This operation option is only available for devices with Bluetooth module. There are the following options:

- The device has been ordered with a Bluetooth module:
Feature 610 "Accessory Mounted", option NF "Bluetooth"
- The Bluetooth module has been ordered as an accessory (ordering number: 71377355) and has been mounted. See Special Documentation SD02252F.

Operation via SmartBlue (app)

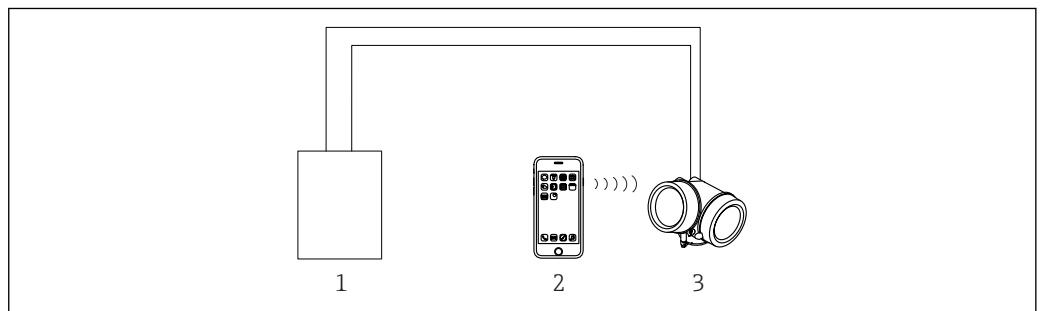

A0034939

25 Operation via SmartBlue (app)

- 1 Transmitter power supply unit
- 2 Smartphone / tablet with SmartBlue (app)
- 3 Transmitter with Bluetooth module

8.1.4 Remote operation

Via HART protocol

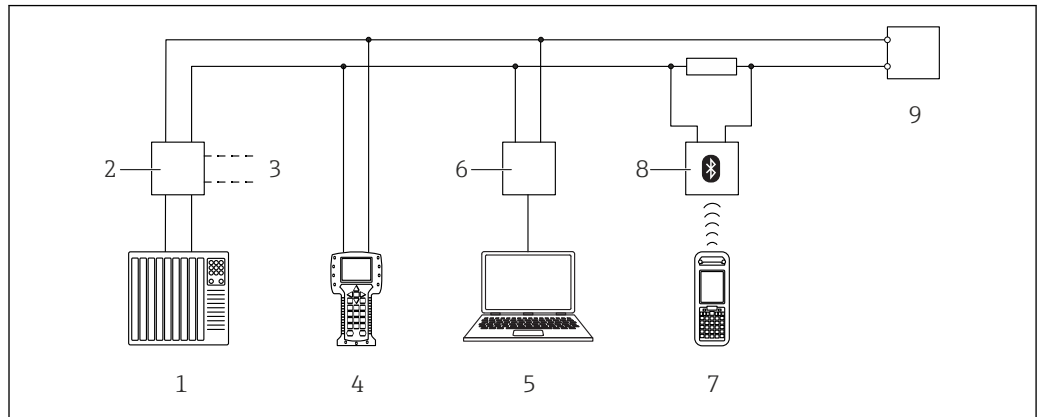

A0036169

▣ 26 Options for remote operation via HART protocol

- 1 PLC (Programmable Logic Controller)
- 2 Transmitter power supply unit, e.g. RN221N (with communication resistor)
- 3 Connection for Commubox FXA191, FXA195 and Field Communicator 375, 475
- 4 Field Communicator 475
- 5 Computer with operating tool (e.g. DeviceCare/FieldCare, AMS Device Manager, SIMATIC PDM)
- 6 Commubox FXA191 (RS232) or FXA195 (USB)
- 7 Field Xpert SFX350/SFX370
- 8 VIATOR Bluetooth modem with connecting cable
- 9 Transmitter

DeviceCare/FieldCare via service interface (CDI)

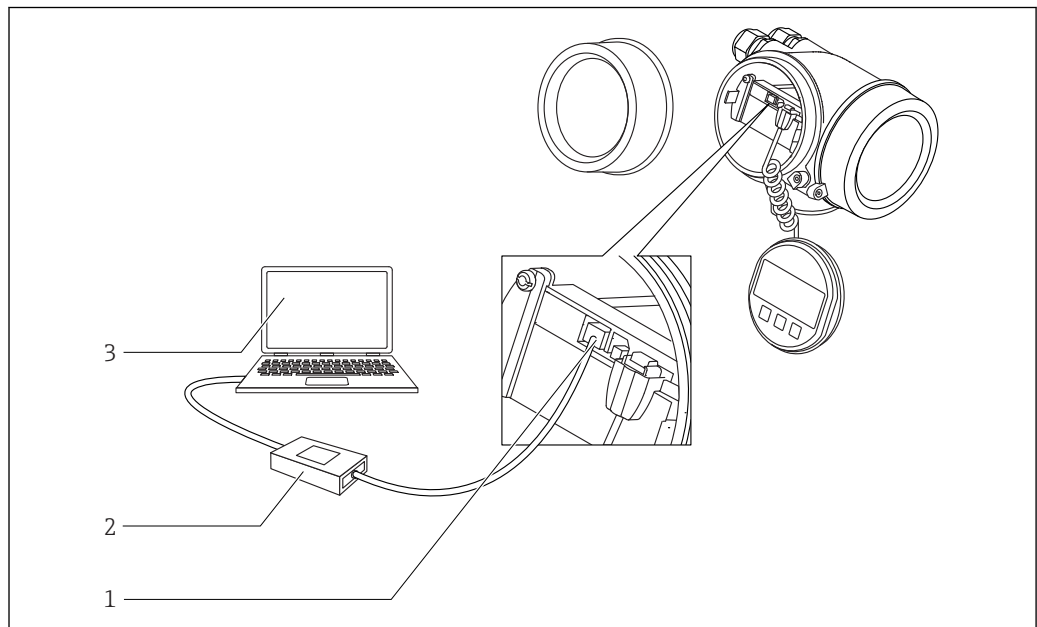

A0032466

▣ 27 DeviceCare/FieldCare via service interface (CDI)

- 1 Service interface (CDI) of the instrument (= Endress+Hauser Common Data Interface)
- 2 Commubox FXA291
- 3 Computer with DeviceCare/FieldCare operating tool

8.2 Structure and function of the operating menu

8.2.1 Structure of the operating menu

Menu	Submenu / parameter	Meaning
	Language ¹⁾	Defines the operating language of the local display.
Commissioning ²⁾		Launches the interactive wizard for guided commissioning. Additional settings generally do not need to be made in the other menus when the wizard is finished.
Setup	Parameter 1 ... Parameter N	When all these parameters have been assigned appropriate values, the measured should be completely configured in a standard application.
	Advanced setup	Contains further submenus and parameters: <ul style="list-style-type: none"> ▪ to adapt the device to special measuring conditions. ▪ to process the measured value (scaling, linearization). ▪ to configure the signal output.
Diagnostics	Diagnostic list	Contains up to 5 currently active error messages.
	Event logbook ³⁾	Contains the last 20 messages (which are no longer active).
	Device information	Contains information needed to identify the device.
	Measured values	Contains all current measured values.
	Data logging	Contains the history of the individual measuring values.
	Simulation	Used to simulate measured values or output values.
	Device check	Contains all parameters needed to check the measurement capability of the device.
Expert ⁵⁾ Contains all parameters of the device (including those which are already contained in one of the above submenus). This menu is organized according to the function blocks of the device. The parameters of the Expert menu are described in: GP0100F (HART)	Heartbeat ⁴⁾	Contains all the wizards for the Heartbeat Verification and Heartbeat Monitoring application packages.
	System	Contains all general device parameters which do not affect the measurement or the communication interface.
	Sensor	Contains all parameters needed to configure the measurement.
	Output	<ul style="list-style-type: none"> ▪ Contains all parameters needed to configure the current output. ▪ Contains all parameters needed to configure the switch output (PFS).

Menu	Submenu / parameter	Meaning
	Communication	Contains all parameters needed to configure the digital communication interface.
	Diagnostics	Contains all parameters needed to detect and analyze operational errors.

- 1) If operating via operating tools (e.g. FieldCare), the "Language" parameter is located under "Setup → Advanced setup → Display"
- 2) Only if operating via an FDT/DTM system
- 3) only available with local operation
- 4) only available if operating via DeviceCare or FieldCare
- 5) On entering the "Expert" menu, an access code is always requested. If a customer specific access code has not been defined, "0000" has to be entered.

8.2.2 User roles and related access authorization

The two user roles **Operator** and **Maintenance** have different write access to the parameters if a device-specific access code has been defined. This protects the device configuration via the local display from unauthorized access →  53.

Access authorization to parameters

User role	Read access		Write access	
	Without access code (from the factory)	With access code	Without access code (from the factory)	With access code
Operator	✓	✓	✓	--
Maintenance	✓	✓	✓	✓

If an incorrect access code is entered, the user obtains the access rights of the **Operator** role.

 The user role with which the user is currently logged on is indicated by the **Access status display** parameter (for display operation) or **Access status tooling** parameter (for tool operation).

8.2.3 Data access - Security

Write protection via access code

Using the device-specific access code, the parameters for the measuring device configuration are write-protected and their values can no longer be changed via local operation.

Define access code via local display

1. Navigate to: Setup → Advanced setup → Administration → Define access code → Define access code
2. Define a max. 4-digit numeric code as an access code.
3. Repeat the same code in **Confirm access code** parameter.
 - ↳ The -symbol appears in front of all write-protected parameters.



Define access code via operating tool (e.g. FieldCare)

1. Navigate to: Setup → Advanced setup → Administration → Define access code
2. Define a max. 4-digit numeric code as an access code.
 - ↳ Write protection is active.



Parameters that can always be changed

The write protection does not include certain parameters that do not affect the measurement. Despite the defined access code, they can always be modified, even if the other parameters are locked.



The device automatically locks the write-protected parameters again if a key is not pressed for 10 minutes in the navigation and editing view. The device locks the write-protected parameters automatically after 60 s if the user skips back to the measured value display mode from the navigation and editing view.

-  If write access is activated via access code, it can be also be deactivated only via the access code →  54.
- In the "Description of Device Parameters" documents, each write-protected parameter is identified with the -symbol.

Disabling write protection via access code

If the -symbol appears on the local display in front of a parameter, the parameter is write-protected by a device-specific access code and its value cannot be changed at the moment using the local display →  53.

The locking of the write access via local operation can be disabled by entering the device-specific access code.

1. After you press , the input prompt for the access code appears.
2. Enter the access code.
 - ↳ The -symbol in front of the parameters disappears; all previously write-protected parameters are now re-enabled.

Deactivation of the write protection via access code

Via local display

1. Navigate to: Setup → Advanced setup → Administration → Define access code → Define access code
2. Enter **0000**.
3. Repeat **0000** in **Confirm access code** parameter.
 - ↳ The write protection is deactivated. Parameters can be changed without entering an access code.

Via an operating tool (e.g. FieldCare)

1. Navigate to: Setup → Advanced setup → Administration → Define access code
2. Enter **0000**.
 - ↳ The write protection is deactivated. Parameters can be changed without entering an access code.

Write protection via write protection switch

Unlike parameter write protection via a user-specific access code, this allows write access to the entire operating menu - except for the **"Contrast display" parameter** - to be locked.

The parameter values are now read only and cannot be edited any more (exception **"Contrast display" parameter**):

- Via local display
- Via service interface (CDI)
- Via HART protocol

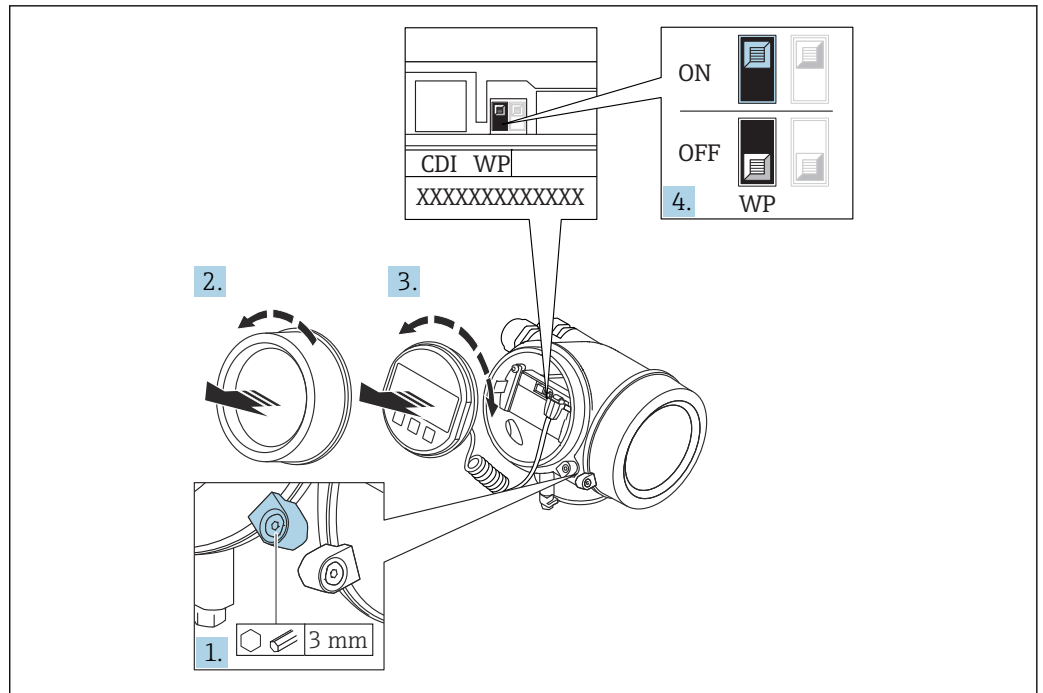

A0026157

1. Loosen the securing clamp.
2. Unscrew the electronics compartment cover.
3. Pull out the display module with a gentle rotational movement. To make it easier to access the lock switch, attach the display module to the edge of the electronics compartment.

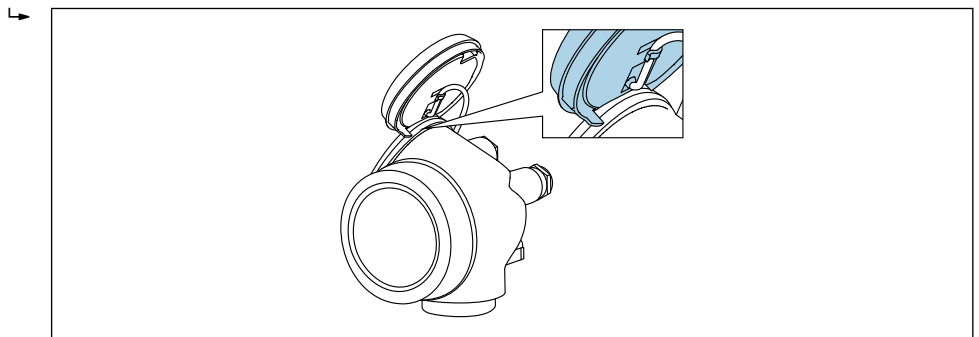

A0036086

4. Setting the write protection switch (WP) on the main electronics module to the **ON** position enables hardware write protection. Setting the write protection switch (WP) on the main electronics module to the **OFF** position (factory setting) disables hardware write protection.
 - ↳ If the hardware write protection is enabled: The **Hardware locked** option is displayed in the **Locking status** parameter. In addition, on the local display the -symbol appears in front of the parameters in the header of the operational display and in the navigation view.

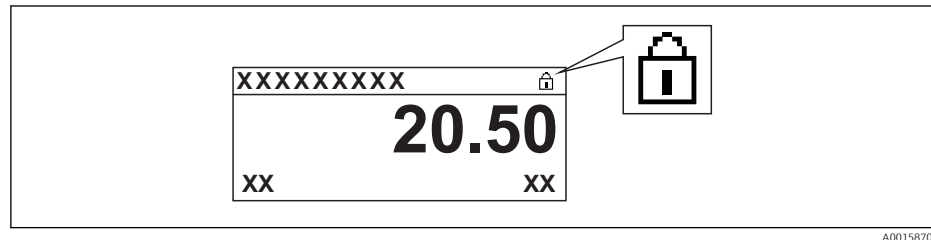

If the hardware write protection is disabled: No option is displayed in the **Locking status** parameter. On the local display, the -symbol disappears from in front of the parameters in the header of the operational display and in the navigation view.

5. Feed the cable into the gap between the housing and main electronics module and plug the display module into the electronics compartment in the desired direction until it engages.
6. Reverse the removal procedure to reassemble the transmitter.

Enabling and disabling the keypad lock

The keypad lock makes it possible to block access to the entire operating menu via local operation. As a result, it is no longer possible to navigate through the operating menu or change the values of individual parameters. Users can only read the measured values on the operational display.

The keypad lock is switched on and off via the context menu.

Switching on the keypad lock

For the SD03 display only

The keypad lock is switched on automatically:

- If the device has not been operated via the display for > 1 minute.
- Each time the device is restarted.

To activate the keylock manually:

1. The device is in the measured value display.
Press  for at least 2 seconds.
↳ A context menu appears.
2. In the context menu select the **Keylock on** option.
↳ The keypad lock is switched on.

 If the user attempts to access the operating menu while the keypad lock is active, the message **Keylock on** appears.

Switching off the keypad lock

1. The keypad lock is switched on.
Press  for at least 2 seconds.
↳ A context menu appears.
2. In the context menu select the **Keylock off** option.
↳ The keypad lock is switched off.

Bluetooth® wireless technology

Signal transmission via Bluetooth® wireless technology uses a cryptographic technique tested by the Fraunhofer Institute

- The device is not visible via *Bluetooth*® wireless technology without the SmartBlue app
- Only one point-to-point connection between **one** sensor and **one** smartphone or tablet is established

8.3 Display and operating module

8.3.1 Display appearance

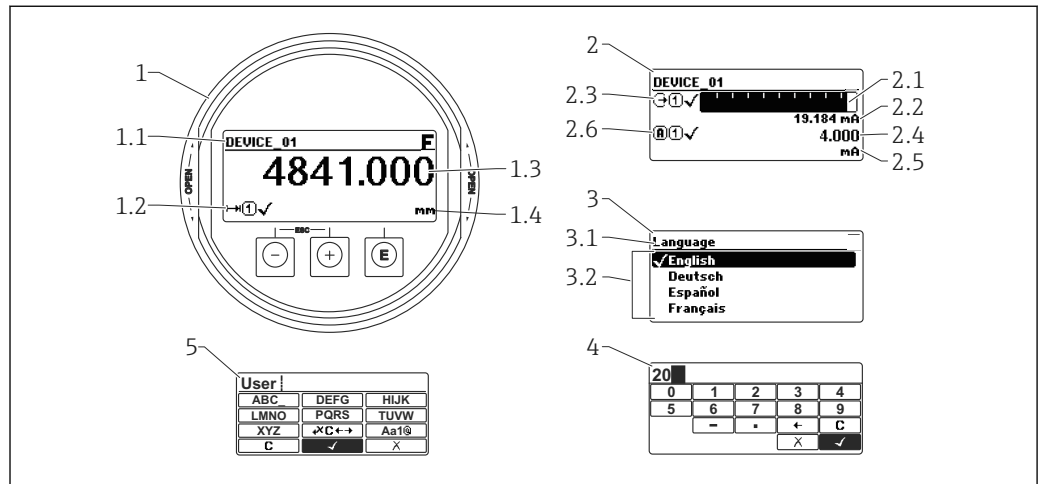





A0012635

28 Appearance of the display and operation module for on-site operation

- 1 Measured value display (1 value max. size)
- 1.1 Header containing tag and error symbol (if an error is active)
- 1.2 Measured value symbols
- 1.3 Measured value
- 1.4 Unit
- 2 Measured value display (1 bargraph + 1 value)
- 2.1 Bargraph for measured value 1
- 2.2 Measured value 1 (including unit)
- 2.3 Measured value symbols for measured value 1
- 2.4 Measured value 2
- 2.5 Unit for measured value 2
- 2.6 Measured value symbols for measured value 2
- 3 Representation of a parameter (here: a parameter with selection list)
- 3.1 Header containing parameter name and error symbol (if an error is active)
- 3.2 Selection list; marks the current parameter value.
- 4 Input matrix for numbers
- 5 Input matrix for alphanumeric and special characters



Display symbols for the submenus

Symbol	Meaning
 <small>A0018367</small>	Display/operat. Appears: <ul style="list-style-type: none"> ▪ In the main menu next to the "Display/operat." selection ▪ In the header on the left in the "Display/operat." menu
 <small>A0018364</small>	Setup Appears: <ul style="list-style-type: none"> ▪ In the main menu next to the "Setup" selection ▪ In the header on the left in the "Setup" menu
 <small>A0018365</small>	Expert Appears: <ul style="list-style-type: none"> ▪ In the main menu next to the "Expert" selection ▪ In the header on the left in the "Expert" menu
 <small>A0018366</small>	Diagnostics Appears: <ul style="list-style-type: none"> ▪ In the main menu next to the "Diagnostics" selection ▪ In the header on the left in the "Diagnostics" menu











Status signals

Symbol	Meaning
F <small>A0032902</small>	"Failure" A device error has occurred. The measured value is no longer valid.
C <small>A0032903</small>	"Function check" The device is in service mode (e.g. during a simulation).
S <small>A0032904</small>	"Out of specification" The device is being operated: <ul style="list-style-type: none"> ▪ Outside its technical specifications (e.g. during warmup or cleaning processes) ▪ Outside the parameter configuration undertaken by the user (e.g. level outside of configured range)
M <small>A0032905</small>	"Maintenance required" Maintenance is required. The measured value is still valid.





Display symbols for locking status

Symbol	Meaning
 <small>A0013148</small>	Read-only parameters The parameter shown is only for display purposes and cannot be edited.
 <small>A0013150</small>	Device locked <ul style="list-style-type: none"> ▪ In front of a parameter name: The device is locked via software and/or hardware. ▪ In the header of the measured value screen: The device is locked via hardware.

Measured value symbols

Symbol	Meaning
Measured values	
 A0032892	Level
 A0032893	Distance
 A0032908	Current output
 A0032894	Measured current
 A0032895	Terminal voltage
 A0032896	Electronics or sensor temperature
Measuring channels	
 A0032897	Measuring channel 1
 A0032898	Measuring channel 2
Status of the measured value	
 A0018361	"Alarm" status Measurement is interrupted. The output assumes the defined alarm condition. A diagnostic message is generated.
 A0018360	"Warning" status The device continues to measure. A diagnostic message is generated.

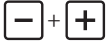
8.3.2 Operating elements

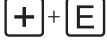
Key	Meaning
 <small>A0018330</small>	<p>Minus key</p> <p><i>For menu, submenu</i> Moves the selection bar upwards in a picklist.</p> <p><i>For text and numeric editor</i> In the input mask, moves the selection bar to the left (backwards).</p>
 <small>A0018329</small>	<p>Plus key</p> <p><i>For menu, submenu</i> Moves the selection bar downwards in a picklist.</p> <p><i>For text and numeric editor</i> In the input mask, moves the selection bar to the right (forwards).</p>
 <small>A0018328</small>	<p>Enter key</p> <p><i>For measured value display</i></p> <ul style="list-style-type: none"> ▪ Pressing the key briefly opens the operating menu. ▪ Pressing the key for 2 s opens the context menu. <p><i>For menu, submenu</i></p> <ul style="list-style-type: none"> ▪ Pressing the key briefly Opens the selected menu, submenu or parameter. ▪ Pressing the key for 2 s for parameter: If present, opens the help text for the function of the parameter. <p><i>For text and numeric editor</i></p> <ul style="list-style-type: none"> ▪ Pressing the key briefly <ul style="list-style-type: none"> ▪ Opens the selected group. ▪ Carries out the selected action. ▪ Pressing the key for 2 s confirms the edited parameter value.
 <small>A0032909</small>	<p>Escape key combination (press keys simultaneously)</p> <p><i>For menu, submenu</i></p> <ul style="list-style-type: none"> ▪ Pressing the key briefly <ul style="list-style-type: none"> ▪ Exits the current menu level and takes you to the next higher level. ▪ If help text is open, closes the help text of the parameter. ▪ Pressing the key for 2 s returns you to the measured value display ("home position"). <p><i>For text and numeric editor</i> Closes the text or numeric editor without applying changes.</p>
 <small>A0032910</small>	<p>Minus/Enter key combination (press and hold down the keys simultaneously)</p> <p>Reduces the contrast (brighter setting).</p>
 <small>A0032911</small>	<p>Plus/Enter key combination (press and hold down the keys simultaneously)</p> <p>Increases the contrast (darker setting).</p>



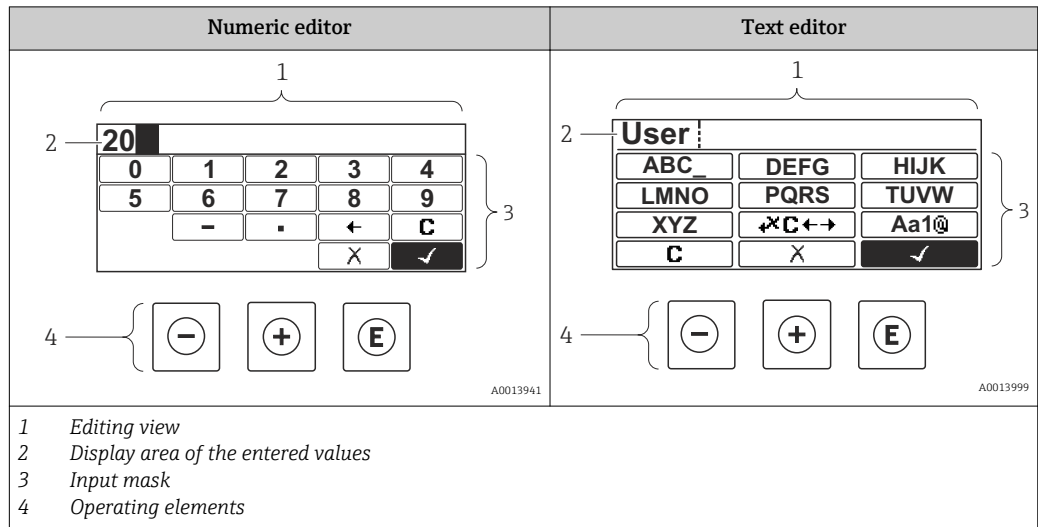



8.3.3 Enter numbers and text





Input mask



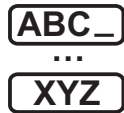

The following input symbols are available in the input mask of the numeric and text editor:

Numeric editor





Symbol	Meaning
 <small>A0013998</small>	Selection of numbers from 0 to 9.
 <small>A0016619</small>	Inserts decimal separator at the input position.
 <small>A0016620</small>	Inserts minus sign at the input position.
 <small>A0013985</small>	Confirms selection.
 <small>A0016621</small>	Moves the input position one position to the left.
 <small>A0013986</small>	Exits the input without applying the changes.
 <small>A0014040</small>	Clears all entered characters.

Text editor

Symbol	Meaning
 <small>A0013997</small>	Selection of letters from A to Z
 <small>A0013981</small>	Toggle <ul style="list-style-type: none"> Between upper-case and lower-case letters For entering numbers For entering special characters

 <small>A0013985</small>	Confirms selection.
 <small>A0013987</small>	Switches to the selection of the correction tools.
 <small>A0013986</small>	Exits the input without applying the changes.
 <small>A0014040</small>	Clears all entered characters.

Correction symbols under 

Symbol	Meaning
 <small>A0032907</small>	Clears all entered characters.
 <small>A0018324</small>	Moves the input position one position to the right.
 <small>A0018326</small>	Moves the input position one position to the left.
 <small>A0032906</small>	Deletes one character immediately to the left of the input position.

8.3.4 Opening the context menu

Using the context menu, the user can call up the following menus quickly and directly from the operational display:

- Setup
- Conf. backup disp.
- Envelope curve
- Keylock on

Calling up and closing the context menu

The user is in the operational display.

1. Press \square for 2 s.
 - ↳ The context menu opens.

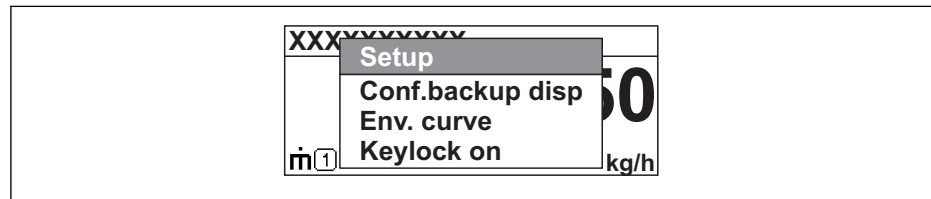

A0037872

2. Press \square + \oplus simultaneously.
 - ↳ The context menu is closed and the operational display appears.

Calling up the menu via the context menu

1. Open the context menu.
2. Press \oplus to navigate to the desired menu.
3. Press \square to confirm the selection.
 - ↳ The selected menu opens.

8.3.5 Envelope curve display on the display and operating module

In order to assess the measuring signal, the envelope curve and - if a mapping has been recorded - the mapping curve can be shown on the display and operating module:

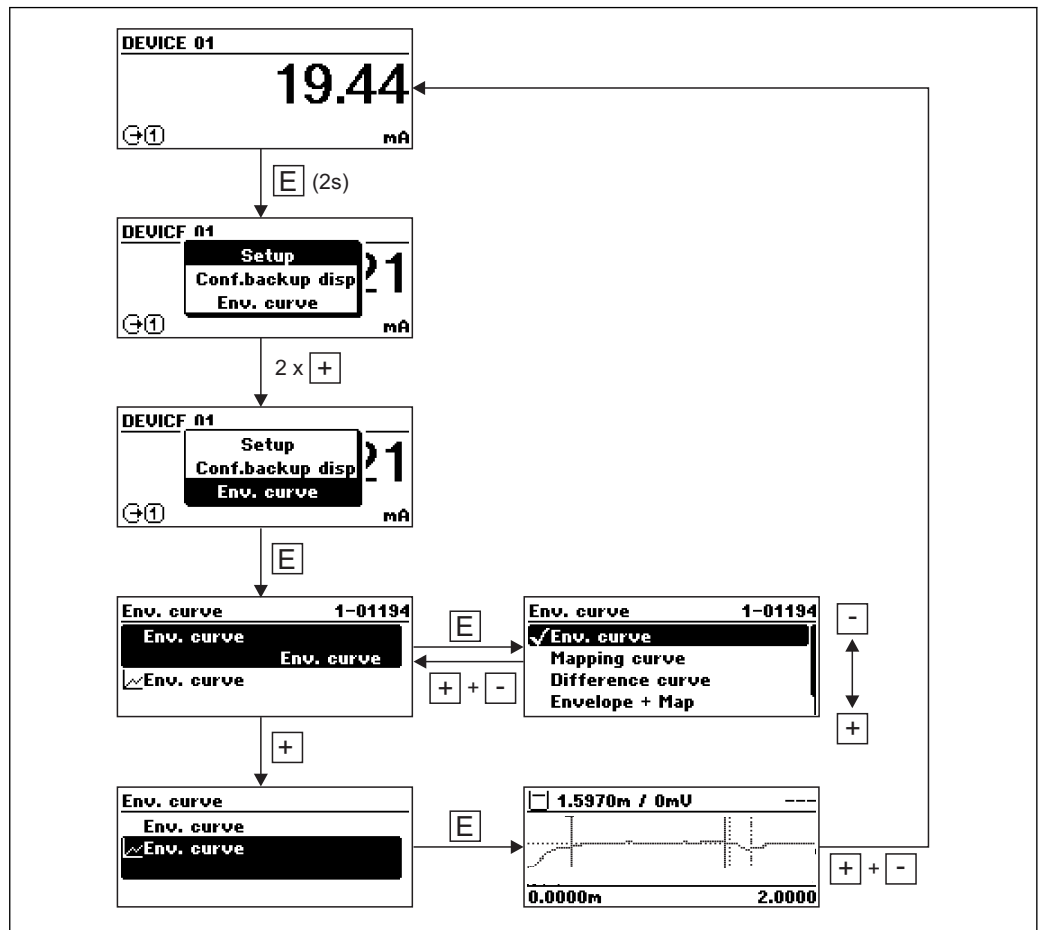

A0014277

9 Device integration via the HART protocol

9.1 Overview of the Device Description files (DD)

HART

Manufacturer ID	0x11
Device type	0x1122
HART specification	7.0
DD files	For information and files see: <ul style="list-style-type: none"> ▪ www.endress.com ▪ www.fieldcommgroup.org

9.2 HART device variables and measuring values

On delivery the following measuring values are assigned to the HART device variables:

Device variables for level measurements

Device variable	Measuring value
Primary variable (PV)	Level linearized
Secondary variable (SV)	Unfiltered distance
Tertiary variable (TV)	Absolute echo amplitude
Quaternary variable (QV)	Relative echo amplitude

 The allocation of the measuring values to the device variables can be changed in the following submenu:

Expert → Communication → Output

10 Commissioning via SmartBlue (App)

10.1 Requirements

Device requirements

Commissioning via SmartBlue is only possible if a Bluetooth module is installed in the device.

System requirements

The SmartBlue App is available for download for mobile smartphone or tablet devices in the Google Play Store for Android, and in the App Store for iOS.

- iOS devices: iPhone 5S or higher from iOS11; iPad 5th Generation or higher from iOS11; iPod Touch 6th Generation or higher from iOS11
- Devices with Android: from Android 6.0 and *Bluetooth*® 4.0

Initial password

The ID number on the nameplate of the Bluetooth module is used as the initial password when establishing the connection for the first time.

- i** It is important to note the following if the Bluetooth module is removed from one device and installed in another device: all log-in data are only stored in the Bluetooth module and not in the device. This also applies to the password changed by the user.

10.2 SmartBlue App

1. Scan the QR code or enter "SmartBlue" in the search field of the App Store.

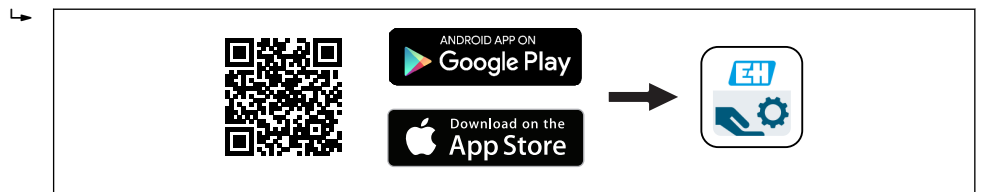

29 Download link

2. Start SmartBlue.
3. Select device from livelist displayed.
4. Enter the login data:
 - ↳ User name: admin
 - Password: serial number of the device
5. Tap the icons for more information.

- i** After logging in for the first time, change the password!

10.3 Envelope curve display in SmartBlue

Envelope curves can be displayed and recorded in SmartBlue.

In addition to the envelope curve, the following values are displayed:

- D = Distance
- L = Level
- A = Absolute amplitude
- With screenshots, the displayed section (zoom function) is saved
- With video sequences, the whole area without zoom function is saved all the time

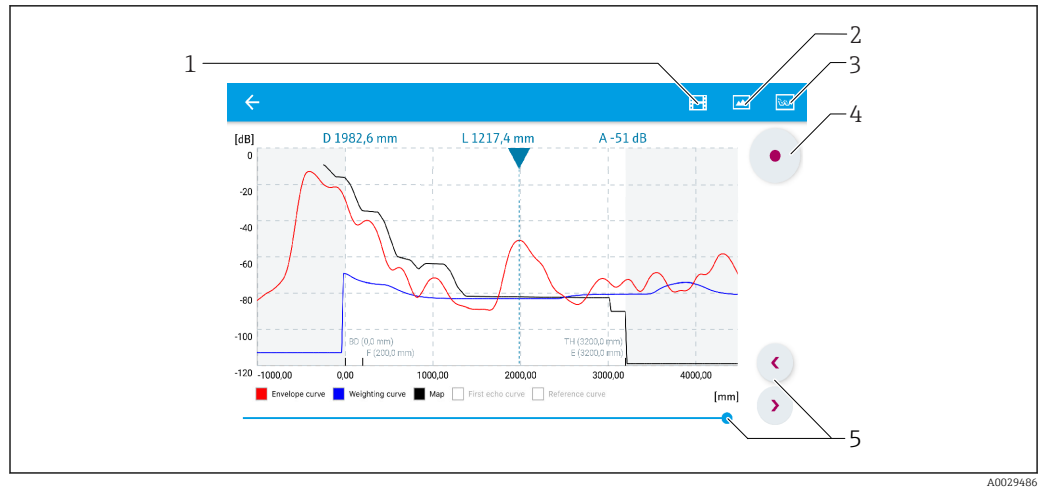

A0029486

30 Envelope curve display (sample) in SmartBlue for Android

- 1 Record video
- 2 Create screenshot
- 3 Display mapping menu
- 4 Start/stop video recording
- 5 Move time on time axis

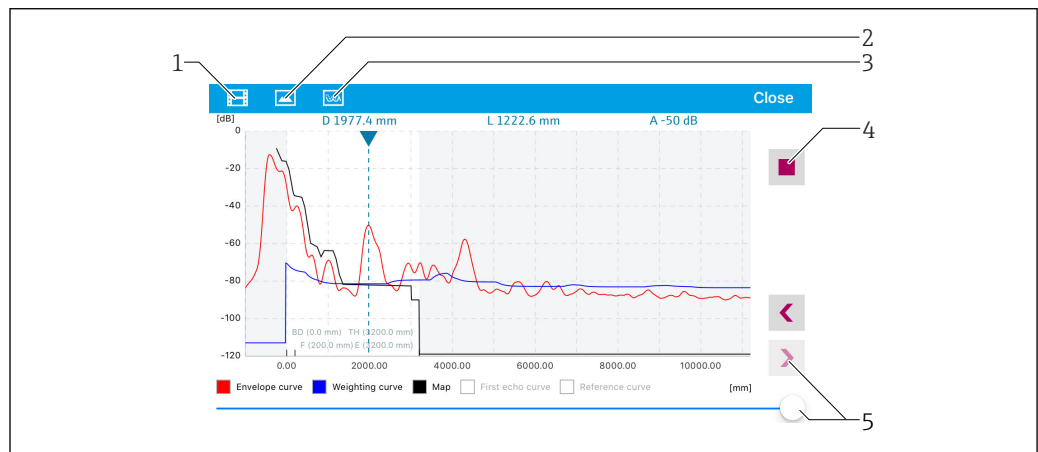

A0029487

31 Envelope curve display (sample) in SmartBlue for iOS

- 1 Record video
- 2 Create screenshot
- 3 Display mapping menu
- 4 Start/stop video recording
- 5 Move time on time axis

11 Commissioning using the Commissioning Wizard

A Wizard is provided in FieldCare and DeviceCare ¹⁾ that guides the user through the initial commissioning process.

1. Connect the device with FieldCare or DeviceCare.
2. Open the device in FieldCare or DeviceCare.
 - ↳ The dashboard (homepage) of the device is displayed:

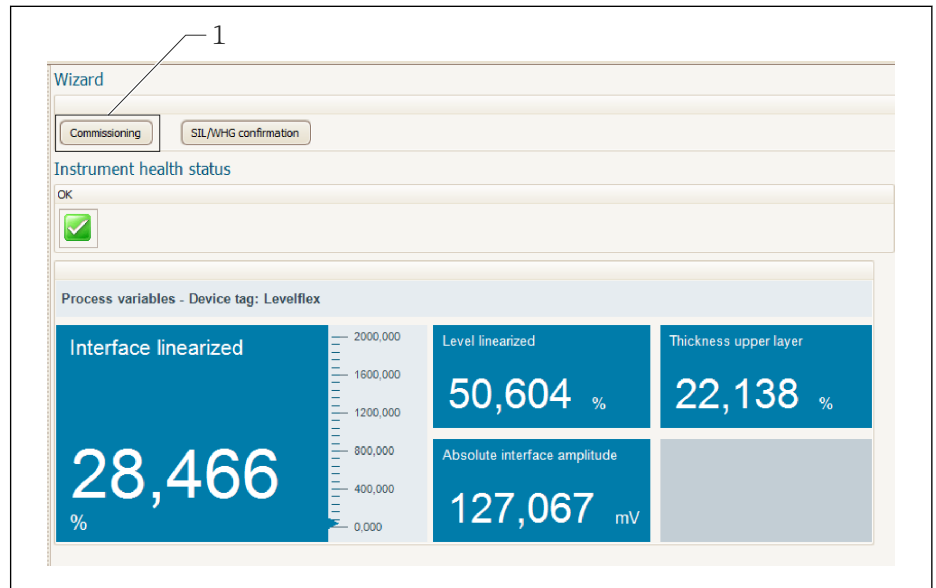

A0025866

1 "Commissioning" button calls up the wizard

3. Click "Commissioning" to launch the Wizard.
 4. Enter the appropriate value in each parameter or select the appropriate option. These values are written directly to the device.
 5. Click "Next" to go to the next page.
 6. Once all the pages have been completed, click "Finish" to close the Wizard.
- i** If you cancel the Wizard before all the necessary parameters have been entered, the device may be in an undefined state. In such situations, it is advisable to reset the device to the factory default settings.

1) DeviceCare is available for download at www.software-products.endress.com. To download the software, it is necessary to register in the Endress+Hauser software portal.

12 Commissioning via operating menu

12.1 Function check

Before commissioning your measuring point, ensure that the post-installation and post-connection checks have been performed:

12.2 Setting the operating language

Factory setting: English or ordered local language

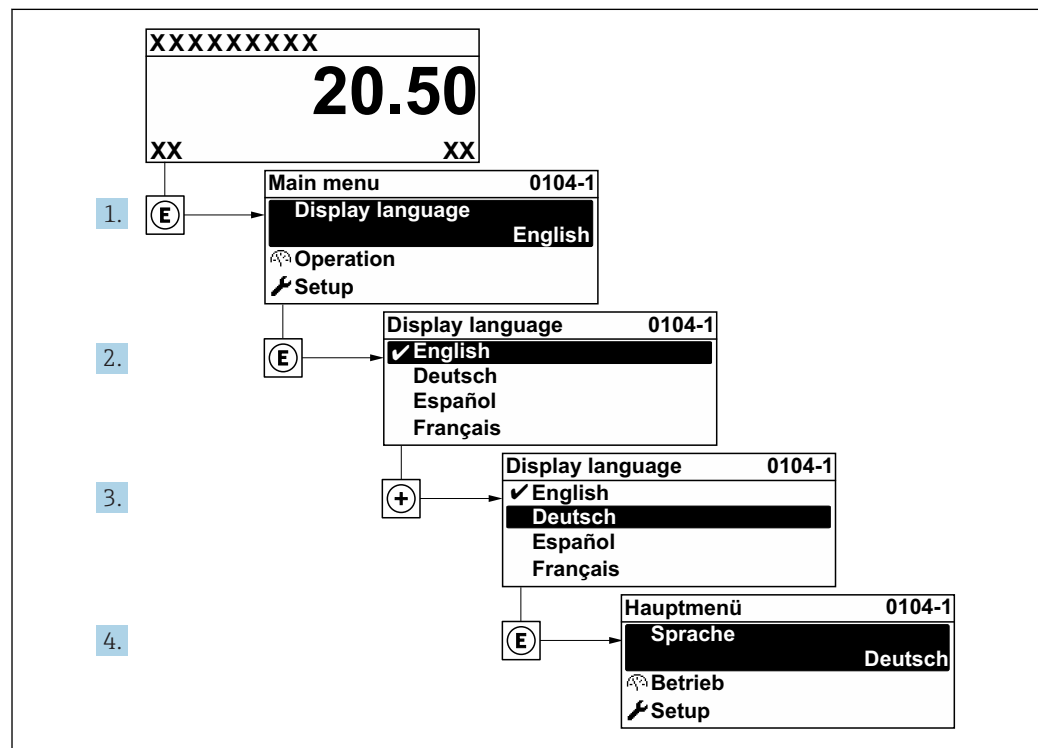

A0029420

32 Using the example of the local display

12.3 Configuring level measurement

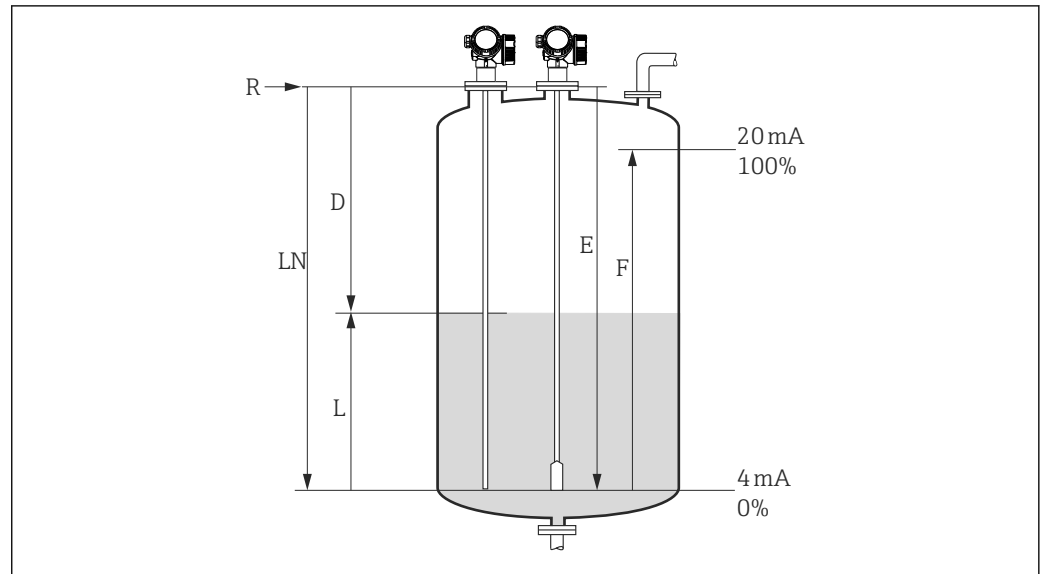

A0011360

33 Configuration parameters for level measurement in liquids

- LN Probe length
- R Reference point of measurement
- D Distance
- L Level
- E Empty calibration (= zero point)
- F Full calibration (= span)

i If the ϵ_r value is lower than 7 in the case of rope probes, measurement is not possible in the area of the tensioning weight. The empty calibration E should not exceed $LN - 250$ mm ($LN - 10$ in) in these cases.

1. Setup → Device tag
 - ↳ Enter device tag.
2. Navigate to: Setup → Distance unit
 - ↳ Select the length unit.
3. Navigate to: Setup → Tank type
 - ↳ Select tank type.
4. For **Tank type** parameter = Bypass / pipe:
 - Navigate to: Setup → Tube diameter
 - ↳ Specify the diameter of the bypass or stilling well.
5. Navigate to: Setup → Medium group
 - ↳ Specify medium group: (**Water based (DC >= 4)** or **Others**)
6. Navigate to: Setup → Empty calibration
 - ↳ Specify empty distance E (Distance from the reference point R to 0% mark).
7. Navigate to: Setup → Full calibration
 - ↳ Specify full distance F (Distance from the 0% to 100%).
8. Navigate to: Setup → Level
 - ↳ Displays the measured level L .
9. Navigate to: Setup → Distance
 - ↳ Displays the distance D between the reference point R and the level L .
10. Navigate to: Setup → Signal quality
 - ↳ Displays the signal quality of the analyzed level echo.

11. Operation via local display:
Navigate to: Setup → Mapping → Confirm distance
 - ↳ Compare the distance displayed with the actual value to start recording an interference echo map.
12. Operation via operating tool:
Navigate to: Setup → Confirm distance
 - ↳ Compare the distance displayed with the actual value to start recording an interference echo map.

12.4 Recording the reference envelope curve

After the measurement has been configured, it is recommended to record the current envelope curve as a reference envelope curve. This can then be used later for diagnostic purposes. The **Save reference curve** parameter is used to record the envelope curve.

Path in the menu

Expert → Diagnostics → Envelope diagnostics → Save reference curve

Meaning of the options

- No
No action
- Yes
The current envelope curve is saved as a reference curve.

 This submenu is only visible for the "Service" user role in devices supplied with software version 01.00.zz or 01.01.zz.

 The reference envelope curve can only be displayed in the envelope curve diagram of FieldCare after it has been loaded from the device into FieldCare. The "Load Reference Curve" function in FieldCare is used for this.

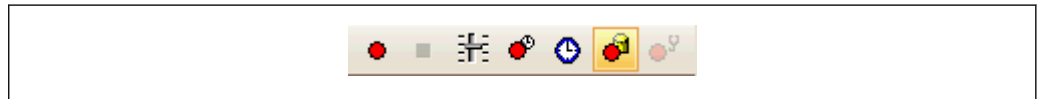

 34 "Load Reference Curve" function

12.5 Configuring the local display

12.5.1 Factory setting of local display for level measurements

Parameters	Factory setting for devices with 1 current output	Factory setting for devices with 2 current outputs
Format display	1 value, max. size	1 value, max. size
Value 1 display	Level linearized	Level linearized
Value 2 display	Distance	Distance
Value 3 display	Current output 1	Current output 1
Value 4 display	None	Current output 2

12.5.2 Adjusting the local display

The local display can be adjusted in the following submenu:

Setup → Advanced setup → Display

12.6 Configuring the current outputs

12.6.1 Factor setting of current outputs for level measurements

Current output	Assigned measured value	4mA value	20mA value
1	Level linearized	0% or the corresponding linearized value	100% or the corresponding linearized value
2 ¹⁾	Relative echo amplitude	0 mV	2 000 mV

1) for devices with two current outputs

12.6.2 Adjusting the current outputs

The current outputs can be adjusted in the following submenus:

Basic settings

Setup → Advanced setup → Current output 1 to 2

Advanced settings

Expert → Output 1 to 2 → Current output 1 to 2

See "Description of Device Parameters" GP01000F

12.7 Configuration management

After commissioning, it is possible to save the current device configuration, copy it to another measuring point or restore the previous device configuration. This can be done using the **Configuration management** parameter and its options.

Path in the menu

Setup → Advanced setup → Configuration backup display → Configuration management

Meaning of the options

■ Cancel

No action is executed and the user exits the parameter.

■ Execute backup

A backup copy of the current device configuration is saved from the HistoROM (integrated in the device) to the display module of the device.

■ Restore

The last backup copy of the device configuration is copied from the display module to the HistoROM of the device.

■ Duplicate

The transmitter configuration of the device is duplicated to another device using the display module. The following parameters, which characterize the individual measuring point are **not** transferred:

- HART date code
- HART short tag
- HART message
- HART descriptor
- HART address
- Device tag
- Medium type

■ Compare

The device configuration saved in the display module is compared to the current device configuration of the HistoROM. The result of the comparison is displayed in **Comparison result** parameter.

■ Clear backup data

The backup copy of the device configuration is deleted from the display module of the device.

 While this action is in progress, the configuration cannot be edited via the local display and a message on the processing status appears on the display.

 If an existing backup copy is restored on a device other than the original device with the **Restore** option, individual device functions may no longer be available. In some cases it is also not possible to restore the original state by resetting to the "as-delivered" state.

The **Duplicate** option should always be used to transfer the configuration to a different device.

12.8 Protecting settings from unauthorized access

The settings can be protected from unauthorized access in two ways:

- Locking via parameters (software locking)
- Locking via write protection switch (hardware locking)

13 Diagnostics and troubleshooting

13.1 General troubleshooting

13.1.1 General errors

Error	Possible cause	Solution
Device does not respond.	Supply voltage does not match the value indicated on the nameplate.	Connect the correct voltage.
	The polarity of the supply voltage is wrong.	Correct the polarity.
	The cables do not contact the terminals properly.	Ensure electrical contact between the cable and the terminal.
Values on the display invisible	Contrast setting is too weak or too strong.	<ul style="list-style-type: none"> ▪ Increase contrast by pressing \oplus and \boxplus simultaneously. ▪ Decrease contrast by pressing \ominus and \boxminus simultaneously.
	The plug of the display cable is not connected correctly.	Connect the plug correctly.
	Display is defective.	Replace display.
"Communication error" is indicated on the display when starting the device or connecting the display.	Electromagnetic interference	Check grounding of the device.
	Broken display cable or display plug.	Replace display.
Duplication of parameters via display from one device to another not working. Only the "Save" and "Cancel" options are available.	Display with backup is not properly detected if a data backup was not carried out on the new device previously.	Connect display (with backup) and restart device.
Output current <3.6 mA	Signal cable connection incorrect.	Check connection.
	Electronics module is defective.	Replace electronics.
HART communication does not function.	Communication resistor missing or incorrectly installed.	Install the communication resistor (250 Ω) correctly.
	Commubox is connected incorrectly.	Connect Commubox correctly.
	Commubox is not set to "HART".	Set Commubox selector switch to "HART".
CDI communication does not work.	Wrong setting of the COM port on the computer.	Check the setting of the COM port on the computer and change it if necessary.
Device measures incorrectly.	Parameter configuration error	Check and correct the parameter configuration.
No communication with device via SmartBlue	No Bluetooth connection	Enable Bluetooth function on smartphone or tablet
	The device is already connected with another smartphone/tablet	Disconnect the device from the other smartphone/tablet
	Bluetooth module not connected	Connect Bluetooth module (see SD02252F).
Login via SmartBlue not possible	Device is being put into operation for the first time	Enter initial password (ID of Bluetooth module) and change it

Error	Possible cause	Solution
Device cannot be operated via SmartBlue	Incorrect password entered	Enter the correct password, paying attention to lower/upper case
Device cannot be operated via SmartBlue	Password forgotten	Contact Endress+Hauser Service (www.addresses.endress.com)

13.1.2 Error - SmartBlue operation

Error	Possible cause	Solution
Device is not visible in the live list	No Bluetooth connection	Enable Bluetooth® function on smartphone or tablet
		Bluetooth® function of sensor disabled, perform recovery sequence
Device is not visible in the live list	The device is already connected with another smartphone/tablet	Only one point-to-point connection is established between a sensor and a smartphone or tablet
Device is visible in the live list but cannot be accessed via SmartBlue	Android end device	Is the location function enabled for the app, was it approved the first time?
		GPS or positioning function must be activated for certain Android versions in conjunction with Bluetooth®
		Activate GPS - close the app fully and restart - enable the positioning function for the app
Device is visible in the live list but cannot be accessed via SmartBlue	Apple end device	Log in as standard Enter user name "admin" Enter initial password (ID of the Bluetooth module) paying attention to lower/upper case
Login via SmartBlue not possible	Device is being put into operation for the first time	Enter initial password (ID of the Bluetooth module) and change; paying attention to lower/upper case
Device cannot be operated via SmartBlue	Incorrect password entered	Enter correct password
Device cannot be operated via SmartBlue	Password forgotten	Contact the Endress+Hauser Service department (www.addresses.endress.com)

13.1.3 Parameter configuration errors

Parameter configuration errors for level measurements

Error	Possible cause	Solution
Measured value incorrect	If measured distance (Setup → Distance) matches the real distance: Calibration error	<ul style="list-style-type: none"> ▪ Check and adjust Empty calibration parameter (→ ☰ 125) if necessary. ▪ Check and adjust Full calibration parameter (→ ☰ 125) if necessary. ▪ Check and adjust linearization if necessary (Linearization submenu (→ ☰ 140)).
	If measured distance (Setup → Distance) does not match the real distance: Interference echo	Carry out mapping (Confirm distance parameter (→ ☰ 128)).
No change of measured value on filling/emptying	Interference echo	Carry out mapping (Confirm distance parameter (→ ☰ 128)).
	Buildup at the probe.	Clean the probe.
	Error in the echo tracking.	Deactivate echo tracking (Expert → Sensor → Echo tracking → Evaluation mode = History off).
Echo lost diagnostic message appears after switching on the supply voltage.	Echo threshold too high.	Check Medium group parameter (→ ☰ 124). If necessary, select a more detailed setting in Medium property parameter (→ ☰ 134).
	Level echo suppressed.	Delete mapping and record it again if necessary (Record map parameter (→ ☰ 129)).
Device displays a level when the tank is empty.	Incorrect probe length	Carry out probe length correction (Confirm probe length parameter (→ ☰ 156)).
	Interference echo	Carry out mapping over entire probe length while the tank is empty (Confirm distance parameter (→ ☰ 128)).
Wrong slope of the level throughout the complete measuring range	Wrong tank type selected.	Set Tank type parameter (→ ☰ 123) correctly.

13.2 Diagnostic information on local display

13.2.1 Diagnostic message

Faults detected by the self-monitoring system of the measuring device are displayed as a diagnostic message in alternation with the measured value display.

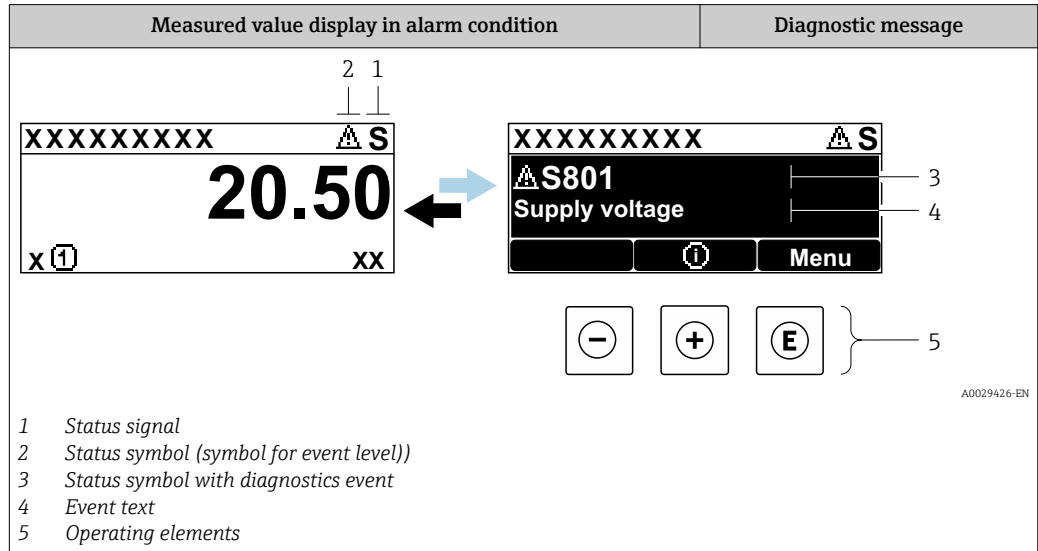

Status signals

F <small>A0032902</small>	"Failure (F)" option A device error is present. The measured value is no longer valid.
C <small>A0032903</small>	"Function check (C)" option The device is in service mode (e.g. during a simulation).
S <small>A0032904</small>	"Out of specification (S)" option The device is operated: <ul style="list-style-type: none"> ▪ Outside of its technical specifications (e.g. during startup or a cleaning) ▪ Outside of the configuration carried out by the user (e.g. level outside configured span)
M <small>A0032905</small>	"Maintenance required (M)" option Maintenance is required. The measured value is still valid.

Status symbol (symbol for event level)

⊗	"Alarm" status The measurement is interrupted. The signal outputs take on the defined alarm condition. A diagnostic message is generated.
⚠	"Warning" status The device continues to measure. A diagnostic message is generated.

Diagnostics event and event text

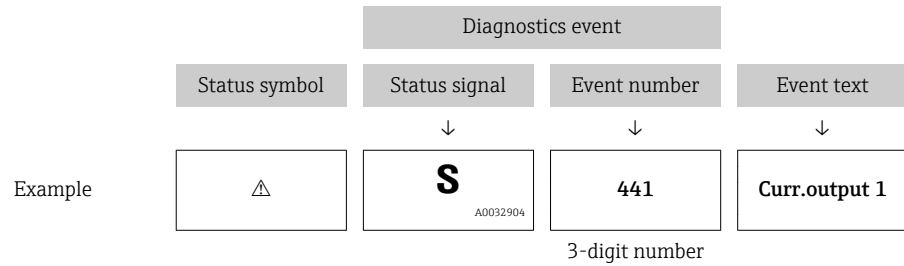

The fault can be identified using the diagnostics event. The event text helps you by providing information about the fault. In addition, the corresponding symbol is displayed before the diagnostics event.



If two or more diagnostic messages are pending simultaneously, only the message with the highest priority is shown. Additional pending diagnostic messages can be shown in the **Diagnostic list** submenu.

-  Past diagnostic messages that are no longer pending are shown as follows:
 - On the local display:
in the **Event logbook** submenu
 - In FieldCare:
via the "Event List /HistoROM" function.

Operating elements

Operating functions in menu, submenu	
	Plus key Opens the message about the remedial measures.
	Enter key Opens the operating menu.

13.2.2 Calling up remedial measures

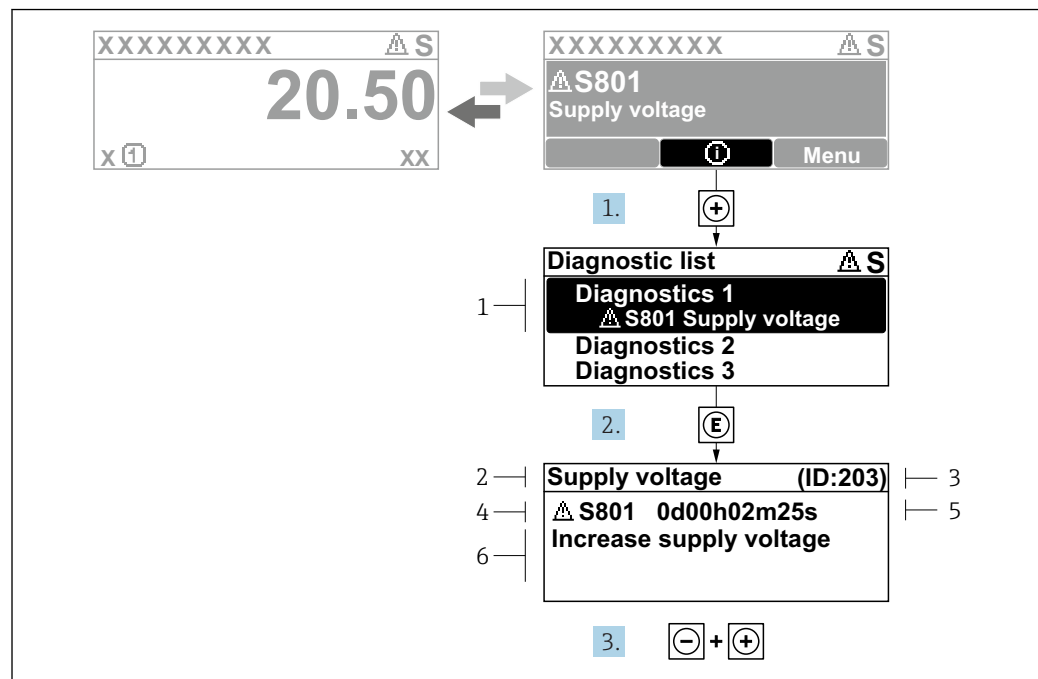

35 Message for remedial measures

- 1 Diagnostic information
- 2 Short text
- 3 Service ID
- 4 Diagnostic behavior with diagnostic code
- 5 Operation time of occurrence
- 6 Remedial measures

The user is in the diagnostic message.

1. Press \oplus ($\text{\textcircled{1}}$ -Symbol).
 - ↳ **Diagnostic list** submenu opens.
2. Select the desired diagnostic event with \oplus or \ominus and press $\text{\textcircled{E}}$.
 - ↳ The message for the remedial measures for the selected diagnostic event opens.
3. Press $\ominus + \oplus$ simultaneously.
 - ↳ The message for the remedial measures closes.

The user is in the **Diagnostics** menu at an entry for a diagnostics event, e.g. in **Diagnostic list** submenu or in **Previous diagnostics**.

1. Press $\text{\textcircled{E}}$.
 - ↳ The message for the remedial measures for the selected diagnostic event opens.
2. Press $\ominus + \oplus$ simultaneously.
 - ↳ The message for the remedial measures closes.

13.3 Diagnostic event in the operating tool

If a diagnostic event is present in the device, the status signal appears in the top left status in the operating tool along with the corresponding symbol for event level in accordance with NAMUR NE 107:

- Failure (F)
- Function check (C)
- Out of specification (S)
- Maintenance required (M)

A: Via the operating menu

1. Navigate to the **Diagnostics** menu.
 - ↳ In the **Actual diagnostics** parameter, the diagnostic event is shown with event text.
2. On the right in the display range, hover the cursor over the **Actual diagnostics** parameter.

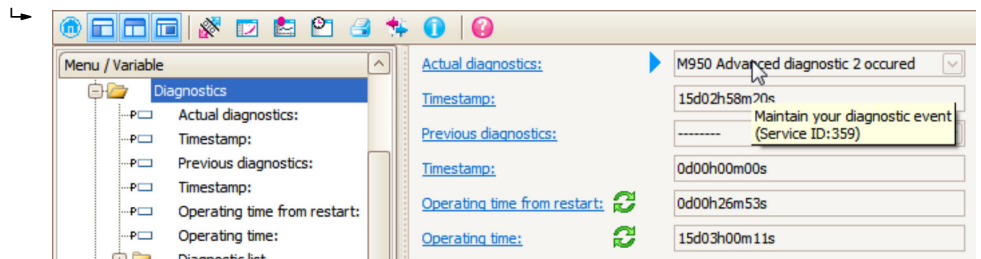

A tool tip with remedial measures for the diagnostic event appears.

B: Via the "Create documentation" function

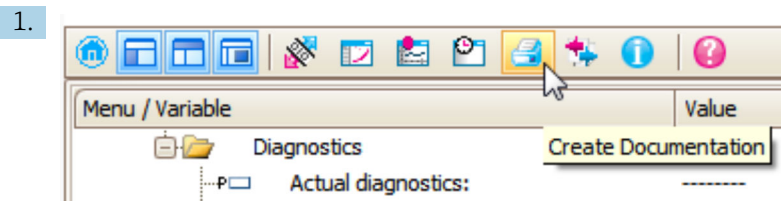

Select the "Create documentation" function.

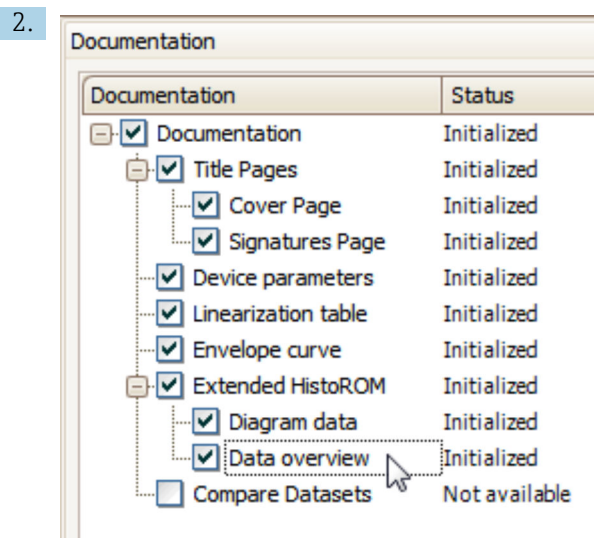

Make sure "Data overview" is marked.

3. Click "Save as ..." and save a PDF of the protocol.
 - ↳ The protocol contains the diagnostic messages and remedy information.

C: Via the "Eventlist / Extended HistoROM" function

1.

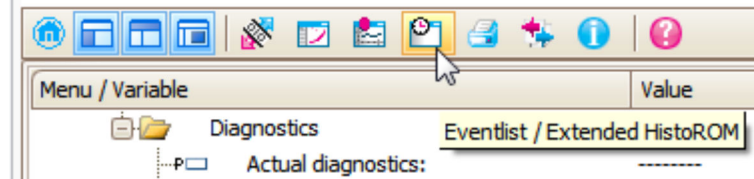

Select the "Eventlist / Extended HistoROM" function.

2.

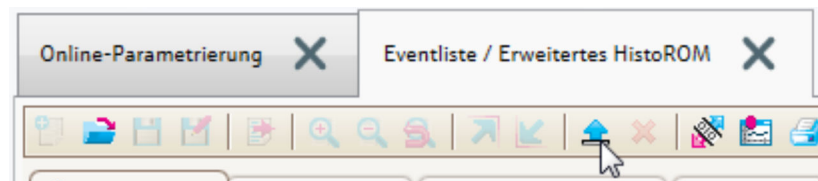

Select the "Load Eventlist" function.

- ↳ The list of events, including remedy information, is shown in the "Data overview" window.

13.4 Diagnostic list

In the **Diagnostic list** submenu submenu, up to 5 currently pending diagnostic messages can be displayed. If more than 5 messages are pending, the messages with the highest priority are shown on the display.

Navigation path

Diagnostics → Diagnostic list

Calling up and closing the remedial measures

1. Press \square .
 - ↳ The message for the remedial measures for the selected diagnostic event opens.
2. Press \square + \oplus simultaneously.
 - ↳ The message about the remedial measures closes.

13.5 List of diagnostic events

Diagnostic number	Short text	Remedy instructions	Status signal [from the factory]	Diagnostic behavior [from the factory]
Diagnostic of sensor				
003	Broken probe detected	1. Check map 2. Check sensor	F	Alarm
046	Build-up detected	Clean sensor	F	Alarm
104	HF cable	and check sealing 1. Dry HF cable connection 2. Change HF cable	F	Alarm
105	HF cable	1. Tighten HF cable connection 2. Check sensor 3. Change HF cable	F	Alarm
106	Sensor	1. Check sensor 2. Check HF cable 3. Contact service	F	Alarm
Diagnostic of electronic				
242	Software incompatible	1. Check software 2. Flash or change main electronics module	F	Alarm
252	Modules incompatible	1. Check if correct electronic modul is plugged 2. Replace electronic module	F	Alarm
261	Electronic modules	1. Restart device 2. Check electronic modules 3. Change I/O Modul or main electronics	F	Alarm
262	Module connection	1. Check module connections 2. Change electronic modules	F	Alarm
270	Main electronic failure	Change main electronic module	F	Alarm
271	Main electronic failure	1. Restart device 2. Change main electronic module	F	Alarm
272	Main electronic failure	1. Restart device 2. Contact service	F	Alarm
273	Main electronic failure	1. Emergency operation via display 2. Change main electronics	F	Alarm
275	I/O module defective	Change I/O module	F	Alarm
276	I/O module faulty	1. Restart device 2. Change I/O module	F	Alarm
276	I/O module faulty		F	Alarm
282	Data storage	1. Restart device 2. Contact service	F	Alarm
283	Memory content	1. Transfer data or reset device 2. Contact service	F	Alarm
311	Electronic failure	Maintenance required! 1. Do not perform reset 2. Contact service	M	Warning
Diagnostic of configuration				
410	Data transfer	1. Check connection 2. Retry data transfer	F	Alarm
411	Up-/download active	Up-/download active, please wait	C	Warning
412	Processing download	Download active, please wait	C	Warning

Diagnostic number	Short text	Remedy instructions	Status signal [from the factory]	Diagnostic behavior [from the factory]
431	Trim 1 to 2	Carry out trim	C	Warning
435	Linearization	Check linearization table	F	Alarm
437	Configuration incompatible	1. Restart device 2. Contact service	F	Alarm
438	Dataset	1. Check data set file 2. Check device configuration 3. Up- and download new configuration	M	Warning
441	Current output 1 to 2	1. Check process 2. Check current output settings	S	Warning
484	Failure mode simulation	Deactivate simulation	C	Alarm
485	Simulation measured value	Deactivate simulation	C	Warning
491	Current output 1 to 2 simulation	Deactivate simulation	C	Warning
494	Switch output simulation	Deactivate simulation switch output	C	Warning
495	Diagnostic event simulation	Deactivate simulation	C	Warning
585	Simulation distance	Deactivate simulation	C	Warning
Diagnostic of process				
801	Energy too low	Increase supply voltage	S	Warning
803	Current loop	1. Check wiring 2. Change I/O module	F	Alarm
825	Operating temperature	1. Check ambient temperature 2. Check process temperature	S	Warning
825	Operating temperature		F	Alarm
921	Change of reference	1. Check reference configuration 2. Check pressure 3. Check sensor	S	Warning
936	EMC interference	Check installation on EMC	F	Alarm
941	Echo lost	Check parameter 'DC value'	F	Alarm ¹⁾
942	In safety distance	1. Check level 2. Check safety distance 3. Reset self holding	S	Alarm ¹⁾
943	In blocking distance	Reduced accuracy Check level	S	Warning
944	Level range	Reduced accuracy Level at process connection	S	Warning
950	Advanced diagnostic 1 to 2 occurred	Maintain your diagnostic event	M	Warning ¹⁾

1) Diagnostic behavior can be changed.

13.6 Event logbook

13.6.1 Event history

A chronological overview of the event messages that have occurred is provided in the **Event list** submenu ²⁾.

Navigation path

Diagnostics → Event logbook → Event list

A maximum of 100 event messages can be displayed in chronological order.



Die Ereignishistorie umfasst Einträge zu:

- Diagnostic events
- Information events

In addition to the operation time of its occurrence, each event is also assigned a symbol that indicates whether the event has occurred or is ended:

- Diagnostic event
 - ☺: Event has occurred
 - ☹: Event has ended
- Information event
 - ☺: Event has occurred

Calling up and closing the remedial measures

1. Press 
 - ↳ The message for the remedial measures for the selected diagnostic event opens.
2. Press  +  simultaneously.
 - ↳ The message about the remedial measures closes.

13.6.2 Filtering the event logbook

Using the **Filter options** parameter, you can define which category of event messages is displayed in the **Event list** submenu.

Navigation path

Diagnostics → Event logbook → Filter options

Filter categories

- All
- Failure (F)
- Function check (C)
- Out of specification (S)
- Maintenance required (M)
- Information

13.6.3 Overview of information events

Info number	Info name
I1000	----- (Device ok)
I1089	Power on
I1090	Configuration reset
I1091	Configuration changed

2) This submenu is only available for operation via local display. In the case of operation via FieldCare, the event list can be displayed with the "Event List / HistoROM" functionality of FieldCare.

Info number	Info name
I1092	Embedded HistoROM deleted
I1110	Write protection switch changed
I1137	Electronic changed
I1151	History reset
I1154	Reset terminal voltage min/max
I1155	Reset electronic temperature
I1156	Memory error trend
I1157	Memory error event list
I1184	Display connected
I1185	Display backup done
I1186	Restore via display done
I1187	Settings downloaded with display
I1188	Display data cleared
I1189	Backup compared
I1256	Display: access status changed
I1264	Safety sequence aborted
I1335	Firmware changed
I1397	Fieldbus: access status changed
I1398	CDI: access status changed
I1512	Download started
I1513	Download finished
I1514	Upload started
I1515	Upload finished
I1554	Safety sequence started
I1555	Safety sequence confirmed
I1556	Safety mode off

13.7 Firmware history

Date	Firmware version	Modifications	Documentation (FMP53, HART)		
			Operating Instructions	Description of Device Parameters	Technical Information
07.2010	01.00.zz	Original software	BA01002F/00/EN/05.10	GP01000F/00/EN/05.10	TI01002F/00/EN/05.10
01.2011	01.01.zz	<ul style="list-style-type: none"> ▪ SIL integrated ▪ Improvements and bugfixes ▪ Additional languages 	<ul style="list-style-type: none"> ▪ BA01002F/00/EN/10.10 ▪ BA01002F/00/EN/13.11 ▪ BA01002F/00/EN/14.12 	<ul style="list-style-type: none"> ▪ GP01000F/00/EN/10.10 ▪ GP01000F/00/EN/13.11 	<ul style="list-style-type: none"> ▪ TI01002F/00/EN/10.10 ▪ TI01002F/00/EN/13.11 ▪ TI01002F/00/EN/14.12 ▪ TI01002F/00/EN/15.12
02.2014	01.02.zz	<ul style="list-style-type: none"> ▪ Support of SD03 ▪ Additional languages ▪ HistoROM functionality enhanced ▪ "Advanced Diagnostics" function block integrated ▪ Improvements and bugfixes 	<ul style="list-style-type: none"> ▪ BA01002F/00/EN/15.13 ▪ BA01002F/00/EN/16.14 	<ul style="list-style-type: none"> ▪ GP01000F/00/EN/14.13 ▪ GP01000F/00/EN/15.14 	<ul style="list-style-type: none"> ▪ TI01002F/00/EN/16.13 ▪ TI01002F/00/EN/17.14
04.2016	01.03.zz	<ul style="list-style-type: none"> ▪ Update to HART 7 ▪ All 17 languages are available in the device ▪ Improvements and bugfixes 	<ul style="list-style-type: none"> ▪ BA01002F/00/EN/17.16 ▪ BA01002F/00/EN/18.16 ¹⁾ ▪ BA01002F/00/EN/20.18 ²⁾ 	GP01000F/00/EN/16.16	<ul style="list-style-type: none"> ▪ TI01002F/00/EN/18.16 ▪ TI01002F/00/EN/20.16 ¹⁾ ▪ TI01002F/00/EN/22.18 ²⁾

- 1) Contains information on the Heartbeat wizards available in the current DTM version for DeviceCare and FieldCare.
- 2) Contains information on Bluetooth interface.



The firmware version can explicitly be ordered via the product structure. In this way it is possible to ensure compatibility of the firmware version with an existing or planned system integration.

14 Maintenance

The measuring device requires no special maintenance.

14.1 Exterior cleaning

When exterior-cleaning the device, always use cleaning agents that do not attack the surface of the housing and the seals.

14.2 Cleaning the probe

14.2.1 Cleaning the probe in the tank

If the device has been mounted in a suitable position, the probe can be cleaned in the tank using a spray ball ([Verweisziel existiert nicht, aber @y.link.required=true](#)).

14.2.2 Cleaning the probe outside the tank

The probe can be disassembled so it can be cleaned better.

The disassembly requires the following tools:

- vise with fiber braces (surface protection for the polished probe rod)
- hook wrench \varnothing 54 mm (21 in)
- open-ended wrench AF27 / AF32 with a torque adjustment up to 20 Nm

Caution!

- Before disassembly, it has to be made sure that the supply voltage for the instrument is switched off!
- When releasing the slotted nut (1) make sure to counterhold at the process connection ring (5) with an open-ended wrench as the adapter (3) could otherwise be released from the flange.

Unmounting the electronics housing

- Unscrew the grooved nut with a hook wrench.
- Remove the unscrewed housing (2) together with the housing adapter from the adapter (3) of the process connection. The housing adapter is still connected with the housing. For the remote version: remove only the cable adapter.
- Replace O-ring (7) where necessary.
Order code: see Device Viewer (*Verweisziel existiert nicht, aber @y.link.required=true*).

Disassembly of the rod probe

- Unscrew adapter (3) from the process connection (as example: flange): unscrew adapter at the wrench faces with hook wrench (AF27) and pull it out of the tank together with the rod probe (length max. 4 m).
- Clamp the probe rod (4) at the wrench flats or use fitting pliers.

Caution: Protect the surface of the polished probe rod! Do not damage the surface by scratching or denting it.

- Unscrew adapter (3) from the probe rod (approx. 12 rotations counter-clockwise) and remove (plug connection). The probe rod is screwed in the insulating bush with 4.5 Nm.
- The O-rings (6) of the probe rod and adapter are now freely accessible and can be exchanged if necessary. The probe rod can be cleaned (autoclaved).
Order code of the O-rings: see Device Viewer (*Verweisziel existiert nicht, aber @y.link.required=true*).

Assembly of the probe

The assembly is done in reversed order:

- Screw adapter (3) with 4.5 Nm on the probe rod (4).
- Screw the adapter into the container process connection together with the probe rod and tighten with 20 Nm.
- Stick housing (2) with housing adapter on the adapter and bolt it with the grooved nut (1) - torque 20 Nm.

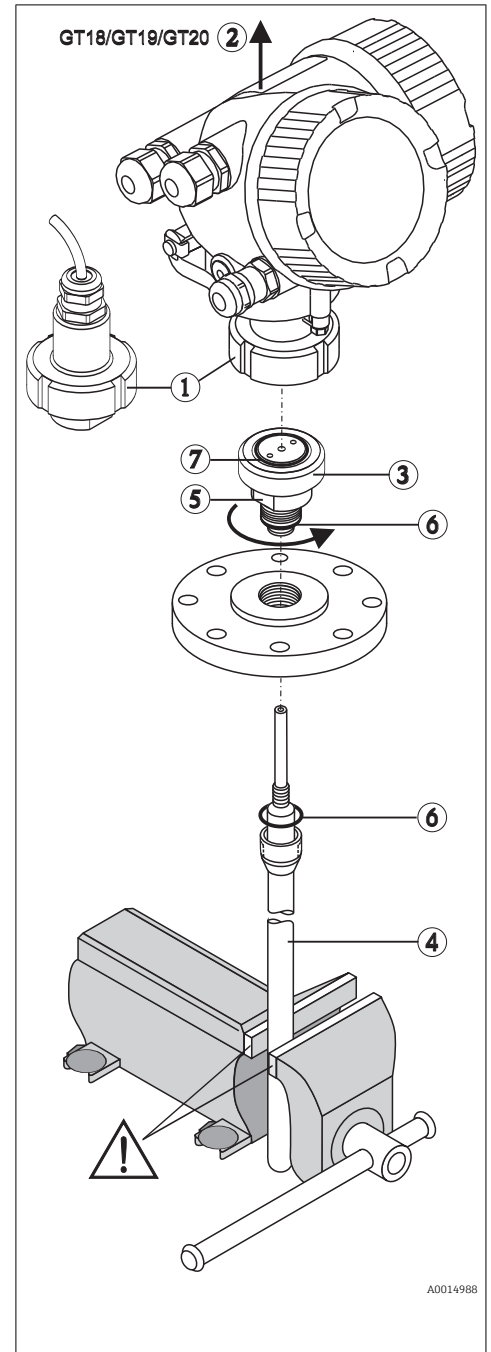

15 Repair

15.1 General notes

15.1.1 Repair concept

Under the Endress+Hauser repair concept, devices have a modular design and repairs are carried out by Endress+Hauser Service or by properly trained customers.

Spare parts are grouped into logical kits with the associated replacement instructions.

For more information on service and spare parts, please contact Endress+Hauser Service.

15.1.2 Repair of Ex-certified devices

When repairing Ex-certified devices, please also note the following:

- Only specialist personnel or Endress+Hauser-Service can carry out repairs to Ex certified devices.
- Relevant standards and national regulations as well as safety instructions (XA) and certificates must be observed.
- Only genuine Endress+Hauser spare parts may be used.
- When ordering spare parts, please check the device designation on the nameplate. Only identical parts may be used as replacements.
- Carry out repairs according to the instructions. Following a repair, the device must fulfill the requirements of the individual tests specified for that device.
- A certified device may be converted to another certified device version by Endress +Hauser Service only.
- All repairs and modifications must be documented.

15.1.3 Replacing electronics modules

When electronics modules have been replaced the device does not need to be recalibrated as the parameters are saved in the HistoROM inside the housing. It may be necessary when replacing the main electronics to record a new interference echo suppression.

15.1.4 Replacing a device

Once a complete device has been replaced, the parameters can be transferred back into the device using one of the following methods:

- Using the display module
Prerequisite: The configuration of the old device was saved previously to the display module.
- Via FieldCare
Prerequisite: The configuration of the old device was saved previously to the computer using FieldCare.

You can continue measuring without performing a new calibration. Only interference echo suppression may need to be carried out once again.

15.2 Spare parts

- Some replaceable measuring device components are identified by means of a spare part nameplate. This contains information about the spare part.
- In the connection compartment cover of the device there is a spare part nameplate which contains the following information:
 - A list of the most important spare parts for the measuring device, including their ordering information.
 - The URL for the *W@M Device Viewer* (www.endress.com/deviceviewer): All the spare parts for the measuring device, along with the order code, are listed here and can be ordered. If available, users can also download the associated Installation Instructions.

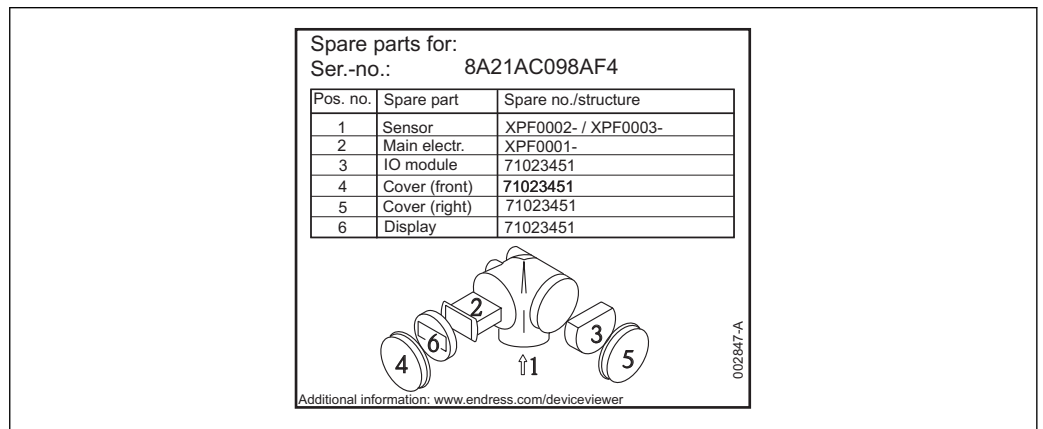

36 Example for spare part nameplate in the connection compartment cover

- i** Measuring device serial number:
 - Located on the device and spare part nameplate.
 - Can be read out via the "Serial number" parameter in the "Device information" submenu.

15.3 Return

The requirements for safe device return can vary depending on the device type and national legislation.

1. Refer to the website for more information: <http://www.endress.com/support/return-material>
2. Return the device if repairs or a factory calibration are required, or if the wrong device was ordered or delivered.

15.4 Disposal





If required by the Directive 2012/19/EU on waste electrical and electronic equipment (WEEE), the product is marked with the depicted symbol in order to minimize the disposal of WEEE as unsorted municipal waste. Do not dispose of products bearing this marking as unsorted municipal waste. Instead, return them to Endress+Hauser for disposal under the applicable conditions.

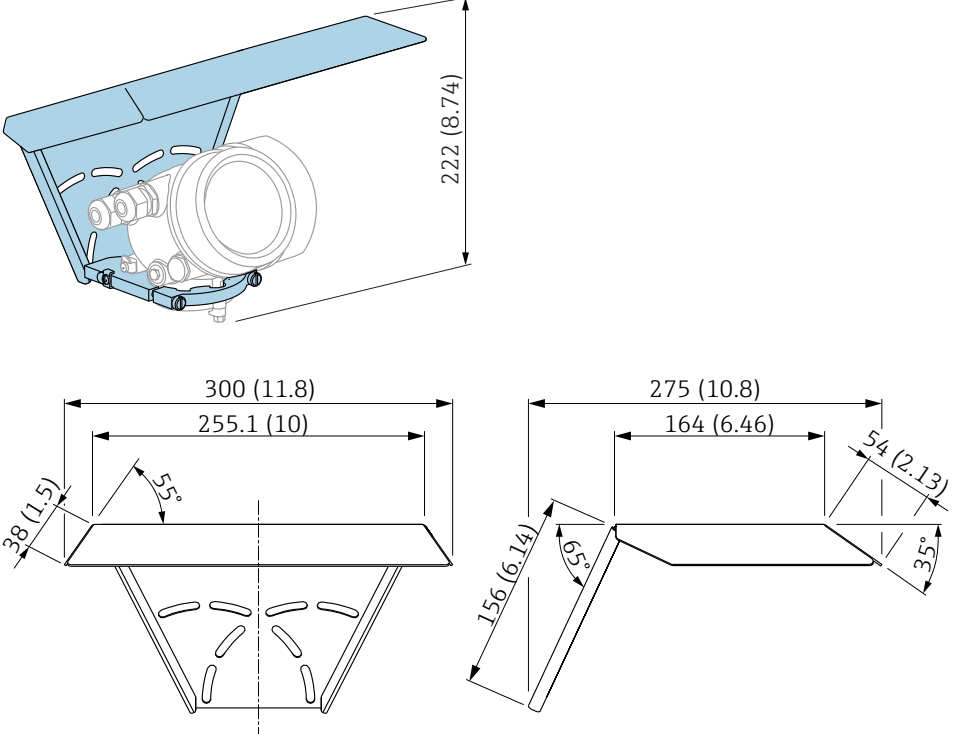

16 Accessories

16.1 Device-specific accessories

16.1.1 Weather protection cover

Accessory	Description
Weather protection cover	 <p data-bbox="1380 869 1436 884">A0015466</p> <p data-bbox="1380 1281 1436 1296">A0015472</p> <p data-bbox="327 1303 837 1332">  37 Weather protection cover; Dimensions: mm (in) </p> <p data-bbox="327 1355 1404 1435">  The weather protection cover can be ordered together with the device (product structure, feature 620 "Accessory Enclosed", option PB "Weather Protection Cover"). Alternatively, it can be separately ordered as an accessory; order code 71162242. </p>

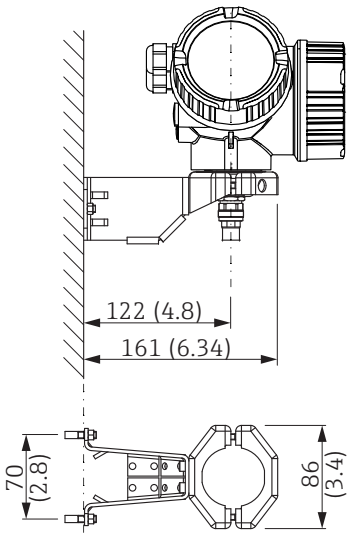
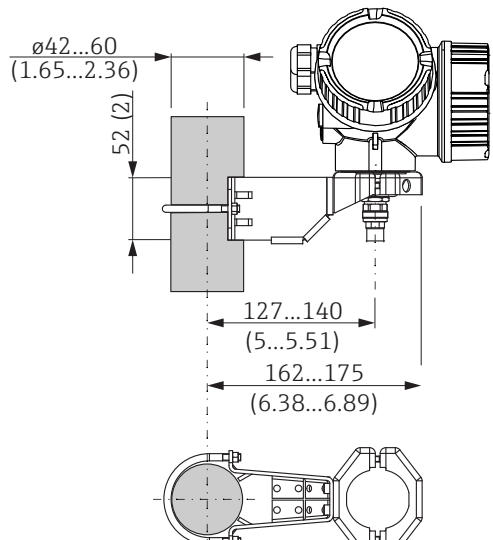
16.1.2 Mounting bracket for electronics housing

Accessories	Description
Mounting bracket for electronics housing	<div style="display: flex; justify-content: space-around;"> <div style="text-align: center;"> <p>A</p>  </div> <div style="text-align: center;"> <p>B</p>  </div> </div> <p> 38 Mounting bracket for electronics housing; engineering unit: mm (in)</p> <p>A Wall mounting B Post mounting</p> <p> With "remote sensor" device versions (see feature 060 in the product structure), the mounting bracket is included in the scope of delivery. However, it can also be ordered separately as an accessory (order number: 71102216).</p> <p style="text-align: right; font-size: small;">A0014793</p>

16.1.3 Weld-in adapter

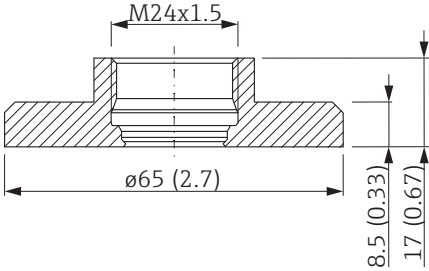
Accessories	Description
Weld-in adapter M24 D65	<div style="text-align: center;">  </div> <p>With M24x1.5 thread for flush-mounted installation of sensor. Material: 1.4435 (AISI 316L) Weight: 0.22 kg (0.48 lbs)</p> <p>Order number</p> <ul style="list-style-type: none"> ■ Standard version: 71041381 ■ With 3.1 material certificate: 71041383 <p>For details, see Operating Instructions BA361F.</p> <p style="text-align: right; font-size: small;">A0012776</p>

16.1.4 Protective cover

Accessories	Description
Protective cover	 <p data-bbox="1385 479 1436 492">A0013589</p> <p data-bbox="676 521 1270 600">For closing off the probe when the electronics module is removed Order number: 71041379 For details, see Operating Instructions BA362F.</p>

16.1.5 Calibration kit

Accessories	Description
Calibration kit	<p data-bbox="676 779 1423 831">The calibration kit is used for regular testing of the accuracy and reproducibility of the Levelflex FMP53 level measurement device.</p> <p data-bbox="676 833 912 857">Order number: 71041382</p> <p data-bbox="676 860 1129 884">For details, see Operating Instructions SD01003F.</p>

16.1.6 Remote display FHX50

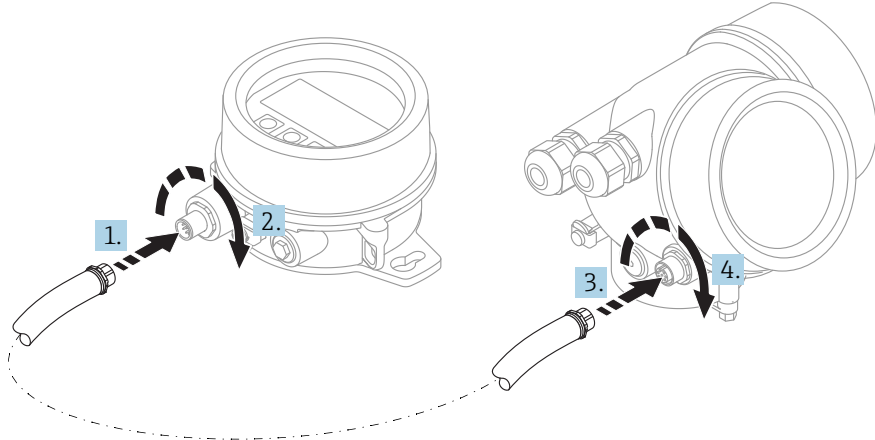
Accessories	Description
Remote display FHX50	<div style="text-align: center;">  </div> <p style="text-align: right; font-size: small;">A0019128</p> <ul style="list-style-type: none"> ▪ Material: <ul style="list-style-type: none"> ▪ Plastic PBT ▪ 316L/1.4404 ▪ Aluminum ▪ Degree of protection: IP68 / NEMA 6P and IP66 / NEMA 4x ▪ Suitable for display modules: <ul style="list-style-type: none"> ▪ SD02 (push buttons) ▪ SD03 (touch control) ▪ Connecting cable: <ul style="list-style-type: none"> ▪ Cable supplied with device up to 30 m (98 ft) ▪ Standard cable supplied by customer up to 60 m (196 ft) ▪ Ambient temperature range: -40 to 80 °C (-40 to 176 °F) ▪ Ambient temperature range (option): -50 to 80 °C (-58 to 176 °F) ¹⁾ <p> i If the remote display should be used, order the device version "Prepared for display FHX50" (feature 030, version L, M or N). For the FHX50, you must select option A: "Prepared for display FHX50" under feature 050 "Measuring device version". </p> <p> i If the device version "Prepared for display FHX50" was not originally ordered and a FHX50 display is to be retrofitted, you must select version B "Not prepared for display FHX50" under feature 050: "Measuring device version" when ordering the FHX50. In this case, a retrofit kit for the device is supplied with the FHX50. The kit can be used to prepare the device so that the FHX50 can be used. </p> <p> i Use of the FHX50 may be restricted for transmitters with an approval. A device can only be retrofitted with the FHX50 if the option L, M or N ("Prepared for FHX50") is listed under <i>Basic specifications</i>, item 4 "Display, operation" in the Safety Instructions (XA) for the device. Also pay attention to the Safety Instructions (XA) of the FHX50. </p> <p> i Retrofitting is not possible on transmitters with: <ul style="list-style-type: none"> ▪ An approval for use in areas with flammable dust (dust ignition-proof approval) ▪ Ex nA type of protection </p> <p> i For details, see document SD01007F. </p>

1) This range is valid if option JN "Ambient temperature transmitter -50 °C (-58 °F)" has been selected in ordering feature 580 "Test, Certificate". If the temperature is permanently below -40 °C (-40 °F), failure rates may be increased.

16.1.7 Overvoltage protection

Accessories	Description
Overvoltage protection for 2-wire devices OVP10 (1-channel) OVP20 (2-channel)	<div data-bbox="327 324 715 660" style="text-align: center;"> </div> <div data-bbox="1380 667 1436 683" style="text-align: right; font-size: small;">A0021734</div> <p>Technical data</p> <ul style="list-style-type: none"> ■ Resistance per channel: $2 \times 0.5 \Omega_{\max}$ ■ Threshold DC voltage: 400 to 700 V ■ Threshold surge voltage: < 800 V ■ Capacitance at 1 MHz: < 1.5 pF ■ Nominal leakage current (8/20 μs): 10 kA ■ Suitable for conductor cross-sections: 0.2 to 2.5 mm² (24 to 14 AWG) <p>📘 Ordered with the device Ideally, the overvoltage protection module should be ordered directly with the device. See product structure, feature 610 "Accessory mounted", option NA "Overvoltage protection". Separate order necessary only if retrofitting.</p> <p>📘 Order numbers for retrofitting</p> <ul style="list-style-type: none"> ■ For 1-channel devices (feature 020, option A): OVP10: 71128617 ■ For 2-channel devices (feature 020, options B, C, E or G) OVP20: 71128619 <p>Housing cover for retrofitting In order to keep the necessary safety distances when using the surge arrester module, the housing cover also needs to be replaced when the device is retrofitted. Depending on the housing type, the suitable cover can be ordered using the following material number:</p> <ul style="list-style-type: none"> ■ Housing GT18: cover 71185516 ■ Housing GT19: cover 71185518 ■ Housing GT20: cover 71185517 <p>📘 Restrictions in case of retrofitting The use of the OVP module may be restricted depending on the transmitter approval. A device may only be retrofitted with the OVP module if the option NA (overvoltage protection) is listed under <i>Optional specifications</i> in the Safety Instructions (XA) associated with the device.</p> <p>📘 For details, see SD01090F.</p>

16.1.8 Bluetooth module for HART devices

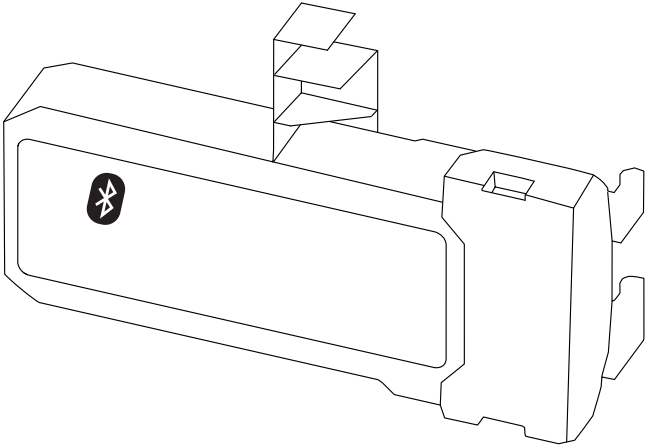
Accessory	Description
Bluetooth module	<div style="text-align: right; margin-bottom: 10px;">A0036493</div>  <ul style="list-style-type: none"> ▪ Quick and easy commissioning via SmartBlue (app) ▪ No additional tools or adapters required ▪ Signal curve via SmartBlue (app) ▪ Encrypted single point-to-point data transmission (tested by Fraunhofer institute) and password protected communication via Bluetooth® wireless technology ▪ Range under reference conditions: > 10 m (33 ft) <p>i When using the Bluetooth module the minimum supply voltage increases by up to 3 V.</p> <p>i Ordering with device The Bluetooth module is preferably ordered with the device. See product structure, feature 610 "Accessory Mounted", option NF "Bluetooth". A separate order is only necessary in case of retrofitting.</p> <p>i Order code for retrofitting Bluetooth module (BT10): 71377355</p> <p>i Restrictions in case of retrofitting Depending on the approval of the transmitter, application of the Bluetooth module may be restricted. A device may only be retrofitted with a Bluetooth module if the option <i>NF</i> (Bluetooth) is listed in the associated Safety Instructions (<i>XA</i>) under <i>Optional specifications</i>.</p> <p>i For details refer to SD02252F.</p>

16.2 Communication-specific accessories

Commubox FXA195 HART

For intrinsically safe HART communication with FieldCare via the USB interface



For details, see "Technical Information" TI00404F

Commubox FXA291

Connects Endress+Hauser field devices with a CDI interface (= Endress+Hauser Common Data Interface) and the USB port of a computer or laptop

Order number: 51516983



For details, see "Technical Information" TI00405C

HART Loop Converter HMX50

Is used to evaluate and convert dynamic HART process variables to analog current signals or limit values

Order number: 71063562



For details, see "Technical Information" TI00429F and Operating Instructions BA00371F

WirelessHART adapter SWA70

- Is used for the wireless connection of field devices
- The WirelessHART adapter can be easily integrated into field devices and existing infrastructures, offers data protection and transmission safety and can be operated in parallel with other wireless networks



For details, see Operating Instructions BA00061S

Connect Sensor FXA30/FXA30B

Fully integrated, battery-powered gateway for simple applications with SupplyCare Hosting. Up to 4 field devices with 4 to 20 mA communication (FXA30/FXA30B), serial Modbus (FXA30B) or HART (FXA30B) can be connected. With its robust design and ability to run for years on the battery, it is ideal for remote monitoring in isolated locations. Version with LTE (USA, Canada and Mexico only) or 3G mobile transmission for worldwide communication.



For details, see "Technical Information" TI01356S and Operating Instructions BA01710S.

Fieldgate FXA42

Fieldgates enable communication between connected 4 to 20 mA, Modbus RS485 and Modbus TCP devices and SupplyCare Hosting or SupplyCare Enterprise. The signals are transmitted either via Ethernet TCP/IP, WLAN or mobile communications (UMTS). Advanced automation capabilities are available, such as an integrated Web-PLC, OpenVPN and other functions.



For details, see "Technical Information" TI01297S and Operating Instructions BA01778S.

SupplyCare Enterprise SCE30B

Inventory management software that displays the level, volume, mass, temperature, pressure, density or other parameters of tanks. The parameters are recorded and transmitted by means of gateways like Fieldgate FXA42, Connect Sensor FXA30B or other gateway types.

This Web-based software is installed on a local server and can also be visualized and operated with mobile terminals such as a smartphone or tablet.



For details, see Technical Information TI01228S and Operating Instructions BA00055S

SupplyCare Hosting SCH30

Inventory management software that displays the level, volume, mass, temperature, pressure, density or other parameters of tanks. The parameters are recorded and

transmitted by means of gateways like Fieldgate FXA42, Connect Sensor FXA30B or other gateway types.

SupplyCare Hosting is offered as a hosting service (Software as a Service, SaaS). In the Endress+Hauser portal, the user is provided with the data over the Internet.

 For details, see Technical Information TI01229S and Operating Instructions BA00050S

Field Xpert SFX350

Field Xpert SFX350 is a mobile computer for commissioning and maintenance. It enables efficient device configuration and diagnostics for HART and FOUNDATION Fieldbus devices in the **non-Ex area**.

 For details, see Operating Instructions BA01202S

Field Xpert SFX370

Field Xpert SFX370 is a mobile computer for commissioning and maintenance. It enables efficient device configuration and diagnostics for HART and FOUNDATION Fieldbus devices in the **non-Ex area** and the **Ex area**.

 For details, see Operating Instructions BA01202S

16.3 Service-specific accessories

DeviceCare SFE100

Configuration tool for HART, PROFIBUS and FOUNDATION Fieldbus field devices

 Technical Information TI01134S

FieldCare SFE500

FDT-based plant asset management tool

It can configure all smart field units in your system and helps you manage them. By using the status information, it is also a simple but effective way of checking their status and condition.

 Technical Information TI00028S

16.4 System components

Memograph M graphic data manager

The Memograph M graphic data manager provides information on all the relevant process variables. Measured values are recorded correctly, limit values are monitored and measuring points analyzed. The data are stored in the 256 MB internal memory and also on a SD card or USB stick.

 Technical Information TI00133R and Operating Instructions BA00247R

RN221N

Active barrier with power supply for safe separation of 4 to 20 mA standard signal circuits. Offers bidirectional HART transmission.

 Technical Information TI00073R and Operating Instructions BA00202R

RN221





















Supply unit for powering two 2-wire measuring devices solely in the non-Ex area. Bidirectional communication is possible via the HART communication jacks.

























 Technical Information TI00081R and Brief Operating Instructions KA00110R

17 Operating menu

17.1 Overview of the operating menu (SmartBlue)

Navigation  SmartBlue

Setup	→  123
Device tag	→  123
Distance unit	→  123
Tank type	→  123
Tube diameter	→  124
Medium group	→  124
Empty calibration	→  125
Full calibration	→  125
Level	→  126
Distance	→  126
Signal quality	→  127
Confirm distance	→  128
Present mapping	→  129
Mapping end point	→  129
Record map	→  129
▶ Advanced setup	→  132
Locking status	→  132
Access status tooling	→  132
Enter access code	→  133
▶ Level	→  134
Medium type	→  134

Medium property	→  134
Process property	→  135
Advanced process conditions	→  136
Level unit	→  137
Blocking distance	→  137
Level correction	→  138
► Linearization	→  140
Linearization type	→  142
Unit after linearization	→  143
Free text	→  144
Level linearized	→  145
Maximum value	→  145
Diameter	→  145
Intermediate height	→  146
Table mode	→  146
Table number	→  147
Level	→  148
Level	→  148
Customer value	→  148
Activate table	→  148
► Probe settings	→  155
Probe grounded	→  155
Present probe length	→  155
Confirm probe length	→  156























▶ Safety settings	→ 150
Output echo lost	→ 150
Value echo lost	→ 150
Ramp at echo lost	→ 151
Blocking distance	→ 137
▶ Current output 1 to 2	→ 158
Assign current output	→ 158
Current span	→ 159
Fixed current	→ 159
Damping output	→ 160
Failure mode	→ 160
Failure current	→ 161
Output current 1 to 2	→ 161
▶ Switch output	→ 162
Switch output function	→ 162
Assign status	→ 163
Assign limit	→ 163
Assign diagnostic behavior	→ 163
Switch-on value	→ 164
Switch-on delay	→ 165
Switch-off value	→ 165
Switch-off delay	→ 166
Failure mode	→ 166























Switch status	→ 166
Invert output signal	→ 166
Diagnostics	→ 180
Actual diagnostics	→ 180
Timestamp	→ 180
Previous diagnostics	→ 180
Timestamp	→ 181
Operating time from restart	→ 181
Operating time	→ 174
► Diagnostic list	→ 182
Diagnostics 1 to 5	→ 182
Timestamp 1 to 5	→ 182
► Measured values	→ 187
Distance	→ 126
Level linearized	→ 145
Output current 1 to 2	→ 161
Measured current 1	→ 188
Terminal voltage 1	→ 188
► Device information	→ 184
Device tag	→ 184
Serial number	→ 184
Firmware version	→ 184
Device name	→ 184
Order code	→ 185
Extended order code 1 to 3	→ 185

Device revision	→ 185
Device ID	→ 185
Device type	→ 186
Manufacturer ID	→ 186
► Simulation	→ 193
Assign measurement variable	→ 194
Process variable value	→ 194
Current output 1 to 2 simulation	→ 194
Value current output 1 to 2	→ 195
Switch output simulation	→ 195
Switch status	→ 195
Device alarm simulation	→ 196





















17.2 Overview of the operating menu (display module)

Navigation  Operating menu

























Language	→  168
Setup	→  123
Device tag	→  123
Distance unit	→  123
Tank type	→  123
Tube diameter	→  124
Medium group	→  124
Empty calibration	→  125
Full calibration	→  125
Level	→  126
Distance	→  126
Signal quality	→  127
Mapping	→  131
Confirm distance	→  131
Mapping end point	→  131
Record map	→  131
Distance	→  131
Advanced setup	→  132
Locking status	→  132
Access status display	→  133
Enter access code	→  133
Level	→  134
Medium type	→  134

Medium property	→  134
Process property	→  135
Advanced process conditions	→  136
Level unit	→  137
Blocking distance	→  137
Level correction	→  138
► Linearization	→  140
Linearization type	→  142
Unit after linearization	→  143
Free text	→  144
Maximum value	→  145
Diameter	→  145
Intermediate height	→  146
Table mode	→  146
► Edit table	
Level	→  148
Customer value	→  148
Activate table	→  148
► Safety settings	→  150
Output echo lost	→  150
Value echo lost	→  150
Ramp at echo lost	→  151
Blocking distance	→  137
► SIL/WHG confirmation	→  153

▶ Deactivate SIL/WHG	→ 154
Reset write protection	→ 154
Code incorrect	→ 154
▶ Probe settings	→ 155
Probe grounded	→ 155
▶ Probe length correction	→ 157
Confirm probe length	→ 157
Present probe length	→ 157
▶ Current output 1 to 2	→ 158
Assign current output	→ 158
Current span	→ 159
Fixed current	→ 159
Damping output	→ 160
Failure mode	→ 160
Failure current	→ 161
Output current 1 to 2	→ 161
▶ Switch output	→ 162
Switch output function	→ 162
Assign status	→ 163
Assign limit	→ 163
Assign diagnostic behavior	→ 163
Switch-on value	→ 164
Switch-on delay	→ 165
Switch-off value	→ 165
Switch-off delay	→ 166

Failure mode	→  166
Switch status	→  166
Invert output signal	→  166
► Display	→  168
Language	→  168
Format display	→  168
Value 1 to 4 display	→  170
Decimal places 1 to 4	→  170
Display interval	→  170
Display damping	→  171
Header	→  171
Header text	→  172
Separator	→  172
Number format	→  172
Decimal places menu	→  172
Backlight	→  173
Contrast display	→  173
► Configuration backup display	→  174
Operating time	→  174
Last backup	→  174

Configuration management	→ 174
Comparison result	→ 175
▶ Administration	→ 177
▶ Define access code	→ 179
Define access code	→ 179
Confirm access code	→ 179
Device reset	→ 177
🔍 Diagnostics	→ 180
Actual diagnostics	→ 180
Previous diagnostics	→ 180
Operating time from restart	→ 181
Operating time	→ 174
▶ Diagnostic list	→ 182
Diagnostics 1 to 5	→ 182
▶ Event logbook	→ 183
Filter options	→ 183
▶ Event list	→ 183
▶ Device information	→ 184
Device tag	→ 184
Serial number	→ 184
Firmware version	→ 184
Device name	→ 184
Order code	→ 185
Extended order code 1 to 3	→ 185
Device revision	→ 185

Device ID	→  185
Device type	→  186
Manufacturer ID	→  186
▶ Measured values	→  187
Distance	→  126
Level linearized	→  145
Output current 1 to 2	→  161
Measured current 1	→  188
Terminal voltage 1	→  188
▶ Data logging	→  189
Assign channel 1 to 4	→  189
Logging interval	→  190
Clear logging data	→  190
▶ Display channel 1 to 4	→  191
▶ Simulation	→  193
Assign measurement variable	→  194
Process variable value	→  194
Current output 1 to 2 simulation	→  194
Value current output 1 to 2	→  195
Switch output simulation	→  195
Switch status	→  195
Device alarm simulation	→  196
▶ Device check	→  197
Start device check	→  197
Result device check	→  197

Last check time	→ 197
Level signal	→ 198
Launch signal	→ 198

17.3 Overview of the operating menu (operating tool)

Navigation























Operating menu

























Setup	→ 123
Device tag	→ 123
Distance unit	→ 123
Tank type	→ 123
Tube diameter	→ 124
Medium group	→ 124
Empty calibration	→ 125
Full calibration	→ 125
Level	→ 126
Distance	→ 126
Signal quality	→ 127
Confirm distance	→ 128
Present mapping	→ 129
Mapping end point	→ 129
Record map	→ 129
▶ Advanced setup	→ 132
Locking status	→ 132
Access status tooling	→ 132
Enter access code	→ 133
▶ Level	→ 134
Medium type	→ 134
Medium property	→ 134
Process property	→ 135



Advanced process conditions	→ 136
Level unit	→ 137
Blocking distance	→ 137
Level correction	→ 138
► Linearization	→ 140
Linearization type	→ 142
Unit after linearization	→ 143
Free text	→ 144
Level linearized	→ 145
Maximum value	→ 145
Diameter	→ 145
Intermediate height	→ 146
Table mode	→ 146
Table number	→ 147
Level	→ 148
Level	→ 148
Customer value	→ 148
Activate table	→ 148
► Safety settings	→ 150
Output echo lost	→ 150
Value echo lost	→ 150
Ramp at echo lost	→ 151
Blocking distance	→ 137
► SIL/WHG confirmation	→ 153

▶ Deactivate SIL/WHG	→ 154
Reset write protection	→ 154
Code incorrect	→ 154
▶ Probe settings	→ 155
Probe grounded	→ 155
Present probe length	→ 155
Confirm probe length	→ 156
▶ Current output 1 to 2	→ 158
Assign current output	→ 158
Current span	→ 159
Fixed current	→ 159
Damping output	→ 160
Failure mode	→ 160
Failure current	→ 161
Output current 1 to 2	→ 161
▶ Switch output	→ 162
Switch output function	→ 162
Assign status	→ 163
Assign limit	→ 163
Assign diagnostic behavior	→ 163
Switch-on value	→ 164
Switch-on delay	→ 165
Switch-off value	→ 165
Switch-off delay	→ 166
Failure mode	→ 166



Switch status	→  166
Invert output signal	→  166
► Display	→  168
Language	→  168
Format display	→  168
Value 1 to 4 display	→  170
Decimal places 1 to 4	→  170
Display interval	→  170
Display damping	→  171
Header	→  171
Header text	→  172
Separator	→  172
Number format	→  172
Decimal places menu	→  172
Backlight	→  173
Contrast display	→  173
► Configuration backup display	→  174
Operating time	→  174
Last backup	→  174
Configuration management	→  174

Backup state	→ 📄 175
Comparison result	→ 📄 175
▶ Administration	→ 📄 177
Define access code	→ 📄 179
Device reset	→ 📄 177
🔍 Diagnostics	→ 📄 180
Actual diagnostics	→ 📄 180
Timestamp	→ 📄 180
Previous diagnostics	→ 📄 180
Timestamp	→ 📄 181
Operating time from restart	→ 📄 181
Operating time	→ 📄 174
▶ Diagnostic list	→ 📄 182
Diagnostics 1 to 5	→ 📄 182
Timestamp 1 to 5	→ 📄 182
▶ Device information	→ 📄 184
Device tag	→ 📄 184
Serial number	→ 📄 184
Firmware version	→ 📄 184
Device name	→ 📄 184
Order code	→ 📄 185
Extended order code 1 to 3	→ 📄 185
Device revision	→ 📄 185
Device ID	→ 📄 185

Device type	→  186
Manufacturer ID	→  186
► Measured values	→  187
Distance	→  126
Level linearized	→  145
Output current 1 to 2	→  161
Measured current 1	→  188
Terminal voltage 1	→  188
► Data logging	→  189
Assign channel 1 to 4	→  189
Logging interval	→  190
Clear logging data	→  190
► Simulation	→  193
Assign measurement variable	→  194
Process variable value	→  194
Current output 1 to 2 simulation	→  194
Value current output 1 to 2	→  195
Switch output simulation	→  195
Switch status	→  195
Device alarm simulation	→  196
► Device check	→  197
Start device check	→  197
Result device check	→  197
Last check time	→  197



Level signal	→  198
Launch signal	→  198
▶ Heartbeat	→  199

17.4 "Setup" menu



- i
 - : Indicates navigation to the parameter via the display and operating module
 - : Indicates navigation to the parameter via operating tools (e.g. FieldCare)
 - : Indicates parameters that can be locked via the access code.

Navigation   Setup



Device tag

Navigation	  Setup → Device tag
Description	Enter a unique name for the measuring point to identify the device quickly within the plant.
Factory setting	FMP5x

Distance unit



Navigation	  Setup → Distance unit	
Description	Used for the basic calibration (Empty / Full).	
Selection	<i>SI units</i> <ul style="list-style-type: none"> ▪ mm ▪ m 	<i>US units</i> <ul style="list-style-type: none"> ▪ ft ▪ in
Factory setting	m	

Tank type



Navigation	  Setup → Tank type
Prerequisite	Medium type (→  134) = Liquid
Description	Select tank type.
Selection	<ul style="list-style-type: none"> ▪ Metallic ▪ Bypass / pipe ▪ Non metallic ▪ Mounted outside ▪ Coaxial
Factory setting	Depending on the probe

- Additional information**
- Depending on the probe some of the options mentioned above may not be available or there may be additional options.
 - For coax probes and probes with metallic center washer **Tank type** parameter corresponds to the type of probe and cannot be changed.

Tube diameter 

- Navigation**   Setup → Tube diameter
- Prerequisite** **Tank type** (→  123) = Bypass / pipe
- Description** Specify diameter of bypass or stilling well.
- User entry** 0 to 9.999 m
- Factory setting** 0.0384 m



Medium group 

- Navigation**   Setup → Medium group
- Prerequisite** **Medium type** (→  134) = Liquid
- Description** Select medium group.
- Selection**
 - Others
 - Water based (DC >= 4)
- Factory setting** Others
- Additional information**

This parameter roughly specifies the dielectric constant (DC) of the medium. For a more detailed definition of the DC use the **Medium property** parameter (→  134).

The **Medium group** parameter presets the **Medium property** parameter (→  134) as follows:

Medium group	Medium property (→  134)
Others	Unknown
Water based (DC >= 4)	DC 4 ... 7

-  The **Medium property** parameter can be changed at a later point of time. However, when doing so, the **Medium group** parameter retains its value. Only the **Medium property** parameter is relevant for the signal evaluation.
-  The measuring range may be reduced for small dielectric constants. For details refer to the Technical Information (TI) of the respective device.

Empty calibration

**Navigation** Setup → Empty calibr.**Description**

Distance between process connection and minimum level (0%).

User entry

Depending on the probe

Factory setting

Depending on the probe

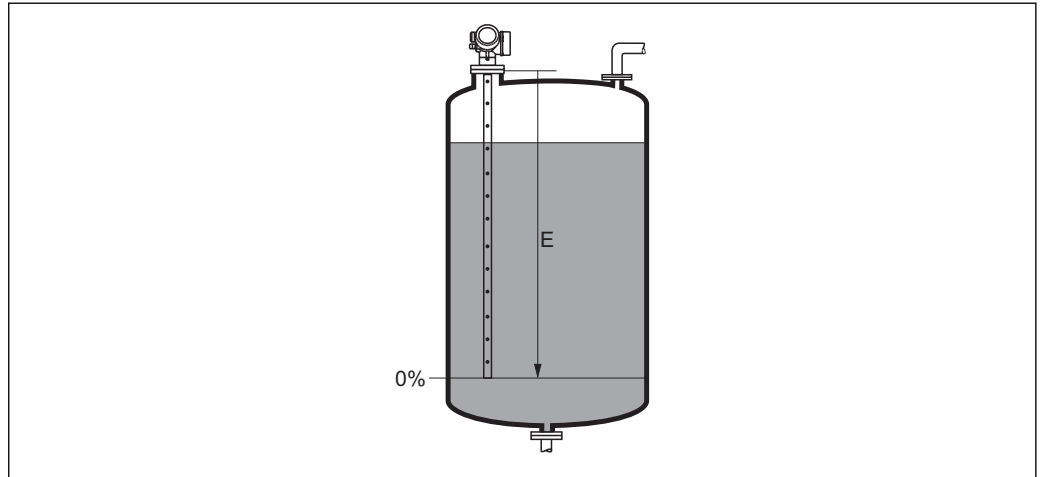
Additional information

A0013178

 39 *Empty calibration (E) for level measurements in liquids*

Full calibration

**Navigation** Setup → Full calibr.**Description**

Distance between minimum level (0%) and maximum level (100%).

User entry

Depending on the probe

Factory setting

Depending on the probe

Additional information

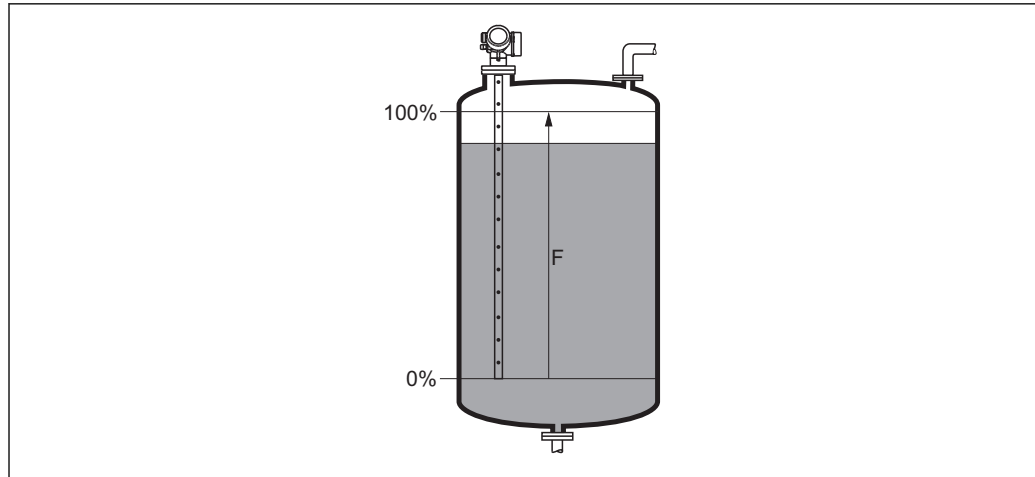

A0013186

40 Full calibration (F) for level measurements in liquids

Level

Navigation

Setup → Level

Description

Displays measured level L_L (before linearization).

Additional information

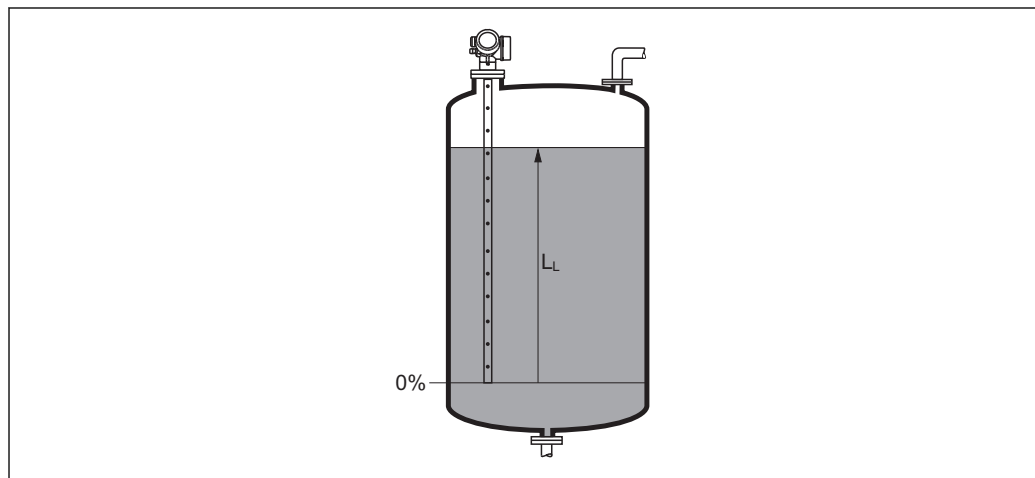

A0013194

41 Level in case of liquid measurements

i The unit is defined in the **Level unit** parameter (→ 137).

Distance

Navigation

Setup → Distance

Description

Displays the measured distance D_L between the reference point (lower edge of the flange or threaded connection) and the level.

Additional information

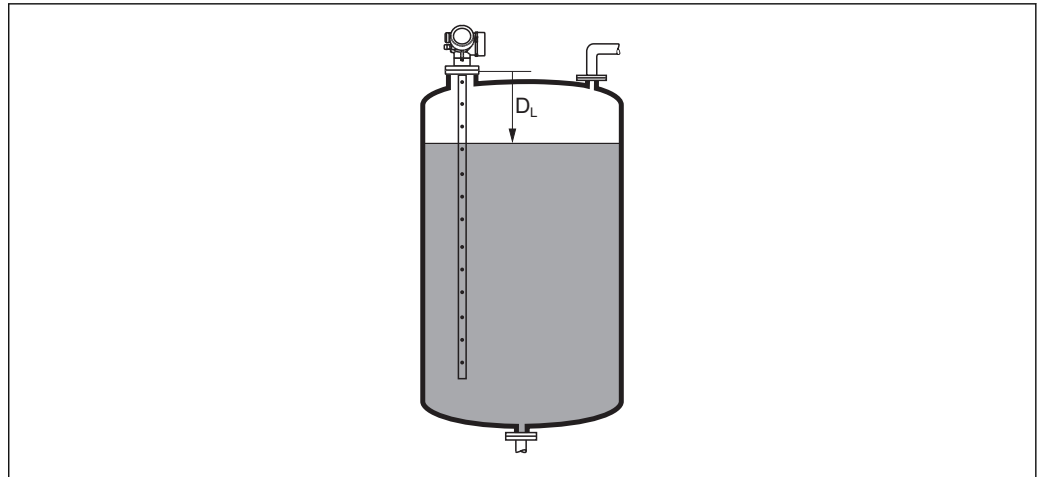

A0013198

42 Distance for liquid measurements

i The unit is defined in the **Distance unit** parameter (→ 123).

Signal quality

Navigation

Setup → Signal quality

Description

Displays the signal quality of the evaluated echo.

Additional information

Meaning of the display options

- **Strong**
The evaluated echo exceeds the threshold by at least 10 mV.
- **Medium**
The evaluated echo exceeds the threshold by at least 5 mV.
- **Weak**
The evaluated echo exceeds the threshold by less than 5 mV.
- **No signal**
The device does not find a usable echo.

The signal quality indicated in this parameter always refers to the currently evaluated echo: either the level/interface echo³⁾ or the end-of-probe echo. To differentiate between these two, the quality of the end-of-probe echo is always displayed in brackets.

i In case of a lost echo (**Signal quality = No signal**) the device generates the following error message:

- F941, for **Output echo lost** (→ 150) = **Alarm**.
- S941, if another option has been selected in **Output echo lost** (→ 150).

3) Of these two echos the one with the lower quality is indicated.

Confirm distance
**Navigation**

Setup → Confirm distance

Description

Specify, whether the measured distance matches the real distance.
Depending on the selection the device automatically sets the range of mapping.

Selection

- Manual map
- Distance ok
- Distance unknown
- Distance too small^{*}
- Distance too big^{*}
- Tank empty
- Delete map

Factory setting

Distance unknown

Additional information**Meaning of the options**

- **Manual map**

To be selected if the range of mapping is to be defined manually in the **Mapping end point** parameter (→ 129). In this case it is not necessary to confirm the distance.

- **Distance ok**

To be selected if the measured distance matches the actual distance. The device performs a mapping.

- **Distance unknown**

To be selected if the actual distance is unknown. A mapping can not be performed in this case.

- **Distance too small**

To be selected if the measured distance is smaller than the actual distance. The device searches for the next echo and returns to the **Confirm distance** parameter. The distance is recalculated and displayed. The comparison must be repeated until the displayed distance matches the actual distance. After this, the recording of the map can be started by selecting **Distance ok**.

- **Distance too big**⁴⁾

To be selected if the measured distance exceeds the actual distance. The device adjusts the signal evaluation and returns to the **Confirm distance** parameter. The distance is recalculated and displayed. The comparison must be repeated until the displayed distance matches the actual distance. After this, the recording of the map can be started by selecting **Distance ok**.

- **Tank empty**

To be selected if the tank is completely empty. The device records a mapping covering the complete measuring range.

To be selected if the tank is completely empty. The device records a mapping covering the complete measuring range minus **Map gap to LN**.

- **Factory map**

To be selected if the present mapping curve (if one exists) is to be deleted. The device returns to the **Confirm distance** parameter and a new mapping can be recorded.



When operating via the display module, the measured distance is displayed together with this parameter for reference purposes.



If the teaching procedure with the **Distance too small** option or the **Distance too big** option is quit before the distance has been confirmed, a map is **not** recorded and the teaching procedure is reset after 60 s.





* Visibility depends on order options or device settings

4) Only available for "Expert → Sensor → Echo tracking → **Evaluation mode** parameter" = "Short time history" or "Long time history"



Present mapping

Navigation	 Setup → Present mapping
Description	Indicates up to which distance a mapping has already been recorded.

Mapping end point

Navigation	 Setup → Map. end point
Prerequisite	Confirm distance (→  128) = Manual map or Distance too small
Description	Specify new end of the mapping.
User entry	0 to 200 000.0 m
Factory setting	0.1 m
Additional information	<p>This parameter defines up to which distance the new mapping is to be recorded. The distance is measured from the reference point, i.e. from the lower edge of the mounting flange or the threaded connection.</p> <p> For reference purposes the Present mapping parameter (→  129) is displayed together with this parameter. It indicates up to which distance a mapping has already been recorded.</p>

Record map

Navigation	 Setup → Record map
Prerequisite	Confirm distance (→  128) = Manual map or Distance too small
Description	Start recording of the map.
Selection	<ul style="list-style-type: none"> ■ No ■ Record map ■ Delete map
Factory setting	No

Additional information**Meaning of the options****■ No**

The map is not recorded.



■ Record map

The map is recorded. After the recording is completed, the new measured distance and the new mapping range appear on the display. When operating via the local display, these values must be confirmed by pressing .

■ Delete map

The mapping (if one exists) is deleted and the device displays the recalculated measured distance and the mapping range. When operating via the local display, these values must be confirmed by pressing .

17.4.1 "Mapping" wizard

-  The **Mapping** wizard is only available when operating via the local display. When operating via an operating tool, all parameters concerning the mapping are located directly in the **Setup** menu (→  123).
-  In the **Mapping** wizard two parameters are displayed simultaneously on the display module at any one time. The upper parameter can be edited, whereas the lower parameter is displayed for reference purposes only.

Navigation  Setup → Mapping

Confirm distance

Navigation  Setup → Mapping → Confirm distance

Description →  128

Mapping end point

Navigation  Setup → Mapping → Map. end point

Description →  129

Record map

Navigation  Setup → Mapping → Record map

Description →  129

Distance





Navigation  Setup → Mapping → Distance

Description →  126





17.4.2 "Advanced setup" submenu

Navigation  Setup → Advanced setup





Locking status

Navigation	  Setup → Advanced setup → Locking status
Description	Indicates the write protection with the highest priority that is currently active.
User interface	<ul style="list-style-type: none"> ▪ Hardware locked ▪ SIL locked ▪ CT active - defined parameters ▪ WHG locked ▪ Temporarily locked
Additional information	<p>Meaning and priorities of the types of write protection</p> <ul style="list-style-type: none"> ▪ Hardware locked (priority 1) The DIP switch for hardware locking is activated on the main electronics module. This locks write access to the parameters. ▪ SIL locked (priority 2) The SIL mode is activated. Writing access to the relevant parameters is denied. ▪ WHG locked (priority 3) The WHG mode is activated. Writing access to the relevant parameters is denied. ▪ Temporarily locked (priority 4) Write access to the parameters is temporarily locked on account of internal processes in progress in the device (e.g. data upload/download, reset etc.). The parameters can be modified as soon as the processes are complete. <p> On the display module, the -symbol appears in front of parameters that cannot be modified since they are write-protected.</p>





Access status tooling

Navigation	 Setup → Advanced setup → Access stat.tool
Description	Shows the access authorization to the parameters via the operating tool.
Additional information	<p> The access authorization can be changed via the Enter access code parameter (→  133).</p> <p> If additional write protection is active, this restricts the current access authorization even further. The write protection status can be viewed via the Locking status parameter (→  132).</p>

Access status display

Navigation	 Setup → Advanced setup → Access stat.disp
Prerequisite	The device has a local display.
Description	Indicates access authorization to parameters via local display.
Additional information	<p> The access authorization can be changed via the Enter access code parameter (→  133).</p> <p> If additional write protection is active, this restricts the current access authorization even further. The write protection status can be viewed via the Locking status parameter (→  132).</p>

Enter access code

Navigation	 Setup → Advanced setup → Ent. access code
Description	Enter access code to disable write protection of parameters.
User entry	0 to 9999
Additional information	<ul style="list-style-type: none"> ▪ For local operation, the customer-specific access code, which has been defined in the Define access code parameter (→  177), has to be entered. ▪ If an incorrect access code is entered, the user retains his current access authorization. ▪ The write protection affects all parameters marked with the -symbol in this document. On the local display, the -symbol in front of a parameter indicates that the parameter is write-protected. ▪ If no key is pressed for 10 min, or the user switches from the navigation and editing mode back to the measured value display mode, the device automatically locks the write-protected parameters after another 60 s. <p> Please contact your Endress+Hauser Sales Center if you lose your access code.</p>

"Level" submenu

Navigation  Setup → Advanced setup → Level

Medium type **Navigation**

 Setup → Advanced setup → Level → Medium type

Description

Specify type of medium.

User interface

- Liquid
- Solid

Factory setting

FMP50, FMP51, FMP52, FMP53, FMP54, FMP55: **Liquid**

Additional information

 This parameter determines the value of several other parameters and strongly influences the complete signal evaluation. Therefore, it is strongly recommended **not to change** the factory setting.

Medium property **Navigation**

 Setup → Advanced setup → Level → Medium property

Prerequisite

EOP level evaluation ≠ Fix DC



Description

Specify relative dielectric constant ϵ_r of the medium.

Selection

- Unknown
- DC 1.4 ... 1.6
- DC 1.6 ... 1.9
- DC 1.9 ... 2.5
- DC 2.5 ... 4
- DC 4 ... 7
- DC 7 ... 15
- DC > 15

Factory setting

Dependent on **Medium type** (→  134) and **Medium group** (→  124).

Additional information

Dependency on "Medium type" and "Medium group"

Medium type (→ ⓘ 134)	Medium group (→ ⓘ 124)	Medium property
Solid		Unknown
Liquid	Water based (DC >= 4)	DC 4 ... 7
	Others	Unknown

-  For dielectric constants (DC values) of many media commonly used in various industries refer to:
 - the Endress+Hauser DC manual (CP01076F)
 - the Endress+Hauser "DC Values App" (available for Android and iOS)

-  For **EOP level evaluation = Fix DC**, the exact dielectric constant has to be entered into the **DC value** parameter. Therefore, the **Medium property** parameter is not available in this case.

Process property



Navigation

  Setup → Advanced setup → Level → Process property

Description

Specify typical rate of level change.

Selection

- For "Medium type" = "Liquid"**
- Very fast > 10 m (400 in)/min
 - Fast > 1 m (40 in)/min
 - Standard < 1 m (40in) /min
 - Medium < 10 cm (4in) /min
 - Slow < 1 cm (0.4in) /min
 - No filter / test
- For "Medium type" = "Solid"**
- Very fast > 100 m (333 ft) /h
 - Fast > 10 m (33 ft) /h
 - Standard < 10 m (33 ft) /h
 - Medium < 1 m (3ft) /h
 - Slow < 0.1 m (0.3ft) /h
 - No filter / test

Factory setting

Standard < 1 m (40in) /min

Additional information

The device adjusts the signal evaluation filters and the damping of the output signal to the typical rate of level change defined in this parameter:

For "Operating mode" = "Level" and "Medium type" = "Liquid"

Process property	Step response time / s
Very fast > 10 m (400 in)/min	5
Fast > 1 m (40 in)/min	5
Standard < 1 m (40in) /min	14
Medium < 10 cm (4in) /min	39
Slow < 1 cm (0.4in) /min	76
No filter / test	< 1

For "Operating mode" = "Level" and "Medium type" = "Solid"

Process property	Step response time / s
Very fast > 100 m (333 ft) /h	37
Fast > 10 m (33 ft) /h	37
Standard < 10 m (33 ft) /h	74
Medium < 1 m (3ft) /h	146
Slow < 0.1 m (0.3ft) /h	290
No filter / test	< 1

For "Operating mode" = "Interface" or "Interface with capacitance"

Process property	Step response time / s
Very fast > 10 m (400 in)/min	5
Fast > 1 m (40 in)/min	5
Standard < 1 m (40in) /min	23
Medium < 10 cm (4in) /min	47
Slow < 1 cm (0.4in) /min	81
No filter / test	2.2

Advanced process conditions



Navigation

Setup → Advanced setup → Level → Adv. conditions

Description

Specify additional process conditions (if required).

Selection

- None
- Oil/Water condensate
- Probe near tank bottom
- Build up
- Foam (>5cm/0,16ft)

Factory setting

None

Additional information

Meaning of the options

- **Oil/Water condensate** (only **Medium type = Liquid**)
Makes sure that in the case of two-phase media only the total level is detected (example: oil/condensate application).
- **Probe near tank bottom** (only for **Medium type = Liquid**)
Improves the empty detection, especially if the probe is mounted close to the tank bottom.
- **Build up**
Increases **EOP range upper area** in order to ensure a safe empty-detection even if the end-of-probe signal has shifted due to build-up.
Enables a safe empty-detection even if the end-of-probe signal has shifted due to build-up.
- **Foam (>5cm/0,16ft)** (only for **Medium type = Liquid**)
Optimizes the signal evaluation in applications with foam formation.

Level unit



Navigation	Setup → Advanced setup → Level → Level unit	
Description	Select level unit.	
Selection	<i>SI units</i> <ul style="list-style-type: none"> ■ % ■ m ■ mm 	<i>US units</i> <ul style="list-style-type: none"> ■ ft ■ in
Factory setting	%	
Additional information	<p>The level unit may differ from the distance unit defined in the Distance unit parameter (→ 123):</p> <ul style="list-style-type: none"> ■ The unit defined in the Distance unit parameter is used for the basic calibration (Empty calibration (→ 125) and Full calibration (→ 125)). ■ The unit defined in the Level unit parameter is used to display the (nonlinearized) level. 	

Blocking distance



Navigation	Setup → Advanced setup → Level → Blocking dist.	
Description	Specify upper blocking distance UB.	
User entry	0 to 200 m	
Factory setting	For rod and rope probes up to 8 m (26 ft): 200 mm (8 in)	
Additional information	<p>Signals in the upper blocking distance are only evaluated if they have been outside the blocking distance when the device was switched on and move into the blocking distance due to a level change during operation. Signals which are already in the blocking distance when the device is switched on, are ignored.</p> <p> This behavior is only valid if the following two conditions are met:</p> <ul style="list-style-type: none"> ■ Expert → Sensor → Echo tracking → Evaluation mode = Short time history or Long time history) ■ Expert → Sensor → Gas phase compensation → GPC mode= On, Without correction or External correction <p>If one of these conditions is not met, signals in the blocking distance will always be ignored.</p> <p> A different behavior for signals in the blocking distance can be defined in the Blocking distance evaluation mode parameter.</p> <p> If required, a different behavior for signals in the blocking distance can be defined by the Endress+Hauser service.</p>	

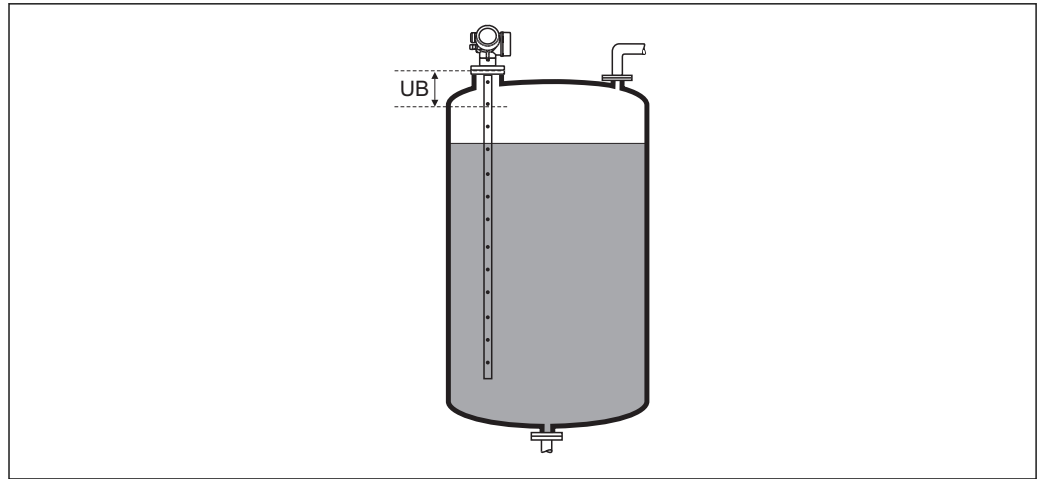

A0013219

43 Blocking distance (UB) for liquid measurements

Level correction



Navigation

Setup → Advanced setup → Level → Level correction

Description

Specify level correction (if required).

User entry

-200 000.0 to 200 000.0 %

Factory setting

0.0 %

Additional information

The value specified in this parameter is added to the measured level (before linearization).

"Linearization" submenu

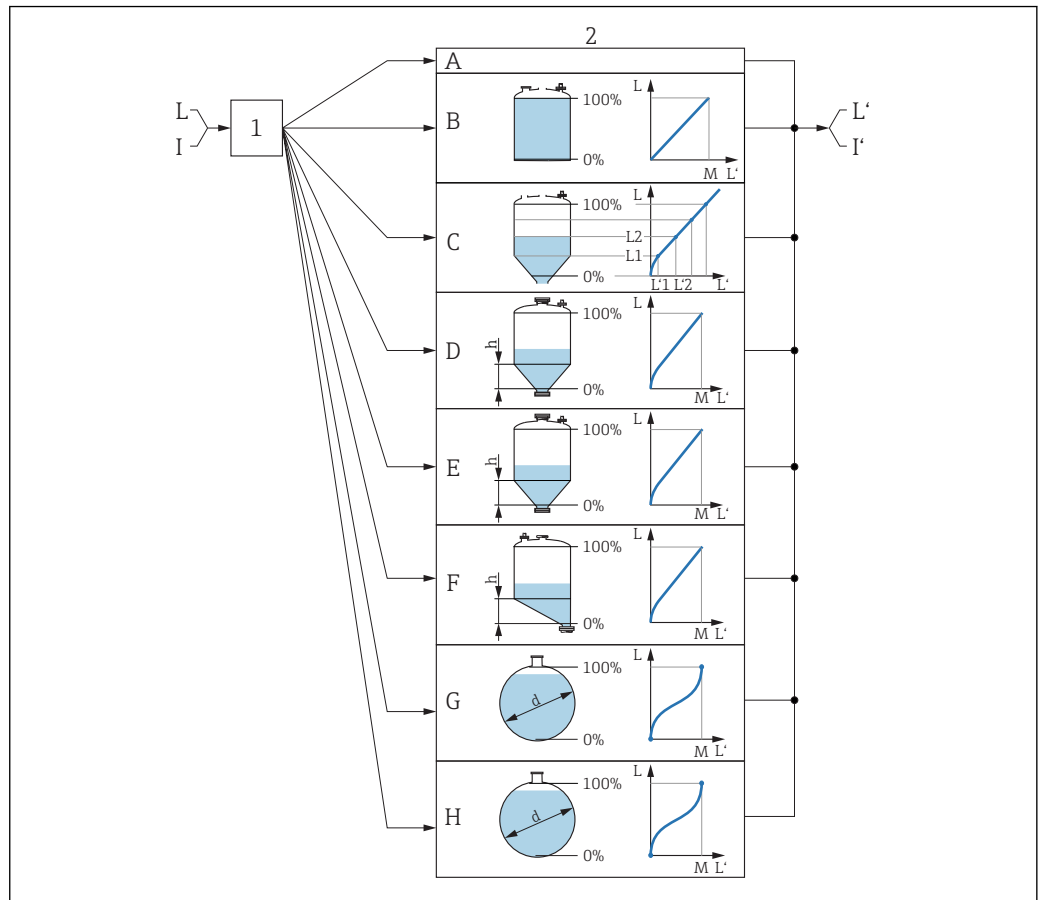











A0016084

44 Linearization: Conversion of the level and, if applicable, interface into a volume or a weight; the conversion depends on the vessel shape

- 1 Selection of linearization type and unit
- 2 Configuration of the linearization
- A Linearization type (→ 142) = None
- B Linearization type (→ 142) = Linear
- C Linearization type (→ 142) = Table
- D Linearization type (→ 142) = Pyramid bottom
- E Linearization type (→ 142) = Conical bottom
- F Linearization type (→ 142) = Angled bottom
- G Linearization type (→ 142) = Horizontal cylinder
- H Linearization type (→ 142) = Sphere
- I For "Operating mode" = "Interface" or "Interface with capacitance": Interface before linearization (measured in level unit)
- I' For "Operating mode" = "Interface" or "Interface with capacitance": Interface after linearization (corresponds to volume or weight)
- L Level before linearization (measured in level unit)
- L' Level linearized (→ 145) (corresponds to volume or weight)
- M Maximum value (→ 145)
- d Diameter (→ 145)
- h Intermediate height (→ 146)













Structure of the submenu on the local display

Navigation  Setup → Advanced setup → Linearization

▶ Linearization		
Linearization type		→  142
Unit after linearization		→  143
Free text		→  144
Maximum value		→  145
Diameter		→  145
Intermediate height		→  146
Table mode		→  146
▶ Edit table		
	Level	→  148
	Customer value	→  148
	Activate table	→  148

Structure of the submenu in the operating tool (e.g. FieldCare)

Navigation  Setup → Advanced setup → Linearization

► Linearization	
Linearization type	→  142
Unit after linearization	→  143
Free text	→  144
Level linearized	→  145
Maximum value	→  145
Diameter	→  145
Intermediate height	→  146
Table mode	→  146
Table number	→  147
Level	→  148
Level	→  148
Customer value	→  148
Activate table	→  148

Description of the parameters

Navigation  Setup → Advanced setup → Linearization

Linearization type 

Navigation  Setup → Advanced setup → Linearization → Lineariz. type

Description Select linearization type.

- Selection**
- None
 - Linear
 - Table
 - Pyramid bottom
 - Conical bottom
 - Angled bottom
 - Horizontal cylinder
 - Sphere

Factory setting None

Additional information

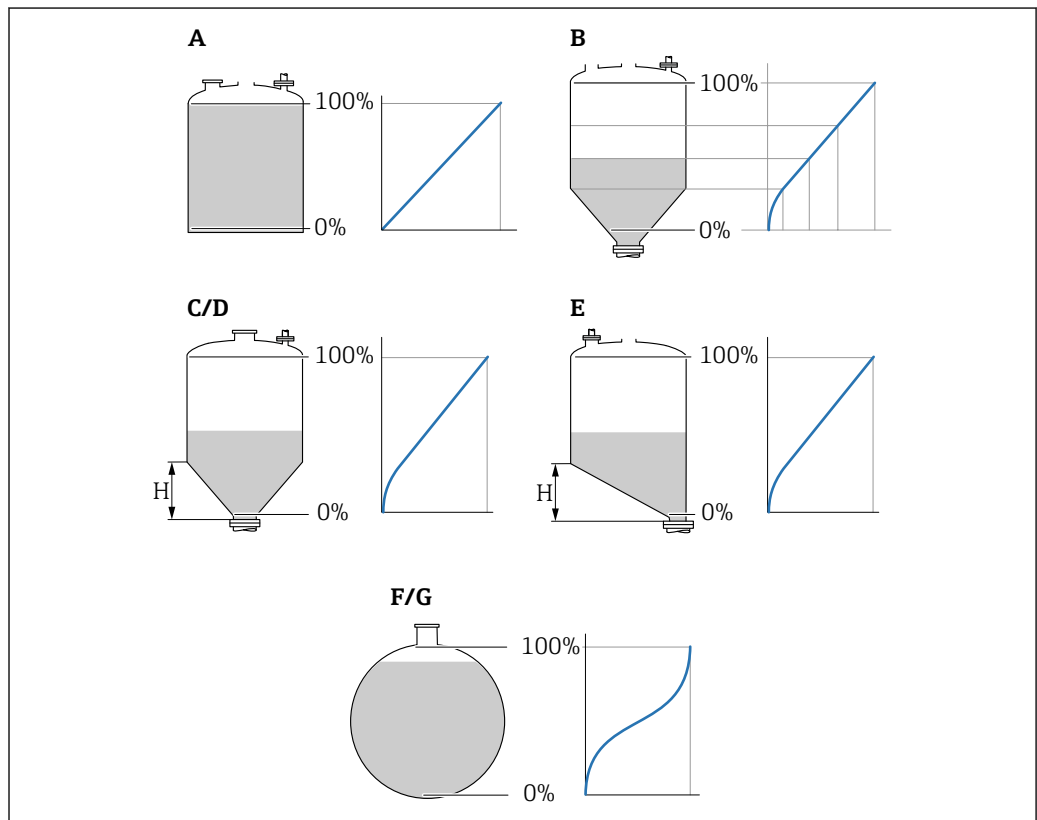

A0021476

 45 *Linearization types*

- A None
- B Table
- C Pyramid bottom
- D Conical bottom
- E Angled bottom
- F Sphere
- G Horizontal cylinder



Meaning of the options

■ None

The level is output in the level unit without being converted (linearized) beforehand.





■ Linear

The output value (volume/weight) is proportional to the level L. This applies, for example, to vertical cylindrical tanks and silos. The following parameters must also be specified:

- **Unit after linearization** (→  143)
- **Maximum value** (→  145): Maximum volume or weight



■ Table

The relationship between the measured level L and the output value (volume/weight) is defined by a linearization table consisting of up to 32 pairs of values "level - volume" or "level - weight" respectively. The following parameters must also be defined:

- **Unit after linearization** (→  143)
- **Table mode** (→  146)
- For each table point: **Level** (→  148)
- For each table point: **Customer value** (→  148)
- **Activate table** (→  148)



■ Pyramid bottom

The output value corresponds to the volume or weight in a silo with a pyramid bottom. The following parameters must also be defined:

- **Unit after linearization** (→  143)
- **Maximum value** (→  145): Maximum volume or weight
- **Intermediate height** (→  146): The height of the pyramid



■ Conical bottom

The output value corresponds to the volume or weight in a tank with a conical bottom. The following parameters must also be defined:

- **Unit after linearization** (→  143)
- **Maximum value** (→  145): Maximum volume or weight
- **Intermediate height** (→  146): The height of the conical part



■ Angled bottom

The output value corresponds to the volume or weight in a silo with an angled bottom. The following parameters must also be defined:

- **Unit after linearization** (→  143)
- **Maximum value** (→  145): Maximum volume or weight
- **Intermediate height** (→  146): The height of the angled bottom



■ Horizontal cylinder

The output value corresponds to the volume or weight in a horizontal cylinder. The following parameters must also be defined:

- **Unit after linearization** (→  143)
- **Maximum value** (→  145): Maximum volume or weight
- **Diameter** (→  145)

■ Sphere



The output value corresponds to the volume or weight in a spherical tank. The following parameters must also be defined:

- **Unit after linearization** (→  143)
- **Maximum value** (→  145): Maximum volume or weight
- **Diameter** (→  145)

Unit after linearization







Navigation

  Setup → Advanced setup → Linearization → Unit lineariz.



Prerequisite

Linearization type (→  142) ≠ None



Description	Select the unit for the linearized value.
Selection	<p>Selection/input (uint16)</p> <ul style="list-style-type: none"> ▪ 1095 = [short Ton] ▪ 1094 = [lb] ▪ 1088 = [kg] ▪ 1092 = [Ton] ▪ 1048 = [US Gal.] ▪ 1049 = [Imp. Gal.] ▪ 1043 = [ft³] ▪ 1571 = [cm³] ▪ 1035 = [dm³] ▪ 1034 = [m³] ▪ 1038 = [l] ▪ 1041 = [hl] ▪ 1342 = [%] ▪ 1010 = [m] ▪ 1012 = [mm] ▪ 1018 = [ft] ▪ 1019 = [inch] ▪ 1351 = [l/s] ▪ 1352 = [l/min] ▪ 1353 = [l/h] ▪ 1347 = [m³/s] ▪ 1348 = [m³/min] ▪ 1349 = [m³/h] ▪ 1356 = [ft³/s] ▪ 1357 = [ft³/min] ▪ 1358 = [ft³/h] ▪ 1362 = [US Gal./s] ▪ 1363 = [US Gal./min] ▪ 1364 = [US Gal./h] ▪ 1367 = [Imp. Gal./s] ▪ 1358 = [Imp. Gal./min] ▪ 1359 = [Imp. Gal./h] ▪ 32815 = [Ml/s] ▪ 32816 = [Ml/min] ▪ 32817 = [Ml/h] ▪ 1355 = [Ml/d]
Factory setting	%
Additional information	<p>The selected unit is only used for display purposes. The measured value is not converted on the basis of the selected unit.</p> <p> Distance-to-distance linearization is also possible, i.e. a linearization from the level unit to another length unit. Select the Linear linearization mode for this purpose. To specify the new level unit, select the Free text option in the Unit after linearization parameter and enter the unit in the Free text parameter (→  144).</p>
Free text	
Navigation	  Setup → Advanced setup → Linearization → Free text
Prerequisite	Unit after linearization (→  143) = Free text

Description	Enter unit symbol.
User entry	Up to 32 alphanumeric characters (letters, numbers, special characters)
Factory setting	Free text



Level linearized

Navigation	 Setup → Advanced setup → Linearization → Level linearized
Description	Displays linearized level.
Additional information	 The unit is defined by the Unit after linearization parameter →  143.

Maximum value

Navigation	  Setup → Advanced setup → Linearization → Maximum value
Prerequisite	Linearization type (→  142) has one of the following values: <ul style="list-style-type: none"> ▪ Linear ▪ Pyramid bottom ▪ Conical bottom ▪ Angled bottom ▪ Horizontal cylinder ▪ Sphere
Description	Linearized value corresponding to a level of 100%.
User entry	-50 000.0 to 50 000.0 %
Factory setting	100.0 %

Diameter

Navigation	  Setup → Advanced setup → Linearization → Diameter
Prerequisite	Linearization type (→  142) has one of the following values: <ul style="list-style-type: none"> ▪ Horizontal cylinder ▪ Sphere
Description	Diameter of the cylindrical or spherical tank.
User entry	0 to 9 999.999 m
Factory setting	2 m

Additional information The unit is defined in the **Distance unit** parameter (→  123).

Intermediate height

Navigation   Setup → Advanced setup → Linearization → Intermed. height

Prerequisite **Linearization type** (→  142) has one of the following values:

- Pyramid bottom
- Conical bottom
- Angled bottom

Description Height of the pyramid, conical or angled bottom.

User entry 0 to 200 m

Factory setting 0 m

Additional information

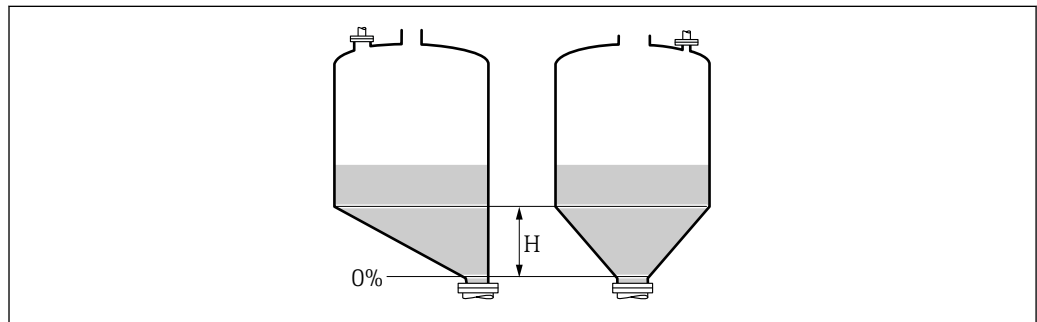

A0013264

H Intermediate height





The unit is defined in the **Distance unit** parameter (→  123).

Table mode

Navigation   Setup → Advanced setup → Linearization → Table mode

Prerequisite **Linearization type** (→  142) = Table

Description Select editing mode of the linearization table.

Selection

- Manual
- Semiautomatic
- Clear table
- Sort table

Factory setting Manual



Additional information

Meaning of the options

- **Manual**
The level and the associated linearized value are entered manually for each linearization point.
- **Semiautomatic**
The level is measured by the device for each linearization point. The associated linearized value is entered manually.
- **Clear table**
Deletes the existing linearization table.
- **Sort table**
Rearranges the linearization points into an ascending order.



Conditions the linearization table must meet:



- The table may consist of up to 32 pairs of values "Level - Linearized Value".
- The table must be monotonic (monotonically increasing or decreasing).
- The first linearization point must refer to the minimum level.
- The last linearization point must refer to the maximum level.

 Before entering a linearization table, the values for **Empty calibration** (→  125) and **Full calibration** (→  125) must be set correctly.

If values of the table need to be changed after the full or empty calibration have been changed, a correct evaluation is only ensured if the existing table is deleted and the complete table is entered again. To do so delete the existing table (**Table mode** (→  146) = **Clear table**). Then enter a new table.

How to enter the table

- **Via FieldCare**
The table points can be entered via the **Table number** (→  147), **Level** (→  148) and **Customer value** (→  148) parameters. As an alternative, the graphic table editor may be used: Device Operation → Device Functions → Additional Functions → Linearization (Online/Offline)
- **Via local display**
Select the **Edit table** submenu to call up the graphic table editor. The table is displayed and can be edited line by line.

 The factory setting for the level unit is "%". If you want to enter the linearization table in physical units, you must select the appropriate unit in the **Level unit** parameter (→  137) beforehand.











 If a decreasing table is entered, the values for 20 mA and 4 mA of the current output are interchanged. That means: 20 mA refers to the lowest level, whereas 4 mA refers to the highest level.

Table number	
Navigation	 Setup → Advanced setup → Linearization → Table number
Prerequisite	Linearization type (→  142) = Table
Description	Select table point you are going to enter or change.
User entry	1 to 32
Factory setting	1



Level (Manual) 

Navigation	 Setup → Advanced setup → Linearization → Level
Prerequisite	<ul style="list-style-type: none"> ▪ Linearization type (→  142) = Table ▪ Table mode (→  146) = Manual
Description	Enter level value of the table point (value before linearization).
User entry	Signed floating-point number
Factory setting	0 %



Level (Semiautomatic)

Navigation	 Setup → Advanced setup → Linearization → Level
Prerequisite	<ul style="list-style-type: none"> ▪ Linearization type (→  142) = Table ▪ Table mode (→  146) = Semiautomatic
Description	Displays measured level (value before linearization). This value is transmitted to the table.

Customer value 

Navigation	 Setup → Advanced setup → Linearization → Customer value
Prerequisite	Linearization type (→  142) = Table
Description	Enter linearized value for the table point.
User entry	Signed floating-point number
Factory setting	0 %

Activate table 

Navigation	  Setup → Advanced setup → Linearization → Activate table
Prerequisite	Linearization type (→  142) = Table
Description	Activate (enable) or deactivate (disable) the linearization table.
Selection	<ul style="list-style-type: none"> ▪ Disable ▪ Enable

Factory setting

Disable

Additional information**Meaning of the options****■ Disable**

The measured level is not linearized.

If **Linearization type** (→  **142**) = **Table** at the same time, the device issues error message F435.

■ Enable

The measured level is linearized according to the table.







When editing the table, the **Activate table** parameter is automatically reset to **Disable** and must be reset to **Enable** after the table has been entered.





"Safety settings" submenu

Navigation  Setup → Advanced setup → Safety sett.

Output echo lost 

Navigation	 Setup → Advanced setup → Safety sett. → Output echo lost
Description	Output signal in case of a lost echo.
Selection	<ul style="list-style-type: none"> ▪ Last valid value ▪ Ramp at echo lost ▪ Value echo lost ▪ Alarm
Factory setting	Last valid value
Additional information	<p>Meaning of the options</p> <ul style="list-style-type: none"> ▪ Last valid value The last valid value is kept in the case of a lost echo. ▪ Ramp at echo lost⁵⁾ In the case of a lost echo the output value is continuously shifted towards 0% or 100%. The slope of the ramp is defined in the Ramp at echo lost parameter (→  151). ▪ Value echo lost⁵⁾ In the case of a lost echo the output assumes the value defined in the Value echo lost parameter (→  150). ▪ Alarm In the case of a lost echo the device generates an alarm; see the Failure mode parameter (→  160)

Value echo lost 

Navigation	 Setup → Advanced setup → Safety sett. → Value echo lost
Prerequisite	Output echo lost (→  150) = Value echo lost
Description	Output value in case of a lost echo
User entry	0 to 200 000.0 %
Factory setting	0.0 %
Additional information	<p>Use the unit which has been defined for the measured value output:</p> <ul style="list-style-type: none"> ▪ without linearization: Level unit (→  137) ▪ with linearization: Unit after linearization (→  143)

5) Only visible if "Linearization type" (→  142) = "None"

Ramp at echo lost



Navigation Setup → Advanced setup → Safety sett. → Ramp echo lost

Prerequisite **Output echo lost (→ 150) = Ramp at echo lost**

Description Slope of the ramp in the case of a lost echo

User entry Signed floating-point number

Factory setting 0.0 %/min

Additional information

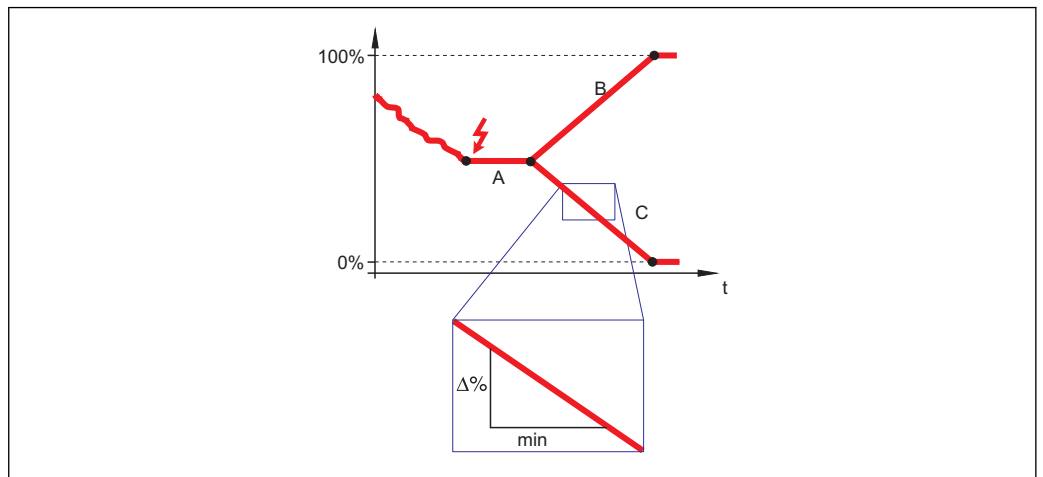

A0013269

- A Delay time echo lost
- B Ramp at echo lost (→ 151) (positive value)
- C Ramp at echo lost (→ 151) (negative value)

- The unit for the slope of the ramp is "percentage of the measuring range per minute" (%/min).
- For a negative slope of the ramp: The measured value is continuously decreased until it reaches 0%.
- For a positive slope of the ramp: The measured value is continuously increased until it reaches 100%.

Blocking distance



Navigation Setup → Advanced setup → Safety sett. → Blocking dist.

Description Specify upper blocking distance UB.

User entry 0 to 200 m

Factory setting For rod and rope probes up to 8 m (26 ft): 200 mm (8 in)

Additional information Signals in the upper blocking distance are only evaluated if they have been outside the blocking distance when the device was switched on and move into the blocking distance

due to a level change during operation. Signals which are already in the blocking distance when the device is switched on, are ignored.

- i** This behavior is only valid if the following two conditions are met:
- Expert → Sensor → Echo tracking → Evaluation mode = **Short time history** or **Long time history**)
 - Expert → Sensor → Gas phase compensation → GPC mode= **On, Without correction** or **External correction**

If one of these conditions is not met, signals in the blocking distance will always be ignored.

- i** A different behavior for signals in the blocking distance can be defined in the **Blocking distance evaluation mode** parameter.

- i** If required, a different behavior for signals in the blocking distance can be defined by the Endress+Hauser service.

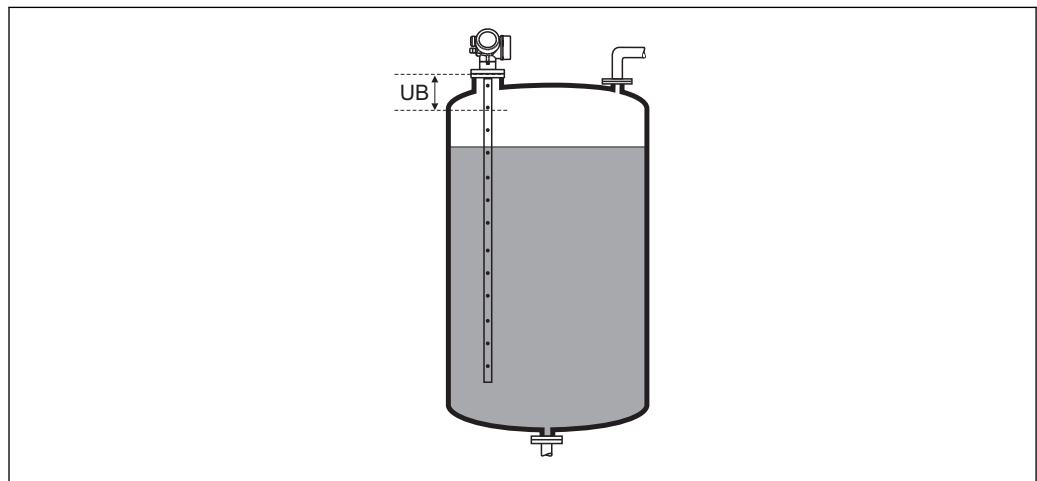

A0013219

i 46 Blocking distance (UB) for liquid measurements



"SIL/WHG confirmation" wizard

 The **SIL/WHG confirmation** wizard is only available for devices with SIL or WHG approval (Feature 590: "Additional Approval", option LA: "SIL" or LC: "WHG overflow prevention") which are currently **not** in the SIL- or WHG-locked state.

The **SIL/WHG confirmation** wizard is required to lock the device according to SIL or WHG. For details refer to the "Functional Safety Manual" of the respective device, which describes the locking procedure and the parameters of the sequence.

Navigation  Setup → Advanced setup → SIL/WHG confirm.

"Deactivate SIL/WHG" wizard

 The **Deactivate SIL/WHG** wizard (→  154) is only visible if the device is SIL-locked or WHG-locked. For details refer to the "Functional Safety Manual" of the respective device.

Navigation  Setup → Advanced setup → Deactiv. SIL/WHG

Reset write protection 

Navigation  Setup → Advanced setup → Deactiv. SIL/WHG → Res. write prot.

Description Enter unlocking code.

User entry 0 to 65 535

Factory setting 0

Code incorrect 

Navigation  Setup → Advanced setup → Deactiv. SIL/WHG → Code incorrect

Description Indicates that a wrong unlocking code has been entered. Select procedure.







Selection



- Reenter code
- Abort sequence



Factory setting Reenter code



"Probe settings" submenu

The **Probe settings** submenu helps to ensure that the end of probe signal within the envelope curve is correctly assigned by the evaluation algorithm. The assignment is correct if the length of probe indicated by the device matches the actual length of the probe. The automatic probe length correction can only be performed if the probe is installed in the vessel and is completely uncovered (no medium). For partially filled vessels and if the probe length is known, select **Confirm probe length** (→  156) = **Manual input** in order to enter the value manually.

-  If a mapping (interference echo suppression) has been recorded after shortening the probe, it is no longer possible to perform an automatic probe length correction. In this case there are two options:
 - Delete the map using the **Record map** parameter (→  129) before performing the automatic probe length correction. After the probe length correction, a new map can be recorded using the **Record map** parameter (→  129).
 - Alternative: Select **Confirm probe length** (→  156) = **Manual input** and enter the probe length manually into the **Present probe length** parameter →  155.
-  An automatic probe length correction is only possible after the correct option has been selected in the **Probe grounded** parameter (→  155).

Navigation   Setup → Advanced setup → Probe settings

Probe grounded		
Navigation	  Setup → Advanced setup → Probe settings → Probe grounded	
Prerequisite	Operating mode = Level	
Description	Specify whether the probe is grounded.	
Selection	<ul style="list-style-type: none"> ▪ No ▪ Yes 	
Factory setting	No	

Present probe length		
Navigation	 Setup → Advanced setup → Probe settings → Pres. length	
Description	<ul style="list-style-type: none"> ▪ In most cases: Displays the length of the probe according to the currently measured end-of-probe signal. ▪ For Confirm probe length (→  156) = Manual input: Enter actual length of probe. 	
User entry	0 to 200 m	
Factory setting	4 m	

Confirm probe length
**Navigation**

Setup → Advanced setup → Probe settings → Confirm length

Description

Select, whether the value displayed in the **Present probe length** parameter → 155 matches the actual length of the probe. Based on this input, the device performs a probe length correction.

Selection

- Probe length OK
- Probe length too small
- Probe length too big
- Probe covered
- Manual input
- Probe length unknown

Factory setting



Probe length OK

Additional information**Meaning of the options**

- **Probe length OK**
To be selected if the indicated length is correct. An adjustment is not required. The device quits the sequence.
- **Probe length too small**
To be selected if the displayed length is smaller than the actual length of the probe. A different end of probe signal is allocated and the newly calculated length is displayed in the **Present probe length** parameter → 155. This procedure has to be repeated until the displayed value matches the actual length of the probe.
- **Probe length too big**
To be selected if the displayed length is bigger than the actual length of the probe. A different end of probe signal is allocated and the newly calculated length is indicated in the **Present probe length** parameter → 155. This procedure has to be repeated until the displayed value matches the actual length of the probe.
- **Probe covered**
To be selected if the probe is (partially or completely) covered. A probe length correction is impossible in this case. The device quits the sequence.
- **Manual input**
To be selected if no automatic probe length correction is to be performed. Instead, the actual length of the probe must be entered manually into the **Present probe length** parameter → 155 ⁶⁾.
- **Probe length unknown**
To be selected if the actual length of the probe is unknown. A probe length correction is impossible in this case and the device quits the sequence.

6) When operated via FieldCare, the **Manual input** option needs not to be selected explicitly. In FieldCare the length of the probe can always be edited.

"Probe length correction" wizard

 The **Probe length correction** wizard is only available when operating via the local display. When operating via an operating tool, all parameters concerning the probe length correction are located directly in the **Probe settings** submenu (→  155).

Navigation  Setup → Advanced setup → Probe settings → Prob.length corr

Confirm probe length**Navigation**

 Setup → Advanced setup → Probe settings → Prob.length corr → Confirm length

Description

→  156



Present probe length**Navigation**

 Setup → Advanced setup → Probe settings → Prob.length corr → Pres. length

Description

→  155

"Current output 1 to 2" submenu

 The **Current output 2** submenu (→  158) is only available for devices with two current outputs.

Navigation  Setup → Advanced setup → Curr.output 1 to 2

Assign current output 1 to 2 

Navigation

 Setup → Advanced setup → Curr.output 1 to 2 → Assign curr.

Description

Select process variable for current output.

Selection

- Level linearized
- Distance
- Electronic temperature
- Relative echo amplitude
- Analog output adv. diagnostics 1
- Analog output adv. diagnostics 2

Factory setting



For level measurements

- Current output 1: Level linearized
- Current output 2 ⁷⁾: Level linearized

Additional information

Definition of the current range for the process variables

Process variable	4 mA value	20 mA value
Level linearized	0 % ¹⁾ or the associated linearized value	100 % ²⁾ or the associated linearized value
Distance	0 (i.e. level is at the reference point)	Empty calibration (→  125) (i.e. level is at 0 %)
Electronic temperature	-50 °C (-58 °F)	100 °C (212 °F)
Relative echo amplitude	0 mV	2 000 mV
Analog output adv. diagnostics 1/2	depending on the parametrization of the Advanced Diagnostics	

- 1) the 0% level is defined by **Empty calibration** parameter (→  125)
 2) The 100% level is defined by **Full calibration** parameter (→  125)

 It may be necessary to adjust the 4mA and 20mA values to the application (especially in the case of the **Analog output adv. diagnostics 1/2** option).

This can be done by the following parameters:

- Expert → Output → Current output 1 to 2 → Turn down
- Expert → Output → Current output 1 to 2 → 4 mA value
- Expert → Output → Current output 1 to 2 → 20 mA value

7) only for devices with two current outputs

Current span



Navigation

Setup → Advanced setup → Curr.output 1 to 2 → Current span

Description

Determines the current range used to transmit the measured value. '4...20mA': Measured variable: 4 ...20 mA '4...20mA NAMUR': Measured variable: 3.8 ... 20.5 mA '4...20mA US': Measured variable: 3.9 ... 20.8 mA 'Fixed current': Measured variable transmitted via HART only Note: Currents below 3.6 mA or above 21.95 mA can be used to signal an alarm.

Selection

- 4...20 mA
- 4...20 mA NAMUR
- 4...20 mA US
- Fixed current

Factory setting

4...20 mA NAMUR

Additional information

Meaning of the options

Option	Current range for process variable	Lower alarm signal level	Upper alarm signal level
4...20 mA	4 to 20.5 mA	< 3.6 mA	> 21.95 mA
4...20 mA NAMUR	3.8 to 20.5 mA	< 3.6 mA	> 21.95 mA
4...20 mA US	3.9 to 20.8 mA	< 3.6 mA	> 21.95 mA
Fixed current	Constant current, defined in the Fixed current parameter (→ 159).		

- In the case of an error, the output current assumes the value defined in the **Failure mode** parameter (→ 160).
- If the measured value is out of the measuring range, **Current output** diagnostic message is issued.
- In a HART multidrop loop only one device can use the analog current to transmit a signal. For all other devices one must set:
 - **Current span = Fixed current**
 - **Fixed current (→ 159) = 4 mA**

Fixed current



Navigation

Setup → Advanced setup → Curr.output 1 to 2 → Fixed current

Prerequisite

Current span (→ 159) = Fixed current

Description

Define constant value of the output current.

User entry

4 to 22.5 mA

Factory setting

4 mA

Damping output

Navigation	Setup → Advanced setup → Curr.output 1 to 2 → Damping out.
Description	Reaction time of the output signal on fluctuation in the measured value.
User entry	0.0 to 999.9 s
Factory setting	0.0 s
Additional information	Fluctuations of the measured value affect the output current with an exponential delay, the time constant τ of which is defined in this parameter. With a small time constant the output reacts immediately to changes of the measured value. With a big time constant the reaction of the output is more delayed. For $\tau = 0$ (factory setting) there is no damping.

Failure mode

Navigation	Setup → Advanced setup → Curr.output 1 to 2 → Failure mode
Prerequisite	Current span (→ 159) ≠ Fixed current
Description	Defines which current the output assumes in the case of an error. 'Min.': < 3.6mA 'Max.': > 21.95mA 'Last valid value': Last valid value before occurrence of the error. 'Actual value': Output current is equal to the measured value; error is ignored. 'Defined value': User defined value.
Selection	<ul style="list-style-type: none"> ▪ Min. ▪ Max. ▪ Last valid value ▪ Actual value ▪ Defined value
Factory setting	Max.
Additional information	<p>Meaning of the options</p> <ul style="list-style-type: none"> ▪ Min. The current output adopts the value of the lower alarm level according to the Current span parameter (→ 159). ▪ Max. The current output adopts the value of the upper alarm level according to the Current span parameter (→ 159). ▪ Last valid value The current remains constant at the last value it had before the error occurred. ▪ Actual value The output current follows the actual measured value; the error is ignored. ▪ Defined value The output current assumes the value defined in the Failure current parameter (→ 161). <p> The error behavior of other output channels is not influenced by these settings but is defined in separate parameters.</p>

Failure current





Navigation	Setup → Advanced setup → Curr.output 1 to 2 → Failure current
Prerequisite	Failure mode (→ 160) = Defined value
Description	Defines which current the output assumes in case of an error.
User entry	3.59 to 22.5 mA
Factory setting	22.5 mA

Output current 1 to 2

Navigation	Setup → Advanced setup → Curr.output 1 to 2 → Output curr. 1 to 2
Description	Shows the actual calculated value of the output current.

"Switch output" submenu

 The **Switch output** submenu (→  162) is only visible for devices with switch output.⁸⁾

Navigation  Setup → Advanced setup → Switch output

Switch output function**Navigation**

 Setup → Advanced setup → Switch output → Switch out funct

Description

Defines the function of the switch output. 'Off' The switch output is always open (non-conductive) 'On' The switch output is always closed (conductive). 'Diagnostic behavior' The switch output is normally closed and is only opened if a diagnostic event is present. 'Limit' The switch output is normally closed and is only opened if a measured variable exceeds a defined limit. 'Digital output' The switch output is controlled by one of the digital output blocks of the device.





Selection

- Off
- On
- Diagnostic behavior
- Limit
- Digital Output

Factory setting

Off

Additional information**Meaning of the options**

- **Off**
The output is always open (non-conductive).
- **On**
The output is always closed (conductive).
- **Diagnostic behavior**
The output is normally closed and is only opened if a diagnostic event is present. The **Assign diagnostic behavior** parameter (→  163) determines for which type of event the output is opened.
- **Limit**
The output is normally closed and is only opened if a measured variable exceeds or falls below a defined limit. The limit values are defined by the following parameters:
 - **Assign limit** (→  163)
 - **Switch-on value** (→  164)
 - **Switch-off value** (→  165)
- **Digital Output**
The switching state of the output tracks the output value of a DI function block. The function block is selected in the **Assign status** parameter (→  163).

 The **Off** and **On** options can be used to simulate the switch output.

8) Ordering feature 020 "Power supply; Output", option B, E or G

Assign status

**Navigation**

Setup → Advanced setup → Switch output → Assign status

Prerequisite**Switch output function (→ 162) = Digital Output****Selection**

- Off
- Digital output AD 1
- Digital output AD 2

Factory setting

Off

Additional information

The **Digital output AD 1** and **Digital output AD 2** options refer to the Advanced Diagnostic Blocks. A switch signal generated in these blocks can be transmitted via the switch output.

Assign limit

**Navigation**

Setup → Advanced setup → Switch output → Assign limit

Prerequisite**Switch output function (→ 162) = Limit****Selection**

- Off
- Level linearized
- Distance
- Interface linearized *
- Interface distance *
- Thickness upper layer *
- Terminal voltage
- Electronic temperature
- Measured capacitance *
- Relative echo amplitude
- Relative interface amplitude *
- Absolute echo amplitude
- Absolute interface amplitude *

Factory setting

Off

Assign diagnostic behavior

**Navigation**

Setup → Advanced setup → Switch output → Assign diag. beh

Prerequisite**Switch output function (→ 162) = Diagnostic behavior****Description**

Defines to which behavior of diagnostic events the switch output reacts.

* Visibility depends on order options or device settings

- Selection**
- Alarm
 - Alarm or warning
 - Warning

Factory setting Alarm

Switch-on value



Navigation Setup → Advanced setup → Switch output → Switch-on value

Prerequisite Switch output function (→ 162) = Limit

Description Defines the switch-on point. The output is closed if the assigned process variable rises above this point.

User entry Signed floating-point number

Factory setting 0

Additional information The switching behavior depends on the relative position of the **Switch-on value** and **Switch-off value** parameters:

Switch-on value > Switch-off value

- The output is closed if the measured value is larger than **Switch-on value**.
- The output is opened if the measured value is smaller than **Switch-off value**.

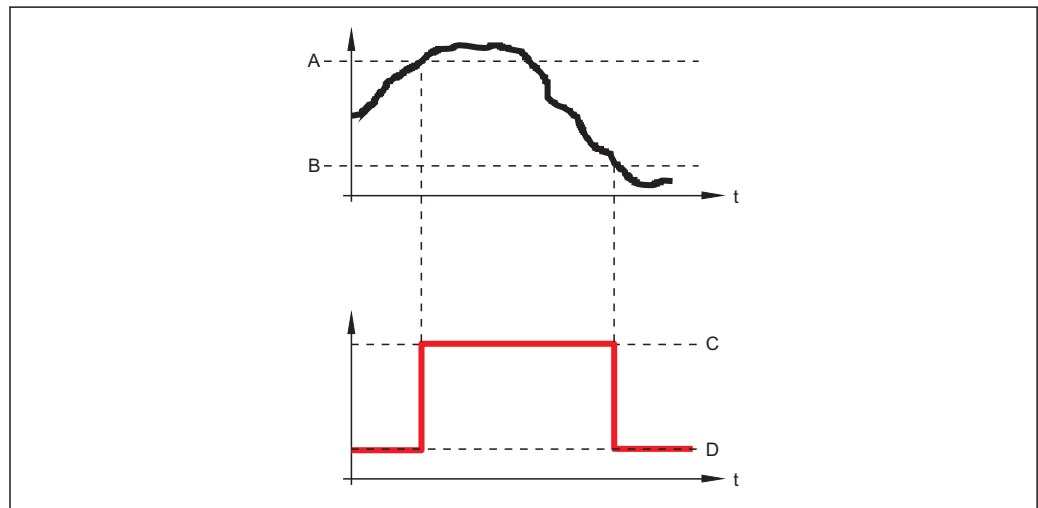

A0015585

- A Switch-on value
- B Switch-off value
- C Output closed (conductive)
- D Output opened (non-conductive)

Switch-on value < Switch-off value

- The output is closed if the measured value is smaller than **Switch-on value**.
- The output is opened if the measured value is larger than **Switch-off value**.

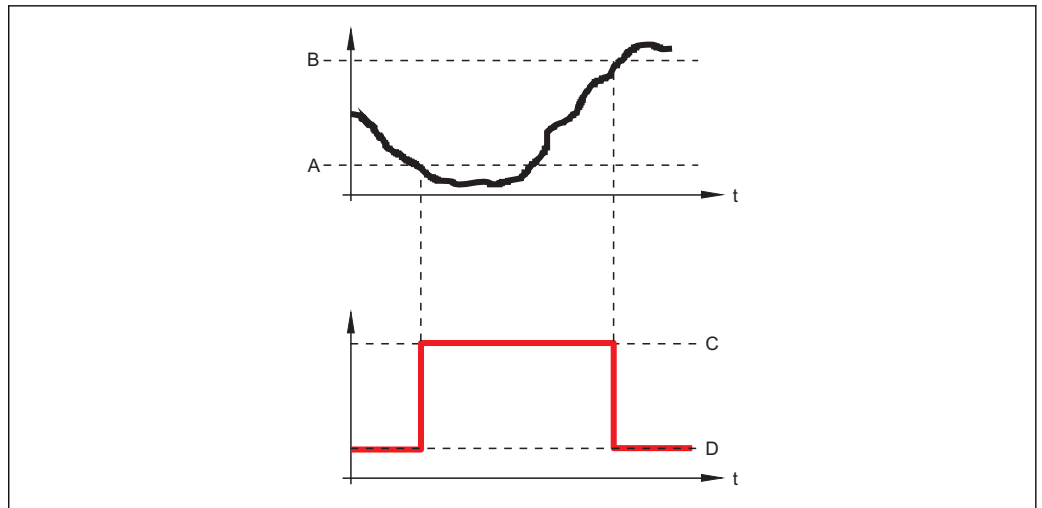

A0015586

- A Switch-on value
- B Switch-off value
- C Output closed (conductive)
- D Output opened (non-conductive)

Switch-on delay



Navigation Setup → Advanced setup → Switch output → Switch-on delay

Prerequisite **▪ Switch output function (→ 162) = Limit**
▪ Assign limit (→ 163) ≠ Off

Description Defines the delay applied before the output is switched on.

User entry 0.0 to 100.0 s

Factory setting 0.0 s

Switch-off value



Navigation Setup → Advanced setup → Switch output → Switch-off value

Prerequisite **Switch output function (→ 162) = Limit**

Description Defines the switch-off point. The output is opened if the assigned process variable falls below this point.





User entry Signed floating-point number

Factory setting 0

Additional information The switching behavior depends on the relative position of the **Switch-on value** and **Switch-off value** parameters; description: see the **Switch-on value** parameter (→ 164).



Switch-off delay



Navigation	  Setup → Advanced setup → Switch output → Switch-off delay
Prerequisite	<ul style="list-style-type: none"> ▪ Switch output function (→  162) = Limit ▪ Assign limit (→  163) ≠ Off
Description	Defines the delay applied before the output is switched off.
User entry	0.0 to 100.0 s
Factory setting	0.0 s



Failure mode



Navigation	  Setup → Advanced setup → Switch output → Failure mode
Prerequisite	Switch output function (→  162) = Limit or Digital Output
Description	Defines the state of the switch output in case of an error.
Selection	<ul style="list-style-type: none"> ▪ Actual status ▪ Open ▪ Closed
Factory setting	Open



Additional information

Switch status

Navigation	  Setup → Advanced setup → Switch output → Switch status
Description	Current status of the switch output.

Invert output signal



Navigation	  Setup → Advanced setup → Switch output → Invert outp.sig.
Description	'No' The switch output behaves as per its parameter setting. 'Yes' The switching behavior is inverted as compared to its parameter setting.
Selection	<ul style="list-style-type: none"> ▪ No ▪ Yes

Factory setting

No

Additional information**Meaning of the options**■ **No**

The behavior of the switch output is as described above.

■ **Yes**The states **Open** and **Closed** are inverted as compared to the description above.

"Display" submenu

 The **Display** submenu is only visible if a display module is connected to the device.

Navigation  Setup → Advanced setup → Display

Language**Navigation**

 Setup → Advanced setup → Display → Language

Description

Set display language.

Selection

- English
- Deutsch *
- Français *
- Español *
- Italiano *
- Nederlands *
- Portuguesa *
- Polski *
- русский язык (Russian) *
- Svenska *
- Türkçe *
- 中文 (Chinese) *
- 日本語 (Japanese) *
- 한국어 (Korean) *
- Bahasa Indonesia *
- tiếng Việt (Vietnamese) *
- čeština (Czech) *

Factory setting

The language selected in feature 500 of the product structure.
If no language has been selected: **English**

Additional information**Format display****Navigation**

 Setup → Advanced setup → Display → Format display

Description

Select how measured values are shown on the display.

Selection

- 1 value, max. size
- 1 bargraph + 1 value
- 2 values
- 1 value large + 2 values
- 4 values

Factory setting

1 value, max. size

* Visibility depends on order options or device settings

Additional information

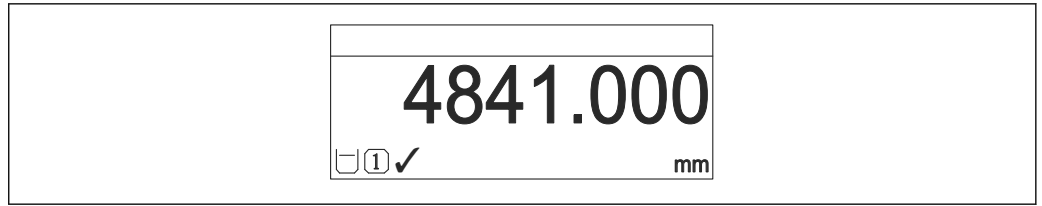

A0019963

47 "Format display" = "1 value, max. size"

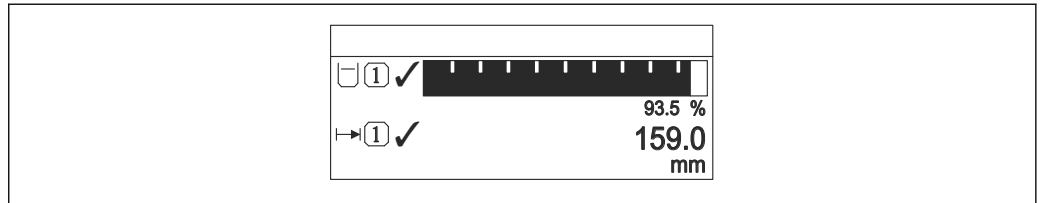

A0019964

48 "Format display" = "1 bargraph + 1 value"

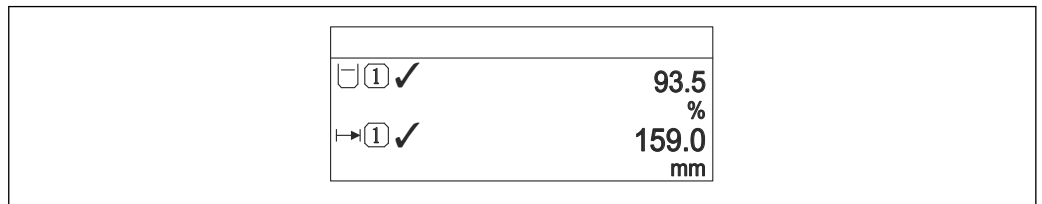

A0019965

49 "Format display" = "2 values"

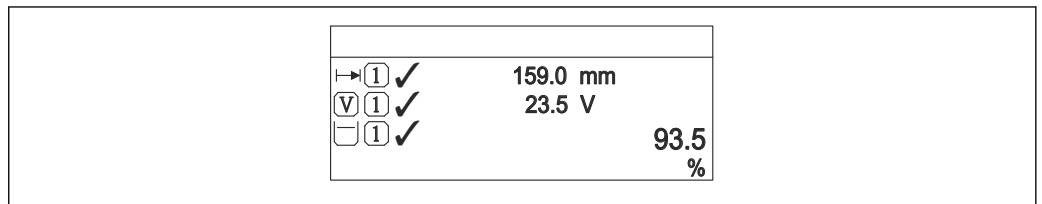

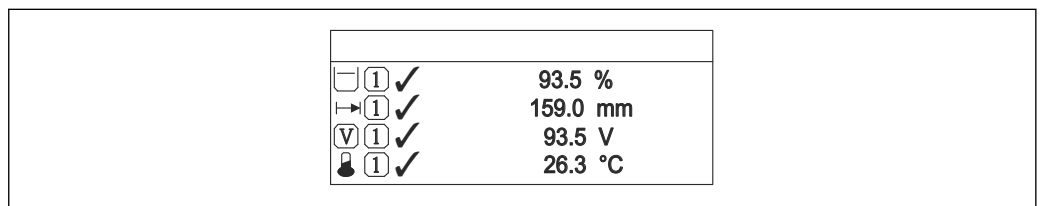

A0019966

50 "Format display" = "1 value large + 2 values"



A0019968

51 "Format display" = "4 values"

- i
■
 The **Value 1 to 4 display** →  170 parameters specify which measured values are shown on the display and in which order.
- If more measured values are specified than the current display mode permits, the values alternate on the device display. The display time until the next change is configured in the **Display interval** parameter (→  170).

Value 1 to 4 display

Navigation Setup → Advanced setup → Display → Value 1 display

Description Select the measured value that is shown on the local display.

Selection

- Level linearized
- Distance
- Interface linearized *
- Interface distance *
- Thickness upper layer *
- Current output 1
- Measured current
- Current output 2 *
- Terminal voltage
- Electronic temperature
- Measured capacitance *
- Analog output adv. diagnostics 1
- Analog output adv. diagnostics 2

Factory setting

For level measurements

- Value 1 display: Level linearized
- Value 2 display: Distance
- Value 3 display: Current output 1
- Value 4 display: None

Decimal places 1 to 4

Navigation Setup → Advanced setup → Display → Decimal places 1

Description This selection does not affect the measurement and calculation accuracy of the device.

Selection

- x
- x.x
- x.xx
- x.xxx
- x.xxxx

Factory setting x.xx

Additional information The setting does not affect the measuring or computational accuracy of the device.

Display interval

Navigation Setup → Advanced setup → Display → Display interval

Description Set time measured values are shown on display if display alternates between values.

* Visibility depends on order options or device settings

User entry	1 to 10 s
Factory setting	5 s
Additional information	This parameter is only relevant if the number of selected measuring values exceeds the number of values the selected display format can display simultaneously.

Display damping



Navigation	Setup → Advanced setup → Display → Display damping
Description	Set display reaction time to fluctuations in the measured value.
User entry	0.0 to 999.9 s
Factory setting	0.0 s

Header



Navigation	Setup → Advanced setup → Display → Header
Description	Select header contents on local display.
Selection	<ul style="list-style-type: none"> ■ Device tag ■ Free text
Factory setting	Device tag

Additional information

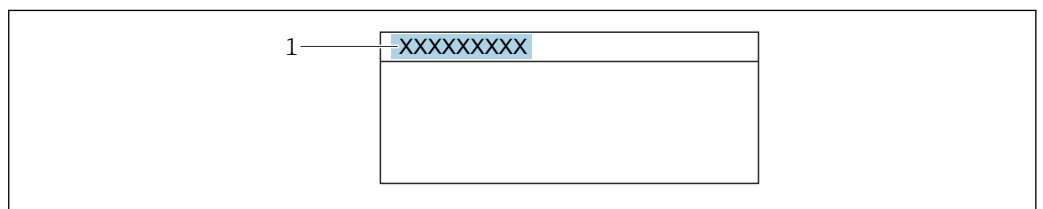

A0029422

1 Position of the header text on the display

Meaning of the options

- **Device tag**
Is defined in the **Device tag** parameter (→ 123)
- **Free text**
Is defined in the **Header text** parameter (→ 172)

Header text



Navigation Setup → Advanced setup → Display → Header text

Prerequisite Header (→ 171) = Free text

Description Enter display header text.

Factory setting -----

Additional information The number of characters which can be displayed depends on the characters used.

Separator



Navigation Setup → Advanced setup → Display → Separator

Description Select decimal separator for displaying numerical values.

Selection

- .
- ,

Factory setting .

Number format



Navigation Setup → Advanced setup → Display → Number format

Description Choose number format for the display.

Selection

- Decimal
- ft-in-1/16"

Factory setting Decimal

Additional information The **ft-in-1/16"** option is only valid for distance units.

Decimal places menu





Navigation Setup → Advanced setup → Display → Dec. places menu







Description Select number of decimal places for the representation of numbers within the operating menu.

Selection	<ul style="list-style-type: none"> ■ X ■ X.X ■ X.XX ■ X.XXX ■ X.XXXX
Factory setting	x.xxxx
Additional information	<ul style="list-style-type: none"> ■ Is only valid for numbers in the operating menu (e.g. Empty calibration, Full calibration), but not for the measured value display. The number of decimal places for the measured value display is defined in the Decimal places 1 to 4 →  170 parameters. ■ The setting does not affect the accuracy of the measurement or the calculations.

Backlight

Navigation	  Setup → Advanced setup → Display → Backlight
Prerequisite	The device has the SD03 local display (with optical keys).
Description	Switch the local display backlight on and off.
Selection	<ul style="list-style-type: none"> ■ Disable ■ Enable
Factory setting	Disable
Additional information	<p>Meaning of the options</p> <ul style="list-style-type: none"> ■ Disable Switches the backlight off. ■ Enable Switches the backlight on. <p> Regardless of the setting in this parameter the backlight may be automatically switched off by the device if the supply voltage is too low.</p>

Contrast display

Navigation	  Setup → Advanced setup → Display → Contrast display
Description	Adjust local display contrast setting to ambient conditions (e.g. lighting or reading angle).
User entry	20 to 80 %
Factory setting	Dependent on the display.
Additional information	<p> Setting the contrast via push-buttons:</p> <ul style="list-style-type: none"> ■ Darker: press the   buttons simultaneously. ■ Brighter: press the   buttons simultaneously.

"Configuration backup display" submenu

 This submenu is only visible if a display module is connected to the device.

The configuration of the device can be saved to the display module at a certain point of time (backup). The saved configuration can be restored to the device if required, e.g. in order to bring the device back into a defined state. The configuration can also be transferred to a different device of the same type using the display module.

Navigation  Setup → Advanced setup → Conf.backup disp

Operating time

Navigation  Setup → Advanced setup → Conf.backup disp → Operating time

Description Indicates how long the device has been in operation.

Additional information *Maximum time*
9999 d (≈ 27 years)

Last backup

Navigation  Setup → Advanced setup → Conf.backup disp → Last backup

Description Indicates when the last data backup was saved to the display module.

Configuration management

Navigation  Setup → Advanced setup → Conf.backup disp → Config. managem.

Description Select action for managing the device data in the display module.



Selection

- Cancel
- Execute backup
- Restore
- Duplicate
- Compare
- Clear backup data

Factory setting Cancel



Additional information

Meaning of the options

- **Cancel**
No action is executed and the user exits the parameter.
 - **Execute backup**
A backup copy of the current device configuration in the HistoROM (built-in in the device) is saved to the display module of the device.
 - **Restore**
The last backup copy of the device configuration is copied from the display module to the HistoROM of the device.
 - **Duplicate**
The transmitter configuration is duplicated to another device using the transmitter display module. The following parameters, which characterize the individual measuring point are **not** included in the transmitted configuration:
 - HART date code
 - HART short tag
 - HART message
 - HART descriptor
 - HART address
 - Device tag
 - Medium type
 - **Compare**
The device configuration saved in the display module is compared to the current device configuration of the HistoROM. The result of this comparison is displayed in the **Comparison result** parameter (→  175).
 - **Clear backup data**
The backup copy of the device configuration is deleted from the display module of the device.
-  While this action is in progress, the configuration cannot be edited via the local display and a message on the processing status appears on the display.
-  If an existing backup is restored to a different device using the **Restore** option, it may occur that some device functionalities are no longer available. In some cases even a device reset will not restore the original status.
- In order to transmit a configuration to a different device, the **Duplicate** option should always be used.

Backup state

Navigation



  Setup → Advanced setup → Conf.backup disp → Backup state

Description

Displays which backup action is currently in progress.

Comparison result

Navigation

  Setup → Advanced setup → Conf.backup disp → Compar. result

Description

Comparison between present device data and display backup.

Additional information**Meaning of the display options****■ Settings identical**

The current device configuration of the HistoROM is identical to the backup copy in the display module.

■ Settings not identical

The current device configuration of the HistoROM is not identical to the backup copy in the display module.

■ No backup available

There is no backup copy of the device configuration of the HistoROM in the display module.

■ Backup settings corrupt

The current device configuration of the HistoROM is corrupt or not compatible with the backup copy in the display module.

■ Check not done

The device configuration of the HistoROM has not yet been compared to the backup copy in the display module.

■ Dataset incompatible

The data sets are incompatible and can not be compared.





To start the comparison, set **Configuration management** (→  174) = **Compare**.



If the transmitter configuration has been duplicated from a different device by **Configuration management** (→  174) = **Duplicate**, the new device configuration in the HistoROM is only partially identical to the configuration stored in the display module: Sensor specific properties (e.g. the mapping curve) are not duplicated. Thus, the result of the comparison will be **Settings not identical**.

"Administration" submenu

Navigation  Setup → Advanced setup → Administration

Define access code 









Navigation  Setup → Advanced setup → Administration → Def. access code

Description Define release code for write access to parameters.

User entry 0 to 9999

Factory setting 0

Additional information

-  If the factory setting is not changed or 0 is defined as the access code, the parameters are not write-protected and the configuration data of the device can then always be modified. The user is logged on in the *Maintenance* role.
-  The write protection affects all parameters marked with the  symbol in this document. On the local display, the  symbol in front of a parameter indicates that the parameter is write-protected.
-  Once the access code has been defined, write-protected parameters can only be modified if the access code is entered in the **Enter access code** parameter (→  133).
-  Please contact your Endress+Hauser Sales Center if you lose your access code.
-  For display operation: The new access code is only valid after it has been confirmed in the **Confirm access code** parameter (→  179).

Device reset 

Navigation   Setup → Advanced setup → Administration → Device reset

Description Reset the device configuration - either entirely or in part - to a defined state.

Selection

- Cancel
- To factory defaults
- To delivery settings
- Of customer settings
- To transducer defaults
- Restart device

Factory setting Cancel

Additional information**Meaning of the options****■ Cancel**

No action

■ To factory defaults

All parameters are reset to the order-code specific factory setting.

■ To delivery settings

All parameters are reset to the delivery setting. The delivery setting may differ from the factory default if customer specific settings have been ordered.

This option is only visible if customer specific settings have been ordered.

■ Of customer settings

All customer parameters are reset to their factory setting. Service parameters, however, remain unchanged.

■ To transducer defaults

Every measurement-related parameter is reset to its factory setting. Service parameters and communication-related parameters, however, remain unchanged.

■ Restart device

The restart resets every parameter which is stored in the volatile memory (RAM) to the factory setting (e.g. measured value data). The device configuration remains unchanged.

"Define access code" wizard

 The **Define access code** wizard is only available when operating via the local display. When operating via an operating tool, the **Define access code** parameter is located directly in the **Administration** submenu. The **Confirm access code** parameter is not available for operation via operating tool.

Navigation  Setup → Advanced setup → Administration → Def. access code

Define access code 

Navigation  Setup → Advanced setup → Administration → Def. access code → Def. access code

Description →  177

Confirm access code 

Navigation  Setup → Advanced setup → Administration → Def. access code → Confirm code

Description Confirm the entered access code.

User entry 0 to 9999

Factory setting 0

17.5 "Diagnostics" menu

Navigation  Diagnostics

Actual diagnostics



Navigation  Diagnostics → Actual diagnos.

Description Displays current diagnostic message.

Additional information The display consists of:

- Symbol for event behavior
- Code for diagnostic behavior
- Operating time of occurrence
- Event text

 If several messages are active at the same time, the messages with the highest priority is displayed.

 Information on what is causing the message, and remedy measures, can be viewed via the  symbol on the display.

Timestamp

Navigation  Diagnostics → Timestamp

Description Displays the timestamp for the currently active diagnostic message.



Previous diagnostics

Navigation  Diagnostics → Prev.diagnostics

Description Displays the last diagnostic message which has been active before the current message.

Additional information The display consists of:

- Symbol for event behavior
- Code for diagnostic behavior
- Operating time of occurrence
- Event text

 The condition displayed may still apply. Information on what is causing the message, and remedy measures, can be viewed via the  symbol on the display.

Timestamp

Navigation  Diagnostics → Timestamp

Description Shows the timestamp of the previous diagnostic message.

Operating time from restart

Navigation   Diagnostics → Time fr. restart

Description Displays the time the device has been in operation since the last device restart.

Operating time

Navigation   Diagnostics → Operating time

Description Indicates how long the device has been in operation.

Additional information *Maximum time*
9999 d (≈ 27 years)

17.5.1 "Diagnostic list" submenu

Navigation  Diagnostics → Diagnostic list

Diagnostics 1 to 5

Navigation	 Diagnostics → Diagnostic list → Diagnostics 1
Description	Display the current diagnostics messages with the highest to fifth-highest priority.
Additional information	The display consists of: <ul style="list-style-type: none">■ Symbol for event behavior■ Code for diagnostic behavior■ Operating time of occurrence■ Event text

Timestamp 1 to 5



Navigation	 Diagnostics → Diagnostic list → Timestamp
Description	Timestamp of the diagnostic message.

17.5.2 "Event logbook" submenu

 The **Event logbook** submenu is only available when operating via the local display. When operating via FieldCare, the event list can be displayed in the FieldCare function "Event List / HistoROM".

Navigation  Diagnostics → Event logbook



Filter options



Navigation	 Diagnostics → Event logbook → Filter options
Description	Define which category of event messages is shown in the Events list submenu.
Selection	<ul style="list-style-type: none"> ▪ All ▪ Failure (F) ▪ Function check (C) ▪ Out of specification (S) ▪ Maintenance required (M) ▪ Information (I)
Factory setting	All
Additional information	 <ul style="list-style-type: none"> ▪ This parameter is only used for operation via the local display. ▪ The status signals are categorized according to NAMUR NE 107.

"Event list" submenu

The **Event list** submenu displays the history of past events of the category selected in the **Filter options** parameter (→  183). A maximum of 100 events are displayed in chronological order.

The following symbols indicate whether an event has occurred or has ended:

- : Event has occurred
- : Event has ended

 Information on what is causing the message, and remedy instructions, can be viewed via the -button.

Display format

- For event messages in category I: information event, event text, "recording event" symbol and time the event occurred
- For event messages in category F, M, C, S (status signal): diagnostics event, event text, "recording event" symbol and time the event occurred

Navigation  Diagnostics → Event logbook → Event list

17.5.3 "Device information" submenu

Navigation  Diagnostics → Device info

Device tag

Navigation  Diagnostics → Device info → Device tag

Description Enter the name for the measuring point.

Factory setting FMP5x

Serial number

Navigation  Diagnostics → Device info → Serial number

Description Shows the serial number of the measuring device.

Additional information  **Uses of the serial number**

- To identify the device quickly, e.g. when contacting Endress+Hauser.
- To obtain specific information on the device using the Device Viewer:
www.endress.com/deviceviewer

 The serial number is also indicated on the nameplate.

Firmware version

Navigation  Diagnostics → Device info → Firmware version

Description Shows the device firmware version installed.

User interface xx.yy.zz



Additional information  For firmware versions differing only in the last two digits ("zz") there is no difference concerning functionality or operation.

Device name



Navigation  Diagnostics → Device info → Device name

Description Shows the name of the transmitter.



Order code 

Navigation	  Diagnostics → Device info → Order code
Description	Shows the device order code.
Additional information	The order code is generated from the extended order code, which defines all device features of the product structure. In contrast, the device features can not be read directly from the order code.



Extended order code 1 to 3 

Navigation	  Diagnostics → Device info → Ext. order cd. 1
Description	Display the three parts of the extended order code.
Additional information	The extended order code indicates the version of all the features of the product structure and thus uniquely identifies the device.

Device revision

Navigation	  Diagnostics → Device info → Device revision
Description	Shows the device revision with which the device is registered with the HART Communication Foundation.
Additional information	The device revision is used to allocate the correct Device Description file (DD) to the device.

Device ID

Navigation	  Diagnostics → Device info → Device ID
Description	Shows the device ID for identifying the device in a HART network.
Additional information	In addition to the Device type and Manufacturer ID, the Device ID is part of the unique device identification (Unique ID) which characterizes each HART device unambiguously.

Device type

Navigation Diagnostics → Device info → Device type**Description**

Shows the device type with which the measuring device is registered with the HART Communication Foundation.

Additional information

Manufacturer ID

Navigation Diagnostics → Device info → Manufacturer ID**Description**

Use this function to view the manufacturer ID with which the measuring device is registered with the HART Communication Foundation.

User interface

2-digit hexadecimal number

Factory setting

0x11 (for Endress+Hauser)

17.5.4 "Measured values" submenu

Navigation  Diagnostics → Measured val.

Distance

Navigation  Diagnostics → Measured val. → Distance

Description Displays the measured distance D_L between the reference point (lower edge of the flange or threaded connection) and the level.

Additional information

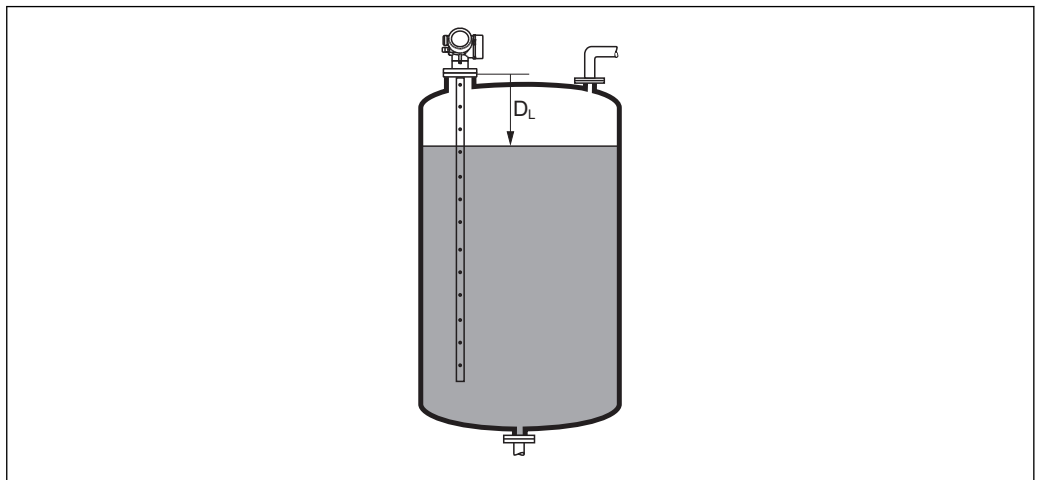

A0013198

 52 *Distance for liquid measurements*

 The unit is defined in the **Distance unit** parameter (→  123).

Level linearized

Navigation  Diagnostics → Measured val. → Level linearized

Description Displays linearized level.

Additional information  The unit is defined by the **Unit after linearization** parameter →  143.

Output current 1 to 2

Navigation  Diagnostics → Measured val. → Output curr. 1 to 2

Description Shows the actual calculated value of the output current.

Measured current 1

Navigation Diagnostics → Measured val. → Measur. curr. 1**Prerequisite**

Only available for current output 1

DescriptionShows the current value of the current output which is currently measured.

Terminal voltage 1

Navigation Diagnostics → Measured val. → Terminal volt. 1**Description**

Shows the current terminal voltage that is applied at the output.

17.5.5 "Data logging" submenu

Navigation  Diagnostics → Data logging

Assign channel 1 to 4

Navigation  Diagnostics → Data logging → Assign chan. 1 to 4

Description Assign a process variable to logging channel.

Selection

- Off
- Level linearized
- Distance
- Unfiltered distance
- Interface linearized *
- Interface distance *
- Unfiltered interface distance
- Thickness upper layer *
- Current output 1
- Measured current
- Current output 2 *
- Terminal voltage
- Electronic temperature
- Measured capacitance *
- Absolute echo amplitude
- Relative echo amplitude
- Absolute interface amplitude *
- Relative interface amplitude *
- Absolute EOP amplitude
- EOP shift
- Noise of signal
- Calculated DC value *
- Analog output adv. diagnostics 1
- Analog output adv. diagnostics 2

Factory setting Off

Additional information A total of 1000 measured values can be logged. This means:

- 1000 data points if 1 logging channel is used
- 500 data points if 2 logging channels are used
- 333 data points if 3 logging channels are used
- 250 data points if 4 logging channels are used

If the maximum number of data points is reached, the oldest data points in the data log are cyclically overwritten in such a way that the last 1000, 500, 333 or 250 measured values are always in the log (ring memory principle).

 The logged data are deleted if a new option is selected in this parameter.

* Visibility depends on order options or device settings

Logging interval

Navigation	Diagnostics → Data logging → Logging interval Diagnostics → Data logging → Logging interval
Description	Define the logging interval t_{log} for data logging. This value defines the time interval between the individual data points in the memory.
User entry	1.0 to 3 600.0 s
Factory setting	30.0 s
Additional information	<p>This parameter defines the interval between the individual data points in the data log, and thus the maximum loggable process time T_{log} :</p> <ul style="list-style-type: none"> ▪ If 1 logging channel is used: $T_{log} = 1000 \cdot t_{log}$ ▪ If 2 logging channels are used: $T_{log} = 500 \cdot t_{log}$ ▪ If 3 logging channels are used: $T_{log} = 333 \cdot t_{log}$ ▪ If 4 logging channels are used: $T_{log} = 250 \cdot t_{log}$ <p>Once this time elapses, the oldest data points in the data log are cyclically overwritten such that a time of T_{log} always remains in the memory (ring memory principle).</p> <p> The logged data are deleted if this parameter is changed.</p> <p><i>Example</i></p> <p>When using 1 logging channel</p> <ul style="list-style-type: none"> ▪ $T_{log} = 1000 \cdot 1 \text{ s} = 1000 \text{ s} \approx 16.5 \text{ min}$ ▪ $T_{log} = 1000 \cdot 10 \text{ s} = 1000 \text{ s} \approx 2.75 \text{ h}$ ▪ $T_{log} = 1000 \cdot 80 \text{ s} = 80\,000 \text{ s} \approx 22 \text{ h}$ ▪ $T_{log} = 1000 \cdot 3\,600 \text{ s} = 3\,600\,000 \text{ s} \approx 41 \text{ d}$

Clear logging data

Navigation	Diagnostics → Data logging → Clear logging Diagnostics → Data logging → Clear logging
Description	Clear the entire logging data.
Selection	<ul style="list-style-type: none"> ▪ Cancel ▪ Clear data
Factory setting	Cancel

"Display channel 1 to 4" submenu

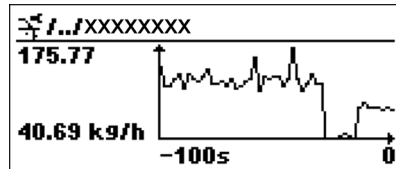

i The **Display channel 1 to 4** submenus are only available for operation via the local display. When operating via FieldCare, the logging diagram can be displayed in the FieldCare function "Event List / HistoROM" .

The **Display channel 1 to 4** submenus invoke a diagram of the logging history of the respective channel.



- x-axis: depending on the number of selected channels, 250 to 1000 measured values of a process variable are displayed.
- y-axis: covers the approximate measured value span and constantly adapts this to the measurement.









i To return to the operating menu, press **+** and **-** simultaneously.

Navigation   Diagnostics → Data logging → Displ.channel 1 to 4

17.5.6 "Simulation" submenu









The **Simulation** submenu is used to simulate specific measuring values or other conditions. This helps to check the correct configuration of the device and connected control units.

Conditions which can be simulated

Condition to be simulated	Associated parameters
Specific value of a process variable	<ul style="list-style-type: none"> ▪ Assign measurement variable (→  194) ▪ Process variable value (→  194)
Specific value of the output current	<ul style="list-style-type: none"> ▪ Current output simulation (→  194) ▪ Value current output (→  195)
Specific state of the switch output	<ul style="list-style-type: none"> ▪ Switch output simulation (→  195) ▪ Switch status (→  195)
Existence of an alarm	Device alarm simulation (→  196)
Existence of a specific diagnostic message	Diagnostic event simulation (→  196)

Structure of the submenu

Navigation  Expert → Diagnostics → Simulation

► Simulation	
Assign measurement variable	→  194
Process variable value	→  194
Current output 1 to 2 simulation	→  194
Value current output 1 to 2	→  195
Switch output simulation	→  195
Switch status	→  195
Device alarm simulation	→  196
Diagnostic event simulation	→  196

Description of parameters

Navigation  Expert → Diagnostics → Simulation

Assign measurement variable 

Navigation  Expert → Diagnostics → Simulation → Assign meas.var.

- Selection**
- Off
 - Level
 - Interface *
 - Thickness upper layer *
 - Level linearized
 - Interface linearized
 - Thickness linearized

Factory setting Off

- Additional information**
- The value of the variable to be simulated is defined in the **Process variable value** parameter (→  194).
 - If **Assign measurement variable** ≠ **Off**, a simulation is active. This is indicated by a diagnostic message of the *Function check (C)* category.

Process variable value 

Navigation  Expert → Diagnostics → Simulation → Proc. var. value

Prerequisite **Assign measurement variable** (→  194) ≠ **Off**

User entry Signed floating-point number

Factory setting 0

- Additional information** Downstream measured value processing and the signal output use this simulation value. In this way, users can verify whether the measuring device has been configured correctly.

Current output 1 to 2 simulation 

Navigation  Expert → Diagnostics → Simulation → Curr.out. 1 to 2 sim.



Description Switch the simulation of the current output on and off.

- Selection**
- Off
 - On



* Visibility depends on order options or device settings

Factory setting	Off
Additional information	An active simulation is indicated by a diagnostic message of the <i>Function check (C)</i> category.



Value current output 1 to 2

Navigation	  Expert → Diagnostics → Simulation → Value curr.out 1 to 2
Prerequisite	Current output simulation (→  194) = On
Description	Defines the value of the simulated output current.
User entry	3.59 to 22.5 mA
Factory setting	3.59 mA
Additional information	The current output assumes the value specified in this parameter. In this way, users can verify the correct adjustment of the current output and the correct function of connected control units.

Switch output simulation



Navigation	  Expert → Diagnostics → Simulation → Switch sim.
Description	Switch the simulation of the switch output on and off.
Selection	<ul style="list-style-type: none"> ■ Off ■ On
Factory setting	Off

Switch status

Navigation	  Expert → Diagnostics → Simulation → Switch status
Prerequisite	Switch output simulation (→  195) = On
Description	Current status of the switch output.
Selection	<ul style="list-style-type: none"> ■ Open ■ Closed
Factory setting	Open

Additional information The switch status assumes the value defined in this parameter. This helps to check correct operation of connected control units.

Device alarm simulation

Navigation   Expert → Diagnostics → Simulation → Dev. alarm sim.

Description Switch the device alarm on and off.



Selection

- Off
- On

Factory setting Off

Additional information When selecting the **On** option, the device generates an alarm. This helps to check the correct output behavior of the device in the case of an alarm.
An active simulation is indicated by the  **C484 Failure mode simulation** diagnostic message.

Diagnostic event simulation

Navigation   Expert → Diagnostics → Simulation → Diag. event sim.

Description Select the diagnostic event to be simulated. Note: To terminate the simulation, select 'Off'.



Factory setting Off

Additional information When operated via the local display, the selection list can be filtered according to the event categories (**Diagnostic event category** parameter).



17.5.7 "Device check" submenu

Navigation   Diagnostics → Device check



Start device check

Navigation	  Diagnostics → Device check → Start dev. check
Description	Start a device check.
Selection	<ul style="list-style-type: none"> ■ No ■ Yes
Factory setting	No
Additional information	In the case of a lost echo a device check can not be performed.



Result device check

Navigation	  Diagnostics → Device check → Result dev.check
Description	Displays the result of the device check.
Additional information	<p>Meaning of the display options</p> <ul style="list-style-type: none"> ■ Installation ok Measurement possible without restrictions. ■ Accuracy reduced A measurement is possible. However, the measuring accuracy may be reduced due to the signal amplitudes. ■ Measurement capability reduced A measurement is currently possible. However, there is the risk of an echo loss. Check the mounting position of the device and the dielectric constant of the medium. ■ Check not done No device check has been performed.



Last check time

Navigation	  Diagnostics → Device check → Last check time
Description	Displays the operating time at which the last device check has been performed.

Level signal

Navigation	  Diagnostics → Device check → Level signal
Prerequisite	Device check has been performed.
Description	Displays result of the device check for the level signal.
User interface	<ul style="list-style-type: none">■ Check not done■ Check not OK■ Check OK
Additional information	For Level signal = Check not OK : Check the mounting position of the device and the dielectric constant of the medium.

Launch signal

Navigation	  Diagnostics → Device check → Launch signal
Prerequisite	Device check has been performed.
Description	Displays result of the display check for the launch signal.
User interface	<ul style="list-style-type: none">■ Check not done■ Check not OK■ Check OK
Additional information	For Launch signal = Check not OK : Check the mounting position of the device. In non-metallic vessels use a metal plate or a metal flange.

17.5.8 "Heartbeat" submenu

 The **Heartbeat** submenu is only available via **FieldCare** or **DeviceCare**. It contains the wizards which are part of the **Heartbeat Verification** and **Heartbeat Monitoring** application packages.

Detailed description

SD01872F

Navigation  Diagnostics → Heartbeat

Index

A

Access authorization to parameters	
Read access	53
Write access	53
Access code	53
Incorrect input	53
Access status display (Parameter)	133
Access status tooling (Parameter)	132
Accessories	
Communication-specific	102
Device-specific	96
Service-specific	103
System components	103
Activate table (Parameter)	148
Actual diagnostics (Parameter)	180
Administration (Submenu)	177
Advanced process conditions (Parameter)	136
Advanced setup (Submenu)	132
Application	9
Assign channel 1 to 4 (Parameter)	189
Assign current output (Parameter)	158
Assign diagnostic behavior (Parameter)	163
Assign limit (Parameter)	163
Assign measurement variable (Parameter)	194
Assign status (Parameter)	163

B

Backlight (Parameter)	173
Backup state (Parameter)	175
Blocking distance (Parameter)	137, 151
Bluetooth® wireless technology	49

C

Cleaning	92
Clear logging data (Parameter)	190
Code incorrect (Parameter)	154
Comparison result (Parameter)	175
Configuration backup display (Submenu)	174
Configuration management (Parameter)	174
Configuration of a level measurement	71
Configuring level measurement	71
Confirm access code (Parameter)	179
Confirm distance (Parameter)	128, 131
Confirm probe length (Parameter)	156, 157
Context menu	64
Contrast display (Parameter)	173
Current output 1 to 2 (Submenu)	158
Current output 1 to 2 simulation (Parameter)	194
Current span (Parameter)	159
Customer value (Parameter)	148

D

Damping output (Parameter)	160
Data logging (Submenu)	189
DD	66
Deactivate SIL/WHG (Wizard)	154

Decimal places 1 (Parameter)	170
Decimal places menu (Parameter)	172
Define access code	53
Define access code (Parameter)	177, 179
Define access code (Wizard)	179
Designated use	9
Device alarm simulation (Parameter)	196
Device check (Submenu)	197
Device Descriptions	66
Device ID (Parameter)	185
Device information (Submenu)	184
Device name (Parameter)	184
Device replacement	94
Device reset (Parameter)	177
Device revision (Parameter)	185
Device tag (Parameter)	123, 184
Device type (Parameter)	186
Diagnostic event	
In the operating tool	85
Diagnostic event simulation (Parameter)	196
Diagnostic events	82
Diagnostic list	86
Diagnostic list (Submenu)	182
Diagnostic message	82
Diagnostics	
Symbols	82
Diagnostics (Menu)	180
Diagnostics 1 (Parameter)	182
Diagnostics event	83
Diameter (Parameter)	145
DIP switch	
see Write protection switch	
Display (Submenu)	168
Display and operating module FHX50	48
Display channel 1 to 4 (Submenu)	191
Display damping (Parameter)	171
Display interval (Parameter)	170
Display module	58
Display symbols	59
Disposal	95
Distance (Parameter)	126, 131, 187
Distance unit (Parameter)	123
Document	
Function	5
Document function	5

E

Electronics housing	
Design	13
Empty calibration (Parameter)	125
Enter access code (Parameter)	133
Envelope curve display	65
Event history	89
Event level	
Explanation	82
Symbols	82

Event list (Submenu) 183
 Event logbook (Submenu) 183
 Event text 83
 Events list 89
 Extended order code 1 (Parameter) 185
 Exterior cleaning 92

F

Failure current (Parameter) 161
 Failure mode (Parameter) 160, 166
 FHX50 48
 Field of application
 Residual risks 9
 Filter options (Parameter) 183
 Filtering the event logbook 89
 Firmware version (Parameter) 184
 Fixed current (Parameter) 159
 Format display (Parameter) 168
 Free text (Parameter) 144
 Full calibration (Parameter) 125
 FV (HART device variable) 66

H

Hardware write protection 54
 HART device variables 66
 HART protocol 50
 HART-Integration 66
 Header (Parameter) 171
 Header text (Parameter) 172
 Heartbeat (Submenu) 199
 Housing
 Design 13
 Turning 29

I

Input mask 62
 Intermediate height (Parameter) 146
 Invert output signal (Parameter) 166

K

Keypad lock
 Disabling 57
 Switching on 57

L

Language (Parameter) 168
 Last backup (Parameter) 174
 Last check time (Parameter) 197
 Launch signal (Parameter) 198
 Level (Parameter) 126, 148
 Level (Submenu) 134
 Level correction (Parameter) 138
 Level linearized (Parameter) 145, 187
 Level signal (Parameter) 198
 Level unit (Parameter) 137
 Linearization (Submenu) 140, 141, 142
 Linearization type (Parameter) 142
 Local display 47
 see Diagnostics message
 see In alarm condition

Locking status 59
 Locking status (Parameter) 132
 Logging interval (Parameter) 190

M

Maintenance 92
 Managing the device configuration 76
 Manufacturer ID (Parameter) 186
 Mapping (Wizard) 131
 Mapping end point (Parameter) 129, 131
 Maximum value (Parameter) 145
 Measured current 1 (Parameter) 188
 Measured value symbols 60
 Measured values (Submenu) 187
 Media 9
 Medium group (Parameter) 124
 Medium property (Parameter) 134
 Medium type (Parameter) 134
 Menu
 Diagnostics 180
 Setup 123
 Mounting outside the vessel 25
 Mounting position for level measurements 17

N

Non-metal vessels 24
 Number format (Parameter) 172

O

Occupational safety 10
 Operating elements
 Diagnostics message 83
 Operating module 58
 Operating time (Parameter) 174, 181
 Operating time from restart (Parameter) 181
 Operational safety 10
 Order code (Parameter) 185
 Output current 1 to 2 (Parameter) 161, 187
 Output echo lost (Parameter) 150
 Overvoltage protection
 General information 43

P

Present mapping (Parameter) 129
 Present probe length (Parameter) 155, 157
 Previous diagnostics (Parameter) 180
 Probe grounded (Parameter) 155
 Probe length correction (Wizard) 157
 Probe settings (Submenu) 155
 Process property (Parameter) 135
 Process variable value (Parameter) 194
 Product safety 10
 PV (HART device variable) 66

R

Ramp at echo lost (Parameter) 151
 Read access 53
 Record map (Parameter) 129, 131
 Registered trademarks 8

- Remedial measures
 - Calling up 84
 - Closing 84
- Remote operation 50
- Repair concept 94
- Replacing a device 94
- Requirements for personnel 9
- Reset write protection (Parameter) 154
- Result device check (Parameter) 197
- Return 95
- Rod probe
 - Design 12
- Rod probes
 - Lateral loading capacity 21
- S**
- Safety instructions
 - Basic 9
- Safety Instructions (XA) 7
- Safety settings (Submenu) 150
- Separator (Parameter) 172
- Serial number (Parameter) 184
- Service interface (CDI) 50
- Setting the operating language 70
- Settings
 - Managing the device configuration 76
 - Operating language 70
- Setup (Menu) 123
- Signal quality (Parameter) 127
- SIL/WHG confirmation (Wizard) 153
- Simulation (Submenu) 193, 194
- Spare parts 95
 - Nameplate 95
- Start device check (Parameter) 197
- Status signals 59, 82
- Submenu
 - Administration 177
 - Advanced setup 132
 - Configuration backup display 174
 - Current output 1 to 2 158
 - Data logging 189
 - Device check 197
 - Device information 184
 - Diagnostic list 182
 - Display 168
 - Display channel 1 to 4 191
 - Event list 183
 - Event logbook 183
 - Events list 89
 - Heartbeat 199
 - Level 134
 - Linearization 140, 141, 142
 - Measured values 187
 - Probe settings 155
 - Safety settings 150
 - Simulation 193, 194
 - Switch output 162
- SV (HART device variable) 66
- Switch output (Submenu) 162
- Switch output function (Parameter) 162
- Switch output simulation (Parameter) 195
- Switch status (Parameter) 166, 195
- Switch-off delay (Parameter) 166
- Switch-off value (Parameter) 165
- Switch-on delay (Parameter) 165
- Switch-on value (Parameter) 164
- Symbols
 - For correction 62
 - In the text and numeric editor 62
- System components 103
- T**
- Table mode (Parameter) 146
- Table number (Parameter) 147
- Tank type (Parameter) 123
- Terminal voltage 1 (Parameter) 188
- Thermal insulation 27
- Timestamp (Parameter) 180, 181, 182
- Tool 28
- Transmitter
 - Turning the display 30
 - Turning the display module 30
- Transmitter housing
 - Turning 29
- Troubleshooting 78
- Tube diameter (Parameter) 124
- Turning the display 30
- Turning the display module 30
- TV (HART device variable) 66
- U**
- Unit after linearization (Parameter) 143
- Use of the measuring device
 - see Designated use
- Using measuring devices
 - Borderline cases 9
 - Incorrect use 9
- V**
- Value 1 display (Parameter) 170
- Value current output 1 to 2 (Parameter) 195
- Value echo lost (Parameter) 150
- W**
- Wizard
 - Deactivate SIL/WHG 154
 - Define access code 179
 - Mapping 131
 - Probe length correction 157
 - SIL/WHG confirmation 153
- Write access 53
- Write protection
 - Via access code 53
 - Via write protection switch 54
- Write protection switch 54



71488043

www.addresses.endress.com
