

Operating Instructions Levelflex FMP56, FMP57 HART

Guided wave radar

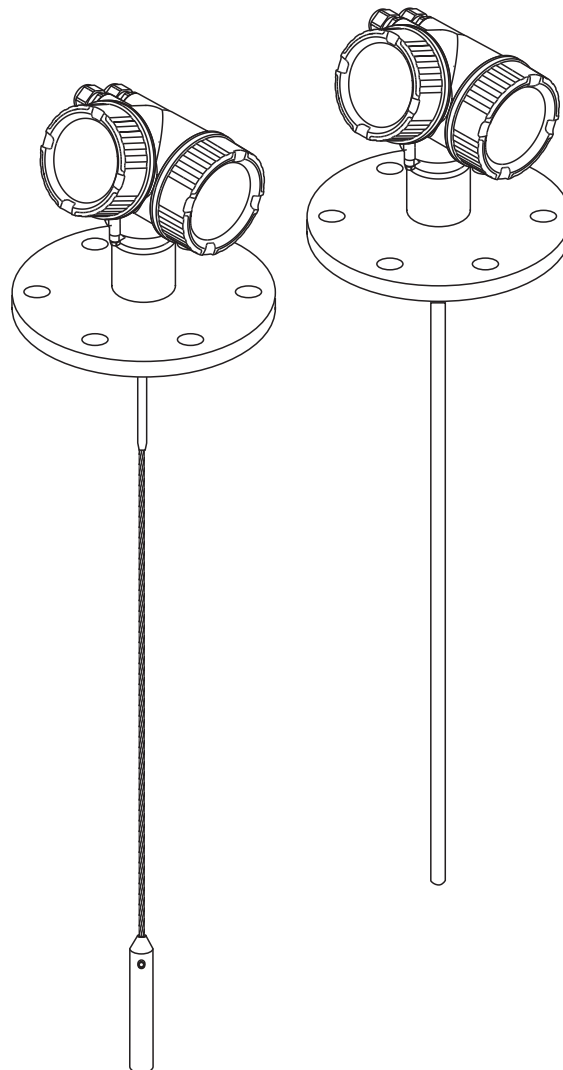

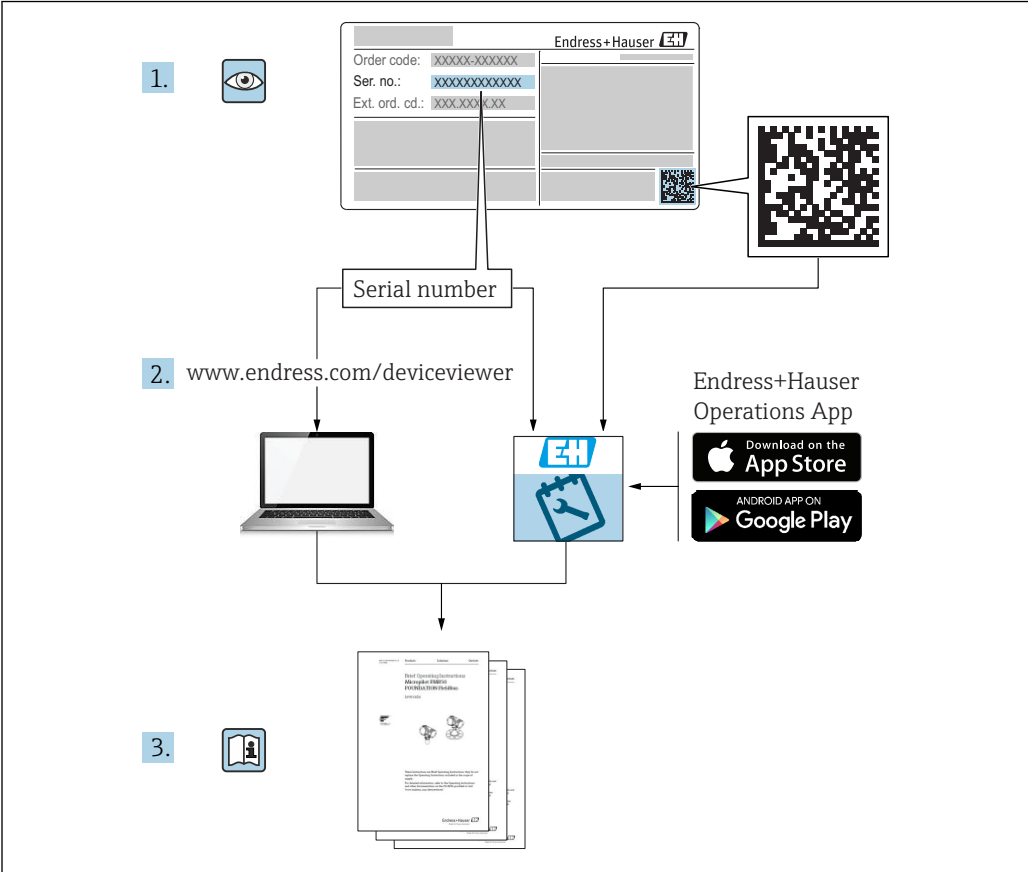

A0023555

Table of contents

1	Important document information	5			
1.1	Document function	5			
1.2	Document conventions	5			
1.2.1	Safety symbols	5			
1.2.2	Electrical symbols	5			
1.2.3	Tool symbols	6			
1.2.4	Symbols for certain types of information and graphics	6			
1.3	Documentation	7			
1.3.1	Technical Information (TI)	7			
1.3.2	Brief Operating Instructions (KA)	7			
1.3.3	Safety Instructions (XA)	7			
1.4	Terms and abbreviations	7			
1.5	Registered trademarks	8			
2	Basic safety instructions	9			
2.1	Requirements for the personnel	9			
2.2	Designated use	9			
2.3	Occupational safety	10			
2.4	Operational safety	10			
2.5	Product safety	10			
2.5.1	CE mark	10			
2.5.2	EAC conformity	10			
3	Product description	11			
3.1	Product design	11			
3.1.1	Levelflex FMP56/FMP57	11			
3.1.2	Electronics housing	12			
4	Incoming acceptance and product identification	13			
4.1	Incoming acceptance	13			
4.2	Product identification	13			
4.2.1	Nameplate	14			
5	Storage, transport	15			
5.1	Storage temperature	15			
5.2	Transporting the product to the measuring point	15			
6	Installation	17			
6.1	Installation conditions	17			
6.1.1	Suitable mounting position	17			
6.1.2	Mounting under confined conditions	19			
6.1.3	Notes on the mechanical load of the probe	20			
6.1.4	Information concerning the process connection	24			
6.1.5	Securing the probe	26			
6.1.6	Special installation situations	28			
6.2	Mounting the measuring device	32			
6.2.1	Tools list	32			
6.2.2	Shortening the probe	32			
6.2.3	Mounting the device	34			
6.2.4	Mounting the "Sensor, remote" version	35			
6.2.5	Turning the transmitter housing	37			
6.2.6	Turning the display	38			
6.3	Post-installation check	39			
7	Electrical connection	40			
7.1	Connection conditions	40			
7.1.1	Terminal assignment	40			
7.1.2	Cable specification	46			
7.1.3	Device plugs	47			
7.1.4	Power supply	48			
7.1.5	Overvoltage protection	51			
7.2	Connecting the measuring device	51			
7.2.1	Opening connection compartment cover	52			
7.2.2	Connecting	52			
7.2.3	Plug-in spring-force terminals	53			
7.2.4	Closing connection compartment cover	53			
7.3	Post-connection check	54			
8	Operation options	55			
8.1	Overview	55			
8.1.1	Local operation	55			
8.1.2	Operation with remote display and operating module FHX50	56			
8.1.3	Operation via Bluetooth® wireless technology	57			
8.1.4	Remote operation	58			
8.2	Structure and function of the operating menu	59			
8.2.1	Structure of the operating menu	59			
8.2.2	User roles and related access authorization	61			
8.2.3	Data access - Security	61			
8.3	Display and operating module	66			
8.3.1	Display appearance	66			
8.3.2	Operating elements	69			
8.3.3	Enter numbers and text	70			
8.3.4	Opening the context menu	72			
8.3.5	Envelope curve display on the display and operating module	73			
9	Device integration via the HART protocol	74			
9.1	Overview of the Device Description files (DD)	74			

9.2	HART device variables and measuring values	74			
10	Commissioning via SmartBlue (App)	75			
10.1	Requirements	75			
10.2	SmartBlue App	75			
10.3	Envelope curve display in SmartBlue	75			
11	Commissioning using the Commissioning Wizard	77			
12	Commissioning via operating menu	78			
12.1	Function check	78			
12.2	Setting the operating language	78			
12.3	Configuring level measurement	79			
12.4	Recording the reference envelope curve	81			
12.5	Configuring the local display	82			
12.5.1	Factory setting of local display for level measurements	82			
12.5.2	Adjusting the local display	82			
12.6	Configuring the current outputs	83			
12.6.1	Factor setting of current outputs for level measurements	83			
12.6.2	Adjusting the current outputs	83			
12.7	Configuration management	84			
12.8	Protecting settings from unauthorized access	85			
13	Diagnostics and troubleshooting ...	86			
13.1	General troubleshooting	86			
13.1.1	General errors	86			
13.1.2	Error - SmartBlue operation	88			
13.1.3	Parameter configuration errors	89			
13.2	Diagnostic information on local display	90			
13.2.1	Diagnostic message	90			
13.2.2	Calling up remedial measures	92			
13.3	Diagnostic event in the operating tool	93			
13.4	Diagnostic list	94			
13.5	List of diagnostic events	95			
13.6	Event logbook	97			
13.6.1	Event history	97			
13.6.2	Filtering the event logbook	97			
13.6.3	Overview of information events	97			
13.7	Firmware history	99			
14	Maintenance	100			
14.1	Exterior cleaning	100			
15	Repair	101			
15.1	General notes	101			
15.1.1	Repair concept	101			
15.1.2	Repair of Ex-certified devices	101			
15.1.3	Replacing electronics modules	101			
15.1.4	Replacing a device	101			
15.2	Spare parts	102			
15.3	Return	102			
15.4	Disposal	102			
16	Accessories	103			
16.1	Device-specific accessories	103			
16.1.1	Weather protection cover	103			
16.1.2	Mounting bracket for electronics housing	104			
16.1.3	Rod extension / centering device ...	105			
16.1.4	Mounting kit, insulated	106			
16.1.5	Remote display FHX50	107			
16.1.6	Overvoltage protection	108			
16.1.7	Bluetooth module for HART devices	109			
16.2	Communication-specific accessories	110			
16.3	Service-specific accessories	111			
16.4	System components	111			
17	Operating menu	112			
17.1	Overview of the operating menu (SmartBlue)	112			
17.2	Overview of the operating menu (display module)	117			
17.3	Overview of the operating menu (operating tool)	124			
17.4	"Setup" menu	130			
17.4.1	"Mapping" wizard	137			
17.4.2	"Advanced setup" submenu	138			
17.5	"Diagnostics" menu	186			
17.5.1	"Diagnostic list" submenu	188			
17.5.2	"Event logbook" submenu	189			
17.5.3	"Device information" submenu	190			
17.5.4	"Measured values" submenu	193			
17.5.5	"Data logging" submenu	195			
17.5.6	"Simulation" submenu	198			
17.5.7	"Device check" submenu	203			
17.5.8	"Heartbeat" submenu	205			
	Index	206			

1 Important document information

1.1 Document function

These Operating Instructions provide all of the information that is required in various phases of the life cycle of the device including:

- Product identification
- Incoming acceptance
- Storage
- Installation
- Connection
- Operation
- Commissioning
- Troubleshooting
- Maintenance
- Disposal

1.2 Document conventions

1.2.1 Safety symbols

DANGER

This symbol alerts you to a dangerous situation. Failure to avoid this situation will result in serious or fatal injury.

WARNING

This symbol alerts you to a dangerous situation. Failure to avoid this situation can result in serious or fatal injury.

CAUTION

This symbol alerts you to a dangerous situation. Failure to avoid this situation can result in minor or medium injury.

NOTICE

This symbol contains information on procedures and other facts which do not result in personal injury.

1.2.2 Electrical symbols



Alternating current



Direct current and alternating current



Direct current



Ground connection

A grounded terminal which, as far as the operator is concerned, is grounded via a grounding system.

Protective earth (PE)

Ground terminals that must be connected to ground prior to establishing any other connections.

The ground terminals are located on the interior and exterior of the device:

- Interior ground terminal: protective earth is connected to the mains supply.
- Exterior ground terminal: device is connected to the plant grounding system.

1.2.3 Tool symbols



Phillips head screwdriver



Flat blade screwdriver



Torx screwdriver



Allen key



Open-ended wrench

1.2.4 Symbols for certain types of information and graphics



Permitted

Procedures, processes or actions that are permitted



Preferred

Procedures, processes or actions that are preferred



Forbidden

Procedures, processes or actions that are forbidden



Tip

Indicates additional information



Reference to documentation



Reference to graphic



Notice or individual step to be observed

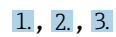

Series of steps



Result of a step



Visual inspection



Operation via operating tool



Write-protected parameter

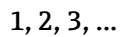

Item numbers

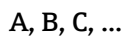

Views



Safety instructions

Observe the safety instructions contained in the associated Operating Instructions



Temperature resistance of the connection cables

Specifies the minimum value of the temperature resistance of the connection cables

1.3 Documentation

The following documentation types are available in the Downloads area of the Endress+Hauser website (www.endress.com/downloads):

-  For an overview of the scope of the associated Technical Documentation, refer to the following:
- *W@M Device Viewer* (www.endress.com/deviceviewer): Enter the serial number from nameplate
 - *Endress+Hauser Operations App*: Enter the serial number from the nameplate or scan the 2D matrix code (QR code) on the nameplate

1.3.1 Technical Information (TI)

Planning aid

The document contains all the technical data on the device and provides an overview of the accessories and other products that can be ordered for the device.

1.3.2 Brief Operating Instructions (KA)

Guide that takes you quickly to the 1st measured value

The Brief Operating Instructions contain all the essential information from incoming acceptance to initial commissioning.

1.3.3 Safety Instructions (XA)

Depending on the approval, the following Safety Instructions (XA) are supplied with the device. They are an integral part of the Operating Instructions.

-  The nameplate indicates the Safety Instructions (XA) that are relevant to the device.

1.4 Terms and abbreviations

BA

Document type "Operating Instructions"

KA

Document type "Brief Operating Instructions"

TI

Document type "Technical Information"

SD

Document type "Special Documentation"

XA

Document type "Safety Instructions"

PN

Nominal pressure

MWP

MWP (Maximum working pressure/max. process pressure)
The MWP can also be found on the nameplate.

ToF

Time of Flight

FieldCare

Scalable software tool for device configuration and integrated plant asset management solutions

DeviceCare

Universal configuration software for Endress+Hauser HART, PROFIBUS, FOUNDATION Fieldbus and Ethernet field devices

DTM

Device Type Manager

DD

Device Description for HART communication protocol

 ϵ_r (Dk value)

Relative dielectric constant

PLC

Programmable logic controller (PLC)

CDI

Common Data Interface

Operating tool

The term "operating tool" is used in place of the following operating software:

- FieldCare / DeviceCare, for operation via HART communication and PC
- SmartBlue (app), for operation using an Android or iOS smartphone or tablet

BD

Blocking Distance; no signals are analyzed within the BD.

PLC

Programmable logic controller (PLC)

CDI

Common Data Interface

PFS

Pulse Frequency Status (Switch output)

1.5 Registered trademarks

HART®

Registered trademark of the FieldComm Group, Austin, Texas, USA

Bluetooth®

The *Bluetooth*® word mark and logos are registered trademarks owned by the Bluetooth SIG, Inc. and any use of such marks by Endress+Hauser is under license. Other trademarks and trade names are those of their respective owners.

Apple®

Apple, the Apple logo, iPhone, and iPod touch are trademarks of Apple Inc., registered in the U.S. and other countries. App Store is a service mark of Apple Inc.

Android®

Android, Google Play and the Google Play logo are trademarks of Google Inc.

KALREZ®, VITON®

Registered trademarks of DuPont Performance Elastomers L.L.C., Wilmington, DE USA

TEFLON®

Registered trademark of E.I. DuPont de Nemours & Co., Wilmington, USA

TRI-CLAMP®

Registered trademark of Ladish & Co., Inc., Kenosha, USA

2 Basic safety instructions

2.1 Requirements for the personnel

The personnel for installation, commissioning, diagnostics and maintenance must fulfill the following requirements:

- ▶ Trained, qualified specialists must have a relevant qualification for this specific function and task.
- ▶ Are authorized by the plant owner/operator.
- ▶ Are familiar with federal/national regulations.
- ▶ Before starting work, read and understand the instructions in the manual and supplementary documentation as well as the certificates (depending on the application).
- ▶ Follow instructions and comply with basic conditions.

The operating personnel must fulfill the following requirements:

- ▶ Are instructed and authorized according to the requirements of the task by the facility's owner-operator.
- ▶ Follow the instructions in this manual.

2.2 Designated use

Application and media

The measuring device described in this manual is intended only for the level measurement of bulk solids. Depending on the version ordered, the measuring device can also measure potentially explosive, flammable, poisonous and oxidizing media.

If the limit values specified in the "Technical data" and the conditions listed in the manual and additional documentation are observed, the measuring device may be used for the following measurements only:

- ▶ Measured process variables: level
- ▶ Calculable process variables: volume or mass in any shape of vessel (calculated from the level by the linearization functionality)

To ensure that the measuring device remains in proper condition for the operation time:

- ▶ Use the measuring device only for media to which the process-wetted materials have an adequate level of resistance.
- ▶ Observe the limit values in "Technical data".

Incorrect use

The manufacturer is not liable for damage caused by improper or non-designated use.

Clarification of borderline cases:

- ▶ For special fluids and fluids for cleaning, Endress+Hauser is glad to provide assistance in verifying the corrosion resistance of fluid-wetted materials, but does not accept any warranty or liability.

Residual risks

Due to heat transfer from the process as well as power loss in the electronics, the temperature of the electronics housing and the assemblies contained therein (e.g. display module, main electronics module and I/O electronics module) may rise up to 80 °C (176 °F). When in operation, the sensor may reach a temperature close to the medium temperature.

Danger of burns from contact with surfaces!

- ▶ In the event of elevated medium temperatures, ensure protection against contact to prevent burns.

2.3 Occupational safety

When working on and with the device:

- ▶ Wear the required personal protective equipment according to federal/national regulations.

2.4 Operational safety

Risk of injury!

- ▶ Operate the device only if it is in proper technical condition, free from errors and faults.
- ▶ The operator is responsible for interference-free operation of the device.

Modifications to the device

Unauthorized modifications to the device are not permitted and can lead to unforeseeable dangers:

- ▶ If modifications are nevertheless required, consult with the manufacturer.

Repair

To ensure continued operational safety and reliability:

- ▶ Carry out repairs on the device only if they are expressly permitted.
- ▶ Observe federal/national regulations pertaining to the repair of an electrical device.
- ▶ Use only original spare parts and accessories from the manufacturer.

Hazardous area

To eliminate the risk of danger to persons or the facility when the device is used in the approval-related area (e.g. explosion protection, pressure equipment safety):

- ▶ Check the nameplate to verify if the device ordered can be put to its intended use in the approval-related area.
- ▶ Observe the specifications in the separate supplementary documentation that is an integral part of this manual.

2.5 Product safety

This measuring device is designed in accordance with good engineering practice to meet state-of-the-art safety requirements, has been tested, and left the factory in a condition in which it is safe to operate. It meets general safety standards and legal requirements.

NOTICE

Loss of degree of protection by opening of the device in humid environments

- ▶ If the device is opened in a humid environment, the degree of protection indicated on the nameplate is no longer valid. This may also impair the safe operation of the device.

2.5.1 CE mark

The measuring system meets the legal requirements of the applicable EU Directives. These are listed in the corresponding EU Declaration of Conformity along with the standards applied.

Endress+Hauser confirms successful testing of the device by affixing to it the CE mark.

2.5.2 EAC conformity

The measuring system meets the legal requirements of the applicable EAC guidelines. These are listed in the corresponding EAC Declaration of Conformity together with the standards applied.

Endress+Hauser confirms successful testing of the device by affixing to it the EAC mark.

3 Product description

3.1 Product design

3.1.1 Levelflex FMP56/FMP57

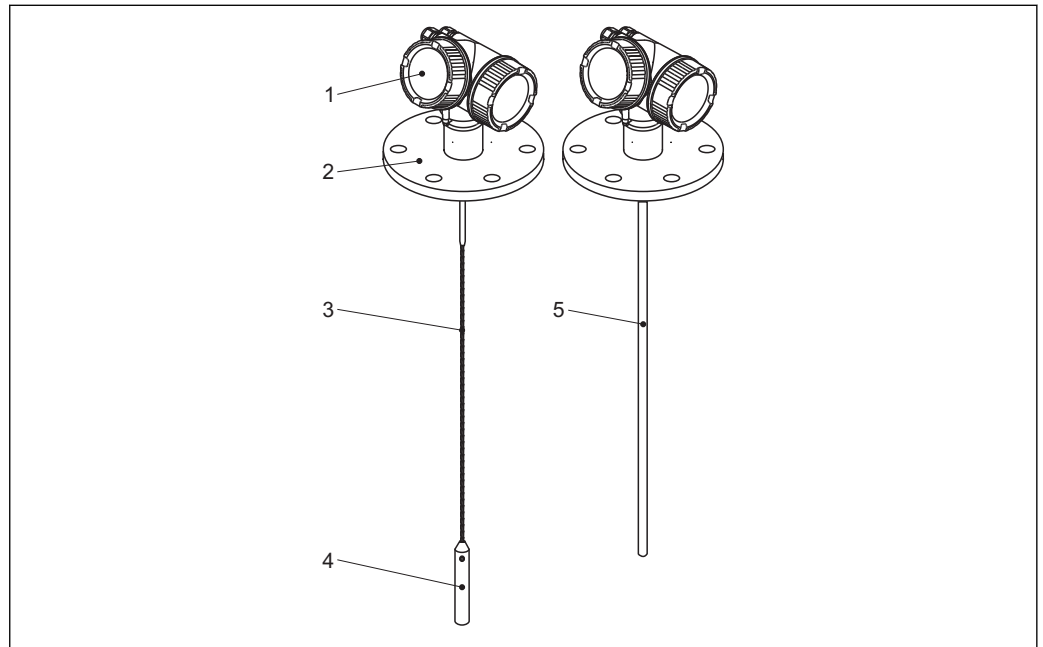

A0012470

1 Design of the Levelflex

- 1 Electronics housing
- 2 Process connection (here as an example: flange)
- 3 Rope probe
- 4 End-of-probe weight
- 5 Rod probe

3.1.2 Electronics housing

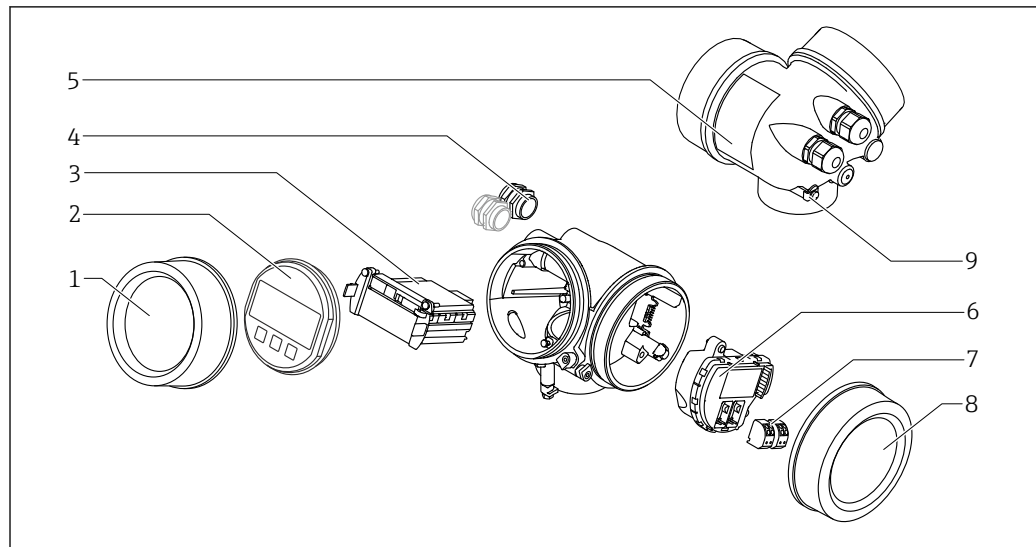

A0012422

2 Design of the electronics housing

- 1 Electronics compartment cover
- 2 Display module
- 3 Main electronics module
- 4 Cable glands (1 or 2, depending on instrument version)
- 5 Nameplate
- 6 I/O electronics module
- 7 Terminals (pluggable spring terminals)
- 8 Connection compartment cover
- 9 Grounding terminal

4 Incoming acceptance and product identification

4.1 Incoming acceptance

Upon receipt of the goods check the following:

- Are the order codes on the delivery note and the product sticker identical?
- Are the goods undamaged?
- Do the nameplate data match the ordering information on the delivery note?
- If required (see nameplate): Are the Safety Instructions (XA) present?



If one of these conditions is not satisfied, contact your Endress+Hauser Sales Center.

4.2 Product identification

The following options are available for identification of the measuring device:

- Nameplate specifications
- Order code with breakdown of the device features on the delivery note
- Enter serial numbers from nameplates in *W@M Device Viewer* (www.endress.com/deviceviewer): All information about the measuring device is displayed.
- Enter the serial number from the nameplates into the *Endress+Hauser Operations App* or scan the 2-D matrix code (QR code) on the nameplate with the *Endress+Hauser Operations App*: all the information for the measuring device is displayed.

4.2.1 Nameplate

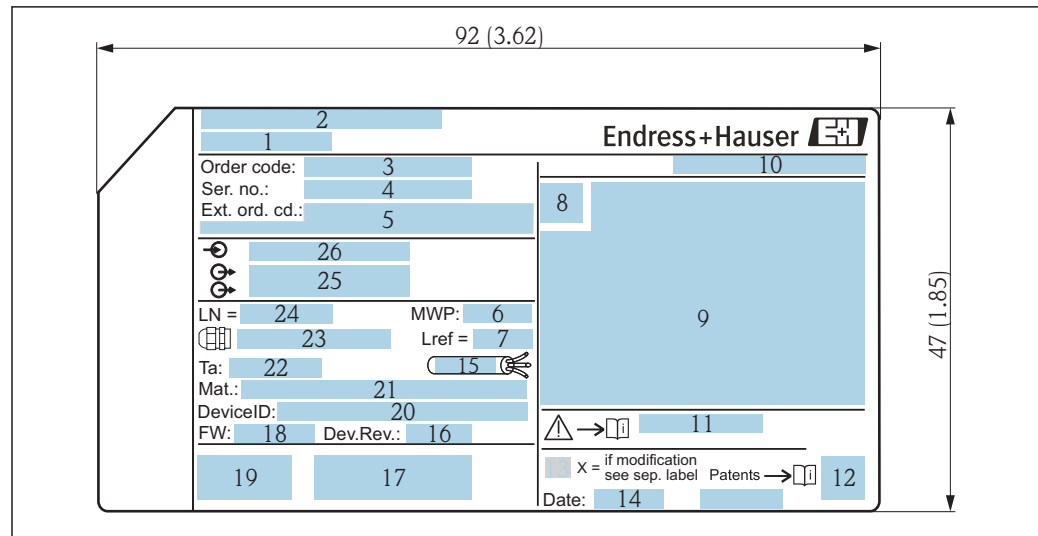

A0010725

 3 Nameplate of the Levelflex; Dimensions: mm (in)

- 1 Device name
- 2 Address of manufacturer
- 3 Order code
- 4 Serial number (Ser. no.)
- 5 Extended order code (Ext. ord. cd.)
- 6 Process pressure
- 7 Gas phase compensation: reference distance
- 8 Certificate symbol
- 9 Certificate and approval relevant data
- 10 Degree of protection: e.g. IP, NEMA
- 11 Document number of the Safety Instructions: e.g. XA, ZD, ZE
- 12 2-D matrix code (QR code)
- 13 Modification mark
- 14 Manufacturing date: year-month
- 15 Permitted temperature range for cable
- 16 Device revision (Dev.Rev.)
- 17 Additional information about the device version (certificates, approvals, communication): e.g. SIL, PROFIBUS
- 18 Firmware version (FW)
- 19 CE mark, C-Tick
- 20 DeviceID
- 21 Material in contact with process
- 22 Permitted ambient temperature (T_a)
- 23 Size of the thread of the cable glands
- 24 Length of probe
- 25 Signal outputs
- 26 Operating voltage

 Only 33 digits of the extended order code can be indicated on the nameplate. If the extended order code exceeds 33 digits, the rest will not be shown. However, the complete extended order code can be viewed in the operating menu of the device in the **Extended order code 1 to 3** parameter.

5 Storage, transport

5.1 Storage temperature

- Permitted storage temperature: -40 to +80 °C (-40 to +176 °F)
- Use original packaging.

5.2 Transporting the product to the measuring point

⚠ WARNING

Housing or rod may become damaged or pull off.

Risk of injury!

- ▶ Transport the measuring device to the measuring point in its original packaging or by the process connection.
- ▶ Always secure lifting equipment (slings, eyes, etc.) at the process connection and never lift the device by the electronic housing or probe. Pay attention to the center of gravity of the device so that it does not tilt or slip unintentionally.
- ▶ Follow the safety instructions and transport conditions for devices weighing more than 18 kg (39.6 lbs) (IEC 61010).

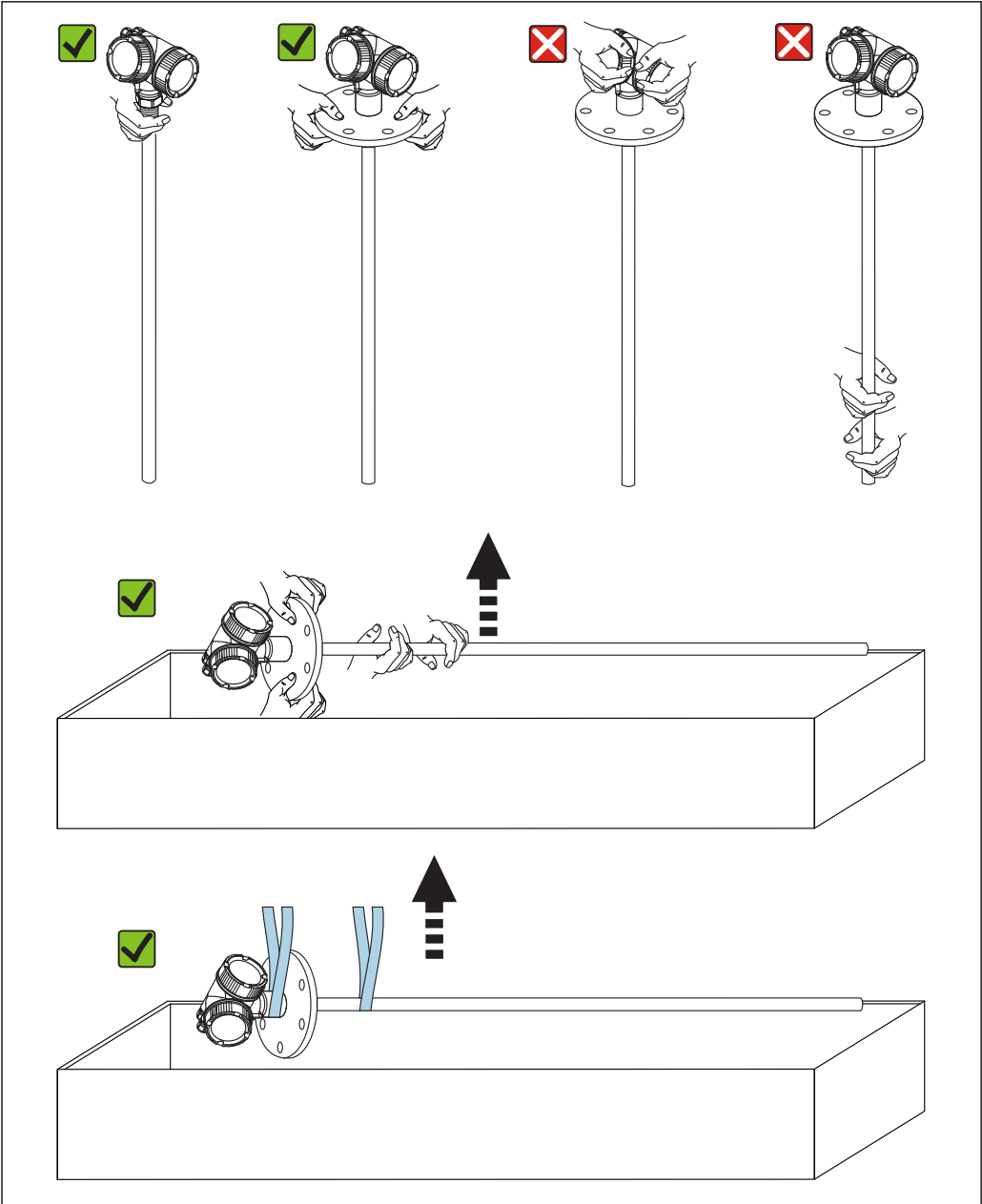

6 Installation

6.1 Installation conditions

6.1.1 Suitable mounting position

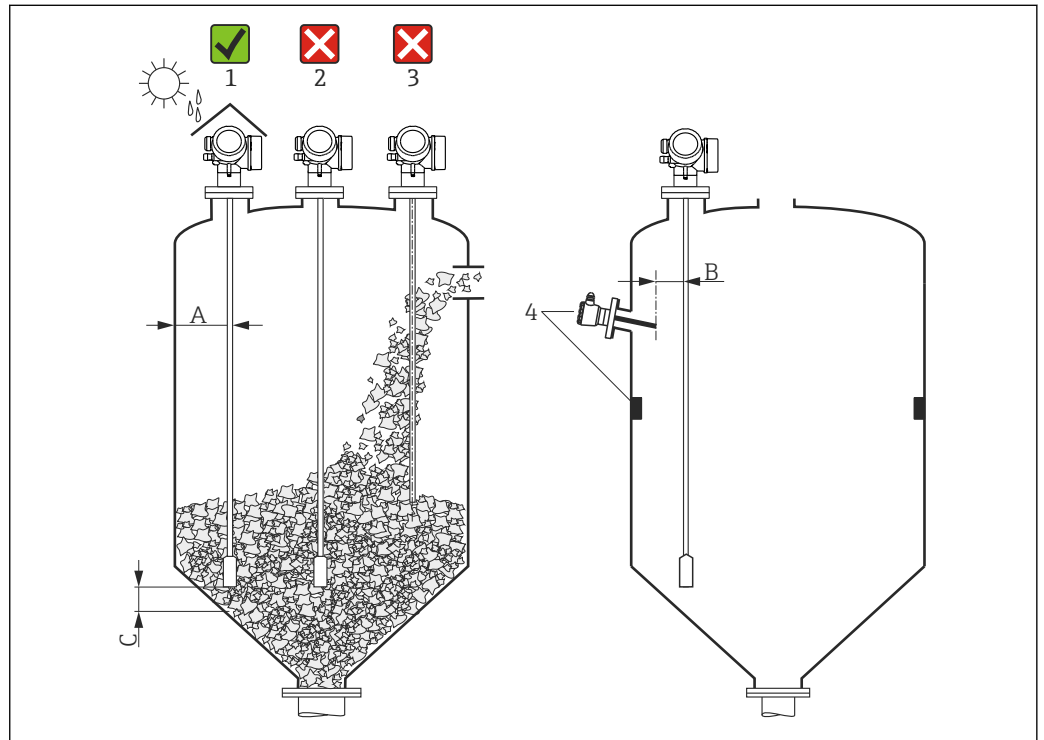



4 Installation conditions for Levelflex

A0021468

Spacing requirements when mounting

- Distance (A) between the vessel wall and rod and rope probes:
 - For smooth metallic walls: > 50 mm (2 in)
 - For plastic walls: > 300 mm (12 in) to metallic parts outside the vessel
 - For concrete walls: > 500 mm (20 in), otherwise the permitted measuring range may be reduced.
- Distance (B) between rod probes and internal fittings (3): > 300 mm (12 in)
- When using more than one Levelflex:
 - Minimum distance between the sensor axes: 100 mm (3.94 in)
- Distance (C) from the end of the probe to the bottom of the vessel:
 - Rope probe: > 150 mm (6 in)
 - Rod probe: > 10 mm (0.4 in)

Additional conditions

- When mounting outdoors, a weather protection cover (1) can be used to protect the device against extreme weather conditions.
 - In metallic vessels, preferably do not mount the probe in the center of the vessel (2), as this would lead to increased interference echoes.
If a central mounting position cannot be avoided, it is essential to perform interference echo suppression (mapping) after commissioning the device.
 - Do not mount the probe in the filling curtain (3).
 - Avoid buckling the rope probe during installation or operation (e.g. as a result of product movement against silo wall) by selecting a suitable mounting location.
 - The probe must be checked regularly for damage during operation.
-  In the case of freely suspended rope probes (probe end not fixed at the bottom), the distance between the probe rope and internal fittings, which can change due to the movement of the product, must never be less than 300 mm (12 in). Occasional contact between the probe end weight and the cone of the vessel, however, does not influence the measurement provided that the dielectric constant is at least $DC = 1.8$.
-  When the housing is mounted in a recess (e.g. in a concrete ceiling), observe a minimum distance of 100 mm (4 in) between the cover of the connection compartment/electronics compartment and the wall. Otherwise the connection compartment/electronics compartment will not be accessible after installation.

6.1.2 Mounting under confined conditions

Mounting with remote probe

The device version with a remote probe is suitable for applications with restricted mounting space. In this case, the electronics housing is mounted at a separate position from the probe.

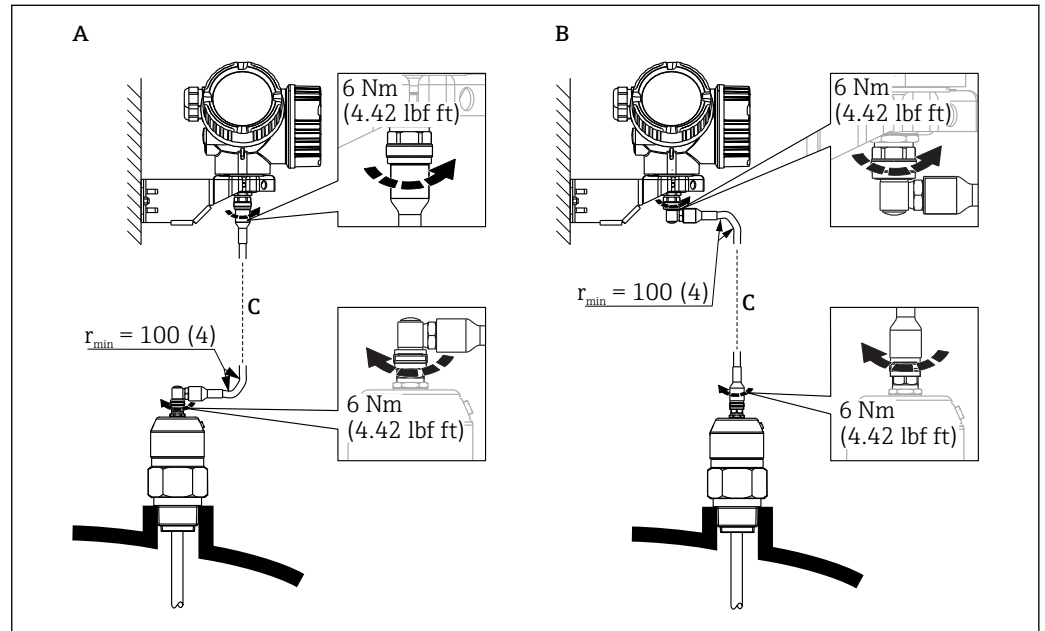

- A Angled plug at the probe
 B Angled plug at the electronics housing
 C Length of the remote cable as ordered

- Product structure, feature 600 "Probe design":
 - Version MB "Sensor remote, 3m cable"
 - Version MC "Sensor remote, 6m cable"
 - Version MD "Sensor remote, 9m cable"
- The connecting cable is included in the delivery with these versions.
 Minimum bending radius: 100 mm (4 inch)
- The mounting bracket for the electronics housing is included in the delivery with these versions. Mounting options:
 - Wall mounting
 - Mounting on DN32 to DN50 (1-1/4 to 2 inch) post or pipe
- The connection cable has one straight plug and one plug angled at 90°. Depending on the local conditions the angled plug can be connected at the probe or at the electronics housing.

i The probe, electronics and connection cable are mutually compatible and bear a common serial number. Only components with the same serial number may be connected to one another.

6.1.3 Notes on the mechanical load of the probe

Tensile load

Bulk solids exert tensile forces on rope probes which increase with:

- The probe length, i.e. the maximum cover
- The bulk density of the product
- The silo diameter and
- The diameter of the probe rope

As the tensile forces also depend greatly on the flowability of the product, a higher safety factor is necessary for highly viscous products and if there is a risk of cornice buildup. In critical cases it is better to use a 6 mm (0.24 in) rope instead of a 4 mm (0.16 in) one.

The same forces also act on the silo ceiling. The tensile forces on a fixed rope are always greater, but cannot be calculated. Observe the tensile loading capacity of the probes.

Ways to reduce the tensile forces:

- Shorten the probe.
- If the maximum tensile load is exceeded, check whether it would be possible to use a non-contact ultrasonic or level radar device.

The following diagrams show typical loads for common bulk solids as reference values. The calculation was performed for the following conditions:

- Calculation according to DIN 1055, Part 6 for the cylindrical part of the silo
- Suspended probe (probe end not fixed at the bottom)
- Free-flowing bulk solid, i.e. mass flow. A calculation for core flow is not possible. In the event of collapsing cornices, considerably higher loads can occur.
- The specification for tensile forces contains safety factor 2 (in addition to the safety factors already contained in DIN 1055), which compensates for the normal fluctuation range in pourable bulk solids.

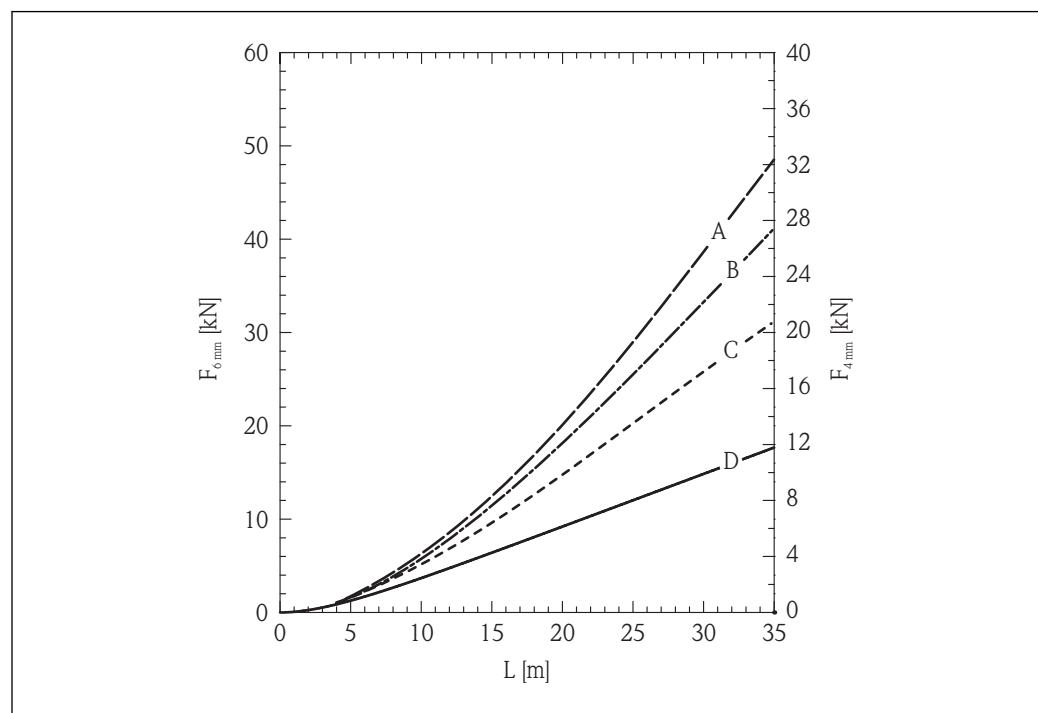

5 Silica sand in metal silo with smooth walls; tensile load as a function of level L for rope diameters 6 mm (0.24 in) and 4 mm (0.16 in)

- A Silo diameter 12 m (40 ft)
- B Silo diameter 9 m (30 ft)
- C Silo diameter 6 m (20 ft)
- D Silo diameter 3 m (10 ft)

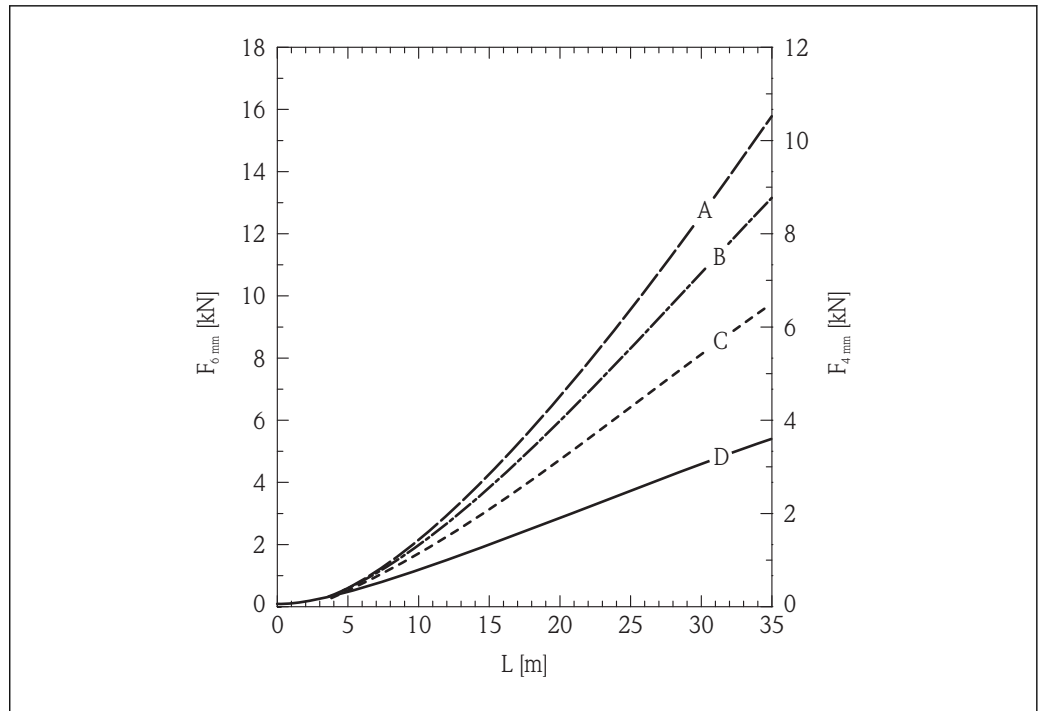

A0017171

6 Polyethylene pellets in metal silo with smooth walls; tensile load as a function of level L for rope diameters 6 mm (0.24 in) and 4 mm (0.16 in)

- A Silo diameter 12 m (40 ft)
- B Silo diameter 9 m (30 ft)
- C Silo diameter 6 m (20 ft)
- D Silo diameter 3 m (10 ft)

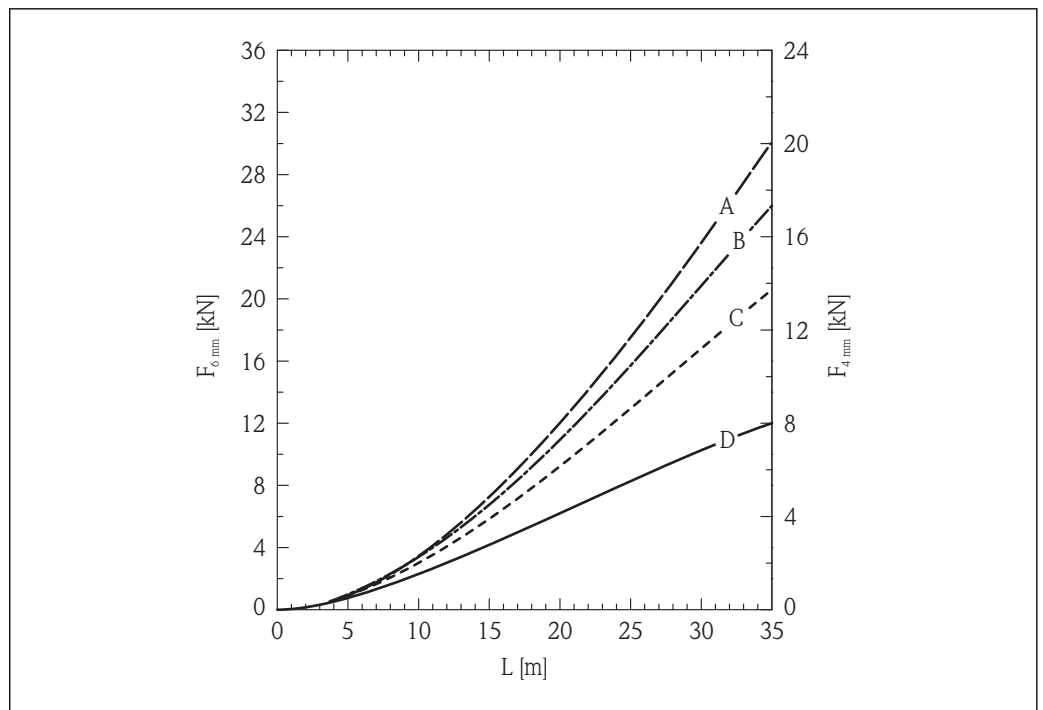

A0017172

7 Wheat in metal silo with smooth walls; tensile load as a function of level L for rope diameters 6 mm (0.24 in) and 4 mm (0.16 in)

- A Silo diameter 12 m (40 ft)
- B Silo diameter 9 m (30 ft)
- C Silo diameter 6 m (20 ft)
- D Silo diameter 3 m (10 ft)

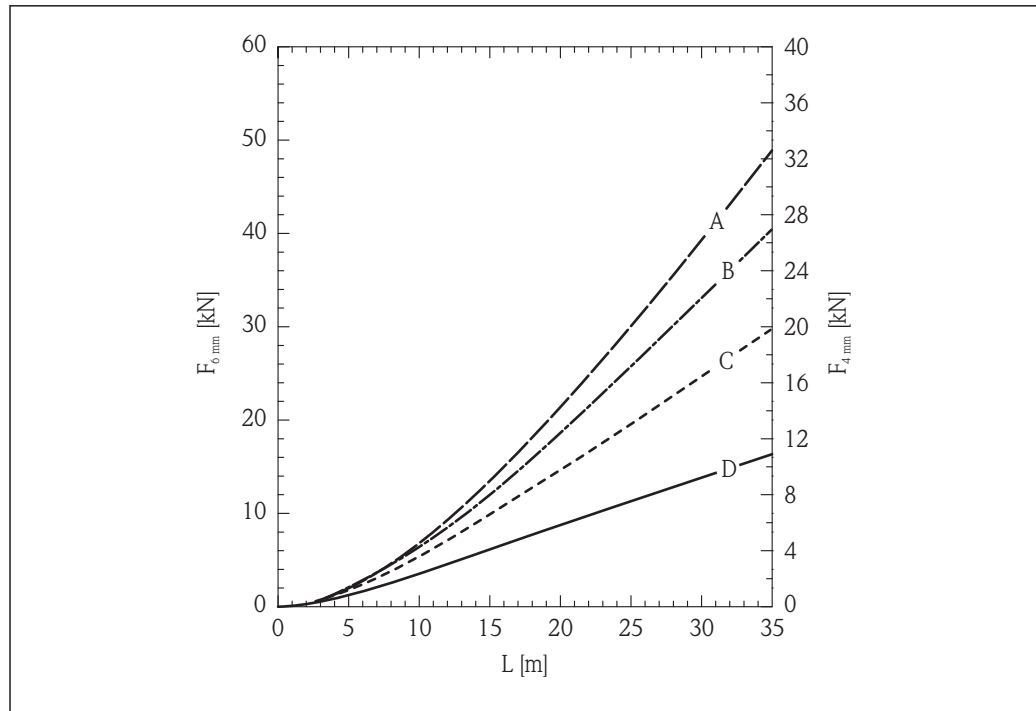

A0017173

8 Cement in metal silo with smooth walls; tensile load as a function of level L for rope diameters 6 mm (0.24 in) and 4 mm (0.16 in)

- A Silo diameter 12 m (40 ft)
- B Silo diameter 9 m (30 ft)
- C Silo diameter 6 m (20 ft)
- D Silo diameter 3 m (10 ft)

Tensile loading capacity of rope probe and breaking load (silo ceiling)

i The ceiling of the silo must be designed to withstand the maximum breaking load.

FMP56

Rope 4mm (1/6") 316

- Tensile loading capacity 12 kN
- Max. breaking load 20 kN

Rope 6mm (1/4") PA>steel

- Tensile loading capacity 12 kN
- Max. breaking load 20 kN

FMP57

Rope 4mm (1/6") 316

- Tensile loading capacity 12 kN
- Max. breaking load 20 kN

Rope 6mm (1/4") 316

- Tensile loading capacity 30 kN
- Max. breaking load 42 kN

Rope 6mm (1/4") PA>steel

- Tensile loading capacity 12 kN
- Max. breaking load 20 kN

Rope 8mm (1/3") PA>steel

- Tensile loading capacity 30 kN
- Max. breaking load 42 kN

Lateral loading capacity (flexural strength) of rod probes

FMP57

Rod 16mm (0.63") 316L

30 Nm

6.1.4 Information concerning the process connection

i Probes are mounted on the process connection with threaded connections or flanges. If there is the danger with this installation that the probe end moves so much that it occasionally touches the vessel floor or cone, the probe may need to be shortened at the lower end and fixed in place.

Threaded connection

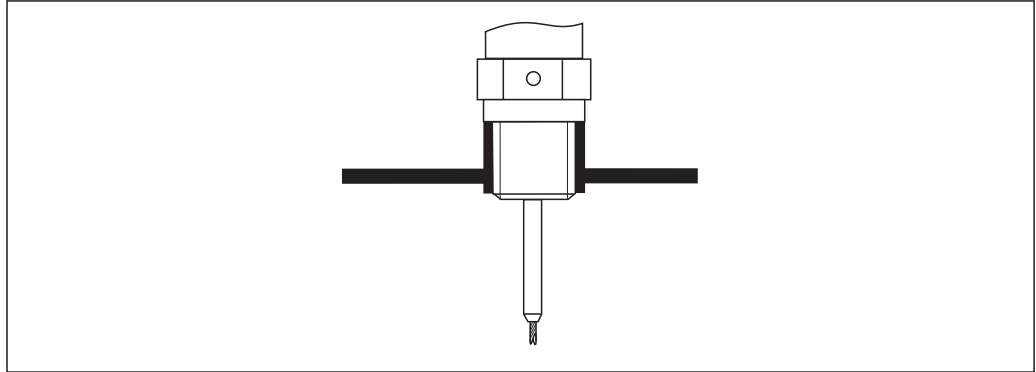

9 Mounting with threaded connection; flush with the vessel ceiling

Seal

The thread and the type of seal comply with DIN 3852 Part 1, screwed plug, form A.

The following types of sealing ring can be used:

- For thread G3/4": According to DIN 7603 with dimensions 27 mm × 32 mm
- For thread G1/-1/2": According to DIN 7603 with dimensions 48 mm × 55 mm

Use a sealing ring according to this standard in form A, C or D and of a material that offers appropriate resistance for the application.

Nozzle mounting

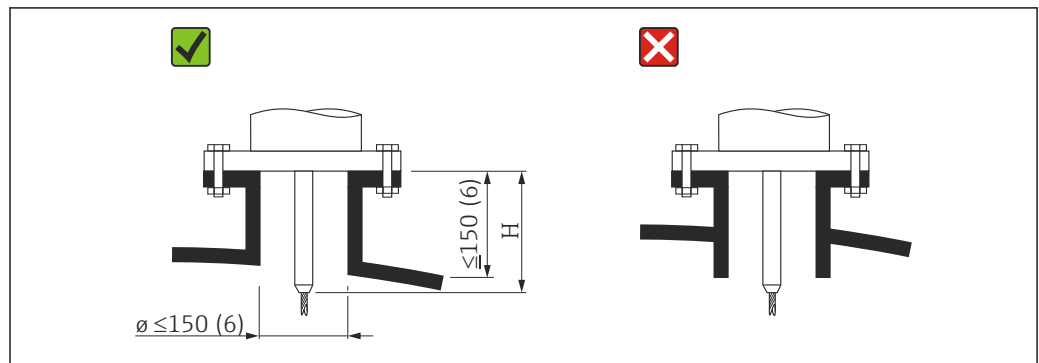

H Length of the centering rod or the rigid part of the rope probe

FMP56

Rope, Ø 4 mm (0.16 in)

Length H:

120 mm (4.7 in)

FMP57

Rope, Ø 4 mm (0.16 in)

Length H:
94 mm (3.7 in)

Rope, Ø 6 mm (0.24 in)

Length H:
135 mm (5.3 in)

- Permissible nozzle diameter: ≤ 150 mm (6 in)
For larger diameters, the near-range measuring capability may be reduced.
For large nozzles, see the section "Mounting in nozzles ≥ DN300"
- Permissible nozzle height: ≤ 150 mm (6 in)
For larger heights, the near-range measuring capability may be reduced.
Larger nozzle heights are possible in special cases (on request), see section "Rod extension/centering device HMP40 for FMP57".
- The end of the nozzle should be flush with the tank ceiling in order to avoid ringing effects.

i In thermally insulated vessels, the nozzle should also be insulated in order to prevent condensate formation.

Rod extension/centering device HMP40 for FMP57

For FMP57 with rope probes, the rod extension/centering device HMP40 is available as an accessory. It must be used if the probe rope would otherwise come into contact with the lower edge of the nozzle.

i This accessory consists of the extension rod, corresponding to the nozzle height, on which a centering disk is also mounted if the nozzles are narrow or when used in bulk solids. We deliver this component separately from the device. Please order a correspondingly shorter probe length.

Only use centering disks with small diameters (DN40 and DN50) if there is no significant build-up in the nozzle above the disk. The nozzle must not become clogged with product.

Mounting in nozzles ≥ DN300

If installation in nozzles ≥ 300 mm (12 in) is unavoidable, installation must be carried out in accordance with the following diagram in order to avoid interference signals in the near range.

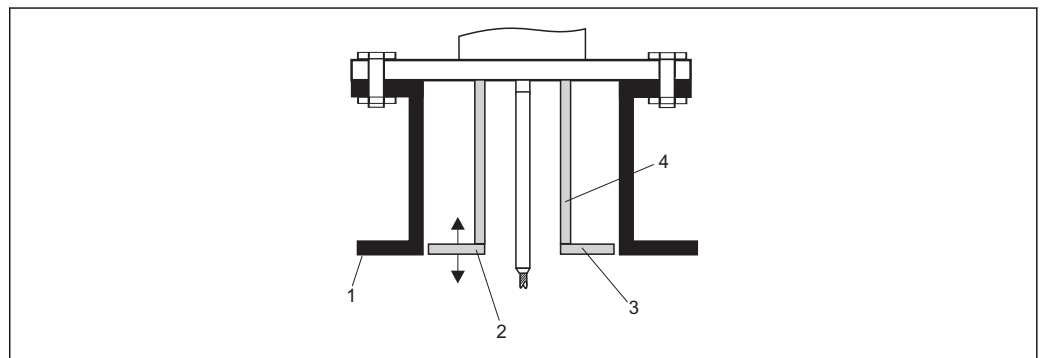

- 1 Lower edge of the nozzle
- 2 Approximately flush with the lower edge of the nozzle (±50 mm)
- 3 Plate, nozzle Ø 300 mm (12 in) = plate Ø 280 mm (11 in); nozzle Ø ≥ 400 mm (16 in) = plate Ø ≥ 350 mm (14 in)
- 4 Pipe Ø 150 to 180 mm

A0014199

6.1.5 Securing the probe

Securing rope probes

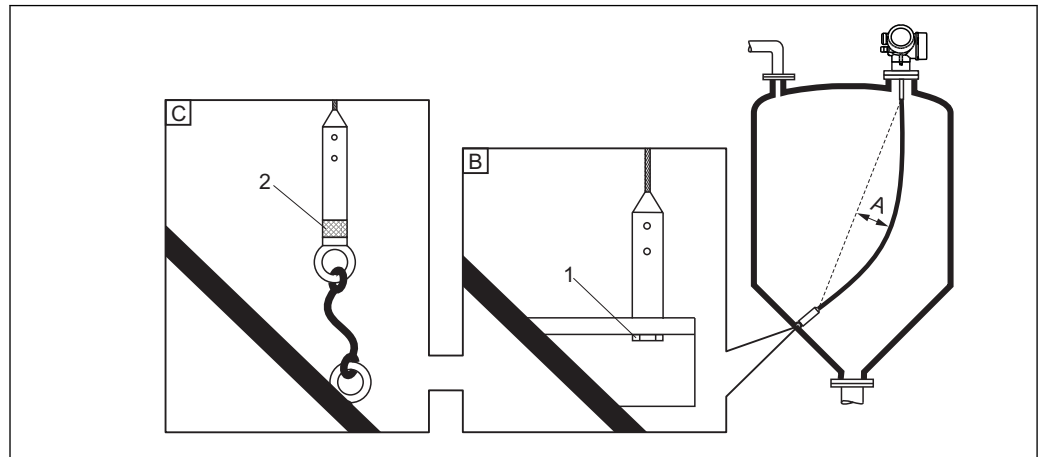

A0012609

- A Rope sag: $\geq 10 \text{ mm}/(1 \text{ m probe length})$ [0.12 in/(1 ft probe length)]
 B Reliably grounded end of probe
 C Reliably insulated end of probe
 1 Fastener in female thread of probe end weight
 2 Insulated fastening kit

- The end of the rope probe must be secured (fixed down) under the following conditions:
 - If the probe would otherwise temporarily come into contact with the vessel wall, the cone, internal fittings/beams or another part of the installation
 - If the probe would otherwise get closer than 0.5 m (1.6 ft) to a concrete wall.
- A female thread is provided in the probe weight to secure the end of the probe:
 - Rope 4 mm (1/6"), 316: M 14
 - Rope 6 mm (1/4"), 316: M 20
 - Rope 6 mm (1/4"), PA>steel: M14
 - Rope 8mm (1/3"), PA>steel: M20
- Far higher tensile loads occur on the probe when it is secured (fixed down). Therefore, preferably use the 6 mm (1/4") rope probe.
- When fixed down, the end of the probe must be either reliably grounded or reliably insulated. Use an insulated fastening kit if it is not otherwise possible to secure the probe with a reliably insulated connection.
- If grounded fastening is used, the search for a positive probe end echo must be activated. Otherwise, automatic probe length correction is not possible.
 Navigation: Expert → Sensor → EOP evaluation → EOP search mode
 Setting: **Positive EOP** option
- To prevent an extremely high tensile load (e.g. due to thermal expansion) and the risk of the rope breaking, the rope must be slack. Required sag: $\geq 10 \text{ mm}/(1 \text{ m rope length})$ [0.12 in/(1 ft rope length)].
 Pay attention to the tensile loading capacity of rope probes.

Securing rod probes

- For WHG approval: A support is required for probe lengths ≥ 3 m (10 ft).
- In general, rod probes must be secured in the event of horizontal flow (e.g. from an agitator) or strong vibrations.
- Only secure rod probes directly at the end of the probe.

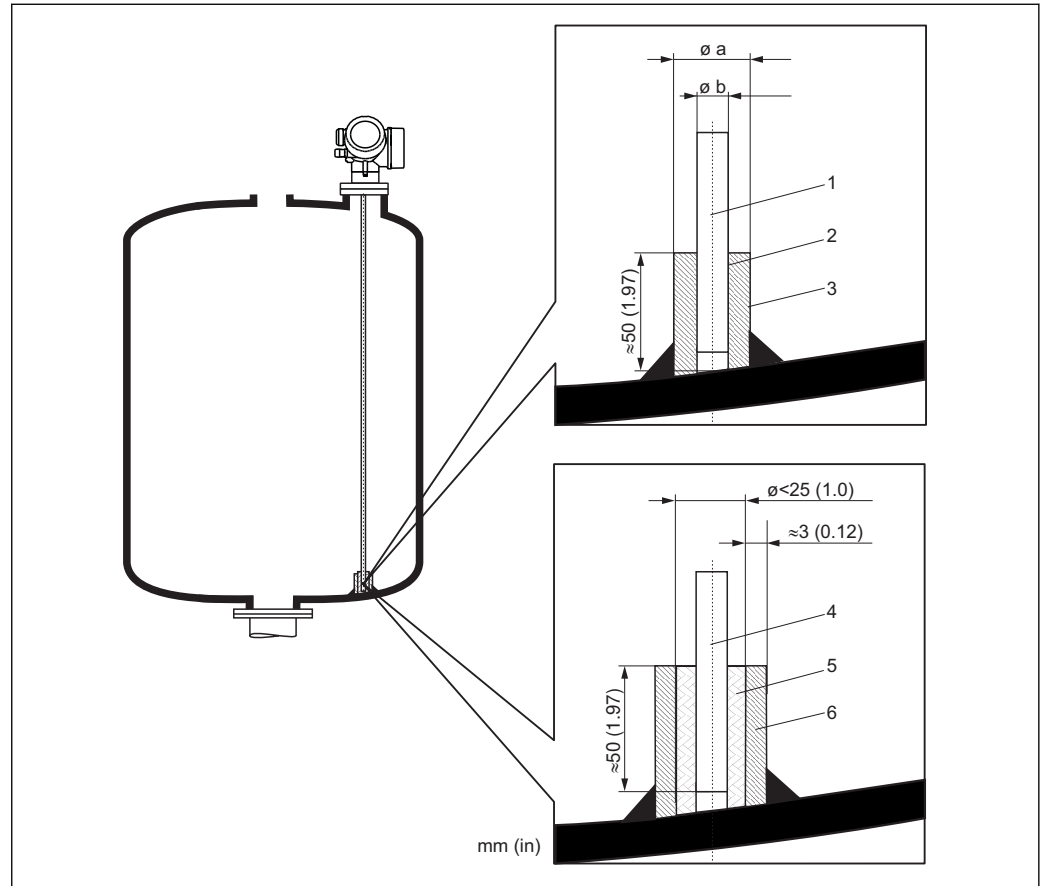

A0012607

Unit of measurement mm (in)

- 1 Probe rod, uncoated
- 2 Sleeve with narrow bore to ensure electrical contact between the sleeve and the rod.
- 3 Short metal pipe, e.g. welded in place
- 4 Probe rod, coated
- 5 Plastic sleeve, e.g. PTFE, PEEK, PPS
- 6 Short metal pipe, e.g. welded in place

NOTICE

Poor grounding of the probe end may cause incorrect measurements.

- ▶ Use a sleeve with a narrow bore to ensure good electrical contact between the sleeve and the probe rod.

NOTICE

Welding can damage the main electronics module.

- ▶ Before welding: Ground the probe rod and remove the electronics.

6.1.6 Special installation situations

Concrete silos

Installation in a thick concrete ceiling, for example, should be flush with the lower edge. Alternatively, the probe can also be installed in a pipe that must not protrude over the lower edge of the silo ceiling. The pipe should be as short as possible. For installation suggestions, see the diagram below.

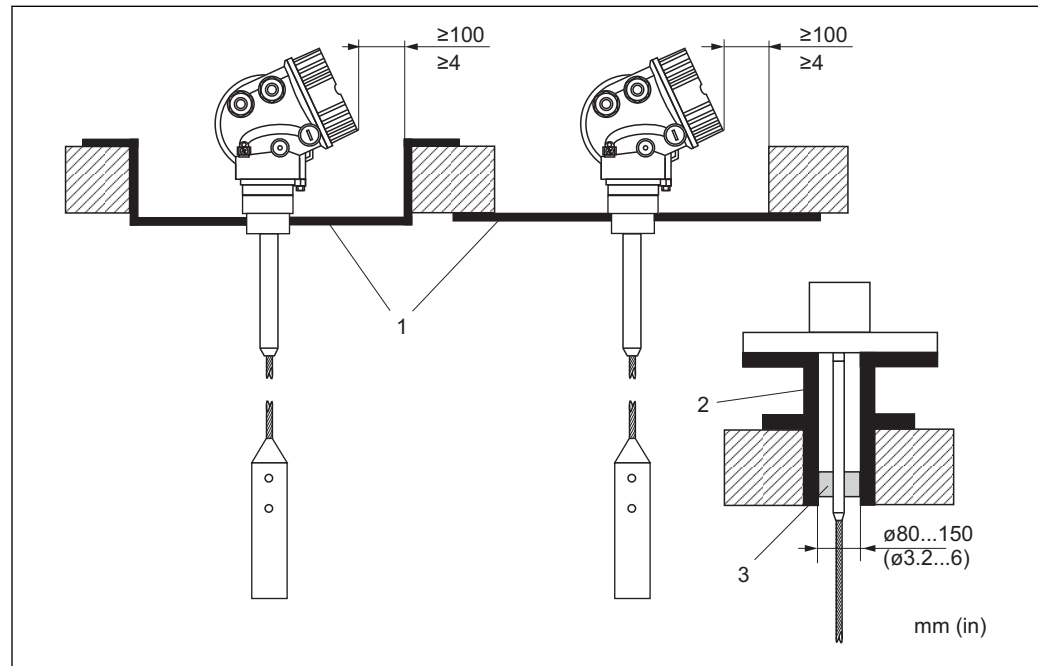

A0014138

- 1 Metal plate
- 2 Metal pipe
- 3 Rod extension/centering device HMP40 (see "Accessories")

i Installation with rod extension/centering device (accessory):

Strong dust generation can lead to build-up behind the centering disk. This can result in interference reflections. For other installation options, please contact Endress +Hauser.

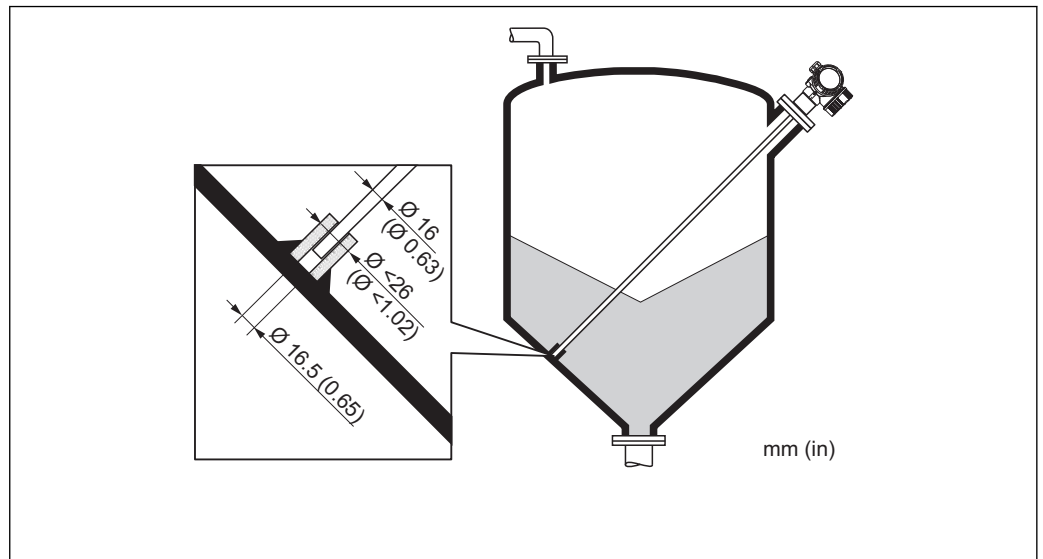
Mounting from the side

- If installation from above is not possible, the device can also be mounted from the side
- Always secure the rope probe in this case
- Support the rod and coax probe if the lateral load-bearing capacity is exceeded
- Only secure rod probes at the end of the probe

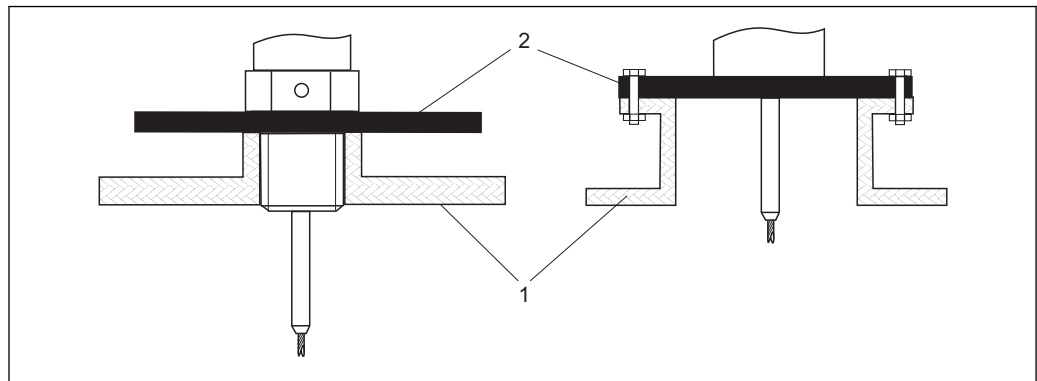
Non-metal vessels

A0012527

- 1 *Non-metal vessel*
2 *Metal sheet or metal flange*

To ensure good measurement results when mounting on non-metal vessels

- Use a device with a metal flange (minimum size DN50/2").
- Alternatively: at the process connection, mount a metal sheet with a diameter of at least 200 mm (8 in) at a right angle to the probe.

Vessel with thermal insulation

i If process temperatures are high, the device must be included in normal vessel insulation (1) in order to prevent the electronics heating up as a result of thermal radiation or convection. The insulation may not go beyond the points labeled "MAX" in the drawings.

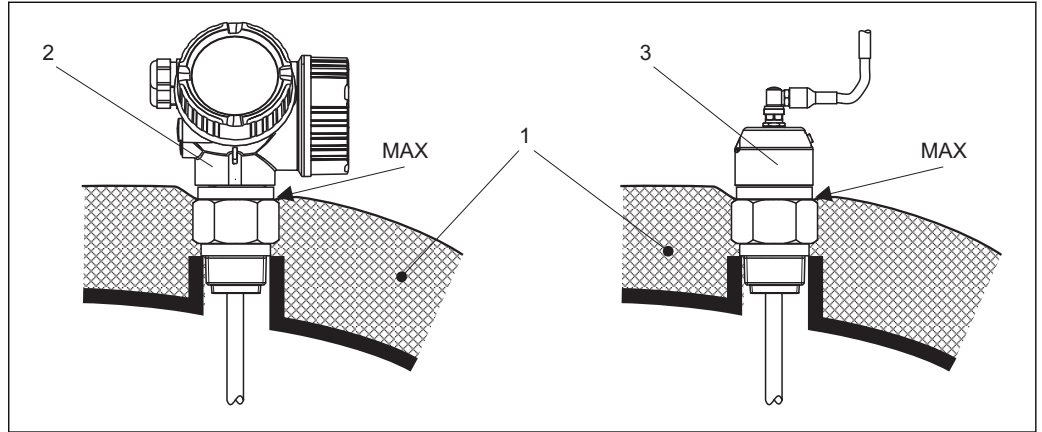

A0014653

10 Process connection with thread

- 1 Vessel insulation
- 2 Compact device
- 3 Sensor, remote

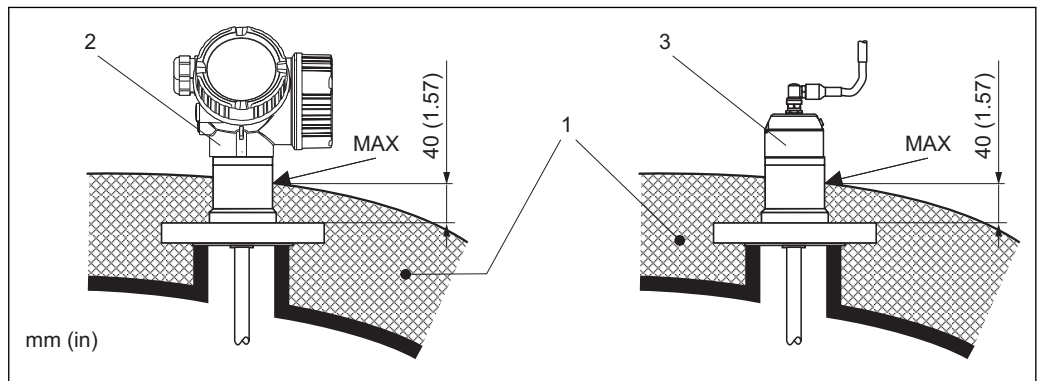

A0014654

11 Process connection with flange - FMP57

- 1 Vessel insulation
- 2 Compact device
- 3 Sensor, remote

6.2 Mounting the measuring device

6.2.1 Tools list

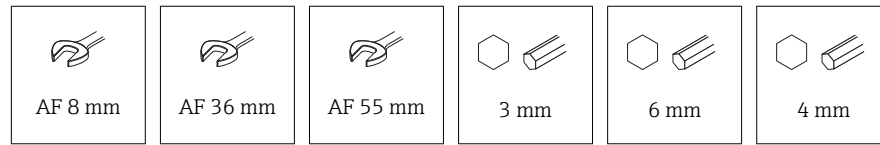

- To shorten rope probes: use a saw or bolt cutters
- To shorten rod or coax probes: use a saw
- For flanges and other process connections, use an appropriate mounting tool

6.2.2 Shortening the probe

Shortening rod probes

Rod probes must be shortened if the distance to the vessel base or outlet cone is less than 10 mm (0.4 in). To shorten, saw off the bottom end of the rod probe.

Shortening rope probes

Rope probes must be shortened if the distance to the vessel base or outlet cone is less than 150 mm (6 in).

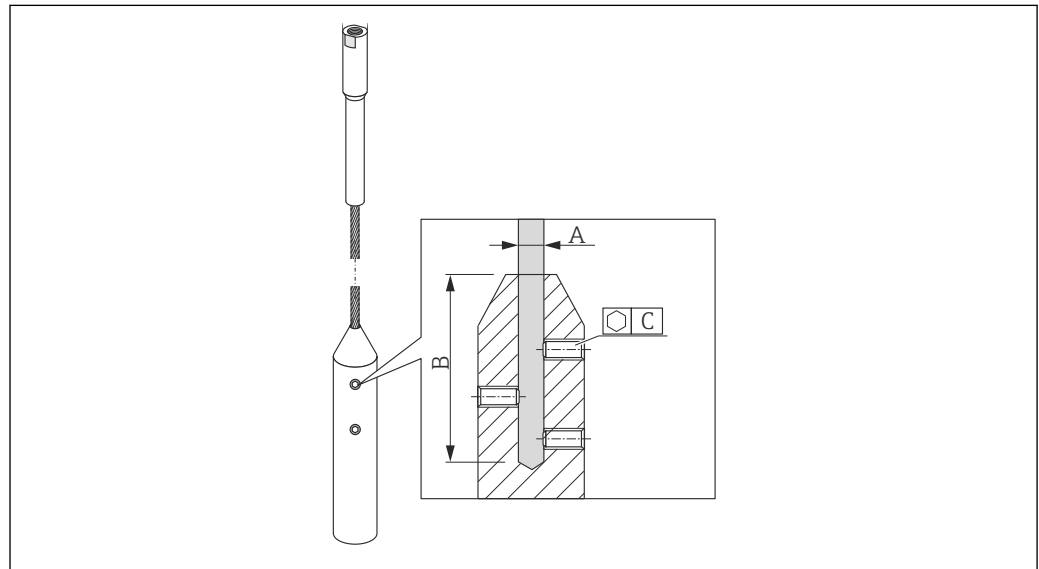

A0021693

Rope material 316

- A:
4 mm (0.16 in)
- B:
40 mm (1.6 in)
- C:
3 mm; 5 Nm (3.69 lbf ft)

Rope material 316

- A:
6 mm (0.24 in)
- B:
55 mm (2.2 in)
- C:
4 mm; 15 Nm (11.06 lbf ft)

Rope material PA > steel

- A:
6 mm (0.24 in)
- B:
40 mm (1.6 in)
- C:
3 mm; 5 Nm (3.69 lbf ft)

Rope material PA > steel

- A:
8 mm (0.31 in)
- B:
55 mm (2.2 in)
- C:
4 mm; 15 Nm (11.06 lbf ft)

1. Using an Allen key, loosen the set screws on the rope weight. Note: The setscrews have a clamping coating in order to prevent them from becoming loose accidentally. A higher torque is therefore required to loosen the screws.
2. Remove the released rope from the weight.
3. Measure off the new rope length.
4. At the point to be shortened, wrap adhesive tape around the rope to prevent it from fraying.
5. Saw off the rope at a right angle or cut it off with a bolt cutter.
6. Insert the rope completely into the weight.
7. Screw the setscrews back into place. Due to the clamping coating of the setscrews, it is not necessary to apply a locking compound.

Entering the new probe length

After shortening the probe:

1. Go to the **Probe settings** submenu and perform a probe length correction.

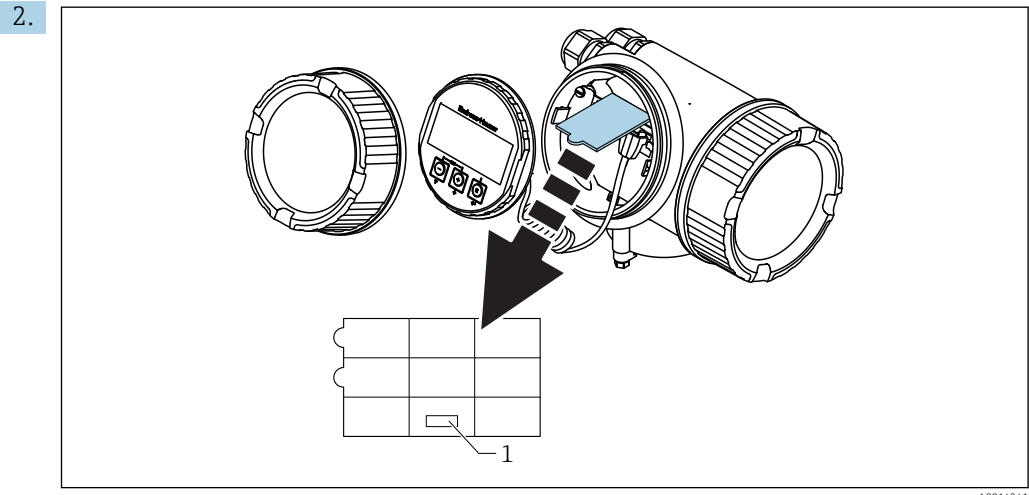

1 Field for the new probe length

For documentation purposes, enter the new probe length into the quick reference guide which can be found in the electronics housing behind the display module.

6.2.3 Mounting the device

Mounting devices with a threaded connection

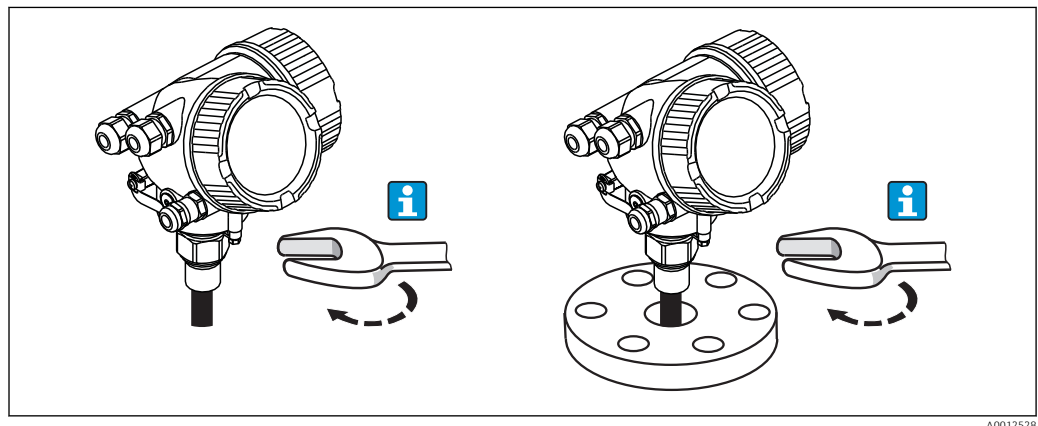

Screw the device with the threaded connection into a sleeve or flange and then secure it to the process vessel via the sleeve/flange.

- i**
 - When screwing into place, turn by the hex bolt only:
 - Thread 3/4": \approx 36 mm
 - Thread 1-1/2": \approx 55 mm
 - Maximum permissible tightening torque:
 - Thread 3/4": 45 Nm
 - Thread 1-1/2": 450 Nm
 - Recommended torque when using the supplied aramid fiber seal and a process pressure of 40 bar (only FMP51, no seal is included with FMP54):
 - Thread 3/4": 25 Nm
 - Thread 1-1/2": 140 Nm
 - When installing in metal vessels, ensure there is good metal contact between the process connection and the vessel.

Mounting devices with a flange

If a seal is used to mount the device, use uncoated metal screws to ensure good electrical contact between the process flange and the probe flange.

Mounting rope probes

NOTICE

Electrostatic discharge can damage the electronics.

- ▶ Ground the housing before lowering the rope probe into the vessel.

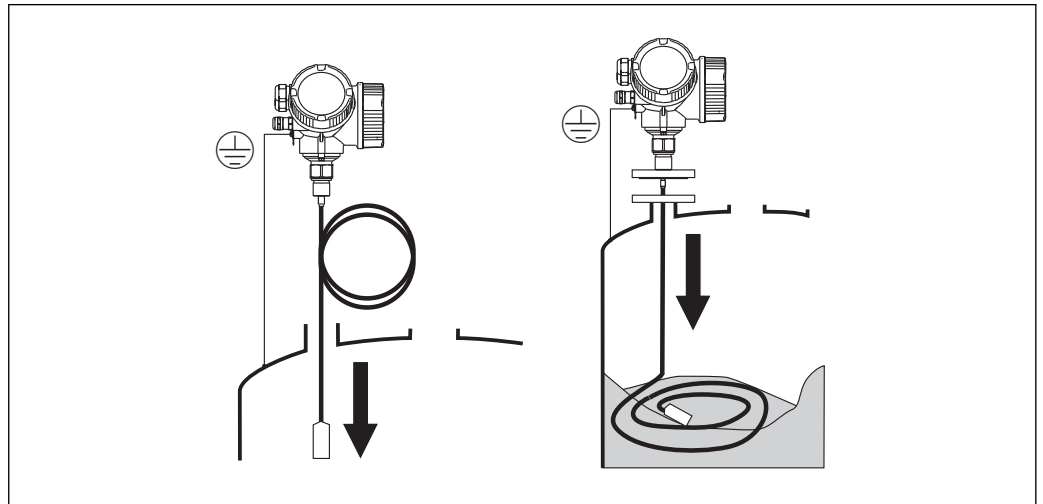

A0012529

Pay attention to the following when introducing the rope probe into the vessel:

- Uncoil the rope slowly and lower it carefully into the vessel.
- Make sure the rope does not bend or buckle.
- Avoid uncontrolled swinging of the weight, as this could damage internal fittings in the vessel.

i Mounting rope probes in a partially filled silo

If a silo is retrofitted with a Levelflex, it is not always possible to empty the silo. If the vessel is at least 2/3 empty, it is possible to mount the rope probe even in a partially filled silo. In this case, if possible perform a visual inspection after mounting: the rope should not become tangled or knotted when the silo is emptied. The probe rope must hang fully extended before an accurate measurement can be performed.

6.2.4 Mounting the "Sensor, remote" version

i This section only applies for devices with the version "Probe design" = "Sensor, remote" (feature 600, version MB/MC/MD).

The following is included in the delivery with the version "Probe design" = "Remote":

- The probe with process connection
- The electronics housing
- The mounting bracket for mounting the electronics housing on a wall or post
- The connection cable (length as ordered). The cable has one straight plug and one plug angled at 90°. Depending on the local conditions the angled plug can be connected at the probe or at the electronics housing.

⚠ CAUTION

Mechanical stress can damage the plugs of the connection cable or cause them to become loose.

- ▶ Mount the probe and the electronics housing securely before connecting the connecting cable.
- ▶ Lay the connecting cable in such a way that it is not exposed to mechanical stress. Minimum bending radius: 100 mm (4 in).
- ▶ When connecting the cable, connect the straight plug before you connect the angled plug. Torque for the union nuts of both plugs: 6 Nm.

i The probe, electronics and connection cable are mutually compatible and bear a common serial number. Only components with the same serial number may be connected to one another.

In the event of strong vibrations, a locking compound, e.g. Loctite 243, can also be used on the plug-in connectors.

Mounting the electronics housing

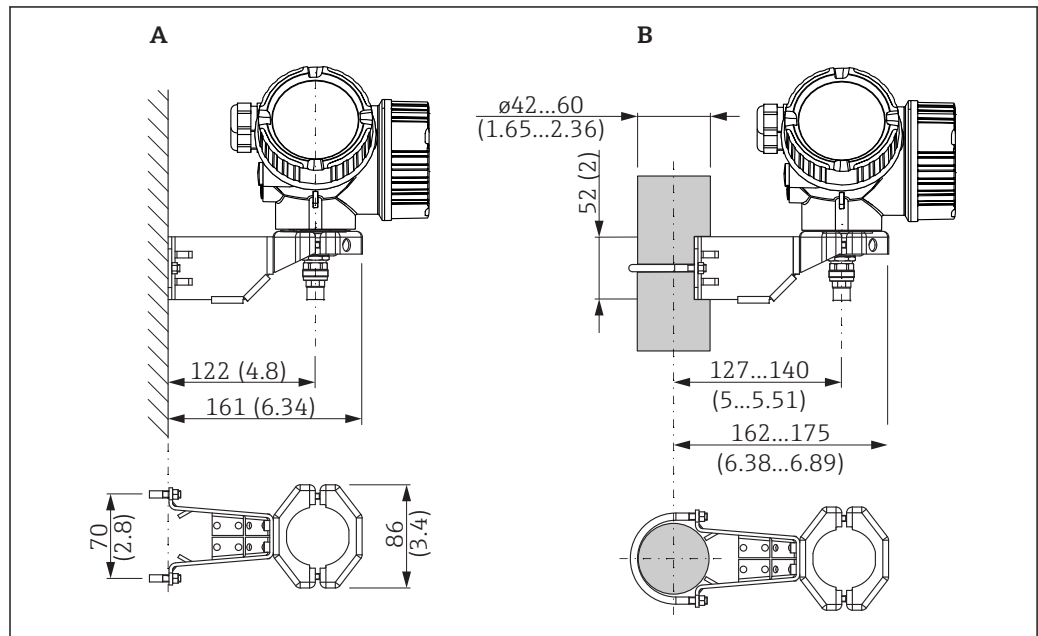

12 Mounting the electronics housing with the mounting bracket. Unit of measurement mm (in)

- A Wall mounting
- B Post mounting

Connecting the connecting cable



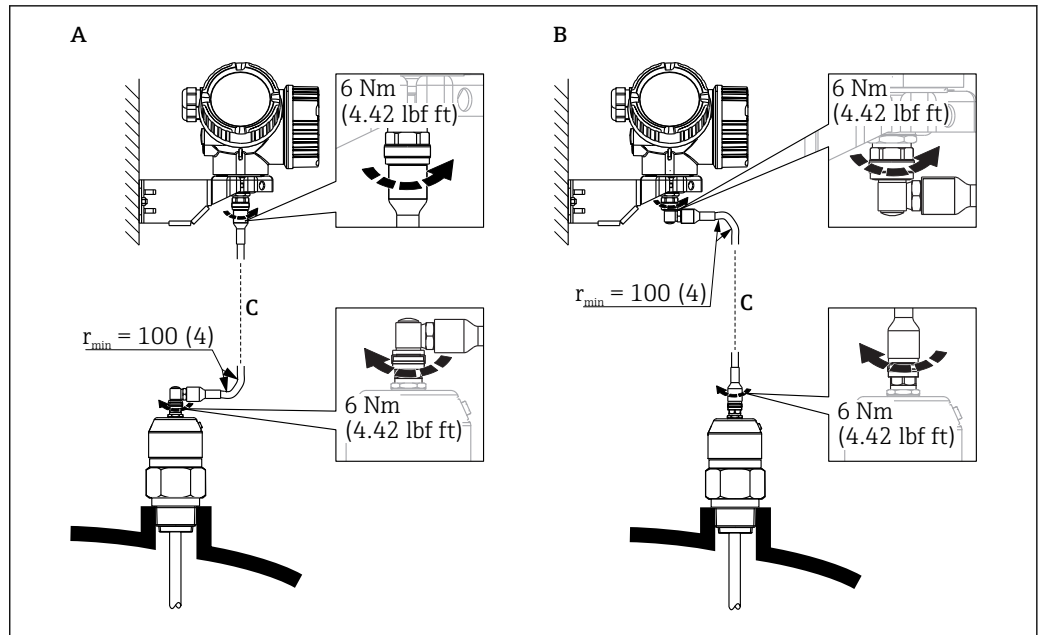

A0014794

13 Connecting the connecting cable. The cable can be connected in the following ways: Unit of measurement mm (in)

- A Angled plug at the probe
- B Angled plug at the electronics housing
- C Length of the remote cable as ordered

6.2.5 Turning the transmitter housing

To provide easier access to the connection compartment or display module, the transmitter housing can be turned:

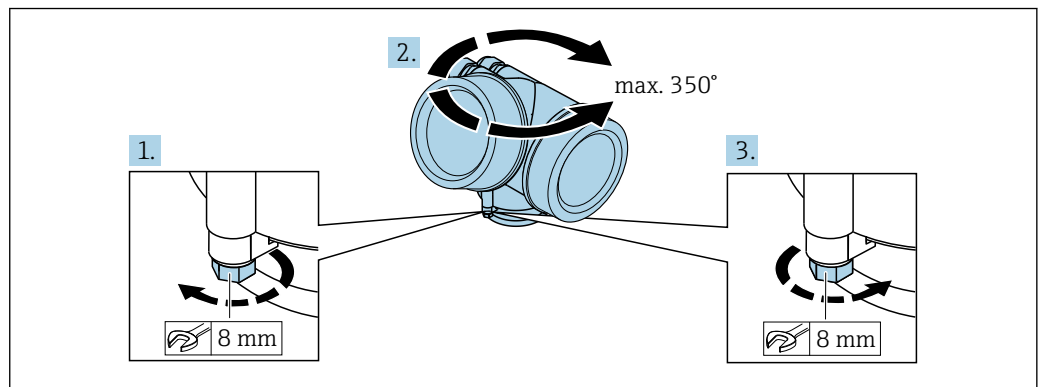

A0032242

1. Unscrew the securing screw using an open-ended wrench.
2. Rotate the housing in the desired direction.
3. Tighten the securing screw (1.5 Nm for plastic housing; 2.5 Nm for aluminum or stainless steel housing).

6.2.6 Turning the display

Opening the cover

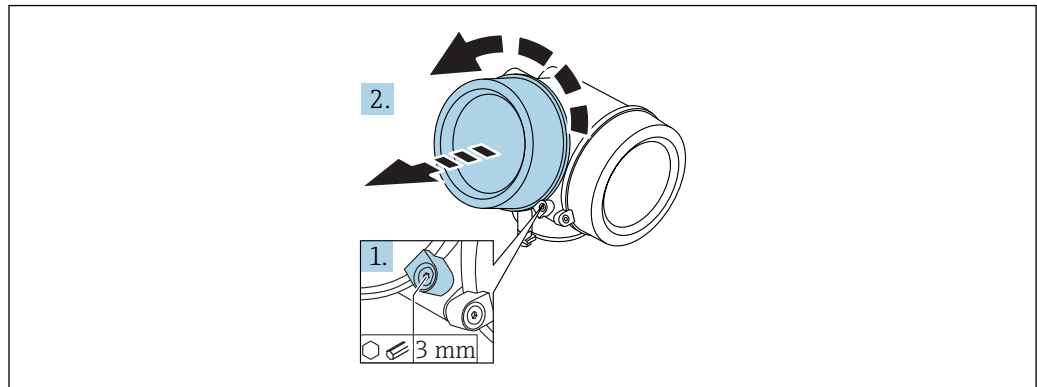

1. Loosen the screw of the securing clamp of the electronics compartment cover using an Allen key (3 mm) and turn the clamp 90 ° counterclockwise.
2. Unscrew the cover and check the cover seal, replace it if necessary.

Turning the display module

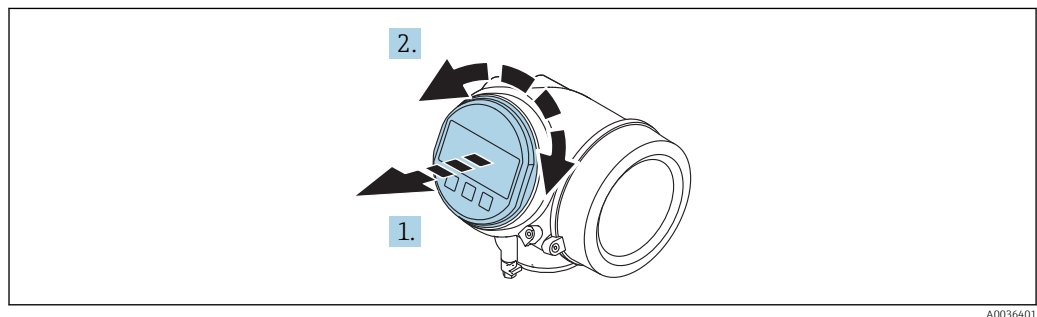

1. Pull out the display module with a gentle rotational movement.
2. Turn the display module to the desired position: max. $8 \times 45^\circ$ in each direction.
3. Feed the coiled cable into the gap between the housing and main electronics module and plug the display module into the electronics compartment until it engages.

Closing the cover of the electronics compartment

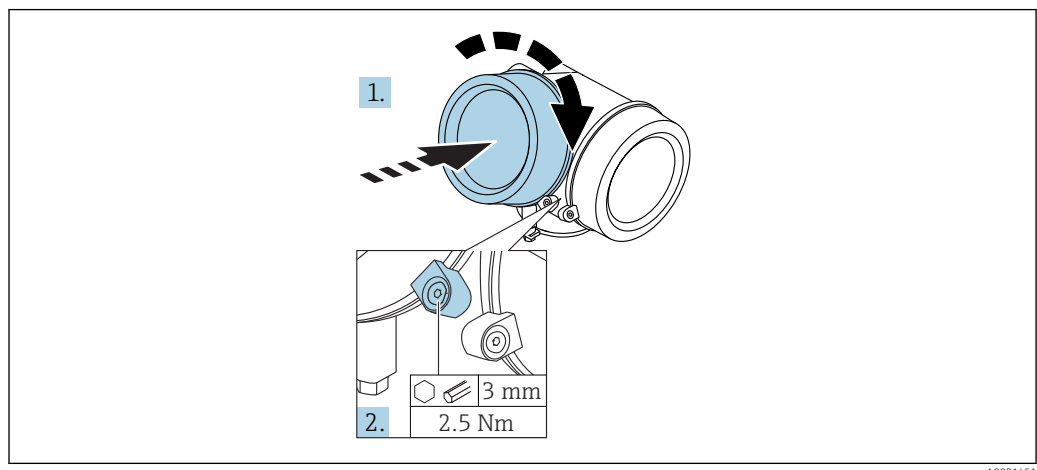

1. Screw down the cover of the electronics compartment.
2. Turn the securing clamp 90 ° clockwise and tighten the screw of the securing clamp of the electronics compartment cover with 3 mm using the Allen key (2.5 Nm).

6.3 Post-installation check

- Is the device undamaged (visual inspection)?
- Does the device comply with the measuring point specifications?
 - Process temperature
 - Process pressure
 - Ambient temperature range
 - Measuring range
- Are the measuring point identification and labeling correct (visual inspection)?
- Is the device adequately protected against precipitation and direct sunlight?
- Is the device adequately protected against impact?
- Are all mounting and safety screws securely tightened?
- Is the device properly secured?

7 Electrical connection

7.1 Connection conditions

7.1.1 Terminal assignment

Terminal assignment 2-wire: 4-20 mA HART

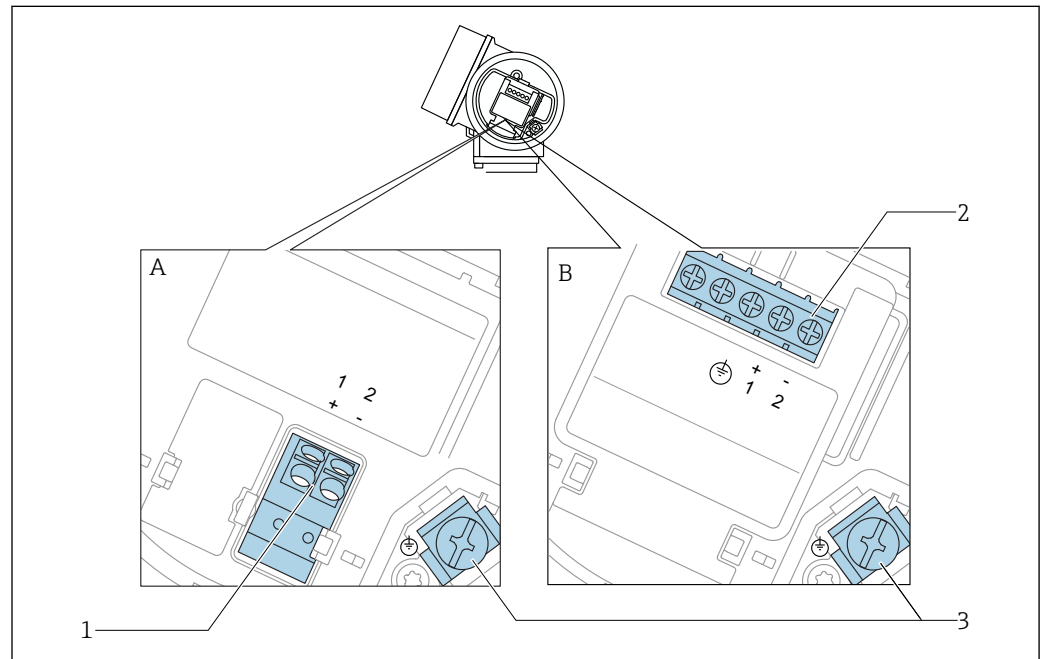

14 Terminal assignment 2-wire: 4-20 mA HART

A Without integrated overvoltage protection

B With integrated overvoltage protection

1 Connection 4-20 mA HART passive: terminals 1 and 2, without integrated overvoltage protection

2 Connection 4-20 mA HART passive: terminals 1 and 2, with integrated overvoltage protection

3 Terminal for cable screen

Block diagram 2-wire: 4-20 mA HART

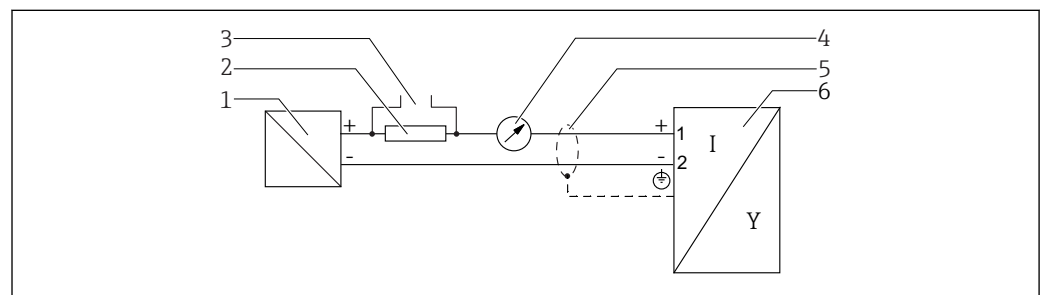

15 Block diagram 2-wire: 4-20 mA HART

1 Active barrier with power supply (e.g. RN221N); observe terminal voltage

2 HART communication resistor ($\geq 250 \Omega$); observe maximum load

3 Connection for Commubox FXA195 or FieldXpert SFX350/SFX370 (via VIATOR Bluetooth modem)

4 Analog display device; observe maximum load

5 Cable screen; observe cable specification

6 Measuring device

Terminal assignment 2-wire: 4-20 mA HART, switch output

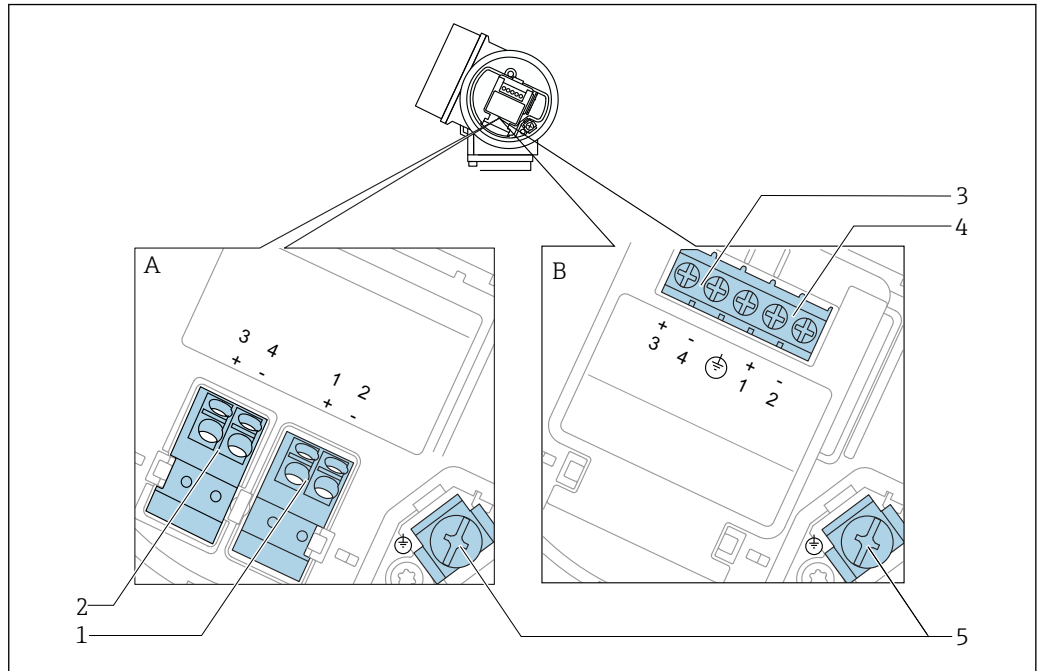

A0036500

16 Terminal assignment 2-wire: 4-20 mA HART, switch output

A Without integrated overvoltage protection

B With integrated overvoltage protection

1 Connection 4-20 mA HART passive: terminals 1 and 2, without integrated overvoltage protection

2 Connection switch output (Open Collector): terminals 3 and 4, without integrated overvoltage protection

3 Connection switch output (Open Collector): terminals 3 and 4, with integrated overvoltage protection

4 Connection 4-20 mA HART passive: terminals 1 and 2, with integrated overvoltage protection

5 Terminal for cable screen

Block diagram 2-wire: 4-20 mA HART, switch output

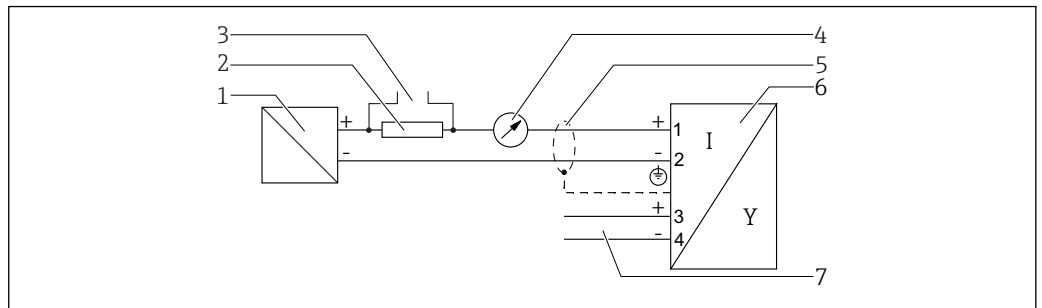

A0036501

17 Block diagram 2-wire: 4-20 mA HART, switch output

1 Active barrier with power supply (e.g. RN221N); observe terminal voltage

2 HART communication resistor ($\geq 250 \Omega$); observe maximum load

3 Connection for Commubox FXA195 or FieldXpert SFX350/SFX370 (via VIATOR Bluetooth modem)

4 Analog display device; observe maximum load

5 Cable screen; observe cable specification

6 Measuring device

7 Switch output (Open Collector)

Terminal assignment 2-wire: 4-20 mA HART, 4-20 mA

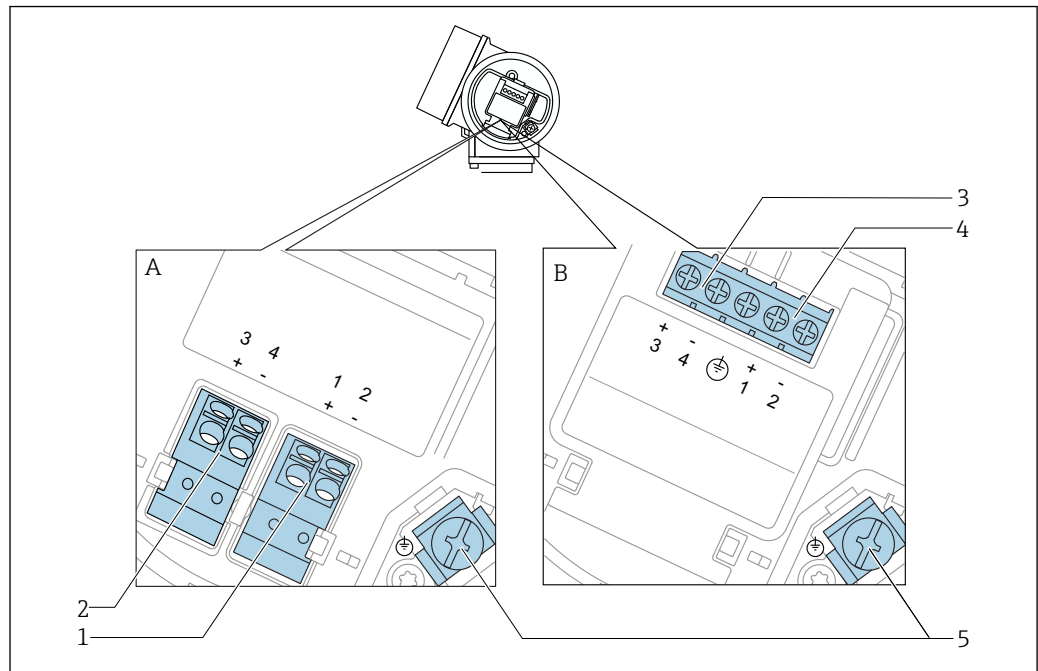

A0036500

18 Terminal assignment 2-wire: 4-20 mA HART, 4-20 mA

- A Without integrated overvoltage protection
- B With integrated overvoltage protection
- 1 Connection current output 1, 4-20 mA HART passive: terminals 1 and 2, without integrated overvoltage protection
- 2 Connection current output 2, 4-20 mA: terminals 3 and 4, without integrated overvoltage protection
- 3 Connection current output 2, 4-20 mA: terminals 3 and 4, with integrated overvoltage protection
- 4 Connection current output 1, 4-20 mA HART passive: terminals 1 and 2, with integrated overvoltage protection
- 5 Terminal for cable screen

Block diagram 2-wire: 4-20 mA HART, 4-20 mA

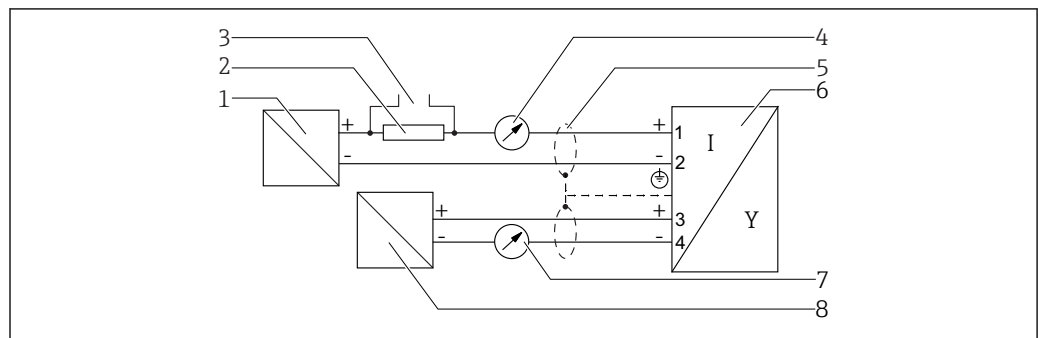

A0036502

19 Block diagram 2-wire: 4-20 mA HART, 4-20 mA

- 1 Active barrier with power supply (e.g. RN221N); observe terminal voltage
- 2 HART communication resistor ($\geq 250 \Omega$); observe maximum load
- 3 Connection for Commubox FXA195 or FieldXpert SFX350/SFX370 (via VIATOR Bluetooth modem)
- 4 Analog display device; observe maximum load
- 5 Cable screen; observe cable specification
- 6 Measuring device
- 7 Analog display device; observe maximum load
- 8 Active barrier with power supply (e.g. RN221N), current output 2; observe terminal voltage

Terminal assignment 4-wire: 4-20 mA HART (10.4 to 48 V_{DC})

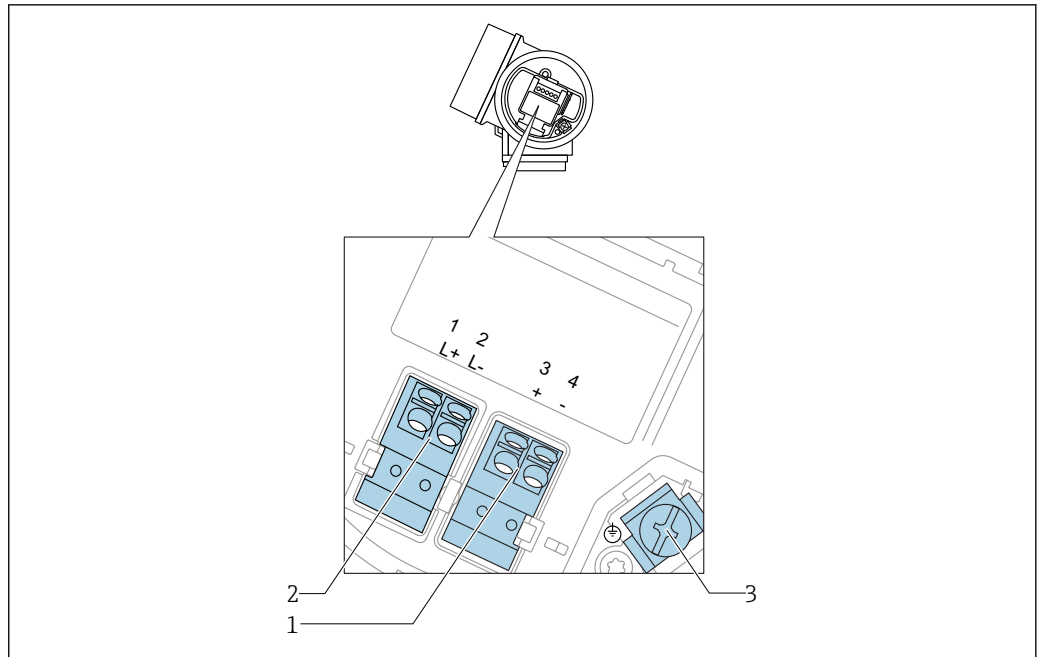

A0036516

20 Terminal assignment 4-wire: 4-20 mA HART (10.4 to 48 V_{DC})

- 1 Connection 4-20 mA HART (active): terminals 3 and 4
- 2 Connection supply voltage: terminals 1 and 2
- 3 Terminal for cable screen

Block diagram 4-wire: 4-20 mA HART (10.4 to 48 V_{DC})

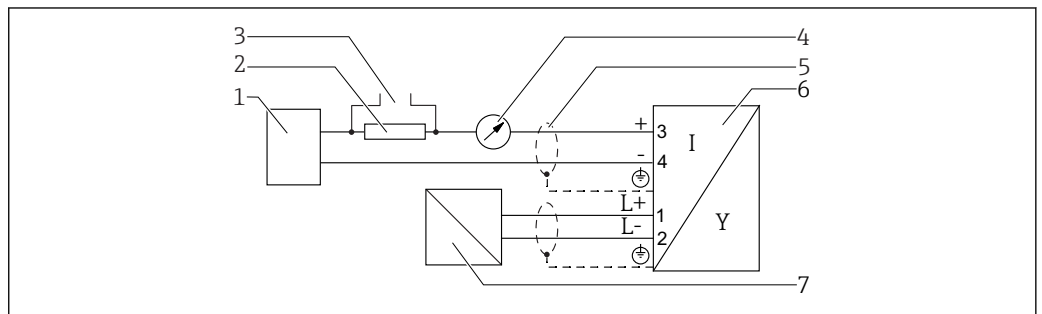

A0036526

21 Block diagram 4-wire: 4-20 mA HART (10.4 to 48 V_{DC})

- 1 Evaluation unit, e.g. PLC
- 2 HART communication resistor ($\geq 250 \Omega$); observe maximum load
- 3 Connection for Commubox FXA195 or FieldXpert SFX350/SFX370 (via VIATOR Bluetooth modem)
- 4 Analog display device; observe maximum load
- 5 Cable screen; observe cable specification
- 6 Measuring device
- 7 Supply voltage; observe terminal voltage, observe cable specification

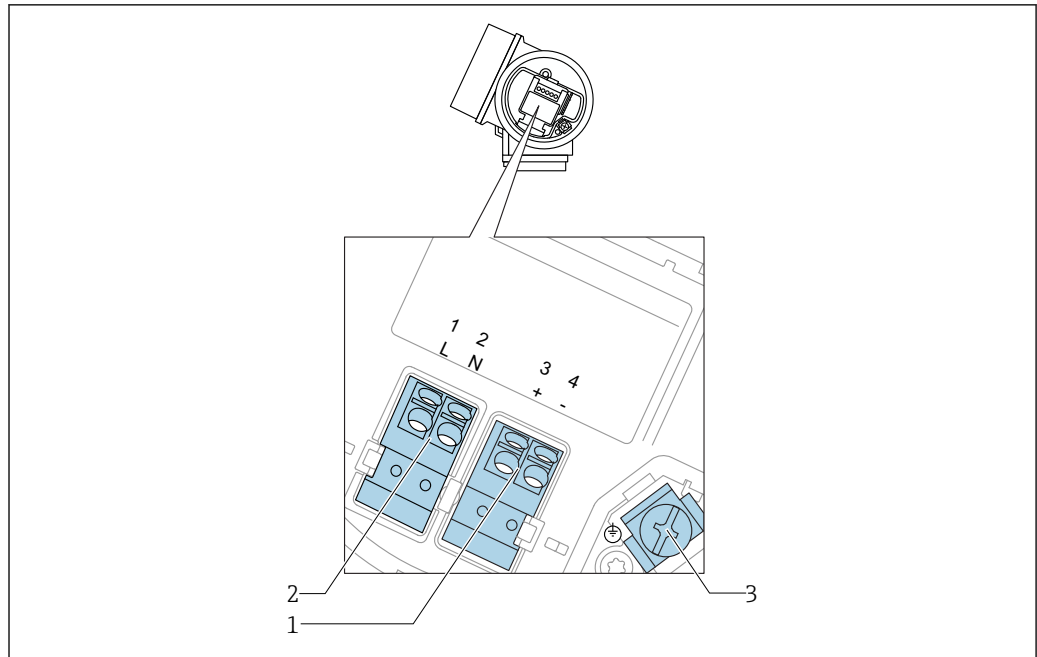
Terminal assignment 4-wire: 4-20 mA HART (90 to 253 V_{AC})

A0036519

22 Terminal assignment 4-wire: 4-20 mA HART (90 to 253 V_{AC})

- 1 Connection 4-20 mA HART (active): terminals 3 and 4
- 2 Connection supply voltage: terminals 1 and 2
- 3 Terminal for cable screen

CAUTION**To ensure electrical safety:**

- ▶ Do not disconnect the protective connection.
- ▶ Disconnect the supply voltage before disconnecting the protective earth.

- i** Connect protective earth to the internal ground terminal (3) before connecting the supply voltage. If necessary, connect the potential matching line to the external ground terminal.
- i** In order to ensure electromagnetic compatibility (EMC): Do **not** only ground the device via the protective earth conductor of the supply cable. Instead, the functional grounding must also be connected to the process connection (flange or threaded connection) or to the external ground terminal.
- i** An easily accessible power switch must be installed in the proximity of the device. The power switch must be marked as a disconnector for the device (IEC/EN61010).

Block diagram 4-wire: 4-20 mA HART (90 to 253 V_{AC})

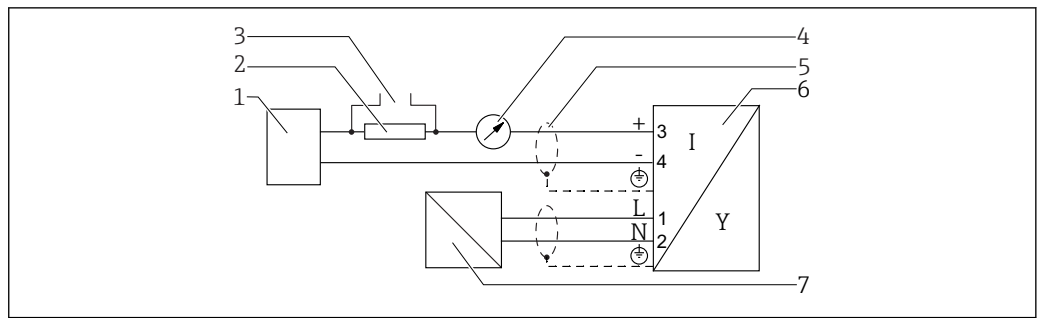

A0036527

23 Block diagram 4-wire: 4-20 mA HART (90 to 253 V_{AC})

- 1 Evaluation unit, e.g. PLC
- 2 HART communication resistor ($\geq 250 \Omega$); observe maximum load
- 3 Connection for Commubox FXA195 or FieldXpert SFX350/SFX370 (via VIATOR Bluetooth modem)
- 4 Analog display device; observe maximum load
- 5 Cable scree; observe cable specification
- 6 Measuring device
- 7 Supply voltage; observe terminal voltage, observe cable specification

Connection examples for the switch output

i For HART devices, the switch output is available as an option.

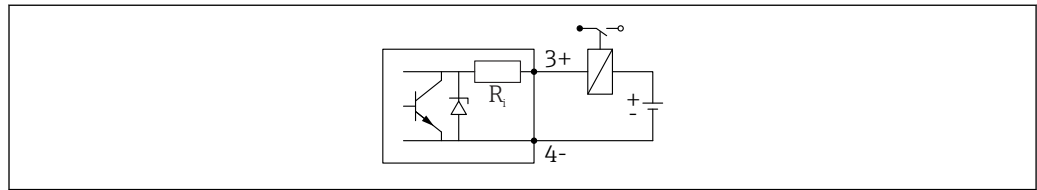

A0015909

24 Connection of a relay

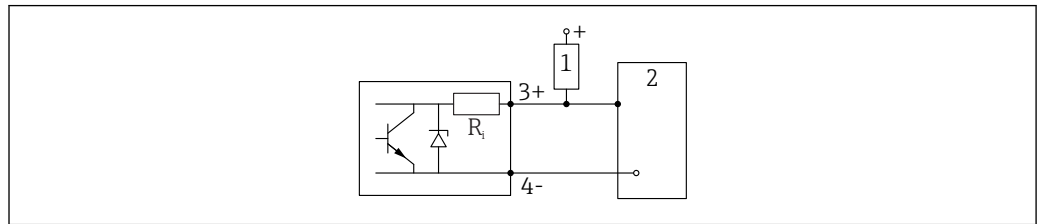

A0015910

25 Connection to a digital input

- 1 Pull-up resistor
- 2 Digital input

i For optimum interference immunity we recommend to connect an external resistor (internal resistance of the relay or pull-up resistor) of $< 1\,000\ \Omega$.

7.1.2 Cable specification

■ Devices without integrated overvoltage protection

Pluggable spring-force terminals for wire cross-sections 0.5 to $2.5\ \text{mm}^2$ (20 to 14 AWG)

■ Devices with integrated overvoltage protection

Screw terminals for wire cross-sections 0.2 to $2.5\ \text{mm}^2$ (24 to 14 AWG)

- For ambient temperature $T_U \geq 60\ ^\circ\text{C}$ ($140\ ^\circ\text{F}$): use cable for temperature $T_U + 20\ \text{K}$.

HART

- A normal device cable suffices if only the analog signal is used.
- A shielded cable is recommended if using the HART protocol. Observe grounding concept of the plant.
- For 4-wire devices: Standard device cable is sufficient for the power line.

7.1.3 Device plugs

 In device versions with a device plug (M12 or 7/8"), it is not necessary to open the housing in order to connect the signal cable.

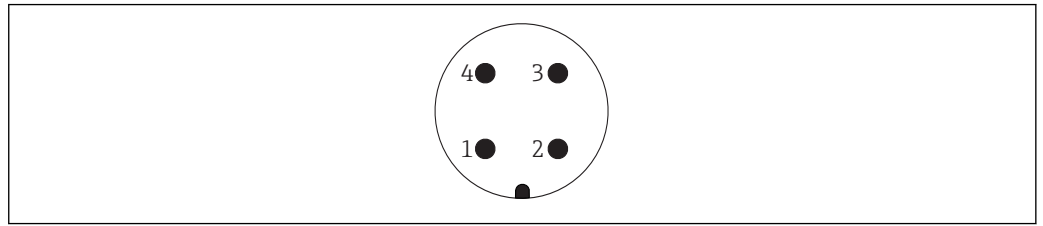

A0011175

 26 Pin assignment of M12 plug

- 1 Signal +
- 2 Not assigned
- 3 Signal -
- 4 Ground

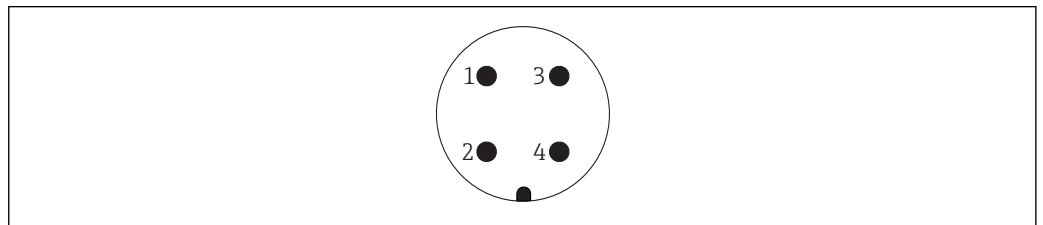

A0011176

 27 Pin assignment of 7/8" plug

- 1 Signal -
- 2 Signal +
- 3 Not assigned
- 4 Shielding

7.1.4 Power supply

2-wire, 4-20mA HART, passive

2-wire; 4-20mA HART¹⁾

"Approval" ²⁾	Terminal voltage U at the device	Maximum load R, depending on the supply voltage U ₀ at the supply unit
<ul style="list-style-type: none"> ■ Non-Ex ■ Ex nA ■ Ex ic ■ CSA GP 	11.5 to 35 V ^{3) 4)}	<p style="text-align: right; font-size: small;">A0035511</p>
Ex ia / IS	11.5 to 30 V ⁴⁾	
<ul style="list-style-type: none"> ■ Ex d / XP ■ Ex ic[ia] ■ Ex tD / DIP 	13.5 to 30 V ^{4) 5)}	<p style="text-align: right; font-size: small;">A0034969</p>

1) Feature 020 of the product structure: option A

2) Feature 010 of the product structure

3) For ambient temperatures $T_a \leq -30\text{ °C}$ (-22 °F) a minimum voltage of 14 V is required for the startup of the device at the minimum error current (3,6 mA). For ambient temperatures $T_a \geq 60\text{ °C}$ (140 °F) a minimum voltage of 12V is required for the sartup of the device at the minimum error current (3,6 mA). The startup current can be parametrized. If the device is operated with a fixed current $I \geq 4,5\text{ mA}$ (HART multidrop mode), a voltage of $U \geq 11,5\text{ V}$ is sufficient throughout the entire range of ambient temperatures.

4) If the Bluetooth modem is used, the minimum supply voltage increases by 2 V.

5) For ambient temperatures $T_a \leq -20\text{ °C}$ (-4 °F) a minimum voltage of 16 V is required for the startup of the device at the minimum error current (3.6 mA).

2-wire; 4-20 mA HART, switch output ¹⁾

"Approval" ²⁾	Terminal voltage U at the device	Maximum load R, depending on the supply voltage U ₀ at the supply unit
<ul style="list-style-type: none"> ▪ Non-Ex ▪ Ex nA ▪ Ex nA[ia] ▪ Ex ic ▪ Ex ic[ia] ▪ Ex d[ia] / XP ▪ Ex ta / DIP ▪ CSA GP 	13.5 to 35 V ^{3) 4)}	<p style="text-align: right; font-size: small;">A0034971</p>
<ul style="list-style-type: none"> ▪ Ex ia / IS ▪ Ex ia + Ex d[ia] / IS + XP 	13.5 to 30 V ^{3) 4)}	

- 1) Feature 020 of the product structure: option B
- 2) Feature 010 of the product structure
- 3) For ambient temperatures $T_a \leq -30\text{ °C}$ (-22 °F) a minimum voltage of 16 V is required for the startup of the device at the minimum error current (3.6 mA).
- 4) If the Bluetooth modem is used, the minimum supply voltage increases by 2 V.

2-wire; 4-20mA HART, 4-20mA ¹⁾

"Approval" ²⁾	Terminal voltage U at the device	Maximum load R, depending on the supply voltage U ₀ at the supply unit
any	Channel 1: 13.5 to 30 V ^{3) 4) 5)}	<p style="text-align: right; font-size: small;">A0034969</p>
	Channel 2: 12 to 30 V	

- 1) Feature 020 of the product structure: option C
- 2) Feature 010 of the product structure
- 3) For ambient temperatures $T_a \leq -30\text{ °C}$ (-22 °F) a minimum voltage of 16 V is required for the startup of the device at the minimum error current (3.6 mA).
- 4) For ambient temperatures $T_a \leq -40\text{ °C}$ (-40 °F), the maximum terminal voltage must be restricted to $U \leq 28\text{ V}$.
- 5) If the Bluetooth modem is used, the minimum supply voltage increases by 2 V.

Polarity reversal protection	Yes
Admissible residual ripple at f = 0 to 100 Hz	$U_{SS} < 1 \text{ V}$
Admissible residual ripple at f = 100 to 10000 Hz	$U_{SS} < 10 \text{ mV}$

4-wire, 4-20mA HART, active

"Power supply; Output" ¹⁾	Terminal voltage	Maximum load R _{max}
K: 4-wire 90-253VAC; 4-20mA HART	90 to 253 V _{AC} (50 to 60 Hz), overvoltage category II	500 Ω
L: 4-wire 10,4-48VDC; 4-20mA HART	10.4 to 48 V _{DC}	

1) Feature 020 of the product structure

7.1.5 Overvoltage protection

If the measuring device is used for level measurement in flammable liquids which requires the use of overvoltage protection according to DIN EN 60079-14, standard for test procedures 60060-1 (10 kA, pulse 8/20 μs), an overvoltage protection module has to be installed.

Integrated overvoltage protection module

An integrated overvoltage protection module is available for 2-wire HART as well as PROFIBUS PA and FOUNDATION Fieldbus devices.

Product structure: Feature 610 "Accessory mounted", option NA "Overvoltage protection".

Technical data	
Resistance per channel	2 × 0.5 Ω max.
Threshold DC voltage	400 to 700 V
Threshold impulse voltage	< 800 V
Capacitance at 1 MHz	< 1.5 pF
Nominal arrest impulse voltage (8/20 μs)	10 kA

External overvoltage protection module

HAW562 or HAW569 from Endress+Hauser are suited as external overvoltage protection.

-  For detailed information please refer to the following documents:
- HAW562: TI01012K
 - HAW569: TI01013K

7.2 Connecting the measuring device

⚠ WARNING

Risk of explosion!

- ▶ Observe applicable national standards.
- ▶ Comply with the specifications in the Safety Instructions (XA).
- ▶ Use specified cable glands only.
- ▶ Check to ensure that the power supply matches the information on the nameplate.
- ▶ Switch off the power supply before connecting the device.
- ▶ Connect the potential matching line to the outer ground terminal before applying the power supply.

Required tools/accessories:

- For devices with a cover lock: Allen key AF3
- Wire stripper
- When using stranded cables: One ferrule for every wire to be connected.

7.2.1 Opening connection compartment cover

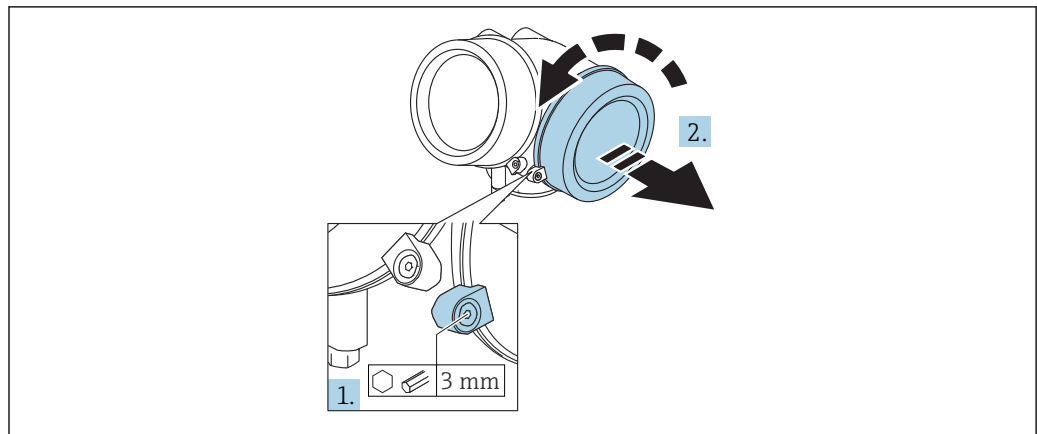

A0021490

1. Loosen the screw of the securing clamp of the connection compartment cover using an Allen key (3 mm) and turn the clamp 90° clockwise.
2. Afterwards unscrew connection compartment cover and check lid gasket, replace if necessary.

7.2.2 Connecting

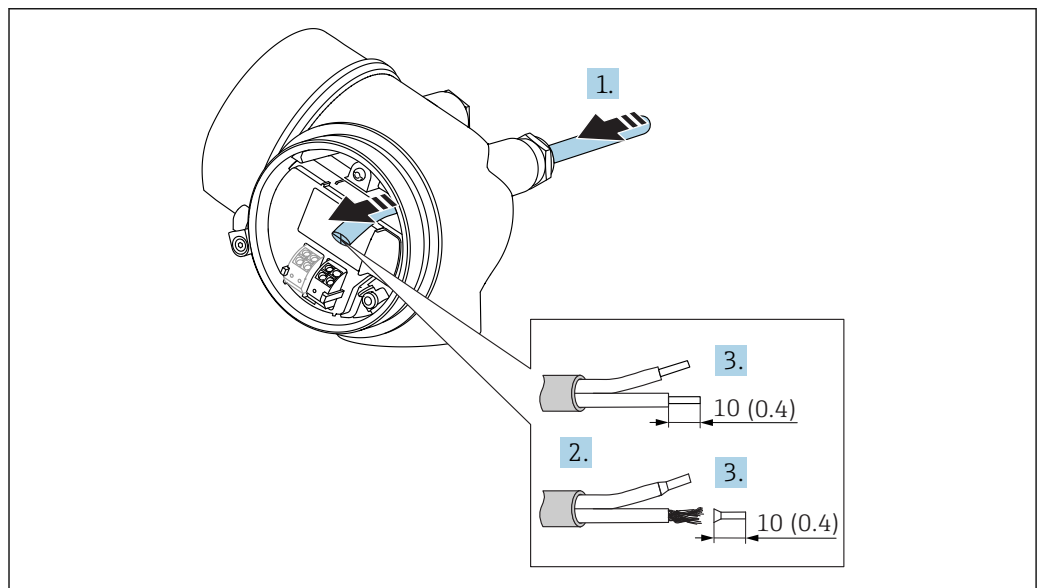

A0036418

28 Dimensions: mm (in)

1. Push the cable through the cable entry . To ensure tight sealing, do not remove the sealing ring from the cable entry.
2. Remove the cable sheath.
3. Strip the cable ends over a length of 10 mm (0.4 in). In the case of stranded cables, also fit ferrules.
4. Firmly tighten the cable glands.

5. Connect the cable in accordance with the terminal assignment.

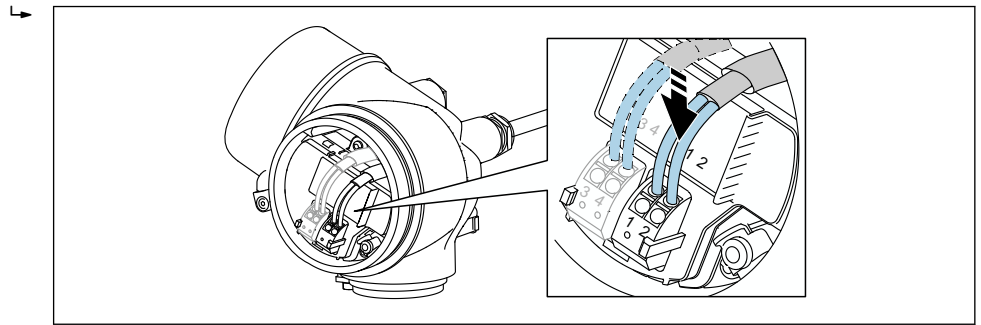

A0034682

6. If using shielded cables: Connect the cable shield to the ground terminal.

7.2.3 Plug-in spring-force terminals

In the case of devices without integrated overvoltage protection, electrical connection is via plug-in spring-force terminals. Rigid conductors or flexible conductors with ferrules can be inserted directly into the terminal without using the lever, and create a contact automatically.

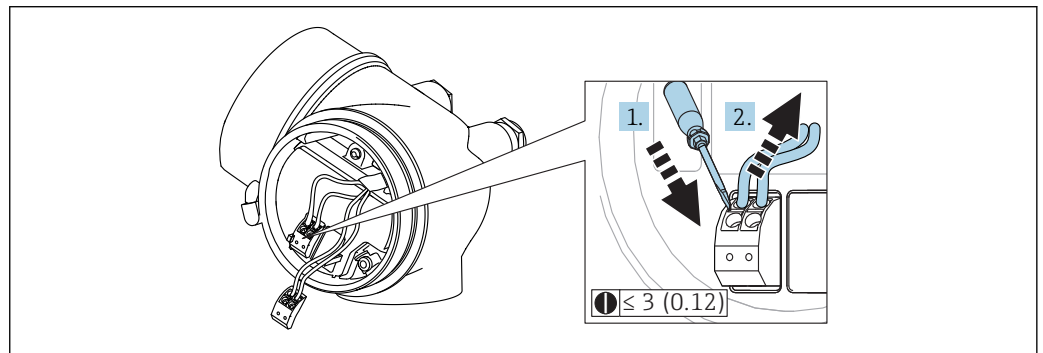

A0013661

☞ 29 Dimensions: mm (in)

To remove cables from the terminal:

1. Using a flat-blade screwdriver ≤ 3 mm, press down on the slot between the two terminal holes
2. while simultaneously pulling the cable end out of the terminal.

7.2.4 Closing connection compartment cover

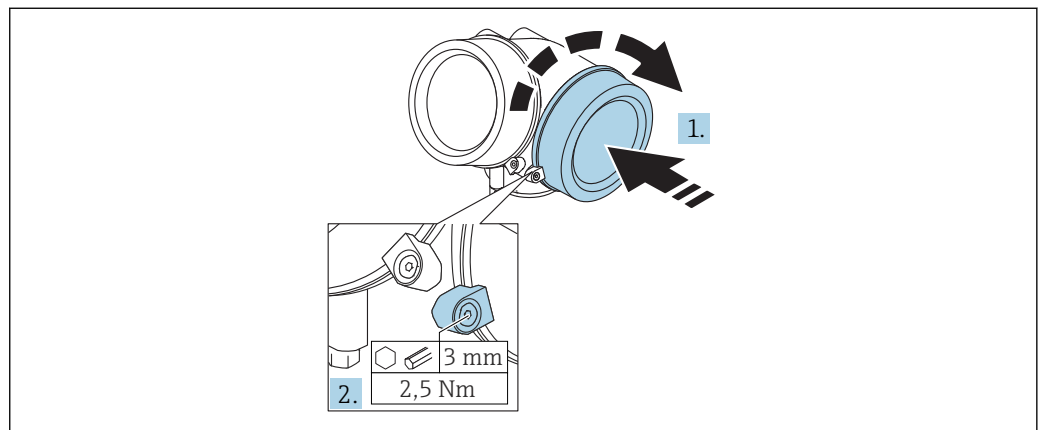

A0021491

1. Screw back firmly connection compartment cover.
2. Turning securing clamp 90 ° counterclockwise and tighten the clamp with 2.5 Nm (1.84 lbf ft) again using the Allen key (3 mm).

7.3 Post-connection check

- Is the device or cable undamaged (visual inspection)?
- Do the cables used comply with the requirements?
- Do the mounted cables have adequate strain relief?
- Are all the cable glands installed, firmly tightened and leak-tight?
- Does the supply voltage match the specifications on the nameplate?
- Is the terminal assignment correct?
- If necessary, has a protective ground connection been established?
- If supply voltage is present, is the device ready for operation and do values appear on the display module?
- Are all the housing covers installed and tightened?
- Is the securing clamp firmly tightened?

8 Operation options

8.1 Overview

8.1.1 Local operation

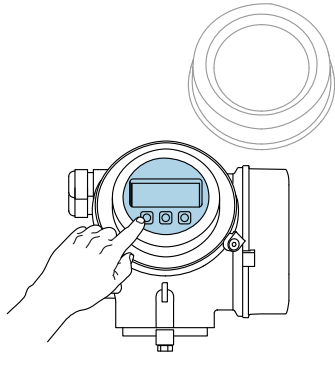
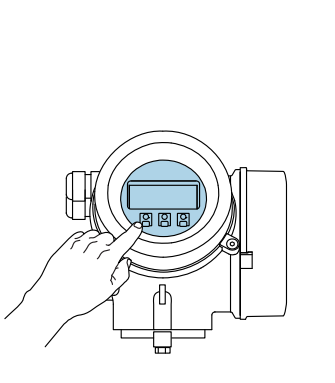
Operation with	Pushbuttons	Touch Control
Order code for "Display; Operation"	Option C "SD02"	Option E "SD03"
	 <p style="text-align: right; font-size: small;">A0036312</p>	 <p style="text-align: right; font-size: small;">A0036313</p>
Display elements	4-line display	4-line display white background lighting; switches to red in event of device error
	Format for displaying measured variables and status variables can be individually configured	
	Permitted ambient temperature for the display: -20 to +70 °C (-4 to +158 °F) The readability of the display may be impaired at temperatures outside the temperature range.	
Operating elements	local operation with 3 push buttons (⊕, ⊖, ⊞)	external operation via touch control; 3 optical keys: ⊕, ⊖, ⊞
	Operating elements also accessible in various hazardous areas	
Additional functionality	Data backup function The device configuration can be saved in the display module.	
	Data comparison function The device configuration saved in the display module can be compared to the current device configuration.	
	Data transfer function The transmitter configuration can be transmitted to another device using the display module.	

8.1.2 Operation with remote display and operating module FHX50

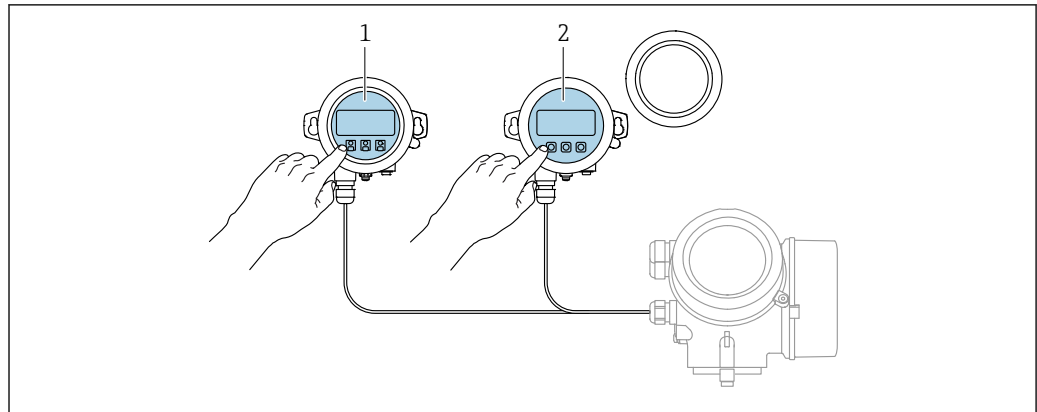

A0036314

30 FHX50 operating options

- 1 Display and operating module SD03, optical keys; can be operated through the glass of the cover
- 2 Display and operating module SD02, push buttons; cover must be removed

8.1.3 Operation via Bluetooth® wireless technology

Requirements

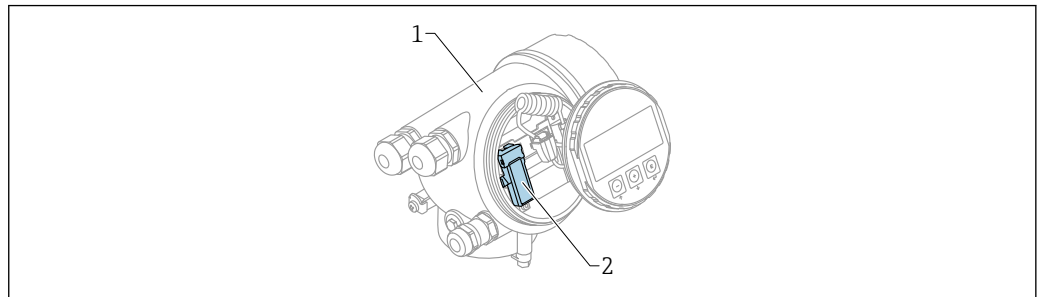

A0036790

31 Device with Bluetooth module

- 1 Electronics housing of the device
- 2 Bluetooth module

This operation option is only available for devices with Bluetooth module. There are the following options:

- The device has been ordered with a Bluetooth module:
Feature 610 "Accessory Mounted", option NF "Bluetooth"
- The Bluetooth module has been ordered as an accessory (ordering number: 71377355) and has been mounted. See Special Documentation SD02252F.

Operation via SmartBlue (app)

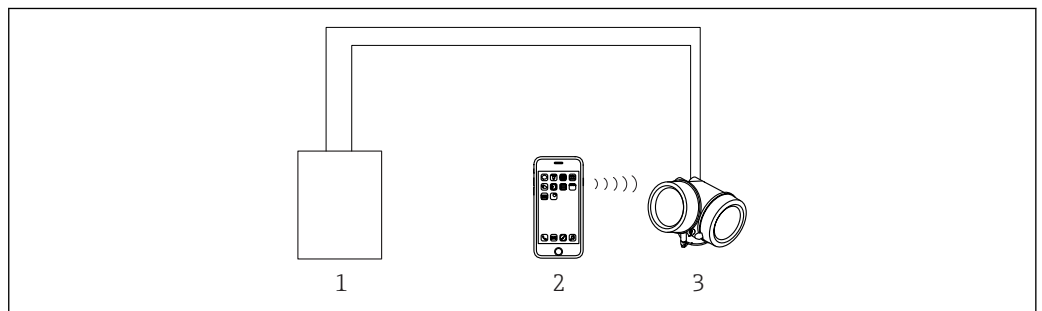

A0034939

32 Operation via SmartBlue (app)

- 1 Transmitter power supply unit
- 2 Smartphone / tablet with SmartBlue (app)
- 3 Transmitter with Bluetooth module

8.1.4 Remote operation

Via HART protocol

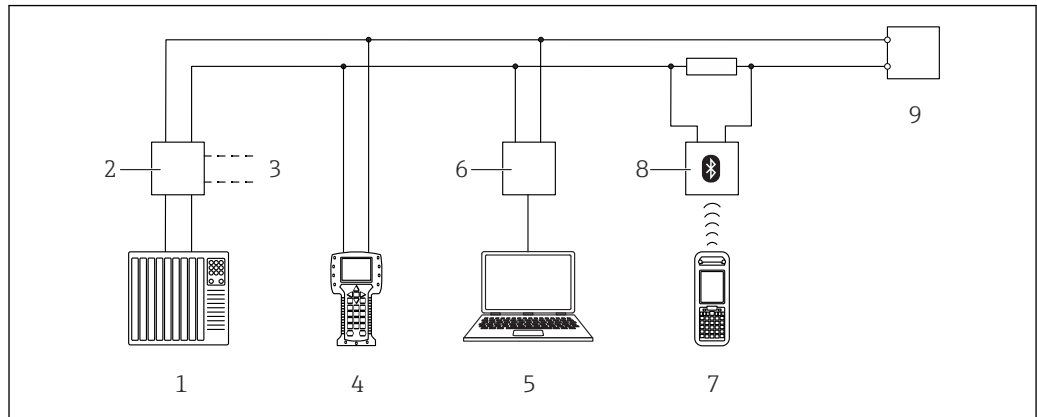

A0036169

33 Options for remote operation via HART protocol

- 1 PLC (Programmable Logic Controller)
- 2 Transmitter power supply unit, e.g. RN221N (with communication resistor)
- 3 Connection for Commubox FXA191, FXA195 and Field Communicator 375, 475
- 4 Field Communicator 475
- 5 Computer with operating tool (e.g. DeviceCare/FieldCare, AMS Device Manager, SIMATIC PDM)
- 6 Commubox FXA191 (RS232) or FXA195 (USB)
- 7 Field Xpert SFX350/SFX370
- 8 VIATOR Bluetooth modem with connecting cable
- 9 Transmitter

DeviceCare/FieldCare via service interface (CDI)

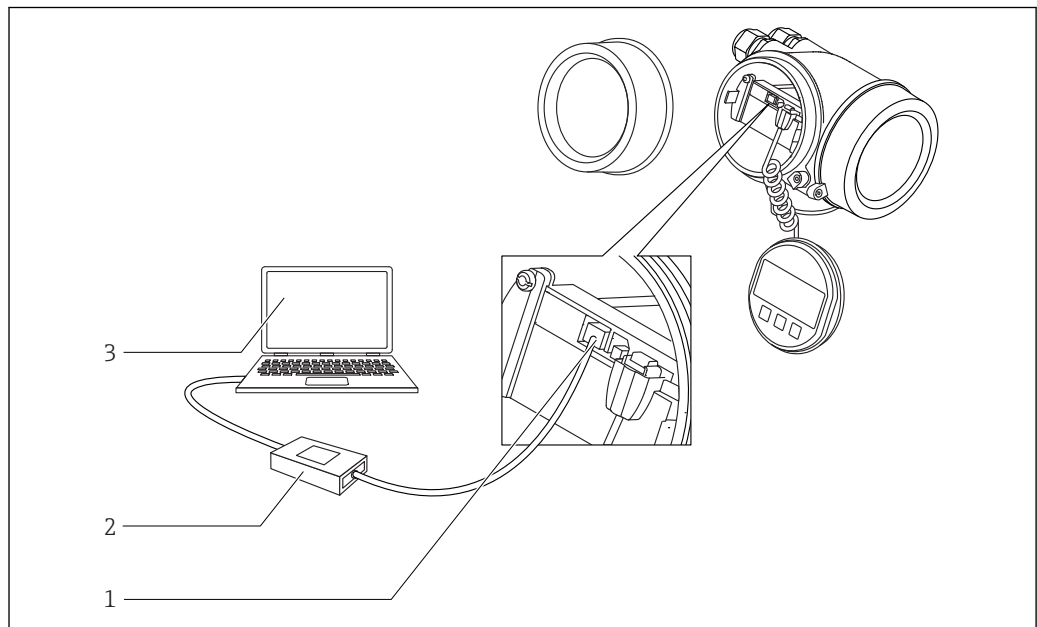

A0032466

34 DeviceCare/FieldCare via service interface (CDI)

- 1 Service interface (CDI) of the instrument (= Endress+Hauser Common Data Interface)
- 2 Commubox FXA291
- 3 Computer with DeviceCare/FieldCare operating tool

8.2 Structure and function of the operating menu

8.2.1 Structure of the operating menu

Menu	Submenu / parameter	Meaning
	Language ¹⁾	Defines the operating language of the local display.
Commissioning ²⁾		Launches the interactive wizard for guided commissioning. Additional settings generally do not need to be made in the other menus when the wizard is finished.
Setup	Parameter 1 ... Parameter N	When all these parameters have been assigned appropriate values, the measured should be completely configured in a standard application.
	Advanced setup	Contains further submenus and parameters: <ul style="list-style-type: none"> ▪ to adapt the device to special measuring conditions. ▪ to process the measured value (scaling, linearization). ▪ to configure the signal output.
Diagnostics	Diagnostic list	Contains up to 5 currently active error messages.
	Event logbook ³⁾	Contains the last 20 messages (which are no longer active).
	Device information	Contains information needed to identify the device.
	Measured values	Contains all current measured values.
	Data logging	Contains the history of the individual measuring values.
	Simulation	Used to simulate measured values or output values.
	Device check	Contains all parameters needed to check the measurement capability of the device.
Expert ⁵⁾ Contains all parameters of the device (including those which are already contained in one of the above submenus). This menu is organized according to the function blocks of the device. The parameters of the Expert menu are described in: GP0100F (HART)	System	Contains all general device parameters which do not affect the measurement or the communication interface.
	Sensor	Contains all parameters needed to configure the measurement.
	Output	<ul style="list-style-type: none"> ▪ Contains all parameters needed to configure the current output. ▪ Contains all parameters needed to configure the switch output (PFS).

Menu	Submenu / parameter	Meaning
	Communication	Contains all parameters needed to configure the digital communication interface.
	Diagnostics	Contains all parameters needed to detect and analyze operational errors.

- 1) If operating via operating tools (e.g. FieldCare), the "Language" parameter is located under "Setup → Advanced setup → Display"
- 2) Only if operating via an FDT/DTM system
- 3) only available with local operation
- 4) only available if operating via DeviceCare or FieldCare
- 5) On entering the "Expert" menu, an access code is always requested. If a customer specific access code has not been defined, "0000" has to be entered.

8.2.2 User roles and related access authorization

The two user roles **Operator** and **Maintenance** have different write access to the parameters if a device-specific access code has been defined. This protects the device configuration via the local display from unauthorized access →  61.

Access authorization to parameters

User role	Read access		Write access	
	Without access code (from the factory)	With access code	Without access code (from the factory)	With access code
Operator	✓	✓	✓	--
Maintenance	✓	✓	✓	✓

If an incorrect access code is entered, the user obtains the access rights of the **Operator** role.

 The user role with which the user is currently logged on is indicated by the **Access status display** parameter (for display operation) or **Access status tooling** parameter (for tool operation).

8.2.3 Data access - Security

Write protection via access code

Using the device-specific access code, the parameters for the measuring device configuration are write-protected and their values can no longer be changed via local operation.

Define access code via local display

1. Navigate to: Setup → Advanced setup → Administration → Define access code → Define access code
2. Define a max. 4-digit numeric code as an access code.
3. Repeat the same code in **Confirm access code** parameter.
 - ↳ The -symbol appears in front of all write-protected parameters.



Define access code via operating tool (e.g. FieldCare)

1. Navigate to: Setup → Advanced setup → Administration → Define access code
2. Define a max. 4-digit numeric code as an access code.
 - ↳ Write protection is active.



Parameters that can always be changed

The write protection does not include certain parameters that do not affect the measurement. Despite the defined access code, they can always be modified, even if the other parameters are locked.



The device automatically locks the write-protected parameters again if a key is not pressed for 10 minutes in the navigation and editing view. The device locks the write-protected parameters automatically after 60 s if the user skips back to the measured value display mode from the navigation and editing view.

-  If write access is activated via access code, it can be also be deactivated only via the access code →  62.
- In the "Description of Device Parameters" documents, each write-protected parameter is identified with the -symbol.

Disabling write protection via access code

If the -symbol appears on the local display in front of a parameter, the parameter is write-protected by a device-specific access code and its value cannot be changed at the moment using the local display →  61.

The locking of the write access via local operation can be disabled by entering the device-specific access code.

1. After you press , the input prompt for the access code appears.
2. Enter the access code.
 - ↳ The -symbol in front of the parameters disappears; all previously write-protected parameters are now re-enabled.

Deactivation of the write protection via access code

Via local display

1. Navigate to: Setup → Advanced setup → Administration → Define access code → Define access code
2. Enter **0000**.
3. Repeat **0000** in **Confirm access code** parameter.
 - ↳ The write protection is deactivated. Parameters can be changed without entering an access code.

Via an operating tool (e.g. FieldCare)

1. Navigate to: Setup → Advanced setup → Administration → Define access code
2. Enter **0000**.
 - ↳ The write protection is deactivated. Parameters can be changed without entering an access code.

Write protection via write protection switch

Unlike parameter write protection via a user-specific access code, this allows write access to the entire operating menu - except for the **"Contrast display" parameter** - to be locked.

The parameter values are now read only and cannot be edited any more (exception **"Contrast display" parameter**):

- Via local display
- Via service interface (CDI)
- Via HART protocol

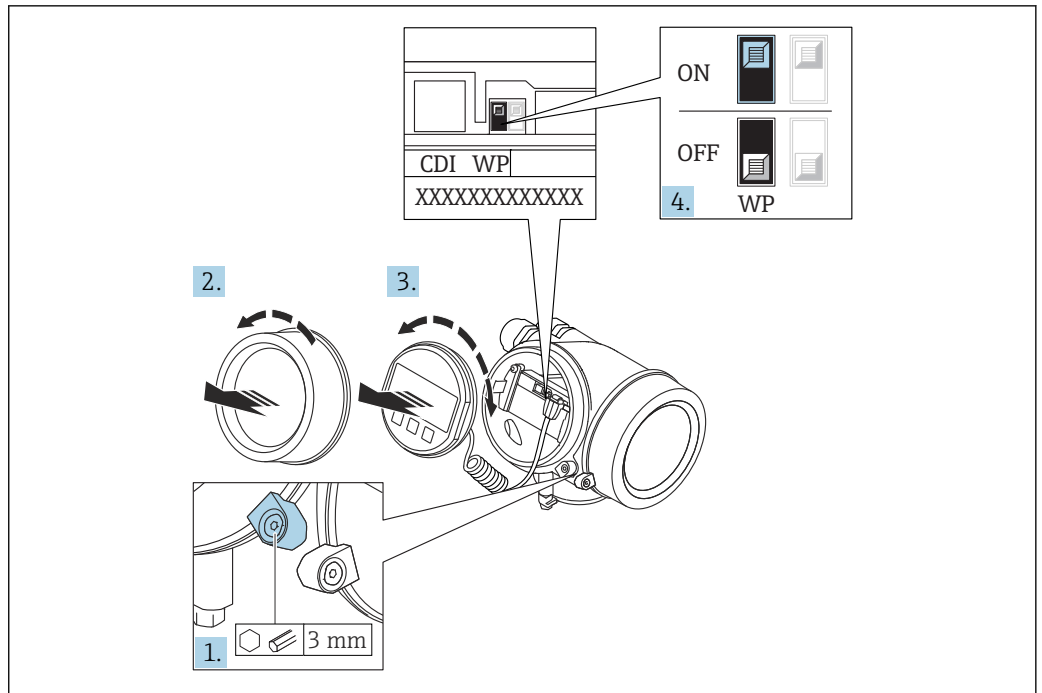

A0026157

1. Loosen the securing clamp.
2. Unscrew the electronics compartment cover.
3. Pull out the display module with a gentle rotational movement. To make it easier to access the lock switch, attach the display module to the edge of the electronics compartment.

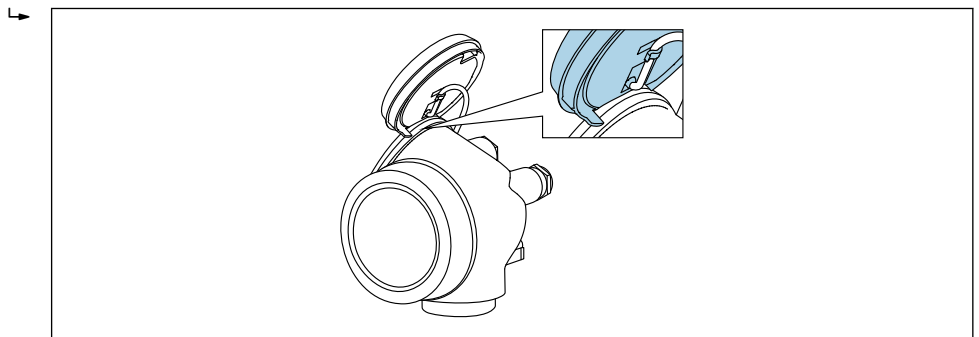

A0036086

4. Setting the write protection switch (WP) on the main electronics module to the **ON** position enables hardware write protection. Setting the write protection switch (WP) on the main electronics module to the **OFF** position (factory setting) disables hardware write protection.
 - ↳ If the hardware write protection is enabled: The **Hardware locked** option is displayed in the **Locking status** parameter. In addition, on the local display the -symbol appears in front of the parameters in the header of the operational display and in the navigation view.

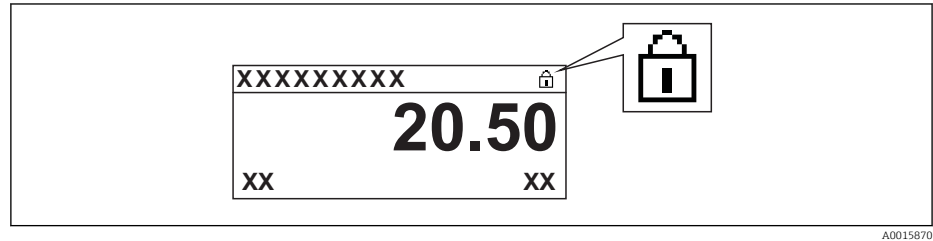

If the hardware write protection is disabled: No option is displayed in the **Locking status** parameter. On the local display, the -symbol disappears from in front of the parameters in the header of the operational display and in the navigation view.

5. Feed the cable into the gap between the housing and main electronics module and plug the display module into the electronics compartment in the desired direction until it engages.
6. Reverse the removal procedure to reassemble the transmitter.

Enabling and disabling the keypad lock

The keypad lock makes it possible to block access to the entire operating menu via local operation. As a result, it is no longer possible to navigate through the operating menu or change the values of individual parameters. Users can only read the measured values on the operational display.

The keypad lock is switched on and off via the context menu.

Switching on the keypad lock

For the SD03 display only

The keypad lock is switched on automatically:

- If the device has not been operated via the display for > 1 minute.
- Each time the device is restarted.

To activate the keylock manually:

1. The device is in the measured value display.
Press  for at least 2 seconds.
↳ A context menu appears.
2. In the context menu select the **Keylock on** option.
↳ The keypad lock is switched on.

 If the user attempts to access the operating menu while the keypad lock is active, the message **Keylock on** appears.

Switching off the keypad lock

1. The keypad lock is switched on.
Press  for at least 2 seconds.
↳ A context menu appears.
2. In the context menu select the **Keylock off** option.
↳ The keypad lock is switched off.

Bluetooth® wireless technology

Signal transmission via Bluetooth® wireless technology uses a cryptographic technique tested by the Fraunhofer Institute

- The device is not visible via *Bluetooth*® wireless technology without the SmartBlue app
- Only one point-to-point connection between **one** sensor and **one** smartphone or tablet is established

8.3 Display and operating module

8.3.1 Display appearance

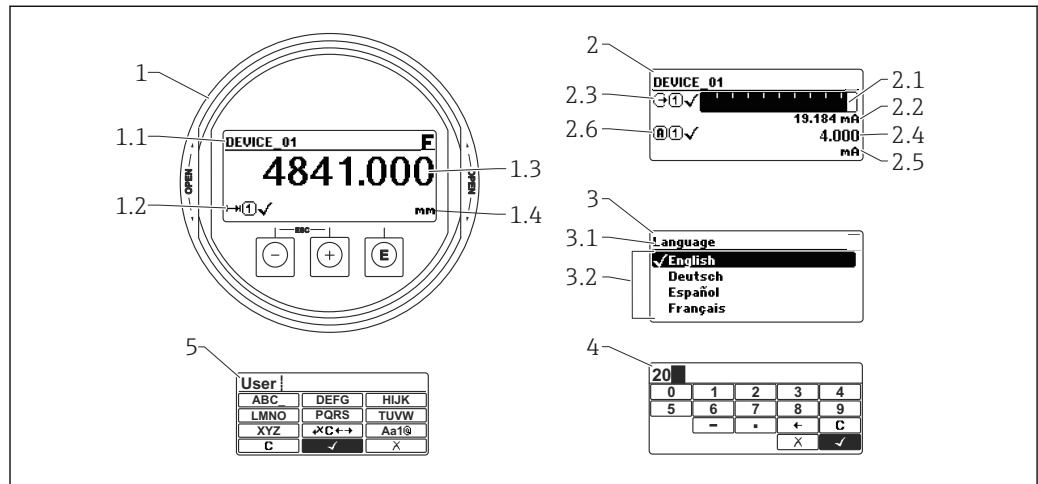





A0012635

35 Appearance of the display and operation module for on-site operation

- 1 Measured value display (1 value max. size)
- 1.1 Header containing tag and error symbol (if an error is active)
- 1.2 Measured value symbols
- 1.3 Measured value
- 1.4 Unit
- 2 Measured value display (1 bargraph + 1 value)
- 2.1 Bargraph for measured value 1
- 2.2 Measured value 1 (including unit)
- 2.3 Measured value symbols for measured value 1
- 2.4 Measured value 2
- 2.5 Unit for measured value 2
- 2.6 Measured value symbols for measured value 2
- 3 Representation of a parameter (here: a parameter with selection list)
- 3.1 Header containing parameter name and error symbol (if an error is active)
- 3.2 Selection list; marks the current parameter value.
- 4 Input matrix for numbers
- 5 Input matrix for alphanumeric and special characters



Display symbols for the submenus

Symbol	Meaning
 <small>A0018367</small>	Display/operat. Appears: <ul style="list-style-type: none"> ▪ In the main menu next to the "Display/operat." selection ▪ In the header on the left in the "Display/operat." menu
 <small>A0018364</small>	Setup Appears: <ul style="list-style-type: none"> ▪ In the main menu next to the "Setup" selection ▪ In the header on the left in the "Setup" menu
 <small>A0018365</small>	Expert Appears: <ul style="list-style-type: none"> ▪ In the main menu next to the "Expert" selection ▪ In the header on the left in the "Expert" menu
 <small>A0018366</small>	Diagnostics Appears: <ul style="list-style-type: none"> ▪ In the main menu next to the "Diagnostics" selection ▪ In the header on the left in the "Diagnostics" menu











Status signals

Symbol	Meaning
F <small>A0032902</small>	"Failure" A device error has occurred. The measured value is no longer valid.
C <small>A0032903</small>	"Function check" The device is in service mode (e.g. during a simulation).
S <small>A0032904</small>	"Out of specification" The device is being operated: <ul style="list-style-type: none"> ▪ Outside its technical specifications (e.g. during warmup or cleaning processes) ▪ Outside the parameter configuration undertaken by the user (e.g. level outside of configured range)
M <small>A0032905</small>	"Maintenance required" Maintenance is required. The measured value is still valid.





Display symbols for locking status

Symbol	Meaning
 <small>A0013148</small>	Read-only parameters The parameter shown is only for display purposes and cannot be edited.
 <small>A0013150</small>	Device locked <ul style="list-style-type: none"> ▪ In front of a parameter name: The device is locked via software and/or hardware. ▪ In the header of the measured value screen: The device is locked via hardware.

Measured value symbols

Symbol	Meaning
Measured values	
 A0032892	Level
 A0032893	Distance
 A0032908	Current output
 A0032894	Measured current
 A0032895	Terminal voltage
 A0032896	Electronics or sensor temperature
Measuring channels	
 A0032897	Measuring channel 1
 A0032898	Measuring channel 2
Status of the measured value	
 A0018361	"Alarm" status Measurement is interrupted. The output assumes the defined alarm condition. A diagnostic message is generated.
 A0018360	"Warning" status The device continues to measure. A diagnostic message is generated.

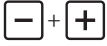
8.3.2 Operating elements

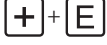
Key	Meaning
 <small>A0018330</small>	<p>Minus key</p> <p><i>For menu, submenu</i> Moves the selection bar upwards in a picklist.</p> <p><i>For text and numeric editor</i> In the input mask, moves the selection bar to the left (backwards).</p>
 <small>A0018329</small>	<p>Plus key</p> <p><i>For menu, submenu</i> Moves the selection bar downwards in a picklist.</p> <p><i>For text and numeric editor</i> In the input mask, moves the selection bar to the right (forwards).</p>
 <small>A0018328</small>	<p>Enter key</p> <p><i>For measured value display</i></p> <ul style="list-style-type: none"> ▪ Pressing the key briefly opens the operating menu. ▪ Pressing the key for 2 s opens the context menu. <p><i>For menu, submenu</i></p> <ul style="list-style-type: none"> ▪ Pressing the key briefly Opens the selected menu, submenu or parameter. ▪ Pressing the key for 2 s for parameter: If present, opens the help text for the function of the parameter. <p><i>For text and numeric editor</i></p> <ul style="list-style-type: none"> ▪ Pressing the key briefly <ul style="list-style-type: none"> ▪ Opens the selected group. ▪ Carries out the selected action. ▪ Pressing the key for 2 s confirms the edited parameter value.
 <small>A0032909</small>	<p>Escape key combination (press keys simultaneously)</p> <p><i>For menu, submenu</i></p> <ul style="list-style-type: none"> ▪ Pressing the key briefly <ul style="list-style-type: none"> ▪ Exits the current menu level and takes you to the next higher level. ▪ If help text is open, closes the help text of the parameter. ▪ Pressing the key for 2 s returns you to the measured value display ("home position"). <p><i>For text and numeric editor</i> Closes the text or numeric editor without applying changes.</p>
 <small>A0032910</small>	<p>Minus/Enter key combination (press and hold down the keys simultaneously)</p> <p>Reduces the contrast (brighter setting).</p>
 <small>A0032911</small>	<p>Plus/Enter key combination (press and hold down the keys simultaneously)</p> <p>Increases the contrast (darker setting).</p>



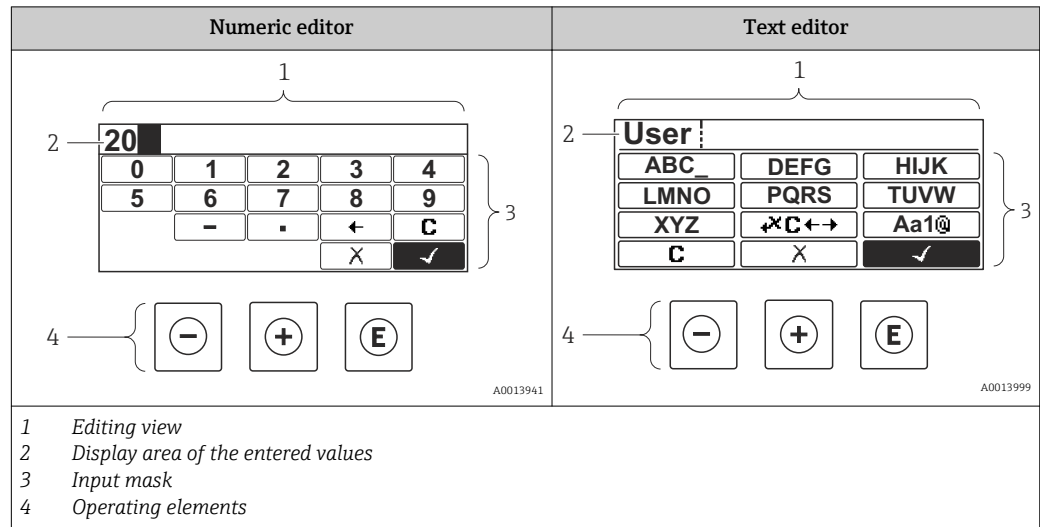



8.3.3 Enter numbers and text

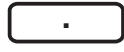

Input mask





The following input symbols are available in the input mask of the numeric and text editor:

Numeric editor

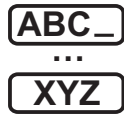
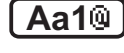



Symbol	Meaning
 A0013998	Selection of numbers from 0 to 9.
 A0016619	Inserts decimal separator at the input position.
 A0016620	Inserts minus sign at the input position.
 A0013985	Confirms selection.
 A0016621	Moves the input position one position to the left.
 A0013986	Exits the input without applying the changes.
 A0014040	Clears all entered characters.

Text editor

Symbol	Meaning
 A0013997	Selection of letters from A to Z
 A0013981	Toggle <ul style="list-style-type: none"> Between upper-case and lower-case letters For entering numbers For entering special characters

 <small>A0013985</small>	Confirms selection.
 <small>A0013987</small>	Switches to the selection of the correction tools.
 <small>A0013986</small>	Exits the input without applying the changes.
 <small>A0014040</small>	Clears all entered characters.

Correction symbols under 

Symbol	Meaning
 <small>A0032907</small>	Clears all entered characters.
 <small>A0018324</small>	Moves the input position one position to the right.
 <small>A0018326</small>	Moves the input position one position to the left.
 <small>A0032906</small>	Deletes one character immediately to the left of the input position.

8.3.4 Opening the context menu

Using the context menu, the user can call up the following menus quickly and directly from the operational display:

- Setup
- Conf. backup disp.
- Envelope curve
- Keylock on



Calling up and closing the context menu

The user is in the operational display.

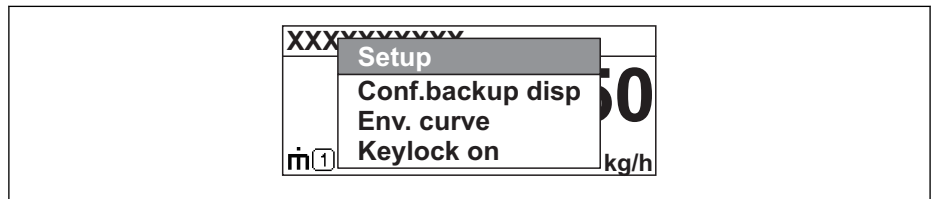

1. Press  for 2 s.
 - ↳ The context menu opens.



A0037872

2. Press  +  simultaneously.
 - ↳ The context menu is closed and the operational display appears.

Calling up the menu via the context menu

1. Open the context menu.
2. Press  to navigate to the desired menu.
3. Press  to confirm the selection.
 - ↳ The selected menu opens.

8.3.5 Envelope curve display on the display and operating module

In order to assess the measuring signal, the envelope curve and - if a mapping has been recorded - the mapping curve can be shown on the display and operating module:

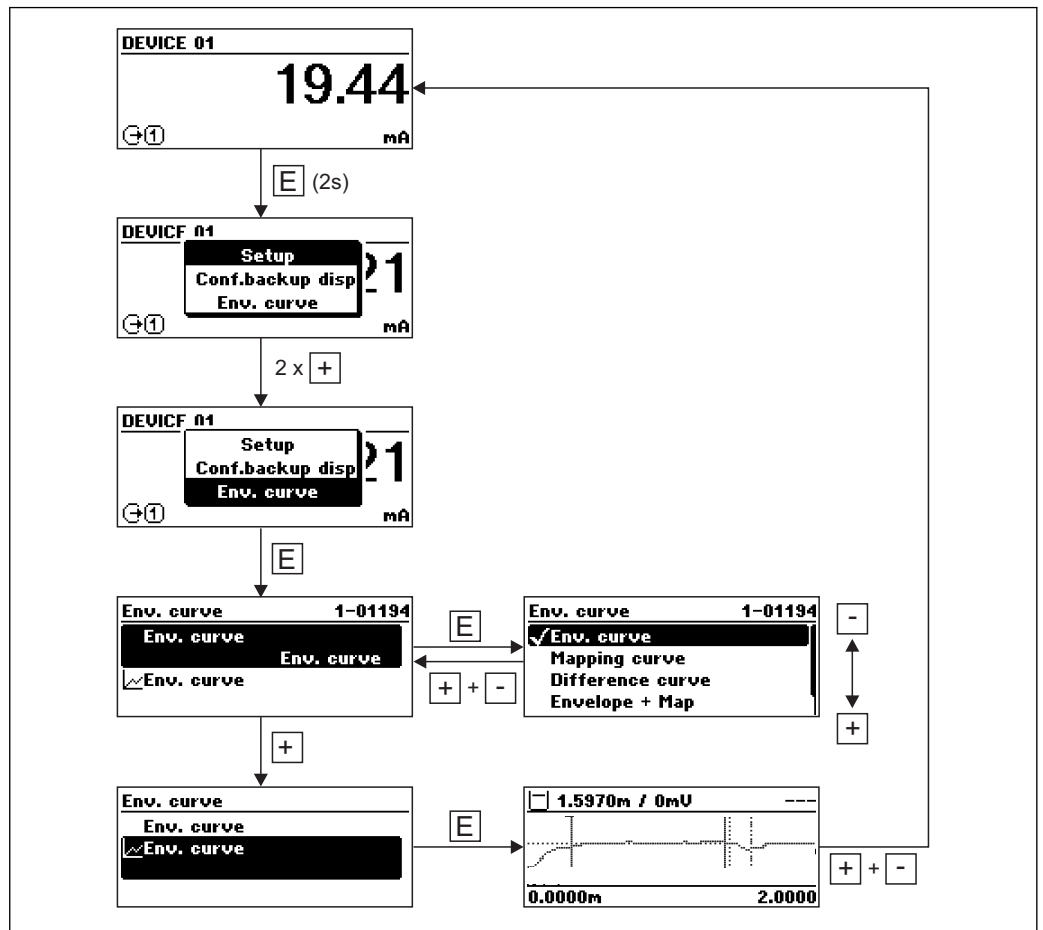

A0014277

9 Device integration via the HART protocol

9.1 Overview of the Device Description files (DD)

HART

Manufacturer ID	0x11
Device type	0x1122
HART specification	7.0
DD files	For information and files see: <ul style="list-style-type: none"> ▪ www.endress.com ▪ www.fieldcommgroup.org

9.2 HART device variables and measuring values

On delivery the following measuring values are assigned to the HART device variables:

Device variables for level measurements

Device variable	Measuring value
Primary variable (PV)	Level linearized
Secondary variable (SV)	Unfiltered distance
Tertiary variable (TV)	Absolute echo amplitude
Quaternary variable (QV)	Relative echo amplitude

 The allocation of the measuring values to the device variables can be changed in the following submenu:

Expert → Communication → Output

10 Commissioning via SmartBlue (App)

10.1 Requirements

Device requirements

Commissioning via SmartBlue is only possible if a Bluetooth module is installed in the device.

System requirements

The SmartBlue App is available for download for mobile smartphone or tablet devices in the Google Play Store for Android, and in the App Store for iOS.

- iOS devices: iPhone 5S or higher from iOS11; iPad 5th Generation or higher from iOS11; iPod Touch 6th Generation or higher from iOS11
- Devices with Android: from Android 6.0 and *Bluetooth*® 4.0

Initial password

The ID number on the nameplate of the Bluetooth module is used as the initial password when establishing the connection for the first time.

- i** It is important to note the following if the Bluetooth module is removed from one device and installed in another device: all log-in data are only stored in the Bluetooth module and not in the device. This also applies to the password changed by the user.

10.2 SmartBlue App

1. Scan the QR code or enter "SmartBlue" in the search field of the App Store.

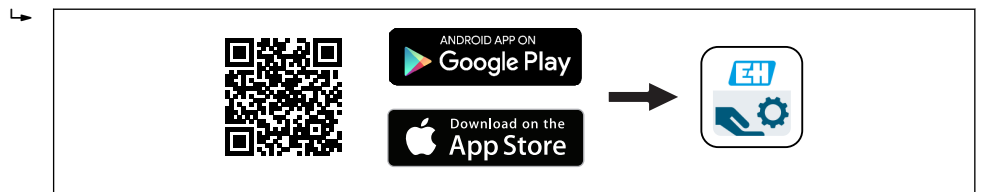

36 Download link

2. Start SmartBlue.
3. Select device from livelist displayed.
4. Enter the login data:
 - ↳ User name: admin
 - Password: serial number of the device
5. Tap the icons for more information.

- i** After logging in for the first time, change the password!

10.3 Envelope curve display in SmartBlue

Envelope curves can be displayed and recorded in SmartBlue.

In addition to the envelope curve, the following values are displayed:

- D = Distance
- L = Level
- A = Absolute amplitude
- With screenshots, the displayed section (zoom function) is saved
- With video sequences, the whole area without zoom function is saved all the time

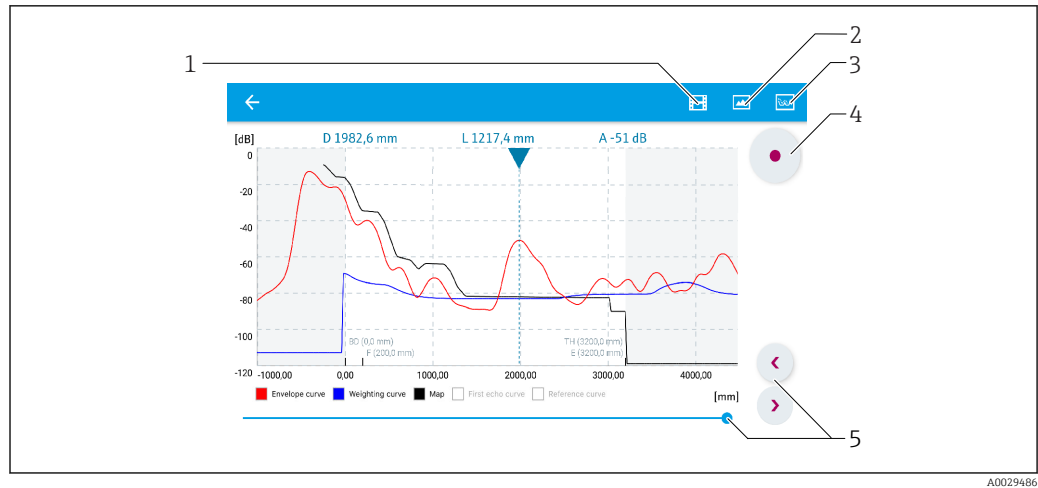

A0029486

37 Envelope curve display (sample) in SmartBlue for Android

- 1 Record video
- 2 Create screenshot
- 3 Display mapping menu
- 4 Start/stop video recording
- 5 Move time on time axis

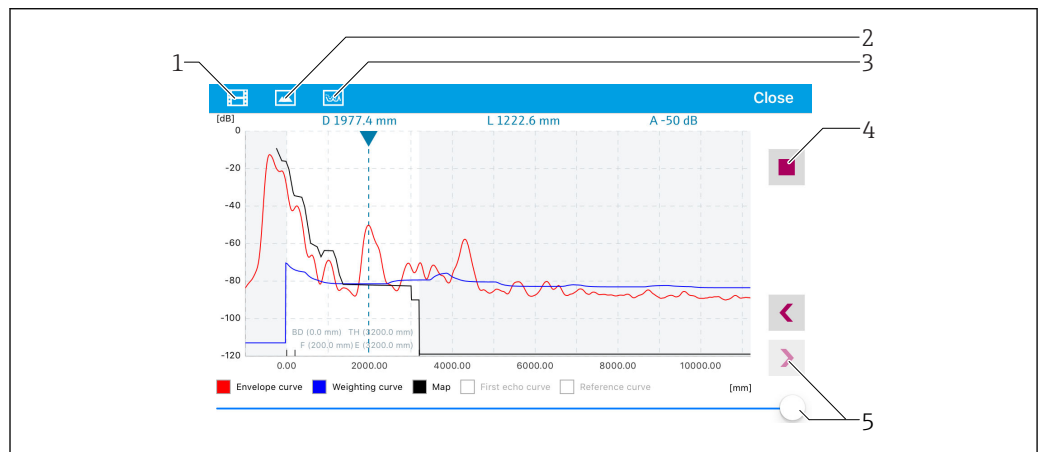

A0029487

38 Envelope curve display (sample) in SmartBlue for iOS

- 1 Record video
- 2 Create screenshot
- 3 Display mapping menu
- 4 Start/stop video recording
- 5 Move time on time axis

11 Commissioning using the Commissioning Wizard

A Wizard is provided in FieldCare and DeviceCare ¹⁾ that guides the user through the initial commissioning process.

1. Connect the device with FieldCare or DeviceCare.
2. Open the device in FieldCare or DeviceCare.
 - ↳ The dashboard (homepage) of the device is displayed:

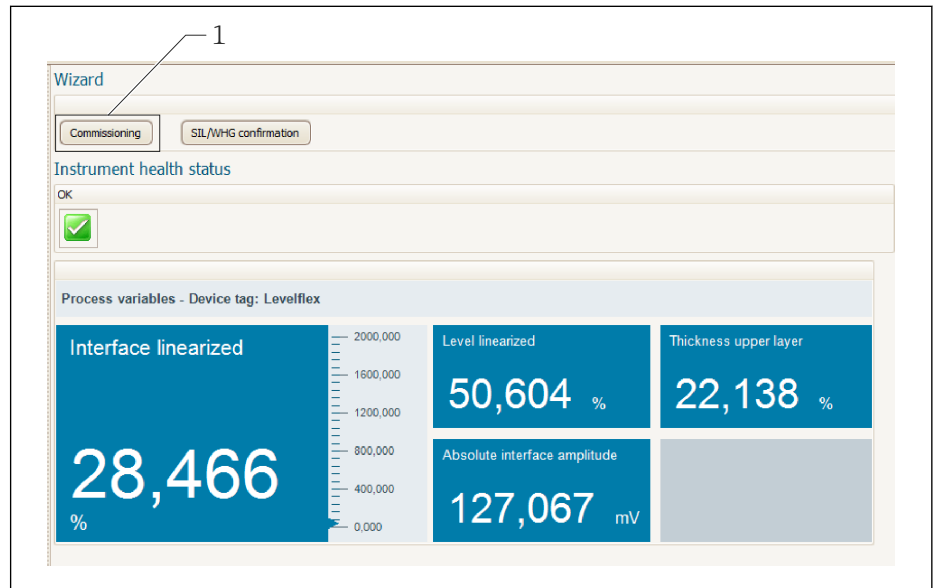

A0025866

1 "Commissioning" button calls up the wizard

3. Click "Commissioning" to launch the Wizard.
 4. Enter the appropriate value in each parameter or select the appropriate option. These values are written directly to the device.
 5. Click "Next" to go to the next page.
 6. Once all the pages have been completed, click "Finish" to close the Wizard.
- i** If you cancel the Wizard before all the necessary parameters have been entered, the device may be in an undefined state. In such situations, it is advisable to reset the device to the factory default settings.

1) DeviceCare is available for download at www.software-products.endress.com. To download the software, it is necessary to register in the Endress+Hauser software portal.

12 Commissioning via operating menu

12.1 Function check

Before commissioning your measuring point, ensure that the post-installation and post-connection checks have been performed:

12.2 Setting the operating language

Factory setting: English or ordered local language

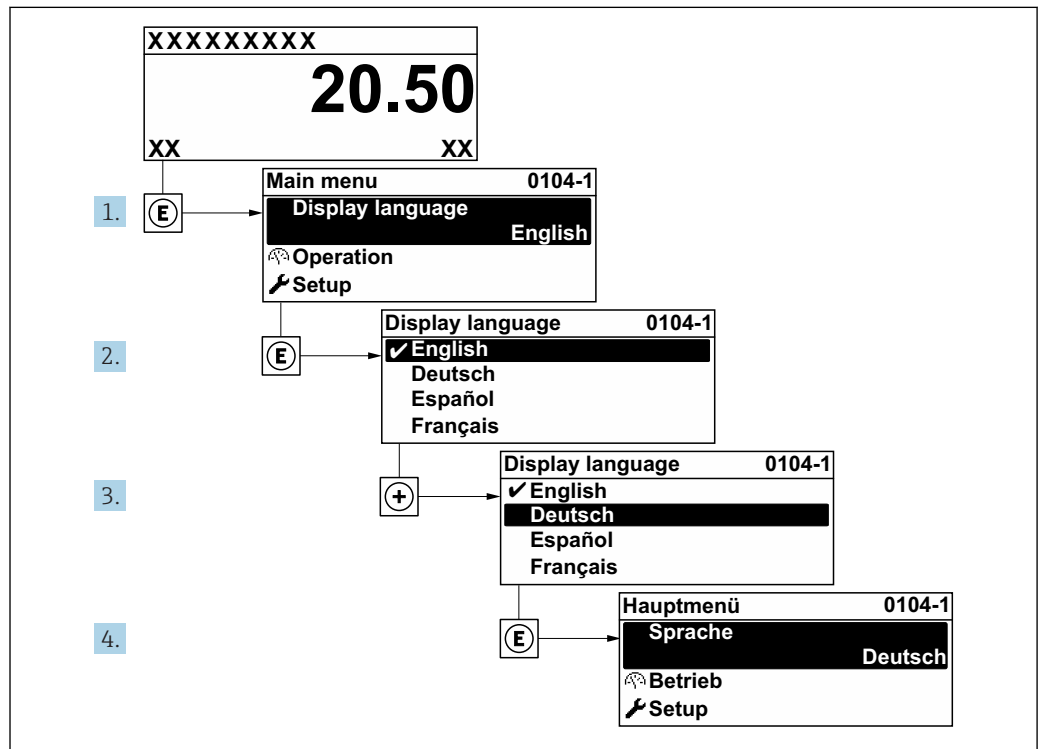

39 Using the example of the local display

A0029420

12.3 Configuring level measurement

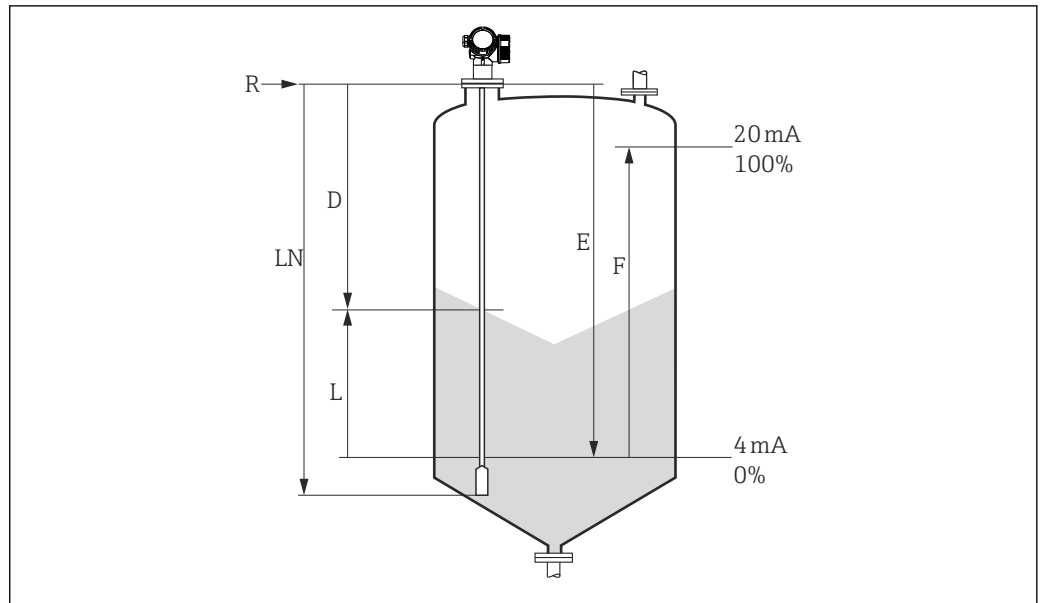

A0012838

40 Configuration parameters for level measurement in bulk solids

- LN Probe length
- R Reference point of measurement
- D Distance
- L Level
- E Empty calibration (= zero point)
- F Full calibration (= span)

i If the ϵ_r value is lower than 7 in the case of rope probes, measurement is not possible in the area of the tensioning weight. The empty calibration E should not exceed $LN - 250$ mm ($LN - 10$ in) in these cases.

1. Setup → Device tag
 - ↳ Enter device tag.
2. Navigate to: Setup → Distance unit
 - ↳ Select the length unit.
3. Navigate to: Setup → Bin type
 - ↳ Select bin type.
4. Navigate to: Setup → Empty calibration
 - ↳ Specify empty distance E (Distance from the reference point R to 0% mark).
5. Navigate to: Setup → Full calibration
 - ↳ Specify full distance F (Distance from the 0% to 100%).
6. Navigate to: Setup → Level
 - ↳ Displays the measured level L .
7. Navigate to: Setup → Distance
 - ↳ Displays the distance D between the reference point R and the level L .
8. Navigate to: Setup → Signal quality
 - ↳ Displays the signal quality of the analyzed level echo.
9. Operation via local display:
 - Navigate to: Setup → Mapping → Confirm distance
 - ↳ Compare the distance displayed with the actual value to start recording an interference echo map.

10. Operation via operating tool:
Navigate to: Setup → Confirm distance
 - ↳ Compare the distance displayed with the actual value to start recording an interference echo map.

12.4 Recording the reference envelope curve

After the measurement has been configured, it is recommended to record the current envelope curve as a reference envelope curve. This can then be used later for diagnostic purposes. The **Save reference curve** parameter is used to record the envelope curve.

Path in the menu

Expert → Diagnostics → Envelope diagnostics → Save reference curve

Meaning of the options

- No
No action
- Yes
The current envelope curve is saved as a reference curve.

 This submenu is only visible for the "Service" user role in devices supplied with software version 01.00.zz or 01.01.zz.

 The reference envelope curve can only be displayed in the envelope curve diagram of FieldCare after it has been loaded from the device into FieldCare. The "Load Reference Curve" function in FieldCare is used for this.

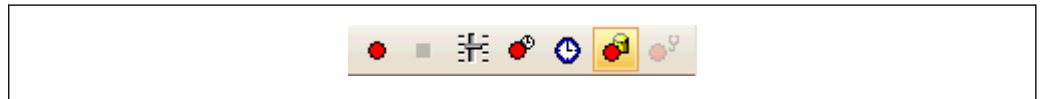

 41 "Load Reference Curve" function

12.5 Configuring the local display

12.5.1 Factory setting of local display for level measurements

Parameters	Factory setting for devices with 1 current output	Factory setting for devices with 2 current outputs
Format display	1 value, max. size	1 value, max. size
Value 1 display	Level linearized	Level linearized
Value 2 display	Distance	Distance
Value 3 display	Current output 1	Current output 1
Value 4 display	None	Current output 2

12.5.2 Adjusting the local display

The local display can be adjusted in the following submenu:
Setup → Advanced setup → Display

12.6 Configuring the current outputs

12.6.1 Factor setting of current outputs for level measurements

Current output	Assigned measured value	4mA value	20mA value
1	Level linearized	0% or the corresponding linearized value	100% or the corresponding linearized value
2 ¹⁾	Relative echo amplitude	0 mV	2 000 mV

1) for devices with two current outputs

12.6.2 Adjusting the current outputs

The current outputs can be adjusted in the following submenus:

Basic settings

Setup → Advanced setup → Current output 1 to 2

Advanced settings

Expert → Output 1 to 2 → Current output 1 to 2

See "Description of Device Parameters" GP01000F

12.7 Configuration management

After commissioning, it is possible to save the current device configuration, copy it to another measuring point or restore the previous device configuration. This can be done using the **Configuration management** parameter and its options.

Path in the menu

Setup → Advanced setup → Configuration backup display → Configuration management

Meaning of the options

- **Cancel**

No action is executed and the user exits the parameter.

- **Execute backup**

A backup copy of the current device configuration is saved from the HistoROM (integrated in the device) to the display module of the device.

- **Restore**

The last backup copy of the device configuration is copied from the display module to the HistoROM of the device.

- **Duplicate**

The transmitter configuration of the device is duplicated to another device using the display module. The following parameters, which characterize the individual measuring point are **not** transferred:

- HART date code
- HART short tag
- HART message
- HART descriptor
- HART address
- Device tag
- Medium type

- **Compare**

The device configuration saved in the display module is compared to the current device configuration of the HistoROM. The result of the comparison is displayed in **Comparison result** parameter.

- **Clear backup data**

The backup copy of the device configuration is deleted from the display module of the device.

 While this action is in progress, the configuration cannot be edited via the local display and a message on the processing status appears on the display.

 If an existing backup copy is restored on a device other than the original device with the **Restore** option, individual device functions may no longer be available. In some cases it is also not possible to restore the original state by resetting to the "as-delivered" state.

The **Duplicate** option should always be used to transfer the configuration to a different device.

12.8 Protecting settings from unauthorized access

The settings can be protected from unauthorized access in two ways:

- Locking via parameters (software locking)
- Locking via write protection switch (hardware locking)

13 Diagnostics and troubleshooting

13.1 General troubleshooting

13.1.1 General errors

Error	Possible cause	Solution
Device does not respond.	Supply voltage does not match the value indicated on the nameplate.	Connect the correct voltage.
	The polarity of the supply voltage is wrong.	Correct the polarity.
	The cables do not contact the terminals properly.	Ensure electrical contact between the cable and the terminal.
Values on the display invisible	Contrast setting is too weak or too strong.	<ul style="list-style-type: none"> ▪ Increase contrast by pressing \oplus and \boxplus simultaneously. ▪ Decrease contrast by pressing \ominus and \boxplus simultaneously.
	The plug of the display cable is not connected correctly.	Connect the plug correctly.
	Display is defective.	Replace display.
"Communication error" is indicated on the display when starting the device or connecting the display.	Electromagnetic interference	Check grounding of the device.
	Broken display cable or display plug.	Replace display.
Duplication of parameters via display from one device to another not working. Only the "Save" and "Cancel" options are available.	Display with backup is not properly detected if a data backup was not carried out on the new device previously.	Connect display (with backup) and restart device.
Output current <3.6 mA	Signal cable connection incorrect.	Check connection.
	Electronics module is defective.	Replace electronics.
HART communication does not function.	Communication resistor missing or incorrectly installed.	Install the communication resistor (250 Ω) correctly.
	Commubox is connected incorrectly.	Connect Commubox correctly.
	Commubox is not set to "HART".	Set Commubox selector switch to "HART".
CDI communication does not work.	Wrong setting of the COM port on the computer.	Check the setting of the COM port on the computer and change it if necessary.
Device measures incorrectly.	Parameter configuration error	Check and correct the parameter configuration.
No communication with device via SmartBlue	No Bluetooth connection	Enable Bluetooth function on smartphone or tablet
	The device is already connected with another smartphone/tablet	Disconnect the device from the other smartphone/tablet
	Bluetooth module not connected	Connect Bluetooth module (see SD02252F).
Login via SmartBlue not possible	Device is being put into operation for the first time	Enter initial password (ID of Bluetooth module) and change it

Error	Possible cause	Solution
Device cannot be operated via SmartBlue	Incorrect password entered	Enter the correct password, paying attention to lower/upper case
Device cannot be operated via SmartBlue	Password forgotten	Contact Endress+Hauser Service (www.addresses.endress.com)

13.1.2 Error - SmartBlue operation

Error	Possible cause	Solution
Device is not visible in the live list	No Bluetooth connection	Enable Bluetooth® function on smartphone or tablet
		Bluetooth® function of sensor disabled, perform recovery sequence
Device is not visible in the live list	The device is already connected with another smartphone/tablet	Only one point-to-point connection is established between a sensor and a smartphone or tablet
Device is visible in the live list but cannot be accessed via SmartBlue	Android end device	Is the location function enabled for the app, was it approved the first time?
		GPS or positioning function must be activated for certain Android versions in conjunction with Bluetooth®
		Activate GPS - close the app fully and restart - enable the positioning function for the app
Device is visible in the live list but cannot be accessed via SmartBlue	Apple end device	Log in as standard Enter user name "admin" Enter initial password (ID of the Bluetooth module) paying attention to lower/upper case
Login via SmartBlue not possible	Device is being put into operation for the first time	Enter initial password (ID of the Bluetooth module) and change; paying attention to lower/upper case
Device cannot be operated via SmartBlue	Incorrect password entered	Enter correct password
Device cannot be operated via SmartBlue	Password forgotten	Contact the Endress+Hauser Service department (www.addresses.endress.com)

13.1.3 Parameter configuration errors

Parameter configuration errors for level measurements

Error	Possible cause	Solution
Measured value incorrect	If measured distance (Setup → Distance) matches the real distance: Calibration error	<ul style="list-style-type: none"> ▪ Check and adjust Empty calibration parameter (→ ☰ 131) if necessary. ▪ Check and adjust Full calibration parameter (→ ☰ 131) if necessary. ▪ Check and adjust linearization if necessary (Linearization submenu (→ ☰ 146)).
	If measured distance (Setup → Distance) does not match the real distance: Interference echo	Carry out mapping (Confirm distance parameter (→ ☰ 134)).
No change of measured value on filling/emptying	Interference echo	Carry out mapping (Confirm distance parameter (→ ☰ 134)).
	Buildup at the probe.	Clean the probe.
	Error in the echo tracking.	Deactivate echo tracking (Expert → Sensor → Echo tracking → Evaluation mode = History off).
Echo lost diagnostic message appears after switching on the supply voltage.	Noise level too high during initialization phase.	Enter Empty calibration parameter (→ ☰ 131) again.
Device displays a level when the tank is empty.	Incorrect probe length	<ul style="list-style-type: none"> ▪ Carry out probe length correction (Confirm probe length parameter (→ ☰ 162)). ▪ Carry out mapping over entire probe length while the tank is empty (Confirm distance parameter (→ ☰ 134)).
Wrong slope of the level throughout the complete measuring range	Wrong bin property selected.	Set Bin type parameter (→ ☰ 130) correctly.

13.2 Diagnostic information on local display

13.2.1 Diagnostic message

Faults detected by the self-monitoring system of the measuring device are displayed as a diagnostic message in alternation with the measured value display.

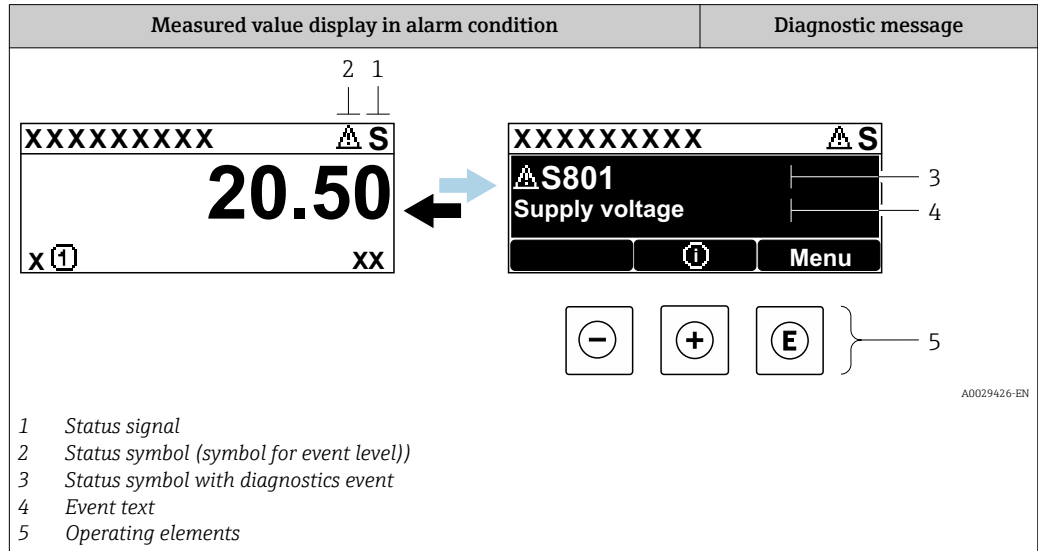

Status signals

F <small>A0032902</small>	"Failure (F)" option A device error is present. The measured value is no longer valid.
C <small>A0032903</small>	"Function check (C)" option The device is in service mode (e.g. during a simulation).
S <small>A0032904</small>	"Out of specification (S)" option The device is operated: <ul style="list-style-type: none"> ▪ Outside of its technical specifications (e.g. during startup or a cleaning) ▪ Outside of the configuration carried out by the user (e.g. level outside configured span)
M <small>A0032905</small>	"Maintenance required (M)" option Maintenance is required. The measured value is still valid.

Status symbol (symbol for event level)

⊗	"Alarm" status The measurement is interrupted. The signal outputs take on the defined alarm condition. A diagnostic message is generated.
⚠	"Warning" status The device continues to measure. A diagnostic message is generated.

Diagnostics event and event text

The fault can be identified using the diagnostics event. The event text helps you by providing information about the fault. In addition, the corresponding symbol is displayed before the diagnostics event.

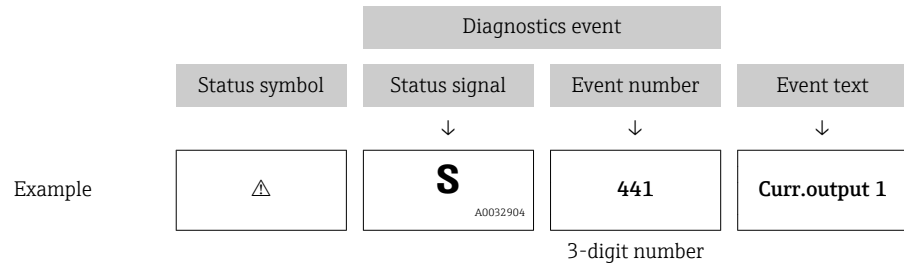

If two or more diagnostic messages are pending simultaneously, only the message with the highest priority is shown. Additional pending diagnostic messages can be shown in the **Diagnostic list** submenu.

-  Past diagnostic messages that are no longer pending are shown as follows:
 - On the local display:
 - in the **Event logbook** submenu
 - In FieldCare:
 - via the "Event List /HistoROM" function.

Operating elements

Operating functions in menu, submenu	
+	Plus key Opens the message about the remedial measures.
E	Enter key Opens the operating menu.

13.2.2 Calling up remedial measures

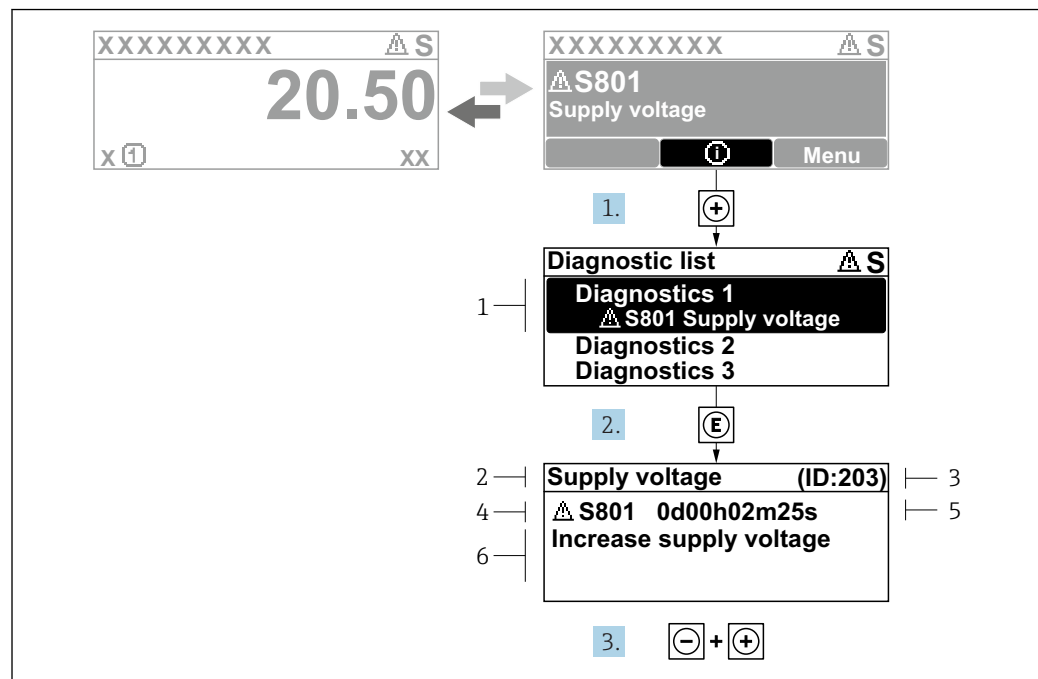

42 Message for remedial measures

- 1 Diagnostic information
- 2 Short text
- 3 Service ID
- 4 Diagnostic behavior with diagnostic code
- 5 Operation time of occurrence
- 6 Remedial measures

The user is in the diagnostic message.

1. Press **+** (Ⓢ-Symbol).
 - ↳ **Diagnostic list** submenu opens.
2. Select the desired diagnostic event with **+** or **-** and press **E**.
 - ↳ The message for the remedial measures for the selected diagnostic event opens.
3. Press **-** + **+** simultaneously.
 - ↳ The message for the remedial measures closes.

The user is in the **Diagnostics** menu at an entry for a diagnostics event, e.g. in **Diagnostic list** submenu or in **Previous diagnostics**.

1. Press **E**.
 - ↳ The message for the remedial measures for the selected diagnostic event opens.
2. Press **-** + **+** simultaneously.
 - ↳ The message for the remedial measures closes.

13.3 Diagnostic event in the operating tool

If a diagnostic event is present in the device, the status signal appears in the top left status in the operating tool along with the corresponding symbol for event level in accordance with NAMUR NE 107:

- Failure (F)
- Function check (C)
- Out of specification (S)
- Maintenance required (M)

A: Via the operating menu

1. Navigate to the **Diagnostics** menu.
 - ↳ In the **Actual diagnostics** parameter, the diagnostic event is shown with event text.
2. On the right in the display range, hover the cursor over the **Actual diagnostics** parameter.

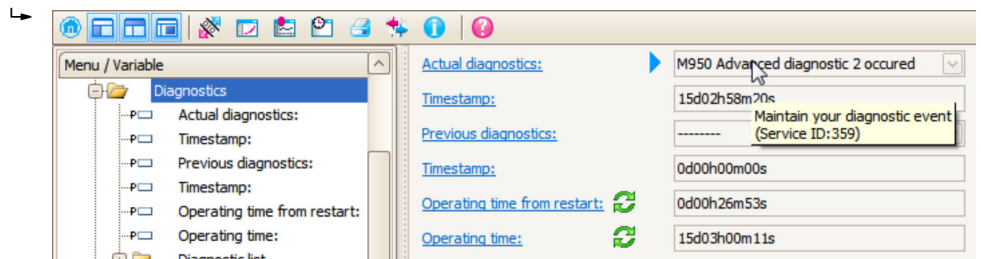

A tool tip with remedial measures for the diagnostic event appears.

B: Via the "Create documentation" function

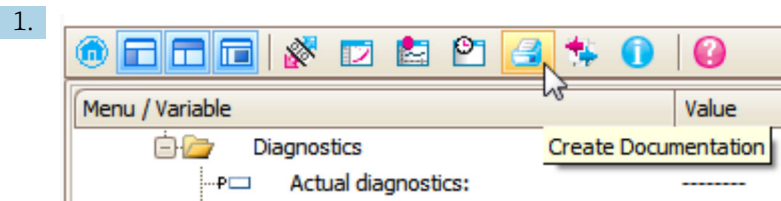

Select the "Create documentation" function.

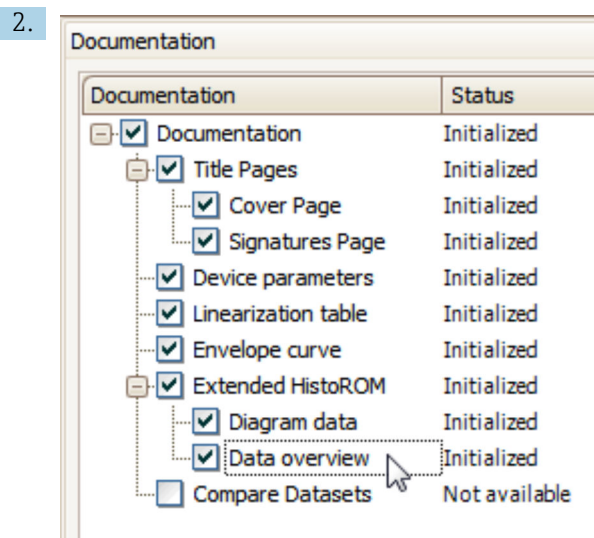

Make sure "Data overview" is marked.

3. Click "Save as ..." and save a PDF of the protocol.
 - ↳ The protocol contains the diagnostic messages and remedy information.

C: Via the "Eventlist / Extended HistoROM" function

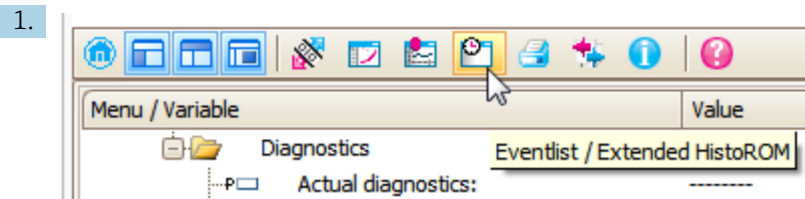

Select the "Eventlist / Extended HistoROM" function.



Select the "Load Eventlist" function.

- ↳ The list of events, including remedy information, is shown in the "Data overview" window.

13.4 Diagnostic list

In the **Diagnostic list** submenu submenu, up to 5 currently pending diagnostic messages can be displayed. If more than 5 messages are pending, the messages with the highest priority are shown on the display.

Navigation path

Diagnostics → Diagnostic list

Calling up and closing the remedial measures

1. Press \square .
 - ↳ The message for the remedial measures for the selected diagnostic event opens.
2. Press \square + \oplus simultaneously.
 - ↳ The message about the remedial measures closes.

13.5 List of diagnostic events

Diagnostic number	Short text	Remedy instructions	Status signal [from the factory]	Diagnostic behavior [from the factory]
Diagnostic of sensor				
003	Broken probe detected	1. Check map 2. Check sensor	F	Alarm
046	Build-up detected	Clean sensor	F	Alarm
104	HF cable	and check sealing 1. Dry HF cable connection 2. Change HF cable	F	Alarm
105	HF cable	1. Tighten HF cable connection 2. Check sensor 3. Change HF cable	F	Alarm
106	Sensor	1. Check sensor 2. Check HF cable 3. Contact service	F	Alarm
Diagnostic of electronic				
242	Software incompatible	1. Check software 2. Flash or change main electronics module	F	Alarm
252	Modules incompatible	1. Check if correct electronic modul is plugged 2. Replace electronic module	F	Alarm
261	Electronic modules	1. Restart device 2. Check electronic modules 3. Change I/O Modul or main electronics	F	Alarm
262	Module connection	1. Check module connections 2. Change electronic modules	F	Alarm
270	Main electronic failure	Change main electronic module	F	Alarm
271	Main electronic failure	1. Restart device 2. Change main electronic module	F	Alarm
272	Main electronic failure	1. Restart device 2. Contact service	F	Alarm
273	Main electronic failure	1. Emergency operation via display 2. Change main electronics	F	Alarm
275	I/O module defective	Change I/O module	F	Alarm
276	I/O module faulty	1. Restart device 2. Change I/O module	F	Alarm
276	I/O module faulty		F	Alarm
282	Data storage	1. Restart device 2. Contact service	F	Alarm
283	Memory content	1. Transfer data or reset device 2. Contact service	F	Alarm
311	Electronic failure	Maintenance required! 1. Do not perform reset 2. Contact service	M	Warning
Diagnostic of configuration				
410	Data transfer	1. Check connection 2. Retry data transfer	F	Alarm
411	Up-/download active	Up-/download active, please wait	C	Warning
412	Processing download	Download active, please wait	C	Warning

Diagnostic number	Short text	Remedy instructions	Status signal [from the factory]	Diagnostic behavior [from the factory]
431	Trim 1 to 2	Carry out trim	C	Warning
435	Linearization	Check linearization table	F	Alarm
437	Configuration incompatible	1. Restart device 2. Contact service	F	Alarm
438	Dataset	1. Check data set file 2. Check device configuration 3. Up- and download new configuration	M	Warning
441	Current output 1 to 2	1. Check process 2. Check current output settings	S	Warning
484	Failure mode simulation	Deactivate simulation	C	Alarm
485	Simulation measured value	Deactivate simulation	C	Warning
491	Current output 1 to 2 simulation	Deactivate simulation	C	Warning
494	Switch output simulation	Deactivate simulation switch output	C	Warning
495	Diagnostic event simulation	Deactivate simulation	C	Warning
585	Simulation distance	Deactivate simulation	C	Warning
Diagnostic of process				
801	Energy too low	Increase supply voltage	S	Warning
803	Current loop	1. Check wiring 2. Change I/O module	F	Alarm
825	Operating temperature	1. Check ambient temperature 2. Check process temperature	S	Warning
825	Operating temperature		F	Alarm
921	Change of reference	1. Check reference configuration 2. Check pressure 3. Check sensor	S	Warning
936	EMC interference	Check installation on EMC	F	Alarm
941	Echo lost	Check parameter 'DC value'	F	Alarm ¹⁾
942	In safety distance	1. Check level 2. Check safety distance 3. Reset self holding	S	Alarm ¹⁾
943	In blocking distance	Reduced accuracy Check level	S	Warning
944	Level range	Reduced accuracy Level at process connection	S	Warning
950	Advanced diagnostic 1 to 2 occurred	Maintain your diagnostic event	M	Warning ¹⁾

1) Diagnostic behavior can be changed.

13.6 Event logbook

13.6.1 Event history

A chronological overview of the event messages that have occurred is provided in the **Event list** submenu ²⁾.

Navigation path

Diagnostics → Event logbook → Event list

A maximum of 100 event messages can be displayed in chronological order.



Die Ereignishistorie umfasst Einträge zu:

- Diagnostic events
- Information events

In addition to the operation time of its occurrence, each event is also assigned a symbol that indicates whether the event has occurred or is ended:

- Diagnostic event
 - ☺: Event has occurred
 - ☹: Event has ended
- Information event
 - ☺: Event has occurred

Calling up and closing the remedial measures

1. Press 
 - ↳ The message for the remedial measures for the selected diagnostic event opens.
2. Press  +  simultaneously.
 - ↳ The message about the remedial measures closes.

13.6.2 Filtering the event logbook

Using the **Filter options** parameter, you can define which category of event messages is displayed in the **Event list** submenu.

Navigation path

Diagnostics → Event logbook → Filter options

Filter categories

- All
- Failure (F)
- Function check (C)
- Out of specification (S)
- Maintenance required (M)
- Information

13.6.3 Overview of information events

Info number	Info name
I1000	----- (Device ok)
I1089	Power on
I1090	Configuration reset
I1091	Configuration changed

2) This submenu is only available for operation via local display. In the case of operation via FieldCare, the event list can be displayed with the "Event List / HistoROM" functionality of FieldCare.

Info number	Info name
I1092	Embedded HistoROM deleted
I1110	Write protection switch changed
I1137	Electronic changed
I1151	History reset
I1154	Reset terminal voltage min/max
I1155	Reset electronic temperature
I1156	Memory error trend
I1157	Memory error event list
I1184	Display connected
I1185	Display backup done
I1186	Restore via display done
I1187	Settings downloaded with display
I1188	Display data cleared
I1189	Backup compared
I1256	Display: access status changed
I1264	Safety sequence aborted
I1335	Firmware changed
I1397	Fieldbus: access status changed
I1398	CDI: access status changed
I1512	Download started
I1513	Download finished
I1514	Upload started
I1515	Upload finished
I1554	Safety sequence started
I1555	Safety sequence confirmed
I1556	Safety mode off

13.7 Firmware history

Date	Firmware version	Modifications	Documentation (FMP56, FMP57, HART)		
			Operating Instructions	Description of Device Parameters	Technical Information
07.2010	01.00.zz	Original software	BA01004F/00/EN/05.10	GP01000F/00/EN/05.10	TI01004F/00/EN/05.10
01.2011	01.01.zz	<ul style="list-style-type: none"> ▪ SIL integrated ▪ Improvements and bugfixes ▪ Additional languages 	<ul style="list-style-type: none"> ▪ BA01004F/00/EN/10.10 ▪ BA01004F/00/EN/13.11 ▪ BA01004F/00/EN/14.12 	<ul style="list-style-type: none"> ▪ GP01000F/00/EN/10.10 ▪ GP01000F/00/EN/13.11 	<ul style="list-style-type: none"> ▪ TI01004F/00/EN/10.10 ▪ TI01004F/00/EN/13.11 ▪ TI01004F/00/EN/14.12 ▪ TI01004F/00/EN/15.12
02.2014	01.02.zz	<ul style="list-style-type: none"> ▪ Support of SD03 ▪ Additional languages ▪ HistoROM functionality enhanced ▪ "Advanced Diagnostics" function block integrated ▪ Improvements and bugfixes 	<ul style="list-style-type: none"> ▪ BA01004F/00/EN/15.13 ▪ BA01004F/00/EN/16.14 	<ul style="list-style-type: none"> ▪ GP01000F/00/EN/14.13 ▪ GP01000F/00/EN/15.14 	<ul style="list-style-type: none"> ▪ TI01004F/00/EN/16.13 ▪ TI01004F/00/EN/17.14
04.2016	01.03.zz	<ul style="list-style-type: none"> ▪ Update to HART 7 ▪ All 17 languages are available in the device ▪ Improvements and bugfixes 	<ul style="list-style-type: none"> ▪ BA01004F/00/EN/17.16 ▪ BA01004F/00/EN/18.16 ¹⁾ ▪ BA01004F/00/EN/20.18 ²⁾ 	GP01000F/00/EN/16.16	<ul style="list-style-type: none"> ▪ TI01004F/00/EN/18.16 ▪ TI01004F/00/EN/20.16 ¹⁾ ▪ TI01004F/00/EN/22.18 ²⁾

- 1) Contains information on the Heartbeat wizards available in the current DTM version for DeviceCare and FieldCare.
- 2) Contains information on the Bluetooth interface.



The firmware version can explicitly be ordered via the product structure. In this way it is possible to ensure compatibility of the firmware version with an existing or planned system integration.

14 Maintenance

The measuring device requires no special maintenance.

14.1 Exterior cleaning

When exterior-cleaning the device, always use cleaning agents that do not attack the surface of the housing and the seals.

15 Repair

15.1 General notes

15.1.1 Repair concept

Under the Endress+Hauser repair concept, devices have a modular design and repairs are carried out by Endress+Hauser Service or by properly trained customers.

Spare parts are grouped into logical kits with the associated replacement instructions.

For more information on service and spare parts, please contact Endress+Hauser Service.

15.1.2 Repair of Ex-certified devices

When repairing Ex-certified devices, please also note the following:

- Only specialist personnel or Endress+Hauser-Service can carry out repairs to Ex certified devices.
- Relevant standards and national regulations as well as safety instructions (XA) and certificates must be observed.
- Only genuine Endress+Hauser spare parts may be used.
- When ordering spare parts, please check the device designation on the nameplate. Only identical parts may be used as replacements.
- Carry out repairs according to the instructions. Following a repair, the device must fulfill the requirements of the individual tests specified for that device.
- A certified device may be converted to another certified device version by Endress +Hauser Service only.
- All repairs and modifications must be documented.

15.1.3 Replacing electronics modules

When electronics modules have been replaced the device does not need to be recalibrated as the parameters are saved in the HistoROM inside the housing. It may be necessary when replacing the main electronics to record a new interference echo suppression.

15.1.4 Replacing a device

Once a complete device has been replaced, the parameters can be transferred back into the device using one of the following methods:

- Using the display module
Prerequisite: The configuration of the old device was saved previously to the display module.
- Via FieldCare
Prerequisite: The configuration of the old device was saved previously to the computer using FieldCare.

You can continue measuring without performing a new calibration. Only interference echo suppression may need to be carried out once again.

15.2 Spare parts

- Some replaceable measuring device components are identified by means of a spare part nameplate. This contains information about the spare part.
- In the connection compartment cover of the device there is a spare part nameplate which contains the following information:
 - A list of the most important spare parts for the measuring device, including their ordering information.
 - The URL for the *W@M Device Viewer* (www.endress.com/deviceviewer):
All the spare parts for the measuring device, along with the order code, are listed here and can be ordered. If available, users can also download the associated Installation Instructions.

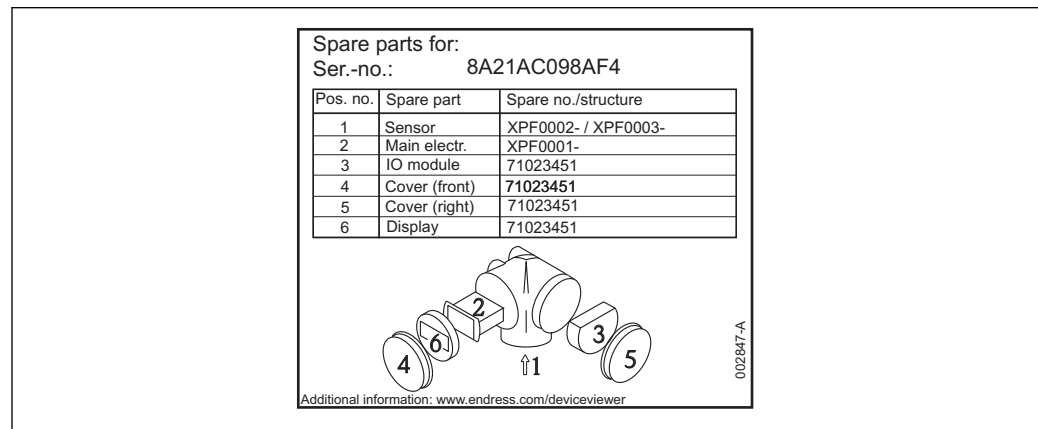

43 Example for spare part nameplate in the connection compartment cover

- i** Measuring device serial number:
 - Located on the device and spare part nameplate.
 - Can be read out via the "Serial number" parameter in the "Device information" submenu.

15.3 Return

The requirements for safe device return can vary depending on the device type and national legislation.

1. Refer to the website for more information:
<http://www.endress.com/support/return-material>
2. Return the device if repairs or a factory calibration are required, or if the wrong device was ordered or delivered.

15.4 Disposal



If required by the Directive 2012/19/EU on waste electrical and electronic equipment (WEEE), the product is marked with the depicted symbol in order to minimize the disposal of WEEE as unsorted municipal waste. Do not dispose of products bearing this marking as unsorted municipal waste. Instead, return them to Endress+Hauser for disposal under the applicable conditions.

16 Accessories

16.1 Device-specific accessories

16.1.1 Weather protection cover

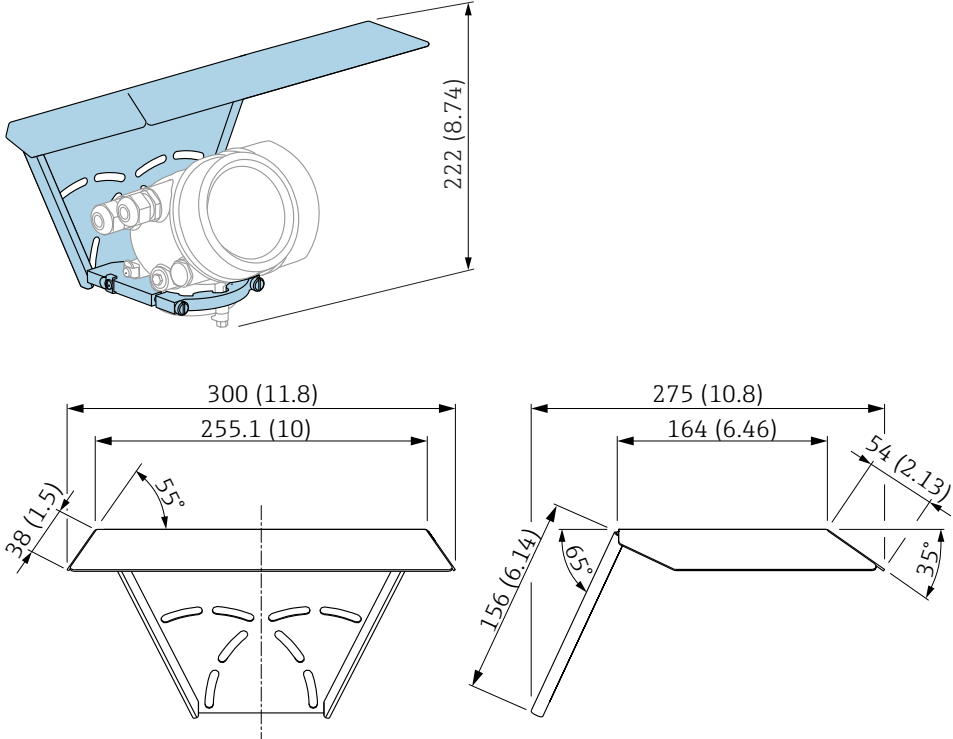
Accessory	Description
Weather protection cover	 <p data-bbox="1476 869 1528 884">A0015466</p> <p data-bbox="1476 1279 1528 1294">A0015472</p> <p data-bbox="416 1305 925 1332">☑ 44 Weather protection cover; Dimensions: mm (in)</p> <p data-bbox="416 1357 1492 1440"> i The weather protection cover can be ordered together with the device (product structure, feature 620 "Accessory Enclosed", option PB "Weather Protection Cover"). Alternatively, it can be separately ordered as an accessory; order code 71162242. </p>



16.1.2 Mounting bracket for electronics housing

Accessories	Description
<p>Mounting bracket for electronics housing</p>	<div style="display: flex; justify-content: space-around;"> <div style="text-align: center;"> <p>A</p> </div> <div style="text-align: center;"> <p>B</p> </div> </div> <p> 45 Mounting bracket for electronics housing; engineering unit: mm (in)</p> <p>A Wall mounting B Post mounting</p> <p> With "remote sensor" device versions (see feature 060 in the product structure), the mounting bracket is included in the scope of delivery. However, it can also be ordered separately as an accessory (order number: 71102216).</p> <p style="text-align: right; font-size: small;">A0014793</p>

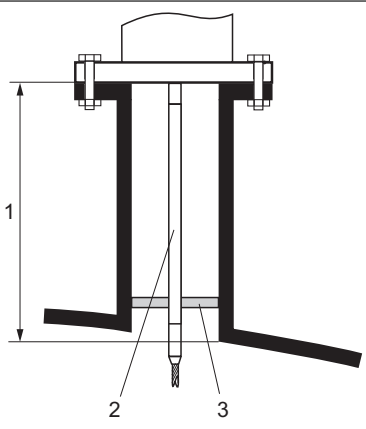
16.1.3 Rod extension / centering device

Accessories	Description																																																		
<p>Rod extension / centering device HMP40</p> <ul style="list-style-type: none"> ▪ Suitable for: FMP57 ▪ Permitted temperature at lower edge of nozzle: <ul style="list-style-type: none"> ▪ without centering disk: no restriction ▪ with centering disk: -40 to +150 °C (-40 to +302 °F) ▪ Additional information: SD01002F 	 <p style="text-align: right; font-size: small;">A0013597</p> <p>1 Nozzle height 2 Extension rod 3 Centering disk</p> <table border="1" style="width: 100%; border-collapse: collapse;"> <tr> <td style="width: 5%;">010</td> <td>Approval:</td> </tr> <tr> <td>A</td> <td>Non-hazardous area</td> </tr> <tr> <td>M</td> <td>FM DIP Cl.II Div.1 Gr.E-G N.I., Zone 21,22</td> </tr> <tr> <td>P</td> <td>CSA DIP Cl.II Div.1 Gr.G + coal dust N.I.</td> </tr> <tr> <td>S</td> <td>FM Cl.I, II, III Div.1 Gr.A-G N.I., Zone 0,1,2,20,21,22</td> </tr> <tr> <td>U</td> <td>CSA Cl.I, II, III Div.1 Gr.A-G N.I., Zone 0,1,2</td> </tr> <tr> <td>1</td> <td>ATEX II 1G</td> </tr> <tr> <td>2</td> <td>ATEX II 1D</td> </tr> <tr> <td colspan="2">020 Extension rod; height of nozzle:</td> </tr> <tr> <td>1</td> <td>115mm; 150-250mm / 6-10"</td> </tr> <tr> <td>2</td> <td>215mm; 250-350mm / 10-14"</td> </tr> <tr> <td>3</td> <td>315mm; 350-450mm / 14-18"</td> </tr> <tr> <td>4</td> <td>415mm; 450-550mm / 18-22"</td> </tr> <tr> <td>9</td> <td>Special version; TSP no. to be specified</td> </tr> <tr> <td colspan="2">030 Centering disk:</td> </tr> <tr> <td>A</td> <td>Not selected</td> </tr> <tr> <td>B</td> <td>DN40 / 1-1/2", inside-d. = 40-45mm, PPS</td> </tr> <tr> <td>C</td> <td>DN50 / 2", inside-d. = 50-57mm, PPS</td> </tr> <tr> <td>D</td> <td>DN80 / 3", inside-d. = 80-85mm, PPS</td> </tr> <tr> <td>E</td> <td>DN80 / 3", inside-d. = 76-78mm, PPS</td> </tr> <tr> <td>G</td> <td>DN100 / 4", inside-d. = 100-110mm, PPS</td> </tr> <tr> <td>H</td> <td>DN150 / 6", inside-d. = 152-164mm, PPS</td> </tr> <tr> <td>J</td> <td>DN200 / 8", inside-d. = 210-215mm, PPS</td> </tr> <tr> <td>K</td> <td>DN250 / 10", inside-d. = 253-269mm, PPS</td> </tr> <tr> <td>Y</td> <td>Special version; TSP no. to be specified</td> </tr> </table>	010	Approval:	A	Non-hazardous area	M	FM DIP Cl.II Div.1 Gr.E-G N.I., Zone 21,22	P	CSA DIP Cl.II Div.1 Gr.G + coal dust N.I.	S	FM Cl.I, II, III Div.1 Gr.A-G N.I., Zone 0,1,2,20,21,22	U	CSA Cl.I, II, III Div.1 Gr.A-G N.I., Zone 0,1,2	1	ATEX II 1G	2	ATEX II 1D	020 Extension rod; height of nozzle:		1	115mm; 150-250mm / 6-10"	2	215mm; 250-350mm / 10-14"	3	315mm; 350-450mm / 14-18"	4	415mm; 450-550mm / 18-22"	9	Special version; TSP no. to be specified	030 Centering disk:		A	Not selected	B	DN40 / 1-1/2", inside-d. = 40-45mm, PPS	C	DN50 / 2", inside-d. = 50-57mm, PPS	D	DN80 / 3", inside-d. = 80-85mm, PPS	E	DN80 / 3", inside-d. = 76-78mm, PPS	G	DN100 / 4", inside-d. = 100-110mm, PPS	H	DN150 / 6", inside-d. = 152-164mm, PPS	J	DN200 / 8", inside-d. = 210-215mm, PPS	K	DN250 / 10", inside-d. = 253-269mm, PPS	Y	Special version; TSP no. to be specified
010	Approval:																																																		
A	Non-hazardous area																																																		
M	FM DIP Cl.II Div.1 Gr.E-G N.I., Zone 21,22																																																		
P	CSA DIP Cl.II Div.1 Gr.G + coal dust N.I.																																																		
S	FM Cl.I, II, III Div.1 Gr.A-G N.I., Zone 0,1,2,20,21,22																																																		
U	CSA Cl.I, II, III Div.1 Gr.A-G N.I., Zone 0,1,2																																																		
1	ATEX II 1G																																																		
2	ATEX II 1D																																																		
020 Extension rod; height of nozzle:																																																			
1	115mm; 150-250mm / 6-10"																																																		
2	215mm; 250-350mm / 10-14"																																																		
3	315mm; 350-450mm / 14-18"																																																		
4	415mm; 450-550mm / 18-22"																																																		
9	Special version; TSP no. to be specified																																																		
030 Centering disk:																																																			
A	Not selected																																																		
B	DN40 / 1-1/2", inside-d. = 40-45mm, PPS																																																		
C	DN50 / 2", inside-d. = 50-57mm, PPS																																																		
D	DN80 / 3", inside-d. = 80-85mm, PPS																																																		
E	DN80 / 3", inside-d. = 76-78mm, PPS																																																		
G	DN100 / 4", inside-d. = 100-110mm, PPS																																																		
H	DN150 / 6", inside-d. = 152-164mm, PPS																																																		
J	DN200 / 8", inside-d. = 210-215mm, PPS																																																		
K	DN250 / 10", inside-d. = 253-269mm, PPS																																																		
Y	Special version; TSP no. to be specified																																																		

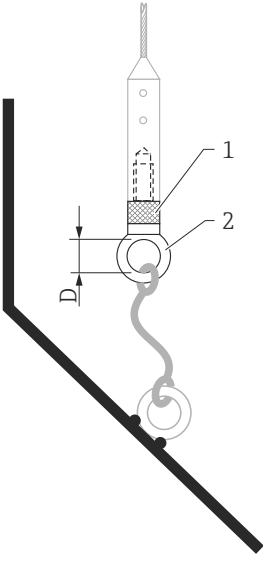
16.1.4 Mounting kit, insulated

Accessories	Description
Mounting kit, insulated suitable for <ul style="list-style-type: none"> ■ FMP56 ■ FMP57 	<div style="text-align: center;">  </div> <p style="text-align: right; font-size: small;">A0013586</p> <p>☑ 46 Scope of delivery of mounting kit:</p> <p>1 Insulation sleeve 2 Eye bolt</p> <p>To secure rope probes so that they are reliably insulated. Maximum process temperature: 150 °C (300 °F)</p> <p>For rope probes 4 mm (1/6 in) or 6 mm (1/4 in) with PA>steel :</p> <ul style="list-style-type: none"> ■ Diameter D = 20 mm (0.8 in) ■ Order number: 52014249 <p>For rope probes 6 mm (1/4 in) or 8 mm (1/3 in) with PA>steel:</p> <ul style="list-style-type: none"> ■ Diameter D = 25 mm (1 in) ■ Order number: 52014250 <p>Due to the risk of electrostatic charge, the insulation sleeve is not suitable for use in hazardous areas! In this case, the probe must be secured so that it is reliably grounded.</p> <p> The mounting kit can also be ordered directly with the device (Levelflex product structure, feature 620 "Accessory enclosed", version PG "mounting kit, insulated, rope").</p>

16.1.5 Remote display FHX50

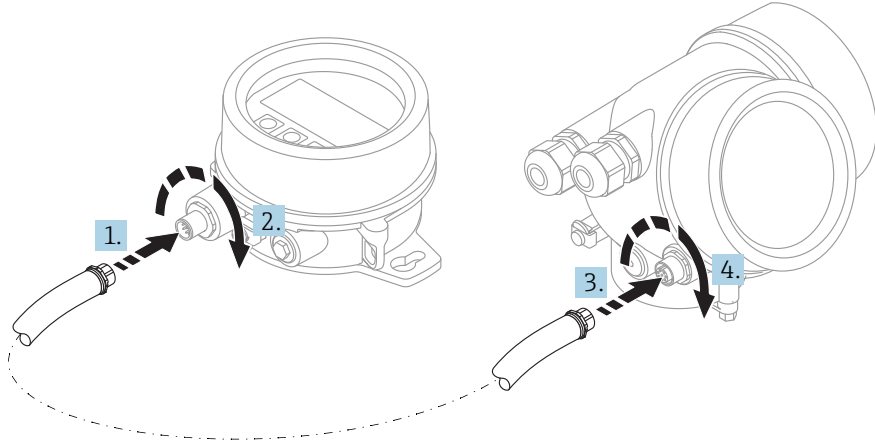
Accessories	Description
Remote display FHX50	<div style="text-align: center;">  </div> <p style="text-align: right; font-size: small;">A0019128</p> <ul style="list-style-type: none"> ▪ Material: <ul style="list-style-type: none"> ▪ Plastic PBT ▪ 316L/1.4404 ▪ Aluminum ▪ Degree of protection: IP68 / NEMA 6P and IP66 / NEMA 4x ▪ Suitable for display modules: <ul style="list-style-type: none"> ▪ SD02 (push buttons) ▪ SD03 (touch control) ▪ Connecting cable: <ul style="list-style-type: none"> ▪ Cable supplied with device up to 30 m (98 ft) ▪ Standard cable supplied by customer up to 60 m (196 ft) ▪ Ambient temperature range: -40 to 80 °C (-40 to 176 °F) ▪ Ambient temperature range (option): -50 to 80 °C (-58 to 176 °F) ¹⁾ <p> i If the remote display should be used, order the device version "Prepared for display FHX50" (feature 030, version L, M or N). For the FHX50, you must select option A: "Prepared for display FHX50" under feature 050 "Measuring device version". </p> <p> i If the device version "Prepared for display FHX50" was not originally ordered and a FHX50 display is to be retrofitted, you must select version B "Not prepared for display FHX50" under feature 050: "Measuring device version" when ordering the FHX50. In this case, a retrofit kit for the device is supplied with the FHX50. The kit can be used to prepare the device so that the FHX50 can be used. </p> <p> i Use of the FHX50 may be restricted for transmitters with an approval. A device can only be retrofitted with the FHX50 if the option L, M or N ("Prepared for FHX50") is listed under <i>Basic specifications</i>, item 4 "Display, operation" in the Safety Instructions (XA) for the device. Also pay attention to the Safety Instructions (XA) of the FHX50. </p> <p> i Retrofitting is not possible on transmitters with: <ul style="list-style-type: none"> ▪ An approval for use in areas with flammable dust (dust ignition-proof approval) ▪ Ex nA type of protection </p> <p> i For details, see document SD01007F. </p>

1) This range is valid if option JN "Ambient temperature transmitter -50 °C (-58 °F)" has been selected in ordering feature 580 "Test, Certificate". If the temperature is permanently below -40 °C (-40 °F), failure rates may be increased.

16.1.6 Overvoltage protection

Accessories	Description
Overvoltage protection for 2-wire devices OVP10 (1-channel) OVP20 (2-channel)	<div data-bbox="327 324 715 660" style="text-align: center;"> </div> <div data-bbox="1380 667 1436 683" style="text-align: right; font-size: small;">A0021734</div> <p>Technical data</p> <ul style="list-style-type: none"> ■ Resistance per channel: $2 \times 0.5 \Omega_{\max}$ ■ Threshold DC voltage: 400 to 700 V ■ Threshold surge voltage: < 800 V ■ Capacitance at 1 MHz: < 1.5 pF ■ Nominal leakage current (8/20 μs): 10 kA ■ Suitable for conductor cross-sections: 0.2 to 2.5 mm² (24 to 14 AWG) <p>i Ordered with the device Ideally, the overvoltage protection module should be ordered directly with the device. See product structure, feature 610 "Accessory mounted", option NA "Overvoltage protection". Separate order necessary only if retrofitting.</p> <p>i Order numbers for retrofitting</p> <ul style="list-style-type: none"> ■ For 1-channel devices (feature 020, option A): OVP10: 71128617 ■ For 2-channel devices (feature 020, options B, C, E or G) OVP20: 71128619 <p>Housing cover for retrofitting In order to keep the necessary safety distances when using the surge arrester module, the housing cover also needs to be replaced when the device is retrofitted. Depending on the housing type, the suitable cover can be ordered using the following material number:</p> <ul style="list-style-type: none"> ■ Housing GT18: cover 71185516 ■ Housing GT19: cover 71185518 ■ Housing GT20: cover 71185517 <p>i Restrictions in case of retrofitting The use of the OVP module may be restricted depending on the transmitter approval. A device may only be retrofitted with the OVP module if the option NA (overvoltage protection) is listed under <i>Optional specifications</i> in the Safety Instructions (XA) associated with the device.</p> <p>i For details, see SD01090F.</p>

16.1.7 Bluetooth module for HART devices

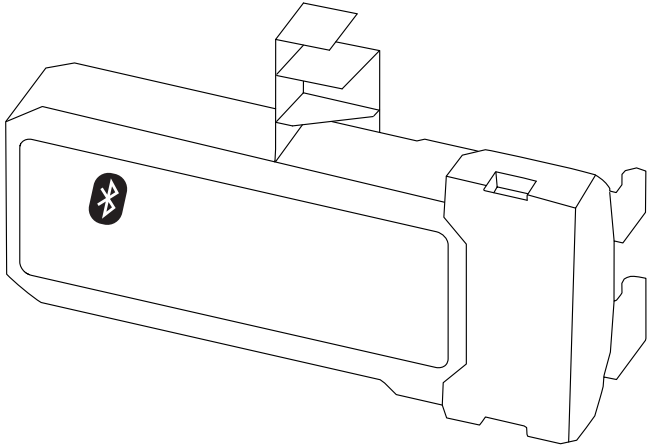
Accessory	Description
Bluetooth module	<div style="text-align: right; margin-bottom: 10px;">A0036493</div>  <ul style="list-style-type: none"> ▪ Quick and easy commissioning via SmartBlue (app) ▪ No additional tools or adapters required ▪ Signal curve via SmartBlue (app) ▪ Encrypted single point-to-point data transmission (tested by Fraunhofer institute) and password protected communication via Bluetooth® wireless technology ▪ Range under reference conditions: > 10 m (33 ft) <p>i When using the Bluetooth module the minimum supply voltage increases by up to 3 V.</p> <p>i Ordering with device The Bluetooth module is preferably ordered with the device. See product structure, feature 610 "Accessory Mounted", option NF "Bluetooth". A separate order is only necessary in case of retrofitting.</p> <p>i Order code for retrofitting Bluetooth module (BT10): 71377355</p> <p>i Restrictions in case of retrofitting Depending on the approval of the transmitter, application of the Bluetooth module may be restricted. A device may only be retrofitted with a Bluetooth module if the option <i>NF</i> (Bluetooth) is listed in the associated Safety Instructions (<i>XA</i>) under <i>Optional specifications</i>.</p> <p>i For details refer to SD02252F.</p>

16.2 Communication-specific accessories

Commubox FXA195 HART

For intrinsically safe HART communication with FieldCare via the USB interface



For details, see "Technical Information" TI00404F

Commubox FXA291

Connects Endress+Hauser field devices with a CDI interface (= Endress+Hauser Common Data Interface) and the USB port of a computer or laptop

Order number: 51516983



For details, see "Technical Information" TI00405C

HART Loop Converter HMX50

Is used to evaluate and convert dynamic HART process variables to analog current signals or limit values

Order number: 71063562



For details, see "Technical Information" TI00429F and Operating Instructions BA00371F

WirelessHART adapter SWA70

- Is used for the wireless connection of field devices
- The WirelessHART adapter can be easily integrated into field devices and existing infrastructures, offers data protection and transmission safety and can be operated in parallel with other wireless networks



For details, see Operating Instructions BA00061S

Connect Sensor FXA30/FXA30B

Fully integrated, battery-powered gateway for simple applications with SupplyCare Hosting. Up to 4 field devices with 4 to 20 mA communication (FXA30/FXA30B), serial Modbus (FXA30B) or HART (FXA30B) can be connected. With its robust design and ability to run for years on the battery, it is ideal for remote monitoring in isolated locations. Version with LTE (USA, Canada and Mexico only) or 3G mobile transmission for worldwide communication.



For details, see "Technical Information" TI01356S and Operating Instructions BA01710S.

Fieldgate FXA42

Fieldgates enable communication between connected 4 to 20 mA, Modbus RS485 and Modbus TCP devices and SupplyCare Hosting or SupplyCare Enterprise. The signals are transmitted either via Ethernet TCP/IP, WLAN or mobile communications (UMTS). Advanced automation capabilities are available, such as an integrated Web-PLC, OpenVPN and other functions.



For details, see "Technical Information" TI01297S and Operating Instructions BA01778S.

SupplyCare Enterprise SCE30B

Inventory management software that displays the level, volume, mass, temperature, pressure, density or other parameters of tanks. The parameters are recorded and transmitted by means of gateways like Fieldgate FXA42, Connect Sensor FXA30B or other gateway types.

This Web-based software is installed on a local server and can also be visualized and operated with mobile terminals such as a smartphone or tablet.



For details, see Technical Information TI01228S and Operating Instructions BA00055S

SupplyCare Hosting SCH30

Inventory management software that displays the level, volume, mass, temperature, pressure, density or other parameters of tanks. The parameters are recorded and

transmitted by means of gateways like Fieldgate FXA42, Connect Sensor FXA30B or other gateway types.

SupplyCare Hosting is offered as a hosting service (Software as a Service, SaaS). In the Endress+Hauser portal, the user is provided with the data over the Internet.

 For details, see Technical Information TI01229S and Operating Instructions BA00050S

Field Xpert SFX350

Field Xpert SFX350 is a mobile computer for commissioning and maintenance. It enables efficient device configuration and diagnostics for HART and FOUNDATION Fieldbus devices in the **non-Ex area**.

 For details, see Operating Instructions BA01202S

Field Xpert SFX370

Field Xpert SFX370 is a mobile computer for commissioning and maintenance. It enables efficient device configuration and diagnostics for HART and FOUNDATION Fieldbus devices in the **non-Ex area** and the **Ex area**.

 For details, see Operating Instructions BA01202S

16.3 Service-specific accessories

DeviceCare SFE100

Configuration tool for HART, PROFIBUS and FOUNDATION Fieldbus field devices

 Technical Information TI01134S

FieldCare SFE500

FDT-based plant asset management tool

It can configure all smart field units in your system and helps you manage them. By using the status information, it is also a simple but effective way of checking their status and condition.

 Technical Information TI00028S

16.4 System components

Memograph M graphic data manager

The Memograph M graphic data manager provides information on all the relevant process variables. Measured values are recorded correctly, limit values are monitored and measuring points analyzed. The data are stored in the 256 MB internal memory and also on a SD card or USB stick.

 Technical Information TI00133R and Operating Instructions BA00247R

RN221N

Active barrier with power supply for safe separation of 4 to 20 mA standard signal circuits. Offers bidirectional HART transmission.

 Technical Information TI00073R and Operating Instructions BA00202R

RN221





















Supply unit for powering two 2-wire measuring devices solely in the non-Ex area. Bidirectional communication is possible via the HART communication jacks.

























 Technical Information TI00081R and Brief Operating Instructions KA00110R



























17 Operating menu

17.1 Overview of the operating menu (SmartBlue)

Navigation  SmartBlue

Setup	→  130
Device tag	→  130
Distance unit	→  130
Bin type	→  130
Empty calibration	→  131
Full calibration	→  131
Level	→  132
Distance	→  132
Signal quality	→  133
Confirm distance	→  134
Present mapping	→  135
Mapping end point	→  135
Record map	→  135
Advanced setup	→  138
Locking status	→  138
Access status tooling	→  138
Enter access code	→  139
Level	→  140
Medium type	→  140
Medium property	→  140
Process property	→  141

Advanced process conditions	→  142
Level unit	→  143
Blocking distance	→  143
Level correction	→  144
► Linearization	→  146
Linearization type	→  148
Unit after linearization	→  149
Free text	→  150
Level linearized	→  151
Maximum value	→  151
Diameter	→  151
Intermediate height	→  152
Table mode	→  152
Table number	→  153
Level	→  154
Level	→  154
Customer value	→  154
Activate table	→  154
► Probe settings	→  161
Probe grounded	→  161
Present probe length	→  161
Confirm probe length	→  162
► Safety settings	→  156
Output echo lost	→  156
Value echo lost	→  156























Ramp at echo lost	→  157
Blocking distance	→  143
► Current output 1 to 2	→  164
Assign current output	→  164
Current span	→  165
Fixed current	→  165
Damping output	→  166
Failure mode	→  166
Failure current	→  167
Output current 1 to 2	→  167
► Switch output	→  168
Switch output function	→  168
Assign status	→  169
Assign limit	→  169
Assign diagnostic behavior	→  169
Switch-on value	→  170
Switch-on delay	→  171
Switch-off value	→  171
Switch-off delay	→  172
Failure mode	→  172
Switch status	→  172
Invert output signal	→  172
 Diagnostics	→  186
Actual diagnostics	→  186
Timestamp	→  186

























Previous diagnostics	→ 186
Timestamp	→ 187
Operating time from restart	→ 187
Operating time	→ 180
► Diagnostic list	→ 188
Diagnostics 1 to 5	→ 188
Timestamp 1 to 5	→ 188
► Measured values	→ 193
Distance	→ 132
Level linearized	→ 151
Output current 1 to 2	→ 167
Measured current 1	→ 194
Terminal voltage 1	→ 194
► Device information	→ 190
Device tag	→ 190
Serial number	→ 190
Firmware version	→ 190
Device name	→ 190
Order code	→ 191
Extended order code 1 to 3	→ 191
Device revision	→ 191
Device ID	→ 191

Device type	→ 192
Manufacturer ID	→ 192
► Simulation	→ 199
Assign measurement variable	→ 200
Process variable value	→ 200
Current output 1 to 2 simulation	→ 200
Value current output 1 to 2	→ 201
Switch output simulation	→ 201
Switch status	→ 201
Device alarm simulation	→ 202

17.2 Overview of the operating menu (display module)

Navigation  Operating menu

























Language	→  174
Setup	→  130
Device tag	→  130
Distance unit	→  130
Bin type	→  130
Empty calibration	→  131
Full calibration	→  131
Level	→  132
Distance	→  132
Signal quality	→  133
Mapping	→  137
Confirm distance	→  137
Mapping end point	→  137
Record map	→  137
Distance	→  137
Advanced setup	→  138
Locking status	→  138
Access status display	→  139
Enter access code	→  139
Level	→  140
Medium type	→  140
Medium property	→  140
Process property	→  141



Advanced process conditions	→  142
Level unit	→  143
Blocking distance	→  143
Level correction	→  144
▶ Linearization	→  146
Linearization type	→  148
Unit after linearization	→  149
Free text	→  150
Maximum value	→  151
Diameter	→  151
Intermediate height	→  152
Table mode	→  152
▶ Edit table	
Level	→  154
Customer value	→  154
Activate table	→  154
▶ Safety settings	→  156
Output echo lost	→  156
Value echo lost	→  156
Ramp at echo lost	→  157
Blocking distance	→  143
▶ SIL/WHG confirmation	→  159
▶ Deactivate SIL/WHG	→  160
Reset write protection	→  160
Code incorrect	→  160

▶ Probe settings	→ 161
Probe grounded	→ 161
▶ Probe length correction	→ 163
Confirm probe length	→ 163
Present probe length	→ 163
▶ Current output 1 to 2	→ 164
Assign current output	→ 164
Current span	→ 165
Fixed current	→ 165
Damping output	→ 166
Failure mode	→ 166
Failure current	→ 167
Output current 1 to 2	→ 167
▶ Switch output	→ 168
Switch output function	→ 168
Assign status	→ 169
Assign limit	→ 169
Assign diagnostic behavior	→ 169
Switch-on value	→ 170
Switch-on delay	→ 171
Switch-off value	→ 171
Switch-off delay	→ 172
Failure mode	→ 172
Switch status	→ 172
Invert output signal	→ 172

► Display	→ 174
Language	→ 174
Format display	→ 174
Value 1 to 4 display	→ 176
Decimal places 1 to 4	→ 176
Display interval	→ 176
Display damping	→ 177
Header	→ 177
Header text	→ 178
Separator	→ 178
Number format	→ 178
Decimal places menu	→ 178
Backlight	→ 179
Contrast display	→ 179
► Configuration backup display	→ 180
Operating time	→ 180
Last backup	→ 180

Configuration management	→ 180
Comparison result	→ 181
▶ Administration	→ 183
▶ Define access code	→ 185
Define access code	→ 185
Confirm access code	→ 185
Device reset	→ 183
🔍 Diagnostics	→ 186
Actual diagnostics	→ 186
Previous diagnostics	→ 186
Operating time from restart	→ 187
Operating time	→ 180
▶ Diagnostic list	→ 188
Diagnostics 1 to 5	→ 188
▶ Event logbook	→ 189
Filter options	→ 189
▶ Event list	→ 189
▶ Device information	→ 190
Device tag	→ 190
Serial number	→ 190
Firmware version	→ 190
Device name	→ 190
Order code	→ 191
Extended order code 1 to 3	→ 191
Device revision	→ 191

Device ID	→  191
Device type	→  192
Manufacturer ID	→  192
▶ Measured values	→  193
Distance	→  132
Level linearized	→  151
Output current 1 to 2	→  167
Measured current 1	→  194
Terminal voltage 1	→  194
▶ Data logging	→  195
Assign channel 1 to 4	→  195
Logging interval	→  196
Clear logging data	→  196
▶ Display channel 1 to 4	→  197
▶ Simulation	→  199
Assign measurement variable	→  200
Process variable value	→  200
Current output 1 to 2 simulation	→  200
Value current output 1 to 2	→  201
Switch output simulation	→  201
Switch status	→  201
Device alarm simulation	→  202
▶ Device check	→  203
Start device check	→  203
Result device check	→  203

Last check time	→  203
Level signal	→  204
Launch signal	→  204

17.3 Overview of the operating menu (operating tool)

Navigation



























Operating menu



















Setup	→ 130
Device tag	→ 130
Distance unit	→ 130
Bin type	→ 130
Empty calibration	→ 131
Full calibration	→ 131
Level	→ 132
Distance	→ 132
Signal quality	→ 133
Confirm distance	→ 134
Present mapping	→ 135
Mapping end point	→ 135
Record map	→ 135
▶ Advanced setup	→ 138
Locking status	→ 138
Access status tooling	→ 138
Enter access code	→ 139
▶ Level	→ 140
Medium type	→ 140
Medium property	→ 140
Process property	→ 141
Advanced process conditions	→ 142
Level unit	→ 143

Blocking distance	→ 143
Level correction	→ 144
► Linearization	→ 146
Linearization type	→ 148
Unit after linearization	→ 149
Free text	→ 150
Level linearized	→ 151
Maximum value	→ 151
Diameter	→ 151
Intermediate height	→ 152
Table mode	→ 152
Table number	→ 153
Level	→ 154
Level	→ 154
Customer value	→ 154
Activate table	→ 154
► Safety settings	→ 156
Output echo lost	→ 156
Value echo lost	→ 156
Ramp at echo lost	→ 157
Blocking distance	→ 143
► SIL/WHG confirmation	→ 159
► Deactivate SIL/WHG	→ 160
Reset write protection	→ 160
Code incorrect	→ 160





▶ Probe settings	→ 161
Probe grounded	→ 161
Present probe length	→ 161
Confirm probe length	→ 162
▶ Current output 1 to 2	→ 164
Assign current output	→ 164
Current span	→ 165
Fixed current	→ 165
Damping output	→ 166
Failure mode	→ 166
Failure current	→ 167
Output current 1 to 2	→ 167
▶ Switch output	→ 168
Switch output function	→ 168
Assign status	→ 169
Assign limit	→ 169
Assign diagnostic behavior	→ 169
Switch-on value	→ 170
Switch-on delay	→ 171
Switch-off value	→ 171
Switch-off delay	→ 172
Failure mode	→ 172
Switch status	→ 172
Invert output signal	→ 172

▶ Display	→ 📖 174
Language	→ 📖 174
Format display	→ 📖 174
Value 1 to 4 display	→ 📖 176
Decimal places 1 to 4	→ 📖 176
Display interval	→ 📖 176
Display damping	→ 📖 177
Header	→ 📖 177
Header text	→ 📖 178
Separator	→ 📖 178
Number format	→ 📖 178
Decimal places menu	→ 📖 178
Backlight	→ 📖 179
Contrast display	→ 📖 179
▶ Configuration backup display	→ 📖 180
Operating time	→ 📖 180
Last backup	→ 📖 180
Configuration management	→ 📖 180
Backup state	→ 📖 181
Comparison result	→ 📖 181
▶ Administration	→ 📖 183
Define access code	→ 📖 185
Device reset	→ 📖 183
🔍 Diagnostics	→ 📖 186
Actual diagnostics	→ 📖 186

Timestamp	→  186
Previous diagnostics	→  186
Timestamp	→  187
Operating time from restart	→  187
Operating time	→  180
▶ Diagnostic list	→  188
Diagnostics 1 to 5	→  188
Timestamp 1 to 5	→  188
▶ Device information	→  190
Device tag	→  190
Serial number	→  190
Firmware version	→  190
Device name	→  190
Order code	→  191
Extended order code 1 to 3	→  191
Device revision	→  191
Device ID	→  191
Device type	→  192
Manufacturer ID	→  192
▶ Measured values	→  193
Distance	→  132
Level linearized	→  151
Output current 1 to 2	→  167
Measured current 1	→  194
Terminal voltage 1	→  194



▶ Data logging	→  195
Assign channel 1 to 4	→  195
Logging interval	→  196
Clear logging data	→  196
▶ Simulation	→  199
Assign measurement variable	→  200
Process variable value	→  200
Current output 1 to 2 simulation	→  200
Value current output 1 to 2	→  201
Switch output simulation	→  201
Switch status	→  201
Device alarm simulation	→  202
▶ Device check	→  203
Start device check	→  203
Result device check	→  203
Last check time	→  203
Level signal	→  204
Launch signal	→  204
▶ Heartbeat	→  205

17.4 "Setup" menu



-   : Indicates navigation to the parameter via the display and operating module
-  : Indicates navigation to the parameter via operating tools (e.g. FieldCare)
-  : Indicates parameters that can be locked via the access code.

Navigation   Setup



Device tag

- Navigation**   Setup → Device tag
- Description** Enter a unique name for the measuring point to identify the device quickly within the plant.
- Factory setting** FMP5x

Distance unit

- Navigation**   Setup → Distance unit
- Description** Used for the basic calibration (Empty / Full).
- Selection**
- | | |
|---|--|
| <i>SI units</i> | <i>US units</i> |
| <ul style="list-style-type: none"> ▪ mm ▪ m | <ul style="list-style-type: none"> ▪ ft ▪ in |
- Factory setting** m

Bin type

- Navigation**   Setup → Bin type
- Prerequisite** **Medium type (→  140) = Solid**
- Description** Specify bin type.
- Selection**
- Concrete
 - Plastic wood
 - Metallic
 - Aluminium
- Factory setting** Metallic

Empty calibration

**Navigation**

Setup → Empty calibr.

Description

Distance between process connection and minimum level (0%).

User entry

Depending on the probe

Factory setting

Depending on the probe

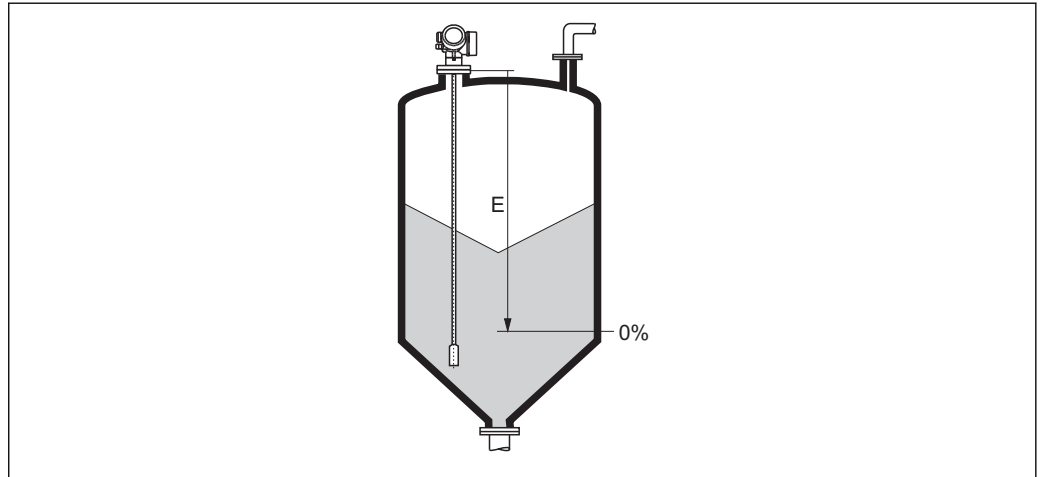
Additional information

A0013180

 47 *Empty calibration (E) for level measurements in bulk solids.*

Full calibration

**Navigation**

Setup → Full calibr.

Description

Distance between minimum level (0%) and maximum level (100%).

User entry

Depending on the probe

Factory setting

Depending on the probe

Additional information

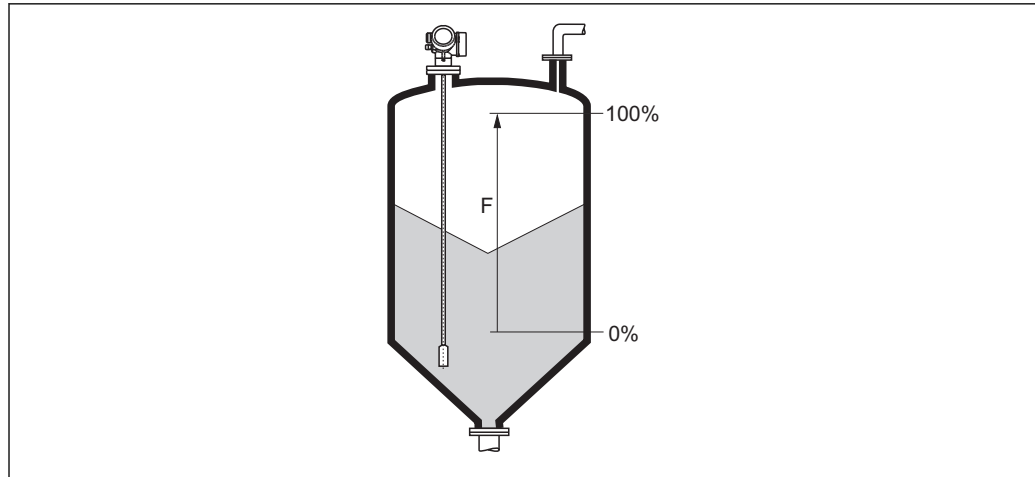

A0013191

48 Full calibration (F) for level measurements in bulk solids

Level

Navigation

Setup → Level

Description

Displays measured level L_L (before linearization).

Additional information

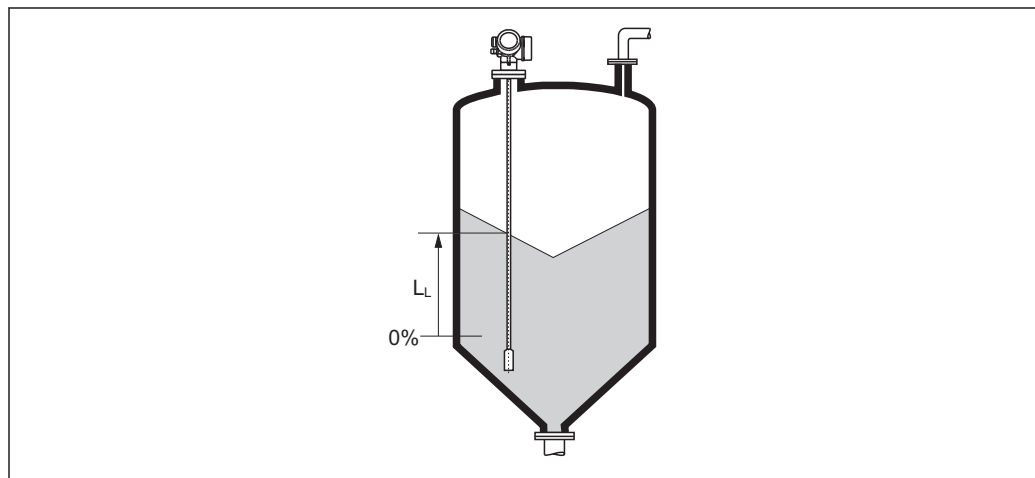

A0013196

49 Level in case of bulk solid measurements

i The unit is defined in the **Level unit** parameter (→ 143).

Distance

Navigation

Setup → Distance

Description

Displays the measured distance D_L between the reference point (lower edge of the flange or threaded connection) and the level.

Additional information

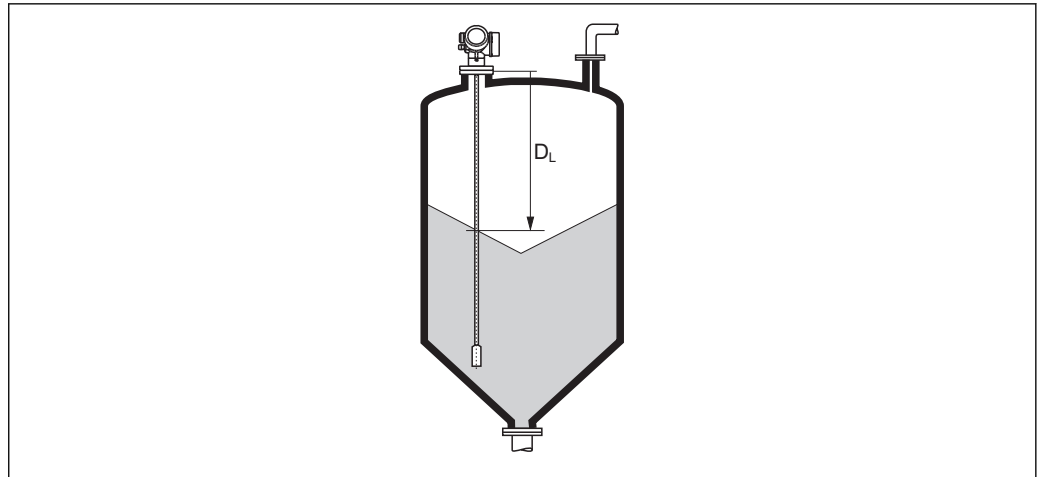

A0013201

50 Distance for bulk solid measurements

The unit is defined in the **Distance unit** parameter (→ 130).

Signal quality

Navigation

Setup → Signal quality

Description

Displays the signal quality of the evaluated echo.

Additional information

Meaning of the display options

- **Strong**
The evaluated echo exceeds the threshold by at least 10 mV.
- **Medium**
The evaluated echo exceeds the threshold by at least 5 mV.
- **Weak**
The evaluated echo exceeds the threshold by less than 5 mV.
- **No signal**
The device does not find a usable echo.

The signal quality indicated in this parameter always refers to the currently evaluated echo: either the level/interface echo³⁾ or the end-of-probe echo. To differentiate between these two, the quality of the end-of-probe echo is always displayed in brackets.

In case of a lost echo (**Signal quality = No signal**) the device generates the following error message:

- F941, for **Output echo lost** (→ 156) = Alarm.
- S941, if another option has been selected in **Output echo lost** (→ 156).

3) Of these two echos the one with the lower quality is indicated.

Confirm distance
**Navigation**

Setup → Confirm distance

Description

Specify, whether the measured distance matches the real distance.
Depending on the selection the device automatically sets the range of mapping.

Selection

- Manual map
- Distance ok
- Distance unknown
- Distance too small^{*}
- Distance too big^{*}
- Tank empty
- Delete map

Factory setting

Distance unknown

Additional information**Meaning of the options**

- **Manual map**
To be selected if the range of mapping is to be defined manually in the **Mapping end point** parameter (→ 135). In this case it is not necessary to confirm the distance.
 - **Distance ok**
To be selected if the measured distance matches the actual distance. The device performs a mapping.
 - **Distance unknown**
To be selected if the actual distance is unknown. A mapping can not be performed in this case.
 - **Distance too small**
To be selected if the measured distance is smaller than the actual distance. The device searches for the next echo and returns to the **Confirm distance** parameter. The distance is recalculated and displayed. The comparison must be repeated until the displayed distance matches the actual distance. After this, the recording of the map can be started by selecting **Distance ok**.
 - **Distance too big⁴⁾**
To be selected if the measured distance exceeds the actual distance. The device adjusts the signal evaluation and returns to the **Confirm distance** parameter. The distance is recalculated and displayed. The comparison must be repeated until the displayed distance matches the actual distance. After this, the recording of the map can be started by selecting **Distance ok**.
 - **Tank empty**
To be selected if the tank is completely empty. The device records a mapping covering the complete measuring range.
To be selected if the tank is completely empty. The device records a mapping covering the complete measuring range minus **Map gap to LN**.
 - **Factory map**
To be selected if the present mapping curve (if one exists) is to be deleted. The device returns to the **Confirm distance** parameter and a new mapping can be recorded.
- When operating via the display module, the measured distance is displayed together with this parameter for reference purposes.
- If the teaching procedure with the **Distance too small** option or the **Distance too big** option is quit before the distance has been confirmed, a map is **not** recorded and the teaching procedure is reset after 60 s.





* Visibility depends on order options or device settings

4) Only available for "Expert → Sensor → Echo tracking → **Evaluation mode** parameter" = "Short time history" or "Long time history"



Present mapping

Navigation	 Setup → Present mapping
Description	Indicates up to which distance a mapping has already been recorded.

Mapping end point

Navigation	 Setup → Map. end point
Prerequisite	Confirm distance (→  134) = Manual map or Distance too small
Description	Specify new end of the mapping.
User entry	0 to 200 000.0 m
Factory setting	0.1 m
Additional information	<p>This parameter defines up to which distance the new mapping is to be recorded. The distance is measured from the reference point, i.e. from the lower edge of the mounting flange or the threaded connection.</p> <p> For reference purposes the Present mapping parameter (→  135) is displayed together with this parameter. It indicates up to which distance a mapping has already been recorded.</p>

Record map

Navigation	 Setup → Record map
Prerequisite	Confirm distance (→  134) = Manual map or Distance too small
Description	Start recording of the map.
Selection	<ul style="list-style-type: none"> ■ No ■ Record map ■ Delete map
Factory setting	No

Additional information**Meaning of the options****■ No**

The map is not recorded.



■ Record map

The map is recorded. After the recording is completed, the new measured distance and the new mapping range appear on the display. When operating via the local display, these values must be confirmed by pressing .

■ Delete map

The mapping (if one exists) is deleted and the device displays the recalculated measured distance and the mapping range. When operating via the local display, these values must be confirmed by pressing .

17.4.1 "Mapping" wizard

-  The **Mapping** wizard is only available when operating via the local display. When operating via an operating tool, all parameters concerning the mapping are located directly in the **Setup** menu (→  130).
-  In the **Mapping** wizard two parameters are displayed simultaneously on the display module at any one time. The upper parameter can be edited, whereas the lower parameter is displayed for reference purposes only.

Navigation  Setup → Mapping

Confirm distance

Navigation  Setup → Mapping → Confirm distance

Description →  134

Mapping end point

Navigation  Setup → Mapping → Map. end point

Description →  135

Record map

Navigation  Setup → Mapping → Record map

Description →  135

Distance





Navigation  Setup → Mapping → Distance

Description →  132





17.4.2 "Advanced setup" submenu

Navigation  Setup → Advanced setup





Locking status

Navigation	  Setup → Advanced setup → Locking status
Description	Indicates the write protection with the highest priority that is currently active.
User interface	<ul style="list-style-type: none"> ■ Hardware locked ■ SIL locked ■ CT active - defined parameters ■ WHG locked ■ Temporarily locked
Additional information	<p>Meaning and priorities of the types of write protection</p> <ul style="list-style-type: none"> ■ Hardware locked (priority 1) The DIP switch for hardware locking is activated on the main electronics module. This locks write access to the parameters. ■ SIL locked (priority 2) The SIL mode is activated. Writing access to the relevant parameters is denied. ■ WHG locked (priority 3) The WHG mode is activated. Writing access to the relevant parameters is denied. ■ Temporarily locked (priority 4) Write access to the parameters is temporarily locked on account of internal processes in progress in the device (e.g. data upload/download, reset etc.). The parameters can be modified as soon as the processes are complete. <p> On the display module, the -symbol appears in front of parameters that cannot be modified since they are write-protected.</p>





Access status tooling

Navigation	 Setup → Advanced setup → Access stat.tool
Description	Shows the access authorization to the parameters via the operating tool.
Additional information	<p> The access authorization can be changed via the Enter access code parameter (→  139).</p> <p> If additional write protection is active, this restricts the current access authorization even further. The write protection status can be viewed via the Locking status parameter (→  138).</p>

Access status display

Navigation	 Setup → Advanced setup → Access stat.disp
Prerequisite	The device has a local display.
Description	Indicates access authorization to parameters via local display.
Additional information	<p> The access authorization can be changed via the Enter access code parameter (→  139).</p> <p> If additional write protection is active, this restricts the current access authorization even further. The write protection status can be viewed via the Locking status parameter (→  138).</p>

Enter access code

Navigation	 Setup → Advanced setup → Ent. access code
Description	Enter access code to disable write protection of parameters.
User entry	0 to 9999
Additional information	<ul style="list-style-type: none"> ▪ For local operation, the customer-specific access code, which has been defined in the Define access code parameter (→  183), has to be entered. ▪ If an incorrect access code is entered, the user retains his current access authorization. ▪ The write protection affects all parameters marked with the -symbol in this document. On the local display, the -symbol in front of a parameter indicates that the parameter is write-protected. ▪ If no key is pressed for 10 min, or the user switches from the navigation and editing mode back to the measured value display mode, the device automatically locks the write-protected parameters after another 60 s. <p> Please contact your Endress+Hauser Sales Center if you lose your access code.</p>

"Level" submenu

Navigation  Setup → Advanced setup → Level

Medium type **Navigation**

 Setup → Advanced setup → Level → Medium type

Description

Specify type of medium.

User interface

- Liquid
- Solid

Factory setting

FMP56, FMP57: **Solid**

Additional information

 This parameter determines the value of several other parameters and strongly influences the complete signal evaluation. Therefore, it is strongly recommended **not to change** the factory setting.

Medium property **Navigation**

 Setup → Advanced setup → Level → Medium property

Prerequisite

EOP level evaluation ≠ Fix DC

Description

Specify relative dielectric constant ϵ_r of the medium.

Selection

- Unknown
- DC 1.4 ... 1.6
- DC 1.6 ... 1.9
- DC 1.9 ... 2.5
- DC 2.5 ... 4
- DC 4 ... 7
- DC 7 ... 15
- DC > 15

Factory setting

Dependent on **Medium type** (→  140) and **Medium group**.

Additional information

Dependency on "Medium type" and "Medium group"

Medium type (→ ⓘ 140)	Medium group	Medium property
Solid		Unknown
Liquid	Water based (DC >= 4)	DC 4 ... 7
	Others	Unknown

-  For dielectric constants (DC values) of many media commonly used in various industries refer to:
 - the Endress+Hauser DC manual (CP01076F)
 - the Endress+Hauser "DC Values App" (available for Android and iOS)

-  For **EOP level evaluation = Fix DC**, the exact dielectric constant has to be entered into the **DC value** parameter. Therefore, the **Medium property** parameter is not available in this case.

Process property



Navigation

  Setup → Advanced setup → Level → Process property

Description

Specify typical rate of level change.

Selection

For "Medium type" = "Liquid"

- Very fast > 10 m (400 in)/min
- Fast > 1 m (40 in)/min
- Standard < 1 m (40in) /min
- Medium < 10 cm (4in) /min
- Slow < 1 cm (0.4in) /min
- No filter / test

For "Medium type" = "Solid"

- Very fast > 100 m (333 ft) /h
- Fast > 10 m (33 ft) /h
- Standard < 10 m (33 ft) /h
- Medium < 1 m (3ft) /h
- Slow < 0.1 m (0.3ft) /h
- No filter / test

Factory setting

Standard < 1 m (40in) /min

Additional information

The device adjusts the signal evaluation filters and the damping of the output signal to the typical rate of level change defined in this parameter:

For "Operating mode" = "Level" and "Medium type" = "Liquid"

Process property	Step response time / s
Very fast > 10 m (400 in)/min	5
Fast > 1 m (40 in)/min	5
Standard < 1 m (40in) /min	14
Medium < 10 cm (4in) /min	39
Slow < 1 cm (0.4in) /min	76
No filter / test	< 1

For "Operating mode" = "Level" and "Medium type" = "Solid"

Process property	Step response time / s
Very fast > 100 m (333 ft) /h	37
Fast > 10 m (33 ft) /h	37
Standard < 10 m (33 ft) /h	74
Medium < 1 m (3ft) /h	146
Slow < 0.1 m (0.3ft) /h	290
No filter / test	< 1

For "Operating mode" = "Interface" or "Interface with capacitance"

Process property	Step response time / s
Very fast > 10 m (400 in)/min	5
Fast > 1 m (40 in)/min	5
Standard < 1 m (40in) /min	23
Medium < 10 cm (4in) /min	47
Slow < 1 cm (0.4in) /min	81
No filter / test	2.2

Advanced process conditions



Navigation

Setup → Advanced setup → Level → Adv. conditions

Description

Specify additional process conditions (if required).

Selection

- None
- Oil/Water condensate
- Probe near tank bottom
- Build up
- Foam (>5cm/0,16ft)





Factory setting





None

Additional information

Meaning of the options

- **Oil/Water condensate** (only **Medium type = Liquid**)
Makes sure that in the case of two-phase media only the total level is detected (example: oil/condensate application).
- **Probe near tank bottom** (only for **Medium type = Liquid**)
Improves the empty detection, especially if the probe is mounted close to the tank bottom.
- **Build up**
Increases **EOP range upper area** in order to ensure a safe empty-detection even if the end-of-probe signal has shifted due to build-up.
Enables a safe empty-detection even if the end-of-probe signal has shifted due to build-up.
- **Foam (>5cm/0,16ft)** (only for **Medium type = Liquid**)
Optimizes the signal evaluation in applications with foam formation.

Level unit									
Navigation	 Setup → Advanced setup → Level → Level unit								
Description	Select level unit.								
Selection	<table border="0"> <thead> <tr> <th><i>SI units</i></th> <th><i>US units</i></th> </tr> </thead> <tbody> <tr> <td>▪ %</td> <td>▪ ft</td> </tr> <tr> <td>▪ m</td> <td>▪ in</td> </tr> <tr> <td>▪ mm</td> <td></td> </tr> </tbody> </table>	<i>SI units</i>	<i>US units</i>	▪ %	▪ ft	▪ m	▪ in	▪ mm	
<i>SI units</i>	<i>US units</i>								
▪ %	▪ ft								
▪ m	▪ in								
▪ mm									
Factory setting	%								
Additional information	<p>The level unit may differ from the distance unit defined in the Distance unit parameter (→  130):</p> <ul style="list-style-type: none"> ▪ The unit defined in the Distance unit parameter is used for the basic calibration (Empty calibration (→  131) and Full calibration (→  131)). ▪ The unit defined in the Level unit parameter is used to display the (nonlinearized) level. 								
Blocking distance									

Navigation	 Setup → Advanced setup → Level → Blocking dist.
Description	Specify upper blocking distance UB.
User entry	0 to 200 m
Factory setting	<ul style="list-style-type: none"> ▪ For rod and rope probes up to 8 m (26 ft): 200 mm (8 in) ▪ For rod and rope probes above 8 m (26 ft): 0.025 * Sondenlänge
Additional information	<p>Signals in the upper blocking distance are only evaluated if they have been outside the blocking distance when the device was switched on and move into the blocking distance due to a level change during operation. Signals which are already in the blocking distance when the device is switched on, are ignored.</p> <p> This behavior is only valid if the following two conditions are met:</p> <ul style="list-style-type: none"> ▪ Expert → Sensor → Echo tracking → Evaluation mode = Short time history or Long time history) ▪ Expert → Sensor → Gas phase compensation → GPC mode= On, Without correction or External correction <p>If one of these conditions is not met, signals in the blocking distance will always be ignored.</p> <p> A different behavior for signals in the blocking distance can be defined in the Blocking distance evaluation mode parameter.</p> <p> If required, a different behavior for signals in the blocking distance can be defined by the Endress+Hauser service.</p>

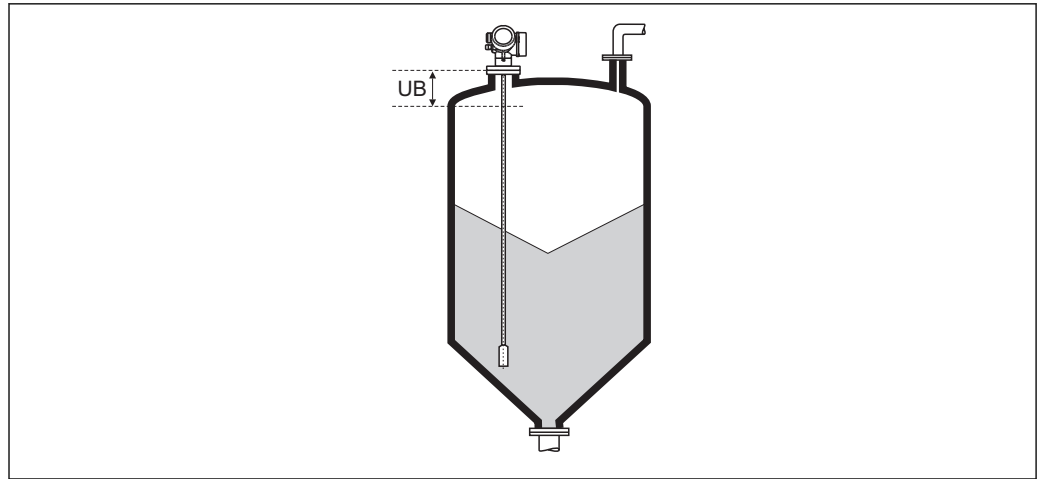

A0013221

51 Blocking distance (UB) for bulk solid measurements

Level correction



Navigation	Setup → Advanced setup → Level → Level correction
Description	Specify level correction (if required).
User entry	-200 000.0 to 200 000.0 %
Factory setting	0.0 %
Additional information	The value specified in this parameter is added to the measured level (before linearization).

"Linearization" submenu

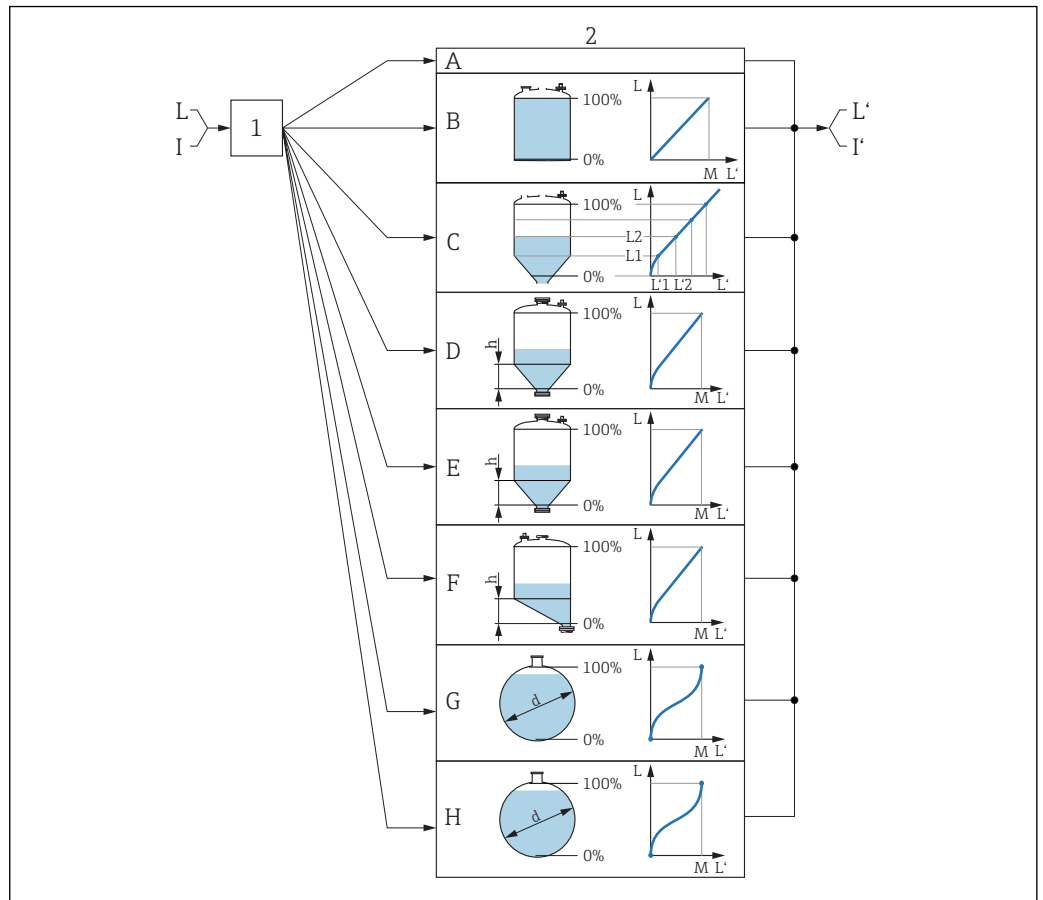











52 Linearization: Conversion of the level and, if applicable, interface into a volume or a weight; the conversion depends on the vessel shape

- 1 Selection of linearization type and unit
- 2 Configuration of the linearization
- A Linearization type (→ 148) = None
- B Linearization type (→ 148) = Linear
- C Linearization type (→ 148) = Table
- D Linearization type (→ 148) = Pyramid bottom
- E Linearization type (→ 148) = Conical bottom
- F Linearization type (→ 148) = Angled bottom
- G Linearization type (→ 148) = Horizontal cylinder
- H Linearization type (→ 148) = Sphere
- I For "Operating mode" = "Interface" or "Interface with capacitance": Interface before linearization (measured in level unit)
- I' For "Operating mode" = "Interface" or "Interface with capacitance": Interface after linearization (corresponds to volume or weight)
- L Level before linearization (measured in level unit)
- L' Level linearized (→ 151) (corresponds to volume or weight)
- M Maximum value (→ 151)
- d Diameter (→ 151)
- h Intermediate height (→ 152)













Structure of the submenu on the local display

Navigation  Setup → Advanced setup → Linearization

► Linearization		
Linearization type		→  148
Unit after linearization		→  149
Free text		→  150
Maximum value		→  151
Diameter		→  151
Intermediate height		→  152
Table mode		→  152
► Edit table		
	Level	→  154
	Customer value	→  154
	Activate table	→  154

Structure of the submenu in the operating tool (e.g. FieldCare)

Navigation  Setup → Advanced setup → Linearization

► Linearization	
Linearization type	→  148
Unit after linearization	→  149
Free text	→  150
Level linearized	→  151
Maximum value	→  151
Diameter	→  151
Intermediate height	→  152
Table mode	→  152
Table number	→  153
Level	→  154
Level	→  154
Customer value	→  154
Activate table	→  154

Description of the parameters

Navigation  Setup → Advanced setup → Linearization

Linearization type 

Navigation  Setup → Advanced setup → Linearization → Lineariz. type

Description Select linearization type.

- Selection**
- None
 - Linear
 - Table
 - Pyramid bottom
 - Conical bottom
 - Angled bottom
 - Horizontal cylinder
 - Sphere

Factory setting None

Additional information

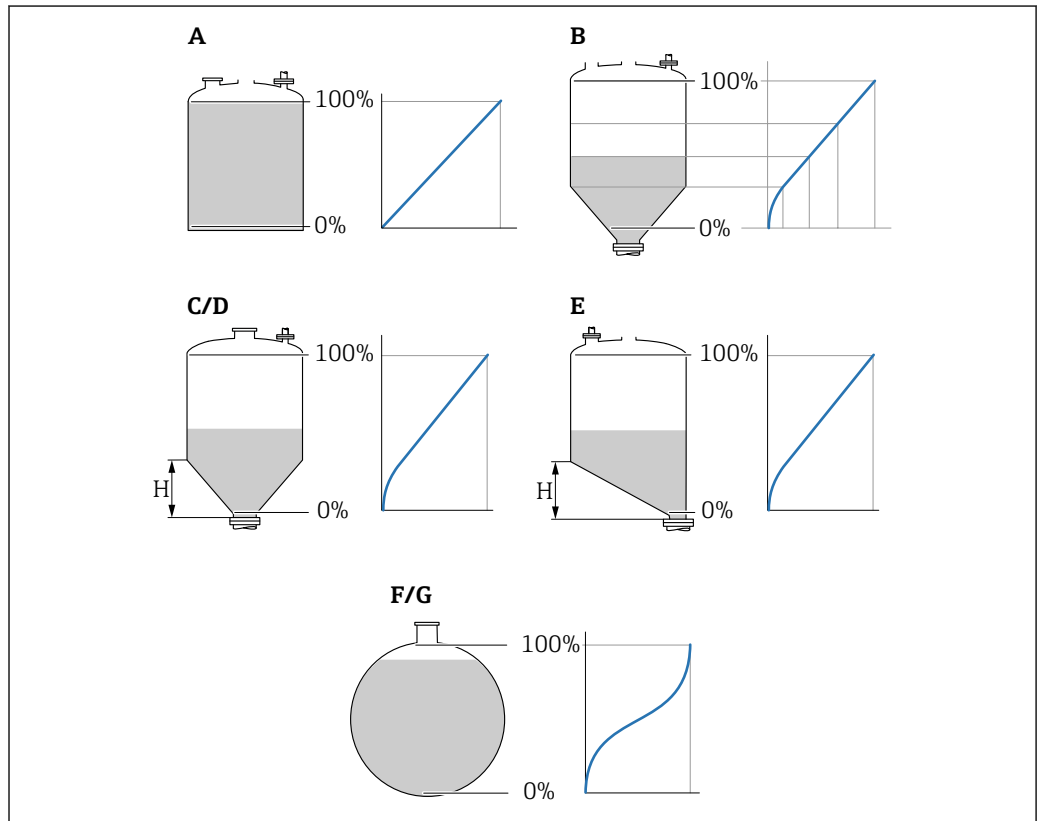

A0021476

 53 Linearization types

- A None
- B Table
- C Pyramid bottom
- D Conical bottom
- E Angled bottom
- F Sphere
- G Horizontal cylinder

Meaning of the options

- **None**

The level is output in the level unit without being converted (linearized) beforehand.

- **Linear**

The output value (volume/weight) is proportional to the level L. This applies, for example, to vertical cylindrical tanks and silos. The following parameters must also be specified:

- **Unit after linearization** (→  149)

- **Maximum value** (→  151): Maximum volume or weight

- **Table**

The relationship between the measured level L and the output value (volume/weight) is defined by a linearization table consisting of up to 32 pairs of values "level - volume" or "level - weight" respectively. The following parameters must also be defined:

- **Unit after linearization** (→  149)

- **Table mode** (→  152)

- For each table point: **Level** (→  154)

- For each table point: **Customer value** (→  154)

- **Activate table** (→  154)

- **Pyramid bottom**

The output value corresponds to the volume or weight in a silo with a pyramid bottom. The following parameters must also be defined:

- **Unit after linearization** (→  149)

- **Maximum value** (→  151): Maximum volume or weight

- **Intermediate height** (→  152): The height of the pyramid

- **Conical bottom**

The output value corresponds to the volume or weight in a tank with a conical bottom. The following parameters must also be defined:

- **Unit after linearization** (→  149)

- **Maximum value** (→  151): Maximum volume or weight

- **Intermediate height** (→  152): The height of the conical part

- **Angled bottom**

The output value corresponds to the volume or weight in a silo with an angled bottom. The following parameters must also be defined:

- **Unit after linearization** (→  149)

- **Maximum value** (→  151): Maximum volume or weight

- **Intermediate height** (→  152): The height of the angled bottom

- **Horizontal cylinder**

The output value corresponds to the volume or weight in a horizontal cylinder. The following parameters must also be defined:

- **Unit after linearization** (→  149)

- **Maximum value** (→  151): Maximum volume or weight

- **Diameter** (→  151)

- **Sphere**



The output value corresponds to the volume or weight in a spherical tank. The following parameters must also be defined:

- **Unit after linearization** (→  149)

- **Maximum value** (→  151): Maximum volume or weight







- **Diameter** (→  151)

Unit after linearization
**Navigation**

  Setup → Advanced setup → Linearization → Unit lineariz.



Prerequisite

Linearization type (→  148) ≠ None



Description	Select the unit for the linearized value.
Selection	<p>Selection/input (uint16)</p> <ul style="list-style-type: none"> ▪ 1095 = [short Ton] ▪ 1094 = [lb] ▪ 1088 = [kg] ▪ 1092 = [Ton] ▪ 1048 = [US Gal.] ▪ 1049 = [Imp. Gal.] ▪ 1043 = [ft³] ▪ 1571 = [cm³] ▪ 1035 = [dm³] ▪ 1034 = [m³] ▪ 1038 = [l] ▪ 1041 = [hl] ▪ 1342 = [%] ▪ 1010 = [m] ▪ 1012 = [mm] ▪ 1018 = [ft] ▪ 1019 = [inch] ▪ 1351 = [l/s] ▪ 1352 = [l/min] ▪ 1353 = [l/h] ▪ 1347 = [m³/s] ▪ 1348 = [m³/min] ▪ 1349 = [m³/h] ▪ 1356 = [ft³/s] ▪ 1357 = [ft³/min] ▪ 1358 = [ft³/h] ▪ 1362 = [US Gal./s] ▪ 1363 = [US Gal./min] ▪ 1364 = [US Gal./h] ▪ 1367 = [Imp. Gal./s] ▪ 1358 = [Imp. Gal./min] ▪ 1359 = [Imp. Gal./h] ▪ 32815 = [Ml/s] ▪ 32816 = [Ml/min] ▪ 32817 = [Ml/h] ▪ 1355 = [Ml/d]
Factory setting	%
Additional information	<p>The selected unit is only used for display purposes. The measured value is not converted on the basis of the selected unit.</p> <p> Distance-to-distance linearization is also possible, i.e. a linearization from the level unit to another length unit. Select the Linear linearization mode for this purpose. To specify the new level unit, select the Free text option in the Unit after linearization parameter and enter the unit in the Free text parameter (→  150).</p>
Free text	
Navigation	  Setup → Advanced setup → Linearization → Free text
Prerequisite	Unit after linearization (→  149) = Free text

Description	Enter unit symbol.
User entry	Up to 32 alphanumeric characters (letters, numbers, special characters)
Factory setting	Free text



Level linearized

Navigation	 Setup → Advanced setup → Linearization → Level linearized
Description	Displays linearized level.
Additional information	 The unit is defined by the Unit after linearization parameter →  149.

Maximum value

Navigation	  Setup → Advanced setup → Linearization → Maximum value
Prerequisite	Linearization type (→  148) has one of the following values: <ul style="list-style-type: none"> ▪ Linear ▪ Pyramid bottom ▪ Conical bottom ▪ Angled bottom ▪ Horizontal cylinder ▪ Sphere
Description	Linearized value corresponding to a level of 100%.
User entry	-50 000.0 to 50 000.0 %
Factory setting	100.0 %

Diameter

Navigation	  Setup → Advanced setup → Linearization → Diameter
Prerequisite	Linearization type (→  148) has one of the following values: <ul style="list-style-type: none"> ▪ Horizontal cylinder ▪ Sphere
Description	Diameter of the cylindrical or spherical tank.
User entry	0 to 9 999.999 m
Factory setting	2 m

Additional information The unit is defined in the **Distance unit** parameter (→  130).

Intermediate height 

Navigation   Setup → Advanced setup → Linearization → Intermed. height

Prerequisite **Linearization type** (→  148) has one of the following values:

- Pyramid bottom
- Conical bottom
- Angled bottom

Description Height of the pyramid, conical or angled bottom.

User entry 0 to 200 m

Factory setting 0 m

Additional information

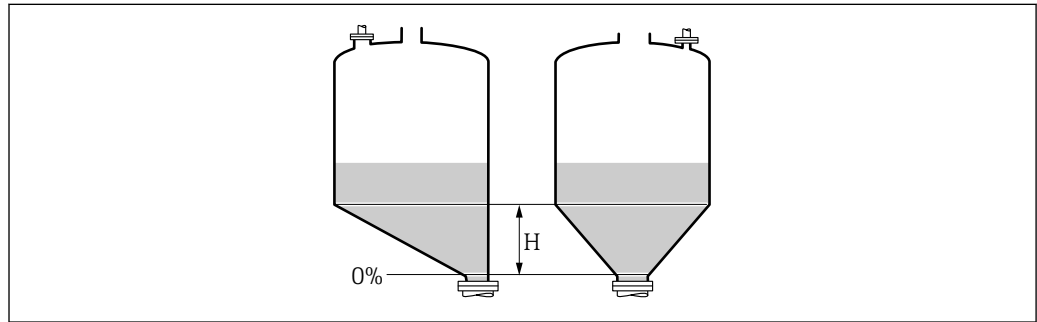

A0013264

H Intermediate height





The unit is defined in the **Distance unit** parameter (→  130).

Table mode 

Navigation   Setup → Advanced setup → Linearization → Table mode

Prerequisite **Linearization type** (→  148) = Table

Description Select editing mode of the linearization table.

Selection

- Manual
- Semiautomatic
- Clear table
- Sort table

Factory setting Manual

Additional information**Meaning of the options**

- **Manual**

The level and the associated linearized value are entered manually for each linearization point.

- **Semiautomatic**

The level is measured by the device for each linearization point. The associated linearized value is entered manually.

- **Clear table**



Deletes the existing linearization table.

- **Sort table**

Rearranges the linearization points into an ascending order.

Conditions the linearization table must meet:



- The table may consist of up to 32 pairs of values "Level - Linearized Value".
- The table must be monotonic (monotonically increasing or decreasing).
- The first linearization point must refer to the minimum level.
- The last linearization point must refer to the maximum level.

 Before entering a linearization table, the values for **Empty calibration** (→  131) and **Full calibration** (→  131) must be set correctly.

If values of the table need to be changed after the full or empty calibration have been changed, a correct evaluation is only ensured if the existing table is deleted and the complete table is entered again. To do so delete the existing table (**Table mode** (→  152) = **Clear table**). Then enter a new table.



How to enter the table

- Via FieldCare

The table points can be entered via the **Table number** (→  153), **Level** (→  154) and **Customer value** (→  154) parameters. As an alternative, the graphic table editor may be used: Device Operation → Device Functions → Additional Functions → Linearization (Online/Offline)

- Via local display

Select the **Edit table** submenu to call up the graphic table editor. The table is displayed and can be edited line by line.

 The factory setting for the level unit is "%". If you want to enter the linearization table in physical units, you must select the appropriate unit in the **Level unit** parameter (→  143) beforehand.



 If a decreasing table is entered, the values for 20 mA and 4 mA of the current output are interchanged. That means: 20 mA refers to the lowest level, whereas 4 mA refers to the highest level.

Table number**Navigation**

 Setup → Advanced setup → Linearization → Table number

Prerequisite

Linearization type (→  148) = **Table**

Description

Select table point you are going to enter or change.

User entry

1 to 32

Factory setting

1

Level (Manual)



Navigation	Setup → Advanced setup → Linearization → Level
Prerequisite	<ul style="list-style-type: none"> ▪ Linearization type (→ 148) = Table ▪ Table mode (→ 152) = Manual
Description	Enter level value of the table point (value before linearization).
User entry	Signed floating-point number
Factory setting	0 %

Level (Semiautomatic)

Navigation	Setup → Advanced setup → Linearization → Level
Prerequisite	<ul style="list-style-type: none"> ▪ Linearization type (→ 148) = Table ▪ Table mode (→ 152) = Semiautomatic
Description	Displays measured level (value before linearization). This value is transmitted to the table.

Customer value



Navigation	Setup → Advanced setup → Linearization → Customer value
Prerequisite	Linearization type (→ 148) = Table
Description	Enter linearized value for the table point.
User entry	Signed floating-point number
Factory setting	0 %

Activate table



Navigation	Setup → Advanced setup → Linearization → Activate table
Prerequisite	Linearization type (→ 148) = Table
Description	Activate (enable) or deactivate (disable) the linearization table.
Selection	<ul style="list-style-type: none"> ▪ Disable ▪ Enable

Factory setting Disable

Additional information

Meaning of the options

▪ **Disable**

The measured level is not linearized.

If **Linearization type** (→  **148**) = **Table** at the same time, the device issues error message F435.

▪ **Enable**

The measured level is linearized according to the table.







When editing the table, the **Activate table** parameter is automatically reset to **Disable** and must be reset to **Enable** after the table has been entered.





"Safety settings" submenu

Navigation  Setup → Advanced setup → Safety sett.

Output echo lost 

Navigation	 Setup → Advanced setup → Safety sett. → Output echo lost
Description	Output signal in case of a lost echo.
Selection	<ul style="list-style-type: none"> ▪ Last valid value ▪ Ramp at echo lost ▪ Value echo lost ▪ Alarm
Factory setting	Last valid value
Additional information	<p>Meaning of the options</p> <ul style="list-style-type: none"> ▪ Last valid value The last valid value is kept in the case of a lost echo. ▪ Ramp at echo lost⁵⁾ In the case of a lost echo the output value is continuously shifted towards 0% or 100%. The slope of the ramp is defined in the Ramp at echo lost parameter (→  157). ▪ Value echo lost⁵⁾ In the case of a lost echo the output assumes the value defined in the Value echo lost parameter (→  156). ▪ Alarm In the case of a lost echo the device generates an alarm; see the Failure mode parameter (→  166)

Value echo lost 

Navigation	 Setup → Advanced setup → Safety sett. → Value echo lost
Prerequisite	Output echo lost (→  156) = Value echo lost
Description	Output value in case of a lost echo
User entry	0 to 200 000.0 %
Factory setting	0.0 %
Additional information	<p>Use the unit which has been defined for the measured value output:</p> <ul style="list-style-type: none"> ▪ without linearization: Level unit (→  143) ▪ with linearization: Unit after linearization (→  149)

5) Only visible if "Linearization type (→  148)" = "None"

Ramp at echo lost



Navigation Setup → Advanced setup → Safety sett. → Ramp echo lost

Prerequisite **Output echo lost (→ 156) = Ramp at echo lost**

Description Slope of the ramp in the case of a lost echo

User entry Signed floating-point number

Factory setting 0.0 %/min

Additional information

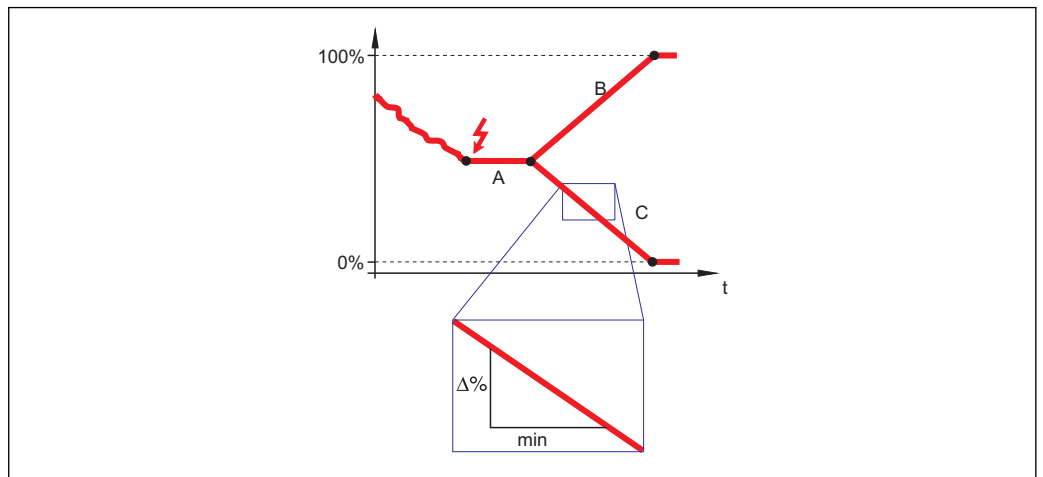

A0013269

- A Delay time echo lost
- B Ramp at echo lost (→ 157) (positive value)
- C Ramp at echo lost (→ 157) (negative value)

- The unit for the slope of the ramp is "percentage of the measuring range per minute" (%/min).
- For a negative slope of the ramp: The measured value is continuously decreased until it reaches 0%.
- For a positive slope of the ramp: The measured value is continuously increased until it reaches 100%.

Blocking distance



Navigation Setup → Advanced setup → Safety sett. → Blocking dist.

Description Specify upper blocking distance UB.

User entry 0 to 200 m

- Factory setting**
- For rod and rope probes up to 8 m (26 ft): 200 mm (8 in)
 - For rod and rope probes above 8 m (26 ft): 0.025 * Sondenlänge

Additional information Signals in the upper blocking distance are only evaluated if they have been outside the blocking distance when the device was switched on and move into the blocking distance

due to a level change during operation. Signals which are already in the blocking distance when the device is switched on, are ignored.

- This behavior is only valid if the following two conditions are met:
 - Expert → Sensor → Echo tracking → Evaluation mode = **Short time history** or **Long time history**)
 - Expert → Sensor → Gas phase compensation → GPC mode= **On, Without correction** or **External correction**

If one of these conditions is not met, signals in the blocking distance will always be ignored.

- A different behavior for signals in the blocking distance can be defined in the **Blocking distance evaluation mode** parameter.

- If required, a different behavior for signals in the blocking distance can be defined by the Endress+Hauser service.

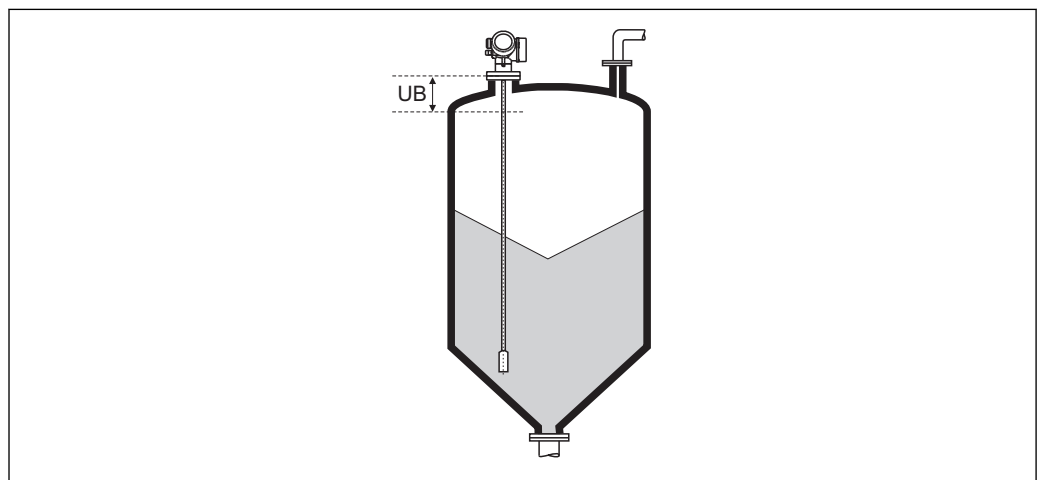

A0013221

54 Blocking distance (UB) for bulk solid measurements



"SIL/WHG confirmation" wizard

 The **SIL/WHG confirmation** wizard is only available for devices with SIL or WHG approval (Feature 590: "Additional Approval", option LA: "SIL" or LC: "WHG overflow prevention") which are currently **not** in the SIL- or WHG-locked state.

The **SIL/WHG confirmation** wizard is required to lock the device according to SIL or WHG. For details refer to the "Functional Safety Manual" of the respective device, which describes the locking procedure and the parameters of the sequence.

Navigation  Setup → Advanced setup → SIL/WHG confirm.

"Deactivate SIL/WHG" wizard

 The **Deactivate SIL/WHG** wizard (→  160) is only visible if the device is SIL-locked or WHG-locked. For details refer to the "Functional Safety Manual" of the respective device.

Navigation  Setup → Advanced setup → Deactiv. SIL/WHG

Reset write protection 







Navigation	 Setup → Advanced setup → Deactiv. SIL/WHG → Res. write prot.
Description	Enter unlocking code.
User entry	0 to 65 535
Factory setting	0



Code incorrect 



Navigation	 Setup → Advanced setup → Deactiv. SIL/WHG → Code incorrect
Description	Indicates that a wrong unlocking code has been entered. Select procedure.
Selection	<ul style="list-style-type: none"> ■ Reenter code ■ Abort sequence
Factory setting	Reenter code



"Probe settings" submenu

The **Probe settings** submenu helps to ensure that the end of probe signal within the envelope curve is correctly assigned by the evaluation algorithm. The assignment is correct if the length of probe indicated by the device matches the actual length of the probe. The automatic probe length correction can only be performed if the probe is installed in the vessel and is completely uncovered (no medium). For partially filled vessels and if the probe length is known, select **Confirm probe length** (→  162) = **Manual input** in order to enter the value manually.

-  If a mapping (interference echo suppression) has been recorded after shortening the probe, it is no longer possible to perform an automatic probe length correction. In this case there are two options:
 - Delete the map using the **Record map** parameter (→  135) before performing the automatic probe length correction. After the probe length correction, a new map can be recorded using the **Record map** parameter (→  135).
 - Alternative: Select **Confirm probe length** (→  162) = **Manual input** and enter the probe length manually into the **Present probe length** parameter →  161.
-  An automatic probe length correction is only possible after the correct option has been selected in the **Probe grounded** parameter (→  161).

Navigation   Setup → Advanced setup → Probe settings

Probe grounded	
<hr/>	
Navigation	  Setup → Advanced setup → Probe settings → Probe grounded
Prerequisite	Operating mode = Level
Description	Specify whether the probe is grounded.
Selection	<ul style="list-style-type: none"> ▪ No ▪ Yes
Factory setting	No

Present probe length	
<hr/>	
Navigation	 Setup → Advanced setup → Probe settings → Pres. length
Description	<ul style="list-style-type: none"> ▪ In most cases: Displays the length of the probe according to the currently measured end-of-probe signal. ▪ For Confirm probe length (→  162) = Manual input: Enter actual length of probe.
User entry	0 to 200 m
Factory setting	4 m

Confirm probe length
**Navigation**

Setup → Advanced setup → Probe settings → Confirm length

Description

Select, whether the value displayed in the **Present probe length** parameter → 161 matches the actual length of the probe. Based on this input, the device performs a probe length correction.

Selection

- Probe length OK
- Probe length too small
- Probe length too big
- Probe covered
- Manual input
- Probe length unknown

Factory setting



Probe length OK

Additional information**Meaning of the options**

- **Probe length OK**
To be selected if the indicated length is correct. An adjustment is not required. The device quits the sequence.
- **Probe length too small**
To be selected if the displayed length is smaller than the actual length of the probe. A different end of probe signal is allocated and the newly calculated length is displayed in the **Present probe length** parameter → 161. This procedure has to be repeated until the displayed value matches the actual length of the probe.
- **Probe length too big**
To be selected if the displayed length is bigger than the actual length of the probe. A different end of probe signal is allocated and the newly calculated length is indicated in the **Present probe length** parameter → 161. This procedure has to be repeated until the displayed value matches the actual length of the probe.
- **Probe covered**
To be selected if the probe is (partially or completely) covered. A probe length correction is impossible in this case. The device quits the sequence.
- **Manual input**
To be selected if no automatic probe length correction is to be performed. Instead, the actual length of the probe must be entered manually into the **Present probe length** parameter → 161 ⁶⁾.
- **Probe length unknown**
To be selected if the actual length of the probe is unknown. A probe length correction is impossible in this case and the device quits the sequence.

6) When operated via FieldCare, the **Manual input** option needs not to be selected explicitly. In FieldCare the length of the probe can always be edited.

"Probe length correction" wizard

 The **Probe length correction** wizard is only available when operating via the local display. When operating via an operating tool, all parameters concerning the probe length correction are located directly in the **Probe settings** submenu (→  161).

Navigation  Setup → Advanced setup → Probe settings → Prob.length corr

Confirm probe length

**Navigation**

 Setup → Advanced setup → Probe settings → Prob.length corr → Confirm length

Description

→  162

Present probe length



**Navigation**

 Setup → Advanced setup → Probe settings → Prob.length corr → Pres. length

Description

→  161

"Current output 1 to 2" submenu

 The **Current output 2** submenu (→  164) is only available for devices with two current outputs.

Navigation  Setup → Advanced setup → Curr.output 1 to 2

Assign current output 1 to 2 

Navigation

 Setup → Advanced setup → Curr.output 1 to 2 → Assign curr.

Description

Select process variable for current output.

Selection

- Level linearized
- Distance
- Electronic temperature
- Relative echo amplitude
- Analog output adv. diagnostics 1
- Analog output adv. diagnostics 2

Factory setting



For level measurements

- Current output 1: Level linearized
- Current output 2 ⁷⁾: Level linearized

Additional information

Definition of the current range for the process variables

Process variable	4 mA value	20 mA value
Level linearized	0 % ¹⁾ or the associated linearized value	100 % ²⁾ or the associated linearized value
Distance	0 (i.e. level is at the reference point)	Empty calibration (→  131) (i.e. level is at 0 %)
Electronic temperature	-50 °C (-58 °F)	100 °C (212 °F)
Relative echo amplitude	0 mV	2 000 mV
Analog output adv. diagnostics 1/2	depending on the parametrization of the Advanced Diagnostics	

- 1) the 0% level is defined by **Empty calibration** parameter (→  131)
 2) The 100% level is defined by **Full calibration** parameter (→  131)

 It may be necessary to adjust the 4mA and 20mA values to the application (especially in the case of the **Analog output adv. diagnostics 1/2** option).

This can be done by the following parameters:

- Expert → Output → Current output 1 to 2 → Turn down
- Expert → Output → Current output 1 to 2 → 4 mA value
- Expert → Output → Current output 1 to 2 → 20 mA value

7) only for devices with two current outputs

Current span



Navigation

Setup → Advanced setup → Curr.output 1 to 2 → Current span

Description

Determines the current range used to transmit the measured value. '4...20mA': Measured variable: 4 ...20 mA '4...20mA NAMUR': Measured variable: 3.8 ... 20.5 mA '4...20mA US': Measured variable: 3.9 ... 20.8 mA 'Fixed current': Measured variable transmitted via HART only Note: Currents below 3.6 mA or above 21.95 mA can be used to signal an alarm.

Selection

- 4...20 mA
- 4...20 mA NAMUR
- 4...20 mA US
- Fixed current

Factory setting

4...20 mA NAMUR

Additional information

Meaning of the options

Option	Current range for process variable	Lower alarm signal level	Upper alarm signal level
4...20 mA	4 to 20.5 mA	< 3.6 mA	> 21.95 mA
4...20 mA NAMUR	3.8 to 20.5 mA	< 3.6 mA	> 21.95 mA
4...20 mA US	3.9 to 20.8 mA	< 3.6 mA	> 21.95 mA
Fixed current	Constant current, defined in the Fixed current parameter (→ 165).		

- In the case of an error, the output current assumes the value defined in the **Failure mode** parameter (→ 166).
- If the measured value is out of the measuring range, **Current output** diagnostic message is issued.
- In a HART multidrop loop only one device can use the analog current to transmit a signal. For all other devices one must set:
 - **Current span = Fixed current**
 - **Fixed current (→ 165) = 4 mA**

Fixed current



Navigation

Setup → Advanced setup → Curr.output 1 to 2 → Fixed current

Prerequisite

Current span (→ 165) = Fixed current

Description

Define constant value of the output current.

User entry

4 to 22.5 mA

Factory setting

4 mA

Damping output

Navigation	Setup → Advanced setup → Curr.output 1 to 2 → Damping out.
Description	Reaction time of the output signal on fluctuation in the measured value.
User entry	0.0 to 999.9 s
Factory setting	0.0 s
Additional information	Fluctuations of the measured value affect the output current with an exponential delay, the time constant τ of which is defined in this parameter. With a small time constant the output reacts immediately to changes of the measured value. With a big time constant the reaction of the output is more delayed. For $\tau = 0$ (factory setting) there is no damping.

Failure mode

Navigation	Setup → Advanced setup → Curr.output 1 to 2 → Failure mode
Prerequisite	Current span (→ 165) ≠ Fixed current
Description	Defines which current the output assumes in the case of an error. 'Min.': < 3.6mA 'Max.': > 21.95mA 'Last valid value': Last valid value before occurrence of the error. 'Actual value': Output current is equal to the measured value; error is ignored. 'Defined value': User defined value.
Selection	<ul style="list-style-type: none"> ▪ Min. ▪ Max. ▪ Last valid value ▪ Actual value ▪ Defined value
Factory setting	Max.
Additional information	<p>Meaning of the options</p> <ul style="list-style-type: none"> ▪ Min. The current output adopts the value of the lower alarm level according to the Current span parameter (→ 165). ▪ Max. The current output adopts the value of the upper alarm level according to the Current span parameter (→ 165). ▪ Last valid value The current remains constant at the last value it had before the error occurred. ▪ Actual value The output current follows the actual measured value; the error is ignored. ▪ Defined value The output current assumes the value defined in the Failure current parameter (→ 167). <p> The error behavior of other output channels is not influenced by these settings but is defined in separate parameters.</p>

Failure current





Navigation	Setup → Advanced setup → Curr.output 1 to 2 → Failure current
Prerequisite	Failure mode (→ 166) = Defined value
Description	Defines which current the output assumes in case of an error.
User entry	3.59 to 22.5 mA
Factory setting	22.5 mA

Output current 1 to 2

Navigation	Setup → Advanced setup → Curr.output 1 to 2 → Output curr. 1 to 2
Description	Shows the actual calculated value of the output current.

"Switch output" submenu

 The **Switch output** submenu (→  168) is only visible for devices with switch output.⁸⁾

Navigation  Setup → Advanced setup → Switch output

Switch output function**Navigation**

 Setup → Advanced setup → Switch output → Switch out funct

Description

Defines the function of the switch output. 'Off' The switch output is always open (non-conductive) 'On' The switch output is always closed (conductive). 'Diagnostic behavior' The switch output is normally closed and is only opened if a diagnostic event is present. 'Limit' The switch output is normally closed and is only opened if a measured variable exceeds a defined limit. 'Digital output' The switch output is controlled by one of the digital output blocks of the device.





Selection

- Off
- On
- Diagnostic behavior
- Limit
- Digital Output

Factory setting

Off



Additional information**Meaning of the options**

- **Off**
The output is always open (non-conductive).
- **On**
The output is always closed (conductive).
- **Diagnostic behavior**
The output is normally closed and is only opened if a diagnostic event is present. The **Assign diagnostic behavior** parameter (→  169) determines for which type of event the output is opened.
- **Limit**
The output is normally closed and is only opened if a measured variable exceeds or falls below a defined limit. The limit values are defined by the following parameters:
 - **Assign limit** (→  169)
 - **Switch-on value** (→  170)
 - **Switch-off value** (→  171)
- **Digital Output**
The switching state of the output tracks the output value of a DI function block. The function block is selected in the **Assign status** parameter (→  169).



 The **Off** and **On** options can be used to simulate the switch output.

8) Ordering feature 020 "Power supply; Output", option B, E or G



Assign status

Navigation	  Setup → Advanced setup → Switch output → Assign status
Prerequisite	Switch output function (→  168) = Digital Output
Selection	<ul style="list-style-type: none"> ▪ Off ▪ Digital output AD 1 ▪ Digital output AD 2
Factory setting	Off
Additional information	The Digital output AD 1 and Digital output AD 2 options refer to the Advanced Diagnostic Blocks. A switch signal generated in these blocks can be transmitted via the switch output.

Assign limit

Navigation	  Setup → Advanced setup → Switch output → Assign limit
Prerequisite	Switch output function (→  168) = Limit
Selection	<ul style="list-style-type: none"> ▪ Off ▪ Level linearized ▪ Distance ▪ Interface linearized * ▪ Interface distance * ▪ Thickness upper layer * ▪ Terminal voltage ▪ Electronic temperature ▪ Measured capacitance * ▪ Relative echo amplitude ▪ Relative interface amplitude * ▪ Absolute echo amplitude ▪ Absolute interface amplitude *
Factory setting	Off

Assign diagnostic behavior

Navigation	  Setup → Advanced setup → Switch output → Assign diag. beh
Prerequisite	Switch output function (→  168) = Diagnostic behavior
Description	Defines to which behavior of diagnostic events the switch output reacts.

* Visibility depends on order options or device settings

Selection

- Alarm
- Alarm or warning
- Warning

Factory setting Alarm

Switch-on value 🔒

Navigation  Setup → Advanced setup → Switch output → Switch-on value

Prerequisite **Switch output function** (→  168) = **Limit**

Description Defines the switch-on point. The output is closed if the assigned process variable rises above this point.

User entry Signed floating-point number

Factory setting 0

Additional information The switching behavior depends on the relative position of the **Switch-on value** and **Switch-off value** parameters:

Switch-on value > Switch-off value

- The output is closed if the measured value is larger than **Switch-on value**.
- The output is opened if the measured value is smaller than **Switch-off value**.

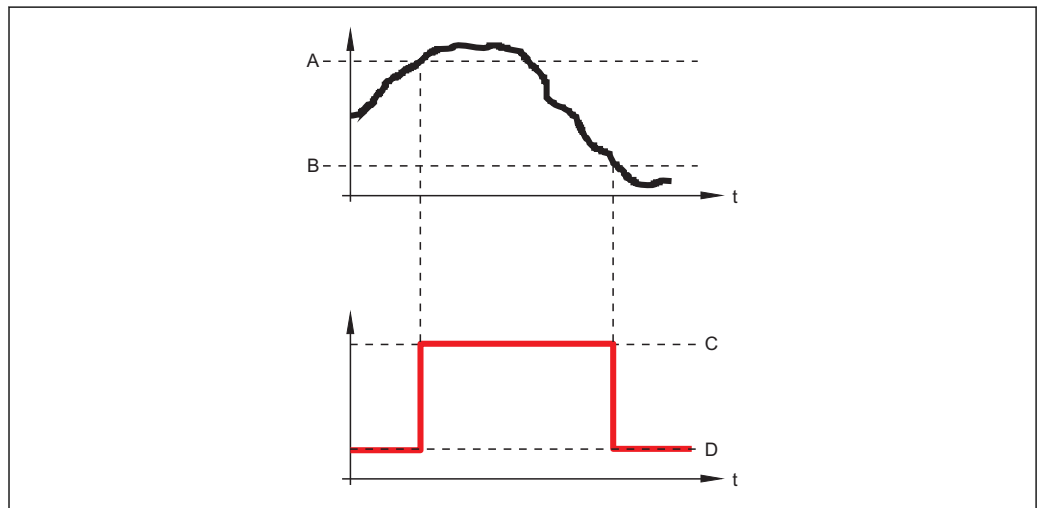

A0015585

- A Switch-on value
 B Switch-off value
 C Output closed (conductive)
 D Output opened (non-conductive)

Switch-on value < Switch-off value

- The output is closed if the measured value is smaller than **Switch-on value**.
- The output is opened if the measured value is larger than **Switch-off value**.

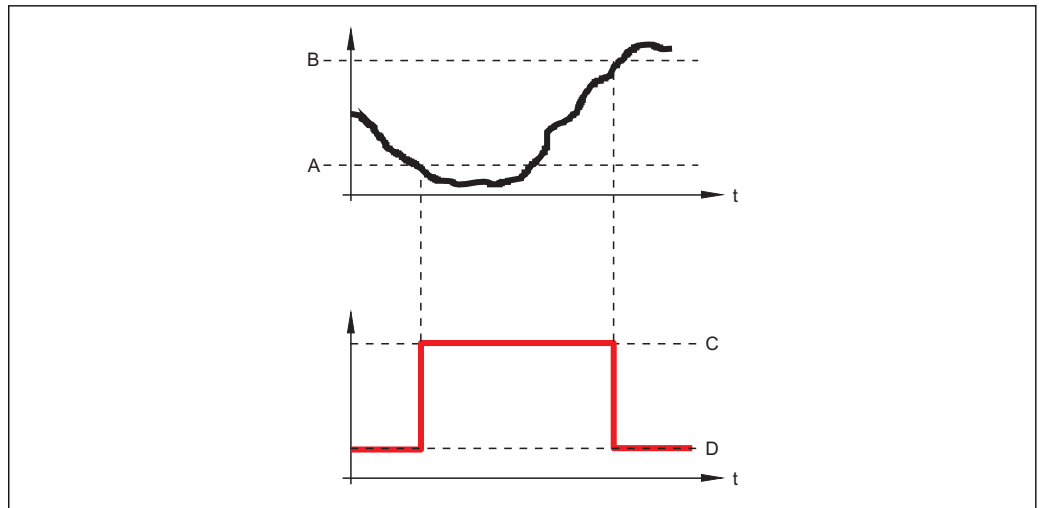

A0015586

- A Switch-on value
- B Switch-off value
- C Output closed (conductive)
- D Output opened (non-conductive)

Switch-on delay



Navigation Setup → Advanced setup → Switch output → Switch-on delay

Prerequisite **▪ Switch output function (→ 168) = Limit**
▪ Assign limit (→ 169) ≠ Off

Description Defines the delay applied before the output is switched on.

User entry 0.0 to 100.0 s

Factory setting 0.0 s

Switch-off value



Navigation Setup → Advanced setup → Switch output → Switch-off value

Prerequisite **Switch output function (→ 168) = Limit**

Description Defines the switch-off point. The output is opened if the assigned process variable falls below this point.





User entry Signed floating-point number

Factory setting 0

Additional information The switching behavior depends on the relative position of the **Switch-on value** and **Switch-off value** parameters; description: see the **Switch-on value** parameter (→ 170).



Switch-off delay



Navigation	  Setup → Advanced setup → Switch output → Switch-off delay
Prerequisite	<ul style="list-style-type: none"> ▪ Switch output function (→  168) = Limit ▪ Assign limit (→  169) ≠ Off
Description	Defines the delay applied before the output is switched off.
User entry	0.0 to 100.0 s
Factory setting	0.0 s



Failure mode



Navigation	  Setup → Advanced setup → Switch output → Failure mode
Prerequisite	Switch output function (→  168) = Limit or Digital Output
Description	Defines the state of the switch output in case of an error.
Selection	<ul style="list-style-type: none"> ▪ Actual status ▪ Open ▪ Closed
Factory setting	Open



Additional information

Switch status

Navigation	  Setup → Advanced setup → Switch output → Switch status
Description	Current status of the switch output.

Invert output signal



Navigation	  Setup → Advanced setup → Switch output → Invert outp.sig.
Description	'No' The switch output behaves as per its parameter setting. 'Yes' The switching behavior is inverted as compared to its parameter setting.
Selection	<ul style="list-style-type: none"> ▪ No ▪ Yes

Factory setting

No

Additional information**Meaning of the options**■ **No**

The behavior of the switch output is as described above.

■ **Yes**The states **Open** and **Closed** are inverted as compared to the description above.

"Display" submenu

 The **Display** submenu is only visible if a display module is connected to the device.

Navigation  Setup → Advanced setup → Display

Language**Navigation**

 Setup → Advanced setup → Display → Language

Description

Set display language.

Selection

- English
- Deutsch *
- Français *
- Español *
- Italiano *
- Nederlands *
- Portuguesa *
- Polski *
- русский язык (Russian) *
- Svenska *
- Türkçe *
- 中文 (Chinese) *
- 日本語 (Japanese) *
- 한국어 (Korean) *
- Bahasa Indonesia *
- tiếng Việt (Vietnamese) *
- čeština (Czech) *

Factory setting

The language selected in feature 500 of the product structure.
If no language has been selected: **English**

Additional information**Format display****Navigation**

 Setup → Advanced setup → Display → Format display

Description

Select how measured values are shown on the display.

Selection

- 1 value, max. size
- 1 bargraph + 1 value
- 2 values
- 1 value large + 2 values
- 4 values

Factory setting

1 value, max. size

* Visibility depends on order options or device settings

Additional information



A0019963

55 "Format display" = "1 value, max. size"

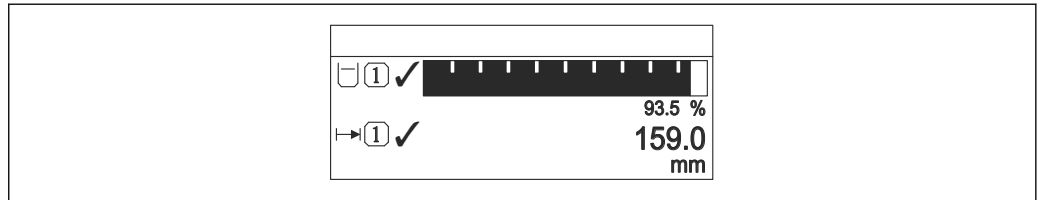

A0019964

56 "Format display" = "1 bargraph + 1 value"

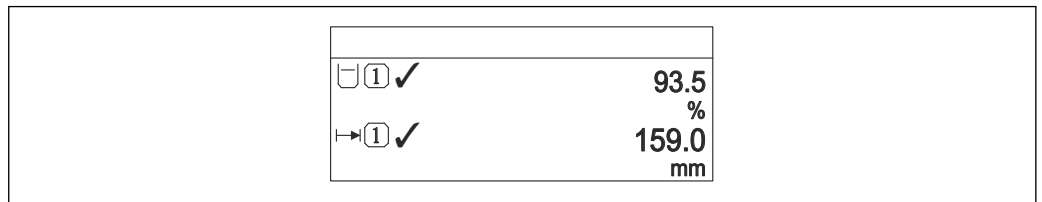

A0019965

57 "Format display" = "2 values"

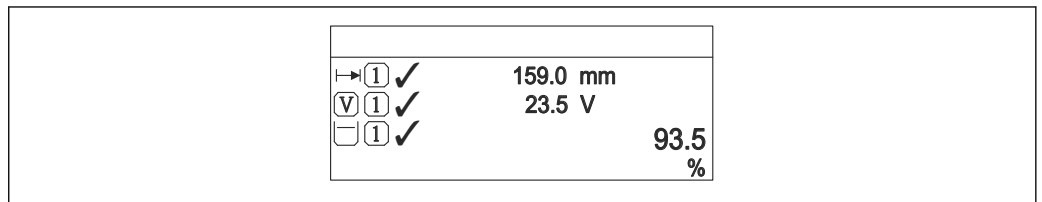

A0019966

58 "Format display" = "1 value large + 2 values"

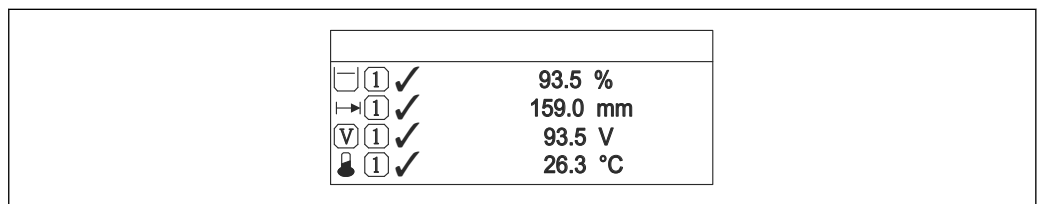

A0019968

59 "Format display" = "4 values"

- i
■
The Value 1 to 4 display → 176 parameters specify which measured values are shown on the display and in which order.
- If more measured values are specified than the current display mode permits, the values alternate on the device display. The display time until the next change is configured in the **Display interval** parameter (→ 176).

Value 1 to 4 display

Navigation Setup → Advanced setup → Display → Value 1 display

Description Select the measured value that is shown on the local display.

Selection

- Level linearized
- Distance
- Interface linearized *
- Interface distance *
- Thickness upper layer *
- Current output 1
- Measured current
- Current output 2 *
- Terminal voltage
- Electronic temperature
- Measured capacitance *
- Analog output adv. diagnostics 1
- Analog output adv. diagnostics 2

Factory setting

For level measurements

- Value 1 display: Level linearized
- Value 2 display: Distance
- Value 3 display: Current output 1
- Value 4 display: None

Decimal places 1 to 4

Navigation Setup → Advanced setup → Display → Decimal places 1

Description This selection does not affect the measurement and calculation accuracy of the device.

Selection

- x
- x.x
- x.xx
- x.xxx
- x.xxxx

Factory setting x.xx

Additional information The setting does not affect the measuring or computational accuracy of the device.

Display interval

Navigation Setup → Advanced setup → Display → Display interval

Description Set time measured values are shown on display if display alternates between values.

* Visibility depends on order options or device settings

User entry	1 to 10 s
Factory setting	5 s
Additional information	This parameter is only relevant if the number of selected measuring values exceeds the number of values the selected display format can display simultaneously.

Display damping



Navigation	Setup → Advanced setup → Display → Display damping
Description	Set display reaction time to fluctuations in the measured value.
User entry	0.0 to 999.9 s
Factory setting	0.0 s

Header



Navigation	Setup → Advanced setup → Display → Header
Description	Select header contents on local display.
Selection	<ul style="list-style-type: none"> ■ Device tag ■ Free text
Factory setting	Device tag

Additional information

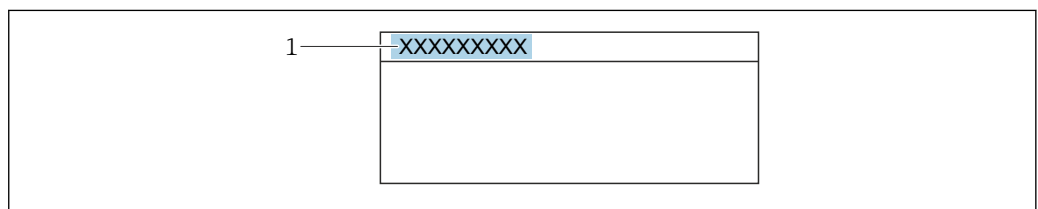



A0029422

1 Position of the header text on the display

Meaning of the options

- **Device tag**
Is defined in the **Device tag** parameter (→ 130)
- **Free text**
Is defined in the **Header text** parameter (→ 178)

Header text 

Navigation   Setup → Advanced setup → Display → Header text



Prerequisite **Header (→  177) = Free text**

Description Enter display header text.

Factory setting -----

Additional information The number of characters which can be displayed depends on the characters used.

Separator 

Navigation   Setup → Advanced setup → Display → Separator



Description Select decimal separator for displaying numerical values.

Selection

- .
- ,

Factory setting .

Number format 

Navigation   Setup → Advanced setup → Display → Number format

Description Choose number format for the display.



Selection

- Decimal
- ft-in-1/16"

Factory setting Decimal

Additional information The **ft-in-1/16"** option is only valid for distance units.



Decimal places menu 

Navigation   Setup → Advanced setup → Display → Dec. places menu







Description Select number of decimal places for the representation of numbers within the operating menu.

Selection	<ul style="list-style-type: none"> ■ X ■ X.X ■ X.XX ■ X.XXX ■ X.XXXX
Factory setting	x.xxxx
Additional information	<ul style="list-style-type: none"> ■ Is only valid for numbers in the operating menu (e.g. Empty calibration, Full calibration), but not for the measured value display. The number of decimal places for the measured value display is defined in the Decimal places 1 to 4 →  176 parameters. ■ The setting does not affect the accuracy of the measurement or the calculations.

Backlight

Navigation	  Setup → Advanced setup → Display → Backlight
Prerequisite	The device has the SD03 local display (with optical keys).
Description	Switch the local display backlight on and off.
Selection	<ul style="list-style-type: none"> ■ Disable ■ Enable
Factory setting	Disable
Additional information	<p>Meaning of the options</p> <ul style="list-style-type: none"> ■ Disable Switches the backlight off. ■ Enable Switches the backlight on. <p> Regardless of the setting in this parameter the backlight may be automatically switched off by the device if the supply voltage is too low.</p>

Contrast display

Navigation	  Setup → Advanced setup → Display → Contrast display
Description	Adjust local display contrast setting to ambient conditions (e.g. lighting or reading angle).
User entry	20 to 80 %
Factory setting	Dependent on the display.
Additional information	<p> Setting the contrast via push-buttons:</p> <ul style="list-style-type: none"> ■ Darker: press the   buttons simultaneously. ■ Brighter: press the   buttons simultaneously.

"Configuration backup display" submenu

 This submenu is only visible if a display module is connected to the device.

The configuration of the device can be saved to the display module at a certain point of time (backup). The saved configuration can be restored to the device if required, e.g. in order to bring the device back into a defined state. The configuration can also be transferred to a different device of the same type using the display module.

Navigation  Setup → Advanced setup → Conf.backup disp

Operating time

Navigation  Setup → Advanced setup → Conf.backup disp → Operating time

Description Indicates how long the device has been in operation.

Additional information *Maximum time*
9999 d (≈ 27 years)

Last backup

Navigation  Setup → Advanced setup → Conf.backup disp → Last backup

Description Indicates when the last data backup was saved to the display module.

Configuration management



Navigation  Setup → Advanced setup → Conf.backup disp → Config. managem.

Description Select action for managing the device data in the display module.



Selection

- Cancel
- Execute backup
- Restore
- Duplicate
- Compare
- Clear backup data

Factory setting Cancel



Additional information

Meaning of the options

- **Cancel**
No action is executed and the user exits the parameter.
 - **Execute backup**
A backup copy of the current device configuration in the HistoROM (built-in in the device) is saved to the display module of the device.
 - **Restore**
The last backup copy of the device configuration is copied from the display module to the HistoROM of the device.
 - **Duplicate**
The transmitter configuration is duplicated to another device using the transmitter display module. The following parameters, which characterize the individual measuring point are **not** included in the transmitted configuration:
 - HART date code
 - HART short tag
 - HART message
 - HART descriptor
 - HART address
 - Device tag
 - Medium type
 - **Compare**
The device configuration saved in the display module is compared to the current device configuration of the HistoROM. The result of this comparison is displayed in the **Comparison result** parameter (→  181).
 - **Clear backup data**
The backup copy of the device configuration is deleted from the display module of the device.
-  While this action is in progress, the configuration cannot be edited via the local display and a message on the processing status appears on the display.
-  If an existing backup is restored to a different device using the **Restore** option, it may occur that some device functionalities are no longer available. In some cases even a device reset will not restore the original status.
- In order to transmit a configuration to a different device, the **Duplicate** option should always be used.

Backup state

Navigation



  Setup → Advanced setup → Conf.backup disp → Backup state

Description

Displays which backup action is currently in progress.

Comparison result

Navigation

  Setup → Advanced setup → Conf.backup disp → Compar. result

Description

Comparison between present device data and display backup.

Additional information**Meaning of the display options****■ Settings identical**

The current device configuration of the HistoROM is identical to the backup copy in the display module.

■ Settings not identical

The current device configuration of the HistoROM is not identical to the backup copy in the display module.

■ No backup available

There is no backup copy of the device configuration of the HistoROM in the display module.

■ Backup settings corrupt

The current device configuration of the HistoROM is corrupt or not compatible with the backup copy in the display module.

■ Check not done

The device configuration of the HistoROM has not yet been compared to the backup copy in the display module.

■ Dataset incompatible

The data sets are incompatible and can not be compared.





To start the comparison, set **Configuration management** (→  180) = **Compare**.













If the transmitter configuration has been duplicated from a different device by **Configuration management** (→  180) = **Duplicate**, the new device configuration in the HistoROM is only partially identical to the configuration stored in the display module: Sensor specific properties (e.g. the mapping curve) are not duplicated. Thus, the result of the comparison will be **Settings not identical**.



"Administration" submenu

Navigation  Setup → Advanced setup → Administration

Define access code 

Navigation	 Setup → Advanced setup → Administration → Def. access code
Description	Define release code for write access to parameters.
User entry	0 to 9999
Factory setting	0
Additional information	<p> If the factory setting is not changed or 0 is defined as the access code, the parameters are not write-protected and the configuration data of the device can then always be modified. The user is logged on in the <i>Maintenance</i> role.</p> <p> The write protection affects all parameters marked with the  symbol in this document. On the local display, the  symbol in front of a parameter indicates that the parameter is write-protected.</p> <p> Once the access code has been defined, write-protected parameters can only be modified if the access code is entered in the Enter access code parameter (→  139).</p> <p> Please contact your Endress+Hauser Sales Center if you lose your access code.</p> <p> For display operation: The new access code is only valid after it has been confirmed in the Confirm access code parameter (→  185).</p>

Device reset 

Navigation	  Setup → Advanced setup → Administration → Device reset
Description	Reset the device configuration - either entirely or in part - to a defined state.
Selection	<ul style="list-style-type: none"> ■ Cancel ■ To factory defaults ■ To delivery settings ■ Of customer settings ■ To transducer defaults ■ Restart device
Factory setting	Cancel

Additional information**Meaning of the options****■ Cancel**

No action

■ To factory defaults

All parameters are reset to the order-code specific factory setting.

■ To delivery settings

All parameters are reset to the delivery setting. The delivery setting may differ from the factory default if customer specific settings have been ordered.

This option is only visible if customer specific settings have been ordered.

■ Of customer settings

All customer parameters are reset to their factory setting. Service parameters, however, remain unchanged.

■ To transducer defaults

Every measurement-related parameter is reset to its factory setting. Service parameters and communication-related parameters, however, remain unchanged.

■ Restart device

The restart resets every parameter which is stored in the volatile memory (RAM) to the factory setting (e.g. measured value data). The device configuration remains unchanged.

"Define access code" wizard

 The **Define access code** wizard is only available when operating via the local display. When operating via an operating tool, the **Define access code** parameter is located directly in the **Administration** submenu. The **Confirm access code** parameter is not available for operation via operating tool.

Navigation  Setup → Advanced setup → Administration → Def. access code

Define access code



Navigation  Setup → Advanced setup → Administration → Def. access code → Def. access code

Description →  183

Confirm access code



Navigation  Setup → Advanced setup → Administration → Def. access code → Confirm code

Description Confirm the entered access code.

User entry 0 to 9999

Factory setting 0

17.5 "Diagnostics" menu

Navigation  Diagnostics

Actual diagnostics



Navigation  Diagnostics → Actual diagnos.

Description Displays current diagnostic message.

Additional information The display consists of:

- Symbol for event behavior
- Code for diagnostic behavior
- Operating time of occurrence
- Event text

 If several messages are active at the same time, the messages with the highest priority is displayed.

 Information on what is causing the message, and remedy measures, can be viewed via the  symbol on the display.

Timestamp

Navigation  Diagnostics → Timestamp

Description Displays the timestamp for the currently active diagnostic message.



Previous diagnostics

Navigation  Diagnostics → Prev.diagnostics

Description Displays the last diagnostic message which has been active before the current message.

Additional information The display consists of:

- Symbol for event behavior
- Code for diagnostic behavior
- Operating time of occurrence
- Event text

 The condition displayed may still apply. Information on what is causing the message, and remedy measures, can be viewed via the  symbol on the display.

Timestamp

Navigation  Diagnostics → Timestamp

Description Shows the timestamp of the previous diagnostic message.

Operating time from restart

Navigation   Diagnostics → Time fr. restart

Description Displays the time the device has been in operation since the last device restart.

Operating time

Navigation   Diagnostics → Operating time

Description Indicates how long the device has been in operation.

Additional information *Maximum time*
9999 d (≈ 27 years)

17.5.1 "Diagnostic list" submenu

Navigation  Diagnostics → Diagnostic list

Diagnostics 1 to 5

Navigation	 Diagnostics → Diagnostic list → Diagnostics 1
Description	Display the current diagnostics messages with the highest to fifth-highest priority.
Additional information	The display consists of: <ul style="list-style-type: none">■ Symbol for event behavior■ Code for diagnostic behavior■ Operating time of occurrence■ Event text

Timestamp 1 to 5



Navigation	 Diagnostics → Diagnostic list → Timestamp
Description	Timestamp of the diagnostic message.

17.5.2 "Event logbook" submenu

 The **Event logbook** submenu is only available when operating via the local display. When operating via FieldCare, the event list can be displayed in the FieldCare function "Event List / HistoROM".

Navigation  Diagnostics → Event logbook



Filter options



Navigation	 Diagnostics → Event logbook → Filter options
Description	Define which category of event messages is shown in the Events list submenu.
Selection	<ul style="list-style-type: none"> ▪ All ▪ Failure (F) ▪ Function check (C) ▪ Out of specification (S) ▪ Maintenance required (M) ▪ Information (I)
Factory setting	All
Additional information	 <ul style="list-style-type: none"> ▪ This parameter is only used for operation via the local display. ▪ The status signals are categorized according to NAMUR NE 107.

"Event list" submenu

The **Event list** submenu displays the history of past events of the category selected in the **Filter options** parameter (→  189). A maximum of 100 events are displayed in chronological order.

The following symbols indicate whether an event has occurred or has ended:

- : Event has occurred
- : Event has ended

 Information on what is causing the message, and remedy instructions, can be viewed via the -button.

Display format

- For event messages in category I: information event, event text, "recording event" symbol and time the event occurred
- For event messages in category F, M, C, S (status signal): diagnostics event, event text, "recording event" symbol and time the event occurred

Navigation  Diagnostics → Event logbook → Event list

17.5.3 "Device information" submenu

Navigation  Diagnostics → Device info

Device tag

Navigation  Diagnostics → Device info → Device tag

Description Enter the name for the measuring point.

Factory setting FMP5x

Serial number

Navigation  Diagnostics → Device info → Serial number

Description Shows the serial number of the measuring device.

Additional information  **Uses of the serial number**

- To identify the device quickly, e.g. when contacting Endress+Hauser.
- To obtain specific information on the device using the Device Viewer:
www.endress.com/deviceviewer

 The serial number is also indicated on the nameplate.

Firmware version

Navigation  Diagnostics → Device info → Firmware version

Description Shows the device firmware version installed.

User interface xx.yy.zz



Additional information  For firmware versions differing only in the last two digits ("zz") there is no difference concerning functionality or operation.

Device name



Navigation  Diagnostics → Device info → Device name

Description Shows the name of the transmitter.



Order code 

Navigation	  Diagnostics → Device info → Order code
Description	Shows the device order code.
Additional information	The order code is generated from the extended order code, which defines all device features of the product structure. In contrast, the device features can not be read directly from the order code.



Extended order code 1 to 3 

Navigation	  Diagnostics → Device info → Ext. order cd. 1
Description	Display the three parts of the extended order code.
Additional information	The extended order code indicates the version of all the features of the product structure and thus uniquely identifies the device.

Device revision

Navigation	  Diagnostics → Device info → Device revision
Description	Shows the device revision with which the device is registered with the HART Communication Foundation.
Additional information	The device revision is used to allocate the correct Device Description file (DD) to the device.

Device ID

Navigation	  Diagnostics → Device info → Device ID
Description	Shows the device ID for identifying the device in a HART network.
Additional information	In addition to the Device type and Manufacturer ID, the Device ID is part of the unique device identification (Unique ID) which characterizes each HART device unambiguously.

Device type

Navigation Diagnostics → Device info → Device type**Description**

Shows the device type with which the measuring device is registered with the HART Communication Foundation.

Additional information

Manufacturer ID

Navigation Diagnostics → Device info → Manufacturer ID**Description**

Use this function to view the manufacturer ID with which the measuring device is registered with the HART Communication Foundation.

User interface

2-digit hexadecimal number

Factory setting

0x11 (for Endress+Hauser)

17.5.4 "Measured values" submenu

Navigation  Diagnostics → Measured val.

Distance

Navigation  Diagnostics → Measured val. → Distance

Description Displays the measured distance D_L between the reference point (lower edge of the flange or threaded connection) and the level.

Additional information

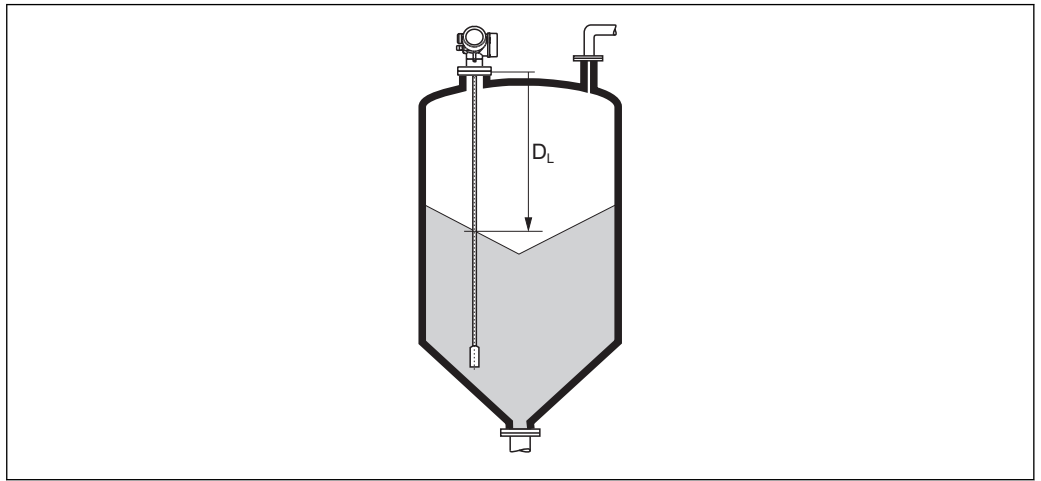

A0013201

 60 Distance for bulk solid measurements

 The unit is defined in the **Distance unit** parameter (→  130).

Level linearized

Navigation  Diagnostics → Measured val. → Level linearized

Description Displays linearized level.

Additional information  The unit is defined by the **Unit after linearization** parameter →  149.

Output current 1 to 2

Navigation  Diagnostics → Measured val. → Output curr. 1 to 2

Description Shows the actual calculated value of the output current.

Measured current 1

Navigation	 Diagnostics → Measured val. → Measur. curr. 1
Prerequisite	Only available for current output 1
Description	Shows the current value of the current output which is currently measured.

Terminal voltage 1

Navigation	 Diagnostics → Measured val. → Terminal volt. 1
Description	Shows the current terminal voltage that is applied at the output.

17.5.5 "Data logging" submenu

Navigation  Diagnostics → Data logging

Assign channel 1 to 4

Navigation  Diagnostics → Data logging → Assign chan. 1 to 4

Description Assign a process variable to logging channel.

Selection

- Off
- Level linearized
- Distance
- Unfiltered distance
- Interface linearized *
- Interface distance *
- Unfiltered interface distance
- Thickness upper layer *
- Current output 1
- Measured current
- Current output 2 *
- Terminal voltage
- Electronic temperature
- Measured capacitance *
- Absolute echo amplitude
- Relative echo amplitude
- Absolute interface amplitude *
- Relative interface amplitude *
- Absolute EOP amplitude
- EOP shift
- Noise of signal
- Calculated DC value *
- Analog output adv. diagnostics 1
- Analog output adv. diagnostics 2

Factory setting Off

Additional information A total of 1000 measured values can be logged. This means:

- 1000 data points if 1 logging channel is used
- 500 data points if 2 logging channels are used
- 333 data points if 3 logging channels are used
- 250 data points if 4 logging channels are used

If the maximum number of data points is reached, the oldest data points in the data log are cyclically overwritten in such a way that the last 1000, 500, 333 or 250 measured values are always in the log (ring memory principle).

 The logged data are deleted if a new option is selected in this parameter.

* Visibility depends on order options or device settings

Logging interval

Navigation	Diagnostics → Data logging → Logging interval Diagnostics → Data logging → Logging interval
Description	Define the logging interval t_{log} for data logging. This value defines the time interval between the individual data points in the memory.
User entry	1.0 to 3 600.0 s
Factory setting	30.0 s
Additional information	<p>This parameter defines the interval between the individual data points in the data log, and thus the maximum loggable process time T_{log} :</p> <ul style="list-style-type: none"> ▪ If 1 logging channel is used: $T_{log} = 1000 \cdot t_{log}$ ▪ If 2 logging channels are used: $T_{log} = 500 \cdot t_{log}$ ▪ If 3 logging channels are used: $T_{log} = 333 \cdot t_{log}$ ▪ If 4 logging channels are used: $T_{log} = 250 \cdot t_{log}$ <p>Once this time elapses, the oldest data points in the data log are cyclically overwritten such that a time of T_{log} always remains in the memory (ring memory principle).</p> <p> The logged data are deleted if this parameter is changed.</p> <p><i>Example</i></p> <p>When using 1 logging channel</p> <ul style="list-style-type: none"> ▪ $T_{log} = 1000 \cdot 1 \text{ s} = 1000 \text{ s} \approx 16.5 \text{ min}$ ▪ $T_{log} = 1000 \cdot 10 \text{ s} = 1000 \text{ s} \approx 2.75 \text{ h}$ ▪ $T_{log} = 1000 \cdot 80 \text{ s} = 80\,000 \text{ s} \approx 22 \text{ h}$ ▪ $T_{log} = 1000 \cdot 3\,600 \text{ s} = 3\,600\,000 \text{ s} \approx 41 \text{ d}$

Clear logging data

Navigation	Diagnostics → Data logging → Clear logging Diagnostics → Data logging → Clear logging
Description	Clear the entire logging data.
Selection	<ul style="list-style-type: none"> ▪ Cancel ▪ Clear data
Factory setting	Cancel

"Display channel 1 to 4" submenu

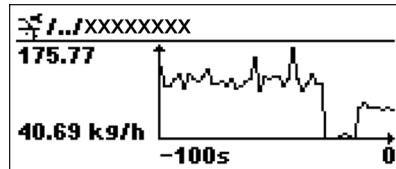

i The **Display channel 1 to 4** submenus are only available for operation via the local display. When operating via FieldCare, the logging diagram can be displayed in the FieldCare function "Event List / HistoROM" .

The **Display channel 1 to 4** submenus invoke a diagram of the logging history of the respective channel.



- x-axis: depending on the number of selected channels, 250 to 1000 measured values of a process variable are displayed.
- y-axis: covers the approximate measured value span and constantly adapts this to the measurement.

i To return to the operating menu, press \oplus and \ominus simultaneously.

Navigation   Diagnostics → Data logging → Displ.channel 1 to 4

17.5.6 "Simulation" submenu









The **Simulation** submenu is used to simulate specific measuring values or other conditions. This helps to check the correct configuration of the device and connected control units.

Conditions which can be simulated

Condition to be simulated	Associated parameters
Specific value of a process variable	<ul style="list-style-type: none"> ▪ Assign measurement variable (→ ☰ 200) ▪ Process variable value (→ ☰ 200)
Specific value of the output current	<ul style="list-style-type: none"> ▪ Current output simulation (→ ☰ 200) ▪ Value current output (→ ☰ 201)
Specific state of the switch output	<ul style="list-style-type: none"> ▪ Switch output simulation (→ ☰ 201) ▪ Switch status (→ ☰ 201)
Existence of an alarm	Device alarm simulation (→ ☰ 202)
Existence of a specific diagnostic message	Diagnostic event simulation (→ ☰ 202)

Structure of the submenu



Navigation  Expert → Diagnostics → Simulation

► Simulation	
Assign measurement variable	→  200
Process variable value	→  200
Current output 1 to 2 simulation	→  200
Value current output 1 to 2	→  201
Switch output simulation	→  201
Switch status	→  201
Device alarm simulation	→  202
Diagnostic event simulation	→  202



Description of parameters

Navigation  Expert → Diagnostics → Simulation

Assign measurement variable

Navigation	 Expert → Diagnostics → Simulation → Assign meas.var.
Selection	<ul style="list-style-type: none"> ■ Off ■ Level ■ Interface * ■ Thickness upper layer * ■ Level linearized ■ Interface linearized ■ Thickness linearized
Factory setting	Off
Additional information	<ul style="list-style-type: none"> ■ The value of the variable to be simulated is defined in the Process variable value parameter (→  200). ■ If Assign measurement variable ≠ Off, a simulation is active. This is indicated by a diagnostic message of the <i>Function check (C)</i> category.

Process variable value

Navigation	 Expert → Diagnostics → Simulation → Proc. var. value
Prerequisite	Assign measurement variable (→  200) ≠ Off
User entry	Signed floating-point number
Factory setting	0
Additional information	Downstream measured value processing and the signal output use this simulation value. In this way, users can verify whether the measuring device has been configured correctly.



Current output 1 to 2 simulation

Navigation	 Expert → Diagnostics → Simulation → Curr.out. 1 to 2 sim.
Description	Switch the simulation of the current output on and off.
Selection	<ul style="list-style-type: none"> ■ Off ■ On



* Visibility depends on order options or device settings

Factory setting	Off
Additional information	An active simulation is indicated by a diagnostic message of the <i>Function check (C)</i> category.



Value current output 1 to 2

Navigation	  Expert → Diagnostics → Simulation → Value curr.out 1 to 2
Prerequisite	Current output simulation (→  200) = On
Description	Defines the value of the simulated output current.
User entry	3.59 to 22.5 mA
Factory setting	3.59 mA
Additional information	The current output assumes the value specified in this parameter. In this way, users can verify the correct adjustment of the current output and the correct function of connected control units.

Switch output simulation



Navigation	  Expert → Diagnostics → Simulation → Switch sim.
Description	Switch the simulation of the switch output on and off.
Selection	<ul style="list-style-type: none"> ■ Off ■ On
Factory setting	Off

Switch status

Navigation	  Expert → Diagnostics → Simulation → Switch status
Prerequisite	Switch output simulation (→  201) = On
Description	Current status of the switch output.
Selection	<ul style="list-style-type: none"> ■ Open ■ Closed
Factory setting	Open

Additional information The switch status assumes the value defined in this parameter. This helps to check correct operation of connected control units.

Device alarm simulation

Navigation   Expert → Diagnostics → Simulation → Dev. alarm sim.

Description Switch the device alarm on and off.

Selection



- Off
- On

Factory setting Off

Additional information When selecting the **On** option, the device generates an alarm. This helps to check the correct output behavior of the device in the case of an alarm.

An active simulation is indicated by the  **C484 Failure mode simulation** diagnostic message.

Diagnostic event simulation

Navigation   Expert → Diagnostics → Simulation → Diag. event sim.

Description Select the diagnostic event to be simulated. Note: To terminate the simulation, select 'Off'.



Factory setting Off

Additional information When operated via the local display, the selection list can be filtered according to the event categories (**Diagnostic event category** parameter).



17.5.7 "Device check" submenu

Navigation   Diagnostics → Device check



Start device check

Navigation	  Diagnostics → Device check → Start dev. check
Description	Start a device check.
Selection	<ul style="list-style-type: none"> ■ No ■ Yes
Factory setting	No
Additional information	In the case of a lost echo a device check can not be performed.

Result device check

Navigation	  Diagnostics → Device check → Result dev.check
Description	Displays the result of the device check.
Additional information	<p>Meaning of the display options</p> <ul style="list-style-type: none"> ■ Installation ok Measurement possible without restrictions. ■ Accuracy reduced A measurement is possible. However, the measuring accuracy may be reduced due to the signal amplitudes. ■ Measurement capability reduced A measurement is currently possible. However, there is the risk of an echo loss. Check the mounting position of the device and the dielectric constant of the medium. ■ Check not done No device check has been performed.

Last check time

Navigation	  Diagnostics → Device check → Last check time
Description	Displays the operating time at which the last device check has been performed.

Level signal

Navigation	 Diagnostics → Device check → Level signal
Prerequisite	Device check has been performed.
Description	Displays result of the device check for the level signal.
User interface	<ul style="list-style-type: none">▪ Check not done▪ Check not OK▪ Check OK
Additional information	For Level signal = Check not OK : Check the mounting position of the device and the dielectric constant of the medium.

Launch signal

Navigation	 Diagnostics → Device check → Launch signal
Prerequisite	Device check has been performed.
Description	Displays result of the display check for the launch signal.
User interface	<ul style="list-style-type: none">▪ Check not done▪ Check not OK▪ Check OK
Additional information	For Launch signal = Check not OK : Check the mounting position of the device. In non-metallic vessels use a metal plate or a metal flange.

17.5.8 "Heartbeat" submenu

 The **Heartbeat** submenu is only available via **FieldCare** or **DeviceCare**. It contains the wizards which are part of the **Heartbeat Verification** and **Heartbeat Monitoring** application packages.

Detailed description

SD01872F

Navigation  Diagnostics → Heartbeat

Index

A

- Access authorization to parameters
 - Read access 61
 - Write access 61
- Access code 61
 - Incorrect input 61
- Access status display (Parameter) 139
- Access status tooling (Parameter) 138
- Accessories
 - Communication-specific 110
 - Device-specific 103
 - Service-specific 111
 - System components 111
- Activate table (Parameter) 154
- Actual diagnostics (Parameter) 186
- Administration (Submenu) 183
- Advanced process conditions (Parameter) 142
- Advanced setup (Submenu) 138
- Application 9
- Assign channel 1 to 4 (Parameter) 195
- Assign current output (Parameter) 164
- Assign diagnostic behavior (Parameter) 169
- Assign limit (Parameter) 169
- Assign measurement variable (Parameter) 200
- Assign status (Parameter) 169

B

- Backlight (Parameter) 179
- Backup state (Parameter) 181
- Bin type (Parameter) 130
- Blocking distance (Parameter) 143, 157
- Bluetooth® wireless technology 57

C

- Cleaning 100
- Clear logging data (Parameter) 196
- Code incorrect (Parameter) 160
- Comparison result (Parameter) 181
- Configuration backup display (Submenu) 180
- Configuration management (Parameter) 180
- Configuration of a level measurement 79
- Configuring level measurement 79
- Confirm access code (Parameter) 185
- Confirm distance (Parameter) 134, 137
- Confirm probe length (Parameter) 162, 163
- Context menu 72
- Contrast display (Parameter) 179
- Current output 1 to 2 (Submenu) 164
- Current output 1 to 2 simulation (Parameter) 200
- Current span (Parameter) 165
- Customer value (Parameter) 154

D

- Damping output (Parameter) 166
- Data logging (Submenu) 195
- DD 74

- Deactivate SIL/WHG (Wizard) 160
 - Decimal places 1 (Parameter) 176
 - Decimal places menu (Parameter) 178
 - Define access code 61
 - Define access code (Parameter) 183, 185
 - Define access code (Wizard) 185
 - Designated use 9
 - Device alarm simulation (Parameter) 202
 - Device check (Submenu) 203
 - Device Descriptions 74
 - Device ID (Parameter) 191
 - Device information (Submenu) 190
 - Device name (Parameter) 190
 - Device replacement 101
 - Device reset (Parameter) 183
 - Device revision (Parameter) 191
 - Device tag (Parameter) 130, 190
 - Device type (Parameter) 192
 - Diagnostic event
 - In the operating tool 93
 - Diagnostic event simulation (Parameter) 202
 - Diagnostic events 90
 - Diagnostic list 94
 - Diagnostic list (Submenu) 188
 - Diagnostic message 90
 - Diagnostics
 - Symbols 90
 - Diagnostics (Menu) 186
 - Diagnostics 1 (Parameter) 188
 - Diagnostics event 91
 - Diameter (Parameter) 151
 - DIP switch
 - see Write protection switch
 - Display (Submenu) 174
 - Display and operating module FHX50 56
 - Display channel 1 to 4 (Submenu) 197
 - Display damping (Parameter) 177
 - Display interval (Parameter) 176
 - Display module 66
 - Display symbols 67
 - Disposal 102
 - Distance (Parameter) 132, 137, 193
 - Distance unit (Parameter) 130
 - Document
 - Function 5
 - Document function 5
- ## E
- Electronics housing
 - Design 12
 - Empty calibration (Parameter) 131
 - Enter access code (Parameter) 139
 - Envelope curve display 73
 - Event history 97
 - Event level
 - Explanation 90

Symbols 90

Event list (Submenu) 189

Event logbook (Submenu) 189

Event text 91

Events list 97

Extended order code 1 (Parameter) 191

Exterior cleaning 100

F

Failure current (Parameter) 167

Failure mode (Parameter) 166, 172

FHX50 56

Field of application

 Residual risks 9

Filter options (Parameter) 189

Filtering the event logbook 97

Firmware version (Parameter) 190

Fixed current (Parameter) 165

Flange 35

Format display (Parameter) 174

Free text (Parameter) 150

Full calibration (Parameter) 131

FV (HART device variable) 74

H

Hardware write protection 62

HART device variables 74

HART protocol 58

HART-Integration 74

Header (Parameter) 177

Header text (Parameter) 178

Heartbeat (Submenu) 205

Housing

 Design 12

 Turning 37

I

Input mask 70

Intermediate height (Parameter) 152

Invert output signal (Parameter) 172

K

Keypad lock

 Disabling 65

 Switching on 65

L

Language (Parameter) 174

Last backup (Parameter) 180

Last check time (Parameter) 203

Launch signal (Parameter) 204

Level (Parameter) 132, 154

Level (Submenu) 140

Level correction (Parameter) 144

Level linearized (Parameter) 151, 193

Level signal (Parameter) 204

Level unit (Parameter) 143

Linearization (Submenu) 146, 147, 148

Linearization type (Parameter) 148

Local display 55

 see Diagnostics message

 see In alarm condition

Locking status 67

Locking status (Parameter) 138

Logging interval (Parameter) 196

M

Maintenance 100

Managing the device configuration 84

Manufacturer ID (Parameter) 192

Mapping (Wizard) 137

Mapping end point (Parameter) 135, 137

Maximum value (Parameter) 151

Measured current 1 (Parameter) 194

Measured value symbols 68

Measured values (Submenu) 193

Media 9

Medium property (Parameter) 140

Medium type (Parameter) 140

Menu

 Diagnostics 186

 Setup 130

Mounting position for level measurements 17

N

Non-metal vessels 30

Number format (Parameter) 178

O

Occupational safety 10

Operating elements

 Diagnostics message 91

Operating module 66

Operating time (Parameter) 180, 187

Operating time from restart (Parameter) 187

Operational safety 10

Order code (Parameter) 191

Output current 1 to 2 (Parameter) 167, 193

Output echo lost (Parameter) 156

Overvoltage protection

 General information 51

P

Present mapping (Parameter) 135

Present probe length (Parameter) 161, 163

Previous diagnostics (Parameter) 186

Probe grounded (Parameter) 161

Probe length correction (Wizard) 163

Probe settings (Submenu) 161

Process property (Parameter) 141

Process variable value (Parameter) 200

Product safety 10

PV (HART device variable) 74

R

Ramp at echo lost (Parameter) 157

Read access 61

Record map (Parameter) 135, 137

Registered trademarks 8

- Remedial measures
 - Calling up 92
 - Closing 92
- Remote operation 58
- Repair concept 101
- Replacing a device 101
- Requirements for personnel 9
- Reset write protection (Parameter) 160
- Result device check (Parameter) 203
- Return 102
- Rod probe
 - Design 11
- Rod probes
 - Lateral loading capacity 23
 - Shortening 32
- Rope probe
 - Design 11
- Rope probes
 - Installation 35
 - Shortening 32
- S**
- Safety instructions
 - Basic 9
- Safety Instructions (XA) 7
- Safety settings (Submenu) 156
- Securing rod probes 27
- Securing rope probes 26
- Separator (Parameter) 178
- Serial number (Parameter) 190
- Service interface (CDI) 58
- Setting the operating language 78
- Settings
 - Managing the device configuration 84
 - Operating language 78
- Setup (Menu) 130
- Signal quality (Parameter) 133
- SIL/WHG confirmation (Wizard) 159
- Simulation (Submenu) 199, 200
- Spare parts 102
 - Nameplate 102
- Start device check (Parameter) 203
- Status signals 67, 90
- Submenu
 - Administration 183
 - Advanced setup 138
 - Configuration backup display 180
 - Current output 1 to 2 164
 - Data logging 195
 - Device check 203
 - Device information 190
 - Diagnostic list 188
 - Display 174
 - Display channel 1 to 4 197
 - Event list 189
 - Event logbook 189
 - Events list 97
 - Heartbeat 205
 - Level 140
 - Linearization 146, 147, 148
 - Measured values 193
 - Probe settings 161
 - Safety settings 156
 - Simulation 199, 200
 - Switch output 168
 - SV (HART device variable) 74
 - Switch output (Submenu) 168
 - Switch output function (Parameter) 168
 - Switch output simulation (Parameter) 201
 - Switch status (Parameter) 172, 201
 - Switch-off delay (Parameter) 172
 - Switch-off value (Parameter) 171
 - Switch-on delay (Parameter) 171
 - Switch-on value (Parameter) 170
- Symbols
 - For correction 70
 - In the text and numeric editor 70
- System components 111
- T**
- Table mode (Parameter) 152
- Table number (Parameter) 153
- Terminal voltage 1 (Parameter) 194
- Thermal insulation 31
- Threaded connection 34
- Timestamp (Parameter) 186, 187, 188
- Tool 32
- Transmitter
 - Turning the display 38
 - Turning the display module 38
- Transmitter housing
 - Turning 37
- Troubleshooting 86
- Turning the display 38
- Turning the display module 38
- TV (HART device variable) 74
- U**
- Unit after linearization (Parameter) 149
- Use of the measuring device
 - see Designated use
- Using measuring devices
 - Borderline cases 9
 - Incorrect use 9
- V**
- Value 1 display (Parameter) 176
- Value current output 1 to 2 (Parameter) 201
- Value echo lost (Parameter) 156
- W**
- Wizard
 - Deactivate SIL/WHG 160
 - Define access code 185
 - Mapping 137
 - Probe length correction 163
 - SIL/WHG confirmation 159
- Write access 61

- Write protection
 - Via access code 61
 - Via write protection switch 62
- Write protection switch 62



71488045

www.addresses.endress.com
