

# Technical Information

## Fieldgate FXA42

### System Products



## Gateway for data transmission via Ethernet, WLAN or mobile telecommunications

### Application

Fieldgates make it possible to remotely interrogate connected 4 to 20 mA Modbus RS485 and Modbus TCP devices, either via Ethernet TCP/IP, WLAN or mobile telecommunications (UMTS, LTE Cat M1 and Cat NB1). The measured data are processed accordingly and forwarded to SupplyCare. In SupplyCare, the data are visualized, compiled into reports and used for other inventory management tasks. However, it is also possible to access the data transmitted by Fieldgate FXA42 without any additional software using the Web browser. Comprehensive configuration and automation capabilities are available for the Fieldgate FXA42 thanks to the integrated Web PLC.

### Your benefits

- Communication via Ethernet, WLAN, UMTS or LTE Cat M1 and Cat NB1
- Easy configuration without any additional software using Web browser
- Four 4 to 20 mA current inputs with integrated loop power supply
- Active/passive current input for 2-wire and 4-wire devices
- 4 digital inputs can also be used as pulse counters for flow applications
- Advanced logic functions thanks to integrated Web-PLC and communication with external systems via Modbus interface

## Table of contents

<b>About this document</b> . . . . .	<b>3</b>	<b>Telecommunications approval</b> . . . . .	<b>21</b>
Symbols . . . . .	3	Europe . . . . .	21
<b>Application</b> . . . . .	<b>4</b>	USA and Canada . . . . .	21
Vendor Managed Inventory . . . . .	4	Other certificates . . . . .	21
<b>Function and system design</b> . . . . .	<b>5</b>	<b>Ordering information</b> . . . . .	<b>23</b>
IT security . . . . .	5	Product design . . . . .	23
System requirements . . . . .	5	Ordering information . . . . .	24
System design . . . . .	5	<b>Accessories</b> . . . . .	<b>24</b>
<b>Input</b> . . . . .	<b>12</b>	Device-specific accessories . . . . .	24
Terminal assignment . . . . .	12	Communication-specific accessories . . . . .	24
Weight . . . . .	12	<b>Supplementary documentation</b> . . . . .	<b>24</b>
Materials . . . . .	12	Standard documentation . . . . .	25
Terminals . . . . .	12	<b>Registered trademarks</b> . . . . .	<b>25</b>
4 to 20 mA analog input . . . . .	12		
Digital input . . . . .	13		
<b>Output</b> . . . . .	<b>14</b>		
Digital output . . . . .	14		
RS485 serial interface (Modbus) . . . . .	15		
<b>Power supply</b> . . . . .	<b>15</b>		
Supply voltage . . . . .	15		
Power consumption . . . . .	15		
Voltage interruption (IEC 61000-4-29) . . . . .	15		
<b>Installation</b> . . . . .	<b>16</b>		
Mounting location . . . . .	16		
Orientation . . . . .	16		
Dimensions . . . . .	16		
Antenna . . . . .	16		
<b>Environment</b> . . . . .	<b>17</b>		
Ambient temperature range . . . . .	17		
Transportation and storage temperature . . . . .	17		
Humidity . . . . .	17		
Condensation . . . . .	17		
Climate class . . . . .	17		
Installation height as per IEC61010-1 Ed.3 . . . . .	17		
Degree of protection . . . . .	17		
Shock resistance . . . . .	17		
Vibration resistance . . . . .	17		
Electromagnetic compatibility . . . . .	17		
<b>Operability</b> . . . . .	<b>18</b>		
Display elements (device status indicator / LED) . . . . .	18		
Operating elements . . . . .	18		
Integrated Web server . . . . .	19		
Integrated Web-PLC . . . . .	20		
<b>Certificates and approvals</b> . . . . .	<b>20</b>		
CE mark . . . . .	20		
RoHS . . . . .	21		
Other standards and guidelines . . . . .	21		

## About this document

---

### Symbols

#### Safety symbols

** DANGER**

This symbol alerts you to a dangerous situation. Failure to avoid this situation will result in serious or fatal injury.

** WARNING**

This symbol alerts you to a dangerous situation. Failure to avoid this situation can result in serious or fatal injury.

** CAUTION**

This symbol alerts you to a dangerous situation. Failure to avoid this situation can result in minor or medium injury.

** NOTICE**

This symbol contains information on procedures and other facts which do not result in personal injury.

#### Electrical symbols

 Ground connection

Grounded clamp, which is grounded via a grounding system.

 Signal ground connection

A terminal that can be used as a ground contact for the digital input.

#### Communication symbols

 Wireless Local Area Network (WLAN)

Communication via a wireless, local network

 Light emitting diode is off

 Light emitting diode is on

 Light emitting diode is flashing

#### Symbols for certain types of information

 Tip

Indicates additional information

 Reference to documentation

 Reference to another section

 1, 2, 3 Series of steps

#### Symbols in graphics

1, 2, 3 ... Item numbers

 Hazardous area

 Safe area (non-hazardous area)

## Application

### Vendor Managed Inventory

Thanks to the remote interrogation of tank or silo levels via Fieldgates, raw material suppliers can access information about current inventory levels at their regular customers' plants 24/7 and factor this information into their own production planning, for example. The Fieldgates monitor the configured level limits and automatically trigger the next delivery of product as required. The possibilities here range from simple refill requisitioning by e-mail through to fully automated order processing by incorporating XML data into the planning systems on both sides.

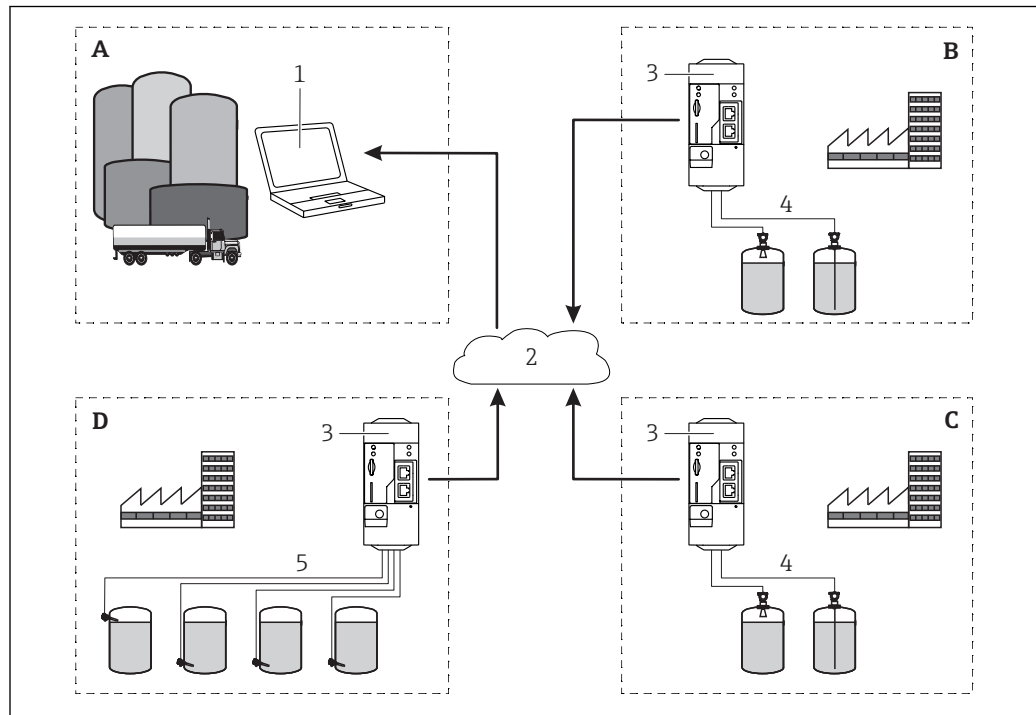

A0031635

1 Application of a Vendor Managed Inventory

- A Supplier
- B Customer 1
- C Customer 2
- D Customer 3
- 1 SupplyCare Enterprise / SupplyCare Hosting (via Web browser)
- 2 Internet / LAN
- 3 Fieldgate FXA42
- 4 Analog 4 to 20 mA
- 5 Limit switch

## Function and system design

### IT security

Our warranty is valid only if the device is installed and used as described in the Operating Instructions. The device is equipped with security mechanisms to protect it against any inadvertent changes to the settings.

IT security measures, which provide additional protection for the device and associated data transfer, must be implemented by the operators themselves in line with their security standards.

### System requirements

Internet browser	Mobile device
<ul style="list-style-type: none"> <li>▪ Mozilla Firefox version 31 or higher</li> <li>▪ Google Chrome version 31 or higher</li> <li>▪ Microsoft Edge</li> <li>▪ Internet Explorer 10 or higher</li> </ul>	<ul style="list-style-type: none"> <li>▪ Device with iOS: iOS Safari 7.1 or higher</li> <li>▪ Device with Android: Android Firefox or Chrome from version 31</li> </ul>

### System design

#### Configuration with 4 to 20 mA analog input (2-wire/4-wire)

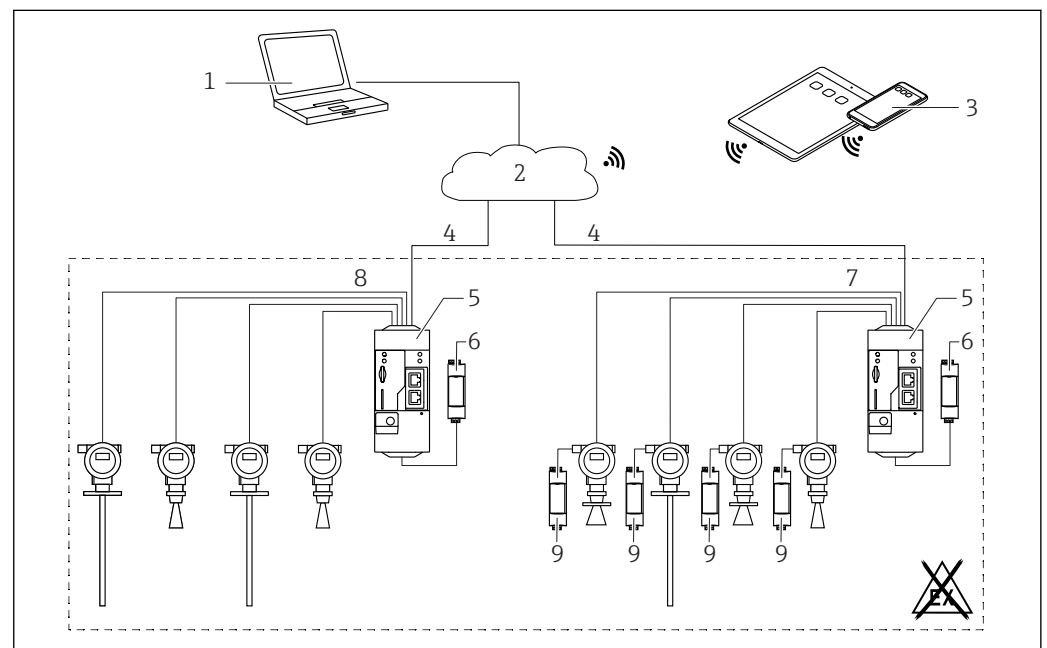

A0030920

2 System architecture of a Fieldgate FXA42 with 4 to 20 mA analog input

- 1 SupplyCare Enterprise / SupplyCare Hosting (via Web browser)
- 2 Internet / LAN
- 3 SupplyCare Enterprise / SupplyCare Hosting on mobile devices (via Web browser)
- 4 Ethernet / WLAN / UMTS / LTE Cat M1 / LTE Cat NB1
- 5 Fieldgate FXA42
- 6 Power supply 24 V<sub>DC</sub>
- 7 4 x analog input 4 to 20 mA (passive), 4-wire
- 8 4 x analog input 4 to 20 mA (active), 2-wire (loop powered)
- 9 Measuring device power supply

## Configuration with a digital input

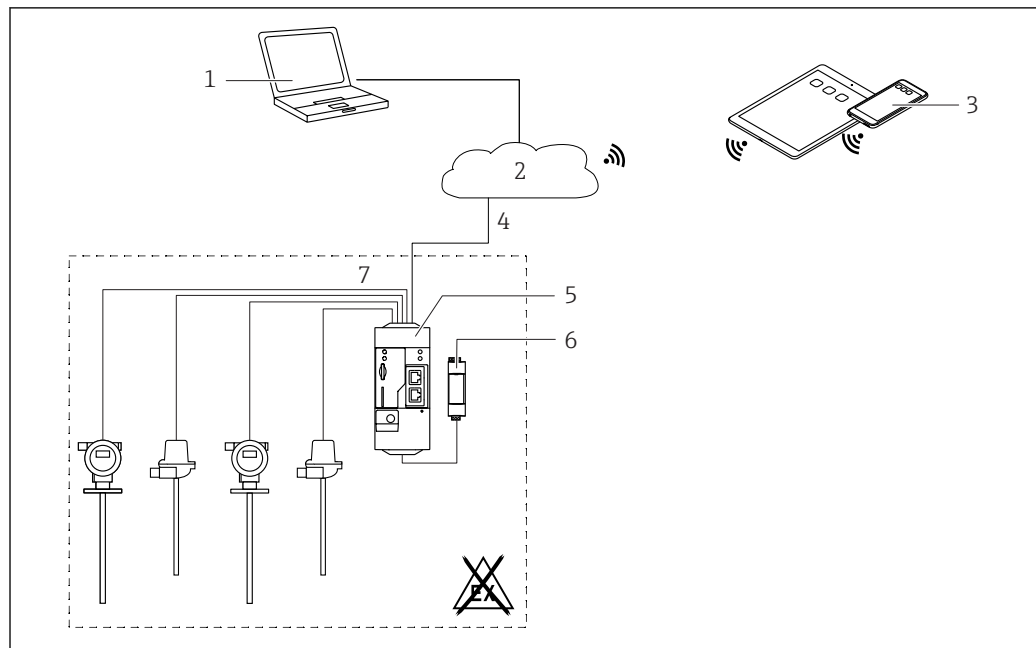

A0030921

3 System architecture of a Fieldgate FXA42 with a digital input

- 1 SupplyCare Enterprise / SupplyCare Hosting (via Web browser)
- 2 Internet / LAN
- 3 SupplyCare Enterprise / SupplyCare Hosting on mobile devices (via Web browser)
- 4 Ethernet / WLAN / UMTS / LTE Cat M1 / LTE Cat NB1
- 5 Fieldgate FXA42
- 6 Power supply 24 V<sub>DC</sub>
- 7 4 x digital input and auxiliary voltage output 24 V<sub>DC</sub>

Configuration with a pulse counter

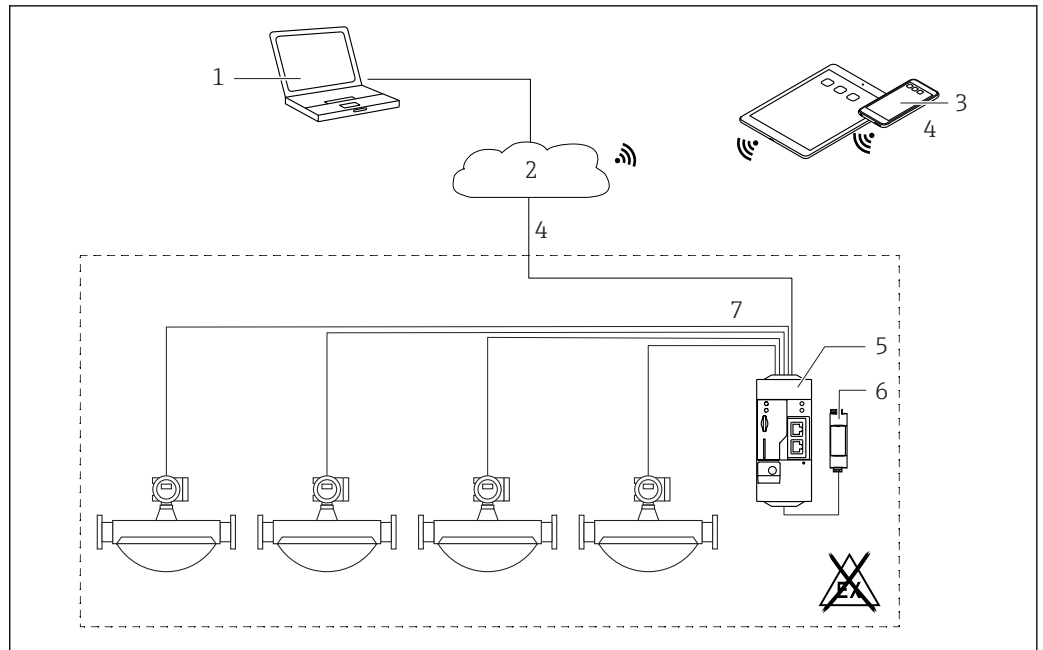

A0030922

4 System architecture of a Fieldgate FXA42 with a pulse counter

- 1 SupplyCare Enterprise / SupplyCare Hosting (via Web browser)
- 2 Internet / LAN
- 3 SupplyCare Enterprise / SupplyCare Hosting on mobile devices (via Web browser)
- 4 Ethernet / WLAN / UMTS / LTE Cat M1 / LTE Cat NB1
- 5 Fieldgate FXA42
- 6 Power supply 24 V<sub>DC</sub>
- 7 4 x digital input with pulse counter

## Configuration with Modbus TCP

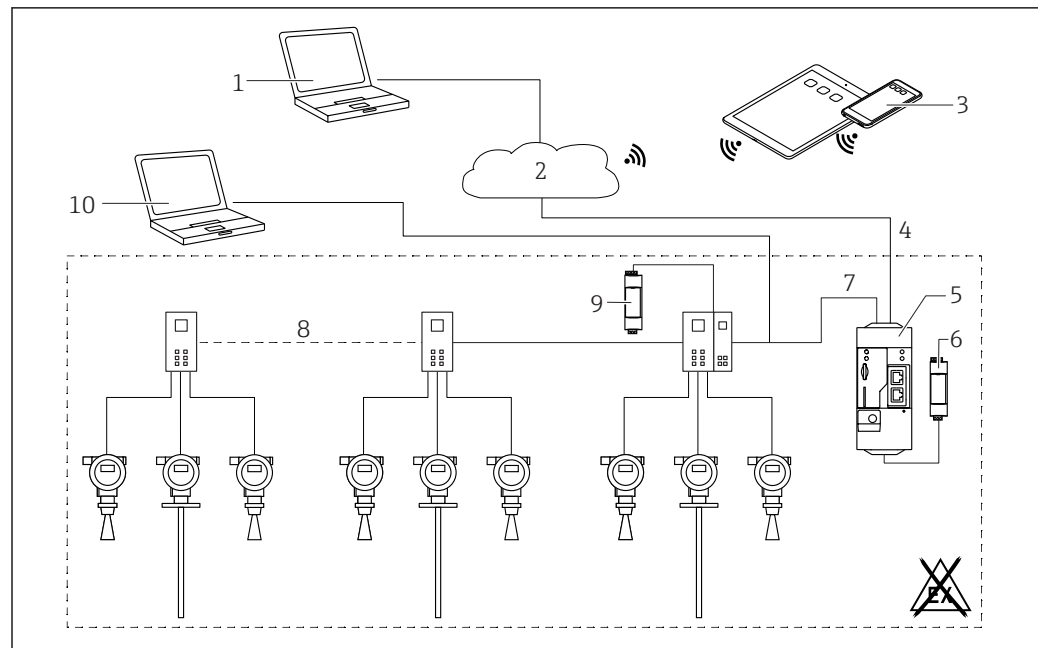

A0034272

5 System architecture of a Fieldgate FXA42 with a HART point-to-point multiplexer

- 1 SupplyCare Enterprise / SupplyCare Hosting (via Web browser)
- 2 Internet / LAN
- 3 SupplyCare Enterprise / SupplyCare Hosting on mobile devices (via Web browser)
- 4 Ethernet / WLAN / UMTS / LTE Cat M1 / LTE Cat NB1
- 5 Fieldgate FXA42
- 6 Power supply 24 V<sub>DC</sub>
- 7 Modbus TCP via Ethernet as server/client
- 8 Phoenix Contact multiplexer from Modbus TCP to HART point-to-point. 1 head module and up to 5 extension modules are possible. Extension modules for 4 or 8 HART channels are possible
- 9 External power supply
- 10 FieldCare tunneling via Phoenix Contact multiplexer

**i** Modbus TCP can be operated as a server and as a client at the Ethernet connection of the Fieldgate FXA42.

**i** When operated as a Modbus client, up to 32 devices and 256 values can be defined. As values can become arrays when reading and writing several registers or coils, the following limit applies: The number of all scalar (non-array) values plus the size of all arrays must not exceed 512.

## Configuration with Modbus TCP

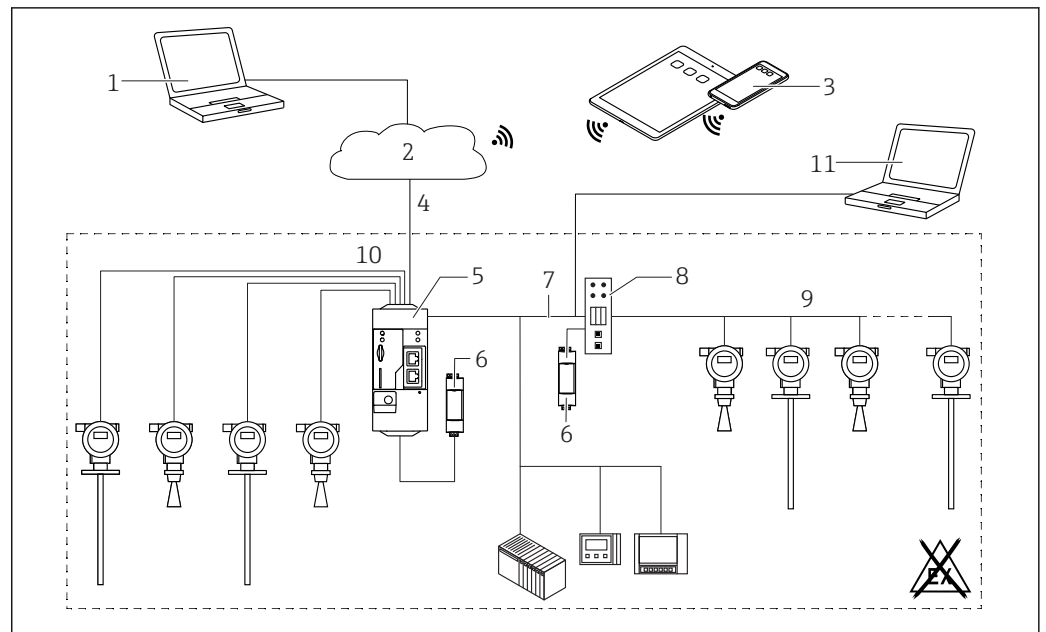

**6** System architecture of a Fieldgate FXA42 with Modbus TCP

- 1 SupplyCare Enterprise / SupplyCare Hosting (via Web browser)
- 2 Internet / LAN
- 3 SupplyCare Enterprise / SupplyCare Hosting on mobile devices (via Web browser)
- 4 Ethernet / WLAN / UMTS / LTE Cat M1 / LTE Cat NB1
- 5 Fieldgate FXA42
- 6 Power supply 24 V<sub>DC</sub>
- 7 Modbus TCP via Ethernet as server/client
- 8 HG1 Plus converter from Modbus to HART Multidrop
- 9 HART Multidrop (maximum 7 devices, depending on the power demand)
- 10 4 x analog input 4 to 20 mA (2-wire / 4-wire)
- 11 FieldCare tunneling via HG1 Plus
- 12 Measuring device power supply

**i** Modbus TCP can be operated as a server or client at the Ethernet connection of the Fieldgate FXA42.

## Configuration with HART Multidrop via Modbus TCP

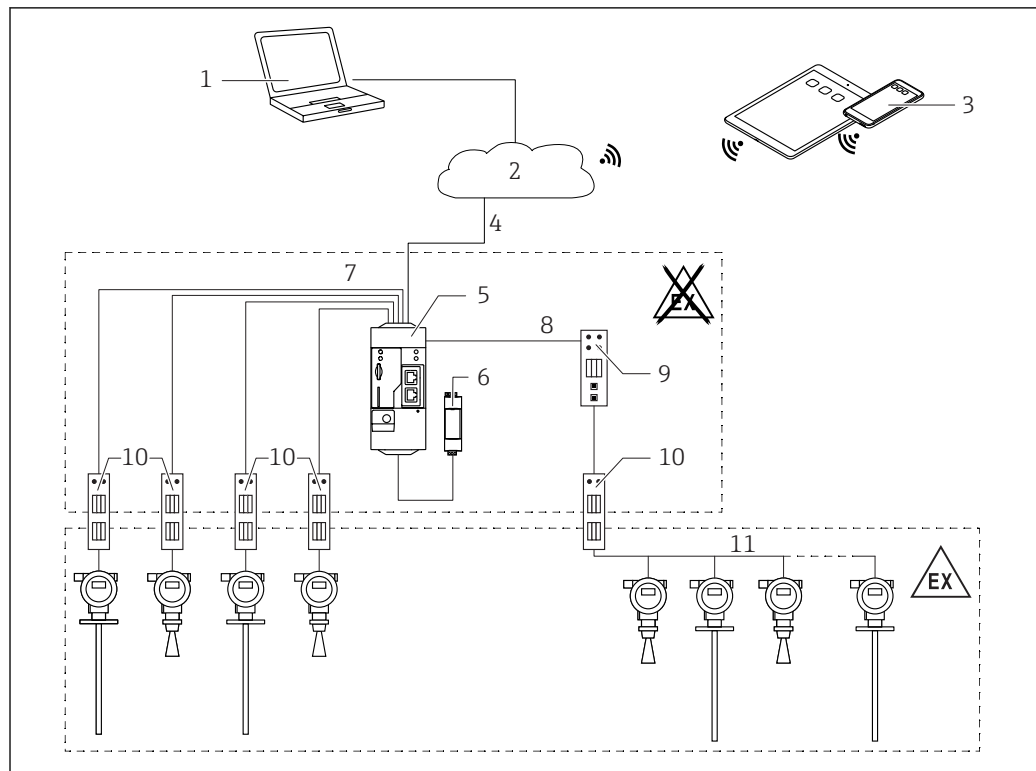

A0030925

 7 System architecture of a Fieldgate FXA42 with HART Multidrop

- 1 SupplyCare Enterprise / SupplyCare Hosting (via Web browser)
- 2 Internet / LAN
- 3 SupplyCare Enterprise / SupplyCare Hosting on mobile devices (via Web browser)
- 4 Ethernet / WLAN / UMTS / LTE Cat M1 / LTE Cat NB1
- 5 Fieldgate FXA42
- 6 Power supply 24 V<sub>DC</sub>
- 7 4 x analog input 4 to 20 mA (2-wire / 4-wire)
- 8 HG1 Plus converter from Modbus to HART Multidrop
- 9 Converter from Modbus to HART Multidrop
- 10 Barrier
- 11 HART Multidrop

 Modbus TCP can be operated as a server or client at the Ethernet connection of the Fieldgate FXA42.

If an appropriate communication barrier is used (→ ) 7), then the measuring devices can also be operated in the hazardous area.

## Configuration with Modbus RS485

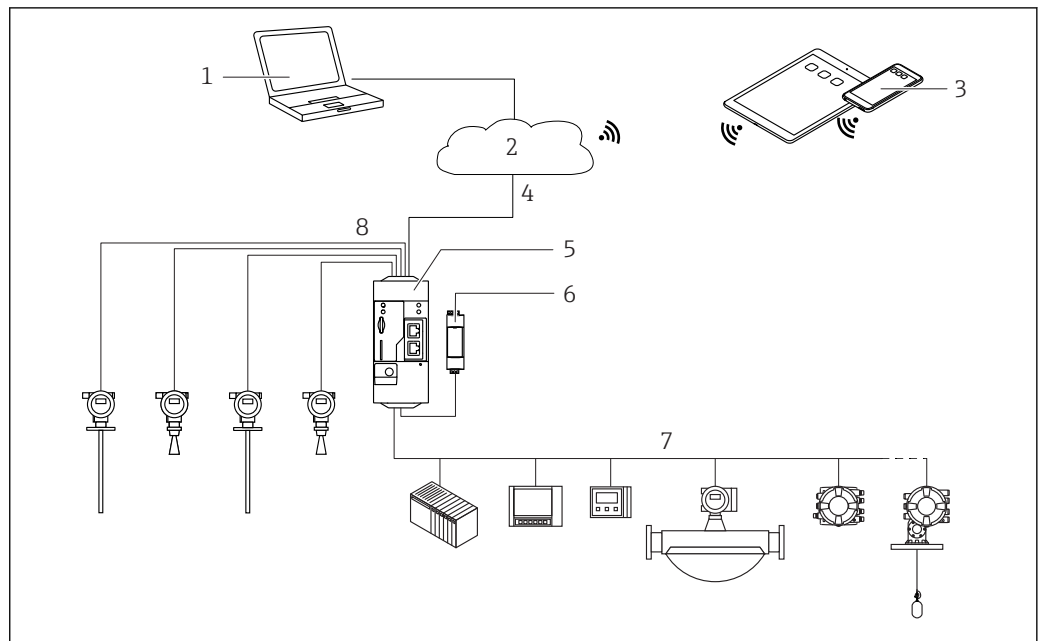

A0030923

**8** System architecture of a Fieldgate FXA42 with Modbus RS485

- 1 SupplyCare Enterprise / SupplyCare Hosting (via Web browser)
- 2 Internet / LAN
- 3 SupplyCare Enterprise / SupplyCare Hosting on mobile devices (via Web browser)
- 4 Ethernet / WLAN / UMTS / LTE Cat M1 / LTE Cat NB1
- 5 Fieldgate FXA42
- 6 Power supply 24 V<sub>DC</sub>
- 7 1 x Modbus RS485 as master or slave
- 8 4 x analog input 4 to 20 mA (2-wire / 4-wire)

**i** The Modbus RS485 connection can be used as either a master or a slave, but cannot act as both simultaneously.

- When operated as a master, up to 32 devices and 256 values can be defined. As values can become arrays when reading and writing several registers or coils, the following limit applies: The number of all scalar (non-array) values plus the size of all arrays must not exceed 512.
- When operated as a slave, up to 128 values can be defined. As values can become arrays when reading and writing several registers or coils, the following limit applies: The number of all scalar (non-array) values plus the size of all arrays must not exceed 512.

# Input

## Terminal assignment

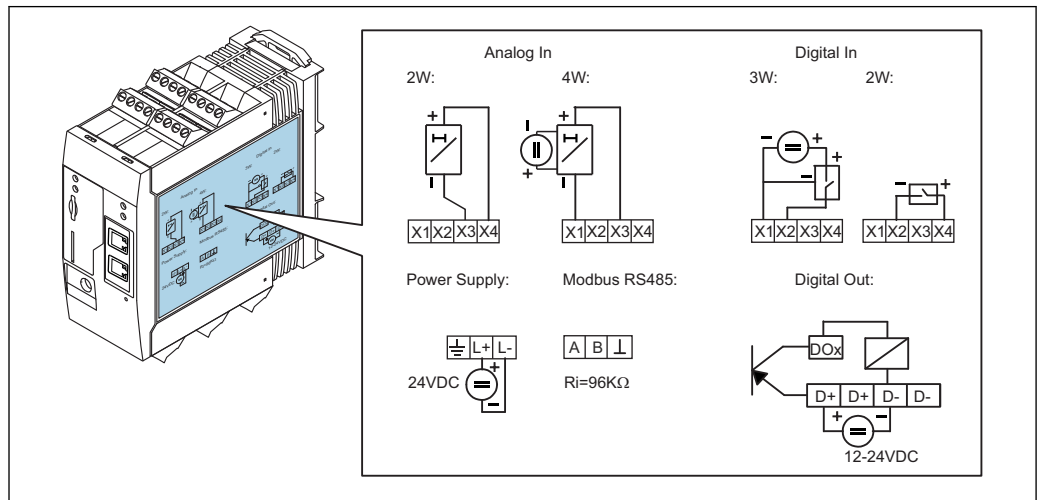

A0031498

9 Labeling on the housing for terminal assignment

**Weight**                      Approx. 300 g (10.6 oz)

**Materials**                      Housing: plastic PC-GF10

**Terminals**                      Plug-in screw terminals, 2.5 mm<sup>2</sup> (14 AWG), 0.1 to 4 mm<sup>2</sup> (30 to 12 AWG), torque 0.5 to 0.6 Nm (0.37 to 0.44 lbf ft)

### 4 to 20 mA analog input

### 4 to 20 mA analog input (2-wire) with auxiliary voltage output

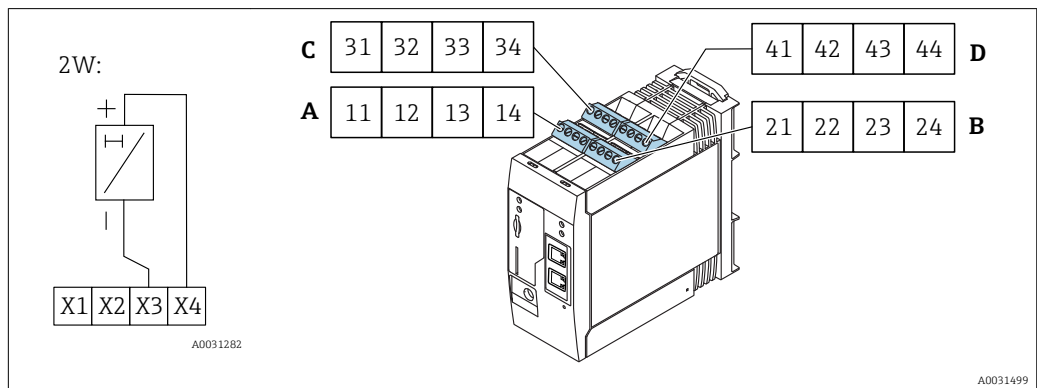

A0031282

A0031499

	Terminal block				Function	Properties
	A	B	C	D		
X1 =	11	21	31	41	4 x GND	
X3 =	13	23	33	43	4 x 4 to 20 mA analog input	Maximum input voltage: 35 V Maximum input current: 22 mA Internal resistance: 250 Ω (suitable for HART communication)
X4 =	14	24	34	44	4 x auxiliary voltage output for transmitter loop power supply	Output voltage: 28 V <sub>DC</sub> (no-load) 26 V <sub>DC</sub> @ 3 mA 20 V <sub>DC</sub> @ 30 mA Output current: max. 160 mA

4 to 20 mA analog input (4-wire)

	Terminal block				Function	Properties
	A	B	C	D		
X1 =	11	21	31	41	4 x GND	
X3 =	13	23	33	43	4 x 4 to 20 mA analog input	Maximum input voltage: 35 V Maximum input current: 22 mA Internal resistance: 250 Ω (suitable for HART communication)

Digital input

Digital input (2-wire) with auxiliary voltage output

	Terminal block				Function	Properties
	A	B	C	D		
X2 =	12	22	32	42	4 x digital input	Input voltage L: < 5 V Input voltage H: > 11 V Input current: < 5 mA Maximum input voltage: 35 V
X4 =	14	24	34	44	4 x auxiliary voltage output to control the digital inputs	Output voltage: 28 V <sub>DC</sub> (no-load) 26 V <sub>DC</sub> @ 3 mA 20 V <sub>DC</sub> @ 30 mA Output current: max. 160 mA

### Digital input (3-wire)

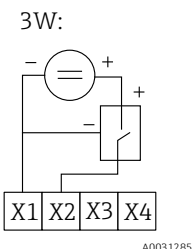

3W:  
A0031285

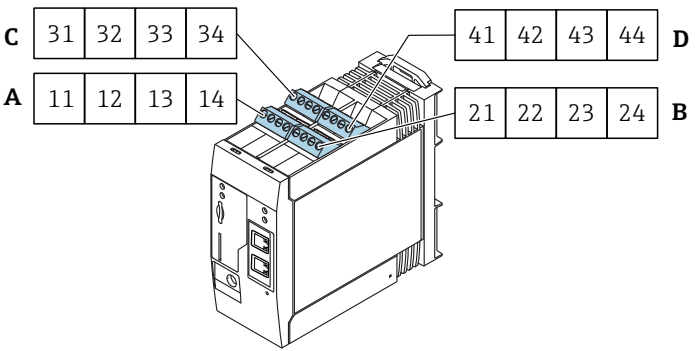

	Terminal block				Function	Properties
	A	B	C	D		
X1 =	11	21	31	41	4 x GND	
X2 =	12	22	32	42	4 x digital input	Input voltage L: < 5 V Input voltage H: > 11 V Input current: < 5 mA Maximum input voltage: 35 V

### Output

#### Digital output

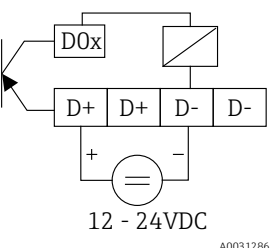

12 - 24VDC  
A0031286

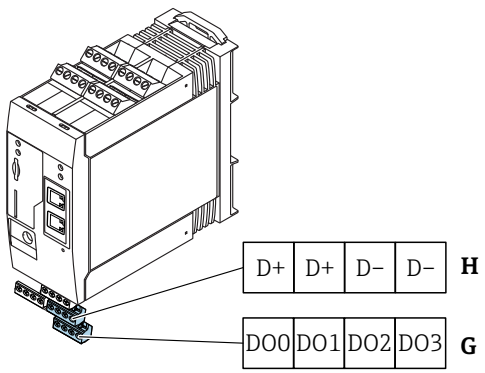

Terminal block		G	Properties			
<table border="1" style="display: inline-table; border-collapse: collapse;"> <tr> <td>DO0</td> <td>DO1</td> <td>DO2</td> <td>DO3</td> </tr> </table> Digital output	DO0	DO1	DO2	DO3	DO0	High-side driver, sourcing, DC-PNP. Output current: 500 mA
	DO0	DO1	DO2	DO3		
	DO1					
	DO2					
DO3						
Terminal block		H	Properties			
<table border="1" style="display: inline-table; border-collapse: collapse;"> <tr> <td>D+</td> <td>D+</td> <td>D-</td> <td>D-</td> </tr> </table> Power supply for digital output <sup>1)</sup>	D+	D+	D-	D-	D+	12 to 24 V <sub>DC</sub>
	D+	D+	D-	D-		
	D+	12 to 24 V <sub>DC</sub>				
	D-	GND				
D-	GND					

1) You may only use power units that ensure safe electrical isolation according to DIN VDE 0570-2-6 and EN61558-2-6 (SELV / PELV or NEC Class 2) and that are designed as limited-energy circuits.

**RS485 serial interface (Modbus)**

- Internal resistance: 96 kΩ
- Protocol: Modbus RTU
- External termination required ( 120 Ω)

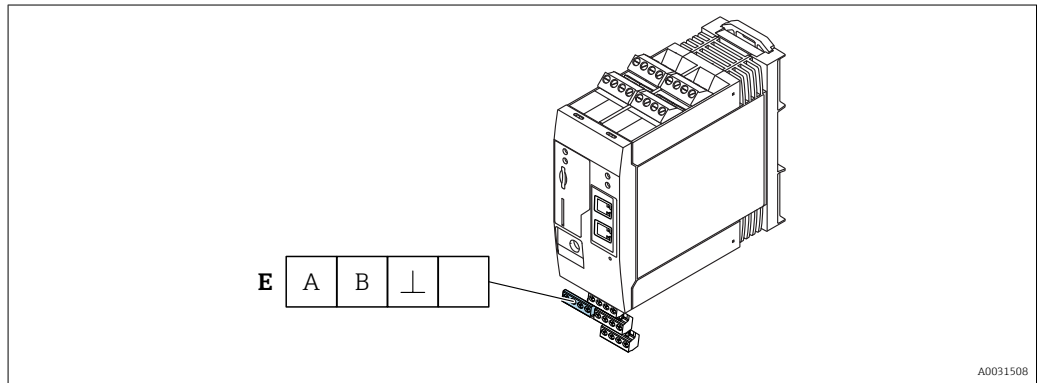

Terminal block	E	Properties				
<table border="1" style="width: 100%;"> <tr> <td style="width: 25%;">A</td> <td style="width: 25%;">B</td> <td style="width: 25%;">⊥</td> <td style="width: 25%;"></td> </tr> </table> <p>Serial interface RS485</p>	A	B	⊥		A	Signal
	A	B	⊥			
	B	Signal				
	⊥	Ground / optional shield connection				
	Not assigned					

## Power supply

**Supply voltage**

**i** The supply voltage is 24 V DC (±20%). You may only use power units that ensure safe electrical isolation according to DIN VDE 0570-2-6 and EN61558-2-6 (SELV / PELV or NEC Class 2) and that are designed as limited-energy circuits.

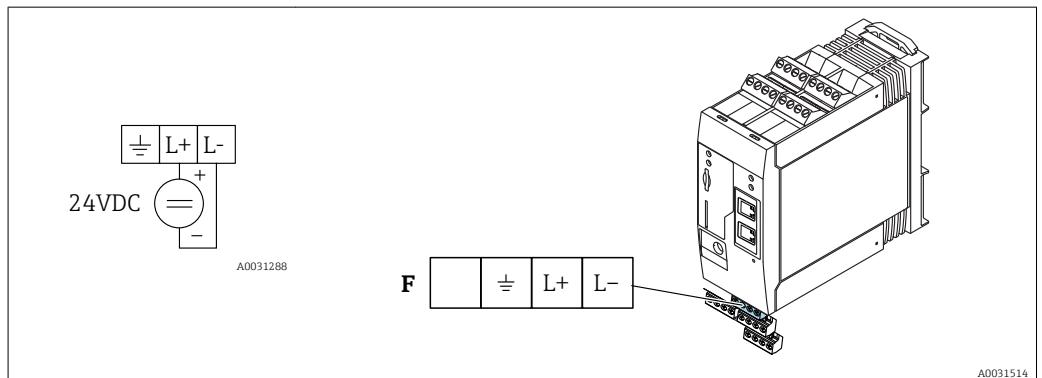

Terminal block	F	Properties				
<table border="1" style="width: 100%;"> <tr> <td style="width: 25%;"></td> <td style="width: 25%;">⊥</td> <td style="width: 25%;">L+</td> <td style="width: 25%;">L-</td> </tr> </table> <p>Power supply for Fieldgate FXA42 <sup>1)</sup></p>		⊥	L+	L-		Not assigned
		⊥	L+	L-		
	⊥	Ground connection				
	L+	24 V <sub>DC</sub>				
L-	GND					

1) You may only use power units that ensure safe electrical isolation according to DIN VDE 0570-2-6 and EN61558-2-6 (SELV / PELV or NEC Class 2) and that are designed as limited-energy circuits.

**Power consumption** < 9 W

**Voltage interruption (IEC 61000-4-29)** 20 ms

## Installation

**Mounting location** The Fieldgate must be housed in a cabinet outside the hazardous area. A protective housing (IP65) must be used if the unit is mounted outdoors.

**Orientation** Vertical or horizontal on DIN rail (HT 35 as per EN 60715).

### Dimensions

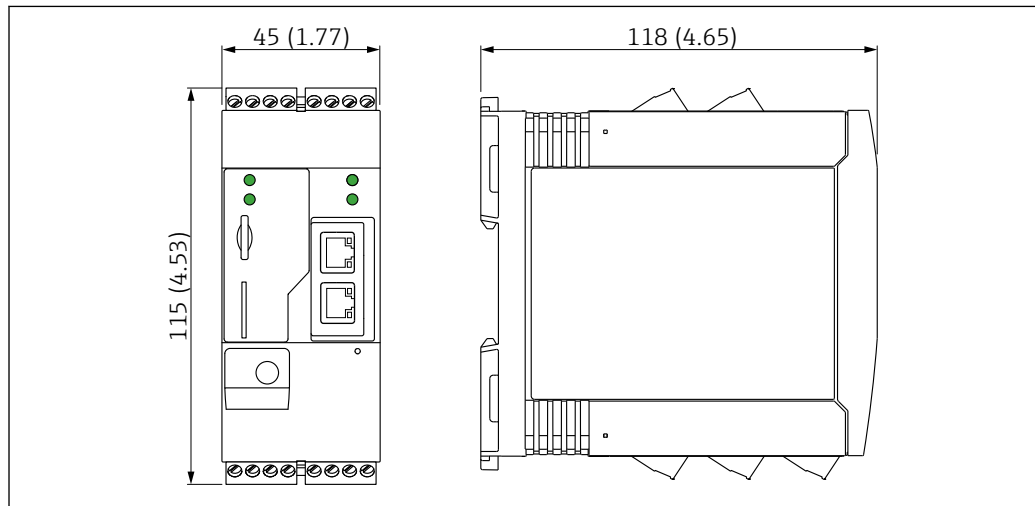

10 Dimensions in mm (in)

### Antenna

The devices require an external antenna for wireless communication via UMTS (2G/3G), LTE Cat M1 and Cat NB1 (2G/4G) and WLAN. The antenna can be purchased as an accessory from Endress+Hauser. The antenna cable is screwed onto the connection on the front of the device. The antenna must be mounted outside the cabinet or field housing. In areas with weak reception, it is advisable to first check the communication before securing the antenna permanently.

Connection: SMA connection.

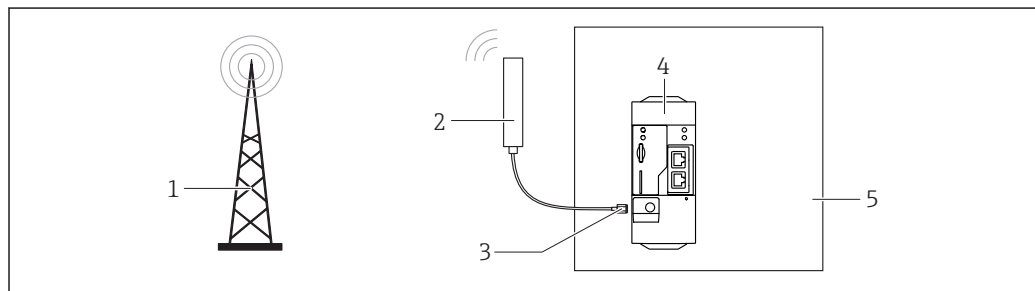

- 1 Mobile communications networks
- 2 Antenna for Fieldgate FXA42
- 3 SMA connection
- 4 Fieldgate FXA42 Ethernet and 2G/3G/4G
- 5 Control cabinet

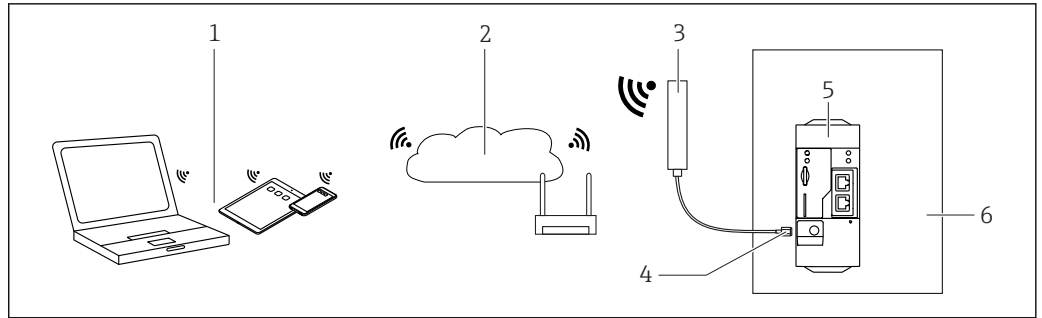

A0031112

- 1 WLAN receivers
- 2 Uplink to Internet or LAN via router
- 3 Antenna for Fieldgate FXA42
- 4 SMA connection
- 5 Fieldgate FXA42 Ethernet and WLAN
- 6 Control cabinet

## Environment

<b>Ambient temperature range</b>	Normal operation (EN 60068-2-14; Nb; 0.5 K/min): -20 to 60 °C (-4 to 140 °F) Side by side installation: -20 to 50 °C (-4 to 122 °F)
<b>Transportation and storage temperature</b>	EN 60068-2-1; Ab; 0.5K/min / EN 60068-2-2; Bb; 0.5K/min: -25 to 85 °C (-13 to 185 °F)
<b>Humidity</b>	EN 60068-2-30; Db; 0.5 K/min: 5 to 85%; non-condensing
<b>Condensation</b>	Not permitted
<b>Climate class</b>	To IEC 60654-1, Class B2
<b>Installation height as per IEC61010-1 Ed.3</b>	Generally up to 2 000 m (6 560 ft) above sea level
<b>Degree of protection</b>	IP20, NEMA1
<b>Shock resistance</b>	DIN EN 60068-2-27: ±15 g; 11 ms
<b>Vibration resistance</b>	EN 60068-2-64 / IEC60068-2-64: 20..2000 Hz 0.01 g <sup>2</sup> /Hz
<b>Electromagnetic compatibility</b>	<ul style="list-style-type: none"> <li>■ Interference immunity: as per IEC 61326, industrial environment</li> <li>■ Interference emissions: as per IEC 61326, Class B</li> </ul>

## Operability

Display elements (device status indicator / LED)

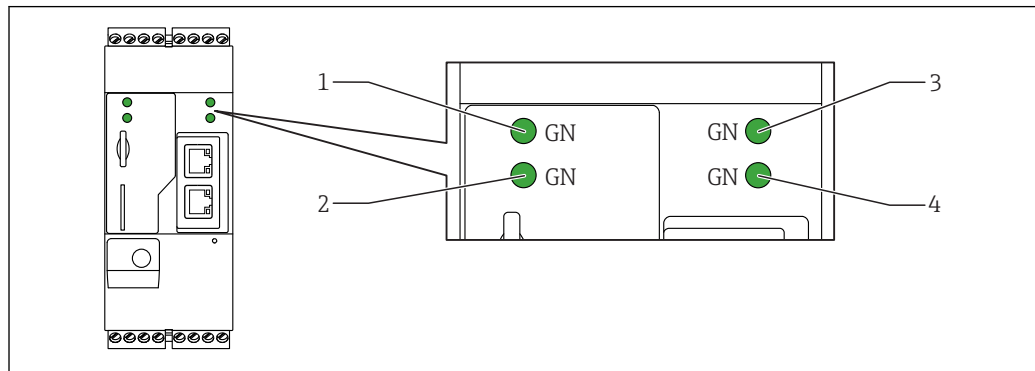

A0030608

- 1 Power
- 2 Modem (mobile communications versions) / WLAN / Ethernet
- 3 Network
- 4 Web-PLC

Identifier	State	Color	Meaning	Comment
Power		Green (GN)	Power supply ON	
Modem		Green (GN)	Power supply for modem ON	Only mobile communications versions
WLAN		Green (GN)	Power supply for WLAN module ON	Only WLAN version
Ethernet		Green (GN)	Power supply for Ethernet interface ON	Only Ethernet version
Network		Green (GN)	Data connection established	Ethernet version: valid fixed IP address configured or DHCP completed successfully
Network			Data connection interrupted	Ethernet version: no valid fixed IP address configured or DHCP not completed successfully
Web-PLC		Green (GN)	Editor program for Web-PLC is enabled	
	2 x	Green (GN)	Manual firmware update completed successfully	
	2 x	Green (GN)	Reset to factory settings (factory reset) confirmed	

Operating elements

**Reset button**

The reset button can be accessed through a small hole in the front (→ 14, 23).

**Card slot**

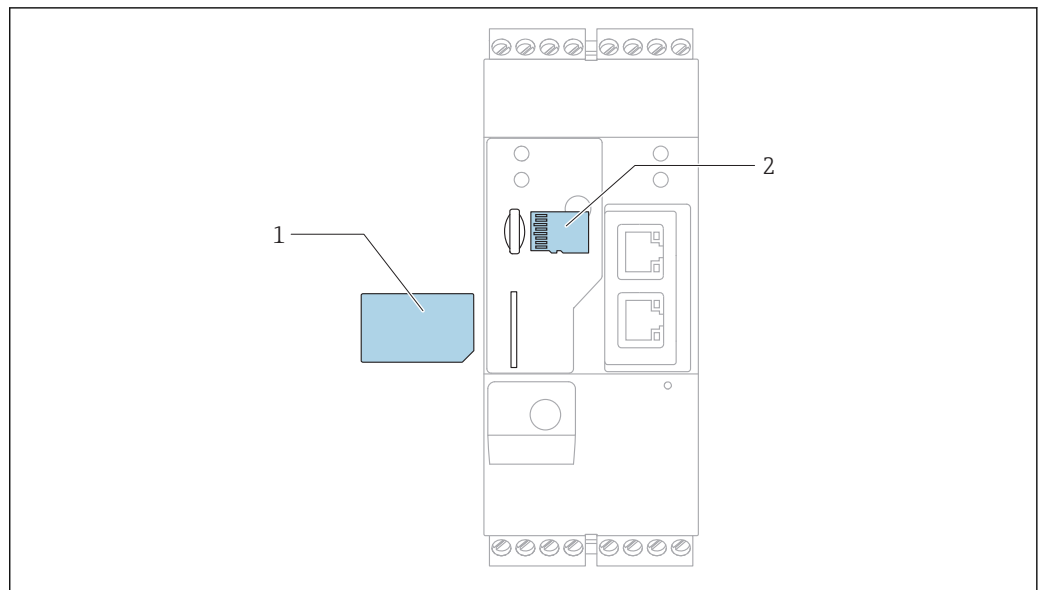

A0030897

- 1 SIM card
- 2 microSD card

**Integrated Web server**

The integrated Web server enables the full control and operation of the Fieldgate and allows users to visualize the current measured values of the connected devices using standard Web browsers. Examples of a few Web pages are provided in the following section.

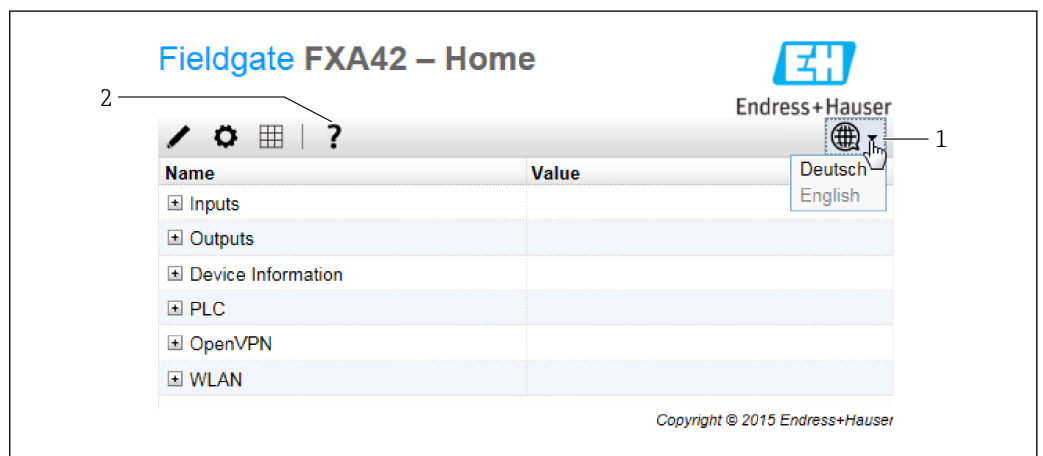

A0030547

11 Home page in the Web browser

- 1 Selecting the language
- 2 Opening the online help

Fieldgate FXA42 – Grid View

Endress+Hauser

State	Name	Value	Unit	Min. Range	Max. Range
LL	Input Analog 0	4.000	mA	4.000 mA	20.000 mA
	Input Analog 1	4.000	mA	4.000 mA	20.000 mA
L	Input Analog 2	4.000		4.000	20.000
	Input Analog 3	4.000	mA	4.000 mA	20.000 mA
	Input Digital 0	0	...	...	...
	Input Digital 1	0	...	...	...
	Input Digital 2	0	...	...	...
	Input Digital 3	0	...	...	...

Copyright © 2015 Endress+Hauser

A0031497

12 Grid view in the Web browser

## Integrated Web-PLC

The Web-PLC is a Web-based graphic editor solution for basic PLC control functions. AND, OR, XOR, FF, TIMER and COUNTER operations are provided for implementing simple PLC functions.

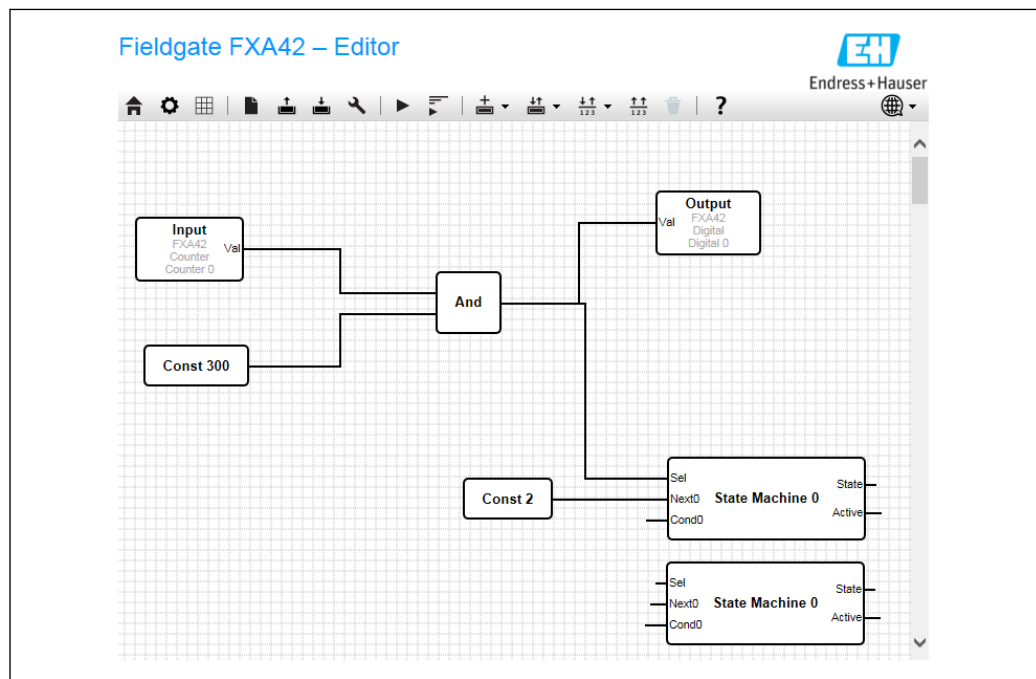

13 Graphic editor for PLC control functions

## Certificates and approvals

### CE mark

The device meets the legal requirements of the applicable EC directives. These are listed in the corresponding EC Declaration of Conformity along with the standards applied.

**RoHS** The measuring system complies with the substance restrictions of the Restriction on Hazardous Substances Directive 2011/65/EU (RoHS 2).

**Other standards and guidelines** Other standards and guidelines that have been considered in the design and development of the device:

- EN 60529  
Degrees of protection provided by enclosures (IP code)
- EN 61010-1  
Safety Requirements for Electrical Equipment for Measurement, Control and Laboratory Use
- IEC/EN 61326  
"Emission in accordance with Class A requirements". Electromagnetic compatibility (EMC requirements).

## Telecommunications approval

---

**Europe** This device meets the requirements of the Radio Equipment Directive (RED) 2014/53/EU.

**USA and Canada** This device complies with Part 15 of the FCC rules.

### Federal Communications Commission Notice

If this equipment does cause harmful interference to radio or television reception, which can be determined by turning the device off and on, the user is encouraged to try to correct the interference by one or more of the following measures:

1. Reorient or relocate the receiving antenna.
2. Increase the separation between the equipment and receiver.
3. Connect the equipment into an outlet on a circuit different from that to which the receiver is connected.

To ensure that the unit complies with current FCC regulations and safety requirements limiting both maximum RF output power and human exposure to radio frequency radiation, use an antenna with a maximum gain of 2 dBi and a separation distance of at least 20 cm must be maintained between the unit's antenna and the body of the user and any nearby persons at all times and in all applications and uses.

### Modifications

The FCC requires the user to be notified that any changes or modifications made to this device that are not expressly approved by Endress+Hauser may void the user's authority to operate the equipment.

### Federal Communications Commission Statement

This device complies with Part 15 of the FCC rules. Operation is subject to the following two conditions:

- (1) This device may not cause harmful interference, and
- (2) This device must accept any interference received, including interference that may cause undesired operation.

### Wireless Notices

In some situations or environments, the use of wireless devices may be restricted. Such restrictions may apply aboard airplanes, in vehicles, in hospitals, near explosives, in hazardous locations, etc. If you are uncertain of the policy that applies to the use of this device, please ask for authorization to use it prior to turning it on.

---

**Other certificates** Other national approvals are available on request.

- **Bulgaria**  
General authorization required for use outdoors and in public.
- **Italy**  
General authorization is required for use outside of own premises.
- **Norway**  
Use can be limited within a 20-km radius of the center of Ny-Alesund.
- **Romania**  
Use as a secondary device; special license required.
- **Latvia**  
A national permit is required for outdoor use of the 2.4 GHz frequency.

## Ordering information

### Product design

Four versions of the Fieldgate FXA42 are available. These versions differ in terms of the device features and data transmission technology.

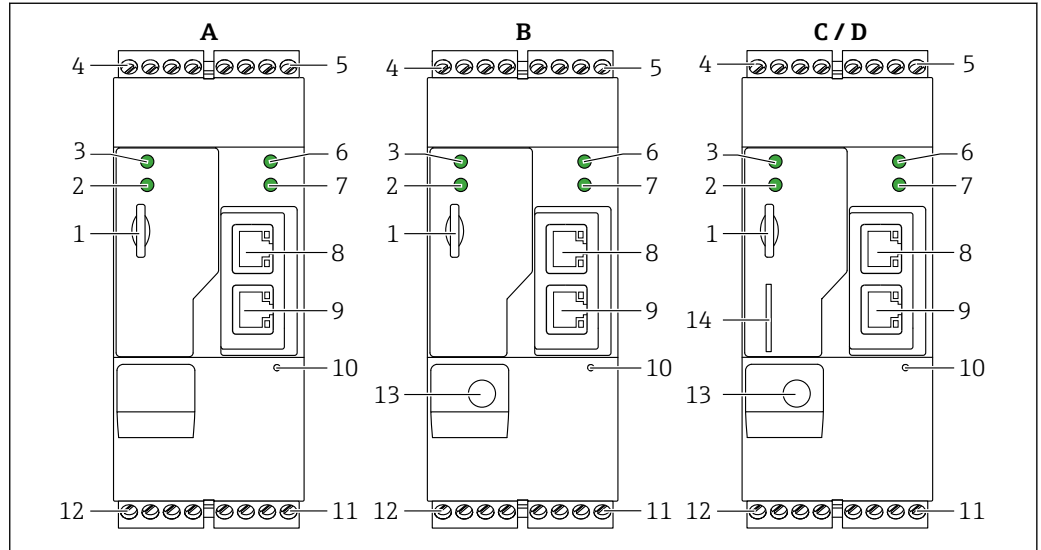

A0030516

14 Fieldgate FXA42 versions and design

- A FXA42-A Ethernet
- B FXA42-B Ethernet and WLAN
- C FXA42-C Ethernet and 2G/3G
- D FXA42-D Ethernet and LTE Cat M1 and Cat NB1 (2G/4G)
- 1 Slot for memory card, card type: microSD
- 2 Status LED for modem / WLAN / Ethernet
- 3 Status LED for supply voltage
- 4, 5 Input modules with analog input, digital input, current source and reference potential
- 6 Status LED for network
- 7 Status LED for Web PLC
- 8, 9 Ethernet connections
- 10 Reset button
- 11 Power supply for Fieldgate FXA42, power supply for digital outputs, digital outputs
- 12 RS-485 serial interface
- 13 Connection for antenna (only WLAN and mobile telecommunications versions)
- 14 Slot for SIM card (only mobile telecommunications versions)

### Supported frequency bands for mobile telecommunications

*FXA42-C: supported frequency bands UMTS (2G/3G)*

2G

Band 2 (1900 MHz), Band 3 (1800 MHz), Band 5 (850 MHz), Band 8 (900 MHz)

3G

Band 1 (2100 MHz), Band 2 (1900 MHz), Band 4 (1700 MHz), Band 5 (850 MHz), Band 6 (800 MHz), Band 8 (900 MHz)

*FXA42-D: supported frequency bands LTE Cat M1 and Cat NB1 (2G/4G)*

2G

Band 2 (1900 MHz), Band 3 (1800 MHz), Band 5 (850 MHz), Band 8 (900 MHz)

4G

Band 1 (2100 MHz), Band 2 (1900 MHz), Band 3 (1800 MHz), Band 4 (AWS 1700 MHz), Band 5 (850 MHz), Band 8 (900 MHz), Band 12 (700 MHz), Band 13 (700 MHz), Band 18 (800 MHz), Band 19 (800 MHz), Band 20 (800 MHz), Band 26 (850 MHz), Band 28 (700 MHz)

## Ordering information

Detailed ordering information is available from the following sources:

- In the Product Configurator on the Endress+Hauser website: [www.endress.com](http://www.endress.com) -> Click "Corporate" -> Select your country -> Click "Products" -> Select the product using the filters and search field -> Open product page -> The "Configure" button to the right of the product image opens the Product Configurator.
- From your Endress+Hauser Sales Center: [www.addresses.endress.com](http://www.addresses.endress.com)



### Product Configurator - the tool for individual product configuration

- Up-to-the-minute configuration data
- Depending on the device: Direct input of measuring point-specific information such as measuring range or operating language
- Automatic verification of exclusion criteria
- Automatic creation of the order code and its breakdown in PDF or Excel output format
- Ability to order directly in the Endress+Hauser Online Shop

## Accessories

### Device-specific accessories

Power unit

Power unit for power supply

Material number: 71327426

Antenna

Antenna with SMA connection for mobile telecommunications or WLAN operation

Material number: 71327395

SD card (card type: microSD)

On request

Communication modules

- Datexel DAT8017-I server unit: analog to Modbus TCP converter  
Material number: 71375710
- Rapsystems HG1 Plus: HART to Modbus gateway  
Material number: 71327424
- Phoenix Contact: HART Ethernet multiplexer head module  
Material number: 71363548
- Phoenix Contact: 4-channel HART extension module  
Material number: 71363561
- Phoenix Contact: 8-channel HART extension module  
Material number: 71363582

### Communication-specific accessories

#### SupplyCare Enterprise SCE30B

Inventory management software that displays the level, volume, mass, temperature, pressure, density or other parameters of tanks. The parameters are recorded and transmitted by means of gateways like Fieldgate FXA42, Connect Sensor FXA30B or other gateway types.

This Web-based software is installed on a local server and can also be visualized and operated with mobile terminals such as a smartphone or tablet.



For details, see Technical Information TI01228S and Operating Instructions BA00055S

#### SupplyCare Hosting SCH30

Inventory management software that displays the level, volume, mass, temperature, pressure, density or other parameters of tanks. The parameters are recorded and transmitted by means of gateways like Fieldgate FXA42, Connect Sensor FXA30B or other gateway types.

SupplyCare Hosting is offered as a hosting service (Software as a Service, SaaS). In the Endress+Hauser portal, the user is provided with the data over the Internet.



For details, see Technical Information TI01229S and Operating Instructions BA00050S

## Supplementary documentation

The following document types are available in the Download Area of the Endress+Hauser website: [www.endress.com](http://www.endress.com) → Download:

**Standard documentation**

The following documentation is available for the Fieldgate FXA42:

- Brief Operating Instructions  
Document code: KA01246S
- Operating Instructions  
Document code: BA01778S

## Registered trademarks

**Modbus®**

Registered trademark of SCHNEIDER AUTOMATION, INC.

**Microsoft®**

Registered trademark of the Microsoft Corporation, Redmond, Washington, USA

---

---



71487512

[www.addresses.endress.com](http://www.addresses.endress.com)

---