

7102

Micro-Bath

User's Guide

LIMITED WARRANTY AND LIMITATION OF LIABILITY

Each Fluke product is warranted to be free from defects in material and workmanship under normal use and service. The warranty period is one year and begins on the date of shipment. Parts, product repairs, and services are warranted for 90 days. This warranty extends only to the original buyer or end-user customer of a Fluke authorized reseller, and does not apply to fuses, disposable batteries, or to any product which, in Fluke's opinion, has been misused, altered, neglected, contaminated, or damaged by accident or abnormal conditions of operation or handling. Fluke warrants that software will operate substantially in accordance with its functional specifications for 90 days and that it has been properly recorded on non-defective media. Fluke does not warrant that software will be error free or operate without interruption.

Fluke authorized resellers shall extend this warranty on new and unused products to end-user customers only but have no authority to extend a greater or different warranty on behalf of Fluke. Warranty support is available only if product is purchased through a Fluke authorized sales outlet or Buyer has paid the applicable international price. Fluke reserves the right to invoice Buyer for importation costs of repair/replacement parts when product purchased in one country is submitted for repair in another country.

Fluke's warranty obligation is limited, at Fluke's option, to refund of the purchase price, free of charge repair, or replacement of a defective product which is returned to a Fluke authorized service center within the warranty period.

To obtain warranty service, contact your nearest Fluke authorized service center to obtain return authorization information, then send the product to that service center, with a description of the difficulty, postage and insurance prepaid (FOB Destination). Fluke assumes no risk for damage in transit. Following warranty repair, the product will be returned to Buyer, transportation prepaid (FOB Destination). If Fluke determines that failure was caused by neglect, misuse, contamination, alteration, accident, or abnormal condition of operation or handling, including overvoltage failures caused by use outside the product's specified rating, or normal wear and tear of mechanical components, Fluke will provide an estimate of repair costs and obtain authorization before commencing the work. Following repair, the product will be returned to the Buyer transportation prepaid and the Buyer will be billed for the repair and return transportation charges (FOB Shipping Point).

THIS WARRANTY IS BUYER'S SOLE AND EXCLUSIVE REMEDY AND IS IN LIEU OF ALL OTHER WARRANTIES, EXPRESS OR IMPLIED, INCLUDING BUT NOT LIMITED TO ANY IMPLIED WARRANTY OF MERCHANTABILITY OR FITNESS FOR A PARTICULAR PURPOSE. FLUKE SHALL NOT BE LIABLE FOR ANY SPECIAL, INDIRECT, INCIDENTAL, OR CONSEQUENTIAL DAMAGES OR LOSSES, INCLUDING LOSS OF DATA, ARISING FROM ANY CAUSE OR THEORY.

Since some countries or states do not allow limitation of the term of an implied warranty, or exclusion or limitation of incidental or consequential damages, the limitations and exclusions of this warranty may not apply to every buyer. If any provision of this Warranty is held invalid or unenforceable by a court or other decision-maker of competent jurisdiction, such holding will not affect the validity or enforceability of any other provision.

Fluke Corporation
P.O. Box 9090
Everett, WA 98206-9090
U.S.A.

Fluke Europe B.V.
P.O. Box 1186
5602 BD Eindhoven
The Netherlands

11/99

To register your product online, visit register.fluke.com

Table of Contents

Chapter	Title	Page
1	Before You Start	1-1
	1.1 Symbols Used	1-1
	1.2 Safety Information	1-2
	1.2.1 Warnings	1-2
	1.2.2 Cautions	1-4
	1.3 Authorized Service Centers	1-5
2	Introduction	2-1
3	Specifications and Environmental Conditions	3-1
	3.1 Specifications	3-1
	3.2 Environmental Conditions	3-2
4	Quick Start	4-1
	4.1 Unpacking	4-1
	4.2 Setup	4-2
	4.3 Power	4-2
	4.4 Setting the Temperature	4-2
5	Installation	5-1
	5.1 Bath Environment	5-1
	5.2 "Dry-out" Period	5-1
	5.3 Bath Preparation and Filling	5-2
	5.4 Power	5-2
6	Bath Use	6-1
	6.1 General	6-1
	6.2 Comparison Calibration	6-2
	6.3 Calibration of Multiple Probes	6-2

7	Parts and Controls	7-1
	7.1 Front Panel.....	7-1
	7.2 Back Panel	7-2
	7.3 Accessories	7-3
	7.3.1 Transport/Pour Access Lid	7-3
	7.3.2 Access Cover (Optional).....	7-4
	7.3.3 Probe Basket.....	7-4
	7.3.4 Stir Bar.....	7-4
	7.3.5 Well Extender (Optional)	7-4
8	General Operation	8-1
	8.1 Changing Display Units	8-1
	8.2 Switching to 230V Operation.....	8-1
	8.3 Bath Fluid	8-1
	8.3.1 Temperature Range	8-2
	8.3.2 Viscosity	8-2
	8.3.3 Specific Heat	8-2
	8.3.4 Thermal Conductivity.....	8-2
	8.3.5 Thermal Expansion.....	8-2
	8.3.6 Electrical Resistivity.....	8-3
	8.3.7 Fluid Lifetime	8-3
	8.3.8 Safety.....	8-3
	8.3.9 Cost	8-3
	8.3.10 Commonly Used Fluids	8-3
	8.3.10.1 Water (Distilled)	8-4
	8.3.10.2 Mineral Oil	8-4
	8.3.10.3 Silicone Oil (Dow Corning 200.05, 200.10, 200.20)	8-4
	8.3.11 Fluid Characteristics Charts	8-4
	8.3.11.1 Limitations and Disclaimer.....	8-5
	8.3.11.2 About the Graph	8-6
	8.4 Stirring	8-7
	8.5 Power	8-8
	8.6 Thermal Electric Devices (TED).....	8-8
	8.7 Fluid Drain	8-9
	8.8 Temperature Controller	8-9
9	Controller Operation	9-1
	9.1 Well Temperature	9-1
	9.2 Temperature Set-point.....	9-1
	9.2.1 Programmable Set-points.....	9-1
	9.2.2 Set-point Value	9-3
	9.2.3 Temperature Scale Units.....	9-3
	9.3 Scan	9-4
	9.3.1 Scan Control.....	9-4
	9.3.2 Scan Rate.....	9-4
	9.4 Temperature Display Hold.....	9-4
	9.4.1 Hold Temperature Display.....	9-5
	9.4.2 Mode Setting	9-5
	9.4.3 Switch Wiring.....	9-5
	9.4.4 Switch Test Example.....	9-6
	9.5 Secondary Menu	9-6
	9.6 Thermal Electric Device (TED).....	9-6
	9.7 Proportional Band.....	9-7
	9.8 Controller Configuration	9-8

9.8.1	Operating Parameters	9-8
9.8.1.1	High Limit	9-9
9.8.1.2	Stir Speed	9-9
9.8.2	Serial Interface Parameters	9-9
9.8.2.1	Baud Rate	9-10
9.8.2.2	Sample Period	9-10
9.8.2.3	Duplex Mode	9-10
9.8.2.4	Linefeed	9-11
9.8.3	Calibration Parameters	9-11
9.8.3.1	R0	9-12
9.8.3.2	ALPHA	9-12
9.8.3.3	DELTA	9-12
9.8.3.4	C0 and CG	9-12
9.8.3.5	rCAL	9-12
10	Digital Communication Interface	10-1
10.1	Serial Communications	10-2
10.1.1	Wiring	10-2
10.1.2	Setup	10-2
10.1.2.1	Baud Rate	10-2
10.1.2.2	Sample Period	10-3
10.1.2.3	Duplex Mode	10-3
10.1.2.4	Linefeed	10-3
10.1.3	Serial Operation	10-3
10.2	Interface Commands	10-3
11	Test Probe Calibration	11-1
11.1	Calibrating a Single Probe	11-1
11.2	Stabilization and Accuracy	11-2
12	Calibration Procedure	12-1
12.1	Calibration Points	12-1
12.2	Calibration Procedure	12-2
12.2.1	Compute DELTA	12-2
12.2.2	Compute R0 & ALPHA	12-3
12.2.3	Accuracy & Repeatability	12-3
13	Maintenance	13-1
14	Troubleshooting	14-1
14.1	Troubleshooting Problems, Possible Causes, and Solutions	14-1
14.2	Comments	14-4
14.2.1	EMC Directive	14-4
14.2.2	Low Voltage Directive (Safety)	14-4

List of Tables

Table	Title	Page
1.	International Electrical Symbols	1-1
2.	Specifications	3-1
3.	Table of Various Bath Fluids	8-5
4.	Nominal Stirrer Motor SettingsWith Different Liquids	8-8
5.	Controller Communications Commands.....	10-4

List of Figures

Figure	Title	Page
1.	7102 Front Panel.....	7-1
2.	7102 Back Panel and Bottom.....	7-2
3.	Bath Lids and Lid Parts	7-3
4.	Probe Basket.....	7-4
5.	Stir Bar	7-4
6.	Chart of Various Bath Fluids	8-6
7.	Controller Operation Flowchart	9-2
8.	Serial Cable Wiring.....	10-2

Chapter 1 Before You Start

1.1 Symbols Used

Table 1 lists the International Electrical Symbols. Some or all of these symbols may be used on the instrument or in this manual.

Table 1. International Electrical Symbols

Symbol	Description
	AC (Alternating Current)
	AC-DC
	Battery
	CE Complies with European Union directives
	DC
	Double Insulated
	Electric Shock
	Fuse
	PE Ground
	Hot Surface (Burn Hazard)
	Read the User's Guide (Important Information)
	Off
	On
	Canadian Standards Association
CATII	OVERVOLTAGE (Installation) CATEGORY II, Pollution Degree 2 per IEC1010-1 refers to the level of Impulse Withstand Voltage protection provided. Equipment of OVERVOLTAGE CATEGORY II is energy-consuming equipment to be supplied from the fixed installation. Examples include household, office, and laboratory appliances.
	C-TICK Australian EMC mark
	The European Waste Electrical and Electronic Equipment (WEEE) Directive (2002/96/EC) mark.

1.2 Safety Information

Use this instrument only as specified in this manual. Otherwise, the protection provided by the instrument may be impaired.

The following definitions apply to the terms “Warning” and “Caution”.

- “Warning” identifies conditions and actions that may pose hazards to the user.
- “Caution” identifies conditions and actions that may damage the instrument being used.

1.2.1 Warnings

Warnings

To avoid personal injury, follow these guidelines.

- **Disclaimer: Hart Scientific manufactures instruments for the purpose of temperature calibration. Instruments used for applications other than calibration are used at the discretion and sole responsibility of the customer. Hart Scientific cannot accept any responsibility for the use of instruments for any application other than temperature calibration.**

GENERAL

- **DO NOT install an access cover without holes onto a bath that is energized. Dangerous pressures may result from fluids vaporizing.**
- **DO NOT use the instrument for any application other than calibration work. The instrument was designed for temperature calibration. Any other use of the unit may cause unknown hazards to the user.**
- **DO NOT use the unit in environments other than those listed in the user's guide. Completely unattended operation is not recommended.**
- **DO NOT install access cover without holes onto a bath that is energized. Dangerous pressures may result from fluids vaporizing.**
- **Follow all safety guidelines listed in the user's manual.**
- **Calibration Equipment should only be used by Trained Personnel.**
- **If this equipment is used in a manner not specified by the manufacturer, the protection provided by the equipment may be impaired or safety hazards may arise.**
- **Inspect the instrument for damage before each use. DO NOT use the instrument if it appears damaged or operates abnormally.**

- Before initial use, or after transport, or after storage in humid or semi-humid environments, or anytime the instrument has not been energized for more than 10 days, the instrument needs to be energized for a “dry-out” period of 2 hours before it can be assumed to meet all of the safety requirements of the IEC 61010-1. If the product is wet or has been in a wet environment, take necessary measures to remove moisture prior to applying power such as storage in a low humidity temperature chamber operating at 50 °C for 4 hours or more.
- The instrument is intended for indoor use only.
- Lift the instrument by the handle provided to move the instrument. DO NOT move the instrument until the display reads less than 25 °C (77 °F) and the unit has been drained or the Transport Lid installed.

BURN HAZARD

- ALWAYS ensure the instrument is COOL before closing the instrument for storage.
- DO NOT touch the well access surface of the unit.
- DO NOT mix water and oil when exceeding temperatures of 90 °C (194 °F).
- DO NOT mix water and oil when exceeding temperatures of 90 °C (194 °F). The temperature of the well access is the same as the actual temperature shown on the display, e.g. if the unit is set at 125 °C and the display reads 125 °C, the well is at 125 °C.
- Ensure the power cord is positioned in such a way as it cannot contact hot surfaces or temperature probes. Always inspect power cord before use for any damage to the insulation due to contact with hot surfaces, cuts or abrasions.
- The top sheet metal of the instrument may exhibit extreme temperatures for areas close to the well access.
- DO NOT turn off the unit at temperatures higher than 100 °C. This could create a hazardous situation. Select a set-point less than 100 °C and allow the unit to cool before turning it off.
- DO NOT remove the fluid at high temperatures. The fluid will be the same temperature as the display temperature.
- DO NOT operate near flammable materials. Extreme temperatures could ignite the flammable material.
- Use of this instrument at HIGH TEMPERATURES for extended periods of time requires caution.

ELECTRICAL HAZARD

- These guidelines must be followed to ensure that the safety mechanisms in this instrument will operate properly. This instrument must be plugged into an AC only electric outlet as listed in Section 3.1, Specifications. The power cord of the instrument is equipped with a three-pronged grounding plug for your protection against electrical shock hazards. It must be plugged directly into a properly grounded three-prong receptacle. The receptacle must be installed in accordance with local codes and ordinances or adapter plug. **DO NOT** use an extension cord. Consult a qualified electrician. Always inspect the power cord before use for any damage to the insulation due to contact with hot surfaces, cuts or abrasions.
- The instrument is equipped with operator accessible fuses. If a fuse blows, it may be due to a power surge or failure of a component. Replace the fuse once. If the fuse blows a second time, it is likely caused by failure of a component part. If this occurs, contact a Hart Scientific Authorized Service Center. Always replace the fuse with one of the same rating, voltage, and type. Never replace the fuse with one of a higher current rating.
- Always replace the power cord with an approved cord of the correct rating and type. If you have questions, contact an Authorized Service Center (see Section 1.3).
- High voltage is used in the operation of this equipment. Severe injury or death may result if personnel fail to observe the safety precautions.

1.2.2 Cautions

Cautions

To avoid possible damage to the instrument, follow these guidelines.

- Always operate this instrument at room temperatures listed in Section 3.2, Environmental Conditions. Allow sufficient air circulation by leaving at least 6 inches (15 cm) of clearance around the instrument.
- Overhead clearance is required. **DO NOT** place this instrument under a cabinet or other structure.
- Never introduce any foreign material into the well.
- **DO NOT** change the values of the calibration constants from the factory set values. The correct setting of these parameters is important to the safety and proper operation of the unit.
- **DO NOT** slam the probe stems into the well. This type of action can cause a shock to the sensor and affect the calibration.
- **DO** use a ground fault interrupt device.

- **DO NOT** operate this instrument in an excessively wet, oily, dusty, or dirty environment.
- The unit is a precision instrument. Although it has been designed for optimum durability and trouble free operation, it must be handled with care.
- Most probes have handle temperature limits. Be sure that the probe handle temperature limit is not exceeded in the air above the instrument.
- The instrument and any thermometer probes used with it are sensitive instruments that can be easily damaged. Always handle these devices with care. Do not allow them to be dropped, struck, stressed, or overheated.
- When calibrating PRTs always follow correct calibration procedure and calibrate from high temperatures to low temperatures with the appropriate triple point of water checks.
- Components and heater lifetimes can be shortened by continuous high temperature operation.
- If a mains supply power fluctuation occurs, immediately turn off the bath. Power bumps from brown-outs and black-outs can damage the instrument. Wait until the power has stabilized before re-energizing the bath.
- Fluids may expand at different rates. Allow for fluid expansion inside the well as the instrument heats. Otherwise, the fluid may overflow the well and leak into the instrument.

1.3 Authorized Service Centers

Please contact one of the following authorized Service Centers to coordinate service on your Hart product:

Fluke Corporation

Hart Scientific Division

799 E. Utah Valley Drive

American Fork, UT 84003-9775

USA

Phone: + 1.801.763.1600

Telefax: +1.801.763.1010

E-mail: support@hartscientific.com

Fluke Nederland B.V.

Customer Support Services
Science Park Eindhoven 5108
5692 EC Son
NETHERLANDS
Phone: +31-402-675300
Telefax: +31-402-675321
E-mail: ServiceDesk@fluke.nl

Fluke Int'l Corporation

Service Center - Instrimpex
Room 2301 Sciteck Tower
22 Jianguomenwai Dajie
Chao Yang District
Beijing 100004, PRC
CHINA
Phone: +86-10-6-512-3436
Telefax: +86-10-6-512-3437
E-mail: xingye.han@fluke.com.cn

Fluke South East Asia Pte Ltd.

Fluke ASEAN Regional Office
Service Center
60 Alexandra Terrace #03-16
The Comtech (Lobby D)
118502
SINGAPORE
Phone: +65-6799-5588
Telefax: +65-6799-5589
E-mail: anthony.ng@fluke.com

When contacting these Service Centers for support, please have the following information available:

- Model Number
- Serial Number
- Voltage
- Complete description of the problem

Chapter 2

Introduction

The Hart Scientific 7102 Micro-Bath may be used as a portable instrument or bench top temperature calibrator for calibrating thermocouple and RTD temperature probes. The 7102 is small enough to use in the field, and accurate enough to use in the lab. With an ambient temperature of 23 °C (74 °F), calibrations may be done over a range of –5 °C to 126 °C (23 °F to 259 °F). The resolution of the 7102 temperature display is 0.01 degrees.

The Micro-Bath calibrator features:

- Convenient handle
- RS-232 interface
- Switchable AC Input (115 VAC or 230 VAC)
- Optional well extender to extend well depth

Built in programmable features include:

- Temperature scan rate control
- Temperature switch hold
- Eight Set-point memory
- Adjustable readout in °C or °F

The temperature is accurately controlled by Hart's hybrid analog/digital controller. The controller uses a precision platinum RTD as a sensor and controls the well temperature with a solid state relay (triac) driven heater.

The LED front panel continuously shows the current well temperature. The temperature may be easily set with the control buttons to any desired temperature within the specified range. The calibrator's multiple fault protection devices insure user and instrument safety and protection.

The 7102 Micro-Bath was designed for portability, low cost, and ease of operation. Through proper use, the instrument will continuously provide accurate calibration of temperature sensors and devices. The user should be familiar with the safety guidelines and operating procedures of the calibrator as described in the instruction manual.

Chapter 3

Specifications and Environmental Conditions

3.1 Specifications

Table 2. Specifications

Range	-5 to 125 °C (23 to 257 °F)
Accuracy	±0.25 °C
Stability	±0.015 °C at -5 °C (oil, 5010) ±0.03 °C at 121 °C (oil, 5010)
Uniformity	±0.02 °C
Resolution	0.01 °C/F
Operating Temperature	5 to 45 °C (41 to 113 °F)
Heating Time	25 °C to 100 °C (77 °F to 212 °F): 30 minutes
Cooling Time	25 °C to 0 °C (77 °F to 32 °F): 30 minutes
Well Size	2.5" dia. x 5.5" deep (64 x 139 mm) (access opening is 1.9" [48 mm] in diameter)
Exterior Dimension	12" H x 7.2" W x 9.5" D (31 cm x 18 cm x 24 cm)
Weight	15 lb. (6.8 kg) with fluid
Power	115 VAC (±10 %), 1.8 A, or 230 VAC (±10 %), 0.9 A, switchable, 50/60 Hz, 200 W
Readout	Switchable °C or °F
Controller	Digital controller with data retention
Thermal Electric Devices (TED)	150 W
Cooling	Fan and Thermal Electric Devices (TED)
Fault Protection	Sensor burnout and short protection
Safety	Overvoltage (Installation) Category II, Pollution Degree 2 per IEC 61010-01
Fuse Rating	115 V: 250 V 3A SB (slow blow) 230 V: 250 V 1.6 A T (time delay)

3.2 Environmental Conditions

Although the instrument has been designed for optimum durability and trouble-free operation, it must be handled with care. The instrument should not be operated in an excessively dusty or dirty environment. Maintenance and cleaning recommendations can be found in the Maintenance Section of this manual.

- The instrument operates safely under the following conditions:
- ambient temperature range: 5 – 45 °C (41 – 113 °F)
- ambient relative humidity: maximum 80 % for temperature <31 °C, decreasing linearly to 50 % at 40 °C
- mains voltage within ± 10 % of nominal
- vibrations in the calibration environment should be minimized
- altitudes less than 2,000 meters

Chapter 4

Quick Start

 **Caution:**

READ SECTION 6 ENTITLED BATH USE before placing the bath in service. Incorrect handling can damage the bath and void the warranty.

4.1 Unpacking

Unpack the Micro-Bath carefully and inspect it for any damage that may have occurred during shipment. If there is shipping damage, notify the carrier immediately.

Verify that the following components are present:

- 7102 Micro-Bath
- Transport/Pour Access Lid
- Probe Basket
- Stir Bar
- Power Cord
- User's Guide
- Report of Calibration
- Calibration Label
- Access Cover, optional
- Well Extender, optional

4.2 Setup

Caution:

DO NOT operate this instrument without fluid.

Place the calibrator on a flat surface with at least 6 inches of free space around the instrument. Plug the power cord into a grounded mains outlet. Observe that the nominal voltage corresponds to that indicated on the back of the calibrator.

Carefully insert the probe basket into the well. Fill the well with the appropriate fluid. The set-point temperature and the number of and size of probes determine the fluid level. Be sure to keep the fluid level an adequate distance below the top of the well to prevent overflowing the fluid when the probes are inserted. For example, placing 200.05 oil at room temperature (25 °C) into the bath and heating the unit to 125 °C, causes a 1-inch (2.54 cm) expansion of the fluid inside the well.

Keep the fluid level at least 1.9 cm (0.75 inches) below the top of the well at all times. With the probe (probes) in the well fill the tank 3/4 full. Heat to the maximum temperature of the fluid. Slowly fill the well to 2.54 cm (1 inch) below the top of the basket at the maximum temperature of the fluid.

Turn on the power to the calibrator by toggling the switch on the power entry module. The fan should begin blowing air through the instrument and the controller display should illuminate after 3 seconds. After a brief self test the controller should begin normal operation. If the unit fails to operate please check the power connection.

The display shows the well temperature and the well TEDs start operating to bring the temperature of the well to the set-point temperature. Insure that the fluid is being stirred.

4.3 Power

Plug the Micro-Bath power cord into a mains outlet of the proper voltage, frequency, and current capability. Refer to Section 3.1, Specifications, for power details. Turn the bath on using the rear panel "POWER" switch. The Micro-Bath will turn on and begin to heat to the previously programmed temperature set-point. The front panel LED display will indicate the actual bath temperature.

4.4 Setting the Temperature

Section 9.2 explains in detail how to set the temperature set-point on the calibrator using the front panel keys. The procedure is summarized here.

1. Press "SET" twice to access the set-point value.
2. Press "UP" or "DOWN" to change the set-point value.
3. Press "SET" to store the new set-point.
4. Press "EXIT" to return to the temperature display.

When the set-point temperature is changed the controller switches the heater on or off to raise or lower the temperature. The displayed well temperature gradually changes until it reaches the set-point temperature. The well may require 25 minutes to reach the set-point depending on the span. Another 10 to 15 minutes is required to stabilize within ± 0.03 °C of the set-point. Ultimate stability may take 20 to 30 minutes more of stabilization time.

Chapter 5 Installation

Caution:

READ SECTION 6 ENTITLED BATH USE before placing the bath in service. Incorrect handling can damage the bath and void the warranty.

5.1 Bath Environment

The 7102 Micro Bath is a precision instrument which should be located in an appropriate environment. The location should be free of drafts, extreme temperatures and temperature changes, dirt, etc. The surface where the bath is placed must be level.

Because the bath is designed for operation at high temperatures, keep all flammable and meltable materials away from the bath. Although the bath is well insulated, top surfaces do become hot. Beware of the danger of accidental fluid spills. The bath should be placed on a heat-proof surface such as concrete with plenty of clear space around the bath.

If the bath is operated at high temperatures, a fume hood should be used to remove any vapors given off by hot bath fluid.

5.2 “Dry-out” Period

Before initial use, after transport, and any time the instrument has not been energized for more than 10 days, the bath will need to be energized for a “dry-out” period of 1-2 hours before it can be assumed to meet all of the safety requirements of the IEC 61010-1.

5.3 Bath Preparation and Filling

The 7102 Micro Bath is not provided with a fluid. Various fluids are available from Hart Scientific and other sources. Depending on the desired temperature range, any of the following fluids, as well as others, may be used in the bath:

- Water (distilled)
- Ethylene glycol/water
- Mineral oil
- Silicone oil

Fluids are discussed in detail in Section 8.3.

Remove the access lid from the bath and check the tank for foreign matter (dirt, remnant packing material, etc.). Thoroughly dry the inside of the well with paper towels before filling.

Fill the bath with clean unpolluted fluid. Under-filling may reduce bath performance. The fluid should never exceed a height of 1.9 cm (0.75 inches) below the top of the basket. Carefully monitor the bath fluid level as the bath temperature rises to prevent overflow or splashing. Remove excess hot fluid if necessary with caution.

Note:

200.05 Silicon Oil expands 2.54 cm (1 inch) for a 100 °C increase in temperature.

5.4 Power

With the bath power switch off, plug the bath into an AC mains outlet of the appropriate voltage, frequency, and current capacity. Refer to Section 3.1, Specifications, for power details.

Chapter 6

Bath Use

Caution:

Read before placing the bath in service

The information in this section is for general information only. It is not designed to be the basis for calibration laboratory procedures. Each laboratory will need to write their own specific procedures.

6.1 General

Be sure to select the correct fluid for the temperature range of the calibration. Bath fluids should be selected to operate safely with adequate thermal properties to meet the application requirements. Also, be aware that some fluids expand and could overflow the bath if not watched. Refer to Section 8.3, Bath Fluid, and subsequent subsections for information specific to fluid selection and to the MSDS sheet specific to the fluid selected. Generally, baths are set to one temperature and used to calibrate probes only at that single temperature. This means that the type of bath fluid does not have to change. Additionally, the bath can be left energized reducing the stress on the system.

The bath generates extreme temperatures. Precautions must be taken to prevent personal injury or damage to objects. Probes may be extremely hot or cold when removed from the bath. Cautiously handle probes to prevent personal injury. Carefully place probes on a heat/cold resistant surface or rack until they are at room temperature. It is advisable to wipe the probe with a clean soft cloth or paper towel before inserting it into another bath. This prevents the mixing of fluids from one bath to another. If the probe has been calibrated in liquid salt, carefully wash the probe in warm water and dry completely before transferring it to another fluid. Always be sure that the probe is completely dry before inserting it into a hot fluid. Be aware that cleaning the probe can be dangerous if the probe has not cooled to room temperature. Additionally, high temperature fluids may ignite the paper towels if the probe has not been cooled.

⚠ Warning:

Some of the high temperature fluids react violently to water or other liquid mediums.

For optimum accuracy and stability, allow the bath adequate stabilization time after reaching the set-point temperature.

6.2 Comparison Calibration

Comparison calibration involves testing a probe (unit under test, UUT) against a reference probe. After inserting the probes to be calibrated into the bath, allow sufficient time for the probes to settle and the temperature of the bath to stabilize.

One of the significant dividends of using a bath rather than a dry-well to calibrate multiple probes is that the probes do not need to be identical in construction. The fluid in the bath allows different types of probes to be calibrated at the same time. However, stem effect from different types of probes is not totally eliminated. Even though all baths have horizontal and vertical gradients, these gradients are minimized inside the bath work area. Nevertheless, probes should be inserted to the same depth in the bath liquid. Be sure that all probes are inserted deep enough to prevent stem effect. From research at Hart Scientific, we suggest a general rule-of-thumb for immersion depth to reduce the stem effect to a minimum: 15 x the diameter of the UUT + the sensor length. Do not submerge the probe handles. If the probe handles get too warm during calibration at high temperatures, a heat shield could be used just below the probe handle. This heat shield could be as simple as aluminum foil slid over the probe before inserting it in the bath or as complicated as a specially designed reflective metal apparatus.

When calibrating over a wide temperature range, better results can generally be achieved by starting at the highest temperature and progressing down to the lowest temperature.

Probes can be held in place in the bath by using probe clamps or drilling holes in the access cover. Other fixtures to hold the probes can be designed. The object is to keep the reference probe and the probe(s) to be calibrated as closely grouped as possible in the working area of the bath. Bath stability is maximized when the bath working area is kept covered.

In preparing to use the bath for calibration start by:

- Placing the reference probe in the bath working area.
- Placing the probe to be calibrated, the UUT, in the bath working area as close as feasibly possible to the reference probe.

6.3 Calibration of Multiple Probes

Fully loading the bath with probes increases the time required for the temperature to stabilize after inserting the probes. Using the reference probe as the guide, be sure that the temperature has stabilized before starting the calibration.

Chapter 7

Parts and Controls

The user should become familiar with the bath and its parts:

7.1 Front Panel

Figure 1 on this page.

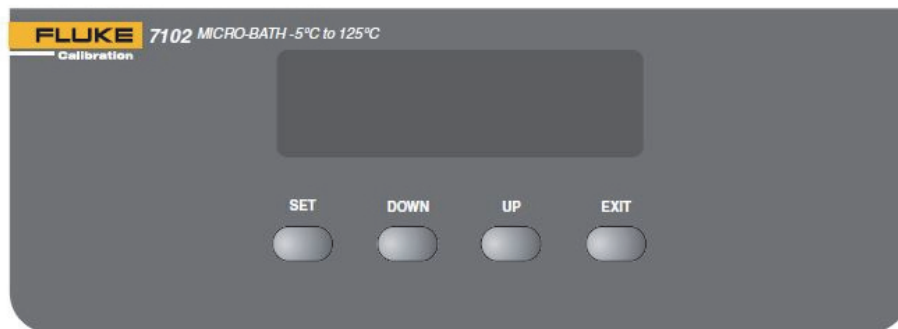

Figure 1. 7102 Front Panel

Controller Display – The digital display is an important part of the temperature controller because it not only displays set and actual temperatures but also displays various calibrator functions, settings, and constants. The display shows temperatures in units according to the selected scale °C or °F.

Controller Keypad – The four button keypad allows easy setting of the set-point temperature. The control buttons (SET, DOWN, UP, and EXIT) are used to set the calibrator temperature set-point, access and set other operating parameters, and access and set calibration parameters.

Setting the control temperature is done directly in degrees of the current scale. It can be set to one-hundredth of a degree Celsius or Fahrenheit.

The functions of the buttons are as follows:

SET – Used to display the next parameter in the menu and to store parameters to the displayed value.

DOWN – Used to decrement the displayed value of parameters.

UP – Used to increment the displayed value.

EXIT – Used to exit a function. Any changes made to the displayed value are ignored. Holding the EXIT button for approximately 0.5 seconds exits back to the main display.

7.2 Back Panel

Figure 2 on next page.

Power Cord – Underneath the calibrator is the removable power cord inlet that plugs into an IEC grounded socket.

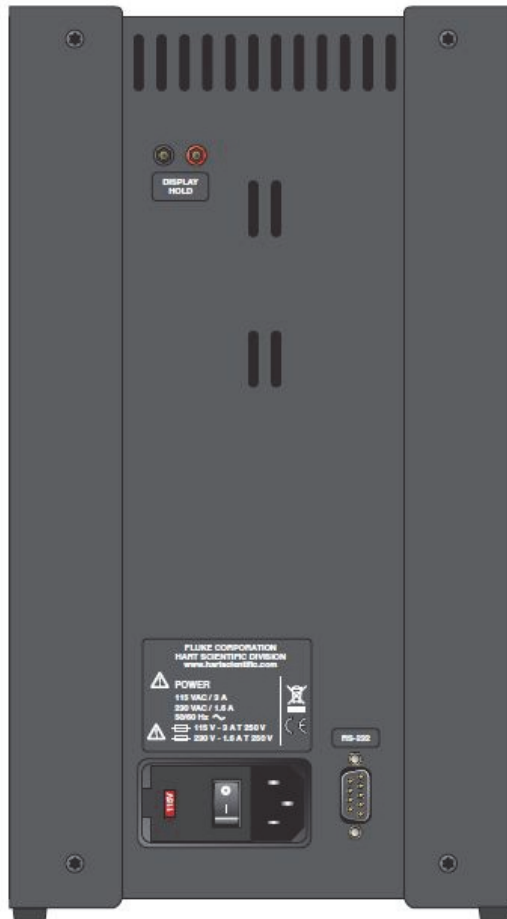

Figure 2. 7102 Back Panel and Bottom

Power Switch – The power switch is located on the power entry module (PEM). The PEM also houses the fuses and the dual voltage selector. The PEM allows the unit to be field switchable for 115 VAC ($\pm 10\%$) or 230 VAC ($\pm 10\%$) operation.

Serial Port – A DB-9 male connector is present for interfacing the calibrator to a computer or terminal with serial RS-232 communications.

Fan – The fan inside the calibrator runs continuously when the unit is being operated to provide cooling for the instrument. Slots at the top and around the two corners of the calibrator are provided for airflow. The area around the calibrator must be kept clear to allow adequate ventilation. The airflow is directed out the back.

7.3 Accessories

7.3.1 Transport/Pour Access Lid

A transport/pour access lid (Figure 3) is provided so the fluid being does not have to be removed when transporting. The lid doubles as a pour spout.

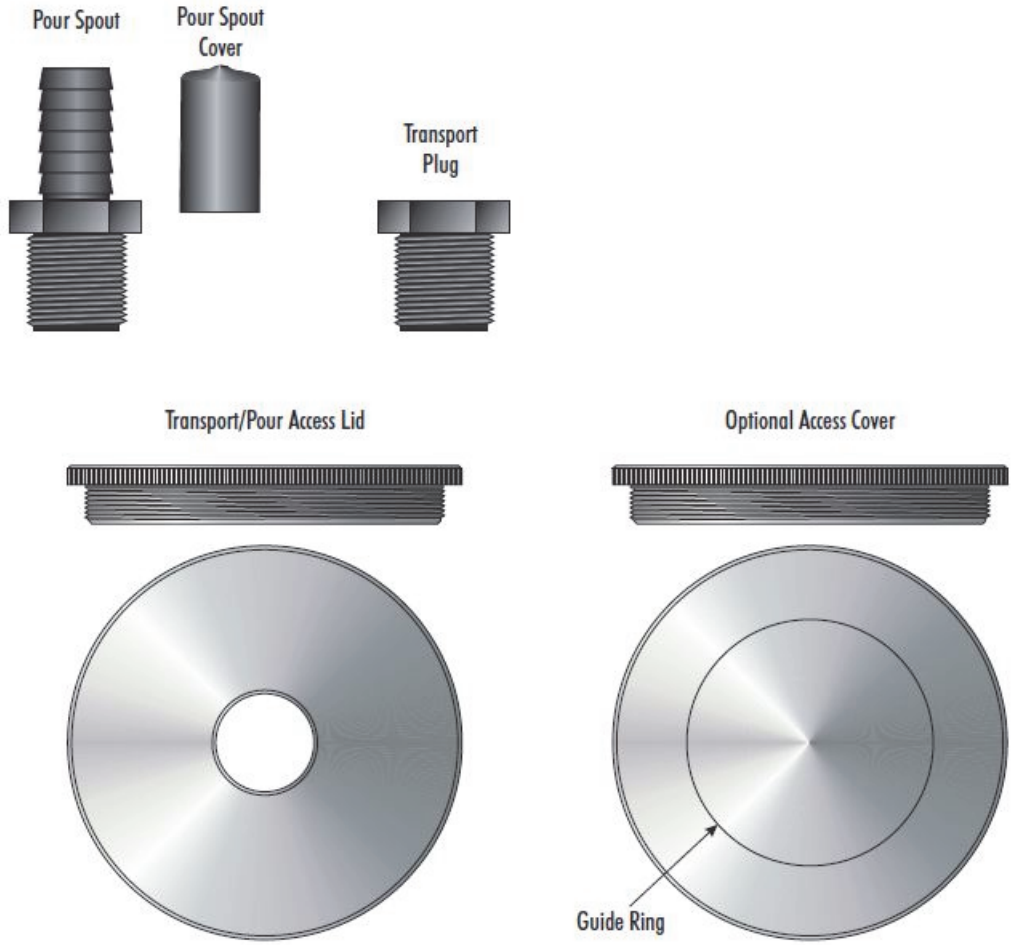

Figure 3. Bath Lids and Lid Parts

7.3.2 Access Cover (Optional)

An aluminum access cover (Figure 3) is available for optimum stability. Holes should be drilled in the access cover to allow insertion of the probes into the well. The holes must be within the guide ring for the probes to fit into the probe basket.

⚠ Warning:

DO NOT install an access cover without holes (like the optional cover) onto a bath that is energized. Dangerous pressures may result from fluids vaporizing.

7.3.3 Probe Basket

A probe basket (Figure 4) is provided as a guide for the probes and to prevent bumping of the stir bar.

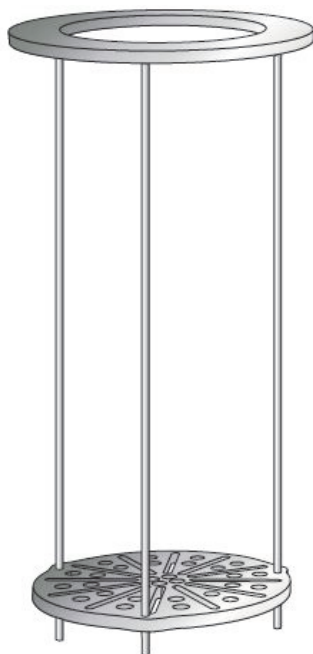

Figure 4. Probe Basket

7.3.4 Stir Bar

The stir bar (Figure 5) sits in the bottom of the well for mixing the fluid providing better accuracy, uniformity, and stability.



Figure 5. Stir Bar

7.3.5 Well Extender (Optional)

An optional well extender is available for increasing the depth of the well. This extender screws onto the well and is equipped with an O-ring. Thread the extender down until the O-ring makes a good seal. Some fluids may expand up to 6.35 cm (2.5 inches). Therefore, when using the well extender keep in mind how much the fluid you are using will expand. Do not overfill the well.

Chapter 8

General Operation

8.1 Changing Display Units

The 7102 can display temperature in Celsius or Fahrenheit.

The temperature units are shipped from the factory set to Celsius.

To change to Fahrenheit or back to Celsius there are two ways:

1. Press “SET” and “UP” simultaneously. This will change the display units.
2. Press the “SET” key three times from the temperature display to show

Un = C

or

- Press the “UP” or “DOWN” key to change units.
- Press “SET” to store changes.

8.2 Switching to 230V Operation

The 7102 is switchable from 115 VAC to 230 VAC 50/60 Hz. Switching the voltage can change the calibration, so **the unit should be calibrated after changing the input voltage.**

To change from 115 VAC to 230 VAC:

- Unplug the unit.
- With a small straight slot screwdriver remove the fuse holder located on the back of the bath. Replace the two fuses (3 amp 250 V) with 1.6 amp 250 V fuses.
- Replace the fuse holder with the “230V” in the display window.

Note:

Use 3 amp fuses for 115 V and 1.6 amp for 230V only. DO NOT PLUG THE UNIT INTO 230 V IF THE FUSE HOLDER READS 115 V.

8.3 Bath Fluid

Many fluids work with the 7102 bath. Choosing a fluid requires consideration of many important characteristics of the fluid. Among these are temperature range, viscosity, specific heat, thermal conductivity, thermal expansion, electrical resistivity, fluid lifetime, safety, and cost.

8.3.1 Temperature Range

One of the most important characteristics to consider is the temperature range of the fluid. Few fluids work well throughout the complete temperature range of the bath. The temperature at which the bath is operated must always be within the safe and useful temperature range of the fluid. The lower temperature range of the fluid is determined by the freeze point of the fluid or the temperature at which the viscosity becomes too great. The upper temperature is usually limited by vaporization, flammability, or chemical breakdown of the fluid. Vaporization of the fluid at higher temperatures may affect temperature stability because of cool condensed fluid dripping into the bath from the lid.

8.3.2 Viscosity

Viscosity is a measure of the thickness of a fluid, how easily it can be poured and mixed. Viscosity affects the temperature stability of the bath. With low viscosity, fluid mixing is better which creates a more uniform temperature throughout the bath. This improves the bath response time which allows it to maintain a more constant temperature. For good control the viscosity should be less than ten centistokes. Twenty centistokes is about the upper limit of allowable viscosity. Viscosities greater than this cause very poor control stability and may also overheat or damage the stirring motor. With oils viscosity may vary greatly with temperature.

When using fluids with higher viscosities the controller proportional band may need to be increased to compensate for the reduced response time. Otherwise the temperature may begin to oscillate.

8.3.3 Specific Heat

Specific heat is the measure of the heat storage ability of the fluid. Specific heat, to a small degree, affects the control stability. It also affects the heating and cooling rates. Generally, a lower specific heat means quicker heating and cooling. The proportional band may require some adjustment depending on the specific heat of the fluid.

8.3.4 Thermal Conductivity

Thermal conductivity measures how easily heat flows through the fluid. Thermal conductivity of the fluid affects the control stability, temperature uniformity, and probe temperature settling time. Fluids with higher conductivity distribute heat more quickly and evenly improving bath performance.

8.3.5 Thermal Expansion

Thermal expansion describes how the volume of the fluid changes with temperature. Thermal expansion of the fluid used must be considered since the increase in fluid volume as the bath temperature changes may cause overflow. Excessive thermal expansion may also be undesirable in applications where constant liquid level is important. Many fluids including oils have significant thermal expansion.

8.3.6 Electrical Resistivity

Electrical resistivity describes how well the fluid insulates against the flow of electric current. In some applications, such as measuring the resistance of bare temperature sensors, it may be important that little or no electrical leakage occur through the fluid. In such conditions choose a fluid with very high resistivity.

8.3.7 Fluid Lifetime

Many fluids degrade over time because of evaporation, water absorption, gelling, or chemical breakdown. Often the degradation becomes significant near the upper temperature limit of the fluid, substantially reducing the fluid's lifetime.

8.3.8 Safety

When choosing a fluid always consider the safety issues associated. Obviously where there are conditions of extreme hot or cold there can be danger to people and equipment. Fluids may also be hazardous for other reasons. Some fluids may be considered toxic. Contact with eyes, skin, or inhalation of vapors may cause injury. A proper fume hood must be used if hazardous or bothersome vapors are produced.

Warning:

Fluids at high temperatures may pose danger from BURNS, FIRE, and TOXIC FUMES. Use appropriate caution and safety equipment.

Fluids may be flammable and require special fire safety equipment and procedures. An important characteristic of the fluid to consider is the flash point. The flash point is the temperature at which there is sufficient vapor given off so that when there is sufficient oxygen present and an ignition source is applied the vapor will ignite. This does not necessarily mean that fire will be sustained at the flash point. The flash point may be either of the open cup or closed cup type. Either condition may occur in a bath situation. The closed cup temperature is always the lower of the two. The closed cup represents the contained vapors inside the tank and the open cup represents the vapors escaping the tank. Oxygen and an ignition source will be less available inside the tank.

Environmentally hazardous fluids require special disposal according to applicable federal or local laws after use.

8.3.9 Cost

Cost of bath fluids may vary greatly, from cents per gallon for water to hundreds of dollars per gallon for synthetic oils. Cost may be an important consideration when choosing a fluid.

8.3.10 Commonly Used Fluids

Below is a description of some of the more commonly used fluids and their characteristics.

8.3.10.1 Water (Distilled)

Water is often used because of its very low cost, availability, and excellent temperature control characteristics. Water has very low viscosity and good thermal conductivity and heat capacity which makes it among the best fluids for control stability at low temperatures. Temperature stability is much poorer at higher temperatures because water condenses on the lid, cools and drips into the bath. Water is safe and relatively inert. The electrical conductivity of water may prevent its use in some applications. Water has a limited temperature range, from a few degrees above 0 °C to a few degrees below 100 °C. At higher temperatures evaporation becomes significant. Water used in the bath should be distilled or softened to prevent mineral deposits. Consider using an algaecide chemical in the water to prevent contamination.

8.3.10.2 Mineral Oil

Mineral oil or paraffin oil is often used at moderate temperatures above the range of water. Mineral oil is relatively inexpensive. At lower temperatures mineral oil is quite viscous and control may be poor. At higher temperatures vapor emission becomes significant. The vapors may be dangerous and use of a fume hood is highly recommended. As with most oils mineral oil will expand as temperature increases so be careful not to fill the bath too full that it overflows when heated. The viscosity and thermal characteristics of mineral oil is poorer than water so temperature stability will not be as good. Mineral oil has very low electrical conductivity. Use caution with mineral oil since it is flammable and may also cause serious injury if inhaled or ingested.

8.3.10.3 Silicone Oil (Dow Corning 200.05, 200.10, 200.20)

Silicone oils are available which offer a much wider operating temperature range than mineral oil. Like most oils, silicone oils have temperature control characteristics which are somewhat poorer than water. The viscosity changes significantly with temperature and thermal expansion also occurs. These oils have very high electrical resistivity. Silicone oils are fairly safe and non-toxic. Silicone oils are fairly expensive.

8.3.11 Fluid Characteristics Charts

Table 3 on page 25 and Figure 6 on page 26 have been created to provide help in selecting a heat exchange fluid media for your constant temperature bath. These charts provide both a visual and numerical representation of most of the physical qualities important in making a selection. The list is not all inclusive. There may be other useful fluids not shown in this listing.

The charts include information on a variety of fluids which often used as heat transfer fluid in baths. Because of the temperature range some fluids may not be useful with your bath.

8.3.11.1 Limitations and Disclaimer

The information given in this manual regarding fluids is intended only to be used as a general guide in choosing a fluid. Though every effort has been made to provide correct information we cannot guarantee accuracy of data or assure suitability of a fluid for a particular application. Specifications may change and sources sometimes offer differing information. Hart Scientific cannot be liable for any personal injury or damage to equipment, product or facilities resulting from the use of these fluids. The user of the bath is responsible for collecting correct information, exercising proper judgment, and insuring safe operation. Operating near the limits of certain properties such as the flash point or viscosity can compromise safety or performance. Your company's safety policies regarding flash points, toxicity, and such issues must be considered. You are responsible for reading the MSDS (material safety data sheets) and acting accordingly.

Table 3. Table of Various Bath Fluids

Fluid (# = Hart Part No.)	Lower Temperature Limit *	Upper Temperature Limit *	Flash Point	Viscosity (centistokes)	Specific Gravity	Specific Heat (cal/g/°C)	Thermal Conductivity (cal/s/cm ² /°C)	Thermal Expansion (cm/cm ³ /°C)	Resistivity (10 ¹² Ω-cm)
Halocarbon 0.8 #5019	-90°C (v) **	70°C (e)	NONE	5.7 @ -50°C 0.8 @ 40°C 0.5 @ 70°C	1.71 @ 40°C	0.2	0.0004	0.0011	
Methanol	-96°C (fr)	60°C (b)	54°C	1.3 @ -35°C 0.66 @ 0°C 0.45 @ 20°C	0.810 @ 0°C 0.792 @ 20°C	0.6	0.0005 @ 20°C	0.0014 @ 25°C	
Water	0°C (fr)	95°C (b)	NONE	1 @ 25°C 0.4 @ 75°C	1.00	1.00	0.0014	0.0002 @ 25°C	
Ethylene Glycol-50% #5020	-35°C (fr)	110°C (b)	NONE	7 @ 0°C 2 @ 50°C 0.7 @ 100°C	1.05	0.8 @ 0°C	0.001		
Mineral Oil	40°C (v)	190°C (fl)	190°C	15 @ 75°C 5 @ 125°C	0.87 @ 25°C 0.84 @ 75°C 0.81 @ 125°C	0.48 @ 25°C 0.53 @ 75°C 0.57 @ 125°C	0.00025 @ 25°C	0.0007 @ 50°C	5 @ 25°C
Dow Corning 200.05 Silicone Oil	-40°C (v) **	133°C (fl, cc)	133°C	5 @ 25°C	0.92 @ 25°C	0.4	0.00028 @ 25°C	0.00105	1000 @ 25°C 10 @ 150°C
Dow Corning 200.10 #5012	-35°C (v) **	165°C (fl, cc)	165°C	10 @ 25°C 3 @ 135°C	0.934 @ 25°C	0.43 @ 40°C 0.45 @ 100°C 0.482 @ 200°C	0.00032 @ 25°C	0.00108	1000 @ 25°C 50 @ 150°C
Dow Corning 200.20 #5013	7°C (v)	230°C (fl, cc)	230°C	20 @ 25°C	0.949 @ 25°C	0.370 @ 40°C 0.393 @ 100°C 0.420 @ 200°C	0.00034 @ 25°C	0.00107	1000 @ 25°C 50 @ 150°C
Dow Corning 200.50 Silicone Oil	25°C (v)	280°C (fl, cc)	280°C	50 @ 25°C	0.96 @ 25°C	0.4	0.00037 @ 25°C	0.00104	1000 @ 25°C 50 @ 150°C
Dow Corning 550 #5016	70°C (v)	232°C (fl, cc) 300°C (fl, oc)	232°C	50 @ 70°C 10 @ 104°C	1.07 @ 25°C	0.358 @ 40°C 0.386 @ 100°C 0.433 @ 200°C	0.00035 @ 25°C	0.00075	100 @ 25°C 1 @ 150°C
Dow Corning 710 #5017	80°C (v)	302°C (fl, oc)	302°C	50 @ 80°C 7 @ 204°C	1.11 @ 25°C	0.363 @ 40°C 0.454 @ 100°C 0.505 @ 200°C	0.00035 @ 25°C	0.00077	100 @ 25°C 1 @ 150°C
Dow Corning 210-H Silicone Oil	66°C (v)	315°C (fl, oc)	315°C	50 @ 66°C 14 @ 204°C	0.96 @ 25°C	0.34 @ 100°C	0.0003	0.00095	100 @ 25°C 1 @ 150°C
Heat Transfer Salt #5001	145°C (fr)	530°C	NONE	34 @ 150°C 6.5 @ 300°C 2.4 @ 500°C	2.0 @ 150°C 1.9 @ 300°C 1.7 @ 500°C	0.33	0.0014	0.00041	1.7 Ω/cm ³

*Limiting Factors — b – boiling point e – high evaporation fl – flash point fr – freeze point v – viscosity — Flash point test oc = open cup cc = closed cup
**Very low water solubility, ice will form as a slush from condensation below freezing.

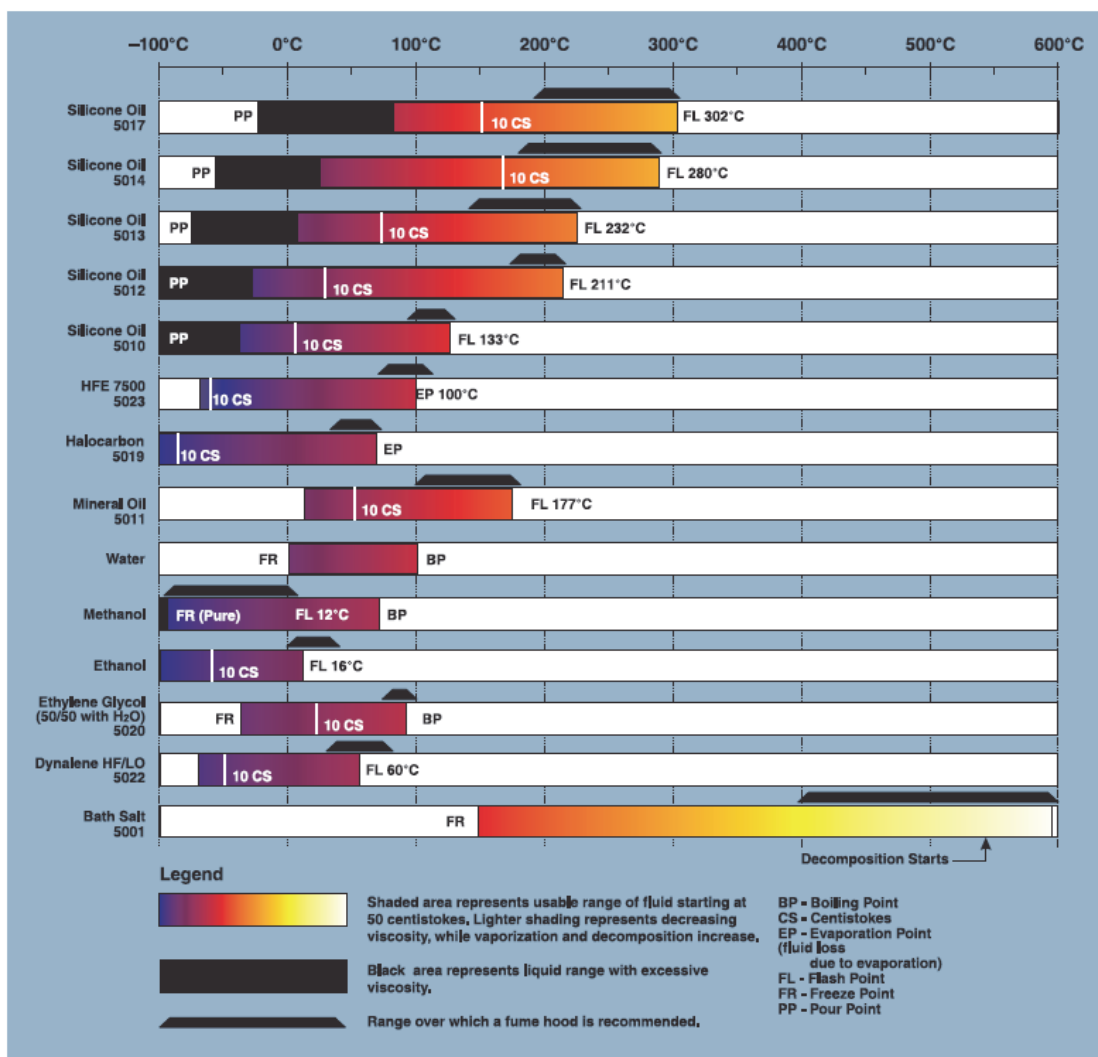

Figure 6. Chart of Various Bath Fluids

8.3.11.2 About the Graph

The fluid graph visually illustrates some of the important qualities of the fluids shown.

Temperature Range: The temperature scale is shown in degrees Celsius. The fluids' general range of application is indicated by the shaded bands. Qualities including pour point, freeze point, important viscosity points, flash point, boiling point and others may be shown.

Freezing Point: The freezing point of a fluid is an obvious limitation to stirring. As the freezing point is approached high viscosity may also limit performance.

Pour Point: This represents a handling limit for the fluid.

Viscosity: Points shown are at 50 and 10 centistokes viscosity. When viscosity is greater than 50 centistokes stirring is very poor and the fluid is unsatisfactory for bath applications. Optimum stirring generally occurs at 10 centistokes and below.

Fume Point: A fume hood should be used. This point is very subjective in nature and is impacted by individual tolerance to different fumes and smells, how well the bath is covered, the surface area of the fluid in the bath, the size and ventilation of the facility where the bath is located and other conditions. We assume the bath is well covered at this point. This is also subject to company policy.

Flash Point: The point at which ignition may occur. The point shown may be either the open or closed cup flash point. Refer to the flash point discussion in Section 8.3.8.

Boiling Point: At or near the boiling point of the fluid, the temperature stability is difficult to maintain. Fuming or evaporation is excessive. Large amounts of heater power may be required because of the heat of vaporization.

Decomposition: The temperature may reach a point at which decomposition of the fluid begins. Further increasing the temperature may accelerate decomposition to the point of danger or impracticality.

8.4 Stirring

Stirring of the bath fluid is very important for stable temperature control. The fluid must be mixed well for good temperature uniformity and fast controller response. The stirrer is adjusted for optimum performance. Table 4 on page 27 shows nominal stirrer motor settings for several fluids.

If the stirrer does not function properly, the instrument will oscillate and not meet published specifications.

Note:

If the bath is used with the probe basket removed, stir motor settings need to be changed so that a small vortex can be seen in the liquid.

 **Warning:**

Do not mix water and oil when exceeding temperatures of 90 °C

Table 4. Nominal Stirrer Motor Settings with Different Liquids

Liquid	Stir Motor Setting	Temperature
Distilled Water	15	5 °C to 90 °C (41 °F to 194 °F)
Ethylene Glycol	15	-5 °C to 90 °C (25 °F to 194 °F)
200.05 Oil	15	-5 °C to 125 °C (-23 °F to 258 °F)
200.10 Oil	15	25 °C to 125 °C (77 °F to 258 °F)

8.5 Power

Power to the bath is provided by an AC mains supply and passes through a filter to prevent switching spikes from being transmitted to other equipment. Refer to Section 3.1, Specifications, for power details.

To turn on the bath, switch the control panel power switch to the ON position. The stir motor will turn on, the LED display will begin to show the bath temperature, and the heater will turn on or off until the bath temperature reaches the programmed set-point.

When powered on the control panel display will briefly show a four digit number. This number indicates the number of times power has been applied to the bath. Also briefly displayed is data which indicates the controller hardware configuration. This data is used in some circumstances for diagnostic purposes.

8.6 Thermal Electric Devices (TED)

The power to the bath is precisely controlled by the temperature controller to maintain a constant bath temperature. Power is controlled by periodically switching the TEDs on for a certain amount of time using power transistors.

8.7 Fluid Drain

The fluid may be drained from the 7102 by tightly screwing the transport/pour access lid onto the top of the bath and pouring the liquid into an appropriate container.

8.8 Temperature Controller

The bath temperature is controlled by Hart Scientific's unique hybrid digital/analog temperature controller. The controller offers the tight control stability of an analog temperature controller as well as the flexibility and programmability of a digital controller.

The bath temperature is monitored with a platinum resistance sensor in the control probe. The signal is electronically compared with the programmable reference signal, amplified, and then fed to a pulse-width modulator circuit which controls the amount of power applied to the bath heater.

The bath is operable within the temperature range given in the specifications. For protection against solid-state relay failure or other circuit failure, a bi-metallic cut-out automatically turns off the heater anytime the bath temperature exceeds the maximum temperature.

The controller allows the operator to set the bath temperature with high resolution, adjust the proportional band, monitor the heater output power, and program the controller configuration and calibration parameters. The controller may be operated in temperature units of degrees Celsius or Fahrenheit. The controller is operated and programmed from the front control panel using the four key switches and digital LED display. The controller is equipped with a serial RS-232 digital interface for remote operation. Operation using the digital interfaces is discussed in Section 10.

When the controller is set to a new set-point the bath heats or cools to the new temperature. Once the new temperature is reached the bath usually takes 15 – 20 minutes for the temperature to settle and stabilize. There may be a small overshoot or undershoot.

Chapter 9

Controller Operation

This chapter discusses in detail how to operate the bath temperature controller using the front control panel. Using the front panel key-switches and LED display the user may monitor the well temperature, set the temperature set-point in degrees C or F, monitor the heater output power, adjust the controller proportional band, and program the calibration parameters, operating parameters, and serial interface configuration. Operation of the functions and parameters are shown in the flowchart in Figure 7 on page 32. This chart may be copied for reference.

In the following discussion a button with the word SET, UP, EXIT or DOWN inside indicates the panel button while the dotted box indicates the display reading. Explanation of the button or display reading are to the right of each button or display value.

9.1 Well Temperature

The digital LED display on the front panel allows direct viewing of the actual well temperature. This temperature value is what is normally shown on the display. The units, C or F, of the temperature value are displayed at the right. For example,

100.00C Well temperature in degrees Celsius

The temperature display function may be accessed from any other function by pressing the “EXIT” button.

9.2 Temperature Set-point

The temperature set-point can be set to any value within the range and resolution as given in the specifications. Be careful not to exceed the safe upper temperature limit of any device inserted into the well.

Setting the temperature involves selecting the set-point memory and adjusting the set- point value.

9.2.1 Programmable Set-points

The controller stores 8 set-point temperatures in memory. The set-points can be quickly recalled to conveniently set the calibrator to a previously programmed temperature set-point.

To set the temperature one must first select the set-point memory. This function is accessed from the temperature display function by pressing “SET”. The number of the set-point memory currently being used is shown at the left on the display followed by the current set-point value.

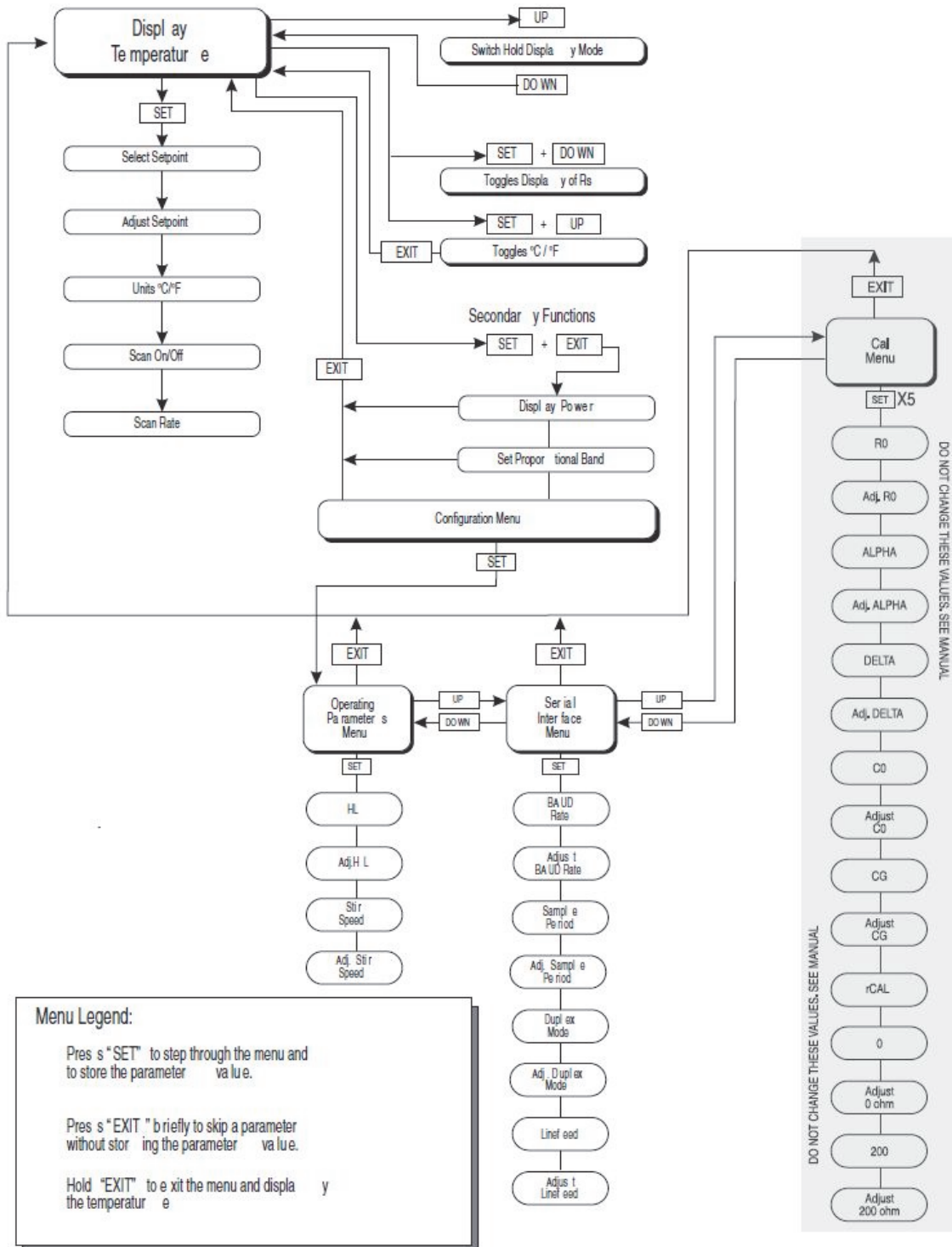

Figure 7. Controller Operation Flowchart

100.00C Well temperature in degrees Celsius



Access set-point memory

1. 25 Set-point memory 1, 25 °C currently used

To change the set-point memory press “UP” or “DOWN”.

4. 125. New set-point memory 4, 125 °C

Press “SET” to accept the new selection and access the set-point value.



Accept selected set-point memory

9.2.2 Set-point Value

The set-point value may be adjusted after selecting the set-point memory and pressing “SET”.

4 125. Set-point 4 value in °C

If the set-point value is correct, hold “EXIT” to resume displaying the well temperature. Press “UP” or “DOWN” to adjust the set-point value.

125.00 New set-point value

When the desired set-point value is reached press “SET” to accept the new value and access the temperature scale units selection. If “EXIT” is pressed instead of “SET”, any changes made to the set-point are ignored.



Accept new set-point value

9.2.3 Temperature Scale Units

The temperature scale units of the controller can be set by the user to degrees Celsius (°C) or Fahrenheit (°F). The selected units are used in displaying the well temperature, set-point, and proportional band.

Press “SET” after adjusting the set-point value to change display units.

Un= C Scale units currently selected

Press “UP” or “DOWN” to change the units.

Un= F New units selected

9.3 Scan

The scan rate can be set and enabled so that when the set-point is changed the bath heats or cools at a specified rate (degrees per minute) until it reaches the new set-point. With the scan disabled the bath heats or cools at the maximum possible rate.

9.3.1 Scan Control

The scan is controlled with the scan on/off function that appears in the main menu after the set-point function.

Sc=OFF Scan function off

Press "UP" or "DOWN" to toggle the scan on or off.

Sc=On Scan function on

Press "SET" to accept the present setting and continue.



Accept scan setting

9.3.2 Scan Rate

The next function in the main menu is the scan rate. The scan rate can be set from .1 to 99.9 °C/min. The maximum scan rate however is actually limited by the natural heating or cooling rate of the instrument. This is often less than 100 °C/min, especially when cooling.

The scan rate function appears in the main menu after the scan control function. The scan rate units are in degrees C per minute.

Sr= 10.0 Scan rate in °C/min

Press "UP" or "DOWN" to change the scan rate.

Sr= 2.0 New scan rate

Press "SET" to accept the new scan rate and continue.



Accept scan rate

9.4 Temperature Display Hold

The 7102 has a display hold function which allows action of an external switch to freeze the displayed temperature and stop the set-point from scanning. This is useful for testing thermal switches and cut-outs. The instrument must be powered off before attaching thermal switches or cut-outs. This section explains the functions available for operating the temperature hold feature. An example follows showing how to set up and use the hold feature to test a switch.

9.4.1 Hold Temperature Display

The hold feature is enabled by simply pressing the “UP” button when the temperature is displayed. The hold temperature display shows the hold temperature on the right and the switch status on the left. For the status “c” means the switch is closed and “o” means the switch is open. The status flashes when the switch is in its active position (opposite the normal position). The hold temperature shows what the temperature of the well was when the switch changed from its normal position to its active position. While the switch is in the normal position the hold temperature will follow the well temperature.

If the Scan Control is “OFF” and the Hold Temperature Display is being used, the temperature at which the switch is activated **does not** affect the set-point temperature. However, if the Scan Control is “ON” and the Hold Temperature Display is being used, the temperature at which the switch is activated **is stored** as the new set-point temperature.

Operation of the hold temperature display is outlined below.

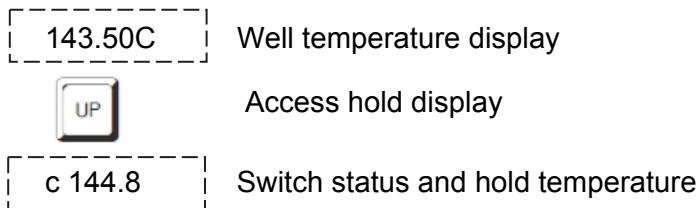

To return to the normal well temperature display press “DOWN”.

9.4.2 Mode Setting

The Hold Function is always in the automatic mode. In this mode the normal position is set to whatever the switch position is when the set-point is changed. For example, if the switch is currently open when the set-point is changed, the closed position then becomes the new active position. The normal position will be set automatically under any of the following conditions, (1) a new set-point number is selected, (2) the set-point value is changed, (3) a new set-point is set through the communications channels.

9.4.3 Switch Wiring

The thermal switch or cut-out is wired to the calibrator at the two terminals on the back of the Micro-Bath labeled “DISPLAY HOLD”. The switch wires may be connected to the terminals either way. Internally the black terminal connects to ground. The red terminal connects to +5V through a 100 kW resistor. The calibrator measures the voltage at the red terminal and interprets +5V as open and 0V as closed.

9.4.4 Switch Test Example

This section describes a possible application for the temperature hold feature and how the instrument is set up and operated.

Suppose you have a thermal switch which is supposed to open at about 75 °C and close at about 50 °C and you want to test the switch to see how accurate and repeatable it is. You can use the temperature hold feature and the scan function to test the switch. Measurements can be made by observing the display or, preferably, by collecting data using a computer connected to the RS-232 port. To set up the test do the following steps.

1. Connect the switch wires to the terminals on the back of the Micro-Bath and place the switch in the well.
2. Enable set-point scanning by setting the scan to "ON" in the primary menu (see Section 9.3.1).
3. Set the scan rate to a low value, say 1.0 °C/min. (see Section 9.3.2). If the scan rate is too high you may lose accuracy because of transient temperature gradients. If the scan rate is too low the duration of the test may be longer than is necessary. You may need to experiment to find the best scan rate.
4. Set the first program set-point to a value above the expected upper switch temperature, say 90 °C.
5. Set the second program set-point to a value below the expected lower switch temperature, say 40 °C, in the program menu.
6. Collect data on a computer connected to the RS-232 port. Refer to Section 9.8.2, Serial Interface Parameters, for instructions on configuring the RS-232 communications interface.

9.5 Secondary Menu

Functions which are used less often are accessed within the secondary menu. The secondary menu is accessed by pressing "SET" and "EXIT" simultaneously and then releasing. The first function in the secondary menu is the heater power display. (See Figure 7 on page 32.)

9.6 Thermal Electric Device (TED)

The temperature controller controls the temperature of the well by pulsing the TED on and off. The total power being applied to the TED is determined by the duty cycle or the ratio of TED on time to the pulse cycle time. By knowing the amount of heating the user can tell if the calibrator is heating up to the set-point, cooling down, or controlling at a constant temperature. Monitoring the percent heater power will let the user know how stable the well temperature is. With good control stability the percent heating power should not fluctuate more than $\pm 5\%$ within one minute.

The heater power display is accessed in the secondary menu. Press “SET” and “EXIT” simultaneously and release. The heater power will be displayed as a percentage of full power.

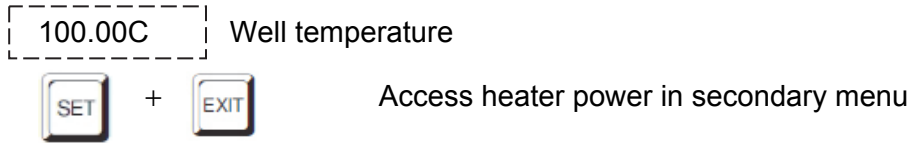

To exit out of the secondary menu hold “EXIT”. To continue on to the proportional band setting function press “EXIT” momentarily or “SET”.

9.7 Proportional Band

In a proportional controller such as this the heater output power is proportional to the well temperature over a limited range of temperatures around the set-point. This range of temperature is called the proportional band. At the bottom of the proportional band the heater output is 100 %. At the top of the proportional band the heater output is 0. Thus as the temperature rises the heater power is reduced, which consequently tends to lower the temperature back down. In this way the temperature is maintained at a fairly constant temperature.

The temperature stability of the well and response time depend on the width of the proportional band. If the band is too wide the well temperature will deviate excessively from the set-point due to varying external conditions. This is because the power output changes very little with temperature and the controller cannot respond very well to changing conditions or noise in the system. If the proportional band is too narrow the temperature may swing back and forth because the controller overreacts to temperature variations. For best control stability the proportional band must be set for the optimum width.

The proportional band width is set at the factory to about 5.0 °C. The proportional band width may be altered by the user if he desires to optimize the control characteristics for a particular application.

The proportional band width is easily adjusted from the front panel. The width may be set to discrete values in degrees C or F depending on the selected units. The proportional band adjustment is accessed within the secondary menu. Press "SET" and "EXIT" to enter the secondary menu and show the heater power. Then press "SET" to access the proportional band.

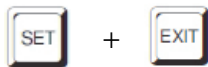

Access heater power in secondary menu

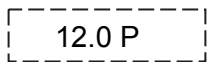

Heater power in percent



Access proportional band

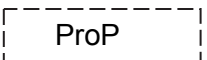

Flashes "ProP" and the setting

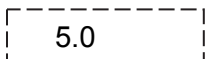

Proportional band setting

To change the proportional band press "UP" or "DOWN".

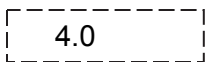

New proportional band setting

To store the new setting press "SET". Press "EXIT" to continue without storing the new value.



Accept the new proportional band setting

9.8 Controller Configuration

The controller has a number of configuration and operating options and calibration parameters which are programmable via the front panel. These are accessed from the secondary menu after the proportional band function by pressing "SET". Pressing "SET" again enters the first of three sets of configuration parameters: operating parameters, serial interface parameters, and calibration parameters. The menus are selected using the "UP" and "DOWN" keys and then pressing "SET". (See Figure 7 on page 32.)

9.8.1 Operating Parameters

The operating parameters menu is indicated by,

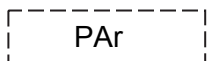

Operating parameters menu

The operating parameters menu contains the High Limit and Stir Speed parameters.

9.8.1.1 High Limit

The High Limit Parameter adjusts the upper set-point temperature. The factory default and maximum temperature are set to 126 °C. For safety, a user can adjust the HL down so the maximum temperature set-point is restricted.

HL High Limit parameter

Press “SET” to enable adjustment of HL

HL Flashes “HL” and then displays the setting

H=126 Current HL setting

Adjust the HL parameter using “UP” or “DOWN”

H=90 New HL setting

Press “SET” to accept the new temperature limit.

9.8.1.2 Stir Speed

The Stir Speed parameter adjusts stirrer motor speed. The factory default is 20.

Str SP Flashes “Str Sp” and then displays the setting

0 Current Stir Speed setting

To change the stir speed press “UP” or “DOWN”.

16 New Stir Speed setting

Press “SET” to accept the new Stir Speed.

The stir motor speed needs to be varied for best stability. Table 3 on page 25 shows nominal settings for several fluids.

9.8.2 Serial Interface Parameters

The serial RS-232 interface parameters menu is indicated by,

SErIAL Serial RS-232 interface parameters menu

The serial interface parameters menu contains parameters which determine the operation of the serial interface. These controls only apply to instruments fitted with the serial interface. The parameters in the menu are — baud rate, sample period, duplex mode, and linefeed. Press “UP” to enter the menu.

9.8.2.1 Baud Rate

The baud rate is the first parameter in the menu. The baud rate setting determines the serial communications transmission rate.

The baud rate parameter is indicated by,

bAUd	Flashes "bAUd" and then displays the setting
2400 b	Current baud rate

The baud rate of the serial communications may be programmed to 300, 600, 1200, **2400**, 4800, or 9600 baud. Use "UP" or "DOWN" to change the baud rate value.

4800 b	New baud rate
--------	---------------

Press "SET" to set the baud rate to the new value or "EXIT" to abort the operation and skip to the next parameter in the menu.

9.8.2.2 Sample Period

The sample period is the next parameter in the serial interface parameter menu. The sample period is the time period in seconds between temperature measurements transmitted from the serial interface. If the sample rate is set to 5, the instrument transmits the current measurement over the serial interface approximately every five seconds. The automatic sampling is disabled with a sample period of 0. The sample period is indicated by,

SPer	Flashes "SPEr" and then displays the setting
SP= 1	Current sample period (seconds)

Adjust the value with "UP" or "DOWN" and then use "SET" to store the sample rate to the displayed value. "EXIT" does not store the new value.

SP= 60	New sample period
--------	-------------------

9.8.2.3 Duplex Mode

The next parameter is the duplex mode. The duplex mode may be set to full duplex or half duplex. With full duplex any commands received by the calibrator via the serial interface will be immediately echoed or transmitted back to the device of origin. With half duplex the commands will be executed but not echoed. The duplex mode parameter is indicated by,

dUPL	Flashes "dUPL" and then displays the setting
------	--

`d=FULL` Current duplex mode setting

The mode may be changed using “UP” or “DOWN” and pressing “SET”.

`d=HALF` New duplex mode setting

9.8.2.4 Linefeed

The final parameter in the serial interface menu is the linefeed mode. This parameter enables (on) or disables (off) transmission of a linefeed character (LF, ASCII 10) after transmission of any carriage-return. The linefeed parameter is indicated by,

`LF` Flashes “LF” and then displays the setting

`LF= On` Current linefeed setting

The mode may be changed using “UP” or “DOWN” and pressing “SET”.

`LF= OFF` New linefeed setting

9.8.3 Calibration Parameters

The operator of the Micro-Bath controller has access to a number of the bath calibration constants namely R0, ALPHA, DELTA, C0, CG, and rCAL. These values are set at the factory and should not be altered. The correct values are important to the accuracy and proper and safe operation of the bath. Access to these parameters is available to the user only so that in the event that the controller memory fails the user may restore these values to the factory settings. The user should have a list of these constants and their settings with manual.

Caution:

DO NOT change the values of the bath calibration constants from the factory set values. The correct setting of these parameters is important to the safety and proper operation of the bath.

The calibration parameters menu is indicated by:

`CAL` Calibration parameters menu

Press “SET” five times to enter the menu.

The calibration parameters R0, ALPHA, DELTA, C0, CG, and rCAL characterize the resistance-temperature relationship of the platinum control sensor. These parameters may be adjusted by an experienced user to improve the accuracy of the calibrator.

9.8.3.1 R0

This probe parameter refers to the resistance of the control probe at 0 °C. The value of this parameter is set at the factory for best instrument accuracy.

9.8.3.2 ALPHA

This probe parameter refers to the average sensitivity of the probe between 0 and 100 °C. The value of this parameter is set at the factory for best instrument accuracy.

9.8.3.3 DELTA

This probe parameter characterizes the curvature of the resistance-temperature relationship of the sensor. The value of this parameter is set at the factory for best instrument accuracy.

9.8.3.4 C0 and CG

These parameters calibrate the accuracy of the bath set-point. These are programmed at the factory when the bath is calibrated. DO NOT alter the value of these parameters. If the user desires to calibrate the bath for improved accuracy then calibrate R0 and ALPHA according to the procedure in Section 12.

9.8.3.5 rCAL

DO NOT adjust this parameter. It is for factory use only.

Chapter 10

Digital Communication Interface

The Micro-Bath calibrator is capable of communicating with and being controlled by other equipment through the digital serial interface.

With a digital interface the instrument may be connected to a computer or other equipment. This allows the user to set the set-point temperature, monitor the temperature, and access any of the other controller functions, all using remote communications equipment. Communications commands are summarized in Table 5.

10.1 Serial Communications

The calibrator is installed with an RS-232 serial interface that allows serial digital communications over fairly long distances. With the serial interface the user may access any of the functions, parameters and settings discussed in Section 9 with the exception of the baud rate setting.

10.1.1 Wiring

The serial communications cable attaches to the calibrator through the DB-9 connector at the back of the instrument. Figure 8 shows the pin-out of this connector and suggested cable wiring. To eliminate noise the serial cable should be shielded with low resistance between the connector (DB-9) and the shield. If the unit is used in a heavy industrial setting, the serial cable must be limited to **ONE METER** in length.

10.1.2 Setup

Before operation the serial interface must first be set up by programming the baud rate and other configuration parameters. These parameters are programmed within the serial interface menu. The serial interface parameters menu is outlined in Figure 7 on page 32.

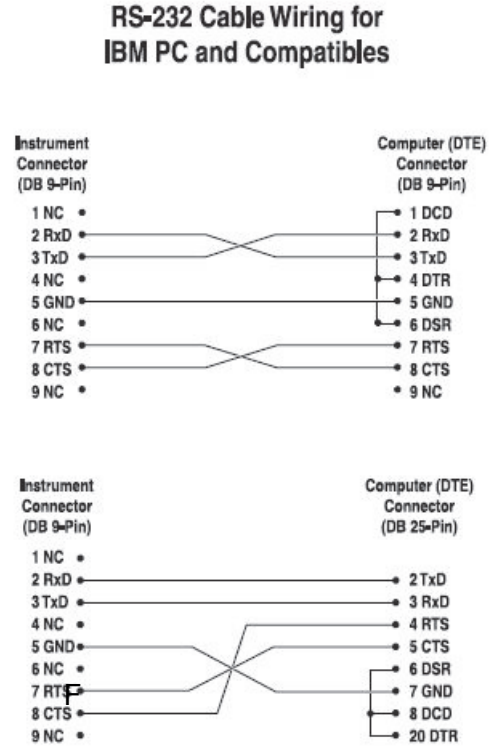

Figure 8. Serial Cable Wiring

To enter the serial parameter programming mode first press "EXIT" while pressing "SET" and release to enter the secondary menu. Press "SET" repeatedly until the display reads "PAR". Press "UP" until the serial interface menu is indicated with "Serial". Finally press "SET" to enter the serial parameter menu. In the serial interface parameters menu are the baud rate, the sample rate, the duplex mode, and the linefeed parameter.

10.1.2.1 Baud Rate

The baud rate is the first parameter in the menu. The display will prompt with the baud rate parameter by showing “bAUd”. Press “SET” to choose to set the baud rate. The current baud rate value will then be displayed. The baud rate of the 7102 serial communications may be programmed to 300, 600, 1200, 2400, 4800, or 9600 baud. The baud rate is pre-programmed to 2400 baud. Use “UP” or “DOWN” to change the baud rate value. Press “SET” to set the baud rate to the new value or “EXIT” to abort the operation and skip to the next parameter in the menu.

10.1.2.2 Sample Period

The sample period is the next parameter in the menu and prompted with “SPeR”. The sample period is the time period in seconds between temperature measurements transmitted from the serial interface. If the sample rate is set to 5, the instrument transmits the current measurement over the serial interface approximately every five seconds. The automatic sampling is disabled with a sample period of 0. Press “SET” to choose to set the sample period. Adjust the period with “UP” or “DOWN” and then use “SET” to set the sample rate to the displayed value.

10.1.2.3 Duplex Mode

The next parameter is the duplex mode indicated with “dUPL”. The duplex mode may be set to half duplex (“HALF”) or full duplex (“FULL”). With full duplex any commands received by the thermometer via the serial interface will be immediately echoed or transmitted back to the device of origin. With half duplex the commands will be executed but not echoed. The default setting is full duplex. The mode may be changed using “UP” or “DOWN” and pressing “SET”.

10.1.2.4 Linefeed

The final parameter in the serial interface menu is the linefeed mode. This parameter enables (“On”) or disables (“OFF”) transmission of a linefeed character (LF, ASCII10) after transmission of any carriage-return. The default setting is with linefeed on. The mode may be changed using “UP” or “DOWN” and pressing “SET”.

10.1.3 Serial Operation

Once the cable has been attached and the interface set up properly the controller will immediately begin transmitting temperature readings at the programmed rate. The serial communications uses 8 data bits, one stop bit, and no parity. The set-point and other commands may be sent via the serial interface to set the temperature set-point and view or program the various parameters. The interface commands are discussed in Section 10.2. All commands are ASCII character strings terminated with a carriage- return character (CR, ASCII 13).

10.2 Interface Commands

The various commands for accessing the calibrator functions via the digital interfaces are listed in this section (see Table 5). These commands are used with the RS-232 serial interface. The commands are terminated with a carriage-return character. The interface makes no distinction between upper and lower case letters, hence either may be used. Commands may be abbreviated to the minimum number of letters which determines a unique command. A command may be used to either set a parameter or display a parameter depending on whether or not a value is sent with the command following a "=" character. For example "s" <CR > will return the current set-point and "s=150.0"<CR> will set the set-point to 150.0 degrees.

In the following list of commands, characters or data within brackets, "[]", are optional for the command. A slash, "/", denotes alternate characters or data. Numeric data, denoted by "n", may be entered in decimal or exponential notation. Characters are shown in lower case although upper case may be used. Spaces may be added within command strings and will simply be ignored. Backspace (BS, ASCII 8) may be used to erase the previous character. A terminating CR is implied with all commands.

Table 5. Controller Communications Commands

Command Description	Command Format	Command Example	Returned	Returned Example	Acceptable Values
Display Temperature					
Read current set-point	s[etpoint]	s	set: 999.99 (C or F)	set: 150.00 C	
Set current set-point to n	s[etpoint]=n	s=200.00			Instrument Range
Read temperature	t[emperature]	t	t: 999.99 (C or F)	t: 55.6 C	
Read temperature units	u[nits]	u	u: x	u: C	
Set temperature units:	u[nits]=c/f				C or F
Set temperature units to Celsius	u[nits]=c	u=c			
Set temperature units to Fahrenheit	u[nits]=f	u=f			
Read scan mode	sc[an]	sc	scan: {ON or OFF}	scan:ON	
Set scan mode	sc[an]=on/off	sc=on			ON or OFF
Read scan rate	sr[ate]	sr	srate: 99.9 (C or F)/min	srate:12.4C/min	
Set scan rate	sr[ate]=n	sr=1.1			.1 to 99.9
Read hold	ho[ld]	ho	hold: open/closed, 99.9 (C or F)	hold: open, 30.5 C	
Secondary Menu					
Read proportional band setting	pr[opband]	pr	pb: 999.9	pb: 15.9	
Set proportional band to n	pr[opband]=n	pr=8.83			Depends on Configuration
Read heater power (duty cycle)	po[wer]	po	po: 999.9	po: 1.0	
Configuration Menu					
Operating Parameters Menu					
Read stirrer motor speed	mo[tor]	mo	mo: 99	mo: 15	
Set stirrer motor speed to n	mo[tor]=n	mo=16			0 to 40
Read high limit	hl	hl	hl:999	hl:126	
Set high limit	hl=n	hl=90			0-126
Serial Interface Menu					
Read serial sample setting	sa[mple]	sa	sa: 9	sa: 1	
Set serial sampling setting to n seconds	sa[mple]=n	sa=0			0 to 999
Set serial duplex mode:	du[plex]=f[ull]/h[alf]				FULL or HALF
Set serial duplex mode to full	du[plex]=f[ull]	du=f			
Set serial duplex mode to half	du[plex]=h[alf]	du=h			
Set serial linefeed mode:	lf[eed]=on/off				ON or OFF
Set serial linefeed mode to on	lf[eed]=on	lf=on			
Set serial linefeed mode to off	lf[eed]=off	lf=of			
Calibration Menu					
Read R0 calibration parameter	r[0]	r	r0: 999.999	r0: 100.578	
Set R0 calibration parameter to n	r[0]=n	r=100.324			90 to 110
Read ALPHA calibration parameter	al[pha]	al	al: 9.9999999	al: 0.0038573	
Set ALPHA calibration parameter	al[pha]=n	al=0.0038433			.002 to .005
Read DELTA calibration parameter	de[ltta]	de	de:9.99999	de: 1.507	
Set DELTA calibration parameter	de[ltta]=n	de=1.3742			0-3.0
Read C0 calibration parameter	*c[0]	*c	c0:99.9999	c0:-0.297	
Set C0 calibration parameter	*c[0]=n	*c=-5.113			
Read CG calibration parameter	*cg	*cg	cg:99.999	cg:-0.555	
Set CG calibration parameter	*cg=n	*cg=4.115			
Functions not on menu					
Read firmware version number	*ver[sion]	*ver	ver:9999,9.99	ver:7102,2.00	
Read structure of all commands	h[elp]	h	list of commands		
Read all operating parameters	all	all	list of parameters		
Legend:	[] Optional Command data				
	{ } Returns either information				
	n Numeric data supplied by user				
	9 Numeric data returned to user				
	x Character data returned to user				
Note:	When DUPLEX is set to FULL and a command is sent to READ, the command is returned followed by a carriage return and linefeed. Then the value is returned as indicated in the RETURNED column.				

Chapter 11

Test Probe Calibration

Note:

This procedure is to be considered a general guideline. Each laboratory should write their own procedure based on their equipment and their quality program. Each procedure should be accompanied by an uncertainty analysis also based on the laboratory's equipment and environment.

For optimum accuracy and stability, allow the calibrator to warm up for 25 minutes after power-up and then allow adequate stabilization time after reaching the set-point temperature. After completing operation of the calibrator, allow the well to cool by setting the temperature to 25 °C for one-half hour before switching the power off.

11.1 Calibrating a Single Probe

Insert the probe to be calibrated into the well of the bath. Best results are obtained with the probe inserted to the full depth of the well. Once the probe is inserted into the well, allow adequate stabilization time to allow the test probe temperature to settle as described above. Once the probe has settled to the temperature of the well, it may be compared to the calibrator display temperature. The display temperature should be stable to within 0.1 °C degree for best results.



Caution:

Never introduce any foreign material into the well.

11.2 Stabilization and Accuracy

The stabilization time of the Micro-Bath depends on the conditions and temperatures involved. Typically the test well will be stable to 0.1 °C within 10 minutes of reaching the set-point temperature. Ultimate stability will be achieved 30 minutes after reaching the set temperature.

Inserting a cold probe into a well requires another period of stabilizing depending on the magnitude of the disturbance and the required accuracy. For example, inserting a .25 inch diameter room temperature probe at 200 °C takes 5 minutes to be within 0.1 °C of its settled point and takes 10 minutes to achieve maximum stability.

Speeding up the calibration process can be accomplished by knowing how soon to make the measurement. Typical measurements should be made at the desired temperatures with the desired test probes to establish these times.

Chapter 12

Calibration Procedure

Note:

This procedure is to be considered a general guideline. Each laboratory should write their own procedure based on their equipment and their quality program. Each procedure should be accompanied by an uncertainty analysis also based on the laboratory's equipment and environment.

Sometimes the user may want to calibrate the bath to improve the temperature set-point accuracy. Calibration is done by adjusting the controller probe calibration constants R0, ALPHA, and DELTA so that the temperature of the bath as measured with a standard thermometer agrees more closely with the set-point. The thermometer used must be able to measure the well temperature with higher accuracy than the desired accuracy of the bath. By using a good thermometer and following this procedure the bath can be calibrated to an accuracy of better than 0.5 °C up to 200 °C.

12.1 Calibration Points

In calibrating the bath, R0, ALPHA, and DELTA are to minimize the set-point error at each of three different bath temperatures. Any three reasonably separated temperatures may be used for the calibration. Improved results can be obtained for shorter ranges when using temperatures that are just within the most useful operating range of the Micro-Bath. The farther apart the calibration temperatures, the larger will be the calibrated temperature range but the calibration error will also be greater over the range. If for instance 50 °C to 150 °C is chosen as the calibration range then the calibrator may achieve an accuracy of say ± 0.3 °C over the range 50 to 150 °C. Choosing a range of 50 °C to 90 °C may allow the calibrator to have a better accuracy of maybe ± 0.2 °C over that range but outside that range the accuracy may be only ± 1.5 °C.

12.2 Calibration Procedure

1. Choose three set-points to use in the calibration of the R0, ALPHA, and DELTA parameters. These set-points are generally 40.0 °C, 95 °C, and 195.0 °C but other set-points may be used if desired or necessary.
2. Set the bath to the low set-point. When the bath reaches the set-point and the display is stable, wait 15 minutes or so and then take a reading from the thermometer. Sample the set-point resistance by holding down the “SET” key and pressing the “DOWN” key. Write these values down as T1 and R1 respectively.
3. Repeat step 2 for the other two set-points recording them as T₂, R₂, T₃, and R₃ respectively.
4. Using the recorded data, calculate new values for R0, ALPHA, and DELTA parameters using the equations given below:

12.2.1 Compute DELTA

$$A = T_3 - T_2$$

$$B = T_2 - T_1$$

$$C = \left[\frac{T_3}{100} \right] \left[1 - \frac{T_3}{100} \right] - \left[\frac{T_2}{100} \right] \left[1 - \frac{T_2}{100} \right]$$

$$D = \left[\frac{T_2}{100} \right] \left[1 - \frac{T_2}{100} \right] - \left[\frac{T_1}{100} \right] \left[1 - \frac{T_1}{100} \right]$$

$$E = R_3 - T_2$$

$$F = R_2 - T_1$$

$$\text{delta} = \frac{AF = BE}{DE - CF}$$

T₁₋₃ – Measured temperature using thermometer.

T₁₋₃ – Value of R from display of 7102 (Press SET and DOWN at the same time.)

where

T_1 and R_1 are the measured temperature and resistance at 50.0 °C

T_2 and R_2 are the measured temperature and resistance at 90.0 °C

T_3 and R_3 and R are the measured temperature and resistance at 150.0 °C

12.2.2 Compute R0 & ALPHA

$$a_1 = T_1 + \text{delta} \left[\frac{T_1}{100} \right] \left[1 - \frac{T_1}{100} \right]$$

$$a_3 = T_3 + \text{delta} \left[\frac{T_3}{100} \right] \left[1 - \frac{T_3}{100} \right]$$

$$rzero = \frac{R_3 a_1 = R_1 a_3}{a_1 - a_3}$$

$$\text{alpha} = \frac{R_1 - R_3}{R_3 a_1 = R_1 a_3}$$

Where:

delta is the new value of DELTA computed above

Program the new values for DELTA (delta), R0 (rzero), and ALPHA (alpha) into the Micro-Bath with the following steps.

- Press “SET” and “EXIT” keys at the same time and then press “UP” until “CAL” is displayed.
- Press “SET” five times until “R0” is displayed.
- Press “SET” then use the “UP” or “DOWN” keys until the correct numerical setting is displayed. Press “SET” to accept the new value.
- Repeat step 2 for ALPHA and DELTA.

12.2.3 Accuracy & Repeatability

Check the accuracy of the Micro-Bath at various points over the calibrated range. If Micro-Bath does not pass specification at all set-points, repeat the **Calibration Procedure**.

Chapter 13

Maintenance

- The calibration instrument has been designed with the utmost care. Ease of operation and simplicity of maintenance have been a central theme in the product development. Therefore, with proper care the instrument should require very little maintenance. Avoid operating the instrument in an oily, wet, dirty, or dusty environment.
- If the outside of the instrument becomes soiled, it may be wiped clean with a damp cloth and mild detergent. Do not use harsh chemicals on the surface which may damage the paint.
- It is important to keep the well of the calibrator clean and clear of any foreign matter. DO NOT use chemicals to clean the well.
- The bath should be handled with care. Avoid knocking or dropping the instrument.
- If a hazardous material is spilt on or inside the equipment, the user is responsible for taking the appropriate decontamination steps as outlined by the national safety council with respect to the material.
- If the mains supply cord becomes damaged, replace it with a cord with the appropriate gauge wire for the current of the instrument. If there are any questions, call an Authorized Service Center for more information.
- Before using any cleaning or decontamination method except those recommended by Hart, users should check with an Authorized Service Center to be sure that the proposed method will not damage the equipment.
- If the instrument is used in a manner not in accordance with the equipment design, the operation of the Micro-Bath may be impaired or safety hazards may arise.

Chapter 14

Troubleshooting

This section contains information on troubleshooting and CE Comments.

14.1 Troubleshooting Problems, Possible Causes, and Solutions

In the event that the instrument appears to function abnormally, this section may help to find and solve the problem. Several possible problem conditions are described along with likely causes and solutions. If a problem arises, please read this section carefully and attempt to understand and solve the problem. If the problem cannot otherwise be solved, contact an Authorized Service Center (see Section 1.3). Be sure to have the model number and serial number of your instrument available.

Problem	Possible Causes and Solutions
Incorrect temperature reading	<p>Incorrect R0, ALPHA, and DELTA parameters. Find the value for R0, ALPHA, and DELTA on the Report of Calibration that was shipped with the instrument. Reprogram the parameters into the instrument (see Section 9.8.3, Calibration Parameters). Allow the instrument to stabilize and verify the accuracy of the temperature reading.</p> <p>Controller locked up. The controller may have locked up due to a power surge or other aberration. Initialize the system by performing the Factory Reset Sequence.</p> <p>Factory Reset Sequence. Hold the SET and EXIT buttons down at the same time while powering up the instrument. The instrument displays shows '-init-', the model number, and the firmware version. Each of the controller parameters and calibration constants must be reprogrammed. The values can be found on the Report of Calibration that was shipped with the instrument.</p>

<p>The instrument heats or cools too quickly or too slowly</p>	<p>Incorrect scan and scan rate settings. The scan and scan rate settings may be set to unwanted values. Check the Scan and Scan Rate settings. The scan may be off (if the unit seems to be responding too quickly). The scan may be on with the Scan Rate set low (if unit seems to be responding too slowly).</p>
<p>An "o" is displayed at the left of the display</p>	<p>External switch is open. The external switch is open causing the displayed temperature to be frozen and keeping the set-point from scanning. Turn the switch test off by pressing the "DOWN" button on the front panel.</p>
<p>The display shows any error</p>	<p>Controller problem. The error messages signify the following problems with the controller.</p> <p>Err 1 – a RAM error Err 2 – a NVRAM error Err 3 – a Structure error Err 4 – an ADC setup error Err 5 – an ADC ready error Err 6 – Defective control sensor. The control sensor may be shorted, open or otherwise damaged.</p> <p>Initialize the system by performing the Factory Reset Sequence described above.</p> <p>Err 7 – Heater control error. Initialize the system by performing the Factory Reset Sequence described above.</p>
<p>The stirrer is not stirring</p>	<p>Stirrer speed needs adjusting. In the Operating Parameters menu, adjust the stirrer speed ("Str Sp") to 0. Wait for the motor to stop. Adjust the stirrer speed to a setting greater than 8 but less than or equal to 25.</p>
<p>Temperature readout is not the actual temperature of the well</p>	<p>Possible RF energy emission. With the unit stable, slowly rotate the unit. If no change occurs, the unit may need to be calibrated. If the display changes more than twice the normal display deviation, another unit in the area could be emitting RF energy. Move the unit to a different location and rotate the unit again. If the temperature is correct in this new area or deviates differently than the first are, RF energy is present in the room. If you have to perform the test in the affected area, use the comparison test to eliminate any possible errors.</p>
<p>Instrument is unstable</p>	<p>Varying line voltage or fluid is not stirring. Place the unit on a clean power line. If the fluid is not stirring, turn the instrument off for one minute</p>

AC voltage present on the chassis	Use a wall plug tester to check the main power plug at the wall. Use an ohmmeter to check the continuity between the ground prong on the PEM and the chassis. If the resistance reading is greater than three ohms, there is a problem. Check the power cord for continuity on the ground prongs. If the resistance is greater than one ohm, replace the power cord.
-----------------------------------	--

14.2 Comments

14.2.1 EMC Directive

Hart Scientifics' equipment has been tested to meet the European Electromagnetic Compatibility Directive (EMC Directive, 89/336/EEC). The Declaration of Conformity for your instrument lists the specific standards to which the unit was tested.

14.2.2 Low Voltage Directive (Safety)

In order to comply with the European Low Voltage Directive (73/23/EEC), Hart Scientific equipment has been designed to meet the EN 61010-1 and EN 61010-2-010 standards.

