



INSTRUMENTS

GX-6100

Operator's Manual

Part Number: 71-0638

Revision: P1

Released: 9/11/25

WARNING

Read and understand this instruction manual before operating instrument. Improper use of the gas monitor could result in bodily harm or death.

Periodic calibration and maintenance of the gas monitor is essential for proper operation and correct readings. Please calibrate and maintain this instrument regularly! Frequency of calibration depends upon the type of use you have and the sensor types. For most applications, typical calibration frequencies are between 3 and 6 months but can be more often or less often based on your usage.

Table of Contents

Chapter 1: Introduction	11
Overview	11
About the GX-6100	11
Specifications	12
About this Manual	15
Chapter 2: Description	16
Overview	16
Instrument Description	16
<i>Case</i>	16
<i>LCD</i>	17
<i>Control Buttons</i>	17
<i>Flashlight LED</i>	17
<i>Alarm LEDs</i>	17
<i>Infrared Communications Port</i>	18
<i>Buzzer</i>	18
<i>Vibrator</i>	18
<i>Printed Circuit Boards (PCBs)</i>	18
<i>Pump</i>	18
<i>Flow Chamber</i>	18
<i>Sensors</i>	19
<i>Filters</i>	20
<i>Inlet Filter Holder</i>	21
<i>Batteries</i>	21
Included Accessories	22
<i>Tapered Rubber Nozzle</i>	22
<i>Belt Clip</i>	22
<i>Rubber Boot</i>	22
<i>Wrist Strap</i>	22
<i>Sample Hose and Probe</i>	22
<i>Screen Protector</i>	23

Other Accessories	24
<i>VOC Zero Filter</i>	24
<i>External Dilution Fitting</i>	25
<i>DIN Rail Mounting Assembly</i>	25
Chapter 3: Normal Mode.....	28
Overview	28
Start Up	28
<i>Turning On the GX-6100</i>	28
<i>Performing a Demand Zero</i>	36
<i>Turning Off the GX-6100</i>	36
Measuring Mode, Normal Operation	37
<i>Monitoring an Area</i>	38
<i>Using Optional Sample Hoses</i>	39
<i>Combustible Gas Detection</i>	39
<i>VOC Detection</i>	42
<i>Snap Log Mode</i>	44
Measuring Mode, Alarms	46
<i>Alarm Indications</i>	46
<i>Responding to Alarms</i>	48
Data Logging	53
Chapter 4: Display Mode.....	55
Tips for Using Display Mode	56
Select PID Gas Name Screen	56
LEL Sensor Target Gas Conversion (HC GAS LIST)	58
Changing the HC Range Setting (HC RANGE SELECT)	61
Viewing and Clearing the Peak Readings (PEAK)	62
STEL Screen	63
TWA Screen	63
Changing the User ID	64
Changing the Station ID	65
Viewing Snap Log Data (REC. DATA DISP)	66
Turning the Pump Off	67

Date/Time, Battery Voltage Screen	68
Viewing the Alarm Points	69
Changing the LCD Flip Setting (INVERSION SELECT)	71
Changing the LCD Background Color	72
Peak Bar Screen	73
Gas Display Screen	74
Turning Bluetooth On/Off (BLUETOOTH)	75
Selecting the Buzzer Volume (BUZZER VOLUME)	76
Chapter 5: User Mode and Calibration	77
Overview	77
Tips for Using User Mode	79
Entering User Mode	80
Performing a Bump Test	80
Performing a Calibration (GAS CAL)	86
<i>Calibration Supplies and Equipment</i>	87
<i>Setting the Fresh Air Reading</i>	87
<i>Performing a Span Adjustment</i>	93
Setting Calibration Concentration Values (SETTING CAL-P)	100
Setting Cylinder Names (CYL SETTING)	103
Changing the Alarm Settings	105
<i>Changing the Alarm Setpoints (ALARM POINTS)</i>	106
<i>Setting Alarms to Latching or Self-Resetting (LATCHING)</i>	108
<i>Turning the Alarm Silence Function On/Off (ALARM SILENCE)</i>	109
<i>Turning the Leak Mode Silence Function On/Off (LEAK SILENCE)</i>	110
<i>Turning the Alarm Function On/Off (ALARM ON)</i>	111
Changing the Man Down Settings (MAN DOWN)	112
Adjusting the CO2 Fresh Air Setting	114
Setting the Date and Time	114
Changing the Date Format	115
Changing the Language Setting	116
Viewing the Version Numbers (VERSION)	117
Exiting User Mode (START MEASURE)	118

Chapter 6: Maintenance	119
Overview	119
Troubleshooting	119
Replacing or Recharging the Batteries	121
<i>Replacing Alkaline Batteries</i>	121
<i>Replacing the Lithium Ion Battery Pack</i>	123
<i>Recharging the Lithium Ion Battery Pack in the Instrument</i>	124
<i>Recharging the Lithium Ion Battery Pack Out of the Instrument</i>	127
Replacing the Probe's Particle Filter and Hydrophobic Filter Disk	130
Replacing the Sensor Filters	131
Replacing a Sensor	134
Replacing the Hydrophobic Filter and Wire Mesh Disk	137
PID Sensor Maintenance	138
<i>Cleaning the PID Sensor's Lamp, 10.0 eV and 10.6 eV Lamps</i>	138
<i>Replacing the PID Sensor's Lamp</i>	142
<i>Replacing the PID Sensor's Electrode Stack</i>	146
 Chapter 8: General Parts List	 151
 Appendix A: Maintenance Mode	 155
Entering Maintenance Mode	156
Tips for Using Maintenance Mode	156
Performing a Calibration (GAS CALIBRATION)	157
Performing a Bump Test (BUMP TEST)	158
Setting the Date and Time (DATE)	158
Setting the Date Format (DATE FORMAT)	158
Updating the Language Setting (LANGUAGE)	159
Viewing the ROM/SUM of the Instrument (VERSION)	160
Restoring the Default Settings (RESTORE DEFAULT)	161
Exiting Maintenance Mode (START MEASURE)	163
 Appendix B: Using the GX-6100 in Leak Check Mode	 164
Overview	163

Start Up, Leak Check Mode	165
<i>Turning On the GX-6100, Leak Check Mode</i>	165
<i>Performing a Demand Zero, Leak Check Mode</i>	166
Leak Testing	167
<i>Setting the Display Range Value</i>	167
<i>Turning the Alarm On and Off</i>	167
<i>Locating a Leak</i>	168
<i>Overscale Conditions</i>	168
<i>Peak Hold Mode</i>	169
<i>Snap Log Mode, Leak Check Mode Operation</i>	170
<i>Viewing Snap Log Data in Leak Check Mode Operation</i>	172
<i>Turning Off the GX-6100, Leak Check Mode</i>	175
Appendix C: Using the GX-6100 in Bar Hole Mode	177
Overview	177
Start Up, Bar Hole Mode	178
<i>Turning On the GX-6100, Bar Hole Mode</i>	178
<i>Performing a Fresh Air Adjustment, Bar Hole Mode</i>	180
Bar Hole Testing	180
<i>Performing a Bar Hole Test</i>	181
<i>Turning Off the GX-6100, Bar Hole Mode</i>	183
Appendix D: Interference Information	184
ESR-A13i-H2S, H ₂ S Detection	184
ESR-A13P-CO, CO Detection	186
ESR-A1CP-COH, H ₂ -Compensated CO Detection	188
ESR-A1DP-COHS, CO Detection	190
ESR-A1DP-COHS, H ₂ S Detection	191
Appendix E: Using the GX-6100 in Inert Mode	194
Alarms	194
Start Up and Operation	195
Appendix F: ESS-03 Toxic Sensors	197
Overview	197

Description	197
Interference	198
Start Up and Normal Operation	199
ESS-03 Calibration	200
ESS-03 Bump Testing	201
Replacing the ESS-03 Sensor or Changing Sensor Type	201
Replacing the HCN or SO ₂ Sensor's Filter Set	203
Parts List	205

Appendix G: Infrared Sensors 207

Overview	207
<i>IR HC Target Gases</i>	207
<i>IR CH₄ Target Gases</i>	207
Description	208
<i>IR Sensor</i>	208
<i>CO₂ Scrubber</i>	209
<i>VOC Zero Filter</i>	209
IR HC Start Up and Normal Operation	210
<i>0-100% LEL/2.0-30.0% vol Autoranging</i>	210
IR CH ₄ Start Up and Normal Operation	210
<i>0 - 100% LEL/5.0 - 100.0% vol Autoranging</i>	210
IR CO ₂ Start Up and Normal Operation	211
<i>Performing a Demand Zero for Carbon Dioxide Sensors</i>	211
<i>Performing a Demand Zero for Instruments with a CO₂ and PID or NH₃ Sensor</i> .	212
IR Calibration	213
IR Bump Testing	213
Replacing an IR Sensor	213
Parts List	215

Appendix H: 10.0 eV/Benzene PID Sensor 216

Overview	216
Sensor Description	217
Tube and Tube Holder	217
<i>Tube</i>	217
<i>Tube Holder</i>	217

Start Up	218
Display Mode	219
Measuring Mode	220
Benzene Select Mode	220
Viewing Benzene Select Mode Data	226
Calibrating the 10.0 eV/Benzene PID Sensor	229
<i>Important Calibration Information</i>	229
<i>Setting the Fresh Air Reading</i>	230
<i>Performing a SPAN CAL</i>	230
<i>Performing a TUBE CAL</i>	231
<i>Entering a CAL CODE</i>	234
Maintenance	235
<i>Replacing a Sensor</i>	235
<i>PID Sensor Maintenance</i>	235
<i>Replacing a Tube</i>	236
Parts List for 10.0 eV/Benzene PID Instruments	237
Appendix I: 11.7 eV PID Sensor	239
Overview	239
11.7 eV PID Lamp Warranty	239
Description	240
<i>Instrument</i>	240
<i>Sensor</i>	240
<i>Dehumidifier Filter</i>	240
Start Up	241
Display Mode	241
Measuring Mode	242
<i>Turning off a GX-6100 with an 11.7 eV Sensor</i>	242
Calibrating the 11.7 eV PID Sensor	243
<i>Setting the Fresh Air Reading</i>	243
<i>Performing a SPAN CAL</i>	243

Maintenance	244
<i>Replacing the Dehumidifier Filter</i>	244
<i>Replacing a Sensor</i>	244
<i>Replacing the PID Sensor's Lamp and Electrode Stack.</i>	244
<i>Cleaning the 11.7 eV PID Sensor's Lamp.</i>	244
Parts List for 11.7 eV PID Instruments.	244

WARNING: *Understand manual before operating. Substitution of components may impair intrinsic safety. To prevent ignition of a hazardous atmosphere, batteries must only be changed or charged in an area known to be nonhazardous. Not tested in oxygen enriched atmospheres (above 21%).*

NOTE: RKI Instruments, Inc. recommends that you refer to ISA-RP12.13, Part II-1987 or an equivalent international recommended practice for guidance in the use of combustible gas detection instruments.

Chapter 1: Introduction

Overview

This chapter briefly describes the GX-6100 gas monitor. This chapter also describes the *GX-6100 Operator's Manual* (this document). Table 1 at the end of this chapter lists the specifications for the GX-6100.

About the GX-6100

Using an advanced detection system consisting of up to six gas sensors, the GX-6100 sample draw gas monitor is capable of detecting the presence of combustible gas, oxygen (O₂), carbon monoxide (CO), hydrogen sulfide (H₂S), and various other toxic gases simultaneously. The GX-6100's rugged, reliable, and easy-to-use design makes it ideally suited for a wide range of applications, including sewage treatment plants, utility manholes, tunnels, hazardous waste sites, power stations, petrochemical refineries, mines, paper mills, drilling rigs, and fire fighting stations. The GX-6100 offers a full range of features including:

- Simultaneous monitoring of one to six gases.
- Choice of three operating modes:
 - Normal Mode for typical confined space or area monitoring. Normal Mode is the standard factory setting.
 - Bar Hole Mode for checking of bar holes when searching for underground gas leaks
 - Leak Check Mode for locating leaks in valves and piping
- Sample-drawing pump with up to 100-foot range
- Liquid crystal display (LCD) for complete and understandable information at a glance
- Ultrabright alarm LEDs
- Distinctive audible/vibrating alarms for dangerous gas conditions and audible alarms for unit malfunction
- Microprocessor control for reliability, ease of use, and advanced capabilities
- Data logging functions (when used in Normal Mode)
- Alarm trend data (when used in Normal Mode)
- STEL and TWA (when used in Normal Mode) and over range alarms
- Peak readings (when used in Normal Mode)
- Built-in time function
- Lunch break feature
- RF shielded high impact plastic case
- CSA "C/US" classification for Class I, Division I, Groups A, B, C, and D hazardous atmospheres (pending)

WARNING: *The Model GX-6100 detects oxygen deficiency, elevated levels of oxygen, combustible gases, carbon monoxide, and hydrogen sulfide, all of which can be dangerous or life threatening. When using the GX-6100, you must follow the instructions and warnings in this manual to assure proper and safe operation of the unit and to minimize the risk of personal injury. Be sure to maintain and periodically calibrate the GX-6100 as described in this manual.*

NOTE: ONLY THE COMBUSTIBLE GAS DETECTION PORTION OF THIS INSTRUMENT HAS BEEN ASSESSED FOR PERFORMANCE.

Specifications

Table 1: Standard Sensor Specifications/Alarm Points

	Methane Calibration Standard (CH ₄)*		Oxygen (O ₂)	Hydrogen Sulfide (H ₂ S)	Carbon Monoxide (CO)	VOCs, Isobutylene Calibration Standard*	
	%LEL, Combustible Gas	%Volume (%VOL), Combustible Gas				Low Range PID	High Range PID
Detection Range	0 - 100% LEL	0 - 100% vol.	0 - 40% vol.	0 - 200.0 ppm	0 - 2000 ppm	0 - 40,000 ppb	0 - 4000 ppm
Reading Increment	1% LEL	1% vol.	0.1% vol.	0.5 ppm	1 ppm	0 - 5000: 1 ppb	0 - 600: 0.1 ppm
						5000 - 40,000: 10 ppb	600 - 4000: 1 ppm
Alarm 1 Factory Setting	10% LEL	n/a	19.5% vol., decreasing	5.0 ppm	25 ppm	5000 ppb	400 ppm
Alarm 2 Factory Setting	25% LEL	n/a	18.0% vol., decreasing	30.0 ppm	50 ppm	10,000 ppb	1000 ppm
Alarm 3 Factory Setting	50% LEL	n/a	25.0% vol., increasing	100.0 ppm	1200 ppm	10,000 ppb	1000 ppm
STEL Alarm	n/a	n/a	n/a	5.0 ppm	200 ppm	n/a	60.0 ppm
TWA Alarm	n/a	n/a	n/a	1.0 ppm	25 ppm	n/a	40.0 ppm

* Although calibrated to a specific gas, these sensors will respond to a variety of gases.

NOTE: Refer to "Sensor Specifications, Leak Check Mode" on page 164 for sensor performance while the instrument is in Leak Check Mode.

Table 2: GX-6100 Specifications

Sampling Method	Sample Draw
Response Time	T90 Within 30 Seconds
Display	Graphics LCD Display
Operating Temperature & Humidity	-20°C to 50°C/Below 95% RH (Without Condensation)
Buzzer Volume	95 dB at 30 cm.
Indication Accuracy	<p><u>Combustible Gas (Catalytic Sensor)</u></p> <ul style="list-style-type: none"> • -40°C to -21°C and 51°C to 60°C (Temporary environment): ± 10% LEL • -20°C to 50°C (Continuous environment): ± 5% of reading or ± 2% LEL <p><u>Oxygen</u></p> <ul style="list-style-type: none"> • 0 - 25.0%: ± 0.5% O₂ • 25.1 - 40.0%: ± 3.0% O₂ <p><u>Hydrogen Sulfide</u></p> <ul style="list-style-type: none"> • 0 - 100 ppm: ± 5% of reading or ± 2 ppm H₂S (whichever is greater) • 101 - 200 ppm: ± 20% of reading <p><u>Carbon Monoxide</u></p> <ul style="list-style-type: none"> • 0 - 500 ppm: ±5% of reading or ± 5 ppm CO (whichever is greater) • 501 - 2000 ppm: ± 20% of reading <p><u>PID</u></p> <ul style="list-style-type: none"> • ± 10% of reading or ± 1 increment (whichever is greater)
Zero Suppression	<ul style="list-style-type: none"> • Combustible Gas: 2% LEL • O₂: 0.5% vol. • H₂S: 0.3 ppm • CO: 2 ppm • CO₂: 0 ppm • HCN: 0.5 ppm • NH₃: 4 ppm • NO₂: 0.30 ppm • PH₃: 0.02 ppm • SO₂: 0.20 ppm

Table 2: GX-6100 Specifications

Safety/ Regulatory	<p><u>ATEX (Certificate Number DEKRA 24ATEX0016)</u></p> <p>With new ceramic type sensor:</p> <ul style="list-style-type: none"> • II 1 G Ex da ia IIC T4 Ga (BUL-6100) • II 1 G Ex da ia IIC T4 Ga (BUD-6100/Toshiba batteries) • II 1 G Ex da ia IIC T3 Ga (BUD-6100/Duracell batteries) <p>Without new ceramic type sensor:</p> <ul style="list-style-type: none"> • II 1 G Ex ia IIC T4 Ga (BUL-6100) • II 1 G Ex ia IIC T4 Ga (BUD-6100/Toshiba batteries) • II 1 G Ex ia IIC T3 Ga (BUD-6100/Duracell batteries)
	<p><u>IECEX (Certificate Number IECEX DEK 24.0014)</u></p> <p>With new ceramic type sensor:</p> <ul style="list-style-type: none"> • Ex da ia IIC T4 Ga (BUL-6100) • Ex da ia IIC T4 Ga (BUD-6100/Toshiba batteries) • Ex da ia IIC T3 Ga (BUD-6100/Duracell batteries) <p>Without new ceramic type sensor:</p> <ul style="list-style-type: none"> • Ex ia IIC T4 Ga (BUL-6100) • Ex ia IIC T4 Ga (BUD-6100/Toshiba batteries) • Ex ia IIC T3 Ga (BUD-6100/Duracell batteries)
	<ul style="list-style-type: none"> • CSA classified (Pending), “C/US”, as Intrinsically Safe. Exia. • Class I, Groups A, B, C, & D. Temperature Code T3A. <div style="text-align: center;">  <p>C US 186718</p> </div>
Power Supply	<ul style="list-style-type: none"> • Three AA size alkaline batteries <p>OR</p> <ul style="list-style-type: none"> • One lithium ion battery pack
Continuous Operating Hours @ 25 °C	<ul style="list-style-type: none"> • Alkaline Batteries: 8 Hours (Non Alarm Operation, Fully Charged) • Li-ion Battery Pack: 28 Hours (Non Alarm Operation, Fully Charged)
Case	High-impact Plastic, RF Shielded, Dust and Weather Proof (IP67 equivalent)

Table 2: GX-6100 Specifications

<p>Included Accessories</p>	<ul style="list-style-type: none"> • Belt clip • Rubber boot • Wrist strap • Tapered nozzle • Screen protector • 3-foot hose and probe • VOC zero filter (included for instruments with a low range PID sensor, a 10.0 eV/benzene PID sensor, an 11.7 eV PID sensor, any PID/IR CO₂, or any NH₃/CO₂ combination) • Dehumidifier filter (included for instruments with an 11.7 eV PID sensor)
<p>Other Accessories</p>	<ul style="list-style-type: none"> • Alkaline Battery Pack • Rechargeable Li-ion Battery Pack • 115 VAC Charger • 12 VDC Charger • Hose/Probes of Various Lengths, see “Chapter 8: General Parts List” on page 151. • VOC Zero Filter (optional for instruments with a high range PID sensor) • Dilution Fitting (1:1) • DIN Rail Mounting Assembly (for mounting chargers to the wall) • IrDA/USB Cable for connecting to a computer when using the Data Logger Management Program (not needed if computer has an infrared port)
<p>Dimensions and Weight</p>	<p>Approximately 201(H) x 70(W) x 56(D) mm (7.9”H x 2.6”W x 2.2”D) Alkaline Type: approximately 450 g (15.8 oz.) Lithium-Ion Type: approximately 500 g (17.6 oz.)</p>

About this Manual

Although the GX-6100 can support up to 6 sensors, this manual specifically describes an instrument with the four standard sensors and a PID sensor. See the appendices for descriptions of other sensors.

The *GX-6100 Operator’s Manual* uses the following conventions for notes, cautions, and warnings.

NOTE: Describes additional or critical information.

CAUTION: Describes potential damage to equipment.

WARNING: Describes potential danger that can result in injury or death.

Chapter 2: Description

Overview

This chapter describes the GX-6100 instrument and accessories.

Instrument Description

The GX-6100 includes the case, LCD, control buttons, flashlight LED, alarm LEDs, infrared communication port, buzzer, vibrator, printed circuit board, pump, flow chamber, sensors, filters, inlet filter holder, and batteries.

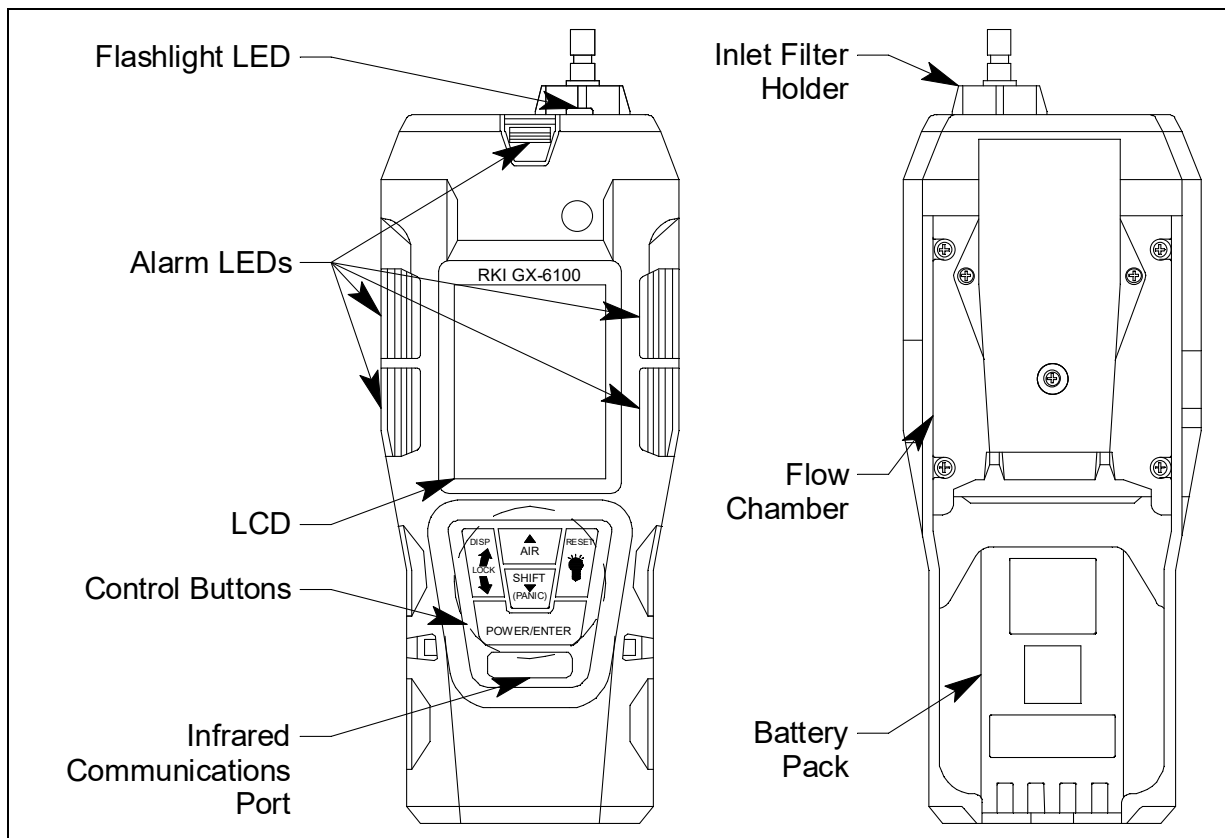

Figure 1: Component Location

Case

The GX-6100's sturdy, high-impact plastic case is radio frequency (RF) resistant and is suitable for use in many environmental conditions, indoors and out. The case is dust proof and water resistant. A clear plastic window is located on the front of the case. The battery pack and flow chamber are located on the back of the GX-6100. The inlet filter holder is located on the top of the GX-6100 case.

LCD

A digital LCD (liquid crystal display) is visible through a clear plastic window in the top case. The LCD simultaneously shows the gas reading for all installed sensors. The LCD also shows information for each of the GX-6100's operating modes.

Control Buttons

Five control buttons are located below the LCD. They are, from left to right and top to bottom, DISP/LOCK, ▲ AIR, SHIFT ▼ (PANIC), POWER/ENTER, and RESET.

Table 3: GX-6100 Control Button Functions

Button	Function(s)
DISP/LOCK	<ul style="list-style-type: none">• activates Display Mode• enters instructions into the GX-6100's microprocessor• allows you to exit a menu without saving changes• locks screen orientation in any mode if INVERSION SELECT is set to ON
▲ AIR	<ul style="list-style-type: none">• activates the demand zero function (adjusts the GX-6100's fresh air reading)• enters instructions into the GX-6100's microprocessor• moves the cursor on the LCD up the screen• increases the value of a parameter available for adjustment• scrolls through parameter options
SHIFT ▼ (PANIC)	<ul style="list-style-type: none">• enters instructions into the GX-6100's microprocessor• moves the cursor on the LCD down the screen• decreases the value of a parameter available for adjustment• scrolls through parameter options• initiates a Panic alarm in any mode if PANIC is set to ON
POWER/ENTER	<ul style="list-style-type: none">• turns the GX-6100 on and off• enters instructions, values, and settings into the GX-6100's microprocessor
RESET	<ul style="list-style-type: none">• silences and resets audible alarm if ALARM LATCHING is set to LATCHING and ALARM SILENCE is set to ON• turns the flashlight LED on and off

Flashlight LED

A white LED is visible through a round, raised, frosted lens in the top of the case. This LED can be used to provide extra light, if necessary. The RESET button turns this LED on and off.

Alarm LEDs

Five sets of red alarm LEDs (light emitting diodes) border the LCD. The alarm LEDs alert you to gas, low battery, and failure alarms.

Infrared Communications Port

An infrared (IR) communications port is located on the front of the case, below the POWER/ENTER button. The data transmitted through the port is in standard IrDA protocol. A computer's infrared port or an IrDA/USB cable connected to a USB port can be used to download data saved by the GX-6100 to a computer using the GX-6100 Data Logger Management Program. See the GX-6100 Data Logger Management Program operator's manual for data logging and downloading instructions.

Buzzer

One solid-state electronic buzzer is located inside the case. Holes on the top front of the case allow the sound to exit the case. The buzzer sounds for gas alarms, malfunctions, low battery voltage, and as an indicator during use of the GX-6100's many display and adjustment options.

Vibrator

A vibrating motor inside the GX-6100 case vibrates for gas alarms, unit malfunctions, and as an indicator during normal use of the various modes of the GX-6100.

Printed Circuit Boards (PCBs)

The GX-6100 printed circuit boards analyze, record, control, store, and display the information collected. The circuit boards are located inside the case. They are not user serviceable.

Pump

A diaphragm pump inside the GX-6100 draws the sample to the sensors. It can draw sample from as far as 100 feet from the GX-6100. The pump is not user-serviceable.

CAUTION: *Sample hose lengths of more than 100 feet are not recommended for the GX-6100 because of flow rate reduction.*

Flow Chamber

The flow chamber is on the back of the GX-6100 and is held in place by four Phillips screws. The flow chamber seals to the rubber sensor gasket which seals to the sensor faces inside the GX-6100 and routes flow from the pump to the sensors and to the exhaust port (on the top of the GX-6100 case).

Sensors

The GX-6100 uses several sensors to monitor LEL-level combustible gas, %volume combustible gas, oxygen (O₂), carbon monoxide (CO), hydrogen sulfide (H₂S), and isobutylene (IBL) simultaneously. The sensors are located inside the GX-6100 and are held in their sockets by the flow chamber. The sensors use different detection principles, as described below.

Combustible Gas Sensors

- **%LEL Sensor (NCR-6309)**

The combustible gas sensor (NCR-6309) detects combustible gas in the %LEL range using 2 catalytic elements: a standard element and a poison-resistant element that is resistant to sensor poisons like silicone. The element's resistance changes based on the reaction of gas with oxygen. The change in resistance affects the current flowing through the element. The GX-6100's circuitry amplifies the current, converts the current to a gas concentration, and displays the concentration on the LCD.

The standard calibration for the combustible gas sensor is to methane but the sensor will still detect and respond to a variety of combustible gases.

WARNING: *Do not give strong force or shock to NCR-6309. There is a danger that the flame-proof performance will be damaged due to breakage etc. This sensor uses flame-proof conditions of "low" possibility of mechanical damage.*

WARNING: *NCR-6309 must not be exposed to ultraviolet light. The sensor shall not be exposed to ultraviolet light or used in equipment in which it is not fully enclosed.*

- **%Volume Sensor (TE-7561)**

The %volume sensor detects combustible gas in the %volume range. It uses a thermal conductivity (TC) element for detection. The presence of combustible gas cools the element causing a change in the resistance of the element which affects the current flowing through it. The current is amplified by the GX-6100's circuitry, converted to a measurement of combustible gas concentration, and displayed on the LCD.

Oxygen, CO, and H₂S Sensors

The O₂, CO, and H₂S sensors are electrochemical cells that consist of two precious metal electrodes in a dilute acid electrolyte. A gas permeable membrane covers the sensor face and allows gas to diffuse into the electrolyte. The gas reacts in the sensor and produces a current proportional to the concentration of the target gas. The GX-6100's circuitry amplifies the current, converts the current to a gas concentration, and displays the concentration on the LCD.

There are 4 different types of CO and H₂S sensors available (only 1 can be installed per instrument):

- CO only (ESR-A13P-CO): A single electrochemical cell that detects CO

- H₂ compensated CO (ESR-A1CP-CO-H): A single electrochemical cell that detects CO. This sensor does not respond to or responds minimally to hydrogen (displays H₂ RICH once H₂ concentration reaches 2000 ppm).

NOTE: The H₂-compensated CO sensor may not effectively compensate for high levels of H₂ if exposed to temperatures above 40°C for longer than 15 minutes. Under these conditions, it can appear to the instrument that the H₂ concentration has exceeded 2000 ppm, the max concentration that can be compensated for, resulting in a CO reading higher than the actual CO level.

- H₂S only (ESR-A13i-H2S): A single electrochemical cell that detects H₂S
- CO/H₂S (ESR-A1DR-COHS): A combination electrochemical cell that detects both CO and H₂S

PID Sensor

Two types of PID sensors can be used with the GX-6100, a low range (higher sensitivity) sensor and a high range (lower sensitivity) sensor (see Table 1 for specifications).

The PID sensor is a cylindrical sensor with a diffusion opening on the front and 3 pins on the back. It is installed in a white housing that has three sockets on the bottom that mate with the GX-6100 instrument. The PID sensor must always be installed in the first smart sensor position which is located in the top left corner of the sensor block.

The standard calibration for a PID channel is to isobutylene. A PID channel can be factory setup for and calibrated to other gases. Regardless of the calibration gas, the PID channel will still detect and respond to a variety of volatile organic compounds (VOCs). Consult RKI Instruments, Inc. for other available PID configurations and to specify the desired PID configuration when a unit is ordered.

Dummy Sensors

Any unit that has less than 6 sensors will have a dummy sensor installed in one or more unused sensor positions. Dummy sensors are factory installed. The flat top of the dummy sensor should face up and the bottom hollow side should face down.

Filters

Combustible Gas Sensor H₂S Removal Filter Disk (Dark Red)

An H₂S removal filter disk is placed into a recess in the filter gasket over the catalytic combustible gas sensor. The filter disk prolongs the life of the combustible gas sensor by preventing H₂S in the ambient air from reaching the sensor. The H₂S filter disk is dark red in color and although it may darken over time, its color is not indicative of remaining filter life.

The H₂S filter disk needs replacing once it's been exposed to 33 ppm hours of H₂S. This means the filter needs replacing after 80 minutes of exposure to 25 ppm H₂S which equates to 40 2-minute calibrations with a cylinder containing 25 ppm H₂S. If H₂S exists in the monitoring environment, the H₂S filter disk will have to be replaced more frequently.

CO/H₂S Sensor Dual Filter (Black and White)

A dual filter is placed into a recess in the filter gasket over the dual CO/H₂S sensor. The black half is a charcoal filter for the CO sensor. The white half is a humidity filter for the H₂S sensor.

Replace the filter if you notice the following:

- Unexplained CO readings
- For users with a 1 ppm H₂S alarm setpoint: A drift on the H₂S zero reading, unexplained H₂S readings, the filter appears dirty, or every 6 months (whichever is sooner)

CO Sensor Charcoal Filter (Black)

A black charcoal filter is placed into a recess in the filter gasket over the CO sensor. The charcoal filter disk scrubs H₂S and certain hydrocarbons out of the sample to avoid false CO readings. If false or elevated CO readings are noticed, especially in the presence of H₂S, change the charcoal filter.

H₂S Humidity Filter (White)

A white humidity filter is placed into a recess in the filter gasket over the H₂S sensor (if installed). The filter absorbs humidity in the sampling environment to prevent unstable readings around 0 ppm. “H₂S” is printed on the side of the filter.

For users with a 1 ppm H₂S alarm setpoint, the filter should be replaced every 6 months, if you notice a drift on the zero reading, or if the filter appears dirty (whichever is sooner). For users with a 2 ppm or higher H₂S alarm setpoint, the filter does not necessarily ever need to be replaced.

Inlet Filter Holder

The filter holder is a clear plastic dome shaped piece on the top of the case. A male quick connect fitting is located on the inlet filter holder. This is the GX-6100's inlet fitting. The filter holder may be removed by turning it counterclockwise and pulling it away from the case. One flat membrane disk hydrophobic filter, a wire mesh disk, and a rubber filter retaining gasket are held in place by the filter holder and are located in the bottom of the case chamber where the filter holder is installed.

Batteries

Three AA-size alkaline batteries or a rechargeable lithium ion battery pack (4.1 VDC) power the GX-6100. Instrument run time is dependent upon battery type. At 25°C, the alkaline batteries last at least 8 hours and the lithium ion battery pack lasts at least 28 hours. The battery icon in the upper right of the LCD shows remaining battery life.

When the GX-6100 detects a low battery voltage, a low battery warning is activated. When battery voltage is too low for Measuring Mode, the GX-6100 sounds a dead battery alarm.

The alkaline batteries can be replaced by removing the battery cover on the back of the case. The lithium ion pack can be replaced by removing the entire battery pack. The battery pack release latch is located on the bottom of the instrument. When viewing the instrument from the bottom with the LCD facing down, push the battery pack release latch toward the right to release the pack.

The lithium ion battery pack can be recharged by placing the GX-6100 in its battery charging station or by placing the battery pack in the charging station.

NOTE: Use of batteries or battery chargers not specified by RKI Instruments, Inc. will compromise the CSA classification and may void the warranty. See page 121.

WARNING: *To prevent ignition of a hazardous atmosphere, batteries must only be changed or charged in an area known to be nonhazardous.*

AVERTISSEMENT: *Pour éviter l'inflammation d'une atmosphère dangereuse, les batteries doivent uniquement être modifiés ou facturés dans une zone connue comme non dangereuse.*

Included Accessories

Included accessories consist of the tapered rubber nozzle, belt clip, rubber boot, wrist strap, and the sample hose/probe.

Tapered Rubber Nozzle

A cone shaped 4 inch long rubber nozzle is included with the GX-6100 as standard. It can be installed on the inlet fitting by pushing the larger end over it. The smaller end can be inserted through a hole in a wall or some other access to an enclosed area to sample the environment.

Belt Clip

A belt clip can be mounted to the back of the case using 3 Phillips head screws. The belt clip allows the GX-6100 to be securely attached to a belt.

Rubber Boot

A protective rubber boot can be installed over the GX-6100.

Wrist Strap

A wrist strap is included with the GX-6100 and can be attached to the right or left wrist strap installation feature on the GX-6100 case.

Sample Hose and Probe

A 3-foot sample hose with an attached probe is standard with the GX-6100. When desired, the rubber nozzle may be removed and the sample hose and probe may be connected to the inlet fitting. Sample hose lengths are available from 3 feet to 100 feet (see page 151). The quick connect end of the sample hose connects to the inlet fitting of the GX-6100. The probe is integral with the hose and connects to it with a tube fitting.

CAUTION: *Sample hose lengths of more than 100 feet are not recommended for the GX-6100 because of flow rate reduction.*

The probe includes a replaceable particle filter and hydrophobic filter disk that prevent particulates and water from entering the GX-6100's flow system. See "Replacing the Probe's Particle Filter and Hydrophobic Filter Disk" on page 130 for instructions to replace the particle filter and hydrophobic filter disk.

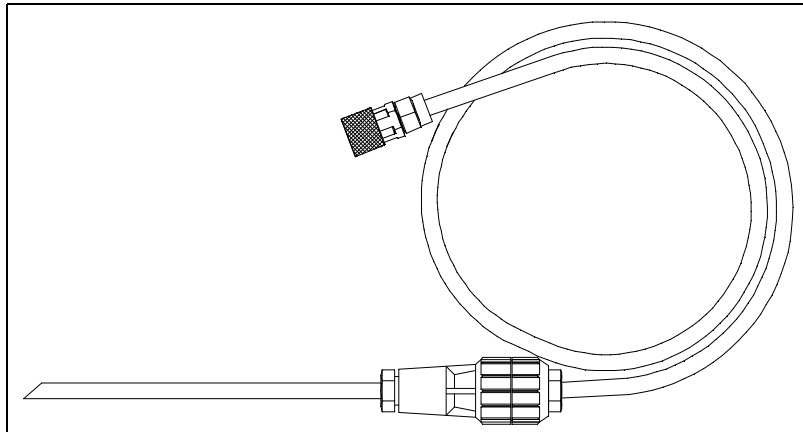

Figure 2: Sample Hose and Probe

Screen Protector

The clear screen protector can be installed over the GX-6100's LCD to prevent it from getting scratched.

1. Remove the GX-6100's rubber boot.
2. Orient the GX-6100 so that the LCD is as horizontal as possible.
3. Clean the LCD with rubbing alcohol.
4. Place 1 drop of water in the center of the LCD.
5. Grasp the tab at the top of the screen protector's backing and pull it away from the screen protector.
6. Use needle-nose pliers or tweezers to handle the screen protector.
7. Align the top of the screen protector with the top of the "RKI GX-6100" logo.
8. Press down on the center of the screen protector. Water should spread out along the entire surface of the screen protector between the screen protector and the LCD. Some of the water may come out the edges.
9. If you are unhappy with the initial placement of the screen protector, lift the screen protector up from a corner. Quickly rearrange the screen protector and set it back down on the LCD.
10. Use a small, stiff piece of plastic and, working your way out from center, remove any air bubbles. The screen protector may shift during this process so be sure to hold it securely with your other hand.

11. Allow enough time for the water between the screen protector and the LCD to dry before handling the GX-6100.
12. Reinstall the rubber boot.

Other Accessories

Several other accessories are available for the GX-6100. This section describes the VOC zero filter, the dilution fitting, and the DIN rail. Detailed instructions regarding the use of the dilution fitting are included in other parts of this manual. Data logging accessories are briefly described in “Data Logging” on page 53.

VOC Zero Filter

A VOC zero filter is included as standard with GX-6100s that include the following:

- Low range PID sensor (PID-001LA)
- 10.0 eV/benzene PID sensor (PID-003L)
- 11.7 eV PID sensor (PID-004)
- Any PID sensor and any CO₂ sensor
- NH₃ sensor and any CO₂ sensor

The VOC zero filter scrubs out low levels of VOC gases using charcoal. Use the VOC zero filter when:

- Performing an air adjust on a PID sensor in an area that may have a low-level VOC background.
- Performing an air adjust on a PID/CO₂ or NH₃/CO₂ instrument (in combination with a CO₂ scrubber).

The filter comes with a tubing stub and plug on each end. Both plugs must be removed before using the filter and must be reinstalled for storage. The filter does not have a preferred flow direction.

When used with a CO₂ scrubber, the VOC zero filter gets connected to the instrument and the CO₂ scrubber gets connected to the VOC zero filter. See “Performing a Demand Zero for Instruments with a CO₂ and PID or NH₃ Sensor” on page 212 for more instructions.

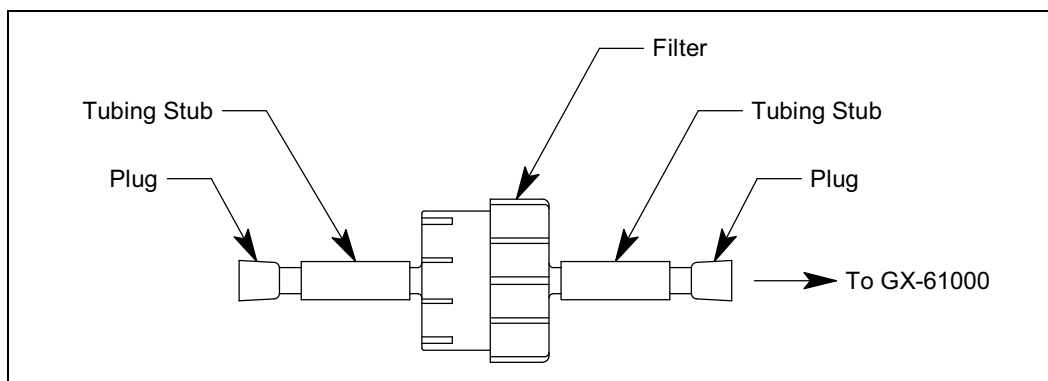

Figure 3: VOC Zero Filter

External Dilution Fitting

A 1:1 external dilution fitting is available for the GX-6100. It is designed to mate with the inlet fitting and accept the sample hose and probe. The fitting is made with brass and nickel plated brass and is appropriate for use with the four standard gases. The fitting is normally used when it is necessary to introduce air into a sample that has no oxygen or a very low level of oxygen, such as a nitrogen purged sample. It can also be used when one of the target gas levels in the sample area will likely be present in a concentration above the detection range for that gas. Since the fitting partially consists of unplated brass, it is not appropriate for detection of elevated levels of H₂S or of gases that are easily absorbed such as Cl₂ or SO₂.

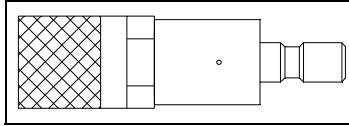

Figure 4: 1:1 Dilution Fitting

DIN Rail Mounting Assembly

Two different DIN rail mounting assemblies are available for the GX-6100's charger. Each assembly has two end clamps but one assembly is long enough to accommodate 1 charger and the other assembly is long enough to accommodate 4 chargers.

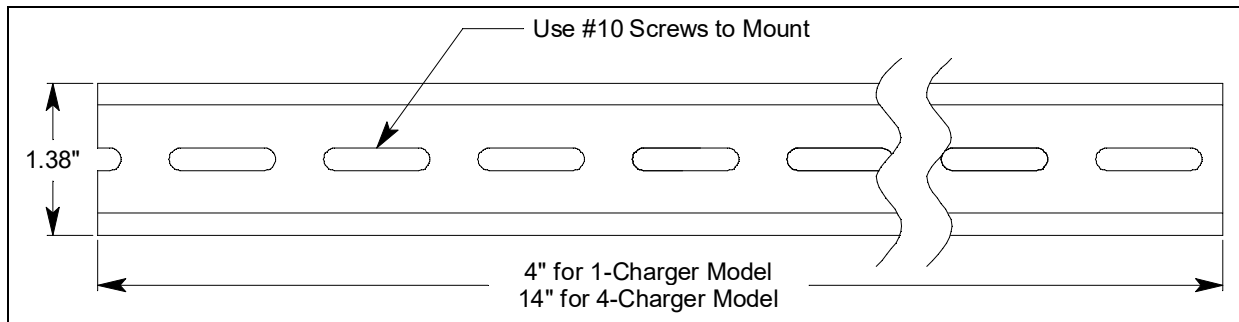

Figure 5: DIN Rail Dimensions

1. Use #10 screws to mount the DIN rail to the wall.

2. Install the charger(s) on the DIN rail. Seat the top of the DIN rail in the top slot on the back of the charger. Press the bottom of the charger toward the DIN rail until it locks into place.

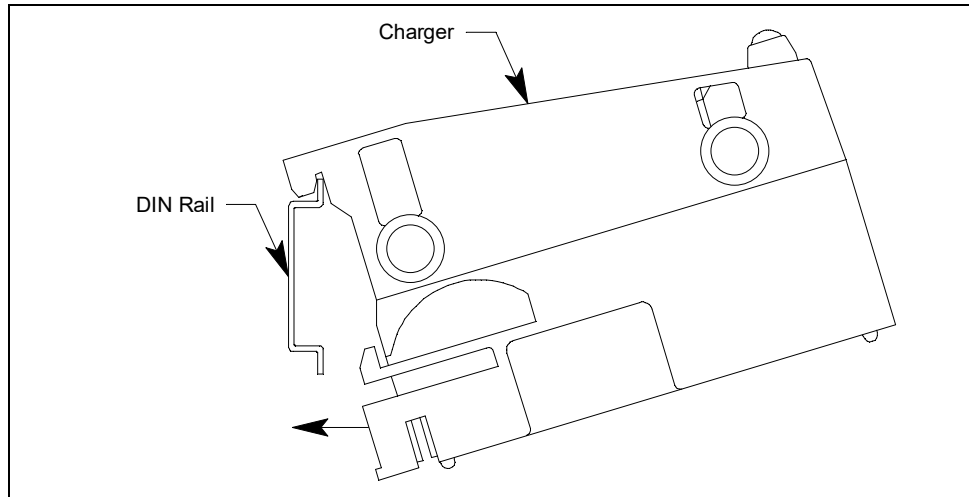

Figure 6: Installing a Charger on the DIN Rail

3. Slide the charger(s) along the DIN rail into the desired position.
4. Install the end clamps on the left and right side of the charger or bank of chargers to prevent sliding.

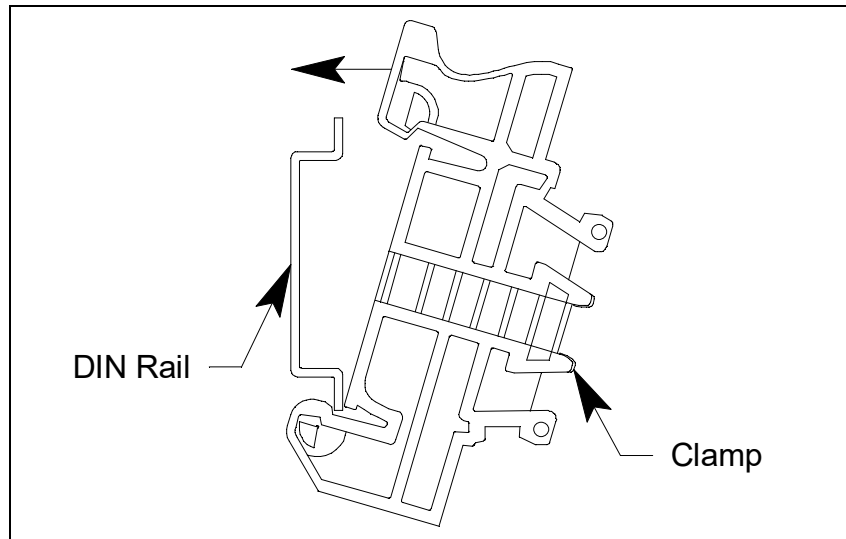

Figure 7: Clamp Installation

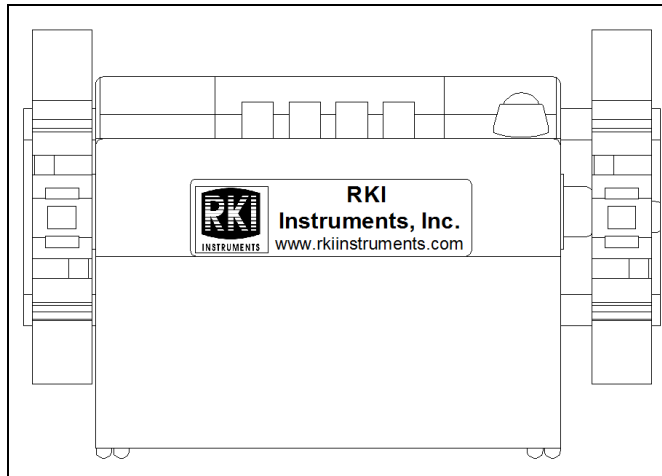

Figure 8: 1-Charger Installation

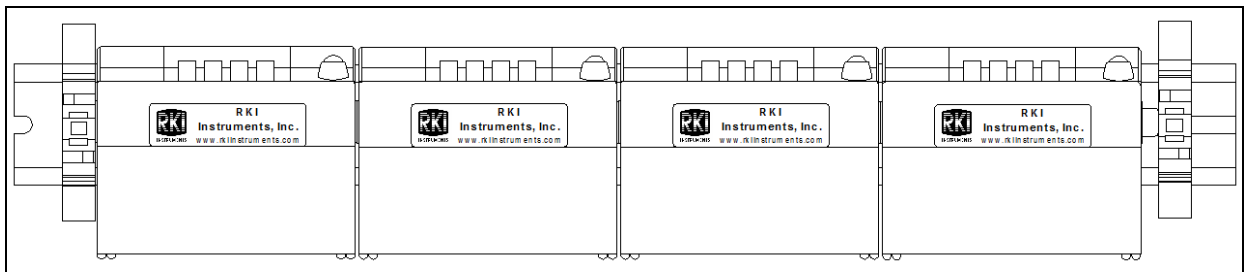

Figure 9: 4-Charger Installation

5. To remove any charger(s) from the DIN rail:
 - a. Remove the clamps by pushing on the bottom of the clamp and pulling on the top of the clamp.
 - b. Slide the charger(s) off the DIN rail.

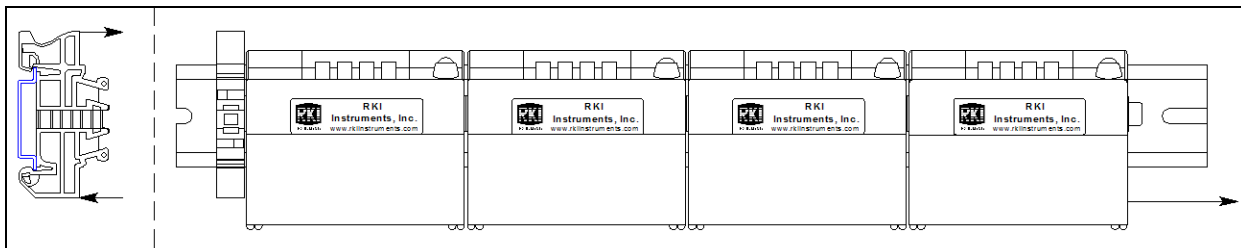

Figure 10: Charger Removal

Chapter 3: Normal Mode

Overview

This chapter explains how to use the GX-6100 to perform confined space entry monitoring or general area monitoring in Normal Mode.

The GX-6100 can also operate in Leak Check Mode and Bar Hole Mode. See page 164 for Leak Check Mode instructions. See page 177 for Bar Hole Mode instructions.

Start Up

This section explains how to start up the GX-6100, get it ready for operation, and turn it off.

NOTE: The screens illustrated in this section are for a standard 4-gas + high range PID unit. The screens displayed by your GX-6100 may be slightly different.

Turning On the GX-6100

To illustrate certain functions, the following description of the GX-6100 start up sequence assumes that the following menu items in the GX-6100 Configuration Program are turned on: **LUNCH BREAK, CAL REMINDER, BUMP REMINDER, USER ID, and STATION ID.** If any of these items are turned off, then the corresponding screens will not appear.

The GX-6100 may be used with a sample hose and probe or with the tapered rubber nozzle. Determine which configuration works best for your application.

NOTE: When the sample hose is not being used, its outgassing characteristics may result in a small buildup of gas to which the PID sensor will respond. If a sample hose has been sitting unused for a period of time, when that sample hose is connected to a GX-6100, the PID channel may temporarily show a reading. The reading will return to a fresh air reading after all of the built up gas has been drawn out of the sample hose.

1. Connect the tapered rubber nozzle or the sample hose and probe to the GX-6100's quick connect inlet fitting.
2. Press and briefly hold down the POWER/ENTER button. Release the button when you hear a beep.

3. If **CAL REMINDER** is set to **ON** (factory setting) and a calibration is due, the screen that appears next depends on how **CAL EXPRD** is set in the GX-6100 Configuration Program. The three possible screens are described below. If a calibration is not due, the instrument shows how many days are left until a calibration is due.

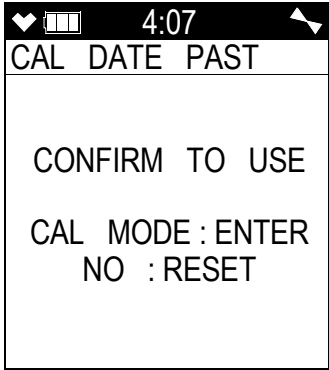
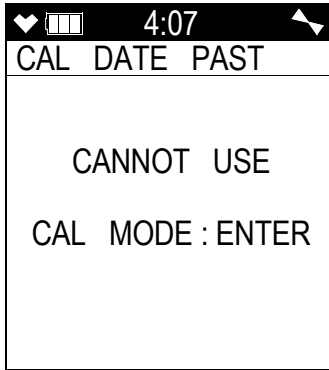
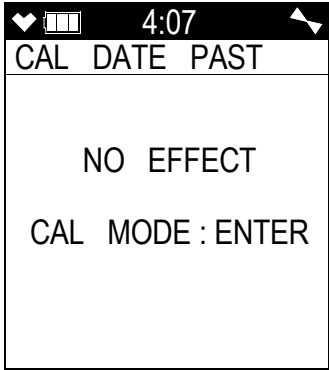
	CAL EXPRD set to CONFIRM TO USE (factory setting)	CAL EXPRD set to CANNOT USE	CAL EXPRD set to NO EFFECT
LCD			
Sound	Buzzer sounds double pulsing tone	Buzzer sounds double pulsing tone	None
Action	<ul style="list-style-type: none"> • <u>Option A, Perform calibration</u>: Press and release POWER/ENTER to perform a calibration. The GX-6100 takes you straight to the SPAN CAL menu in User Mode's GAS CAL menu. See page 77 for calibration instructions. <p>If the calibration is successful, the screen above will not appear again until the unit is due for calibration. If the calibration is not successful, the screen above will again appear in the startup sequence.</p> <ul style="list-style-type: none"> • <u>Option B, Bypass message</u>: To continue without performing a calibration, press and release RESET. 	<p>The GX-6100 cannot be used until a successful calibration is performed. Press and release POWER/ENTER to perform a calibration. The instrument takes you straight to the SPAN CAL menu in User Mode's GAS CAL menu. Even if the User password function has been turned on, no password is required to perform a calibration.</p> <p>If you don't press POWER/ENTER, the instrument automatically goes to the SPAN CAL menu after 6 seconds. See page 77 for calibration instructions.</p> <p>If the calibration is successful, the screen above will not appear again until the unit is due for calibration. If the calibration is not successful, the screen above will again appear in the startup sequence.</p>	<ul style="list-style-type: none"> • <u>Option A, Perform calibration</u>: To perform a calibration, press and release POWER/ENTER. The instrument takes you straight to the SPAN CAL menu in User Mode's GAS CAL menu. • <u>Option B, Bypass message</u>: To continue without performing a calibration, wait a few seconds for the instrument to continue with its startup sequence.

4. If **BUMP REMINDER** is set to **ON** (factory setting is **OFF**) and a bump test is due, the screen that appears next depends on how **BUMP EXPRD** is set in the GX-6100 Configuration Program. The three possible screens are described below. If a bump test is not due, the instrument shows how many days are left until a bump test is due.

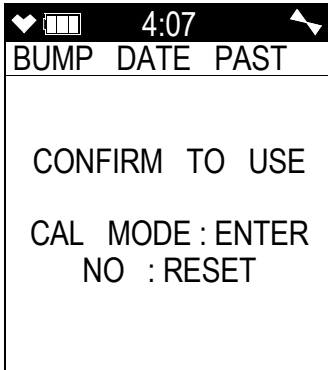
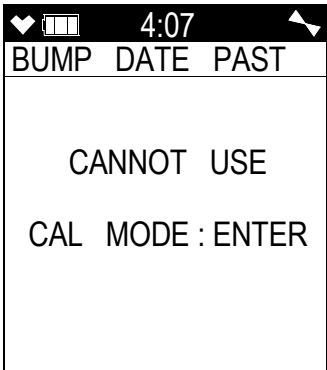
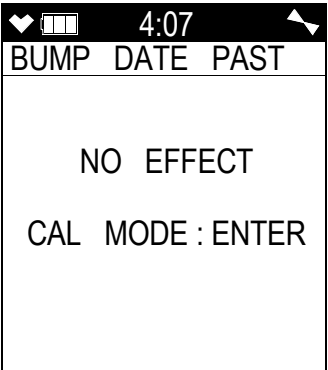
	BUMP EXPRD set to CONFIRM TO USE (factory setting)	BUMP EXPRD set to CANNOT USE	BUMP EXPRD set to NO EFFECT
LCD			
Sound	Buzzer sounds double pulsing tone	Buzzer sounds double pulsing tone	None
Action	<ul style="list-style-type: none"> • <u>Option A, Perform bump test</u>: Press and release POWER/ENTER to perform a bump test. The instrument takes you straight to the 4-gas Gas Select screen in User Mode's BUMP TEST menu. See page 80 for bump test instructions. <p>If the bump test is successful, the screen above will not appear again until the unit is due for bump testing. If the bump test is not successful, the screen above will again appear in the startup sequence.</p> <ul style="list-style-type: none"> • <u>Option B, Bypass message</u>: To continue without performing a bump test, press and release RESET. 	<p>The GX-6100 cannot be used until a successful bump test has been performed. Press and release POWER/ENTER to perform a bump test. The instrument takes you straight to the 4-gas Gas Select screen in User Mode's BUMP TEST menu. If you don't press POWER/ENTER, the instrument automatically goes to the SPAN CAL screen after 6 seconds. See page 80 for bump test instructions.</p> <p>If the bump test is successful, the screen above will not appear again until the unit is due for bump testing. If the bump test is not successful, the screen above will again appear in the startup sequence.</p>	<ul style="list-style-type: none"> • <u>Option A, Perform bump test</u>: To perform a bump test, press and release POWER/ENTER. The instrument takes you straight to the 4-gas Gas Select screen in User Mode's BUMP menu. • <u>Option B, Bypass message</u>: To continue without performing a bump test, wait a few seconds for the instrument to continue with its startup sequence.

5. The Date/Time screen appears for a few seconds.

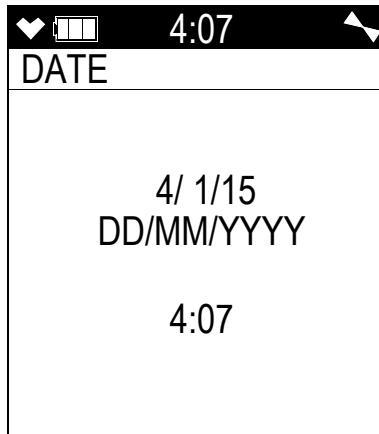

6. The Battery Voltage screen appears for a few seconds. The alarm latching setting is displayed at the bottom of the LCD.

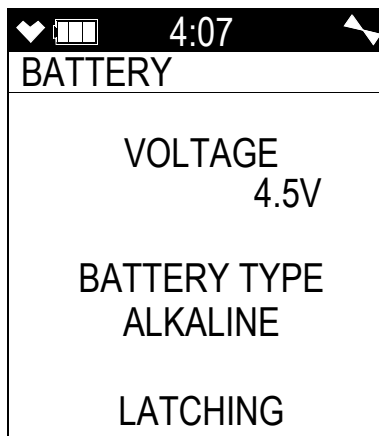

7. If **LUNCH BREAK** is turned on (see the *GX-6100 Configuration Program Operator's Manual* to program the **LUNCH BREAK** setting), the Lunch Break screen appears. The unit counts down from 5 seconds at the top of the screen.

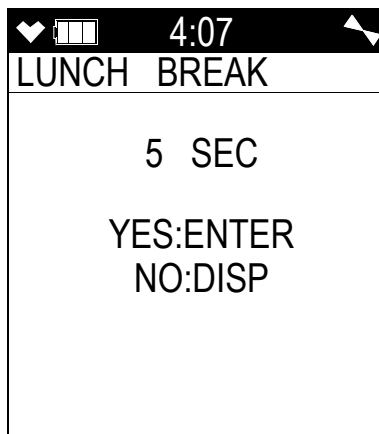

- To continue accumulating peak and time-weighted average (TWA) readings from the last time the GX-6100 was used, press and release the POWER/ENTER button before the countdown reaches 0 or allow the countdown to reach 0. If you do not press the POWER/ENTER button within the 5 second countdown, the GX-6100 automatically resumes accumulating the peak and TWA readings. The GX-6100 will also continue to keep track of operating time including the operating time from the last time the GX-6100 was used. The short-term exposure limit (STEL) reading is reset each time the GX-6100 is turned on.
 - To reset the accumulation of these measurements, press and release the DISP/LOCK button before the countdown reaches 0.
8. The Active Gases screen appears for a few seconds indicating which channels are active, their target gas, and unit of measurement.

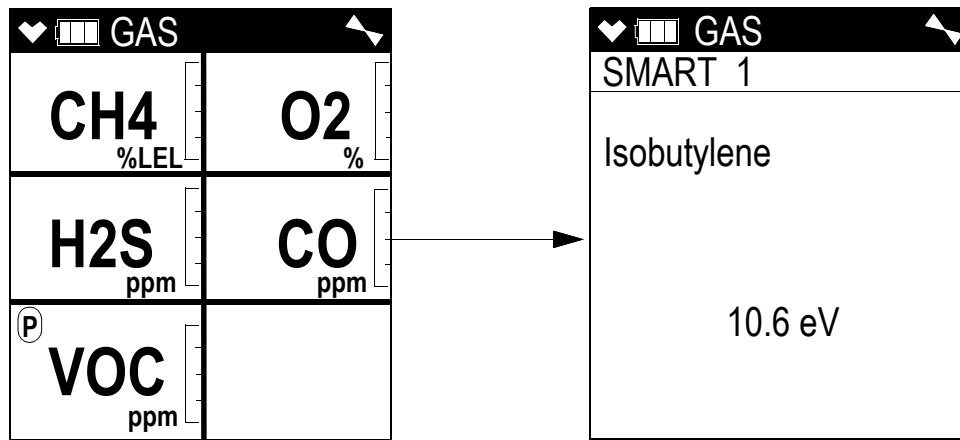

9. The full scale values and the gas alarm setpoints are displayed by five screens in sequence: the Full Scale screen, the Alarm 1 screen, Alarm 2 screen, Alarm 3 screen, STEL Alarm screen, and TWA Alarm screen. Each screen remains on the LCD for three seconds.

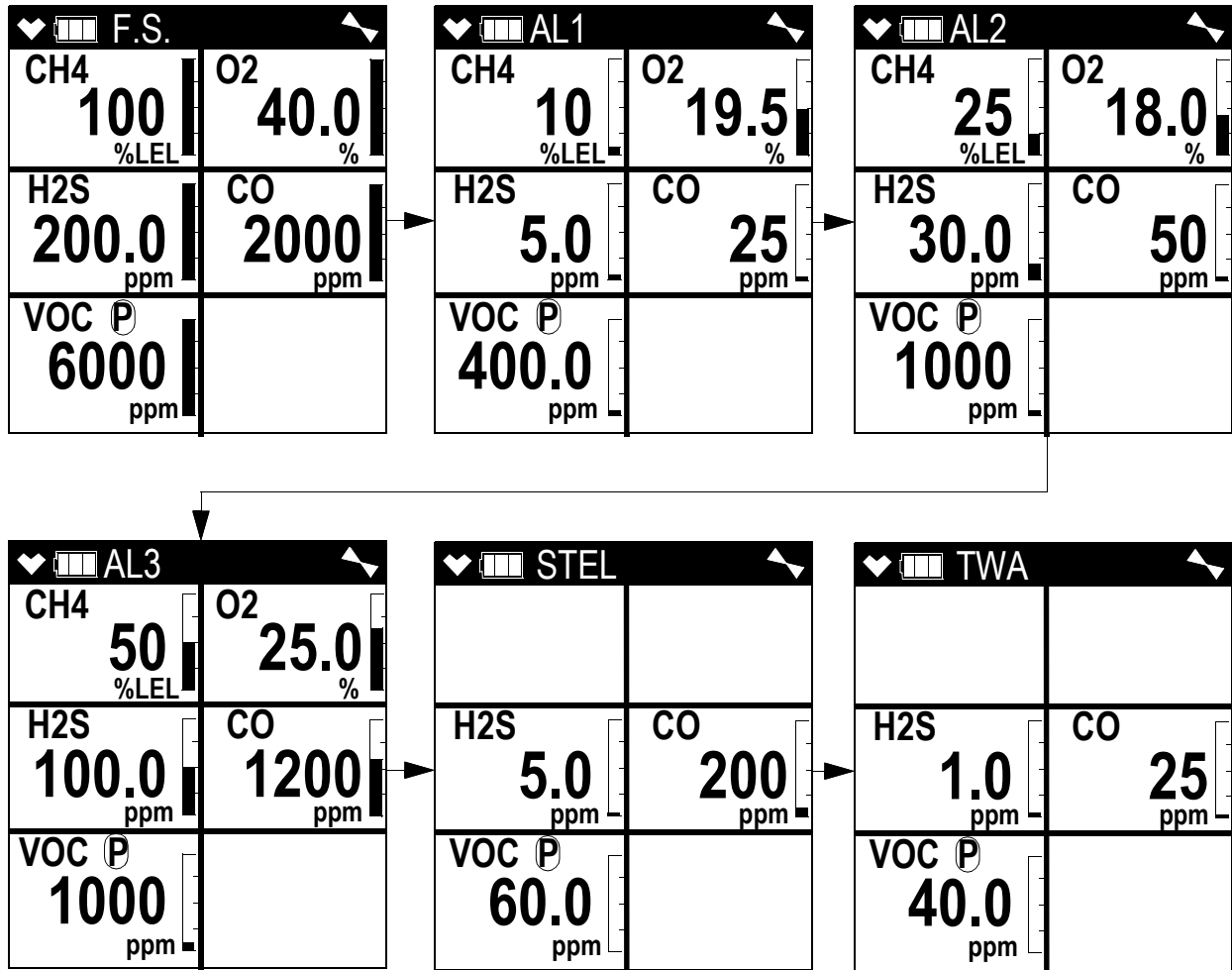

10. The User ID screen appears for a few seconds, followed by the Station ID screen.

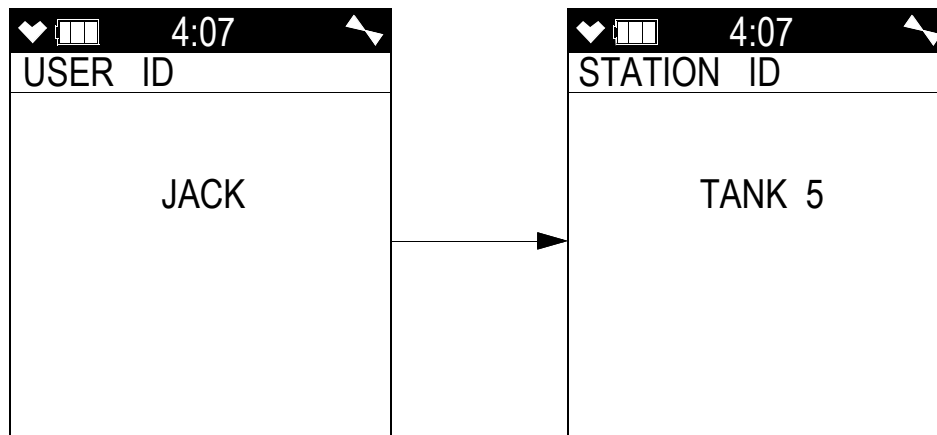

11. If the GX-6100 experiences a sensor failure during start up, a screen indicating which sensor failed appears and the buzzer sounds a double pulsing tone once per second. In the example below, the CH₄ sensor has failed.

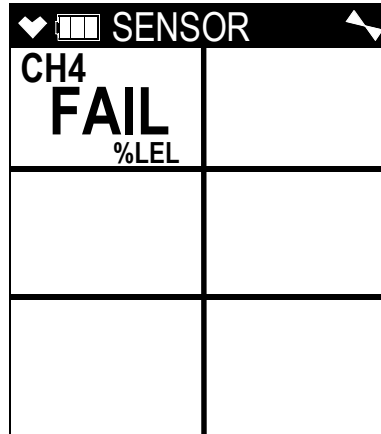

If you wish to continue, press and release the RESET button to acknowledge the failure. The gas reading for the failed sensor will be replaced by “- - -”. Replace the failed sensor as soon as possible.

12. The combustible gas sensor contains 2 separate sensors: a standard catalytic sensor and a backup, poison-resistant sensor that is resistant to sensor poisons like silicone. An HC Gas List alarm indicates that the standard sensor has a reduced output, possibly due to one or more sensor poisons in the environment, and that the poison-resistant sensor is being used to provide gas readings. The poison-resistant sensor has a limited list of detectable gases. See Table 11 on page 59 for which gases can and cannot be detected during an HC Gas List condition.

Depending on the version, one of the following screens appears, the LEDs flash, and the instrument beeps.

Press and release POWER MODE to confirm the HC Gas List screen and continue to the Gas Name Screen. If POWER MODE is not pressed after 5 seconds, the GX-6100 will automatically proceed to the next screen.

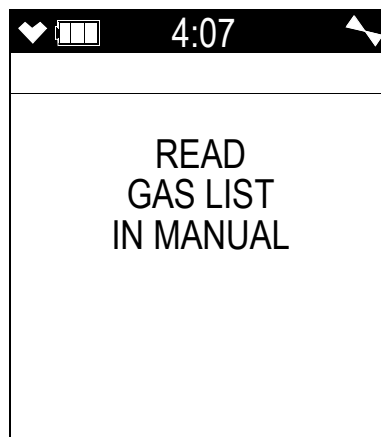

NOTE: If your application requires detection of a gas still detectable after an HC Gas List condition (like methane or isobutane), there is no need to replace the combustible gas sensor.

However, if your application requires detection of a gas not detectable after an HC Gas List condition (like methanol or ethanol), you must replace the combustible gas sensor as soon as possible.

13. The GX-6100 is now monitoring for gas in Measuring Mode. The Measuring Mode screen appears displaying the current gas reading for each target gas.

If you have 2 PID sensors installed, they might both be displayed as “VOC”. The channel that appears first is based on the following sensor priority.

High Priority ↓ Low Priority	10.6 eV low range PID
	10.0 eV/benzene PID
	11.7 eV PID
	10.6 eV high range PID
	ESS-03 Cl ₂
	MOS sensors
	ESS-03 NH ₃
	IR and other ESS-03 sensors

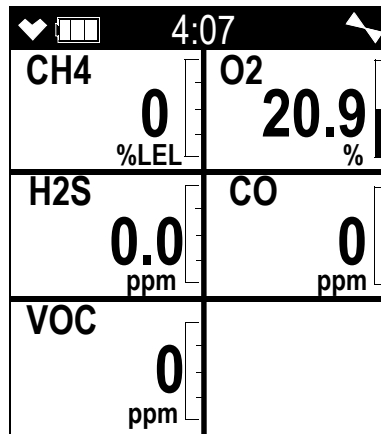

Performing a Demand Zero

Before using the GX-6100, it is recommended to set the fresh air readings for the target gases by performing a demand zero. This will set the CH₄, H₂S, CO, and PID channels to zero and the O₂ channel to 20.9%.

1. Find a fresh-air environment. This is an environment free of toxic or combustible gases and of normal oxygen content (20.9%).
2. Turn on the unit as described above in Turning On the GX-6100.
3. If you suspect any low-level VOC background in the area, you will need to use the VOC zero filter.

NOTE: If you have both a PID or NH₃ sensor and a CO₂ sensor installed, you will need to follow the directions on page 212 instead of following the directions shown below.

- a. Remove the plug from each end of the VOC zero filter.
- b. Attach the VOC zero filter to the inlet fitting or probe. The filter does not have a preferred flow direction.
- c. Let the instrument draw through the VOC zero filter for 1 minute before continuing.
4. Press and hold the ▲ AIR button. The LCD prompts you to continue holding the ▲ AIR button and the buzzer will pulse while you hold the button.
5. Continue to hold the ▲ AIR button until the LCD prompts you to release it. The GX-6100 will set the fresh air reading for all channels. Start up is complete and the unit is now ready for monitoring.
6. If the VOC zero filter was used, remove the filter from the GX-6100's inlet fitting or probe. Reinstall the plugs on each end of the filter.

Turning Off the GX-6100

1. Press and hold the POWER/ENTER button.
2. TURN OFF will appear on the display and the buzzer will pulse for about five seconds.
3. Release the button when TURN OFF disappears from the display.

Measuring Mode, Normal Operation

When the GX-6100 completes its startup sequence, it is in Measuring Mode. In Measuring Mode the GX-6100 continuously monitors the sampled atmosphere and displays the gas concentrations present for its target gases.

If a sensor is in a sensor life warning condition, the gas name flashes. A sensor life warning indicates that the sensor is nearing the end of its useful life.

In a low-light environment, press and release any button to turn on the display backlight. See the *GX-6100 Configuration Program Operator's Manual* to adjust backlight duration.

If **Beep Select** is set to anything other than **OFF** in the GX-6100 Configuration Program, the GX-6100 gives periodic indications to confirm that it's operating.

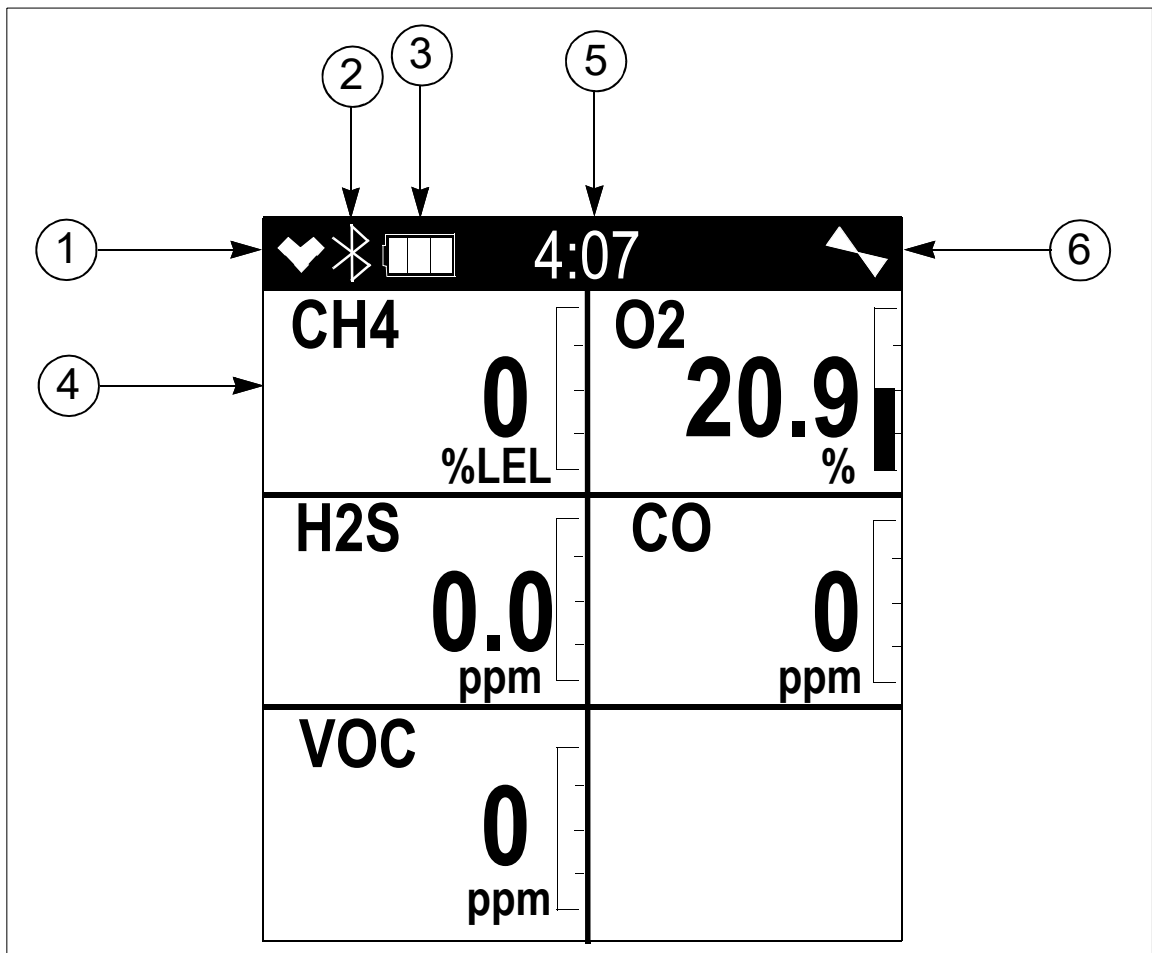





Figure 11: Measuring Mode Display

1. Heart Symbol: The heart symbol in the upper left corner of the LCD indicates the operation status and blinks when normal. A microprocessor error causes the heart symbol to stop flashing or to disappear.
2. Bluetooth Icon: The Bluetooth logo indicates that Bluetooth is enabled. When disabled, this space will be blank.

3. **Battery Icon:** Displays one of three levels of battery charge
 -  : Fully charged
 -  : Low charge
 -  : Depleted, needs charging
4. **Channel Reading:** The current reading for each active channel is displayed in different quadrants of the screen. A peak bar will also display if enabled (see page 73).
5. **Clock:** The current time is displayed at the top of the LCD in 24-hour format.
6. **Fan/Pump Icon:** The X-shaped icon next to the battery indicates that the pump is active and will rotate in place when functioning properly.

Monitoring an Area

1. Start up the GX-6100 as described above in “Start Up” on page 28. It is now in Measuring Mode.

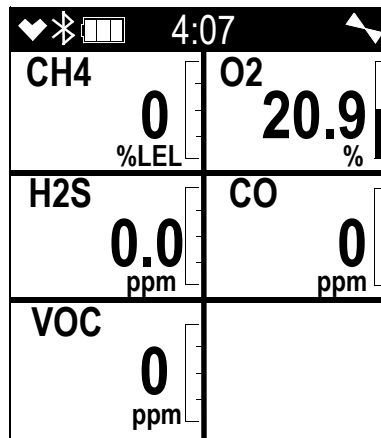

2. Take the GX-6100 to the monitoring area.
Put the probe tip in the area to be monitored.

NOTE: If the particle filter or hydrophobic filter become dirty or clogged, replace them. If water enters the probe, dry out or replace the particle filter (if installed) and shake any water out of the probe and off of the hydrophobic filter. If you notice that water has entered the flow system through the probe, replace the probe’s hydrophobic filter. See page 130 for instructions to replace the particle filter and the hydrophobic filter.

3. Wait 10 - 15 seconds and observe the display for gas readings. If a reading is observed, allow the reading to stabilize to determine the gas concentrations present.

NOTE: Response time increases with the length of the sample hose. Long sample hoses will require more time to show a response at the GX-6100. The maximum sample hose length recommended for the GX-6100 is 100 feet. Consult RKI Instruments, Inc. for longer sample hose lengths.

4. If a gas alarm occurs, take appropriate action. See page 48.

Using Optional Sample Hoses

The standard sample hose for the GX-6100 is 3 feet long. Optional sample hoses and probes with longer hoses are available from 5 - 100 feet in 5-foot increments (see page 151). If you are considering using a hose and probe with a longer hose, keep in mind that a longer hose will increase the GX-6100's response time and the flowrate may decrease close to the low flow alarm point.

CAUTION: *Sample hose lengths of more than 100 feet are not recommended for the GX-6100 because of flow rate reduction and increased response time. Consult RKI Instruments, Inc. for hose lengths longer than 100 feet.*

The chart below illustrates how response time is affected by the sample hose length.

Table 4: GX-6100 Response Time vs. Sample Hose Length

Hose Used	Typical Time to 90% of Response (T90)
Probe & 3 Foot Hose (standard)	10 seconds
Probe & 10 Foot Hose	15 seconds
Probe & 30 Foot Hose	30 seconds
Probe & 50 Foot Hose	40 seconds
Probe & 60 Foot Hose	45 seconds
Probe & 70 Foot Hose	50 seconds

Combustible Gas Detection

The GX-6100 can support two combustible gas sensors for normal operation: a TC (thermal conductivity) sensor for detection in the %volume range and a catalytic sensor for detection in the %LEL range. Either sensor or both may be installed in your unit.

If both the %volume and %LEL sensors are installed, the combustible gas channel is setup at the factory as %LEL/%volume autoranging. In this case, the combustible gas channel will display the combustible gas concentration in %LEL up to 100% LEL. If the combustible gas concentration rises above 100% LEL, then the unit automatically begins displaying the concentration in %volume.

CAUTION: *If both the %LEL and %vol sensors are installed in your instrument, make sure you follow the recommendations in the next section, “Applications with High Levels of Combustible Gas” on page 40, to protect the %LEL sensor. Failure to do so will result in damage to the %LEL sensor.*

WARNING: *If the combustible channel is set for %volume only, then there are no gas alarms for any detection channel. See “Changing the HC Range Setting (HC RANGE SELECT)” on page 61.*

There are three important issues to keep in mind when monitoring for combustible gas.

Applications with High Levels of Combustible Gas

The GX-6100 provides the %LEL sensor with some protection by turning off the %LEL sensor power temporarily when it determines that a %LEL over scale (more than 100% LEL) concentration of combustible gas is present. When this happens, “OVER” is displayed below the gas name and the display units to the right of the combustible gas channel change to %volume. However, this protection is not adequate to completely prevent damage to the sensor when it is exposed to moderate or high levels of %volume gas.

Combustible gas is present at moderate or high %volume levels in many applications such as purging applications. If your GX-6100 is equipped with both the %LEL and %volume sensors, you must set up the instrument so that the combustible channel operates in the %volume only range when you use the instrument for this type of application to protect the %LEL sensor from damage. You can set the combustible channel to operate in the %volume range only in the HC Range Screen of Display Mode. See “Changing the HC Range Setting (HC RANGE SELECT)” on page 61 for instructions to set the combustible channel to operate in the %volume range only.

CAUTION: *Failure to set the combustible channel to %volume only operation when using the GX-6100 for applications with moderate to high %volume levels of combustible gas will result in damage to the %LEL sensor.*

The instrument may be set up for combustible channel autoranging operation when it is used for confined space applications where %volume combustible gas concentrations are not likely to be found.

Silicone & Other Potentially Damaging Compounds

Silicone vapors and chlorine and fluorine compounds, such as chlorinated hydrocarbons, can damage the %LEL sensor. These compounds should be avoided. If exposure to these compounds is suspected, verify the %LEL response on a known gas sample.

%LEL Sensor Relative Responses

Although the standard factory setup and calibration for the combustible gas channel is to methane (CH₄), the combustible sensors will respond to other combustible gases as well.

Table 5 lists the conversion factors for several hydrocarbon gases **if the GX-6100 is calibrated to methane**. Conversion factors are not available for the %volume TC sensor. To use this table, multiply the display reading on the combustible gas channel by the factor in the appropriate row to obtain the actual gas concentration. For example, if you are detecting ethylene and the display reads 10% LEL for the combustible gas channel, you actually have 10% LEL x 0.83 = 8.3% LEL ethylene present.

Table 5: LEL Hydrocarbon Conversions

Gas	LEL Conversion Factor (from CH ₄ Cal.)
Acetone	2.22
Acetylene	1.43
Benzene	2.50
Butadiene	1.52
Cyclopentane	1.45
DME	1.16
Ethane	0.94
Ethanol	1.96
Ethyl Acetate	2.86
Ethylene	0.83
Heptane	3.13
Hexane	1.89
Hydrogen	0.95

Gas	LEL Conversion Factor (from CH ₄ Cal.)
IPA	1.64
Isobutane	1.10
MEK	2.63
Methane	1.00
Methanol	1.82
MIBK	4.00
MMA	3.33
Nonane	9.09
Propane	1.12
Propylene	0.97
THF	2.33
Toluene	4.55
Xylene	7.69

The GX-6100 provides the catalytic combustible sensor with some protection against exposure to high levels of combustible gas which can damage the sensor. It does this by turning off the combustible sensor power temporarily when it determines that an over scale (more than 100% LEL) concentration of combustible gas is present that may damage the sensor. Nevertheless, concentrations of combustible gas of more than 100% LEL can still affect the zero level or calibration of the combustible sensor if the concentration is high enough.

CAUTION: Do not expose the catalytic combustible sensor to high concentrations of combustible gas such as that from a butane lighter. Exposure to high concentrations of combustible gas may adversely affect the performance of the sensor.

CAUTION: Any rapid increase in the combustible gas reading on the catalytic combustible channel followed by a declining or erratic reading may indicate a gas concentration above the LEL which may be hazardous.

Some gases such as silicone vapors, chlorinated hydrocarbons, and sulfur compounds can contaminate the detection elements inside the combustible sensor damaging the sensor and result in reduced response to combustible gas. Make every effort to avoid these gases.

VOC Detection

When monitoring for VOCs using the PID sensor, keep the following in mind:

- Regardless of what gas the PID sensor is calibrated to (factory calibration is to isobutylene), the PID sensor will still detect and respond to a variety of volatile organic compounds (VOCs).
- The PID channel will indicate an upscale reading if one of a variety of combustible gases is present. If %LEL concentrations of one of these combustible gases is present, the PID channel may indicate an overscale reading.
- If concentrations of methane greater than 10% LEL are present in the monitoring environment, the PID channel's reading will be suppressed.
- The PID sensor will also respond to H₂S and NH₃, so if H₂S or NH₃ is present, the PID channel may indicate an upscale reading depending on the concentration present.
- If your instrument has both a low range PID sensor and a high range PID sensor installed and if you are monitoring for gases in the higher range, the low range PID channel may be in over range alarm while monitoring, depending on the level of VOCs present.
- If you have 2 PID sensors installed, they might both be displayed as "VOC". The channel that appears first is based on the following sensor priority.

High Priority ↓ Low Priority	10.6 eV low range PID
	10.0 eV/benzene PID
	11.7 eV PID
	10.6 eV high range PID
	ESS-03 Cl ₂
	MOS sensors
	ESS-03 NH ₃
	IR and other ESS-03 sensors

Oxygen-Enriched Atmospheres

The GX-6100 is not intended for use in oxygen-enriched atmospheres.

WARNING: Do not use the GX-6100 in an environment whose oxygen concentration is above 21%.

H₂-Compensated CO Detection

- GX-6100 displays CO readings.
- H₂ reading is not displayed but “H2 RICH” appears once H₂ concentration rises above 2000 ppm.

NOTE: The H₂-compensated CO sensor may not effectively compensate for high levels of H₂ if exposed to temperatures above 40°C for longer than 15 minutes. Under these conditions, it can appear to the instrument that the H₂ concentration has exceeded 2000 ppm, the max concentration that can be compensated for, resulting in a CO reading higher than the actual CO level.

Interference Information

Some gases interfere with CO, H₂S, and super toxic sensors. For a complete list of these gases, refer to the following pages:

- H₂S-Only Sensor: ESR-A13i-H2S, H₂S Detection on page 184
- CO-Only Sensor: ESR-A13P-CO, CO Detection on page 186
- CO (H₂-compensated) Sensor: ESR-A1CP-COH, H₂-Compensated CO Detection on page 188
- CO Detection (Dual CO/H₂S Sensor): ESR-A1DP-COHS, CO Detection on page 190
- H₂S Detection (Dual CO/H₂S Sensor): ESR-A1DP-COHS, H₂S Detection on page 191

Zero Suppression

The GX-6100's gas sensors have built-in zero suppression which ignores, or suppresses, noisier readings below the target gas suppression concentration. Refer to the following table for each suppression concentration of every target gas. These values are not user-adjustable.

Target Gas	Zero Suppression
Combustible Gas	2% LEL
Oxygen (O ₂)	0.5 VOL%
Hydrogen Sulfide (H ₂ S)	0.3 ppm
Carbon Monoxide (CO)	2 ppm
Carbon Dioxide (CO ₂)	0 ppm
Hydrogen Cyanide (HCN)	0.5 ppm

Target Gas	Zero Suppression
Ammonia (NH ₃)	4 ppm
Nitrogen Dioxide (NO ₂)	0.30 ppm
Phosphine (PH ₃)	0.02 ppm
Sulfur Dioxide (SO ₂)	0.20 ppm

NOTE: MOS, PID, and CO₂ channels have no zero suppression.

Snap Log Mode

The snap logging function in Snap Log Mode allows the user to record data at a specific time and have it saved to the data logger. The data is assigned a snap log ID and is saved with the station ID that was in use when the data was taken.

To enter Snap Log Mode and record snap log data:

1. While the unit is in Measuring Mode, press and hold the SHIFT ▼ (PANIC) button, then press and hold the ▲ AIR button and hold both until you hear a beep. The unit will cycle through the following screens.

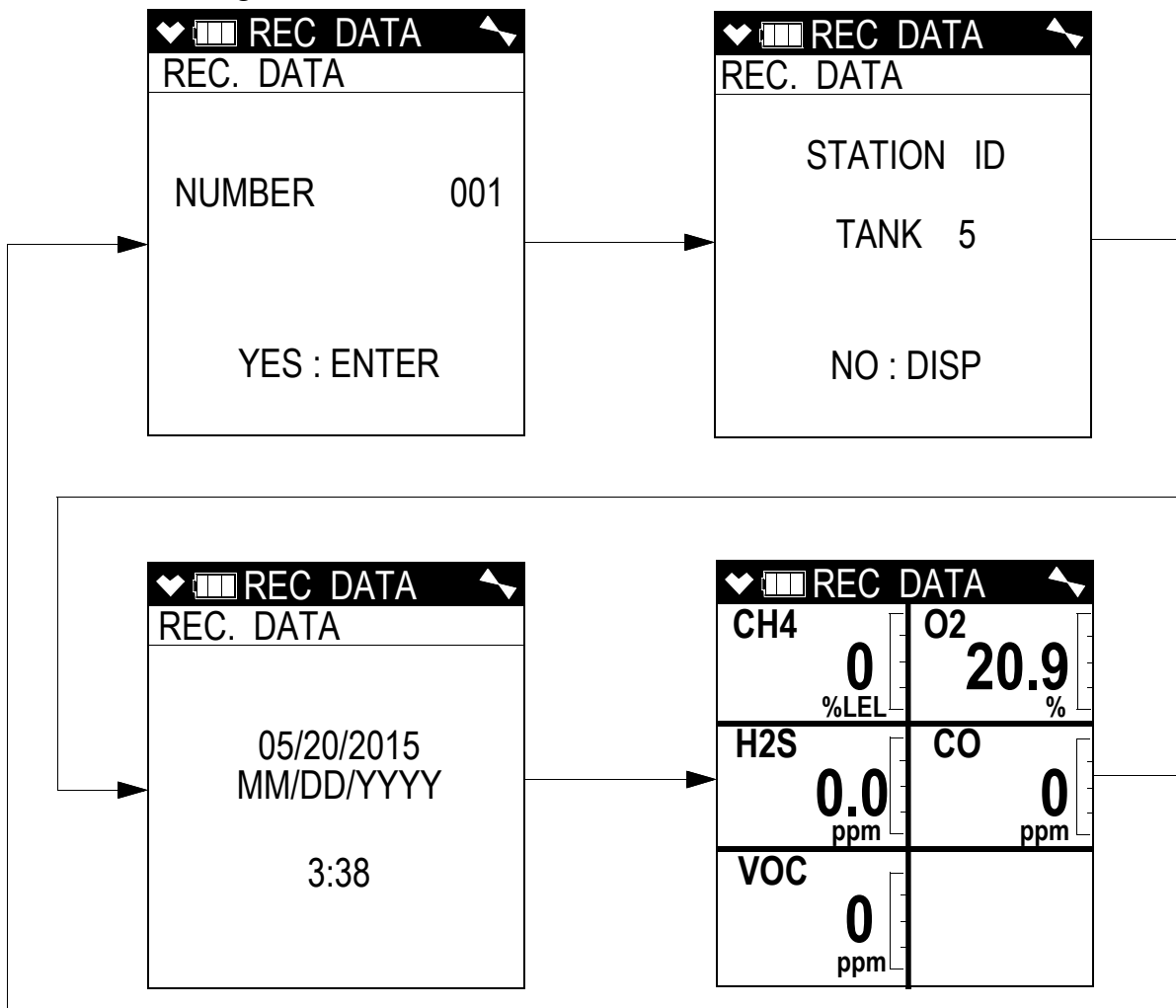

The first screen displays what snap log ID will be given to this particular set of data and that you should press the POWER ENTER button to save a set of snap log data. The snap log ID number increases sequentially with each set of snap log data taken. The second screen displays what Station ID will be associated with this snap log and that you should press the DISP/LOCK button to exit Snap Log Mode without saving a set of snap log data. The third screen displays the year, month, day, and time of the snap log. The fourth screen displays the current gas readings.

NOTE: If the GX-6100 detects an alarm condition while in Snap Log Mode, it will automatically exit Snap Log Mode and return to Measuring Mode. You may then reenter Snap Log Mode and take snap logs while the instrument is still in alarm.

2. You can change the Station ID to be used with the snap log by pressing the SHIFT ▼ (PANIC) button and then pressing the DISP/LOCK button. The Station ID Select screen will appear and the current Station ID will be flashing.

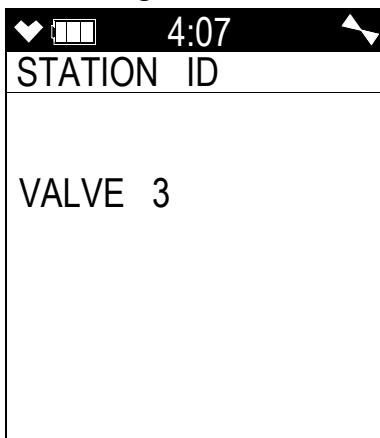

3. Use the ▲ AIR and SHIFT ▼ (PANIC) buttons to scroll to the desired Station ID, then press and release the POWER/ENTER button to return to the Snap Logging screen sequence.
To return to the Snap Logging screen sequence without changing the Station ID, press and release the DISP/LOCK button.
4. To take a snap log of the current gas readings, press and release the POWER/ENTER button. The unit will display SAVED along the bottom of the screen before returning to the Snap Logging screen sequence.

To exit Snap Log Mode without taking a snap log or when you are finished recording snap logs, press and release the DISP/LOCK button. The unit will immediately return to the Measuring Mode screen.

The data recorded in Snap Log Mode can be viewed in Display Mode. See page 73 for more information.

Measuring Mode, Alarms

This section covers alarm indications in Measuring Mode. It also describes how to reset the GX-6100 after an alarm has occurred and how to respond to an alarm condition.

NOTE: False alarms may be caused by radio frequency (RF) or electromagnetic (EMI) interference. Keep the GX-6100 away from RF and EMI sources such as radio transmitters or large motors.

Alarm Indications

The GX-6100 buzzer will sound an alarm, the LEDs will flash, and the vibrator will pulse when any sort of alarm condition or failure is encountered.

NOTE: If an alarm condition occurs while you are in Display Mode, the GX-6100 will automatically bring up the alarm screen instead.

The table below summarizes the types of alarms produced by the GX-6100 and their indications. None of the Man Down alarm indications will happen if **MAN DOWN** is set to **OFF** in Maintenance Mode (factory setting).

Table 6: Alarm Types and Indications

Alarm Type	Visual Indications	Other Indications
<u>Alarm 1</u> Concentration of gas rises above the Alarm 1 setting or falls below the Alarm 1 setting for O ₂	<ul style="list-style-type: none"> Affected channel display alternates between gas reading and AL1 Alarm LED arrays flash in circle sequence once per second Backlight turns on 	<ul style="list-style-type: none"> High-low tone sounding twice per second Vibrator pulses once per second
<u>Alarm 2</u> Concentration of gas rises above the Alarm 2 setting or falls below the Alarm 2 setting for O ₂	<ul style="list-style-type: none"> Affected channel display alternates between gas reading and AL2 Alarm LED arrays flash in circle sequence twice per second Backlight turns on 	<ul style="list-style-type: none"> High-low tone sounding four times per second Vibrator pulses twice per second
<u>Alarm 3</u> Concentration of gas rises above the Alarm 3 setting	<ul style="list-style-type: none"> Affected channel display alternates between gas reading and AL3 Alarm LED arrays flash in circle sequence twice per second Backlight turns on 	<ul style="list-style-type: none"> High-low tone sounding four times per second Vibrator pulses twice per second
<u>TWA or STEL</u> Concentration of CO, H ₂ S, or high range VOC rises above the TWA or STEL alarm setting.	<ul style="list-style-type: none"> Affected channel display alternates between gas reading and TWA or STEL Alarm LED arrays flash in circle sequence once per second Backlight turns on 	<ul style="list-style-type: none"> High-low tone sounding twice per second Vibrator pulses once per second

Table 6: Alarm Types and Indications

Alarm Type	Visual Indications	Other Indications
<u>Over Range</u>	<ul style="list-style-type: none"> Affected channel display alternates between OVER displayed where the gas reading normally is and OVER displayed where the reading units normally are Alarm LED arrays flash in circle sequence twice per second Backlight turns on 	<ul style="list-style-type: none"> High-low tone sounding four times per second Vibrator pulses twice per second
<u>Low Flow</u>	<ul style="list-style-type: none"> The display indicates FAIL LOW FLOW Alarm LED arrays flash once per second Backlight turns on 	Double pulsing tone once per second
<u>Low Battery Warning</u>	<ul style="list-style-type: none"> The last bar in the battery icon disappears and the battery icon starts flashing 	None
<u>Dead Battery Alarm</u>	<ul style="list-style-type: none"> Gas readings disappear and FAIL BATTERY appears at the top of the screen Alarm LED arrays flash once per second 	Double pulsing tone once per second
<u>Sensor Failure</u>	<ul style="list-style-type: none"> SENSOR appears at the top of the screen and the failed sensor(s) are indicated with FAIL under the gas name. Alarm LED arrays flash once per second 	Double pulsing tone once per second
<u>Clock Failure</u>	<ul style="list-style-type: none"> FAIL CLOCK appears at the top of the screen Alarm LED arrays flash once per second 	Double pulsing tone once per second
<u>System Failure</u>	<ul style="list-style-type: none"> FAIL SYSTEM appears at the top of the screen and an error code displays below it Alarm LED arrays flash once per second 	Double pulsing tone once per second
<u>Man Down Warning 1:</u> The WARNING 1 TIME defined in Maintenance Mode has passed since the instrument detected movement.	<ul style="list-style-type: none"> Alarm LED arrays flash once per second 	Single pulsing tone once per second

Table 6: Alarm Types and Indications

Alarm Type	Visual Indications	Other Indications
<u>Man Down Warning 2:</u> The WARNING 2 TIME defined in Maintenance Mode has passed since the instrument detected movement.	<ul style="list-style-type: none"> Alarm LED arrays flash twice per second 	Single pulsing tone twice per second
<u>Man Down Alarm:</u> The ALARM TIME defined in Maintenance Mode has passed since the instrument detected movement.	<ul style="list-style-type: none"> MAN DOWN flashes at top of screen in place of time Alarm LED arrays flash in circle sequence twice per second 	<ul style="list-style-type: none"> High-low tone sounding twice per second Vibrator pulses twice per second
<u>Panic</u> User presses and holds the SHIFT ▼ (PANIC) button.	<ul style="list-style-type: none"> Screen unaffected for 5 seconds before alarm starts MAN DOWN flashes at top of screen in place of time Alarm LED arrays flash in circle sequence twice per second Backlight turns on 	<ul style="list-style-type: none"> Single pulsing tone twice per second for 5 seconds before alarm starts High-low tone sounding twice per second Vibrator pulses twice per second

Responding to Alarms

This section describes response to gas, over range, battery, sensor failure, clock failure, system failure, man down, and panic alarms.

Responding to Gas Alarms

1. Determine which gas alarm has been activated.
2. Follow your established procedure for an increasing gas condition or a decreasing oxygen condition.

- Reset or silence the alarm as necessary or allowed. Table 7 summarizes resetting and silencing alarms for all **ALARM LATCHING** and **ALARM SILENCE** combinations that are possible. See page 108 for further descriptions of these parameters.

Table 7: Resetting and Silencing Alarms

	ALARM LATCHING: LATCHING	ALARM LATCHING: SELF RESET
ALARM SILENCE: ON	<p>(factory setting)</p> <ul style="list-style-type: none"> Press and release the RESET button to silence the buzzer. If the gas concentration was still above the alarm level when the button was pressed, the LED arrays continue to flash, the vibrator continues to pulse, and the GX-6100 continues to display the current alarm level. The gas reading must fall below (or rise above for an oxygen low alarm) an alarm setting before you can reset the alarm, the LEDs, and the vibrator using the RESET button. 	<ul style="list-style-type: none"> Press and release the RESET button to silence the buzzer. The RESET button will not reset the alarm. Alarm, LEDs, and vibrator will automatically reset when gas reading falls below (or rises above for an oxygen low alarm) an alarm setpoint.
ALARM SILENCE: OFF	<ul style="list-style-type: none"> RESET button will not silence buzzer. The gas reading must fall below (or rise above for an oxygen low alarm) an alarm setting before you can reset the alarm condition using the RESET button. 	<ul style="list-style-type: none"> RESET button will not silence or reset alarm. Alarm condition will automatically reset when gas reading falls below (or rises above for an oxygen low alarm) an alarm setpoint.

Responding to Over Range Alarms

WARNING: *An over range condition may indicate an extreme combustible gas, toxic gas, or oxygen concentration. Confirm a normal condition with a different GX-6100 or with another gas detecting device.*

CAUTION: *High off-scale readings may indicate an explosive concentration.*

PRUDENCE: *Des lectures élevées hors échelle peuvent indiquer une concentration explosive.*

- Determine which channel is in alarm.
- Follow your established procedure for an extreme gas condition.

NOTE: If your instrument has both a low range PID sensor and a high range PID sensor installed and if you are monitoring for gases in the higher range, the low range PID channel may be in over range alarm while monitoring, depending on the level of VOCs present.

3. Reset the alarm using the RESET button once the alarm condition has cleared.
4. Calibrate the GX-6100 as described on page 77.
5. If the over range condition continues or if you are not able to successfully calibrate the unit, you may need to replace the sensor that has triggered the over range alarm.
6. If the over range condition continues after you have replaced the sensor, contact RKI Instruments, Inc. for further instructions.

Responding to Battery Alarms

WARNING: *The GX-6100 is not operational as a gas monitoring device during a dead battery alarm. Take the Model GX-6100 to a non-hazardous area and replace or recharge the batteries as described on page 121.*

The GX-6100 is fully functional during a low battery warning. However, only a limited amount of operating time remains, approximately 1 - 2 hours. The amount of time depends on how often the LCD backlight is used and how often the unit is responding to alarm conditions. Recharge the Li-ion battery pack or replace the alkaline batteries as soon as possible as described in “Replacing or Recharging the Batteries” on page 121.

NOTE: Alarms and the LCD back light consume battery power and reduce the amount of operating time remaining.

Responding to Sensor Failure Alarms

1. Determine which sensor has triggered the sensor failure alarm.
2. Try calibrating the failed sensor, as described on page 77 before replacing it.
3. If the sensor failure continues, replace the sensor as described on page 134.
4. If the sensor failure condition continues after you have replaced the sensor, contact RKI Instruments, Inc. for further instructions.

Responding to Clock Failure Alarms (051)

A clock failure alarm occurs if the unit's internal clock malfunctions.

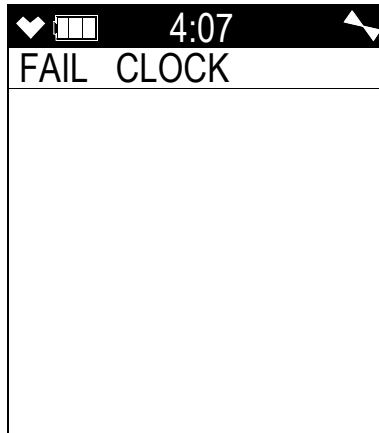

1. Press and release the RESET button to continue into Measuring Mode.

CAUTION: *There will be no datalogging function if you operate the instrument after a clock failure.*

2. Attempt to change the date using the **DATE** menu item in Maintenance Mode. See page 158.
3. If the date cannot be set correctly, contact RKI Instruments, Inc. as soon as possible.

Responding to System Failure Alarms

1. If a system failure occurs, the system failure screen will display an error code as shown below:

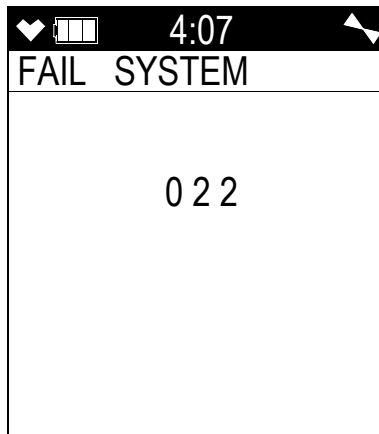

2. The error code meanings are shown in the table below:

Table 8: Error Code Explanation

Error Code	Explanation
000	ROM failure
010	RAM failure
021	FRAM failure
022	Abnormal settings for alarm setpoints or cal values
031	FLASH memory failure
080	Main PCB or pressure sensor voltage failure
081	Sensor PCB communication or voltage failure
082	Internal thermistor abnormality/ambient temperature is significantly outside of operating temperature range
083	Bluetooth failure
084	Acceleration sensor failure

3. If the error code is anything but 031 as shown above, the instrument cannot be used. Contact RKI Instruments, Inc. as soon as possible.

If the error code is 031, you may press and release the RESET button to continue into Measuring Mode if the instrument must be used temporarily.

CAUTION: *There will be no datalogging function if you operate the instrument after a 031 system failure. Contact RKI Instruments, Inc. as soon as possible.*

Responding to a Man Down Warning 1 and Warning 2

The Man Down Warning 1 and Warning 2 alarms occur after the **WARNING 1 TIME** and **WARNING 2 TIME**, respectively, have passed since the last movement of the instrument. See page 113 for instructions to change these values.

1. Follow your established procedure for a man down warning.
2. To silence the alarm and reset the Man Down clock, move the instrument or press and release the RESET button.

Responding to a Man Down Alarm

The Man Down Alarm alarms occur after the **ALARM TIME** has passed since the last movement of the instrument. See page 113 for instructions to change this value.

1. Follow your established procedure for a man down alarm.
2. To silence the alarm and reset the Man Down clock, press and release the RESET button. Moving the instrument will not reset the alarm or Man Down clock.

Responding to a Panic Alarm

If the user is in a dangerous situation or feels that others must be alerted to any sort of problem, holding the SHIFT ▼ (PANIC) button will initiate a panic alarm.

1. Press and release the RESET button to silence and reset the alarm.

Data Logging

NOTE: The GX-6100 only logs data while in Normal Mode. If the GX-6100 is used in Leak Check Mode or Bar Hole Mode, no downloadable data will be logged while it is in either of these two modes.

The GX-6100 features the ability to log data to its internal memory and download it to a computer via the infrared communications port on the front of the unit. It logs gas readings in Measuring Mode, alarm data, and calibration data.

NOTE: The data logging function is separate from the snap logging function. For a description of the snap logging function, see “Snap Log Mode” on page 44.

To utilize the GX-6100’s downloading capability, you will need the GX-6100 Data Logger Management Program and a computer with an infrared port or a USB port that runs one of the following operating systems: Windows 8, Windows 10, or Windows 11. If your computer has an infrared port, then no additional accessories are needed to download data from the GX-6100. If your computer does not have an infrared port but does have a USB port, a USB/IrDA adapter cable can be used to download data from the GX-6100 using the USB port. The GX-6100 Data Logger Program is available at www.rkiinstruments.com/product/gx-6100-multigas-detector/, under “GX-6100 Software”. The USB/IrDA adapter cable is available from RKI Instruments, Inc.

The data logging capacity depends on how often the GX-6100 stores data, how many channels are active, and how often the GX-6100 is turned on and off. The table below illustrates how much data logging time is available for the various interval times. It assumes that the unit is a standard four sensors plus PID unit, is only turned on once, and there are no alarm occurrences. See the GX-6100 Config program and the *GX-6100 Configuration Program Operator’s Manual* for instructions on setting the data logging interval time.

Table 9: Data Logging Capacity

Interval Time	Data Logging Time
10 seconds	10 hours
20 seconds	20 hours
30 seconds	30 hours
1 minute	60 hours
3 minutes	180 hours
5 minutes	300 hours

Table 9: Data Logging Capacity

Interval Time	Data Logging Time
10 minutes	600 hours

For a complete description of the Data Logger Management Program and procedures for downloading data to a computer, see the GX-6100 Data Logger Management Program Operator's Manual.

Chapter 4: Display Mode

This section describes using the GX-6100 in Display Mode. See Table 10 below for a list of Display Mode's menu items, a short description of each item, and the page number for further description.

Table 10: Display Mode Items

Menu Item (page number)	Function
Select PID Gas Name (page 56)	Define the PID channel's gas name
HC GAS LIST (page 58)	Displays which gas that the catalytic combustible gas channel's reading is being converted to (instrument must be calibrated to methane or isobutane)
HC RANGE SELECT (page 61)	Changes the detection range of the HC channel
PEAK (page 62)	Displays and clears the peak readings
STEL (page 63)	Displays STEL readings (<i>H₂S</i> , <i>CO</i> , and high range PID only)
TWA (page 63)	Displays TWA readings (<i>H₂S</i> , <i>CO</i> , and high range PID only)
USER ID (page 63)	Displays and changes the User ID
STATION ID (page 65)	Displays and changes the Station ID
REC. DATA DISP (page 66)	Displays all saved log data
PUMP OFF (page 67)	Turns the internal pump off to conserve battery between monitoring sessions
DATE AND BATTERY (page 68)	Displays the date/time, battery voltage, and battery type
ALARM POINTS (page 69)	Displays the alarm setpoints
INVERSION SELECT (page 71)	Inverts the orientation of the LCD
LCD BACKGROUND (page 72)	Reverses the black/white of the LCD
PEAK BAR (page 73)	Turns the peak bar function on or off
GAS DISP (page 74)	Changes how the gas readings are displayed
BLUETOOTH (page 75)	Turns the Bluetooth functionality on or off
BUZZER VOLUME (page 76)	Changes the buzzer volume (Low or High)

Tips for Using Display Mode

- To enter Display Mode, scroll from one menu item to the next, or skip an item when a question is asked, press DISP/LOCK.
- To enter an item, press POWER/ENTER.
- To change a flashing parameter, use either the ▲ AIR button or SHIFT ▼ (PANIC) button.
- To return to Measuring Mode from the top level of any menu item, press and release the RESET button.

NOTE: With the exception of the **Pump Off** screen, each screen displays for 20 seconds. If you do not press a button within 20 seconds, the GX-6100 automatically returns to Measuring Mode. If the **Pump Off** screen is used to turn the instrument's pump off, the Pump Off screen will display until you turn the pump back on.

Select PID Gas Name Screen

The standard PID channel is configured for and calibrated to isobutylene. If calibration to a different gas is required for an application, the PID channel can also be configured for other gases. Regardless of what gas the PID sensor is configured for and calibrated to, the sensor will still detect and respond to a variety of volatile organic compounds (VOCs).

If you configure the instrument for another gas, the instrument will retain that configuration until you change it again. Turning the instrument off and on does not change this setting.

If there are 2 PID sensors installed in your GX-6100, the PID Gas Name Screens will appear in Display Mode in the following order regardless of their position in the flow system: 10.0 eV/benzene, 10.6 eV, 11.7 eV.

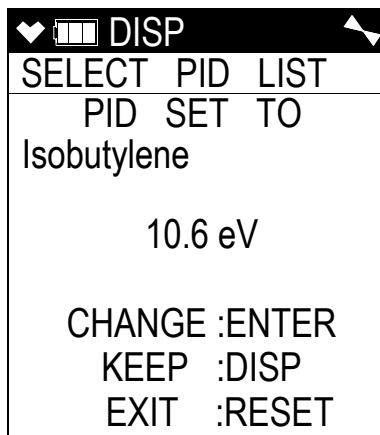

1. With the PID Gas Name Screen displayed, press and release the POWER/ENTER button. The top level of the PID Gas Name List will be displayed and the cursor will be next to the letter corresponding to the first letter of the current setting. In the example below, the PID channel is configured for isobutylene so the cursor is next to "I". Each letter has a list of gas names behind it.

At the top of the letter list, there is a User List item and a Recent List item. The User List can hold 30 gas names. See the *GX-6100 Configuration Program Operator's Manual* for instructions to edit the User List. The Recent List can hold up to 8 gas names and is made up of the 8 most recently used gas names. The Recent List is not user editable.

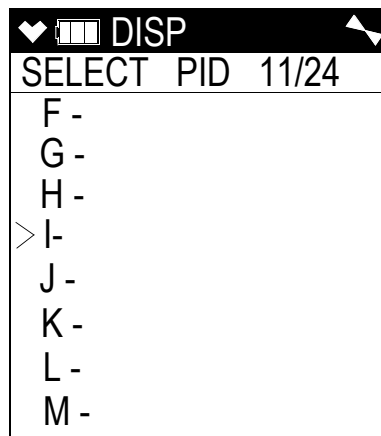

2. Press ▲ AIR or SHIFT ▼ (PANIC) to scroll through the letter and list options. To view the gas names behind a letter, User List, or Recent List, press and release the POWER/ENTER button when the cursor is next to the desired letter.

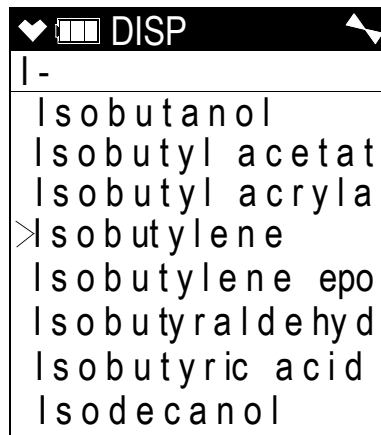

3. Press ▲ AIR or SHIFT ▼ (PANIC) to scroll through the gas names.

- To view the information for each gas name, press and release the POWER/ENTER button when the cursor is next to the desired gas name. The number in the upper left corner is the gas's number in relation to all other gas names that are stored in the GX-6100. The chemical formula is displayed next to the gas number. The response factor relative to isobutylene is listed on the second line. The gas name is listed on the third line.

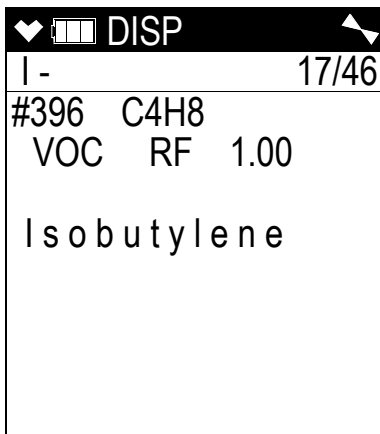

- To select a gas name, press and release the POWER/ENTER button while you are viewing the parameters. The selection will be in effect until you change it again.
To return to the gas name list without saving any changes, press and release the DISP/LOCK button.
- To return to the top level PID Gas Name List that has all of the letter choices, press and release the DISP/LOCK button.
- To return to the PID Gas Name Screen, press and release the DISP/LOCK button one more time.

LEL Sensor Target Gas Conversion (HC GAS LIST)

NOTE: Leak Check Mode is only supported for methane (**CH4**) and isobutane (**i-C4H10**). If any other gas option is selected in **HC GAS LIST** menu of Display Mode, the GX-6100 will only display the combustible gas readings in terms of methane or isobutane, whichever the instrument was calibrated to.

The **HC GAS LIST** screen allows you to select a converted target gas based on a CH4 or i-C4H10 calibration. It does not change the calibrated target gas. You must go to Factory Mode's **GAS.COMB** item to change the calibrated target gas.

Selecting a converted target gas from the **HC GAS LIST** menu (based on a CH4 or i-C4H10 calibration) does not provide the same reading accuracy as selecting a calibrated target gas in Factory Mode's **GAS.COMB** item and calibrating with that target gas in User Mode.

Selecting a converted target gas in **HC GAS LIST** does not mean that the combustible gas sensor will respond only to that gas. The combustible gas sensor responds to a number of gases regardless of the target gas selection.

NOTE: If H₂ is selected as the target gas, either in Factory Mode or in Display Mode, the sensor will only respond to the gases available during an HC Gas List Condition (see Table 11). It will not respond to heavy hydrocarbons.

If you select a new converted target gas, the change is saved after you turn the instrument off and on.

Table 11: Available HC Gas Conversions

Gas	Available Converted Gases Based on Calibrated Target Gas (Selected in Factory Mode)		Available Converted Target Gases During HC Gas List Condition
	CH ₄ (methane)	i-C ₄ H ₁₀ (isobutane)	
CH ₄ (methane)	-	X	O
i-C ₄ H ₁₀ (isobutane)	O	-	O
H ₂ (hydrogen)	O	O	O
CH ₃ OH (methanol)	O	O	X
C ₂ H ₂ (acetylene)	O	O	O
C ₂ H ₄ (ethylene)	O	O	O
C ₂ H ₆ (ethane)	O	X	O
C ₂ H ₅ OH (ethanol)	O	O	X
C ₃ H ₆ (propylene)	O	O	O
C ₃ H ₆ O (acetone)	O	O	X
C ₃ H ₈ (propane)	O	X	O
C ₄ H ₆ (butadiene)	O	O	O
C ₅ H ₁₀ (cyclopentane)	O	O	O
C ₆ H ₆ (benzene)	O	O	X
n-C ₆ H ₁₄ (hexane)	O	O	O
C ₇ H ₈ (toluene)	O	O	X
n-C ₇ H ₁₆ (heptane)	O	O	O
C ₈ H ₁₀ (xylene)	O	O	X

Table 11: Available HC Gas Conversions

Gas	Available Converted Gases Based on Calibrated Target Gas (Selected in Factory Mode)		Available Converted Target Gases During HC Gas List Condition
	CH4 (methane)	i-C4H10 (isobutane)	
n-C9H20 (nonane)	O	O	X
EtAc (ethyl acetate)	O	O	X
IPA (isopropyl alcohol)	O	O	X
MEK (methyl ethyl ketone)	O	O	X
MMA (methyl methacrylate)	O	O	X
DME (dimethyl ether)	O	O	X
MIBK (methyl isobutyl ketone)	O	O	X
THF (tetrahydrofuran)	O	O	X
n-C5H12 (n-pentane)	O	O	O
X = not available O = available			

1. While in Measuring Mode, press the DISP button until **HC GAS LIST** appears.

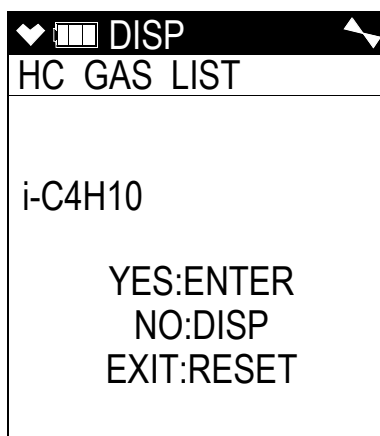

2. Press POWER/ENTER. The current HC target gas begins flashing on screen.
3. Press ▲ AIR or SHIFT ▼ (PANIC) to display the desired setting.
4. Press POWER/ENTER to save the setting and return to the main menu. The change is saved and the instrument returns to Display Mode.
5. The gas formula displays at the bottom of the Measuring Mode screen. The gas selection remains selected if you turn the instrument off and on again.

Changing the HC Range Setting (HC RANGE SELECT)

The **HC RANGE SELECT** setting applies to installed catalytic and TC sensors. It controls the unit of measurement for the combustible gas channel(s). This setting will only be displayed if both a catalytic and TC sensor are installed.

NOTE: If anything other than **AUTO RANGE** is selected, the setting will revert to **AUTO RANGE** when the instrument is turned off and turned back on.

- **AUTO RANGE** (factory setting): The HC channel's gas reading will be displayed in %LEL until the gas level reaches 100% LEL, or 5.0% VOL for methane. If a TC sensor is installed, gas readings above 100% LEL are displayed in %VOL. Alarm points exist for the %LEL range but do not exist for the %VOL range.
 - **LEL ONLY:** The HC channel's gas reading will only be displayed in %LEL up to 100% LEL. This is the only available HC range setting if a TC sensor is not installed.
 - **VOL ONLY:** The HC channel's gas reading will only be displayed in %VOL. This is the only available HC range setting if a catalytic sensor is not installed.
1. While in Measuring Mode, press DISP/LOCK until the **HC AUTO SELECT** screen appears.
 2. Press POWER/ENTER. The current setting begins flashing on screen.
 3. Press ▲ AIR or SHIFT ▼ (PANIC) to display the desired setting.
 4. Press POWER/ENTER to save the setting and return to the main menu.

Viewing and Clearing the Peak Readings (PEAK)

The peak screen displays the highest (lowest for oxygen) concentrations detected since the GX-6100 was turned on. Peak readings are stored in the GX-6100's memory until a higher level is detected (lower for oxygen), the peak reading is cleared, or the GX-6100 is turned off.

NOTE: The lunch break feature enables the GX-6100 to save peak readings when it is turned off so it can continue them when it is turned on again. See "Turning On the GX-6100" on page 28.

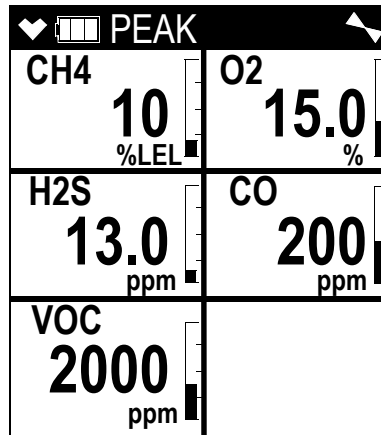

To clear the peak readings:

1. While in Measuring Mode, press DISP/LOCK until the **PEAK** screen appears.
2. Press and hold RESET until the screen prompts you to release it.

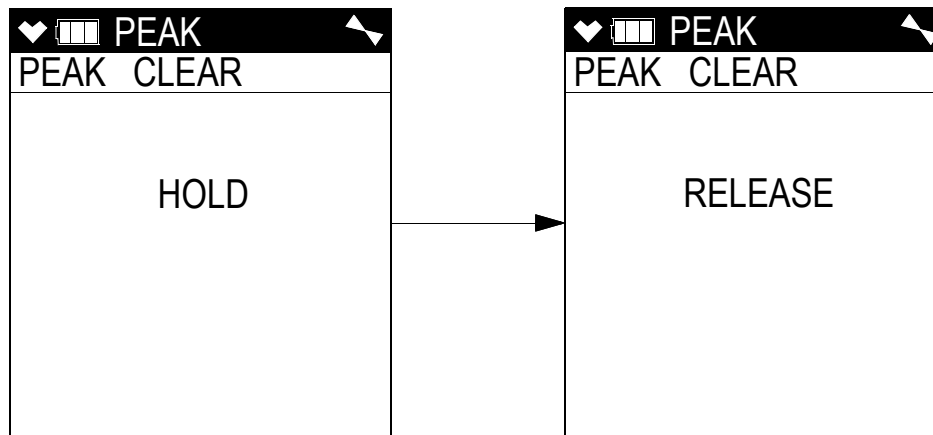

3. The peak readings are cleared and the unit returns to the **PEAK** Screen.

To return to the **PEAK** screen without clearing the peak readings, release the RESET button before the above screen sequence occurs.

STEL Screen

The STEL screen displays the short term exposure limit (STEL) readings for H_2S , CO , and high range VOC only. The STEL reading is the average reading over the last 15 minutes.

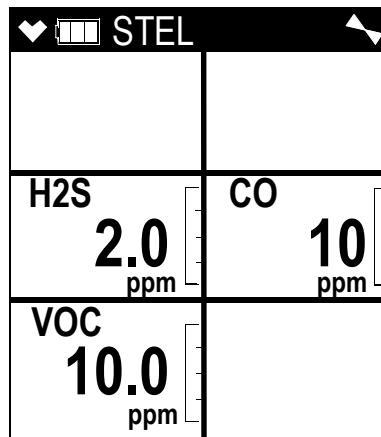

TWA Screen

The TWA screen displays the time weighted average (TWA) readings for H_2S , CO , and high range VOC only.

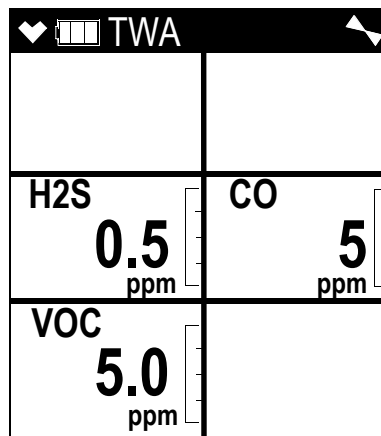

The TWA reading is the average reading over the last 8 hours. If 8 hours have not elapsed since the last time the TWA reading was cleared, the average is still calculated over 8 hours. The missing time is assigned a 0 value for readings.

Changing the User ID

Use this screen to select a user ID from the user ID list in the GX-6100's memory. The current user ID is displayed. A user ID can be up to 16 characters long. The GX-6100 can store up to 128 user IDs.

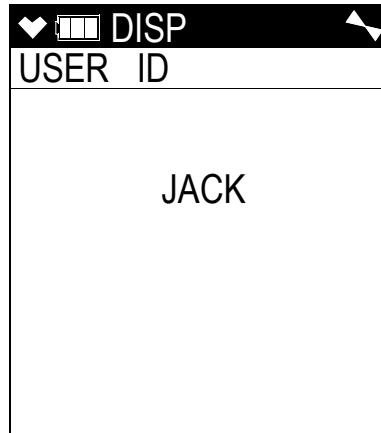

The user ID provides a way to identify the GX-6100 user during a data logging session.

To select a different user ID:

1. While in Measuring Mode, press DISP/LOCK until the **USER ID** screen appears.
2. Press POWER/ENTER. The current user ID begins flashing on screen.
3. Press ▲ AIR or SHIFT ▼ (PANIC) to scroll through the available user IDs. Any of the user IDs in the list that have not been changed from the factory setting will be shown as **USER_ID_XXX** where the “XXX” is a number from **000** to **127**.
4. When the desired user ID is displayed, press POWER/ENTER to select it.

To exit the selection screen without saving a change, press DISP/LOCK. You will return to the **USER ID** screen without saving the user ID change.

5. The unit will save the selected user ID as the current one and return to the **USER ID** screen.

Changing the Station ID

Use this screen to select a station ID from the station ID list in the GX-6100's memory. The current station ID is displayed. A station ID can be up to 16 characters long. The GX-6100 can store up to 128 station IDs.

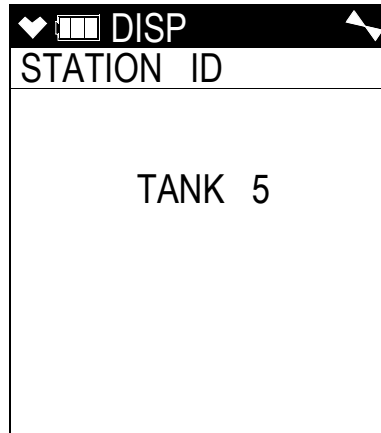

The station ID provides a way to identify a location where monitoring was done during a data logging session.

To select a different station ID:

1. While in Measuring Mode, press DISP/LOCK until the **STATION ID** screen appears.
2. Press POWER/ENTER. The current station ID begins flashing on screen.
3. Press ▲ AIR and SHIFT ▼ (PANIC) to scroll through the available station IDs. Any of the station IDs in the list that have not been changed from the factory setting will be shown as **STATION_ID_XXX** where the “XXX” is a number from 000 to 127.
4. When the desired station ID is displayed, press POWER/ENTER to select it.

To exit the selection screen without saving a change, press DISP/LOCK. You will return to the **STATION ID** screen without saving the station ID change.

5. The unit will save the selected station ID as the current one and return to the **STATION ID** screen.

Viewing Snap Log Data (REC. DATA DISP)

The Snap Logging screen allows you to view data from previous snap logs. For information on how to use the snap logging feature, see “Snap Log Mode” on page 44.

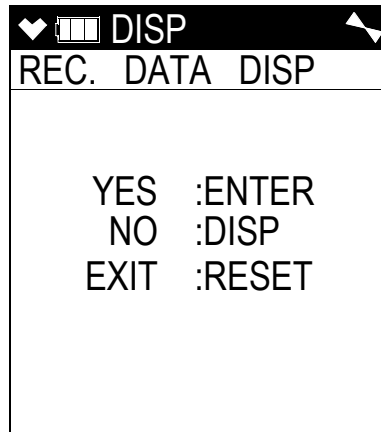

To view snap log data:

1. While in Measuring Mode, press DISP/LOCK until the **REC. DATA DISP** screen appears.
2. Press POWER/ENTER. If there are no snap logs saved to the instrument, the screen displays **NO DATA**.

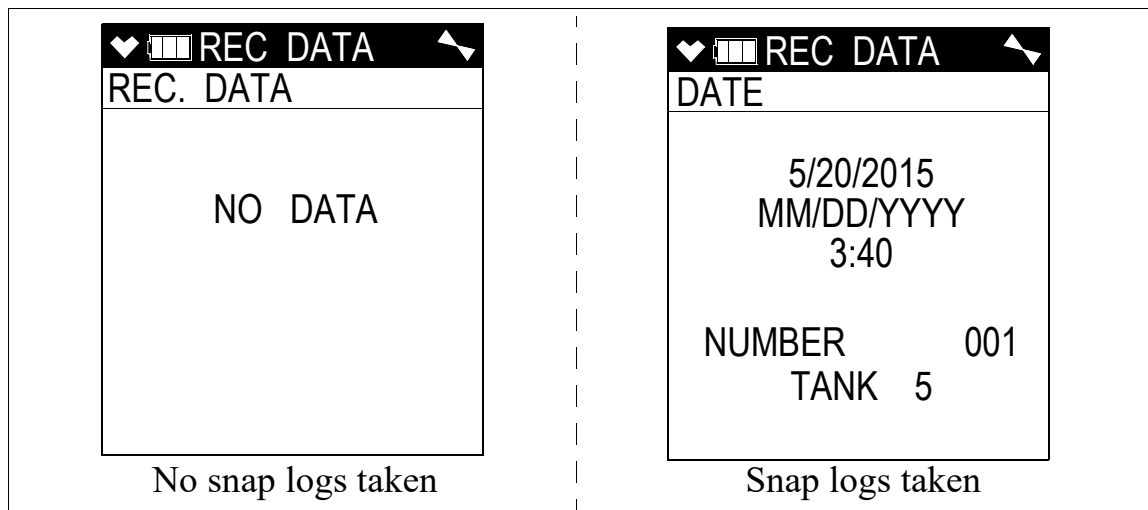

3. If snap logs have been taken, the screen indicates the year, month, day, and time that the most recent snap log was taken.

The number near the bottom of the screen indicates the snap log ID number. The first snap log that is taken is given an ID of **001**. The next snap log ID is **002**. The ID number increases sequentially with each set of snap log data.

The last line of the screen indicates the Station ID that was used for the snap log.

4. Press AIR or SHIFT (PANIC) to scroll through different snap logs.

5. To view a snap log's channel readings, press POWER/ENTER.

REC DATA	
CH4 0 %LEL	O2 20.9 %
H2S 0.0 ppm	CO 0 ppm
VOC 0 ppm	

The gas readings that were taken during the snap log are displayed. You can use the ▲ AIR and SHIFT ▼ (PANIC) buttons to scroll through the different snap logs. The gas readings will change as you view different snap log data but the snap log ID is not visible from this screen. To scroll through the data by viewing the snap log ID number, press and release POWER/ENTER.

6. To return to the **REC. DATA DISP** screen, press DISP/LOCK.

Turning the Pump Off

WARNING: *The GX-6100 is not a gas monitoring device while the pump is off.*

This feature can be used to conserve battery life if there is a significant period of time until the next gas monitoring task, but you do not want to wait for the warm-up sequence to complete if you turn the instrument off and on again.

DISP	
PUMP OFF	
YES	:ENTER
NO	:DISP
EXIT	:RESET

To use the Pump Off feature:

1. While in Measuring Mode, press DISP/LOCK until the **PUMP OFF** screen appears.

2. Press POWER/ENTER to turn the pump off. The fan symbol in the upper right corner will disappear. The instrument cannot return to Display Mode or Measuring Mode until the pump is turned back on.

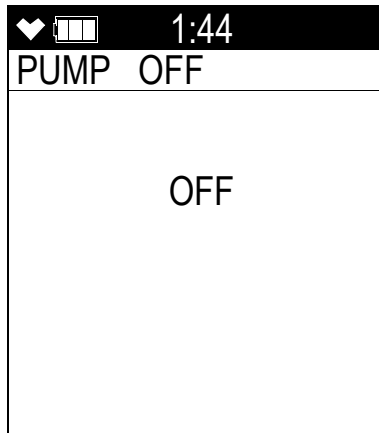

3. To turn the pump back on and return to Display Mode, press DISP/LOCK or POWER/ENTER.

Date/Time, Battery Voltage Screen

The **DATE AND BATTERY** screen displays the current battery voltage. Fully charged alkaline batteries typically indicate around 6.0 volts. A fully charged Li-ion battery pack typically indicates 4.1 volts. This screen also displays during the startup sequence.

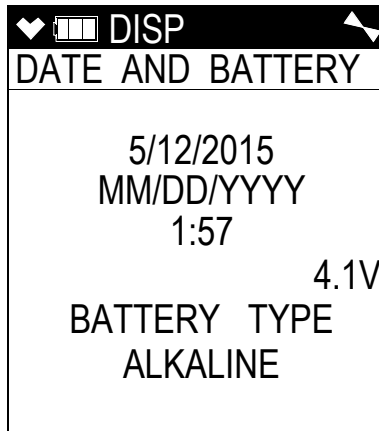

Viewing the Alarm Points

The **ALARM POINTS** screen can display and simulate the gas alarm settings for all active channels. To change the instrument's alarm points, see “Changing the Alarm Setpoints (ALARM POINTS)” on page 106.

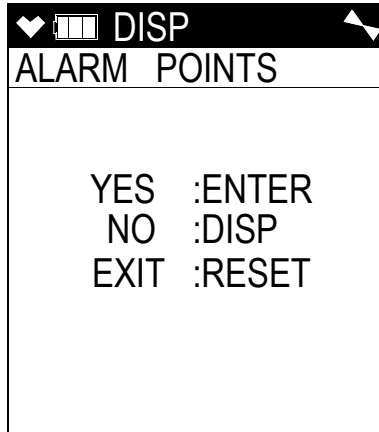

To view the alarm setpoints:

1. While in Measuring Mode, press DISP/LOCK until the **ALARM POINTS** screen appears.
2. Press POWER/ENTER. The **F.S.** screen will appear, showing full scale settings for each active channel.
3. Press ▲ AIR or SHIFT ▼ (PANIC) to scroll through the **ALARM 1**, **ALARM 2**, **ALARM 3**, **STEL**, and **TWA** settings. See Figure 12 for reference.
4. Pressing POWER/ENTER while viewing an alarm setting will cause the instrument to simulate that alarm condition. The buzzer, LED's, and vibration will activate. Press any button except POWER/ENTER to stop the simulated alarm.

5. Press DISP/LOCK to return to the **ALARM POINTS** screen.

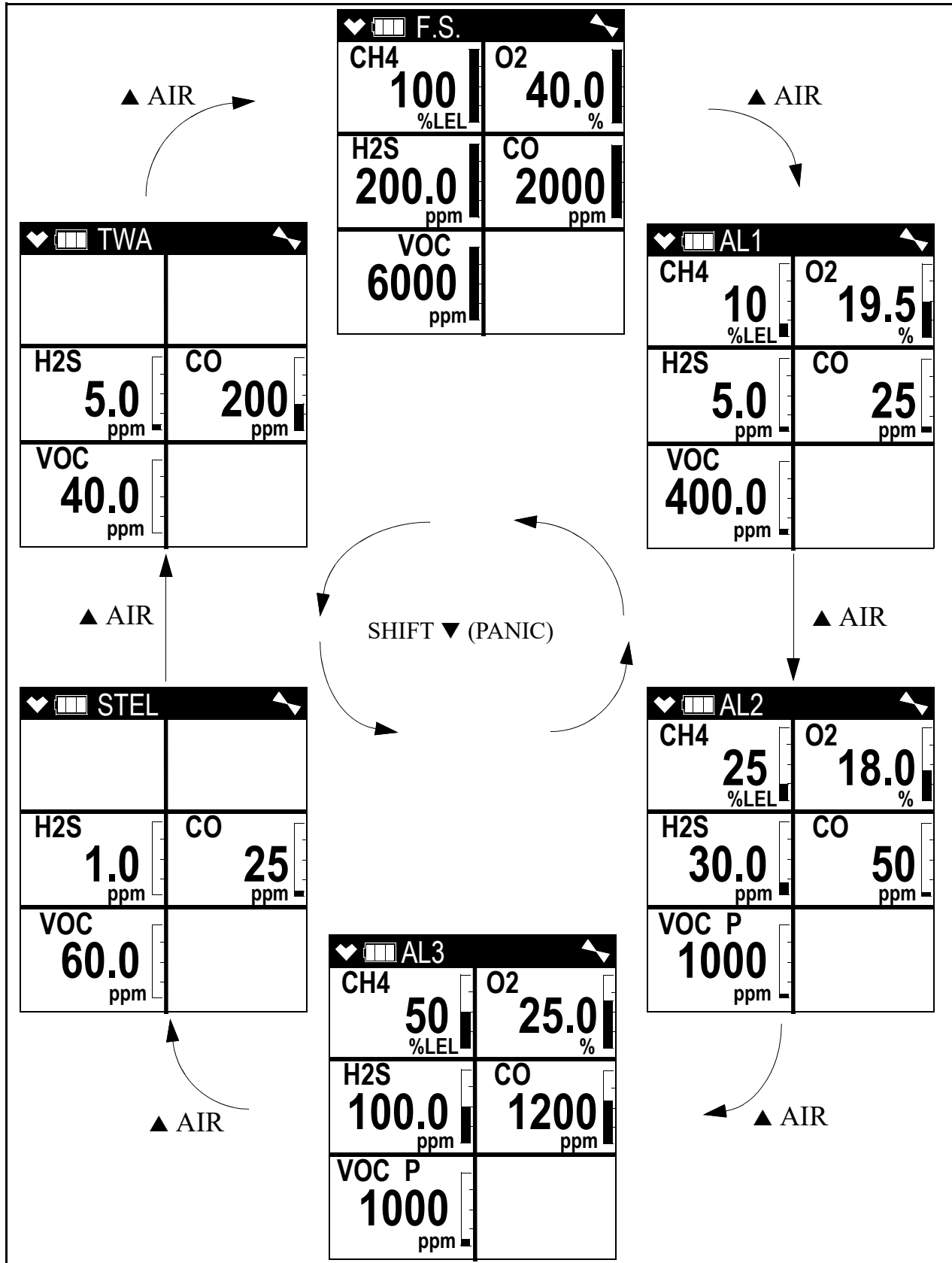
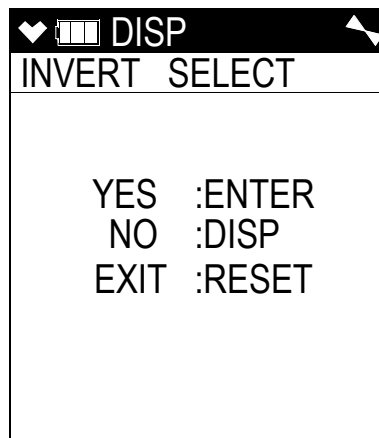

Figure 12: Alarm Points (Display Mode)

Changing the LCD Flip Setting (INVERSION SELECT)

NOTE: Screens in User Mode and Maintenance Mode will never flip upside down regardless of the instrument's **INVERT SELECT** setting or actual orientation.

- **OFF** (factory setting): The instrument's LCD will not flip and can only be read when the instrument is right side up. A **LOCK** symbol appears at the top of the screen to indicate that the LCD's position is fixed.
- **AUTO**: The instrument's LCD will rotate to match the orientation of the instrument.
- **ON**: The instrument's LCD flips upside down and can only be read when the instrument is in this orientation. A **LOCK** symbol appears at the top of the screen to indicate that the LCD's position is fixed.



To change the LCD Flip setting:

1. While in Measuring Mode, press DISP/LOCK until the **INVERSION SELECT** screen appears.
2. Press POWER/ENTER. The current setting begins flashing on screen.
3. Press ▲ AIR or SHIFT ▼ (PANIC) to display the desired setting.
4. Press POWER/ENTER to save the desired setting and return to the **INVERSION SELECT** screen.

To return to the **INVERSION SELECT** screen without saving any changes, press DISP/LOCK.

Changing the LCD Background Color

- **ON**: The LCD's colors will flip. The background will be black instead of white and the text will be white instead of black.
- **OFF** (factory setting): The LCD background will be white and the LCD text will be black.

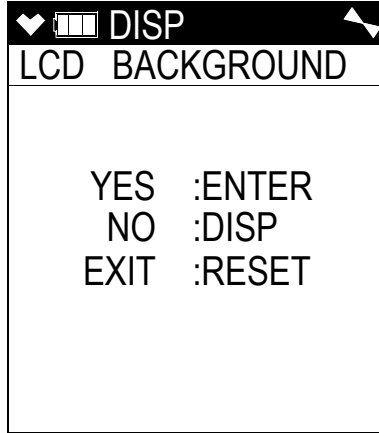

To change the LCD background color:

1. While in Measuring Mode, press DISP/LOCK until the **LCD BACKGROUND** screen appears.
2. Press POWER/ENTER. The current setting begins flashing on screen.
3. Press ▲ AIR or SHIFT ▼ (PANIC) to display the desired setting.
4. Press and release the POWER/ENTER button to save the desired setting and return to the **LCD BACKGROUND** screen.

To return to the **LCD BACKGROUND** screen without saving any changes, press DISP/LOCK.

Peak Bar Screen

The **PEAK BAR** screen turns the GX-6100's peak bar functionality on and off. The peak bar represents each channel's peak reading in bar graph format.

- **ON**: A peak bar appears along the right side of each channel reading in Measuring Mode and on the **PEAK** screen in Display Mode.
- **OFF**: Only the channel readings are displayed in Measuring Mode and on the **PEAK** screen in Display Mode.

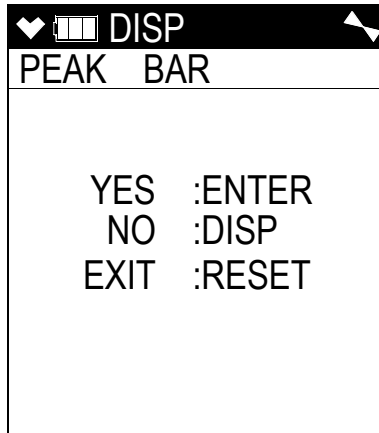

To change the Peak bar setting:

1. While in Measuring Mode, press DISP/LOCK until the **PEAK BAR** screen appears.
2. Press POWER/ENTER. The current setting begins flashing on screen.
3. Press ▲ AIR or SHIFT ▼ (PANIC) to display the desired setting.
4. Press POWER/ENTER to save the desired setting and return to the **PEAK BAR** screen.
To return to the **PEAK BAR** screen without saving any changes, press DISP/LOCK.

Gas Display Screen

The **GAS DISP** screen allows the user to choose how the gas readings are displayed in Measuring Mode.

NOTE: If anything other than **DISPLAY ALL** is selected, the instrument will return to **DISPLAY ALL** when it is turned off and turned back on.

- **DISPLAY ALL** (factory setting): All active channels' readings will be displayed at once
- **SCROLL AUTO**: One active channel will display at a time and the instrument will automatically scroll through all active channels for the duration of the operating session.
- **SCROLL MANUAL**: One active channel will display at a time and the user must press and release the POWER/ENTER button to scroll through all active channels. If the POWER/ENTER button is not pressed, the instrument will display the same channel's readings for the duration of the operating session.

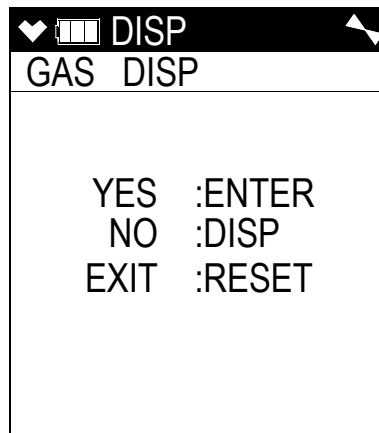

To change the Gas Display setting:

1. While in Measuring Mode, press DISP/LOCK until the **GAS DISP** screen appears.
2. Press POWER/ENTER. The available choices will appear.

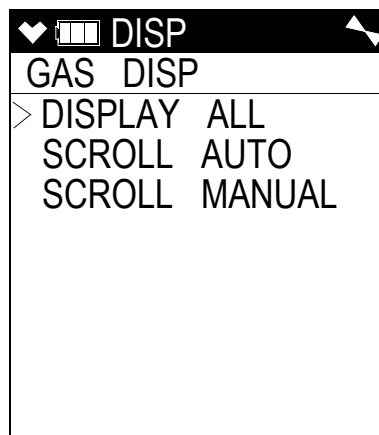

3. Press ▲ AIR or SHIFT ▼ (PANIC) to move the cursor next to the desired setting.

4. Press POWER/ENTER to save the desired setting and return to the **GAS DISP** screen.
To return to the **GAS DISP** screen without saving any changes, press DISP/LOCK.

Turning Bluetooth On/Off (BLUETOOTH)

The **BLUETOOTH** screen turns the GX-6100's Bluetooth functionality on and off.

- **ON**: Turns Bluetooth functionality on, allowing for connection to the RK Link app on your phone
- **OFF** (factory setting): Bluetooth functionality is turned off.

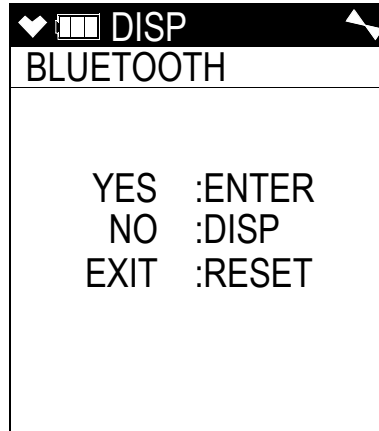

To turn Bluetooth on or off:

1. While in Measuring Mode, press DISP/LOCK until the **BLUETOOTH** screen appears.
2. Press POWER/ENTER. The current setting begins flashing on screen.
3. Press ▲ AIR or SHIFT ▼ (PANIC) to display the desired setting.
4. Press POWER/ENTER to save the desired setting and return to the **BLUETOOTH** screen.
To return to the **BLUETOOTH** screen without saving any changes, press DISP/LOCK.

Selecting the Buzzer Volume (BUZZER VOLUME)

The **BUZZER VOLUME** screen allows you to adjust the volume of the instrument's buzzer: **HIGH** (factory setting) or **LOW**.

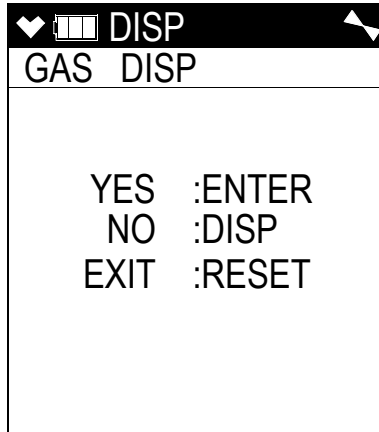

Selecting the Buzzer Volume setting:

1. While in Measuring Mode, press DISP/LOCK until the **BUZZER VOLUME** screen appears.
2. Press POWER/ENTER. The current setting begins flashing on screen.
3. Press ▲ AIR or SHIFT ▼ (PANIC) to display the desired setting.
4. Press POWER/ENTER to save the desired setting and return to the **BUZZER VOLUME** screen.

To return to the **BUZZER VOLUME** screen without saving any changes, press DISP/LOCK.

Chapter 5: User Mode and Calibration

Overview

This section describes using the GX-6100 in User Mode as well as how to calibrate and bump test the GX-6100.

See Table 12 for a list of the items found in User Mode, the page that the menu item instructions can be found on, and a short description of the menu item.

Table 12: User Mode Menu Items

Menu Item (page number)	Description		
BUMP TEST (page 80)	The instrument performs a bump test.		
GAS CAL (page 86)	Displays the following menu items:		
	AIR CAL	The instrument performs a fresh air adjustment.	
	CO2 ZERO	The instrument performs a zero adjustment on the CO ₂ channel using 100% nitrogen. <i>NOTE: This menu item only appears in units with a CO₂ sensor installed.</i>	
	SPAN CAL	CALIBRATION	The instrument performs a span adjustment.
		SETTING CAL-P	Sets the calibration concentration for each channel
CYL SETTING		Assigns the cylinder name for each channel (A-E)	
ALARM SETTING (page 105)	Displays the following settings:		
	ALARM POINTS (page 106)	Displays the current alarm points for each channel <i>NOTE: If Inert Mode has been enabled using the GX-6100 Config PC Program, Inert Mode alarms will be adjustable using this menu.</i>	
	ALARM LATCHING (page 108)	LATCHING (factory setting): The instrument remains in alarm until the alarm condition passes and POWER/ENTER is pressed. SELF-RESET : The instrument automatically resets an alarm when the alarm condition passes.	

Table 12: User Mode Menu Items

Menu Item (page number)	Description	
ALARM SET- TING (page 105) cont.	ALARM SILENCE (page 109)	<p>ON: The instrument's buzzer can be silenced during an alarm condition by pressing the POWER/ENTER or ▲ AIR buttons.</p> <p>OFF (factory setting): The instrument's buzzer cannot be silenced during an alarm condition by pressing the POWER/ENTER or ▲ AIR buttons.</p>
	LEAK SILENCE (page 110)	<p>ON (factory setting): While in Leak Check Mode, the buzzer can be silenced by pressing POWER/ENTER or ▲ AIR. When this setting is enabled, the letters NO ALM will flash on the screen.</p> <p>OFF: While in Leak Check Mode, the buzzer cannot be silenced. The alarm condition must first pass before the buzzer can be silenced by pressing POWER/ENTER.</p>
	ALARM ON (page 111)	<p>ON (factory setting): The alarms are enabled in Normal Mode.</p> <p>OFF: The alarms are not enabled. When this setting is enabled, the letters NO ALM will flash on the screen in Normal Mode.</p>
MAN DOWN (page 112)	Displays the following menu items:	
	MAN DOWN (page 112)	<p>ON: The Man Down Alarm can be triggered if the instrument detects no motion for the period of time defined in Warning 1 Time, Warning 2 Time, and Alarm Time.</p> <p>OFF (factory setting): The Man Down Alarm cannot be triggered.</p>
	PANIC (page 112)	<p>ON (factory setting): A Panic Alarm can be initiated by pressing and holding the SHIFT ▼ (PANIC) button.</p> <p>OFF: A Panic Alarm cannot be triggered.</p>

Table 12: User Mode Menu Items

Menu Item (page number)	Description	
MAN DOWN (page 112) cont.	MAN DOWN TIME (page 113)	<p>Sets the Warning 1, Warning 2, and Alarm Time periods (1 second increments from 10 - 120 seconds)</p> <p>Alarm Time \geq Warning 2 Time \geq Warning 1 Time</p> <p><u>Factory Settings:</u></p> <ul style="list-style-type: none"> • Alarm Time: 90 seconds • Warning 2: 75 seconds • Warning 1: 60 seconds
CO2AIR SETTING (page 114)	<p>ON: CO₂ channel is set to 400 ppm (0.04% VOL) during a demand zero, auto zero, or AIR CAL</p> <p>OFF (factory setting): CO₂ channel is not adjusted during a demand zero, auto zero, or AIR CAL</p> <p><i>NOTE: Only appears in units with a CO₂ sensor installed.</i></p>	
DATE (page 114)	Sets the instrument's date and time	
DATE FORMAT (page 158)	Sets the date format	
LANGUAGE (page 116)	Sets the instrument's user interface language	
VERSION (page 117)	Displays the version numbers for the main board, PID table, Bluetooth, and sensor board	
START MEASURE (page 118)	Returns to Measuring Mode	

Tips for Using User Mode

- When in the main menu, the cursor (>) indicates which menu item will be selected if the POWER/ENTER button is pressed and released.
- Use the SHIFT ▼ (PANIC) button to move the cursor down through the main menu and submenu items, and to lower values or change the setting in a specific option.
- Use the ▲ AIR button to move the cursor up through the main menu and submenu items, and to raise values or change the setting in a specific option.
- Use the POWER/ENTER button to enter a selected menu item with the cursor next to it and to enter and save settings during programming.
- An adjustable parameter that is flashing can be adjusted with the ▲ AIR and SHIFT ▼ (PANIC) buttons.

- Press the DISP/LOCK button while in a screen where you are entering or updating parameters to exit the screen without saving any changes.

Entering User Mode

WARNING: *The GX-6100 is not in operation as a gas detector while in User Mode.*

1. Take the GX-6100 to a non-hazardous location and turn it off if it is on.
2. Press and hold the ▲ AIR and SHIFT ▼ (PANIC) buttons, then press and hold the POWER/ENTER button. After the beep, release the buttons.
3. The User Mode main menu displays. It has 9 menu items.

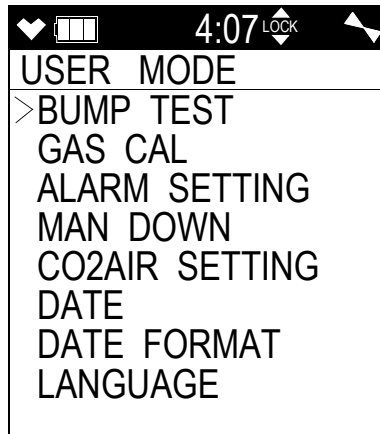

4. Use the ▲ AIR or SHIFT ▼ (PANIC) button to move the cursor up and down the menu items.

Performing a Bump Test

NOTE: If your GX-6100 has a PH₃ or Cl₂ sensor installed, they must be bump tested before any other installed sensors. See “ESS-03 Bump Testing” on page 201 for more information.

If the combustible gas channel is calibrated to a gas other than methane, use an appropriate multigas cylinder.

1. Install the demand flow regulator onto the calibration cylinder.
2. Connect the sample tubing to the demand flow regulator.
3. Install the sample hose and probe on the GX-6100 inlet fitting. Make sure the probe's two halves are tightened firmly together to avoid leaks that can affect the calibration. See Figure 24 on page 130 for an illustration of the internal parts of the probe.
4. Press and hold ▲ AIR and SHIFT (PANIC). Press POWER/ENTER.

5. After the beep, release all buttons. The MODE SELECT screen appears with the cursor next to **USER MODE**.

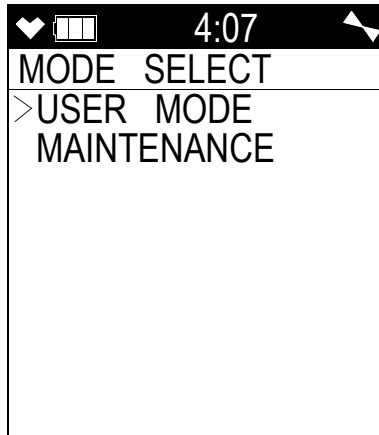

6. The User Mode menu displays with the cursor next to **BUMP TEST**.

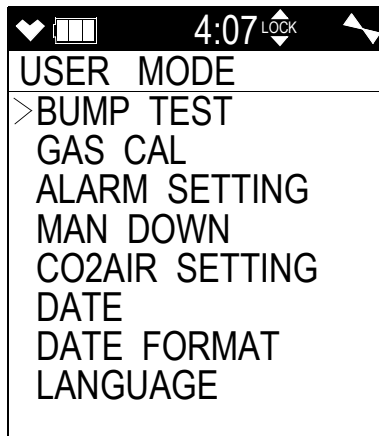

7. Press POWER/ENTER. The first of the Gas Select screens, the standard four sensors screen, will be displayed. In addition to the standard four sensors screen, there is a separate screen for each installed smart sensor, and an **ESCAPE** screen that will take you back to the User Mode menu. Use the ▲ AIR and SHIFT ▼ (PANIC) buttons to display the gas(es) you want to test.

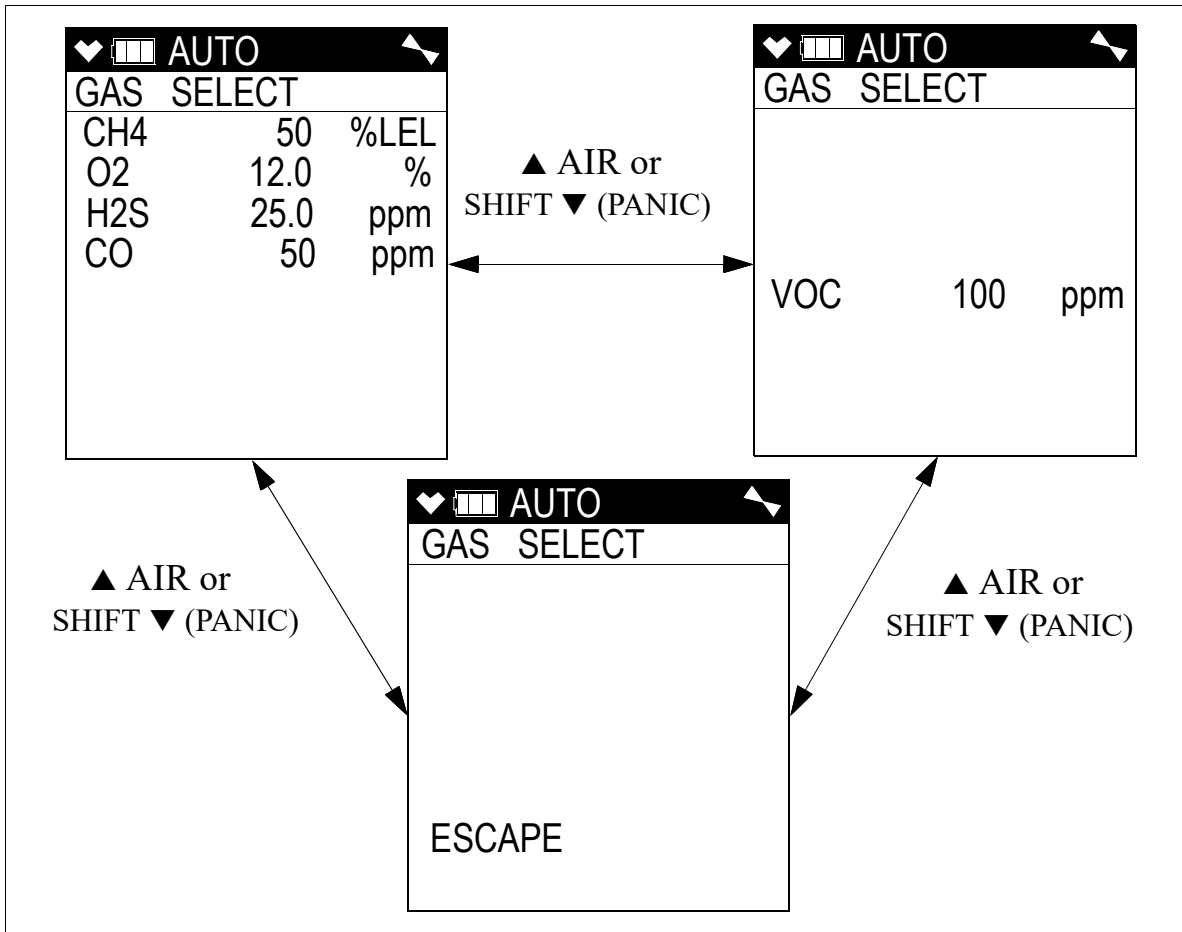

8. Before proceeding, confirm that the bump test gas value(s) are the same as the concentration(s) in the calibration cylinder. If they are not, adjust the bump test gas value(s) by entering the **GAS CAL** menu item in User Mode, changing the value(s) there, and reentering the **BUMP TEST** menu item.

9. With the desired sensor screen displayed, connect the tubing from the demand flow regulator to the rigid tube on the probe then quickly press and release the POWER/ENTER button to proceed to the Bump In Progress screen. The instrument will count down.

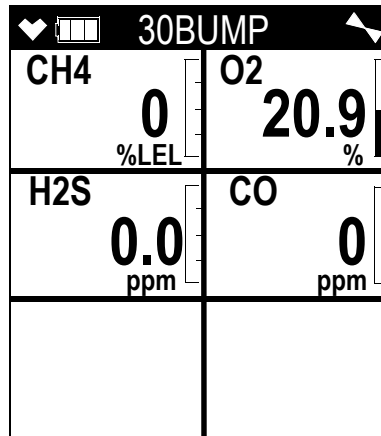

If you do not want to proceed with the bump test, press and release the DISP/LOCK button to return to the Gas Select screen.

If you do want to continue with the bump test, proceed to the next step.

10. When **Calibration After Bump Test Failed** in the **BUMP PARAMETERS** menu item in the GX-6100 Configuration Program is set to **OFF**:
 - a. The instrument will indicate which channels passed or failed the bump test with an **OK** (pass) or an **NG** (fail) to the right of the gas. You can scroll between the bump test results and the bump test gas readings with the ▲ AIR and SHIFT ▼ (PANIC) button.

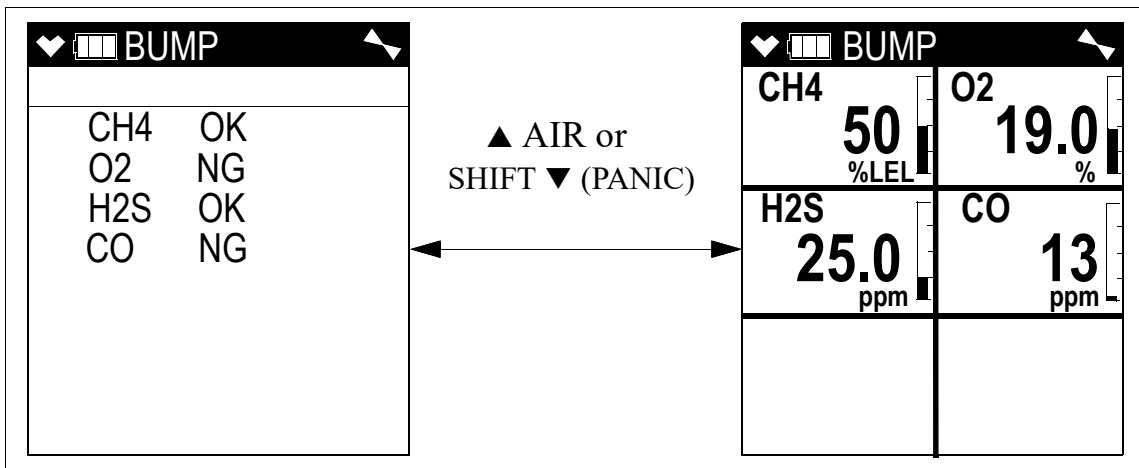

- b. If all channels passed: Press and release the POWER/ENTER button to return to the Gas Select screen. If **Automatic Start After Successful Bump Test** is selected in the GX-6100 Configuration Program and if your instrument is a 4-gas only, the instrument will automatically start the warmup sequence.
- c. If any channels failed: The buzzer will sound a double pulsing tone until you press and release the POWER/ENTER button to return to the Gas Select screen.
See “Troubleshooting” on page 119 to investigate the cause of the failure and replace the failed sensor(s) if necessary.
- d. Disconnect the tubing from the probe.

11. When **Calibration after Bump Test Failed** in the GX-6100 Configuration Program is set to **ON**:

If all channels pass the bump test:

- a. The results screen appears. You can scroll between the bump test results and the bump test gas readings with the ▲ AIR and SHIFT ▼ (PANIC) buttons.

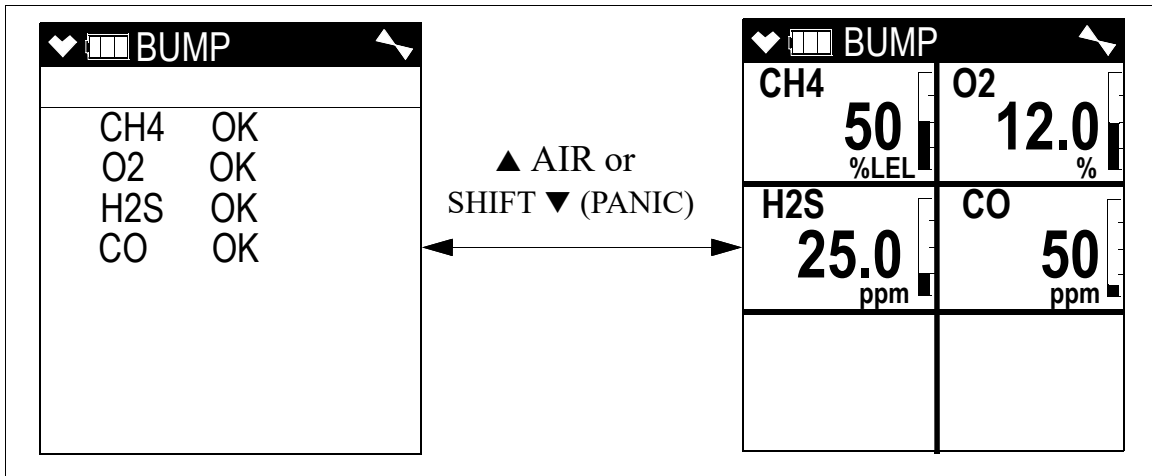

- b. To return to the Gas Select screen, press and release the POWER/ENTER button. If **Automatic Start After Successful Bump Test** is selected (factory setting) in the GX-6100 Configuration Program and your instrument is a 4-gas only, the instrument will automatically start the warmup sequence.
- c. Disconnect the tubing from the probe.

If any channel fails the bump test:

- a. The instrument will beep and a calibration is immediately and automatically started. Continue to apply the calibration gas. CAL will appear at the top of the screen along with a countdown.

The calibration time counted down during a calibration initiated because of a failed bump test is the difference between the gas time and the calibration time defined in the **Bump Test Parameter** area in the GX-6100 Configuration Program.

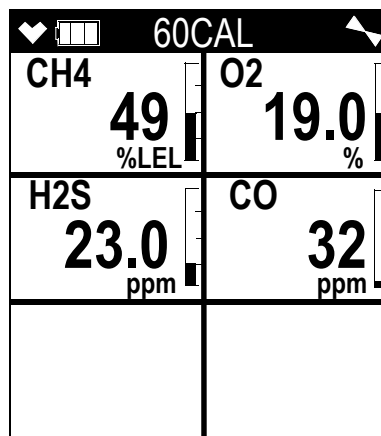

- b. At the end of the calibration, the instrument displays the results from both the bump test and the calibration. Use the ▲ AIR and SHIFT ▼ (PANIC) button to scroll between the calibration/bump test results, the bump test gas readings, and the calibration gas readings.

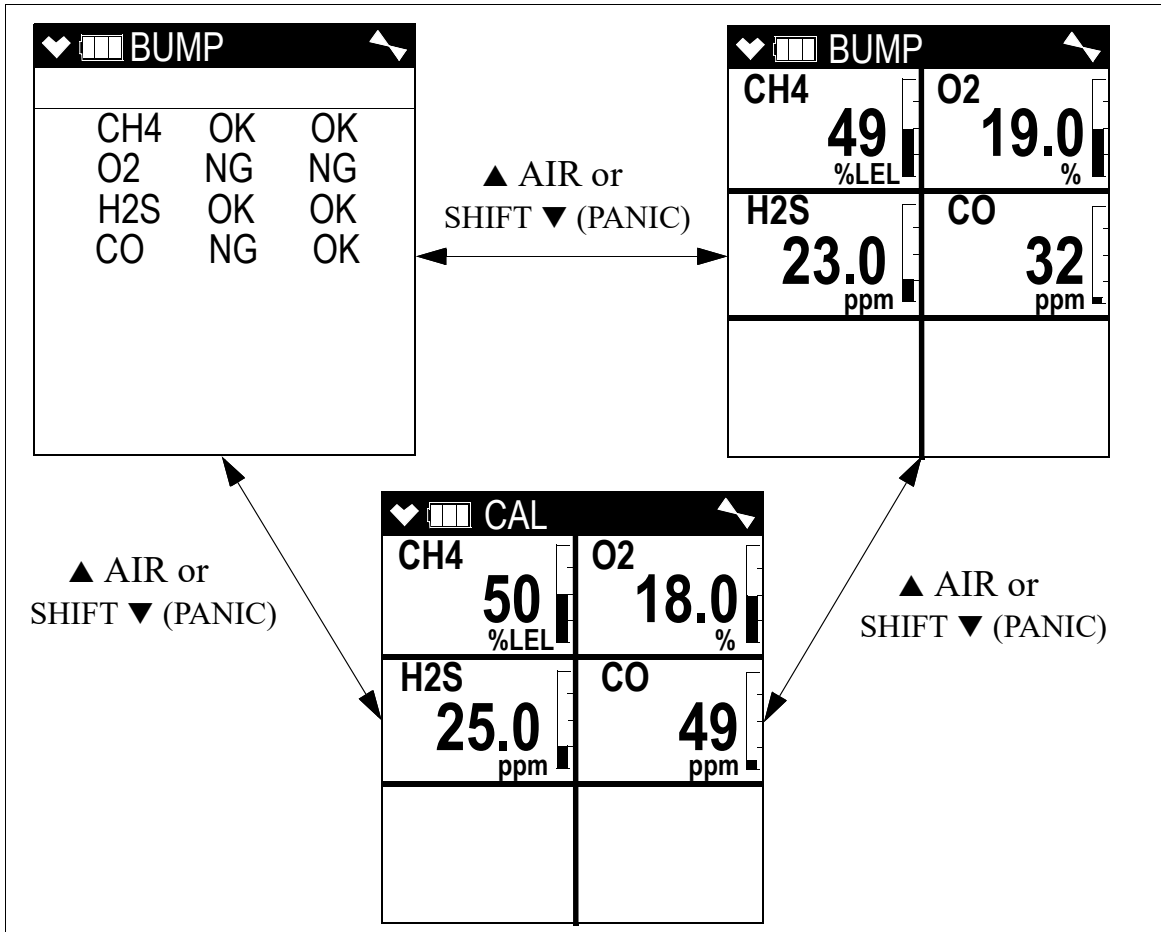

- c. To return to the Gas Select screen, press and release the POWER/ENTER button at any time. If any channel failed the calibration, the buzzer will sound a double pulsing tone until you press and release the POWER/ENTER button.
- d. Disconnect the tubing from the probe.
12. Unscrew the demand flow regulator from the calibration cylinder.
 13. If you want to bump test any more channels, repeat Step 9 - Step 12.
 14. Use the SHIFT ▼ (PANIC) button to display the **ESCAPE** screen, then press and release the POWER/ENTER button to return to the User Mode menu.
 15. Use the SHIFT ▼ (PANIC) button to place the cursor next to the **START MEASURE** menu item, then press and release the POWER/ENTER button to return to Measuring Mode.

Returning to Measuring Mode

1. Disconnect the tubing from the probe.
2. Unscrew the demand flow regulator from the calibration cylinder.
3. For a passed bump test, the cursor will already be next to **START MEASURE**. Press and release the POWER/ENTER button to return to Measuring Mode.
4. For a failed bump test:
 - a. Use the SHIFT ▼ (PANIC) button to displays the Escape Gas Select screen, then press and release the POWER/ENTER button to return to the **GAS CAL** menu.
 - b. Use the SHIFT ▼ (PANIC) button to move the cursor next to **ESCAPE**, then press and release the POWER/ENTER button to return to the User Mode menu.
 - c. Use the SHIFT ▼ (PANIC) button to place the cursor next to **START MEASURE**, then press and release the POWER/ENTER button to return to Measuring Mode.

Performing a Calibration (GAS CAL)

NOTE: You can set up the GX-6100 to alert you during the startup sequence when calibration is due using the GX-6100 Configuration Program. See the *GX-6100 Configuration Program Operator's Manual*.

CAUTION: *BEFORE EACH DAY'S USAGE, SENSITIVITY IN THE %LEL RANGE MUST BE TESTED ON A KNOWN CONCENTRATION OF THE COMBUSTIBLE TARGET GAS, METHANE, EQUIVALENT TO 25 - 50% OF FULL SCALE CONCENTRATION (the %LEL full scale is 100% LEL). ACCURACY MUST BE WITHIN -0 to + 20% OF ACTUAL. ACCURACY MAY BE CORRECTED BY FOLLOWING THE CALIBRATION INSTRUCTIONS FOR THE COMBUSTIBLE CHANNEL BELOW.*

If the combustible channel passes the above response test and does not require calibration, the unit should still be calibrated periodically. The optimum frequency of calibration depends heavily on how the GX-6100 is used. For example, instruments used daily may need to be calibrated weekly or monthly, while instruments that are used only a few times a year may need to be calibrated before each use. Typical calibration frequencies range from monthly to quarterly. Make sure to perform the combustible channel response test as described above and make sure to develop a calibration schedule tailored to your application that takes this test and required calibration resulting from this test into account.

Calibration Supplies and Equipment

To calibrate the GX-6100, you will need:

- Known calibrating samples of the gases being detected

Channel	Min. Cal. Gas Concentration	Max. Cal. Gas Concentration
Combustible and toxic gases	10% of full scale	75% of full scale
Oxygen	0.0%	17.0%

- An oxygen-free source, such as 100% nitrogen is recommended for setting the oxygen zero.

CAUTION: When using span calibration, although the GX-6100 can be calibrated with an oxygen concentration of up to 18.0%, RKI Instruments, Inc. recommends that the multi-gas cylinder have an oxygen concentration in the range of 10% - 16% oxygen.

- A demand-flow regulator to provide adequate sample gas flow

NOTE: RKI Instruments, Inc. recommends that you dedicate a regulator for use with chlorine (Cl₂) gas and that you do not use that dedicated regulator for any other gases, particularly hydrogen sulfide (H₂S).

- Non-absorbent tubing

WARNING: If you are using a calibration kit that includes a gas bag and a fixed flow regulator or dispensing valve, do not apply gas directly to the GX-6100 with the regulator or dispensing valve or damage to the pump will result.

To calibrate the %LEL, oxygen, CO, H₂S, and PID sensors at the same time without a zero-oxygen source, you can use the span calibration feature with either a 5-gas cylinder or a 4-gas cylinder and a PID cylinder. This chapter includes instructions for both scenarios.

Setting the Fresh Air Reading

1. Find a fresh-air environment. This is an environment free of toxic or combustible gases and of normal oxygen content (20.9%).
2. Turn the instrument off if it is on.
3. Press and hold ▲ AIR and SHIFT (PANIC), then press and hold POWER/ENTER.

4. Release all buttons after the beep. The **MODE SELECT** screen appears with the cursor next to **USER MODE**.

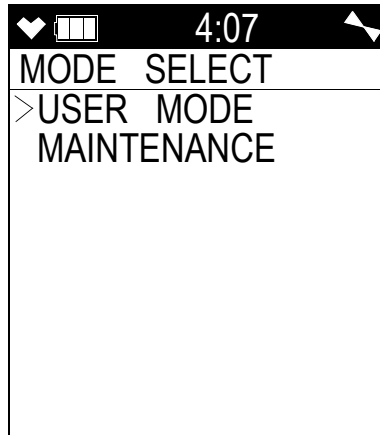

5. The User Mode menu appears with the cursor next to **BUMP TEST**.

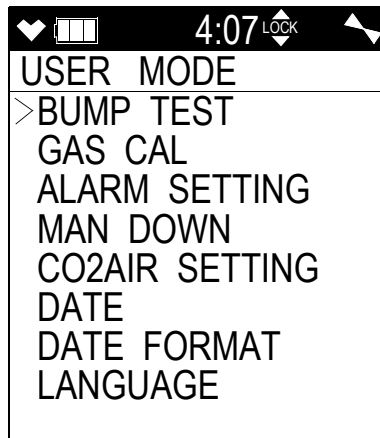

6. Press ▲ AIR or SHIFT ▼ (PANIC) to scroll to the **GAS CAL** menu item.
7. Press POWER/ENTER. The **GAS CAL** menu displays with the cursor next to **AIR CAL**.

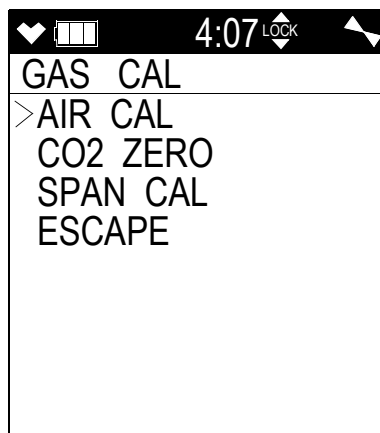

8. Press and release the POWER/ENTER button. The Fresh Air Reading screen will display.

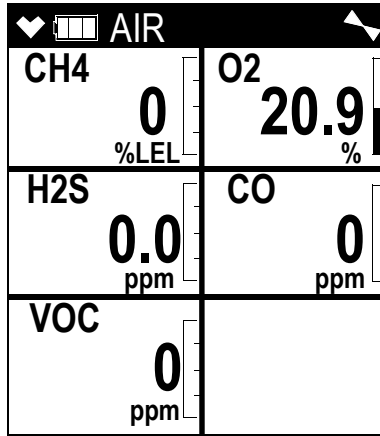

9. If any low-level VOC background is suspected in the area, a VOC zero filter must be used.

NOTE: If you have both a PID or NH₃ sensor and a CO₂ sensors installed, you will need to follow the directions on page 212 instead of following the directions shown below.

- a. Remove the plug from each end of the VOC zero filter.
 - b. Attach the VOC zero filter to the inlet fitting or probe. The filter does not have a preferred flow direction.
 - c. Let the instrument draw through the VOC zero filter for 1 minute before continuing.
10. To continue with the fresh air adjustment, press and hold the ▲ AIR button.
If you do not want to continue, press and release the DISP/LOCK button and the unit will return to the **GAS CAL** screen.
11. The GX-6100 will indicate that it is adjusting the zero reading for a few seconds and then it will prompt you to release the ▲ AIR button.

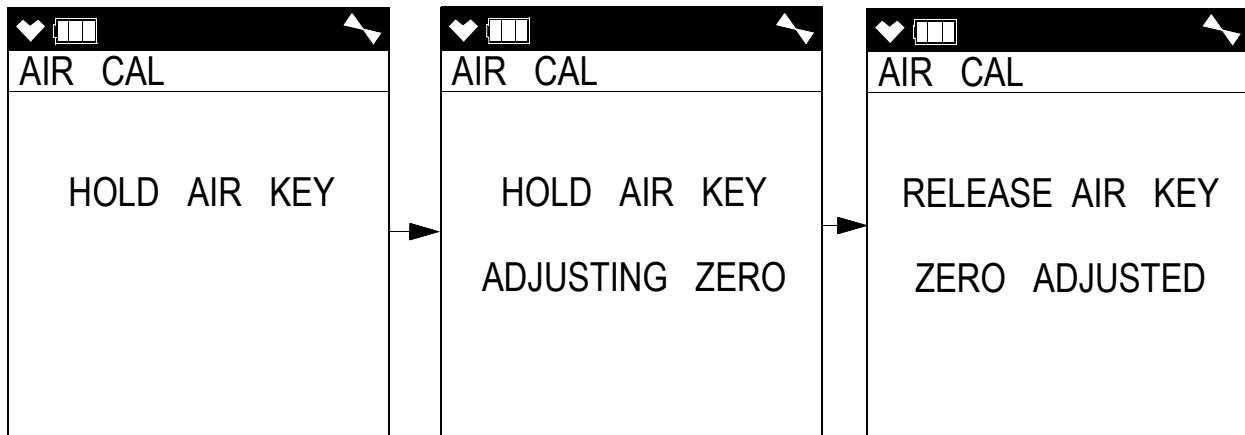

12. Release the ▲ AIR button. The fresh air adjustment will finish, the fresh air readings will be displayed momentarily, and then the instrument will return to the **GAS CAL** screen.

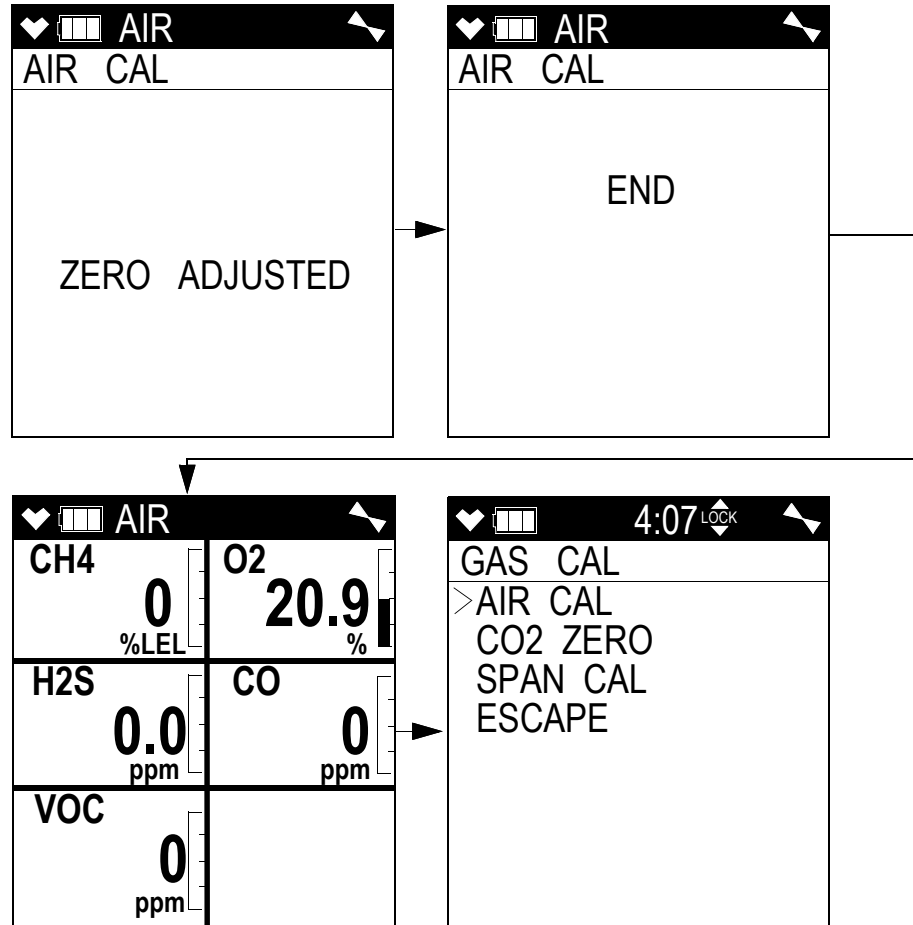

13. If the VOC zero filter was used, remove the filter from the GX-6100's inlet fitting or probe. Reinstall the plugs on each end of the filter.

Performing a Zero Adjustment on the CO₂ Sensor (CO₂ ZERO CAL)

Performing a zero adjustment on the CO₂ sensor sets the sensor's zero to a known concentration of CO₂ (0 ppm or 0%).

Preparing for a CO₂ ZERO CAL

To set the zero reading on the CO₂ sensor, you will need:

- 100% nitrogen (N₂) cylinder
- Demand flow regulator
- Non-absorbent tubing

1. Install the demand flow regulator onto the calibration cylinder.
2. Connect the sample tubing to the demand flow regulator.

3. Install the sample hose and probe on the GX-6100 inlet fitting. Make sure the probe's two halves are tightened firmly together to avoid leaks that can affect the calibration. See Figure 24 on page 130 for an illustration of the internal parts of the probe.

Performing a CO2 ZERO CAL

1. Find a fresh-air environment. This is an environment free of toxic or combustible gases and of normal oxygen content (20.9%).
2. Turn the instrument off if it is on.
3. Press and hold ▲ AIR and SHIFT (PANIC), then press and hold POWER/ENTER.
4. Release all buttons after the beep. The **MODE SELECT** screen appears with the cursor next to **USER MODE**.

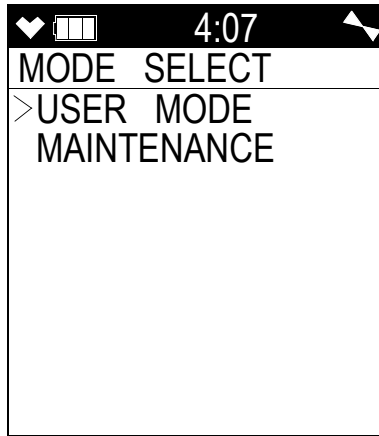

5. The User Mode menu appears with the cursor next to **BUMP TEST**.

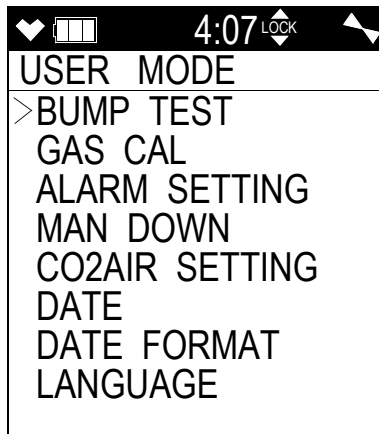

6. Press ▲ AIR or SHIFT ▼ (PANIC) to scroll to the **GAS CAL** menu item.

7. Press POWER/ENTER. The GAS CAL menu displays with the cursor next to **AIR CAL**.

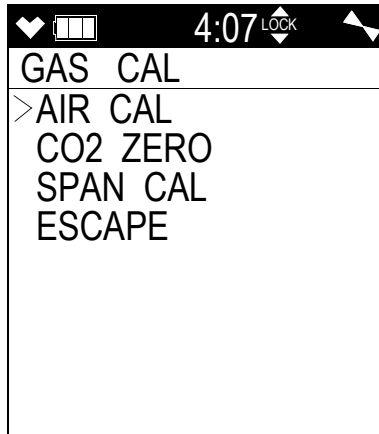

8. Press ▲ AIR or SHIFT ▼ (PANIC) to scroll to the **CO2 ZERO** menu item.
9. Make sure the GX-6100 has been turned on for at least 45 seconds before continuing.
10. Press and release POWER MODE. The CO₂ channel displays the current reading.

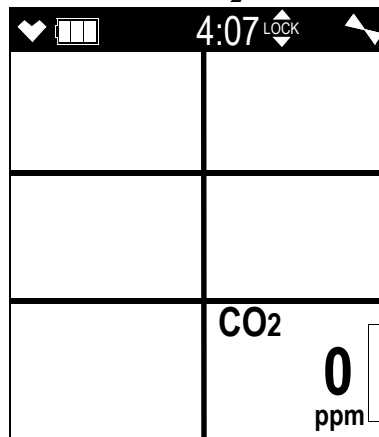

NOTE: To back out of the gas application screen without performing the bump test, press DISP/LOCK.

11. Connect the tubing from the demand flow regulator to the rigid tube on the probe.
12. Allow the gas to flow for 1 minute.
13. Press and release POWER MODE to confirm the current CO₂ reading.
14. Remove the tubing from the probe.
15. If the zero adjustment passed, the screen says “**PASS**” and the instrument returns to the Gas Cal menu.

16. If the zero adjustment failed:
 - a. “**FAIL**” replaces the gas reading.
 - b. The LEDs flash and the buzzer sounds a double pulsing tone.
 - c. Press and release RESET to clear the failure. The instrument returns to the **GAS CAL** menu.
 - d. See “Troubleshooting” on page 119.
17. Unscrew the regulator from the calibration cylinder.
18. Store the calibration kit in a safe and convenient place.
19. Press ▲ AIR or SHIFT ▼ (PANIC) to place the cursor next to **ESCAPE**.
20. Press and release POWER MODE. The instrument returns to User Mode.

Performing a Span Adjustment

NOTE: If your GX-6100 has a PH₃ or Cl₂ sensor installed, they must be calibrated before any other installed sensors. See “ESS-03 Calibration” on page 200 for more information.

1. Find a fresh-air environment. This is an environment free of toxic or combustible gases and of normal oxygen content (20.9%).
2. Turn the instrument off if it is on.
3. Press and hold ▲ AIR and SHIFT (PANIC). Press POWER/ENTER then release all buttons after the beep. The **MODE SELECT** screen appears with the cursor next to **USER MODE**.

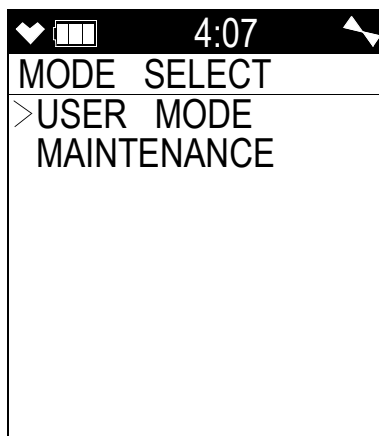

4. The User Mode menu displays with the cursor next to **BUMP TEST**.

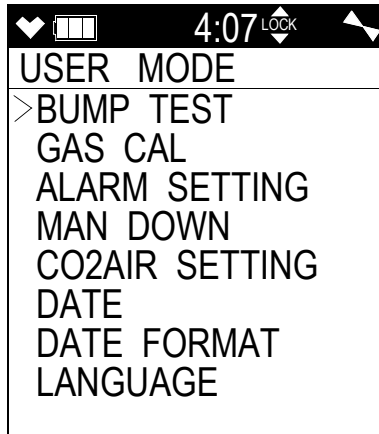

5. Press SHIFT ▼ (PANIC) to scroll to the **GAS CAL** menu item.
6. Press POWER/ENTER. The **GAS CAL** menu displays with the cursor next to **AIR CAL**.

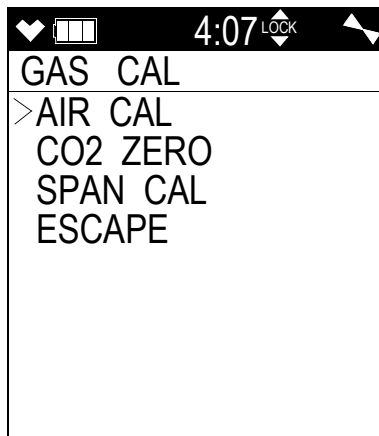

7. Install the demand flow regulator onto the 4-gas or 5-gas calibration cylinder.

8. Connect the sample tubing to the demand flow regulator.
9. Install the sample hose and probe on the GX-6100 inlet fitting. Make sure the probe's two halves are tightened firmly together to avoid leaks that can affect the calibration. See Figure 24 on page 130 for an illustration of the internal parts of the probe.
10. Scroll to the **SPAN CAL** menu item by pressing ▲ AIR or SHIFT ▼ (PANIC).

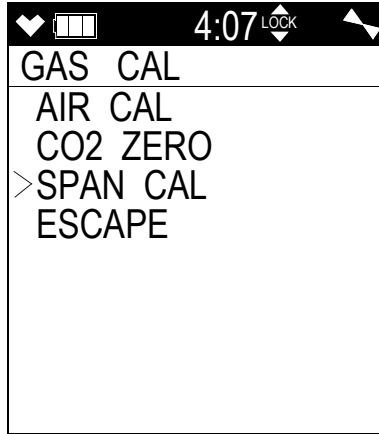

11. Press and release the POWER/ENTER button to display the **SPAN CAL** menu.

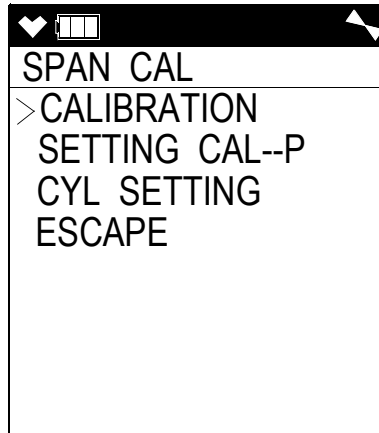

12. Press POWER/ENTER to enter the CAL sequence. The instrument displays the gases assigned to Cylinder A and their assigned calibration values (see page 100 if the calibration values do not match the calibration gas cylinder's concentrations).

CAL		
CYLINDER A		
CH4	50	%LEL
O2	12.0	%
H2S	25.0	ppm
CO	50	ppm

If necessary, use AIR to scroll to the **GAS CAL** screen for the gas(es) you want to calibrate. As shipped from the factory, 4-gases assigned to Cylinder A and PID channel assigned to Cylinder B. If an H₂-compensated CO sensor is installed, H₂ is assigned to Cylinder D.

If you have a 5-gas cylinder with isobutylene, change the PID sensor's cylinder assignment to Cylinder A to calibrate any 4-gas sensors at the same time as the PID sensor.

13. Press and release the POWER/ENTER button to proceed to the Calibration In Process screen with **APPLYGAS** and the gas readings flashing.

APPLY	
CH4 0 %LEL	O2 20.9 %
H2S 0.0 ppm	CO 0 ppm

If you do not want to proceed with the calibration, press and release the DISP/LOCK button to return to the **SPAN CAL** menu.

If you do want to continue with the calibration, proceed to the next step.

14. Connect the tubing from the demand flow regulator to the rigid tube on the probe. Allow the GX-6100 to draw gas for one minute.
15. Press and release the POWER/ENTER button to set the span adjustment for each channel to the programmed values.

16. If all channels passed calibration, if **SEN LIFE ALERT** is set to **ON**, and if a sensor is in a sensor life warning condition, the following screen sequence occurs.

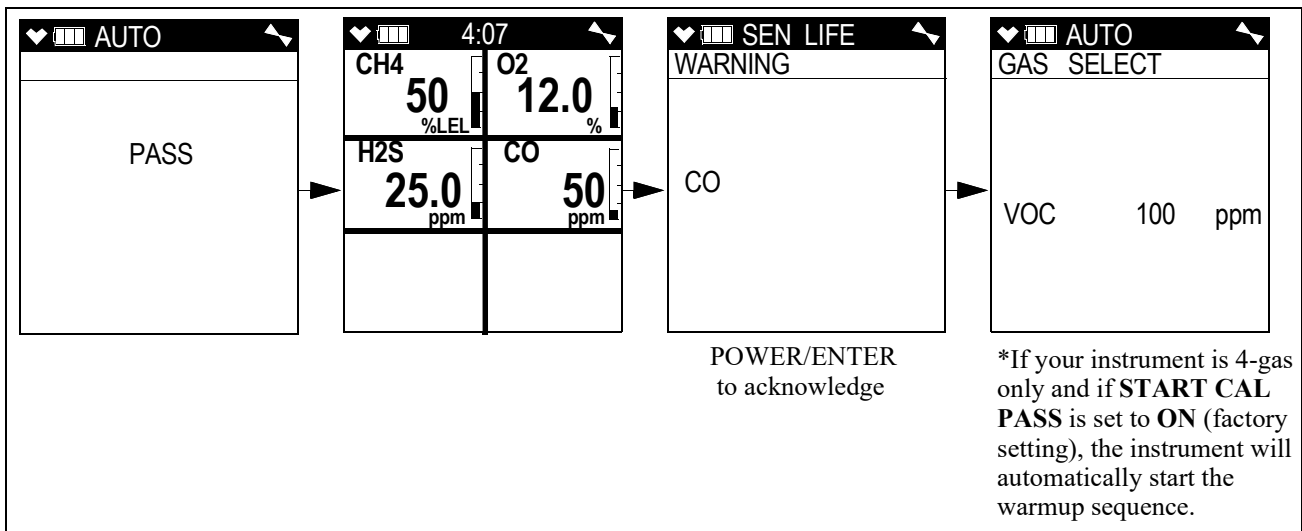

The buzzer and LEDs activate in a double pulsing pattern in the sensor life warning screen.

17. Press and release POWER/ENTER to acknowledge the warning.

18. If all channels passed calibration and if no sensors are in a sensor life warning condition or if **SEN LIFE ALERT** is set to **OFF** (factory setting), the following screen sequence occurs.

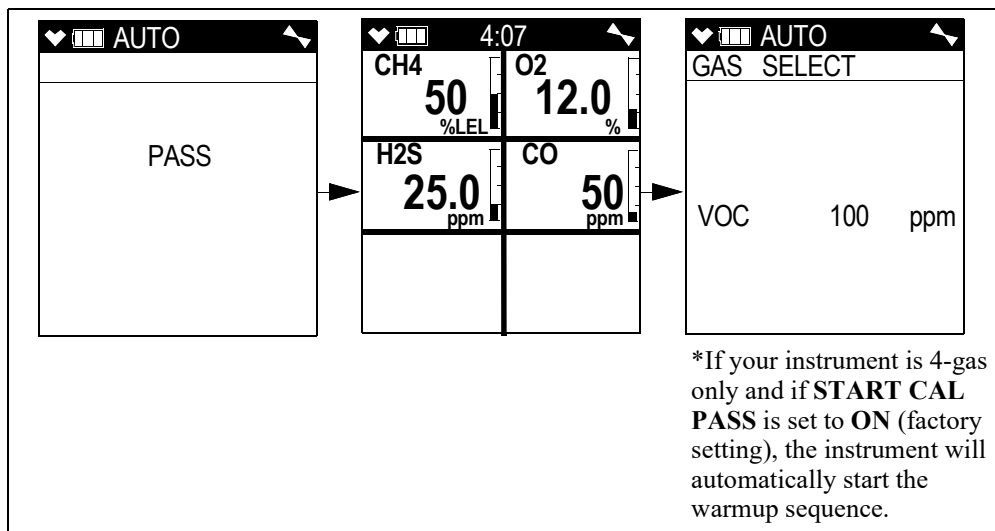

19. If any of the sensors cannot be adjusted to the proper value, a screen displays that indicates a calibration failure and lists the sensor(s) that failed to calibrate. In the example below, the oxygen and H₂S channels failed calibration. The other sensors calibrated normally.

SENSOR	
	O2 FAIL %
H2S FAIL ppm	

The buzzer and alarm LEDs activate in a double pulsing pattern. Press and release the RESET button to reset the alarm and continue to the Gas Select screen. After calibrating the PID channel by following the instructions below, attempt to calibrate the standard channels again. If the failure continues, investigate the cause. See “Troubleshooting” on page 119.

If **SEN LIFE ALERT** is set to **ON** (factory setting is **OFF**) and if a sensor is in a sensor life warning condition, the following screen appears. The buzzer and LEDs activate in a double pulsing pattern. Press and release POWER/ENTER to acknowledge the sensor life warning.

SEN LIFE
WARNING
CO

The SPAN CAL screen displays.

AUTO		
GAS	SELECT	
CH4	50	%LEL
O2	12.0	%
H2S	25.0	ppm
CO	50	ppm

20. Repeat Step 13 through Step 19 for any other sensors that need calibration.

Returning to Measuring Mode

1. Disconnect the tubing from the probe.
2. Unscrew the demand flow regulator from the calibration cylinder.
3. For a passed calibration, the cursor will already be next to **START MEASURE**. Press and release the POWER/ENTER button to return to Measuring Mode.
4. For a failed calibration:
 - a. Use the SHIFT ▼ (PANIC) button to displays the Escape Gas Select screen, then press and release the POWER/ENTER button to return to the **GAS CAL** menu.
 - b. Use the SHIFT ▼ (PANIC) button to move the cursor next to **ESCAPE**, then press and release the POWER/ENTER button to return to the User Mode menu.
 - c. Use the SHIFT ▼ (PANIC) button to place the cursor next to **START MEASURE**, then press and release the POWER/ENTER button to return to Measuring Mode.

Setting Calibration Concentration Values (SETTING CAL-P)

This menu item allows you to update one or more calibration values (the reading required to pass a calibration/bump test). Refer to the table below for the minimum and maximum calibration values for each sensor.

Table 13: Calibration Value Setting Ranges

Sensor	Detection target gas	Setting range lower limit	Setting range upper limit
NCR-6309	Methane (CH ₄) Propane (C ₃ H ₈)	1% LEL	75% LEL
ESR-X13P	Oxygen (O ₂)	0.0%	18.0%
ESR-A13i/ESR-A1DP	Hydrogen sulfide (H ₂ S)	0.5 ppm	200.0 ppm
ESR-A13P/ ESR-A1DP/ ESR-A1CP	Carbon monoxide (CO)	12 ppm	2,000 ppm
ESS-03DH	Sulfur dioxide (SO ₂)	0.00 ppm	99.90 ppm
ESS-03DH	Nitrogen dioxide (NO ₂)	0.00 ppm	20.00 ppm
ESS-03DH	Hydrogen cyanide (HCN)	0.3 ppm	15.0 ppm
ESS-B332	Ammonia (NH ₃)	0.0 ppm	400.0 ppm
ESS-B335	Chlorine (Cl ₂)	0.00 ppm	10.00 ppm
ESS-03DH	Phosphine (PH ₃)	0.00 ppm	20.00 ppm
DES-3311-2	Isobutane (HC (i-C ₄ H ₁₀))	0% LEL	30.0 vol%
DES-3311-3	Methane (CH ₄)	0% LEL	100.0 vol%
DES-3311-1	Carbon dioxide (CO ₂ , vol%)	0.00 vol%	10.00 vol%
DES-3311-4	Carbon dioxide (CO ₂ , ppm)	0 ppm	10,000 ppm
PID-001A	Volatile organic compounds (VOC, 10.6 eV, 40 ppm)	0 ppb	40,000 ppb
PID-002A	Volatile organic compounds (VOC, 10.6 eV, 4000 ppm)	0.0 ppm	4,000 ppm
SHS-8661	Isobutane (HC (i-C ₄ H ₁₀))	0 ppm	2,000 ppm
SHS-8661	Methane (CH ₄)	0 ppm	5,000 ppm
TE-7561	Methane (CH ₄)	0 vol%	100 vol%

1. Turn the instrument off if it is on.
2. Press and hold ▲ AIR and SHIFT (PANIC). Press POWER/ENTER then release all buttons after the beep. The MODE SELECT screen appears with the cursor next to **USER MODE**.

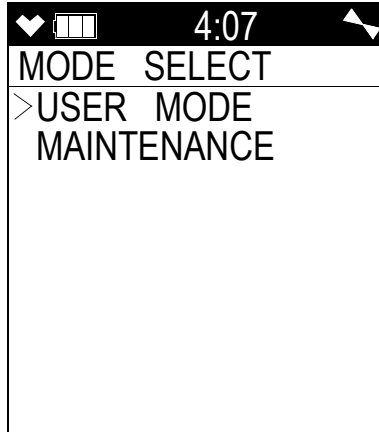

3. The User Mode menu displays with the cursor next to **BUMP TEST**.

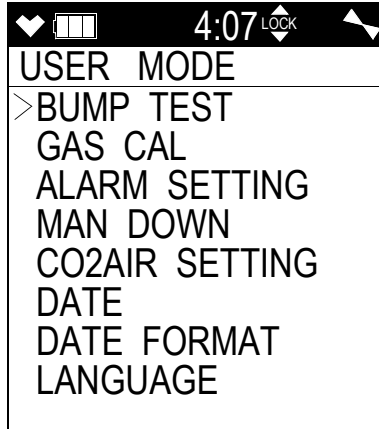

4. Press SHIFT ▼ (PANIC) to scroll to the **GAS CAL** menu item.
5. Press POWER/ENTER. The **GAS CAL** menu displays with the cursor next to **AIR CAL**.

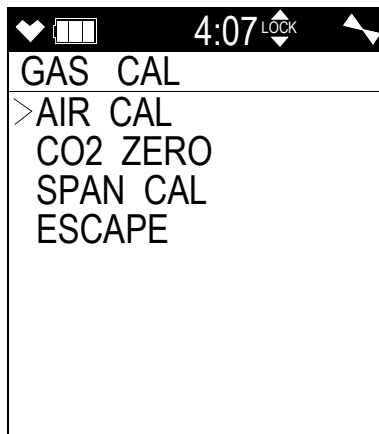

6. Press SHIFT ▼ (PANIC) to scroll to the **SPAN CAL** menu item.

7. Press POWER/ENTER. The **SPAN CAL** menu displays with the cursor next to **CALIBRATION**.

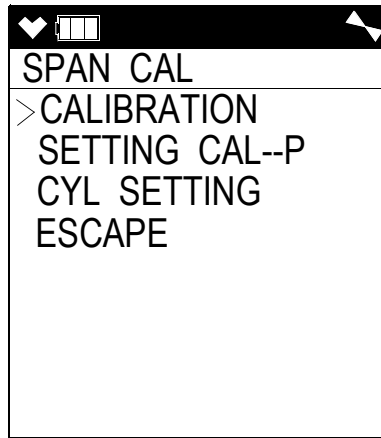

8. Press the ▲ AIR and SHIFT ▼ (PANIC) buttons to put the cursor next to **SETTING CAL--P**.
9. Press POWER/ENTER to display the **SETTING CAL--P** menu.

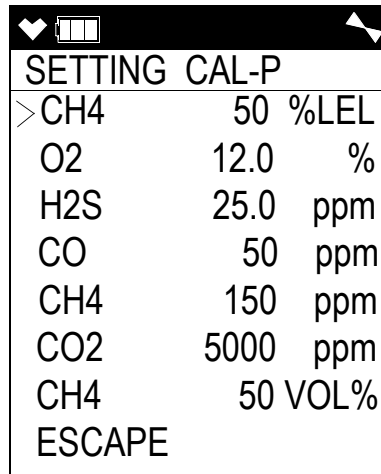

10. Press the ▲ AIR and SHIFT ▼ (PANIC) buttons to scroll to the desired calibration value.
11. Press and release the POWER/ENTER button. The value begins to flash.
12. Use the ▲ AIR and SHIFT ▼ (PANIC) buttons to adjust the calibration gas setting to the desired value.
13. Press and release the POWER/ENTER button to save the change. The calibration gas value stops flashing.

14. When you are done adjusting the calibration gas values, move the cursor to **ESCAPE**.

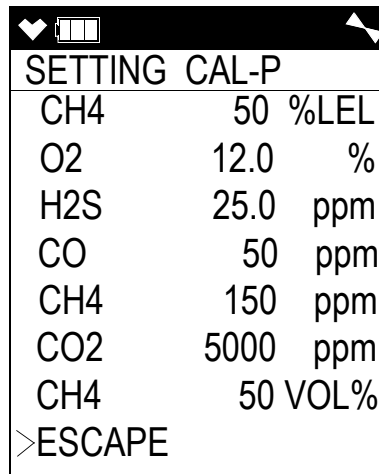

SETTING CAL-P		
CH4	50	%LEL
O2	12.0	%
H2S	25.0	ppm
CO	50	ppm
CH4	150	ppm
CO2	5000	ppm
CH4	50	VOL%
>ESCAPE		

15. Press and release the POWER/ENTER button. The instrument returns to the **SPAN CAL** menu.

Setting Cylinder Names (CYL SETTING)

The **CYL SETTING** parameter is used to assign cylinder names (**Cylinder A-G**) to each active channel.

By default, the standard four-gas channels are assigned to **Cylinder A**, the first smart sensor is assigned to **Cylinder B**, the second smart sensor is assigned to **Cylinder C**, H₂ is assigned to **Cylinder D**, and the TC %volume sensor is assigned to **Cylinder G**.

1. Turn the instrument off if it is on.
2. Press and hold ▲ AIR and SHIFT ▼ (PANIC). Press POWER/ENTER then release all buttons after the beep. The MODE SELECT screen appears with the cursor next to **USER MODE**.

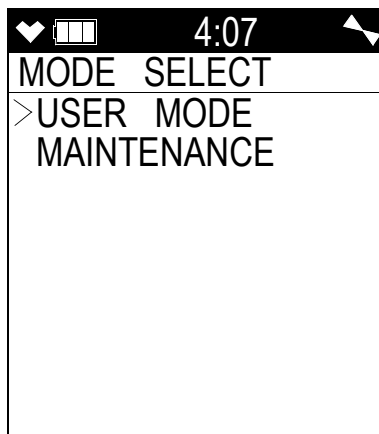

MODE SELECT	
>	USER MODE
	MAINTENANCE

3. Press POWER/ENTER to enter User Mode. The User Mode menu displays with the cursor next to **BUMP TEST**.

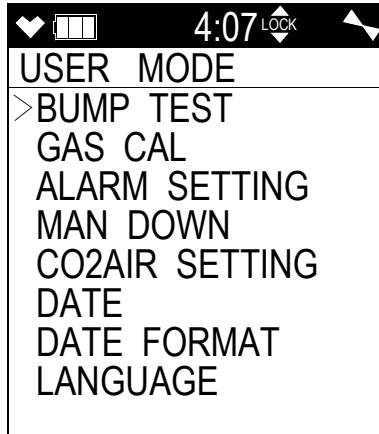

4. Press SHIFT ▼ (PANIC) to scroll to the **GAS CAL** menu item.
5. Press POWER/ENTER. The **GAS CAL** menu displays with the cursor next to **AIR CAL**.

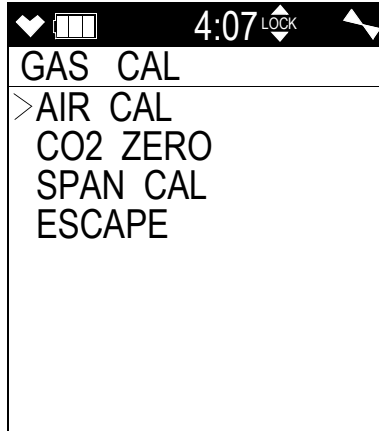

6. Press SHIFT ▼ (PANIC) to scroll to the **SPAN CAL** menu item.
7. Press POWER/ENTER. The **SPAN CAL** menu displays with the cursor next to **CALIBRATION**.

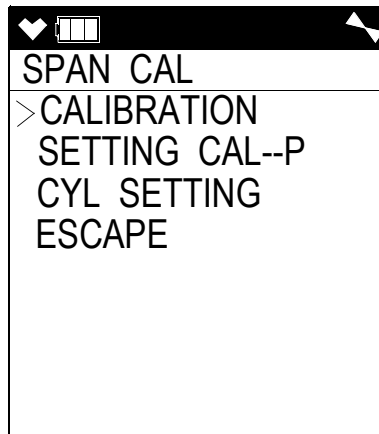

8. Press ▲ AIR and SHIFT ▼ (PANIC) to scroll to **CYL SETTING**.

9. Press POWER/ENTER. The list of active channels and their cylinder assignments appear.

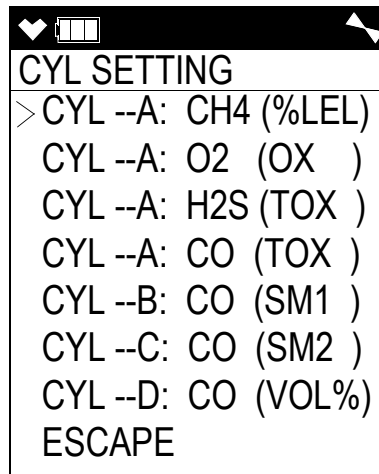

10. Press ▲ AIR or SHIFT ▼ (PANIC) to scroll to the channel that needs cylinder reassignment.
11. Press POWER/ENTER to select the channel. The cylinder name begins flashing.
12. Press ▲ AIR or SHIFT ▼ (PANIC) to change the cylinder name. Options range from Cylinder A to G.

NOTE: If you have a 5-gas cylinder, make sure that the smart sensor included in that 5-gas cylinder is assigned to the same cylinder as the 4-gas sensors.

13. Press POWER/ENTER to save the desired cylinder name.
14. Repeat Step 10 through Step 13 for any other channels that need cylinder reassignment.
15. To return to the **SPAN CAL** menu, press DISP.

Changing the Alarm Settings

The **ALARM SETTINGS** menu item has a sub menu with 6 menu items:

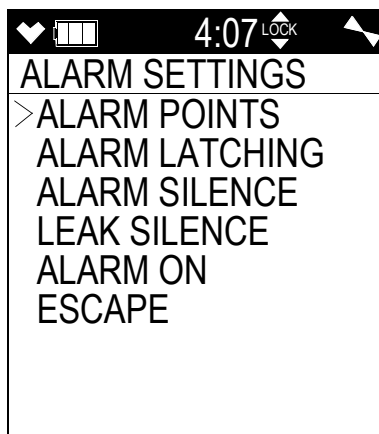

To enter the **ALARM SETTINGS** menu:

1. While in User Mode, press SHIFT ▼ (PANIC) to scroll to **ALARM SETTINGS**.

2. Press POWER/ENTER. The **ALARM SETTINGS** menu appears.

Changing the Alarm Setpoints (ALARM POINTS)

The **ALARM POINTS** menu is used to view and change the alarm setpoints of all active channels.

Table 14: Alarm Point Ranges

Gas / Sensor		Lowest Alarm Point	Highest Alarm Point
Methane (CH ₄) Propane (C ₃ H ₈)	NCR-6309	1% LEL	60% LEL
Oxygen (O ₂)	ESR-X13P	0.0%	25.0%
Hydrogen Sulfide (H ₂ S)	ESR-A13i/ ESR-A1DP	0.5 ppm	200.0 ppm
Carbon Monoxide (CO)	ESR-A13P/ ESR-A1DP/ ESR-A1CP	12 ppm	2,000 ppm
Sulfur Dioxide (SO ₂)	ESS-03DH	0.00 ppm	99.90 ppm
Nitrogen Dioxide (NO ₂)	ESS-03DH	0.00 ppm	20.00 ppm
Hydrogen Cyanide (HCN)	ESS-03DH	0.0 ppm	15.0 ppm
Ammonia (NH ₃)	ESS-B332	0.0 ppm	400.0 ppm
Chlorine (Cl ₂)	ESS-B335	0.00 ppm	10.00 ppm
Phosphine (PH ₃)	ESS-03DH	0.00 ppm	20.00 ppm
Isobutane (HC (i-C ₄ H ₁₀))	DES-3311-2	0% LEL	30.0 VOL%
Methane (CH ₄)	DES-3311-3	0% LEL	100.0 VOL%
Carbon Dioxide (CO ₂ , VOL%)	DES-3311-1	0.00 VOL%	10.00 VOL%
Carbon Dioxide (CO ₂ , ppm)	DES-3311-4	0 ppm	10,000 ppm
Volatile Organic Compounds (VOCs), (10.6 eV, 40 ppm)	PID-001A	0 ppb	40,000 ppb
VOCs (10.6 eV, 40,000 ppm)	PID-002A	0.0 ppm	4,000 ppm
VOCs (10.0 eV, 100 ppm)	PID-003	0.00 ppm	100.0 ppm
VOCs (11.7 eV, 1000 ppm)	PID-004	0.0 ppm	1,000 ppm

To change the current alarm setpoints:

1. While in User Mode, press SHIFT ▼ (PANIC) to scroll to **ALARM SETTINGS**.

2. Press POWER/ENTER. The **ALARM SETTINGS** menu appears.
3. While in the **ALARM SETTINGS** menu, press SHIFT ▼ (PANIC) to scroll to **ALARM POINTS**.

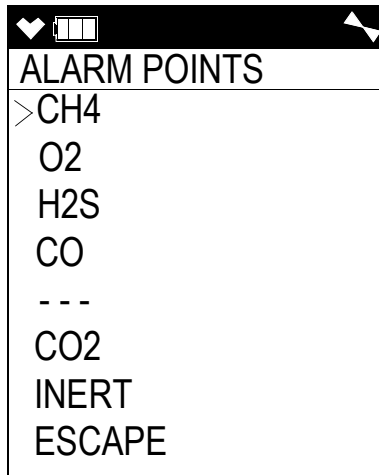

4. Press POWER/ENTER button. The **ALARM POINTS** menu displays each channel's target gas.
The " - - " indicates an unused channel that can only be adjusted when a sensor is detected.
5. Press ▲ AIR or SHIFT ▼ (PANIC) button to scroll through each gas.
6. Press POWER/ENTER when the cursor is next to the desired channel. The channel's alarm setpoints appear.
In the example below, the O₂ channel is displayed:

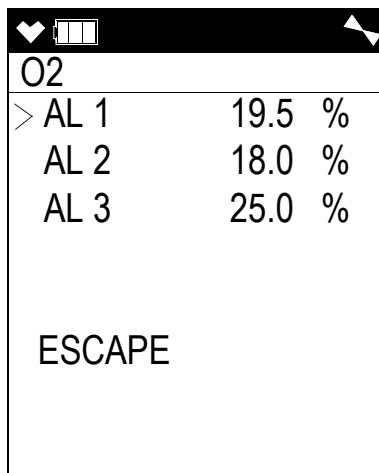

7. Press ▲ AIR or SHIFT ▼ (PANIC) to scroll through each alarm setpoint.
8. Press POWER/ENTER when the cursor is next to the desired setpoint. The desired alarm setpoint begins flashing.
9. Press ▲ AIR or SHIFT ▼ (PANIC) to increase or decrease the setpoint.

10. Press POWER/ENTER to confirm the setting.
To leave the setting unchanged and return to the **ALARM POINTS** menu, press DISP/LOCK.
11. To return to the **ALARM SETTINGS** menu, press SHIFT ▼ (PANIC) to scroll to **ESCAPE** and press POWER/ENTER.
12. See “Exiting User Mode (START MEASURE)” on page 118 to enter Measuring Mode.

Setting Alarms to Latching or Self-Resetting (LATCHING)

LATCHING (factory setting): The GX-6100 remains in alarm until the alarm condition passes *and* POWER/ENTER is pressed.

SELF-RESET: The GX-6100 automatically resets an alarm when the alarm condition passes.

1. While in User Mode, press SHIFT ▼ (PANIC) to scroll to **ALARM SETTINGS**.
2. Press POWER/ENTER. The **ALARM SETTINGS** menu appears.
3. While in the **ALARM SETTINGS** menu, press SHIFT ▼ (PANIC) to scroll to **ALARM LATCHING**.
4. Press POWER/ENTER. The **ALARM LATCHING** menu appears with the current setting flashing.



5. Press ▲ AIR or SHIFT ▼ (PANIC) to display the desired setting.
6. Press POWER/ENTER to save the setting and return to the **ALARM SETTINGS** menu.
7. See “Exiting User Mode (START MEASURE)” on page 118 to enter Measuring Mode.

Turning the Alarm Silence Function On/Off (ALARM SILENCE)

ON (factory setting): The buzzer can be silenced during an alarm condition by pressing POWER/ENTER or AIR.

OFF: The buzzer cannot be silenced during an alarm condition by pressing POWER/ENTER or AIR. The alarm condition must first pass before the buzzer can be silenced.

1. While in User Mode, press SHIFT ▼ (PANIC) to scroll to **ALARM SETTINGS**.
2. Press POWER/ENTER. The **ALARM SETTINGS** menu appears.
3. While in the **ALARM SETTINGS** menu, press SHIFT ▼ (PANIC) to scroll to **ALARM SILENCE**.
4. Press POWER/ENTER. The **ALARM SILENCE** menu appears with the current setting flashing.

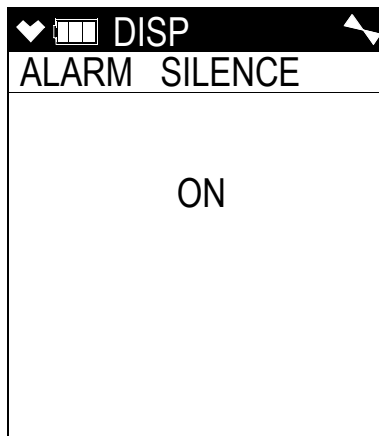

5. Press ▲ AIR or SHIFT ▼ (PANIC) to display the desired setting.
6. Press POWER/ENTER to save the setting and return to the **ALARM SETTINGS** menu.
7. See “Exiting User Mode (START MEASURE)” on page 118 to enter Measuring Mode.

Turning the Leak Mode Silence Function On/Off (LEAK SILENCE)

NOTE: **LEAK SILENCE** only applies to Leak Check Mode and does not affect buzzer operation in Normal or Bar Hole Mode.

ON (factory setting): While in Leak Check Mode, the buzzer can be silenced during an alarm condition by pressing POWER/ENTER or AIR. When this settings is enabled, the letters **NO ALM** will start flashing on the screen while the instrument is in Leak Check Mode.

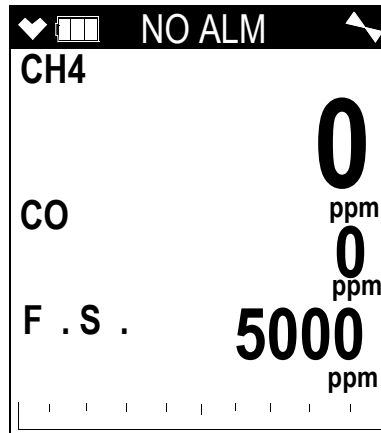

OFF: While in Leak Check Mode, the buzzer cannot be silenced during an alarm condition. The alarm condition must first pass before the buzzer can be silenced by pressing POWER/ENTER.

1. While in User Mode, press SHIFT ▼ (PANIC) to scroll to **ALARM SETTINGS**.
2. Press POWER/ENTER. The **ALARM SETTINGS** menu appears.
3. While in the **ALARM SETTINGS** menu, press SHIFT ▼ (PANIC) to scroll to **LEAK SILENCE**.
4. Press POWER/ENTER. The **LEAK SILENCE** menu appears with the current setting flashing.

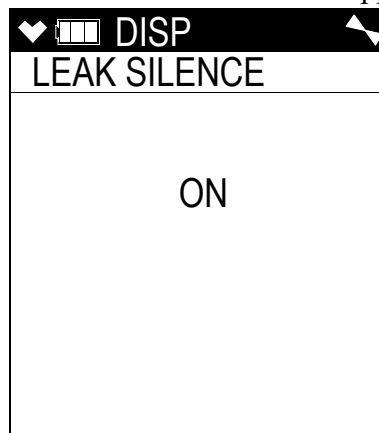

5. Press ▲ AIR or SHIFT ▼ (PANIC) to display the desired setting.
6. Press POWER/ENTER to save the setting and return to the **ALARM SETTINGS** menu.
7. See “Exiting User Mode (START MEASURE)” on page 118 to enter Measuring Mode.

Turning the Alarm Function On/Off (ALARM ON)

ON (factory setting): The instrument's gas alarms operate as described in "Measuring Mode, Alarms" on page 46.

OFF: The gas alarms will not operate during alarm conditions. **NO ALM** will be displayed at the top of the LCD.

NOTE: Fault alarms will always operate normally, regardless of the **ALARM ON** setting.

1. While in User Mode, press SHIFT ▼ (PANIC) to scroll to **ALARM SETTINGS**.
2. Press POWER/ENTER. The **ALARM SETTINGS** menu appears.
3. While in the **ALARM SETTINGS** menu, press SHIFT ▼ (PANIC) to scroll to **ALARM ON**.
4. Press POWER/ENTER. The **ALARM ON** menu appears with the current setting flashing.

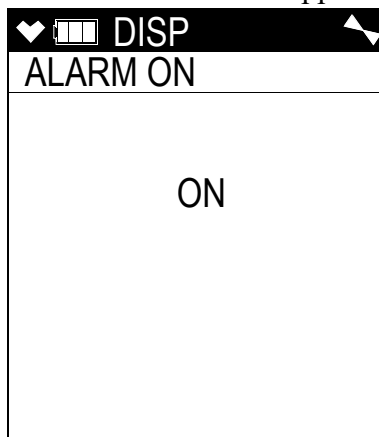

5. Press ▲ AIR or SHIFT ▼ (PANIC) to display the desired setting.
6. Press POWER/ENTER to save the setting and return to the **ALARM SETTINGS** menu.
7. See "Exiting User Mode (START MEASURE)" on page 118 to enter Measuring Mode.

Returning to the User Mode Menu (ESCAPE)

1. From the **ALARM SETTINGS** menu, press ▲ AIR or SHIFT ▼ (PANIC) to move the cursor next to **ESCAPE**.
2. Press and release POWER/ENTER. The instrument will return to the User Mode main menu.

Changing the Man Down Settings (MAN DOWN)

The **MAN DOWN** menu item has a sub menu with 4 menu items:

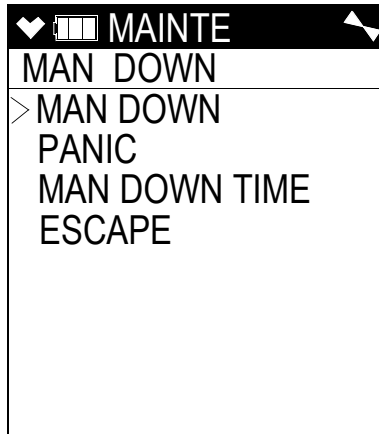

To enter the Man Down menu:

1. While in User Mode, press **SHIFT ▼** (PANIC) to scroll to **MAN DOWN**.
2. Press **POWER/ENTER**. The **MAN DOWN** menu appears.

Turning the Man Down Alarm On/Off

ON: The Man Down alarm can be triggered if the instrument detects no motion for the period of time defined in **MAN DOWN TIME** below.

OFF (factory setting): The Man Down alarm cannot be triggered.

See “Measuring Mode, Alarms” on page 46 for a description of the Man Down alarm.

1. From the **MAN DOWN MENU** screen, place the cursor next to **MAN DOWN**.
2. Press and release **POWER/ENTER**. The Man Down screen appears.
3. Use **▲ AIR** or **SHIFT ▼** (PANIC) to display the desired setting.
4. Press and release **POWER/ENTER** to save the setting and return to the **MAN DOWN MENU** screen.

Changing the PANIC Setting

ON (factory setting): A Panic Alarm can be manually initiated by holding down the **SHIFT ▼** (PANIC) button.

OFF: A Panic Alarm cannot be manually initiated.

See “Measuring Mode, Alarms” on page 46 for a description of the Panic Alarm.

1. From the **MAN DOWN** menu screen, place the cursor next to **PANIC**.
2. Press and release **POWER/ENTER**. The Panic screen appears.
3. Use **▲ AIR** or **SHIFT ▼** (PANIC) to display the desired setting.

4. Press and release POWER/ENTER to save the setting and return to the **MAN DOWN MENU** screen.

Setting the Man Down Warning/Alarm Times (MAN DOWN TIME)

The Man Down Warning/Alarm times are the amount of time that has to pass between a Man Down detection and each warning/alarm. Each time can be set in 1 second increments. The range for each Man Down setting is 10 - 120 seconds.

When setting the Man Down Warning/Alarm times, keep in mind that **ALARM TIME** \geq **WARNING 2 TIME** \geq **WARNING 1 TIME**.

Warning/Alarm	Factory Setting
WARNING 1 TIME	60 seconds
WARNING 2 TIME	75 seconds
ALARM TIME	90 seconds

1. While in the **MAN DOWN** menu, use AIR to place the cursor next to **MAN DOWN TIME**.
2. Press POWER/ENTER. The current **WARNING 1 TIME** setting flashes.

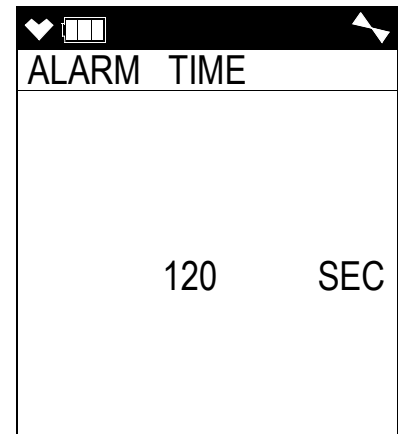
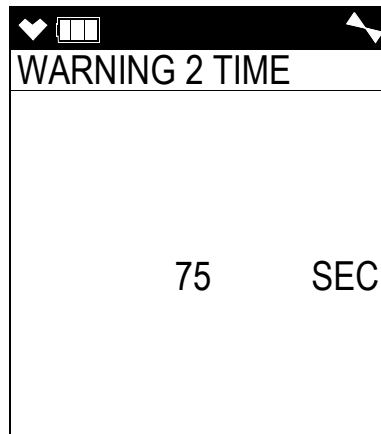
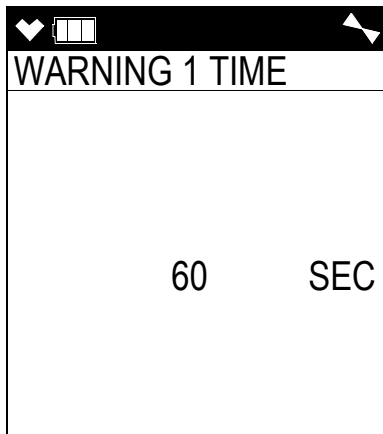

3. Press AIR or SHIFT ▼ (PANIC) to adjust the setting.
4. Press and release POWER/ENTER to save the setting.
5. Repeat Step 3 through Step 4 for the **WARNING 2 TIME** and **ALARM TIME** settings.
6. The instrument returns to the **MAN DOWN** menu.
7. See “Returning to the User Mode Menu (ESCAPE)” on page 113 to return to User Mode.

Returning to the User Mode Menu (ESCAPE)

1. From the **MAN DOWN MENU** screen, place the cursor next to **ESCAPE**.
2. Press and release POWER/ENTER. The instrument will return to the main menu.

Adjusting the CO₂ Fresh Air Setting

NOTE: This menu item only appears if a CO₂ sensor is installed.

ON: CO₂ channel is set to 400 ppm (0.04% VOL.) during a demand zero, auto zero, or **AIR CAL.**

OFF (factory setting): CO₂ channel is not adjusted during a demand zero, auto zero, or **AIR CAL.**

To change the CO₂ Fresh Air setting:

1. While in User Mode, press SHIFT ▼ (PANIC) to scroll to **CO2AIR SETTING.**

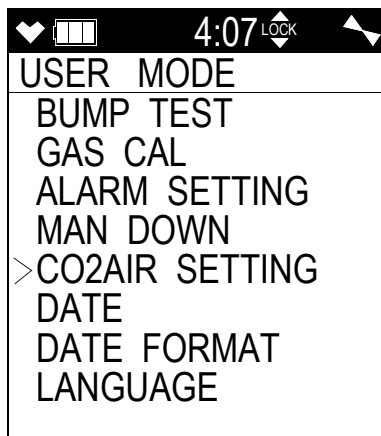

2. Press POWER/ENTER. The current setting flashes.
3. Use AIR to display the desired setting.
4. Press POWER/ENTER to save the setting and return to User Mode.
To leave the setting unchanged and return to User Mode, press DISP/LOCK.
5. See “Exiting User Mode (START MEASURE)” on page 118 to return to Measuring Mode.

Setting the Date and Time

NOTE: The example screen shown below assumes a **DATE FORMAT** setting of **MM/DD/YYYY** (factory setting). If your instrument’s **DATE FORMAT** is set to another format, your screen will appear different.

To change the date and/or time:

1. While in User Mode, press SHIFT ▼ (PANIC) to scroll to **DATE.**

2. Press POWER/ENTER. The date and time will be displayed with the year flashing.

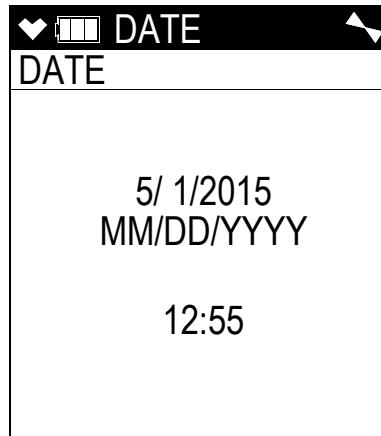

3. Press ▲ AIR or SHIFT ▼ (PANIC) to display the desired year.
4. Press POWER/ENTER to save the setting. The month setting flashes.
5. Repeat Step 3 and Step 4 to enter the month, day, hours, and minutes settings. To return to a previous value, press DISP/LOCK.
6. The instrument returns to User Mode after the seconds setting is saved.

Changing the Date Format

The date can be displayed in three ways: **MM/DD/YYYY** (factory setting), **DD/MM/YYYY**, or **YYYY/MM/DD**.

To change the date format:

1. While in User Mode, press SHIFT ▼ (PANIC) to scroll to **DATE FORMAT**.
2. Press POWER/ENTER. The **DATE FORMAT** screen appears with the current setting flashing.
3. Press ▲ AIR or SHIFT ▼ (PANIC) to display the desired setting.
4. Press POWER/ENTER to save the setting and return to the main menu.

Changing the Language Setting

The **LANGUAGE** menu item changes the language for the GX-6100's user interface. The available choices are **English** (factory setting), **Japanese**, **Italian**, **Spanish**, **German**, **French**, **Portuguese**, **Russian**, **Korean**, **Chinese (SC)**, **Chinese (TC)**, **Vietnamese**, **Polish**, **Turkish**, **Slovak**, and **Czech**.



To change the instrument's user interface language:

1. While in User Mode, press **SHIFT ▼** (PANIC) to scroll to **LANGUAGE**.
2. Press **POWER/ENTER**. The **LANGUAGE** screen appears with the cursor in front of the current language.
3. Press **▲ AIR** or **SHIFT ▼** (PANIC) to scroll to the desired language.
If you do not wish to select a new language, press and release **DISP/LOCK**. The unit will return to the main menu.
4. Press **POWER/ENTER** to save the setting and return to the main menu. The GX-6100's user interface will now be in the newly selected language.
5. If you select a language other than English, a prompt will appear during startup that allows you to change the language back to English if desired.

Viewing the Version Numbers (VERSION)

The **VERSION** screen shows the version numbers for the main board, PID table, Bluetooth, and sensor board currently loaded in the instrument.

1. While in User Mode, press **SHIFT ▼ (PANIC)** to scroll to **VERSION**.
2. Press **POWER/ENTER**. The **MAIN VER** screen displays the ROM, checksum, and version number values for your unit.

Press the **SHIFT ▼ (PANIC)** button to display the **PID TABLE VER** screen, the **OPTION VER** screen, and the **SENS BOARD VER** screen as shown in the figure below.

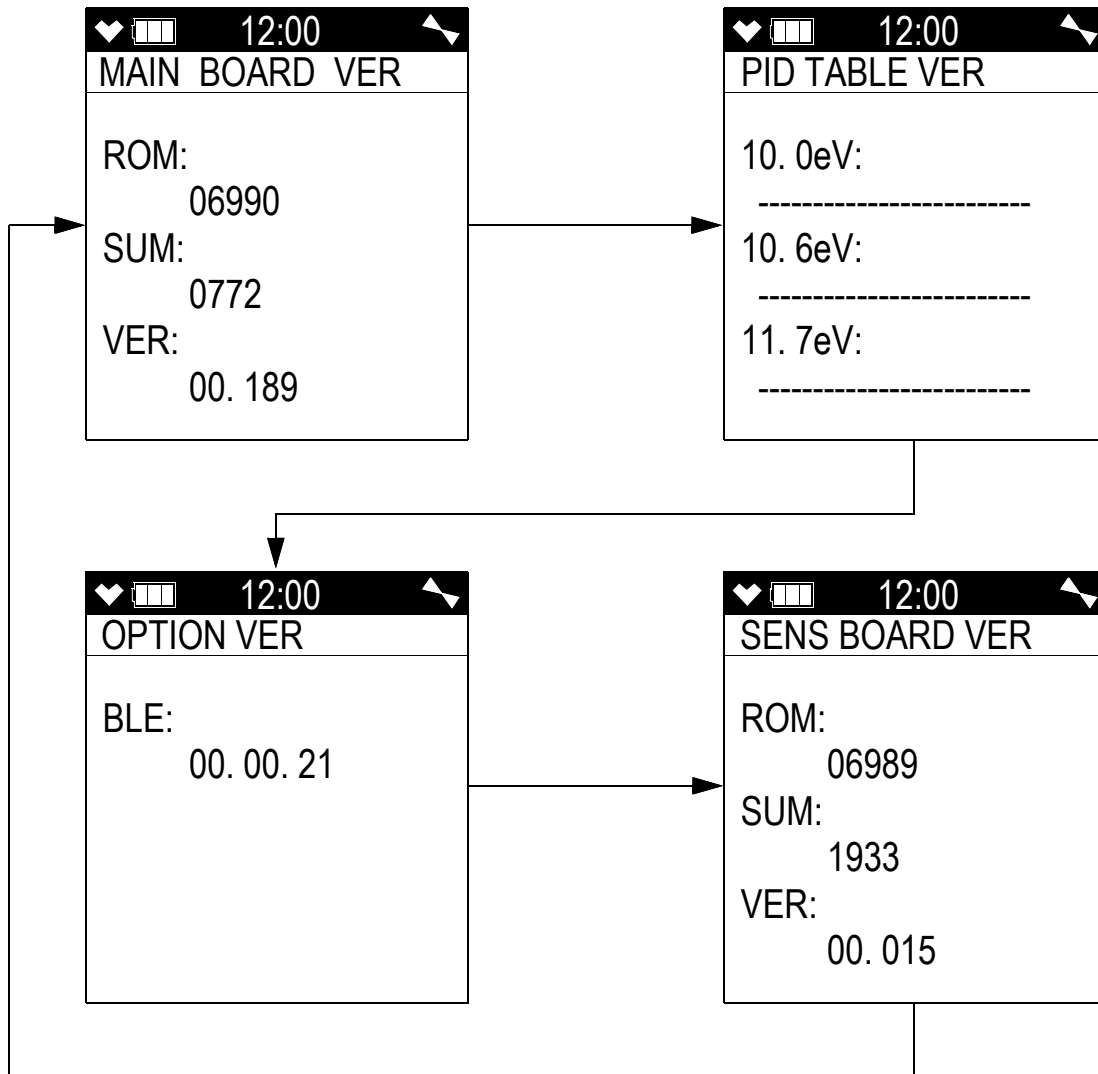

3. Press **POWER/ENTER** to return to the main menu.

Exiting User Mode (START MEASURE)

1. While in User Mode, press SHIFT ▼ (PANIC) to scroll to **START MEASURE**.
2. Press and release POWER/ENTER.
3. The unit will begin its start-up sequence.

Chapter 6: Maintenance

Overview

This chapter describes troubleshooting procedures for the GX-6100. It also includes procedures for replacing and recharging the batteries and replacing various consumable parts.

WARNING: *RKI Instruments, Inc. recommends that service, calibration, and repair of RKI Instruments be performed by personnel properly trained for this work. Replacing sensors and other parts with original equipment does not affect the intrinsic safety of the instrument.*

Troubleshooting

The troubleshooting table describes error messages, symptoms, probable causes, and recommended action for problems you may encounter with the GX-6100.

Table 15: Troubleshooting the GX-6100

Symptoms	Probable Causes	Recommended Action
<ul style="list-style-type: none">The LCD is blank.	<ul style="list-style-type: none">The unit may have been turned off.The alkaline batteries may need to be replaced or Li-ion battery pack may need to be recharged.	<ol style="list-style-type: none">To turn on the unit, press and briefly hold the POWER/ENTER button.If the unit does not turn on, replace the alkaline batteries or recharge the Li-ion battery pack.If the difficulties continue, contact RKI Instruments, Inc. for further instruction.
<ul style="list-style-type: none">The LCD shows abnormally high or low readings but other gas detection instruments do not.	<ul style="list-style-type: none">The H₂S scrubber disk or charcoal filter may need to be replaced.The GX-6100 may need to be recalibrated.The sensor for the affected channel(s) may need replacement.	<ol style="list-style-type: none">Replace the H₂S scrubber disk or charcoal filter.Recalibrate the unit.If the difficulties continue, replace the sensor for the affected channel(s) and calibrate the affected channel(s).If the difficulties continue, contact RKI Instruments, Inc. for further instruction.

Table 15: Troubleshooting the GX-6100

Symptoms	Probable Causes	Recommended Action
<ul style="list-style-type: none"> The unit indicates flow failure and does not recover when RESET is pressed and released. 	<ul style="list-style-type: none"> The probe tube is clogged. The hydrophobic filter disk in the probe is dirty. The sample hose has a kink or obstruction. The pump is malfunctioning. 	<ol style="list-style-type: none"> Inspect the probe tube for any obstructions. Inspect the hydrophobic filter disk in the probe and replace if necessary. Inspect the sample hose for kinks or obstructions and replace if necessary. If difficulties continue, contact RKI Instruments, Inc. for further instruction.
<ul style="list-style-type: none"> Span calibration or bump test fails. 	<ul style="list-style-type: none"> The span calibration values may not match the cylinder gas concentrations (span calibration only). The charcoal filter is saturated causing an elevated CO reading. The sample gas is not reaching the sensors because of a bad connection. The calibration cylinder may be out of gas or is outdated. The bump test gas time is not long enough. For PID sensors, the lamp may need to be cleaned. For PID sensors, the electrode stack may need to be replaced. The sensor for the affected channel(s) may need replacement. 	<ol style="list-style-type: none"> Check all calibration tubing for leaks or for any bad connections. Make sure the GX-6100 has been properly set up for calibration. Change the charcoal filter. Verify that the calibration cylinder contains an adequate supply of fresh test sample. Increase the bump test gas time using the GX-6100 Configuration Program described in <i>GX-6100 Configuration Program Operator's Manual</i>. Clean the PID sensor's lamp. Replace the PID sensor's electrode stack. If the fail condition continues, replace the sensor(s). If the difficulties continue, contact RKI Instruments, Inc. for further instruction.
<ul style="list-style-type: none"> Heart symbol at the top of the screen becomes steadily on or disappears 	<ul style="list-style-type: none"> A microprocessor error has occurred. 	<ul style="list-style-type: none"> Contact RKI Instruments, Inc. for further instruction.
<ul style="list-style-type: none"> Instrument does not go into low flow alarm when inlet is plugged. 	<ul style="list-style-type: none"> Sensor gasket is not seated properly. 	<ul style="list-style-type: none"> Turn the instrument off and remove the flow chamber. Ensure that the sensor gasket's flow fitting connections are facing up and that the gasket is secured under the gasket aligning tabs.

Replacing or Recharging the Batteries

WARNING: *To prevent ignition of a hazardous atmosphere, batteries must only be changed or charged in an area known to be nonhazardous.*

AVERTISSEMENT: *Pour éviter l'inflammation d'une atmosphère dangereuse, les batteries doivent uniquement être modifiés ou facturés dans une zone connue comme non dangereuse.*

Replace or recharge the batteries when the battery icon indicates that the unit is in low battery warning. When in low battery warning, the lowest battery level indication bar disappears and the battery icon will be flashing.

Replacing Alkaline Batteries

NOTE: Use Procell PC 1500 alkaline batteries or RKI Instruments, Inc. lithium-ion battery pack 49-1639 to maintain the CSA classification of the GX-6100. Use of other batteries will void the CSA classification and may void the warranty. Do not mix old/new or different types of batteries.

NOTE: Utiliser Procell 1500 piles alcalines ou RKI Instruments, Inc. pack batterie lithium-ion 49-1639 de maintenir la classification CSA de la GX-6100. L'utilisation d'autres piles annule la classification CSA et peut annuler la garantie. Ne mélangez pas les anciennes/nouvelles ou différents types de piles.

1. Turn off the GX-6100.

WARNING: *Do not remove the batteries while the GX-6100 is on.*

2. Turn the GX-6100 over so that the flow chamber and battery cover are facing up and the LCD is facing down.

3. Push the battery cover latch toward the bottom of the instrument.

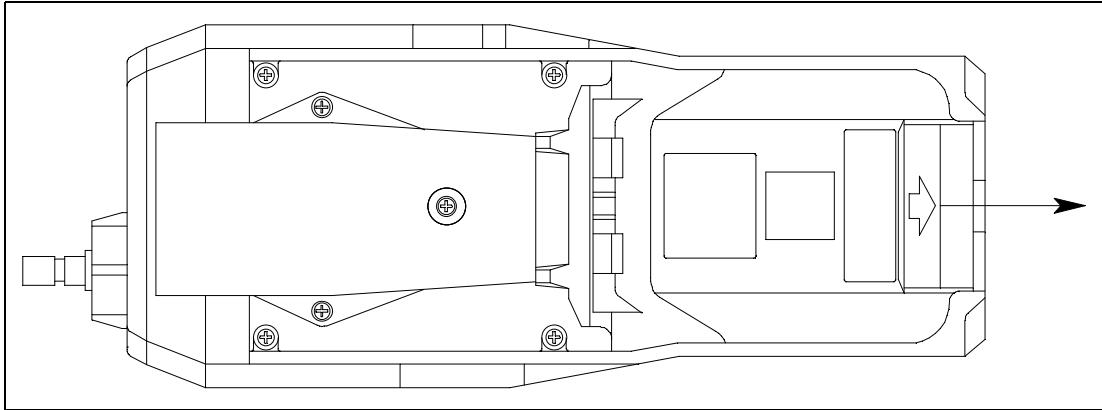

Figure 13: Releasing Battery Cover Latch

4. Grasp the end of the battery cover that's closest to the bottom of the instrument and lift it up.

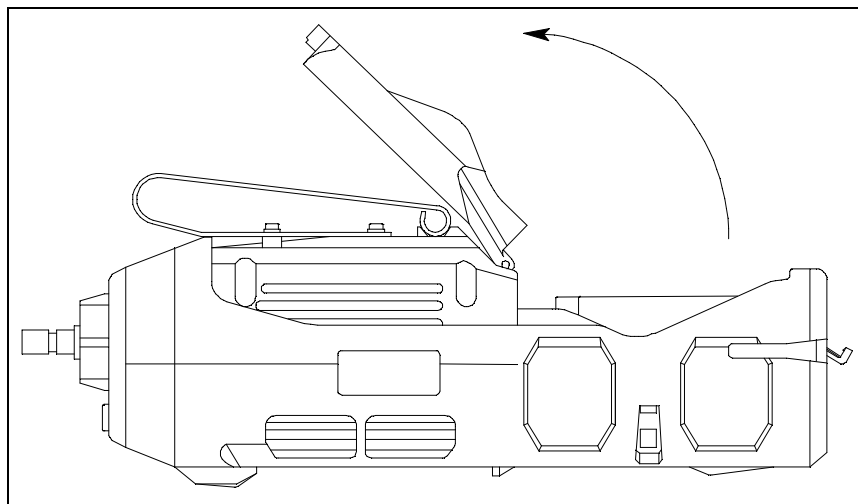

Figure 14: Opening Battery Cover

5. Carefully remove the old alkaline batteries. Verify that the battery compartment and electrical contacts are clean.
6. Carefully install the new AA alkaline batteries according to the battery diagram inside the battery compartment.

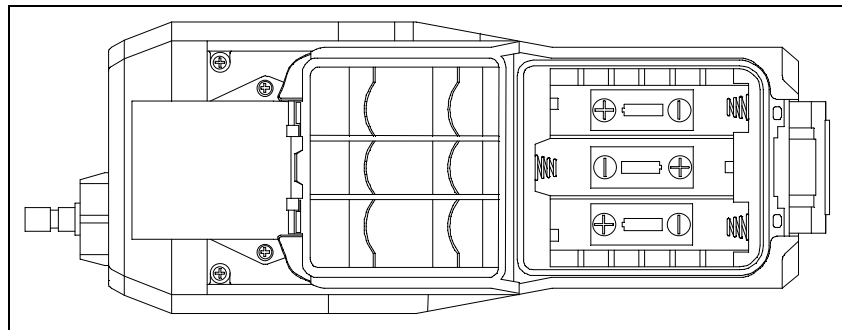

Figure 15: Installing the Alkaline Batteries

7. Close the battery cover and secure the battery cover latch by pushing it up and toward the top of the instrument.

Replacing the Lithium Ion Battery Pack

NOTE: Use Procell PC 1500 alkaline batteries or RKI Instruments, Inc. lithium-ion battery pack 49-1639 to maintain the CSA classification of the GX-6100. Use of other batteries will void the CSA classification and may void the warranty. Do not mix old/new or different types of batteries.

NOTE: Utiliser Procell 1500 piles alcalines ou RKI Instruments, Inc. pack batterie lithium-ion 49-1639 de maintenir la classification CSA de la GX-6100. L'utilisation d'autres piles annule la classification CSA et peut annuler la garantie. Ne mélangez pas les anciennes/nouvelles ou différents types de piles.

1. Turn off the GX-6100.

WARNING: *Do not remove the battery pack while the GX-6100 is on.*

2. Remove the rubber boot, if installed.
3. Turn the GX-6100 over so that the flow chamber and battery cover are facing up and the LCD is facing down.
4. The battery pack release latch is located on the bottom of the instrument and is closer to the front of the case than the back.
5. Slide the battery pack release latch to the right with one hand and lift up on the battery pack with the other.

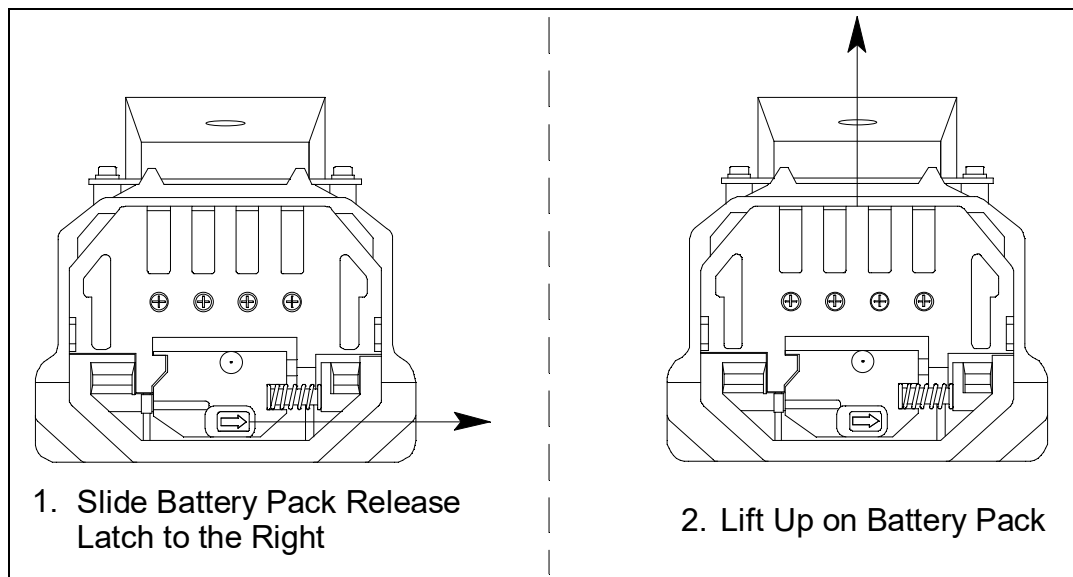

Figure 16: Releasing the Battery Pack

6. Slide the battery pack away from the instrument.

7. Install a new battery pack. If the battery pack release latch moved back into its closed position, slide the latch to the right with one hand and insert a new battery pack with the other.

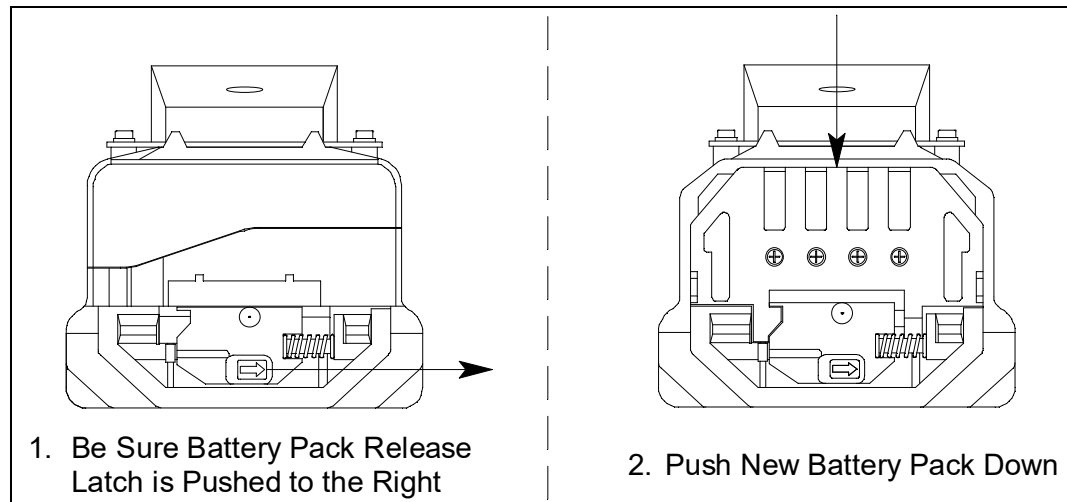

Figure 17: Installing the Battery Pack

8. Release the battery pack release latch. If it does not return to its closed position automatically, push the latch to the left and toward the instrument until it is flush with the bottom of the instrument.
9. Reinstall the rubber boot, if desired.

Recharging the Lithium Ion Battery Pack in the Instrument

CAUTION: *To be used only with lithium ion battery pack p/n 49-1639. Charge only with RKI charger model BC-6000A, p/n 49-2185, or RKI charger model BC-6000ADC, p/n 49-2186. Use of other rechargeable batteries or chargers or charging of other rechargeable batteries in the GX-6100 will void the warranty.*

PRUDENCE: *Pour être utilisé uniquement avec une batterie au lithium-ion p/n 49-1639. Charge uniquement en fonction du modèle de chargeur RKI BC-6000A, p/n 49-2185, ou modèle de chargeur BC-6000ADC RKI, p/n 49-2186. L'utilisation d'autres piles ou chargeurs rechargeables ou charger d'autres batteries rechargeables dans le GX-6100 annule la garantie.*

The charger can be mounted to the wall using DIN rail, if desired. See page 25 for instructions.

1. Make sure the GX-6100 is off.
2. Confirm that the power adapter's DC output cord is plugged into the charger.

3. If using an AC powered charging station, plug the AC adapter into an electrical outlet.

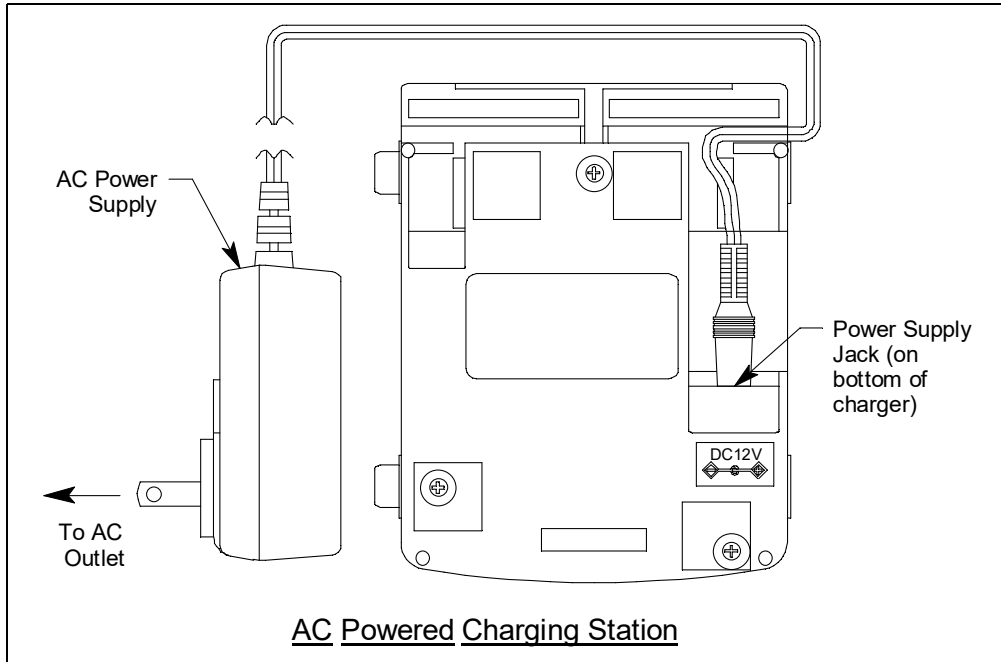

Figure 18: Connecting the Charging Station's AC Adapter

If using a DC powered charging station, plug the 12 VDC vehicle plug adapter into a vehicle's 12 VDC power socket.

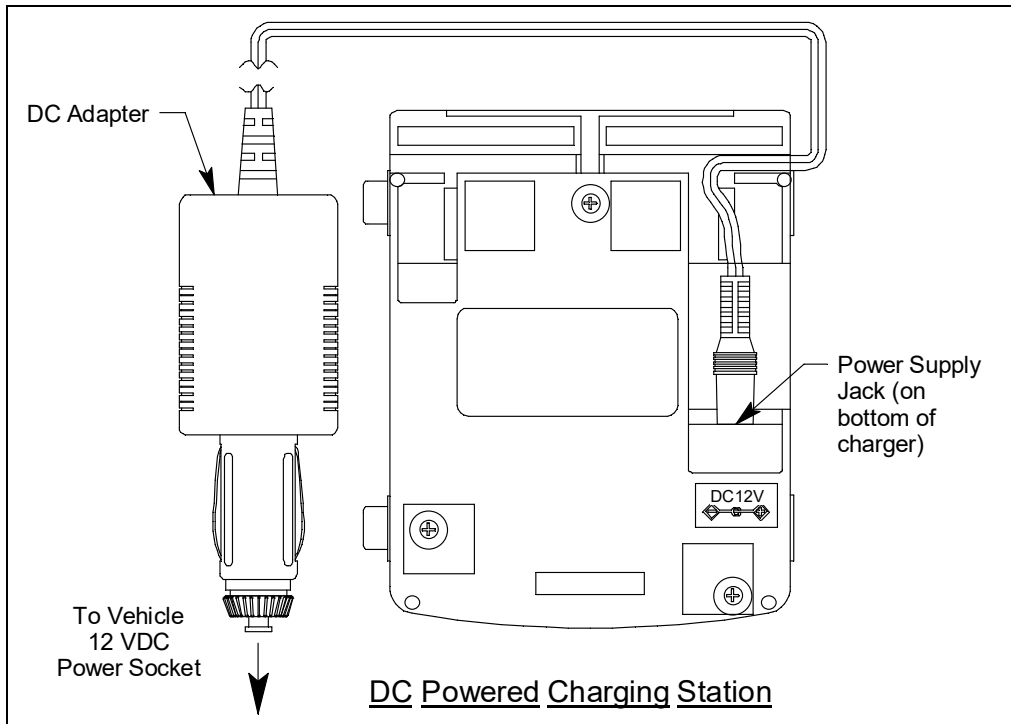

Figure 19: Connecting the Charging Station's DC Adapter

The construction of the charging stations allows them to be chained together but a separate adapter must be used for each charging station. One adapter will not operate more than one charging station.

- Place the GX-6100 into the battery charging station as shown in Figure 20 below so that the metal contacts on the back of the unit come into contact with the metal contacts on the back of the holder in the charging station. When proper contact has been made, the red LED on the charging station will turn on.

If you are using a DC adapter, the charging station comes with a Velcro strap and washer assembly to secure the GX-6100. Ensure that the washer is installed over the GX-6100's inlet fitting, that both ends of the Velcro strap are attached to the charging station, and that the assembly is securing the instrument.

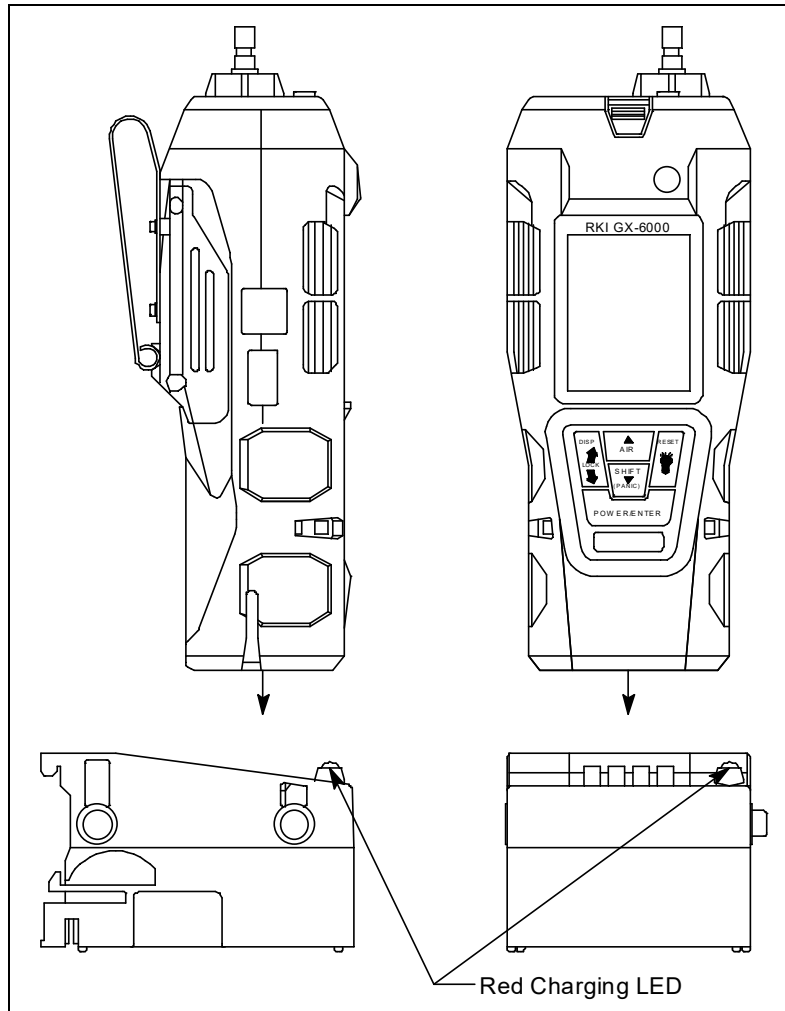

Figure 20: Putting the GX-6100 into the Charging Station

- When a full charge has been reached, approximately 6 hours, the red LED on the charging station will turn off. Remove the GX-6100 from the charging station and unplug the charging station's power cord from the AC outlet.

Recharging the Lithium Ion Battery Pack Out of the Instrument

The lithium ion battery pack may be charged using the charging station while it is out of the GX-6100. This is useful if spare battery packs are kept in case the pack in the GX-6100 needs to be charged, but the unit must be used immediately. In this case, a spare charged pack can be installed in the GX-6100 and the dead pack charged in the charging station.

The charger can be mounted to the wall using DIN rail, if desired. See page 25 for instructions.

1. Make sure the GX-6100 is off.
2. Confirm that the power adapter's DC output cord is plugged into the charger.
3. If using an AC powered charging station, plug the AC adapter into an electrical outlet.

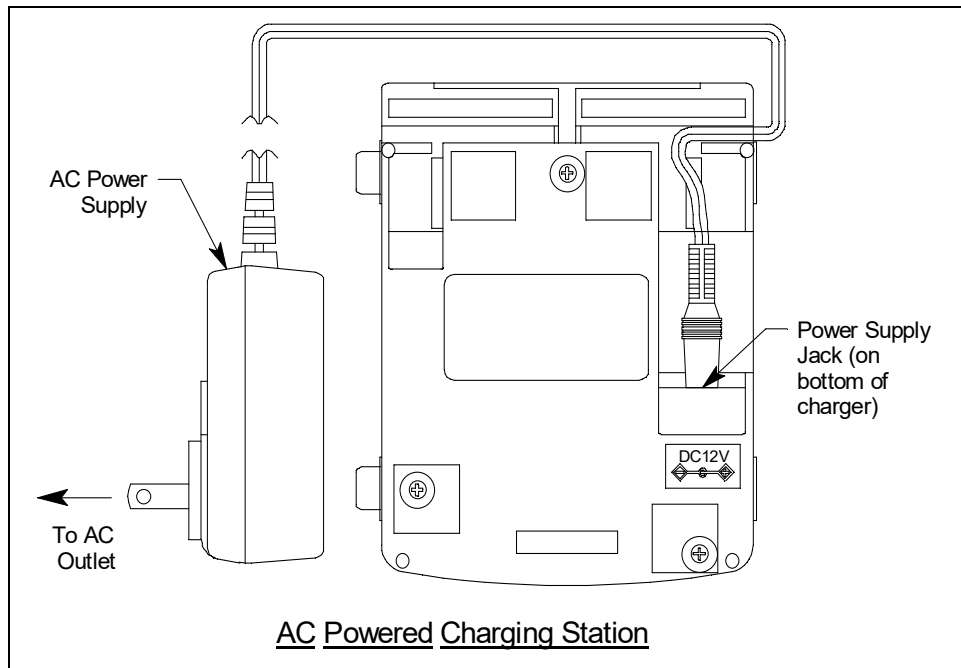

Figure 21: Connecting the Charging Station's AC Adapter

If using a DC powered charging station, plug the 12 VDC vehicle plug adapter into a vehicle's 12 VDC power socket.

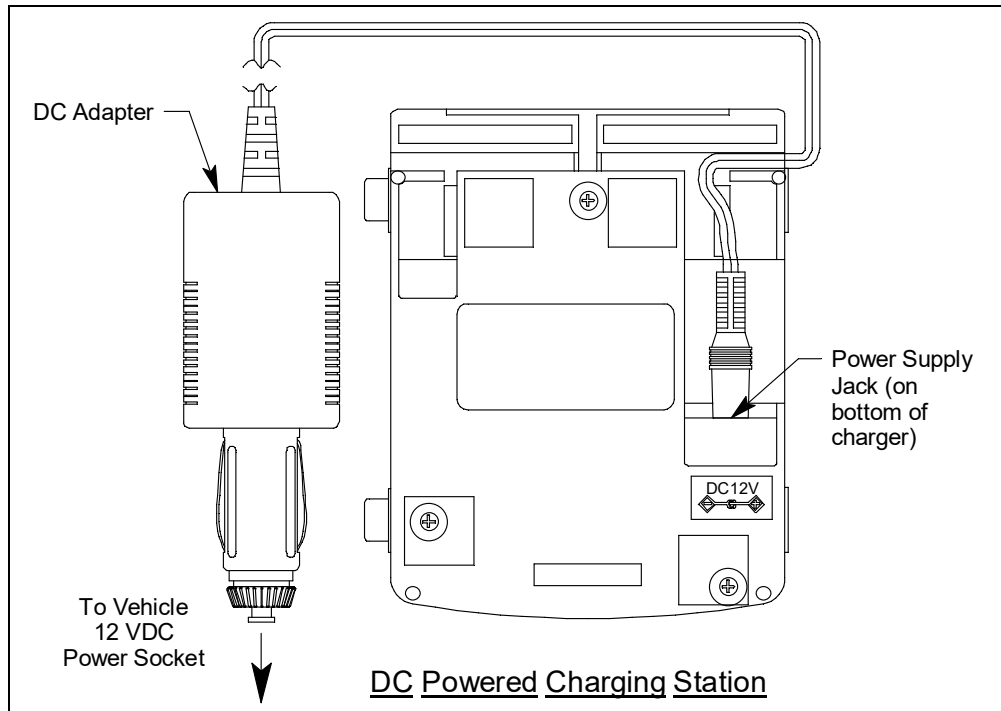

Figure 22: Connecting the Charging Station's DC Adapter

The construction of the charging stations allows them to be chained together but a separate adapter must be used for each charging station. One adapter will not operate more than one charging station.

4. If necessary, remove the battery pack from the instrument as described in Step 1 - Step 6 in "Replacing the Lithium Ion Battery Pack" on page 123.

5. Insert the battery pack into the charging station as shown in Figure 23 below so that the metal contacts on the back of the battery pack come into contact with the metal contacts in the charging station. When proper contact has been made, the red LED on the charging station will turn on.

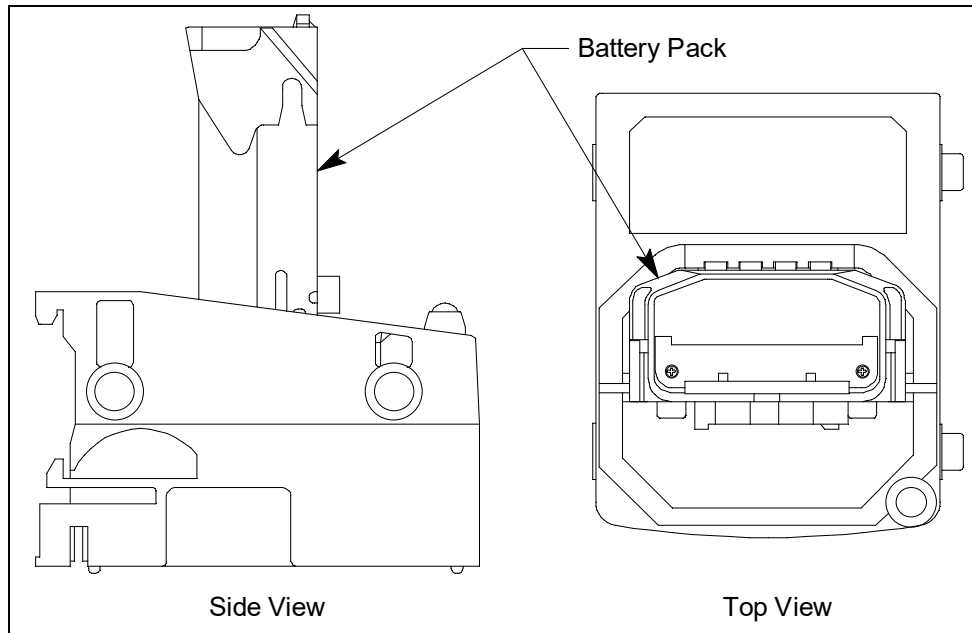

Figure 23: Putting the Battery Pack into the Charging Station

6. When a full charge has been reached, approximately 6 hours, the red LED on the charging station will turn off. Remove the battery pack from the charging station and unplug the charging station's power cord from the AC outlet.
7. If necessary, reinstall the battery pack as described in Step 7 - Step 8 on page 123.

Replacing the Probe's Particle Filter and Hydrophobic Filter Disk

Inspect the probe's internal components if you notice that the GX-6100's pump sounds bogged down or if an unexplained low flow alarm occurs. Replace the particle filter and hydrophobic filter disk if they appear dirty or saturated with liquid. Replace the gasket in the probe if it appears damaged.

1. Hold the sample hose and probe assembly so that the probe tip is pointing up.
2. Grasp each end of the clear probe body firmly and unscrew the two halves from each other. The top half includes the probe tube and the bottom half includes the sample hose.

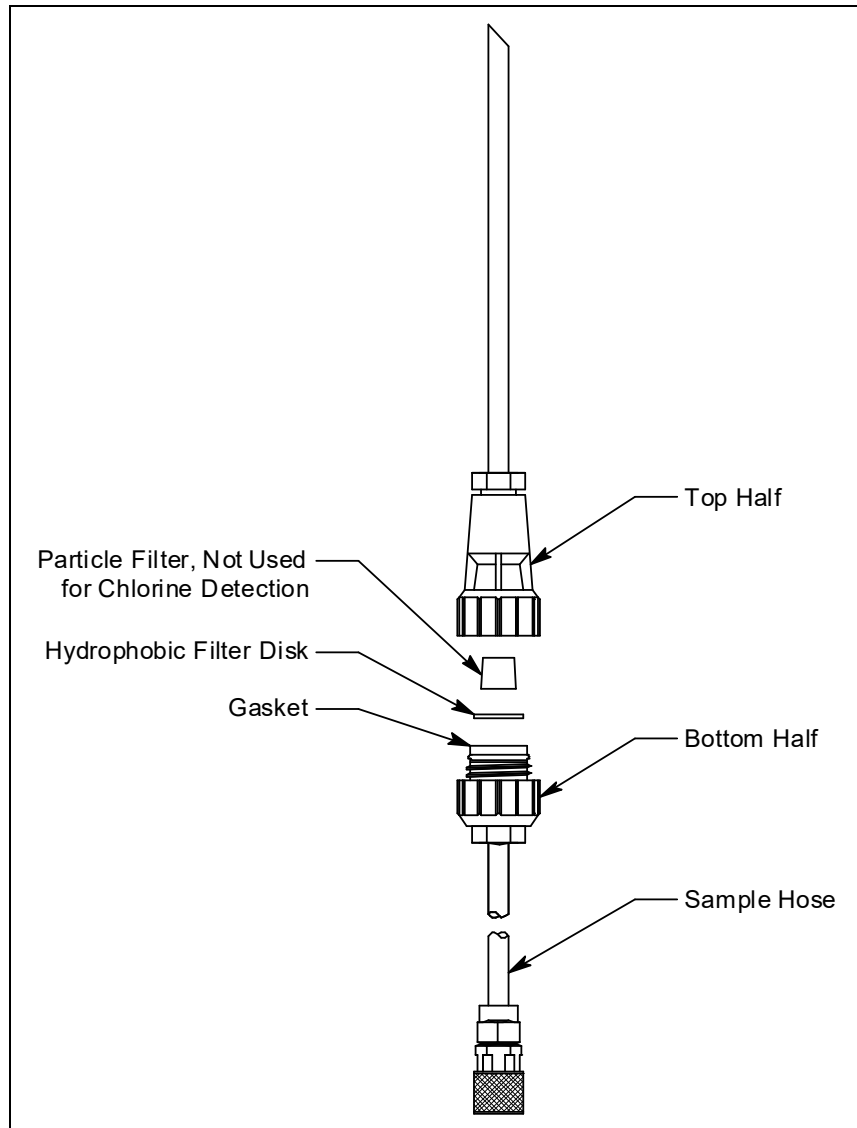

Figure 24: Replacing the Particle Filter and Hydrophobic Filter Disk

3. Set the top half aside. Make sure the bottom half remains oriented with the sample hose facing down.

4. The particle filter should be sitting on top of the hydrophobic filter disk. If it is not, remove it from the top half of the probe.
5. Remove the white hydrophobic filter disk from the top of the bottom half. The disk sits in a black gasket.
6. Place the new filter disk flat on top of the gasket. Make sure that it sits in the gasket and does not extend over the gasket's edge.
7. Set the new particle filter on top of the filter disk. The bigger end should be facing down.

CAUTION: *If you are replacing filters in a probe intended for chlorine detection, do not install the particle filter.*

8. Carefully screw the top half onto the bottom half disk while keeping the probe oriented with the probe tip facing up and the sample hose facing down. The particle filter fits into a recess in the top half of the probe. Be sure the particle filter is not compressed in any way.
9. Tighten the halves together very firmly to ensure a seal.
10. To test the seal, do the following.
 - a. Install the probe on the GX-6100.
 - b. Startup the GX-6100.
 - c. Confirm that a low flow alarm occurs when you cover the end of the probe tube with your finger.
 - d. If a low flow alarm does not occur, hand tighten the probe further.
 - e. If a low flow alarm still does not occur when you cover the probe tube with your finger, disassemble the probe, inspect the placement of the hydrophobic filter disk, reassemble the probe, and re-test it.

Replacing the Sensor Filters

Combustible Gas Sensor Filter

The H₂S filter disk is dark red in color and although it may darken over time, its color is not indicative of remaining filter life. The H₂S filter disk can absorb H₂S for 33 ppm hours and should be replaced after that much exposure. With this many ppm hours of absorption, the H₂S filter disk should be replaced after 80 minutes of exposure to 25 ppm H₂S. This equates to replacing the H₂S filter disk after 40 2-minute calibrations with a cylinder containing 25 ppm H₂S. If H₂S exists in the monitoring environment, the H₂S filter disk will have to be replaced more frequently.

Dual CO/H₂S Sensor Filter

The dual CO/H₂S sensor has a half black/half white filter installed over it. The filter should be replaced if you notice either 1) unexplained CO readings or 2) For users with a 1 ppm H₂S alarm point: a drift on the H₂S channel's zero reading, unexplained H₂S readings, the filter appears dirty, or every 6 months (whichever is sooner).

CO-Only Sensor Filter

A black charcoal filter is installed over CO-only sensors. The filter should be replaced if you notice unexplained CO readings.

H₂S-Only Sensor Filter

A white humidity filter is placed into a recess in the filter gasket over the H₂S sensor (if installed). The filter absorbs humidity in the sampling environment to prevent unstable readings around 0 ppm. "H₂S" is printed on the side of the filter.

For users with a 1 ppm H₂S alarm setpoint, the filter should be replaced every 6 months, if you notice a drift on the zero reading, or if the filter appears dirty (whichever is sooner). For users with a 2 ppm or higher H₂S alarm setpoint, the filter does not necessarily ever need to be replaced.

Filter Replacement Procedure

1. Verify that the GX-6100 is off.
2. Use a small Phillips screwdriver to unscrew the four screws holding the flow chamber to the rest of the GX-6100's case.
3. Grasp the sides of the flow chamber and lift it away from the rest of the case. The screws are captive screws and will not come out of the flow chamber.
4. To replace the H₂S scrubber disk, remove the old one from its recess in the sensor gasket and replace it with the new one making sure that it is properly seated. You do not have to remove the sensor gasket to replace the H₂S scrubber disk. It sits in a recess on top of it.

5. To replace the dual charcoal/humidity filter, pull the old one out of its recess in the sensor gasket if it did not already come out and replace it with a new one. You do not have to remove the sensor gasket to do this. The charcoal filter sits in a recess on top of it.

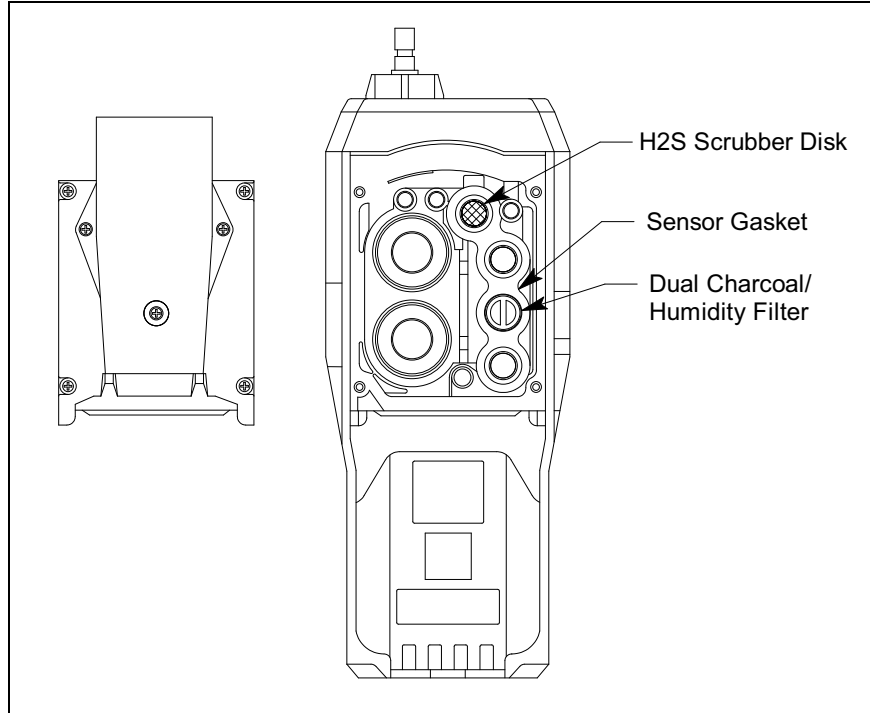

Figure 25: Replacing the H₂S Scrubber Disk and Dual Charcoal/Humidity Filter

6. Ensure that the sensor gasket is installed properly. The flow fitting connections need to be facing up and cannot be skewed sideways. The gasket must be pushed down in the center and secured under the gasket aligning tabs.

NOTE: Failure to install the sensor gasket appropriately may result in inaccurate gas readings.

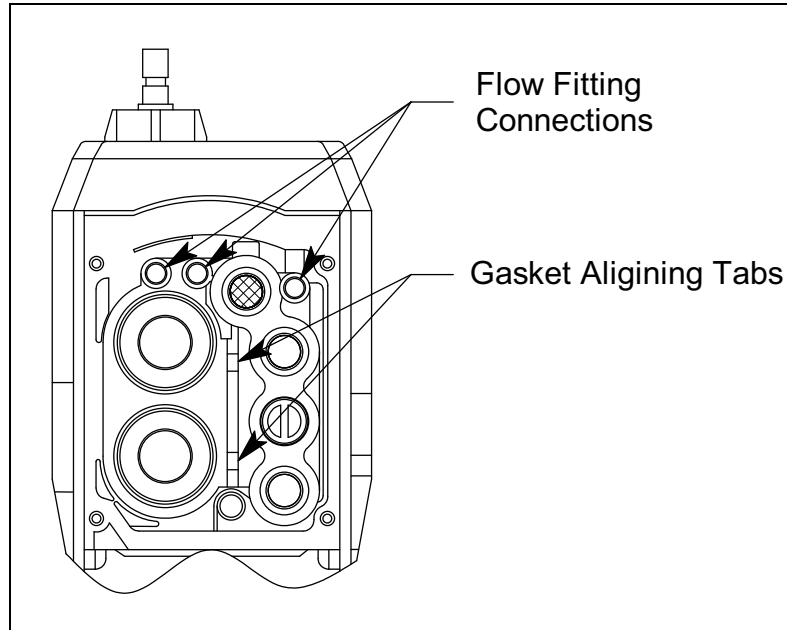

Figure 26: Sensor Gasket Seating

7. Insert the flow chamber back into the instrument.
8. Tighten the flow chamber's four screws that were loosened in Step 2.
9. To verify that the sensor gasket was inserted properly:
 - a. Turn the GX-6100 on.
 - b. Plug the inlet with your finger.
 - c. Verify that the GX-6100 goes into low flow alarm. If the GX-6100 does not go into low flow alarm, turn the instrument off and attempt to seat the sensor gasket again.

Replacing a Sensor

1. Verify that the GX-6100 is off.
2. Use a small Phillips screwdriver to unscrew the four screws holding the flow chamber to the rest of the GX-6100's case.
3. Grasp the sides of the flow chamber and lift it away from the rest of the case. The screws are captive screws and will not come out of the flow chamber.
4. Gently pull up the edges of the sensor gasket to loosen it from its connections. Be sure not to lose any of the filters that are in it. The sensors will be exposed.

5. Locate the sensor you want to replace and remove it from its socket.
6. Carefully insert the replacement sensor in the correct socket.
 - a. Be sure that the new sensor is installed in the same position as the old sensor and that the following sensor priority for the smart sensor 1 position is maintained.

High Priority ↓ Low Priority	10.6 eV low range PID
	10.0 eV/benzene PID
	11.7 eV PID
	10.6 eV high range PID
	ESS-03 Cl ₂
	MOS sensors
	ESS-03 NH ₃
	IR and other ESS-03 sensors

For example, if your instrument is a 4-gas + low range PID + high range PID, the low range PID sensor should be in the smart sensor 1 position and the high range PID sensor should be in the smart sensor 2 position. If your instrument is a 4-gas + high range PID, the high range PID sensor should be in the smart sensor 1 position and a dummy sensor should be installed in the smart sensor 2 position. See the figure below for the location of the smart sensor 1 and 2 positions.

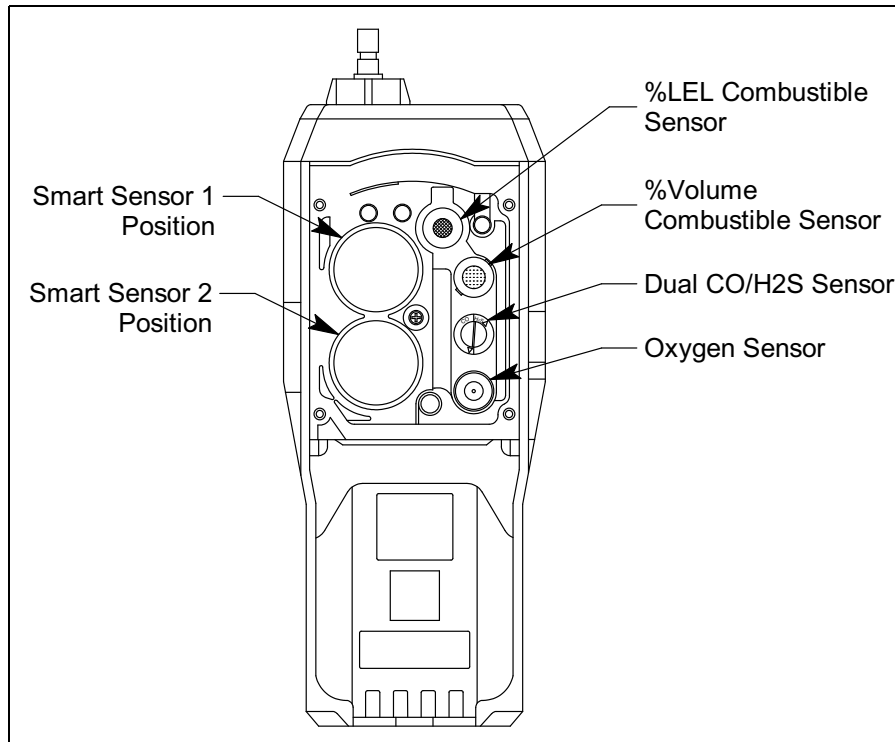

Figure 27: Replacing a Sensor

CAUTION: When replacing a sensor, verify that the sensor is properly aligned with its socket before inserting it into the socket. The CO, H₂S, and dual CO/H₂S sensors have alignment slots which match up with alignment tabs in the sockets. The combustible sensors each have two non-polarized contacts which must line up with the contacts in their socket. Forcing a sensor into its socket may damage the sensor or the socket.

7. If your instrument has a factory installed dummy sensor, ensure that it is still installed correctly. Make sure that the flat side is up and the hollow side is down.
8. Place the sensor gasket and filters back over the sensors ensuring that the sensor gasket seals with the sensors and the flow fittings. The flow fitting connections need to be facing up and cannot be skewed sideways. The gasket must be pushed down in the center and secured under the gasket aligning tabs.

NOTE: Failure to install the sensor gasket appropriately may result in inaccurate gas readings.

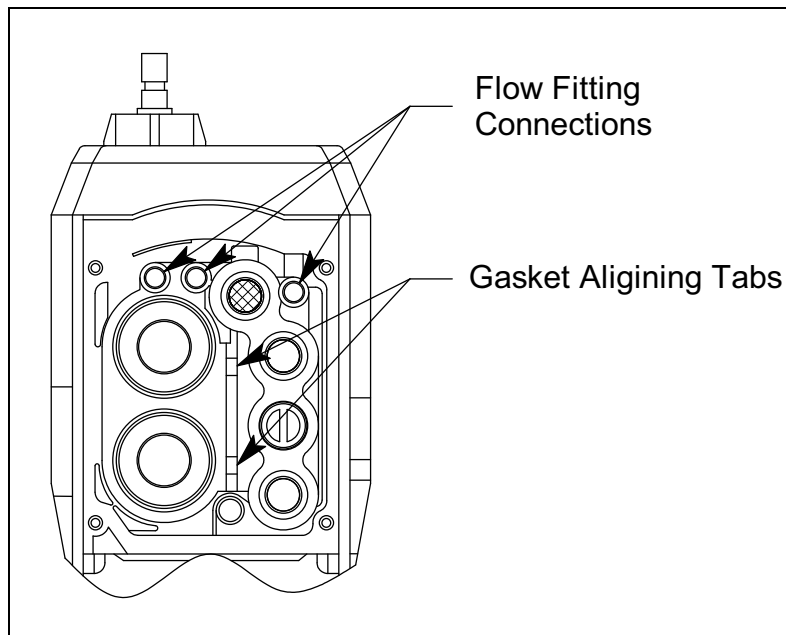

Figure 28: Sensor Gasket Seating

9. Insert the flow chamber back into the instrument.
10. Tighten the flow chamber's four screws that were loosened in Step 2.
11. Start up the GX-6100 by pressing and briefly holding the POWER/ENTER button.
12. To verify that the sensor gasket was inserted properly:
 - a. Plug the inlet with your finger.
 - b. Verify that the GX-6100 goes into low flow alarm. If the GX-6100 does not go into low flow alarm, turn the instrument off and attempt to seat the sensor gasket again.
13. Calibrate the new sensors as described on page 77.

Replacing the Hydrophobic Filter and Wire Mesh Disk

1. Verify that the GX-6100 is off.
2. Locate the clear plastic filter holder at the top of the GX-6100.
3. Grasp the filter holder and turn it 1/4 turn counterclockwise.
4. Pull the filter holder away from the case.
5. The wire mesh disk and hydrophobic filter are located in the case and are retained by a rubber gasket.

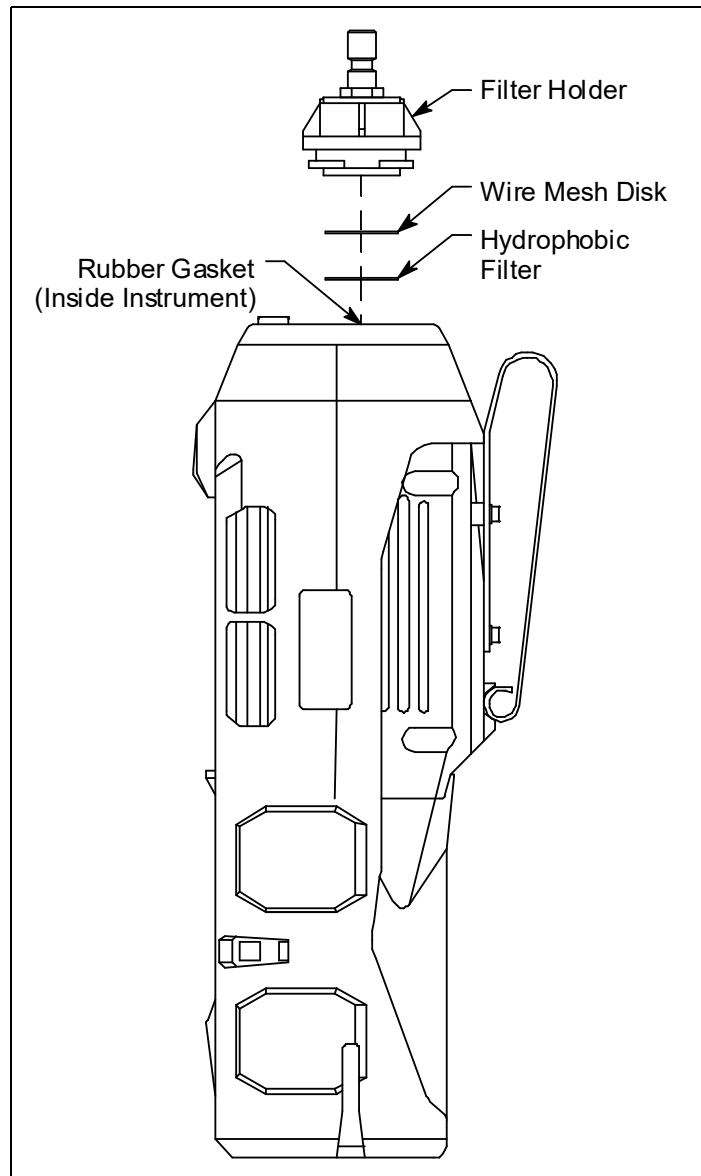

Figure 29: Changing the Filter & Wire Mesh Disk

6. Using a small flat head screwdriver, carefully pry the wire mesh disk and hydrophobic filter from the gasket. Do not remove the gasket.
7. Carefully install the new hydrophobic filter and/or wire mesh disk making sure the wire mesh disk is on top of the hydrophobic filter.
8. Reinstall the filter holder. Align the two wide tabs on the bottom of the filter holder with the two wide slots in the case where the filter holder fits. Push the filter holder into the case and turn it 1/4 turn clockwise until it snaps into place.

PID Sensor Maintenance

The PID sensor includes user serviceable parts. They are the lamp and the electrode stack. The following sections include procedures for cleaning the lamp, replacing the lamp, and replacing the electrode stack.

Cleaning the PID Sensor's Lamp, 10.0 eV and 10.6 eV Lamps

Clean the lamp if you notice a significant drop in sensitivity from one scheduled calibration to another or if you are not able to calibrate the PID channel. See Table 16 on page 151 for lamp cleaning kit ordering information. The lamp cleaning kit for the 10.0 eV and 10.6 eV PID sensors includes the following items:

- an electrode stack removal tool
- a small vial of aluminum oxide powder
- 40 cotton swabs
- 10 finger cots

Perform the following procedure to clean the PID lamp:

1. Verify that the GX-6100 is off.
2. Use a small Phillips screwdriver to unscrew the four screws holding the flow chamber to the rest of the GX-6100's case.
3. Grasp the sides of the flow chamber and lift it away from the rest of the case. The screws are captive screws and will not come out of the flow chamber.
4. Gently pull up the edges of the sensor gasket to loosen it from its connections. Be sure not to lose any of the filters that are in it. The sensors will be exposed.
5. Locate the PID sensor.
6. Grasp the sensor firmly and pull it out of its socket.

- Place the PID sensor face down on a flat clean working surface.

NOTE: Do not touch the lamp window with your fingers as this may contaminate the window with finger oil. At this point it is recommended that the finger cots be used on the fingers handling the lamp. Finger cots are included with the lamp cleaning kit.

- Hold the PID sensor steady on the working surface with one hand and using the other hand, locate the tabs on the electrode stack removal tool and insert them into the slots on the side of the PID sensor near the face.

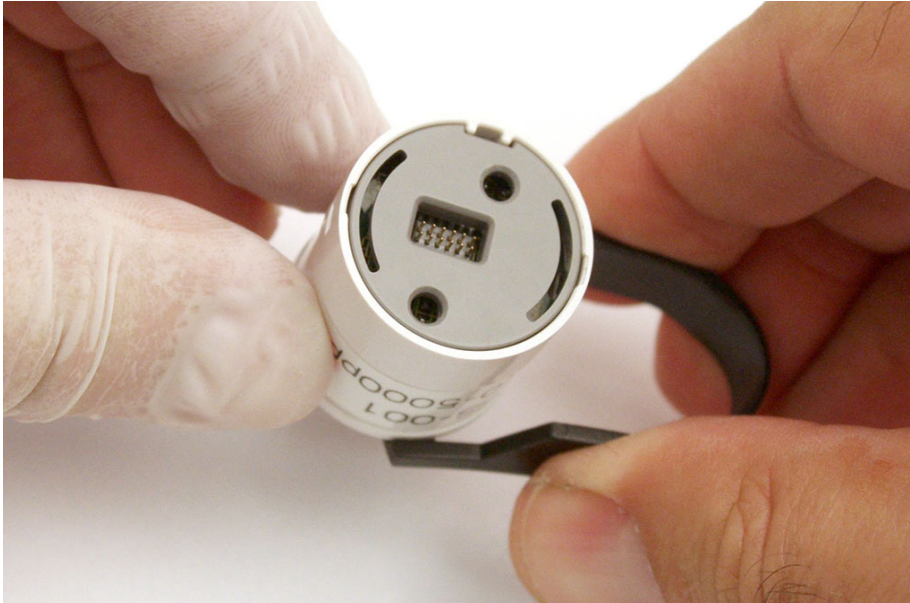

Figure 30: Using Removal Tool

- Squeeze the removal tool to push the tabs into the sensor slots until the electrode stack and lamp are released.
- Carefully lift the PID sensor body away from the electrode stack and lamp. Take care not to touch the lamp window, the flat end of the lamp, with your fingers. If the lamp remains lodged in the sensor body, carefully remove it with tweezers.

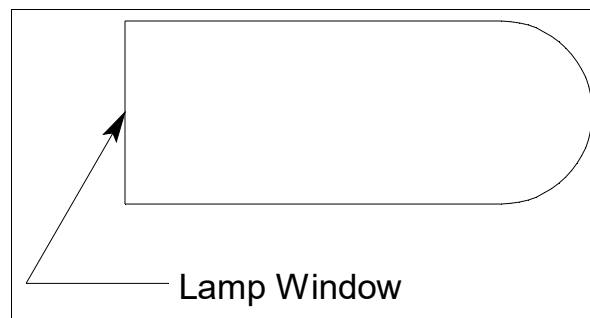

Figure 31: Lamp Window Location

- If the spring in the lamp cavity comes out, place it back into the lamp cavity.
- Hold the lamp in one hand being careful not to touch the lamp window with your fingers.

13. With the other hand collect a small amount of aluminum oxide powder on a cotton swab.
14. Use this cotton swab to polish the PID lamp window. Use a circular motion, applying light pressure to clean the lamp window. Do not touch the lamp window with your fingers.

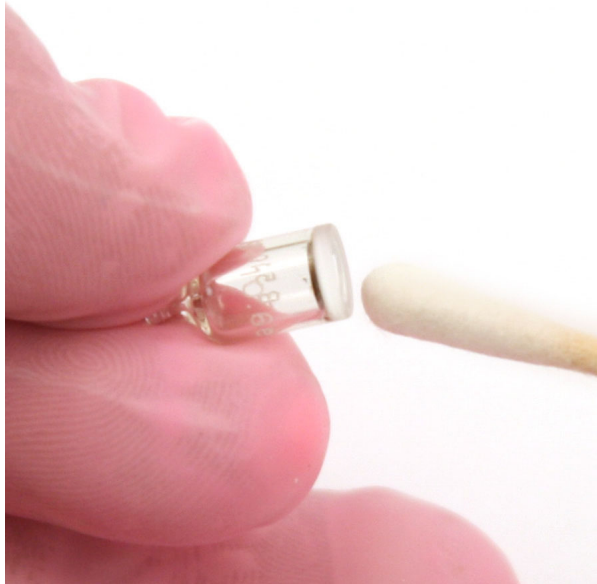

Figure 32: Polishing the Electrode Lamp Window

15. Continue polishing until you can hear a squeaking sound made by the cotton swab moving over the window surface. This usually occurs after about 15 seconds of polishing.
16. Remove the residual powder from the lamp window with a clean cotton swab. Take care not to touch the tip of the cotton swab that is used to clean the lamp as this may contaminate it with finger oil.
17. Ensure the lamp is completely dry and any visible signs of contamination are removed before reinstalling.
18. Hold the electrode stack between the thumb and forefinger of one hand and place the window end of the lamp inside the O-ring seal in the electrode stack with the other hand as shown below.



Figure 33: Reinstalling the Electrode Lamp

19. Twisting the lamp slightly during insertion will help to ensure the lamp window is snug against the stack's front electrode. The lamp should be supported by the O-ring.
20. Continuing to hold the electrode stack between your forefinger and thumb, carefully insert the lamp into the lamp cavity in the sensor ensuring that the lamp remains in position.
21. Press in the electrode stack firmly to ensure that the stack wing clips are engaged and the faces of the stack and sensor body are flush.
22. Carefully line up the PID sensor's connections with the connections on the bottom of the socket and slowly insert the sensor in the socket.
23. Do not attempt to push the sensor in farther once it makes contact with the bottom of the socket until you are sure that the sensor's connections are engaged with the socket's connections. If you feel that the connections did not engage, slightly rotate the sensor back and forth without putting pressure on it until you feel the connections engage.
24. Push the sensor into the socket until it bottoms out.
25. Place the sensor gasket and filters back over the sensors ensuring that it seals with the sensors and the flow fittings. The flow fitting connections need to be facing up and cannot be skewed sideways. The gasket must be pushed down in the center and secured under the gasket aligning tabs.

NOTE: Failure to install the sensor gasket appropriately may result in inaccurate gas readings.

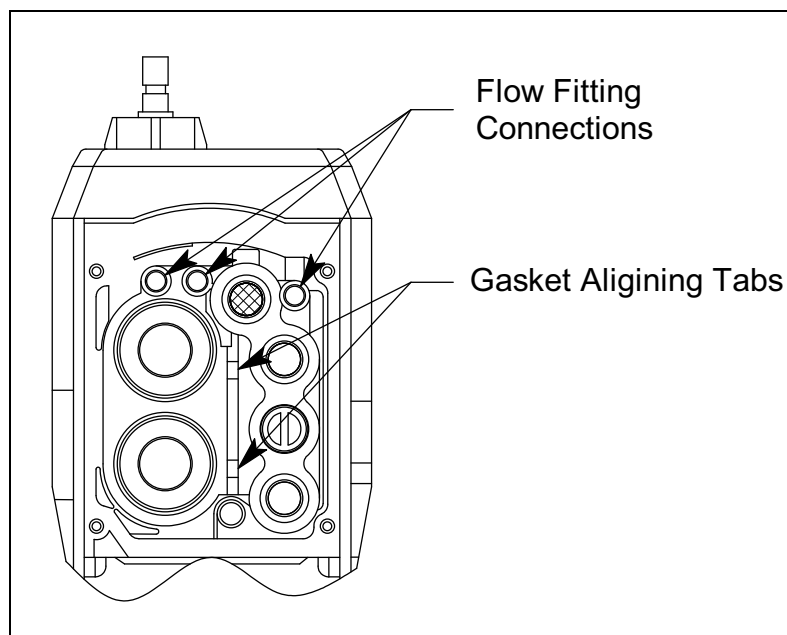

Figure 34: Sensor Gasket Seating

26. Insert the flow chamber back into the instrument.
27. Tighten the flow chamber's four screws that were loosened in Step 2.
28. Start up the GX-6100 by pressing and briefly holding the POWER/ENTER button.

29. To verify that the sensor gasket was inserted properly:
 - a. Plug the inlet with your finger.
 - b. Verify that the GX-6100 goes into low flow alarm. If the GX-6100 does not go into low flow alarm, turn the instrument off and attempt to seat the sensor gasket again.
30. Calibrate the PID sensor as described in “Chapter 5: User Mode and Calibration” on page 77.

Replacing the PID Sensor's Lamp

If cleaning the PID lamp does not resolve any calibration problems you may be having, the lamp may need to be replaced.

NOTE: Do not touch the new lamp window (the flat end) with your fingers as this may contaminate the window with finger oil.

1. Verify that the GX-6100 is off.
2. Use a small Phillips screwdriver to unscrew the four screws holding the flow chamber to the rest of the GX-6100's case.
3. Grasp the sides of the flow chamber and lift it away from the rest of the case. The screws are captive screws and will not come out of the flow chamber.
4. Gently pull up the edges of the sensor gasket to loosen it from its connections. Be sure not to lose any of the filters that are in it. The sensors will be exposed.
5. Locate the PID sensor.
6. Grasp the sensor firmly and pull it out of its socket.
7. Place the PID sensor face down on a flat clean working surface.

8. Hold the PID sensor steady on the working surface with one hand and using the other hand, locate the tabs on the electrode stack removal tool and insert them into the slots on the side of the PID sensor near the face.



Figure 35: Using Removal Tool

9. Squeeze the removal tool to push the tabs into the sensor slots until the electrode stack and lamp are released.
10. Carefully lift the PID sensor body away from the electrode stack and lamp. If the lamp remains lodged in the sensor body, carefully remove it with tweezers.
11. If the spring in the lamp cavity comes out, place it back into the lamp cavity.
12. Discard the old PID lamp.

NOTE: At this point it is recommended that the finger cots be used on the fingers handling the lamp. Finger cots are included with the lamp cleaning kit.

13. Hold the electrode stack between the thumb and forefinger of one hand and place the window end of the new lamp inside the O-ring seal in the electrode stack with the other hand as shown below. Take care not to touch the lamp window.

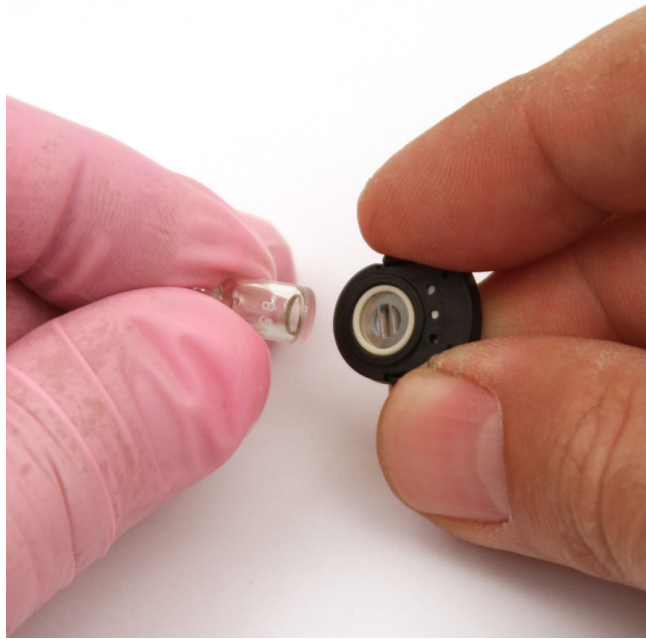

Figure 36: Reinstalling the Electrode Lamp

14. Twisting the lamp slightly during insertion will help to ensure the lamp window is snug against the stack's front electrode. The lamp should be supported by the O-ring.
15. Continuing to hold the electrode stack between your forefinger and thumb, carefully insert the lamp into the lamp cavity in the sensor ensuring that the lamp remains in position.
16. Press in the electrode stack firmly to ensure that the stack wing clips are engaged and the faces of the stack and sensor body are flush.
17. Carefully line up the PID sensor's connections with the connections on the bottom of the socket and slowly insert the sensor in the socket.
18. Do not attempt to push the sensor in farther once it makes contact with the bottom of the socket until you are sure that the sensor's connections are engaged with the socket's connections. If you feel that the connections did not engage, slightly rotate the sensor back and forth without putting pressure on it until you feel the connections engage.
19. Push the sensor into the socket until it bottoms out.

20. Place the sensor gasket and filters back over the sensors ensuring that it seals with the sensors and the flow fittings. The flow fitting connections need to be facing up and cannot be skewed sideways. The gasket must be pushed down in the center and secured under the gasket aligning tabs.

NOTE: Failure to install the sensor gasket appropriately may result in inaccurate gas readings.

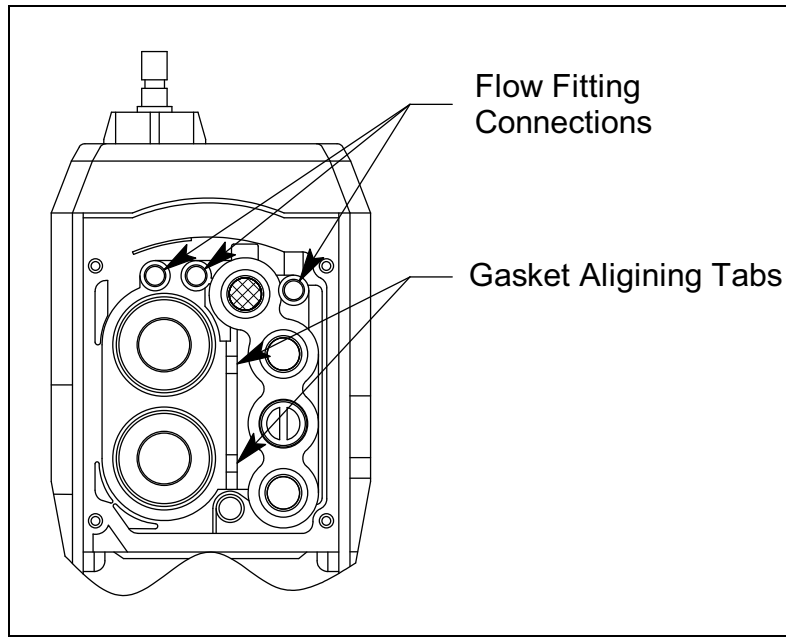

Figure 37: Sensor Gasket Seating

21. Insert the flow chamber back into the instrument.
22. Tighten the flow chamber's four screws that were loosened in Step 2.
23. Start up the GX-6100 by pressing and briefly holding the POWER/ENTER button.
24. To verify that the sensor gasket was inserted properly:
 - a. Plug the inlet with your finger.
 - b. Verify that the GX-6100 goes into low flow alarm. If the GX-6100 does not go into low flow alarm, turn the instrument off and attempt to seat the sensor gasket again.
25. Calibrate the PID sensor as described on page 77.

Replacing the PID Sensor's Electrode Stack

The electrode stack can last for the life of the PID sensor if the GX-6100 is used in a very clean, controlled environment. When used in a heavily contaminated or dirty environment, the electrode stack may only last a month. A contaminated electrode stack will cause a drop in sensitivity which can cause problems calibrating the PID channel. The electrode stack should be replaced if the PID sensor shows signs of contamination even after cleaning or replacing the lamp.

NOTE: Do not touch the new lamp window (the flat end) with your fingers as this may contaminate the window with finger oil.

1. Verify that the GX-6100 is off.
2. Use a small Phillips screwdriver to unscrew the four screws holding the flow chamber to the rest of the GX-6100's case.
3. Grasp the sides of the flow chamber and lift it away from the rest of the case. The screws are captive screws and will not come out of the flow chamber.
4. Gently pull up the edges of the sensor gasket to loosen it from its connections. Be sure not to lose any of the filters that are in it. The sensors will be exposed.
5. Locate the PID sensor.
6. Grasp the sensor firmly and pull it out of its socket.
7. Place the PID sensor face down on a flat clean working surface.

NOTE: At this point it is recommended that the finger cots be used on the fingers handling the lamp. Finger cots are included with the lamp cleaning kit.

8. Hold the PID sensor steady on the working surface with one hand and using the other hand, locate the tabs on the electrode stack removal tool and insert them into the slots on the side of the PID sensor near the face.



Figure 38: Using Removal Tool

9. Squeeze the removal tool to push the tabs into the sensor slots until the electrode stack and lamp are released.
10. Carefully lift the PID sensor body away from the electrode stack and lamp. If the lamp remains lodged in the sensor body, carefully remove it with tweezers.
11. If the spring in the lamp cavity comes out, place it back into the lamp cavity.
12. Discard the old electrode stack.

13. Hold the new electrode stack between the thumb and forefinger of one hand and place the window end of the lamp inside the O-ring seal in the new electrode stack with the other hand as shown below. Take care not to touch the lamp window.

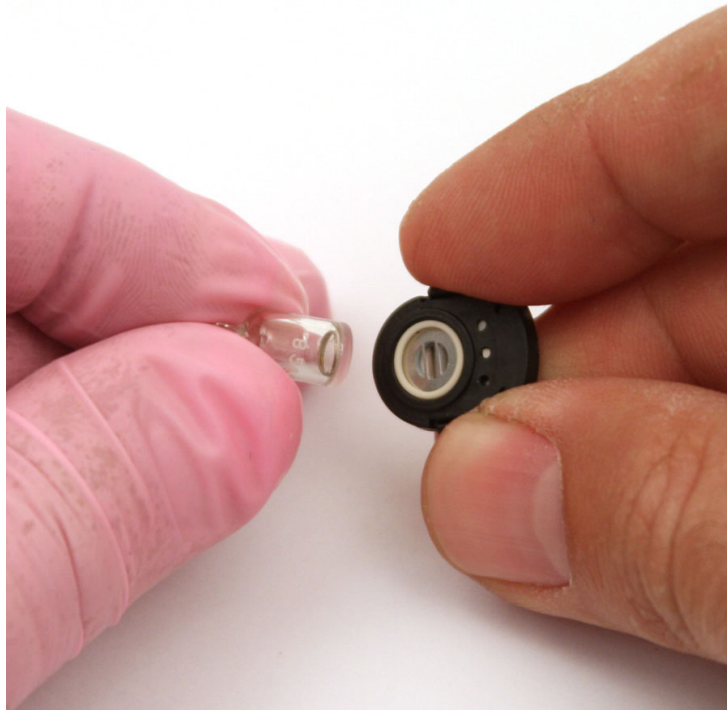

Figure 39: Reinstalling Electrode Lamp

14. Twisting the lamp slightly during insertion will help to ensure the lamp window is snug against the stack's front electrode. The lamp should be supported by the O-ring.
15. Continuing to hold the electrode stack between your forefinger and thumb, carefully insert the lamp into the lamp cavity in the sensor ensuring that the lamp remains in position.
16. Press in the electrode stack firmly to ensure that the stack wing clips are engaged and the faces of the stack and sensor body are flush.
17. Carefully line up the PID sensor's connections with the connections on the bottom of the socket and slowly insert the sensor in the socket.
18. Do not attempt to push the sensor in farther once it makes contact with the bottom of the socket until you are sure that the sensor's connections are engaged with the socket's connections. If you feel that the connections did not engage, slightly rotate the sensor back and forth without putting pressure on it until you feel the connections engage.
19. Push the sensor into the socket until it bottoms out.

20. Place the sensor gasket and filters back over the sensors ensuring that it seals with the sensors and the flow fittings. The flow fitting connections need to be facing up and cannot be skewed sideways. The gasket must be pushed down in the center and secured under the gasket aligning tabs.

NOTE: Failure to install the sensor gasket appropriately may result in inaccurate gas readings.

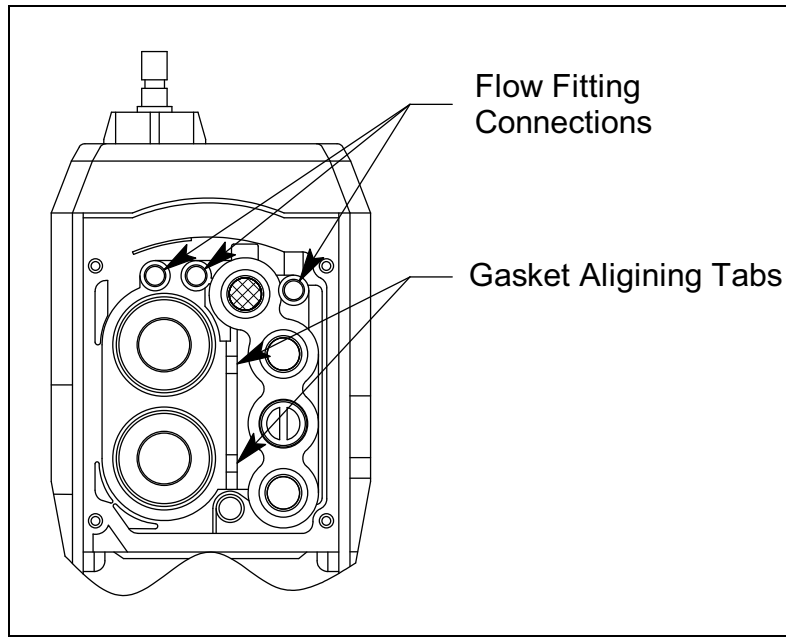

Figure 40: Sensor Gasket Seating

21. Insert the flow chamber back into the instrument.
22. Tighten the flow chamber's four screws that were loosened in Step 2.
23. Start up the GX-6100 by pressing and briefly holding the POWER/ENTER button.
24. To verify that the sensor gasket was inserted properly:
 - a. Plug the inlet with your finger.
 - b. Verify that the GX-6100 goes into low flow alarm. If the GX-6100 does not go into low flow alarm, turn the instrument off and attempt to seat the sensor gasket again.
25. Calibrate the PID sensor as described on page 77.

Chapter 7: Storage and Disposal

Storage

- Store away from direct sunlight
- Store in a location with normal temperature, humidity, and pressure
- Store in a location free of gases, solvents, and vapors
- Store away from dust and dirt
- Turn the power on at least *once every six months for approximately three minutes* to check pump suction. Grease inside the pump motor may solidify and prevent operation unless the product is routinely operated.
- The instrument must always be stored with a battery pack that is either fully charged (Li-ion version) or has fresh batteries installed (alkaline version). The sensors use a small amount of power even when the instrument is turned off. It is important to replace or recharge the batteries every 6 months during storage.
- To store a Li-ion battery pack by itself, discharge the battery to 1 bar in the battery icon and then remove it from the GX-6100.
- To store an alkaline pack by itself, remove the batteries.
- The storage period for accessories is 1 year.

Usage After Storage

- After long-term storage, be sure to perform calibration before resuming use.
- If there is a temperature difference of 15°C or more between the storage and usage locations, turn on the power and allow the product to run for about 10 minutes in a similar environment to the usage location to acclimatize before performing fresh air adjustment in clean air.

Disposal

- Remove the batteries
- Dispose in accordance with local regulations

Chapter 8: General Parts List

Table 16: Parts List

Part Number	Description
06-1248RK-03	Calibration kit tubing, 3 foot length
10-1093RK	Screw, for flow chamber
10-1098RK	Screw, for belt clip
13-0112RK	Wrist strap
13-0123	Belt clip
13-6022	DIN rail, 4" long
13-6022-01	DIN rail mounting kit for 1 charger, includes 4" DIN rail and 2 end clamps
13-6025	DIN rail, 14" long
13-6025-01	DIN rail mounting kit for 4 chargers, includes 14" DIN rail and 2 end clamps
13-6100	End clamp for DIN rail mounting of charger
17-1031RK	Tapered rubber nozzle, red
20-0326	Rubber boot, black
21-1833RK	Filter holder, clear plastic
33-0159RK	Hydrophobic filter, for instrument inlet and for probe
33-0560RK	PID sensor electrode stack, 0 - 40,000 ppb, 2 stacks
33-0560-01	PID sensor electrode stack, 0 - 40,000 ppb, 1 stack
33-0562	PID sensor electrode stack, 0 - 4000 ppm, HPPM type
33-1112RK	Wire mesh disk filter, for instrument inlet
33-3013	Particle filter for probe
33-6092	VOC zero filter, charcoal, with tubing stubs and plugs (Included for low-range PID units, 10.0 eV/benzene units, 11.7 eV PID units, PID/CO ₂ combo units, and NH ₃ /CO ₂ combo units—optional for high-range PID units)
33-7130	Charcoal filter/humidity filter disk (black and white), for dual CO/H ₂ S sensor, 5 pack
33-7131	H ₂ S scrubber disk (dark red), for combustible gas sensor, 5 pack
33-7132	Charcoal filter disk (black), for CO and H ₂ -compensated CO sensors, 5 pack
33-7133	Humidity filter (white), for H ₂ S sensors, 5 pack

Table 16: Parts List

Part Number	Description
47-5124	IrDA adapter module only (for use with all premier portables)
47-5124-01	IrDA Adapter Module with USB extender cable (for use with all premier portables)
47-5125	Cable, USB A male to USB A female, USB extender, 6 feet long
49-0115RK	AC adapter
49-1120RK	AA size alkaline battery
49-1638	Alkaline battery pack
49-1639	Li-ion battery pack
49-2185-01	Battery charger, BC-6000, with 100 - 240 VAC adapter
51-1503	PID sensor replacement lamp, for PID-001LA and PID-002LA sensor
65-7003	Dummy sensor, smart sensor position
65-7004	Dummy sensor, LEL, O ₂ , dual CO/H ₂ S, or TC sensor position
71-0638	Operator's Manual, GX-6100 (this document)
71-0700	Operator's Manual, GX-6100 Configuration Program
71-0705	Operator's Manual, GX-6100 Data Logger Management Program
80-0006-XXP	Sample hose with integral probe, with hydrophobic filter and particle filter, no scrubber section. Replace "XX" with length in feet. 3 foot hose is standard. Lengths up to 100 feet are available.
80-0172	Probe, with hydrophobic filter and particle filter, no scrubber section
80-0404RK	Dilution fitting, 1:1
81-0090RK-01	Calibration cylinder, 3-gas (CH ₄ /O ₂ /CO), 34 liter steel
81-0090RK-03	Calibration cylinder, 3-gas (CH ₄ /O ₂ /CO), 103 liter
81-0103RK-04	Calibration cylinder, isobutylene, 100 ppm in air, 34 liter aluminum
81-0104RK-04	Calibration cylinder, isobutylene, 10 ppm in air, 34 liter aluminum
81-0143RK-02	Calibration cylinder, 5-gas (Proprietary blend of IBL, CH ₄ , O ₂ , H ₂ S, CO), 58-liter aluminum
81-0143RK-04	Calibration cylinder, 5-gas (Proprietary blend of IBL, CH ₄ , O ₂ , H ₂ S, CO), 34 liter aluminum
81-0154RK-02	Calibration cylinder, 4- gas (CH ₄ /O ₂ / H ₂ S/CO), 58 liter
81-0154RK-04	Calibration cylinder, 4- gas (CH ₄ /O ₂ / H ₂ S/CO), 34 liter aluminum

Table 16: Parts List

Part Number	Description
81-1054RK	Regulator, demand-flow type, for Cl ₂ , HCN, and NH ₃ in 34-liter aluminum, 58-liter, and 103-liter calibration cylinders (cylinders with internal threads)
81-1054RK-H2S	Regulator, demand-flow type, for CO, CO ₂ , H ₂ S, N ₂ , NO ₂ , PH ₃ , SO ₂ , zero air, and combustible gases in 34-liter aluminum, 58-liter, and 103-liter calibration cylinders (cylinders with internal threads)
81-1055RK	Regulator, demand-flow type, for all gases in 17- and 34-liter steel cylinders (cylinders with external threads)
81-6AAX-DLV	Calibration kit: 34 liter four-gas (CH ₄ /O ₂ /H ₂ S/CO) cylinder, 34 liter 10 ppm IBL in air cylinder, demand flow regulator, calibration tubing
81-6ABI-DLV	Calibration kit: 34 liter five-gas (IBL/CH ₄ /O ₂ /H ₂ S/CO) cylinder, 34 liter 5 ppm SO ₂ in N ₂ cylinder, demand flow regulator, calibration tubing
81-6ABK-DLV	Calibration kit: 34 liter five-gas (IBL/CH ₄ /O ₂ /H ₂ S/CO) cylinder, 34 liter 10 ppm NO ₂ in N ₂ cylinder, demand flow regulator, calibration tubing
81-6ABL-DLV	Calibration kit: 34 liter five-gas (IBL/CH ₄ /O ₂ /H ₂ S/CO) cylinder, 34 liter 10 ppm HCN in N ₂ cylinder, demand flow regulator, calibration tubing
81-6ABX-DLV	Calibration kit: 34 liter five-gas (IBL/CH ₄ /O ₂ /H ₂ S/CO) cylinder, demand flow regulator, calibration tubing
81-6AXX	Calibration kit: 58 liter four-gas (CH ₄ /O ₂ /H ₂ S/CO) cylinder, demand flow regulator, calibration tubing
81-6AXX-DLV	Calibration kit: 34 liter four-gas (CH ₄ /O ₂ /H ₂ S/CO) cylinder, demand flow regulator, calibration tubing
81-6XAX-DLV	Calibration kit: 34 liter 10 ppm IBL in air cylinder, demand flow regulator, calibration tubing
81-6XBX-DLV	Calibration kit: 34 liter 100 ppm IBL in air cylinder, demand flow regulator, calibration tubing
82-0003RK	Electrode stack removal tool
82-0300RK	Aluminum oxide powder PID lamp cleaning kit, with electrode stack removal tool, for 10.0 eV and 10.6 eV PID sensors' lamps ONLY
ESR-A13i-H2S	Hydrogen sulfide (H ₂ S) sensor
ESR-A13P-CO	Carbon monoxide (CO) sensor
ESR-A1CP-CO-H	Hydrogen-compensated carbon monoxide (CO) sensor
ESR-A1DP-COHS	Dual carbon monoxide (CO) and hydrogen sulfide (H ₂ S) sensor
NCR-6309	LEL combustible sensor, catalytic

Table 16: Parts List

Part Number	Description
ESR-X13P-OXY	Oxygen sensor
PID-001LA	PID sensor, 0 - 40,000 ppb VOC, improved type
PID-002LA	PID sensor, 0 - 4,000 ppm VOC, improved type
TE-7561	TC sensor, 0 - 100% VOL.

Appendix A: Maintenance Mode

This appendix describes the GX-6100 in Maintenance Mode. The GX-6100 is factory-set to suit most applications. Update settings in Maintenance Mode only if required by your specific application. Maintenance Mode items and their factory settings are listed in Table 17 below.

Table 17: Maintenance Mode Menu Items

Menu Item (Page # of Description)	Description	
GAS CAL (page 157)	Displays the following menu items:	
	AIR CAL	The instrument performs a fresh air adjustment.
	CO2 ZERO	The instrument performs a zero adjustment on the CO ₂ channel using 100% nitrogen. <i>NOTE: This menu item only appears in units with a CO₂ sensor installed.</i>
	SPAN CAL	The instrument performs a span adjustment.
BUMP TEST (page 158)	Perform a bump test	
DATE (page 158)	Displays and changes the time/date	
DATE FORMAT (page 158)	<ul style="list-style-type: none"> • DD/MM/YYYY • MM/DD/YYYY (factory setting) • YYYY/MM/DD 	
LANGUAGE (page 159)	<ul style="list-style-type: none"> • ENGLISH (factory setting) • JAPANESE • ITALIAN • SPANISH • GERMAN • FRENCH • PORTUGUESE • RUSSIAN • KOREAN • CHINESE(SC) • CHINESE(TC) • VIETNAMESE • POLISH • TURKISH • SLOVAK • CZECH 	
VERSION (page 160)	Displays the version numbers for the main board, PID table, Bluetooth, and sensor board	

Table 17: Maintenance Mode Menu Items

Menu Item (Page # of Description)	Description
LCD CONTRAST (page 161)	Adjust the contrast level (1-50 , factory setting is 25)
RESTORE DEFAULT (page 161)	Restore default settings
START MEASURE (page 163)	Enter Measuring Mode

Entering Maintenance Mode

WARNING: The GX-6100 is not in operation as a gas detector while in Maintenance Mode.

1. Take the GX-6100 to a non-hazardous location and turn it off if it is on.
2. Press and hold the ▲ AIR and SHIFT ▼ (PANIC) buttons, then press and hold the POWER/ENTER button. When you hear a beep, release the buttons.
3. The main menu displays. It displays eight menu items at a time.

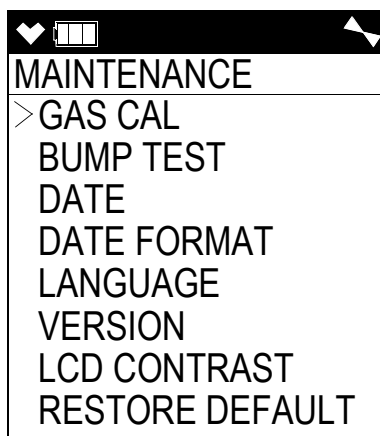

4. Use the ▲ AIR or SHIFT ▼ (PANIC) button to move the cursor up and down through the menu items. Additional items are available above and below the items currently displayed on the screen. They will appear as you scroll farther up or down the current list using the ▲ AIR or SHIFT ▼ (PANIC) buttons.

Tips for Using Maintenance Mode

- When in the main menu, the cursor (>) indicates which menu item will be selected if the POWER/ENTER button is pressed and released.
- Use the SHIFT ▼ (PANIC) button to move the cursor down through the main menu and submenu items, and to lower values or change the setting in a specific option.
- Use the ▲ AIR button to move the cursor up through the main menu and submenu items, and to raise values or change the setting in a specific option.

- Use the POWER/ENTER button to enter a menu item with the cursor next to it and to enter and save settings during programming.
- Flashing parameters can be adjusted with the ▲ AIR and SHIFT ▼ (PANIC) buttons.
- Press the DISP/LOCK button while in a screen where you are entering or updating parameters to exit the screen without saving any changes. You can also use the DISP/LOCK button to back out of submenus and return to the main menu.

Performing a Calibration (GAS CALIBRATION)

1. While in Maintenance Mode, press ▲ AIR or SHIFT ▼ (PANIC) to scroll to **GAS CALIBRATION**.
2. Press and release POWER/ENTER. The **GAS CALIBRATION** menu appears.

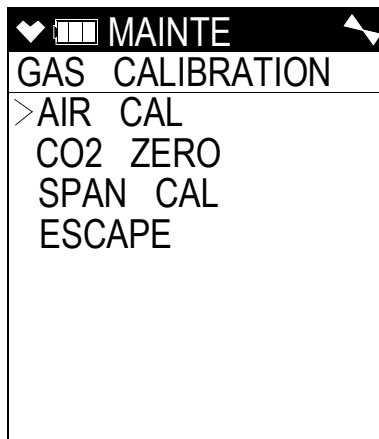

3. Use the ▲ AIR or SHIFT ▼ (PANIC) buttons to move the cursor to the operation you wish to perform.

See “Performing a Calibration (GAS CAL)” on page 86 for instructions to calibrate the instrument.

NOTE: Even if **Automatic Start After Successful Calibration** is selected (factory setting) in the GX-6100 Configuration Program, the GX-6100 will not automatically start its warmup sequence. That setting only applies to User Mode operation.

See “Setting the Fresh Air Reading” on page 87 for instructions to zero all channels.

See “Performing a Zero Adjustment on the CO₂ Sensor (CO₂ ZERO CAL)” on page 90 for instructions to zero the CO₂ channel.

Performing a Bump Test (BUMP TEST)

Entering the **BUMP TEST** menu item brings you to the first of the Gas Select screens. See “Performing a Bump Test” on page 80 for instructions, starting at Step 7.

NOTE: Even if **Automatic Start After Successful Calibration** is selected (factory setting) in the GX-6100 Configuration Program, the GX-6100 will not automatically start its warmup sequence. That setting only applies to User Mode operation.

Setting the Date and Time (DATE)

1. While in Maintenance Mode, press ▲ AIR or SHIFT ▼ (PANIC) to scroll to **DATE**.
2. Press and release POWER/ENTER. The date and time will be displayed with the year flashing.

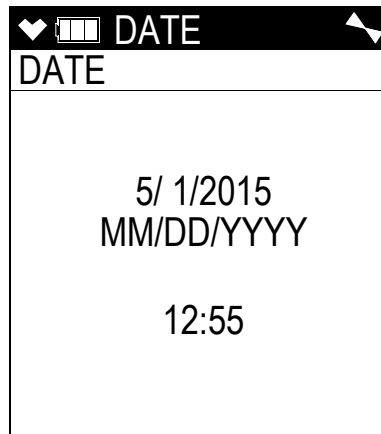

3. Use ▲ AIR or SHIFT ▼ (PANIC) to display the desired year.
4. Press and release POWER/ENTER to save the setting. The month setting flashes.
5. Repeat Step 3 and Step 4 to enter the month, day, hours, and minutes settings. The main menu displays after you enter the seconds setting.

Setting the Date Format (DATE FORMAT)

The date can be displayed in one of three ways:

- **MM/DD/YYYY** (factory setting)
- **DD/MM/YYYY**
- **YYYY/MM/DD**

1. While in Maintenance Mode, press ▲ AIR or SHIFT ▼ (PANIC) to scroll to **DATE FORMAT**.
2. Press and release POWER/ENTER. The **DATE FORMAT** screen appears with the current setting displayed.

3. Use ▲ AIR or SHIFT ▼ (PANIC) to display the desired setting.
4. Press and release POWER/ENTER to save the setting and return to the main menu.

Updating the Language Setting (LANGUAGE)

This setting allows you to select the language for the GX-6100's user interface. The available choices are **English** (factory setting), **Japanese**, **Italian**, **Spanish**, **German**, **French**, **Portuguese**, **Russian**, **Korean**, **Chinese (SC)**, **Chinese (TC)**, **Vietnamese**, **Polish**, **Turkish**, **Slovak**, and **Czech**.

1. While in Maintenance Mode, press ▲ AIR or SHIFT ▼ (PANIC) to scroll to **LANGUAGE**.
2. Press and release POWER/ENTER. The **LANGUAGE** screen appears with the cursor in front of the current language.
3. Use ▲ AIR or SHIFT ▼ (PANIC) to move the cursor in front of the desired language.
If you do not wish to select a new language, press and release DISP/LOCK. The unit will return to the main menu.
4. Press and release POWER/ENTER to save the new language setting and return to the main menu. The GX-6100's user interface will now be in the newly selected language.
5. If you select a language other than English, a prompt will appear during startup that allows you to change the language back to English if desired.

Viewing the ROM/SUM of the Instrument (VERSION)

The **ROM/SUM** screen shows the firmware version that is loaded in the instrument and the firmware checksum.

1. While in Maintenance Mode, press ▲ AIR or SHIFT ▼ (PANIC) to scroll to **VERSION**.
2. Press and release the POWER/ENTER button. The ROM and checksum values for your unit will be displayed.

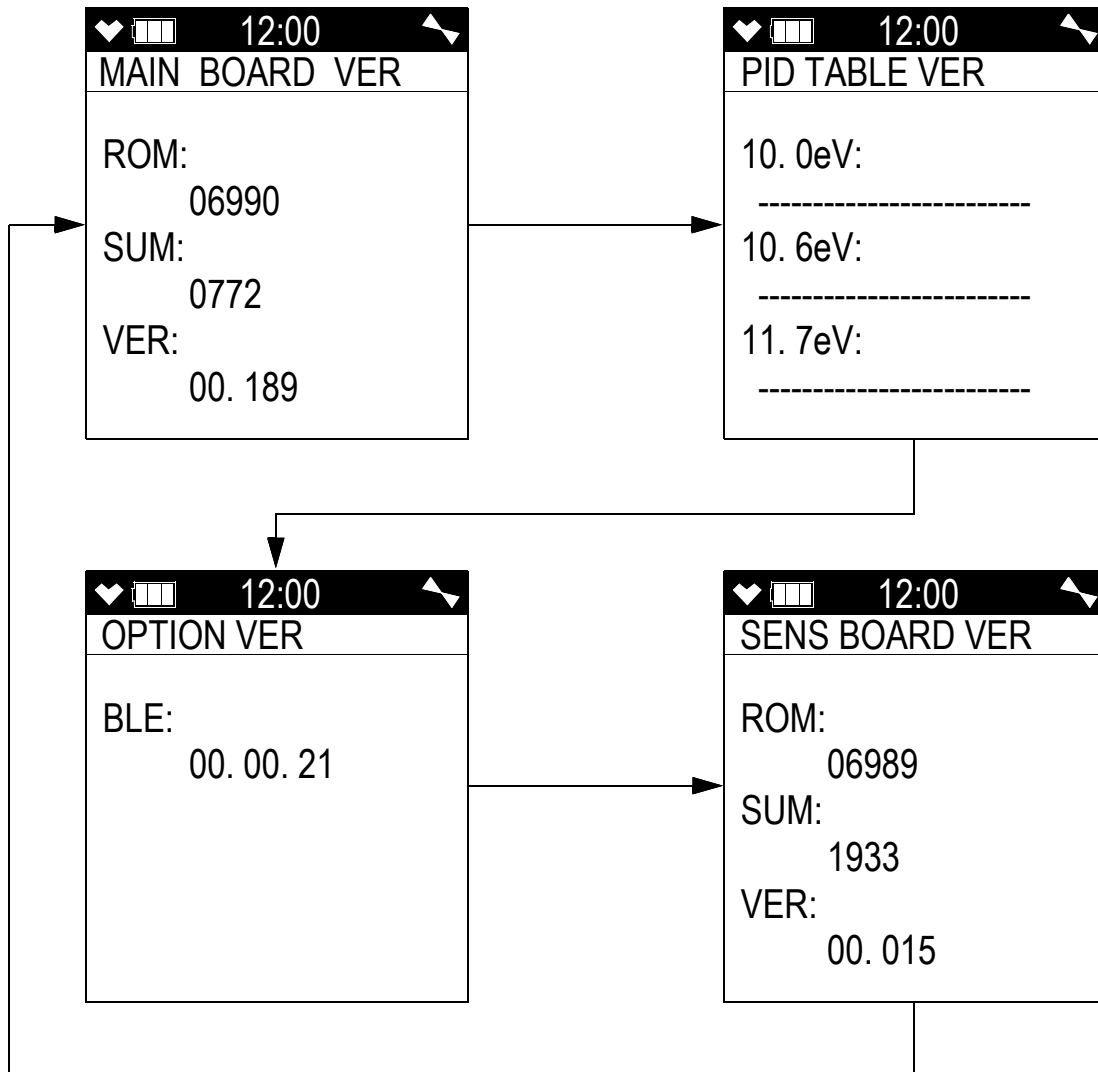

3. The first line displays the ROM number. The ROM number indicates the firmware version number. In the above example, the ROM number is 05017. The bottom line displays the firmware file's checksum, 62C7 in the above example.
4. Press and release the POWER/ENTER button again to return to the main menu.

Adjusting LCD Contrast (LCD CONTRAST)

Use this setting to adjust the LCD contrast value (**1 - 50**) so characters on the LCD are easy to see. Increasing the contrast darkens the characters and LCD background. **25** is the factory setting.

1. While in Maintenance Mode, press ▲ AIR or SHIFT ▼ (PANIC) to scroll to **LCD CONTRAST**.
2. Press and release the POWER/ENTER button. The current LCD contrast setting will be displayed.

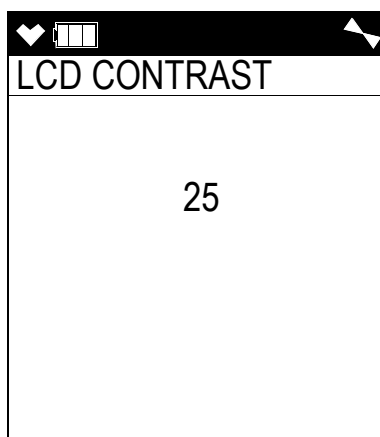

3. Use ▲ AIR or SHIFT ▼ (PANIC) to increase or decrease the LCD contrast setting. If you do not wish to change the setting, press and release DISP/LOCK. The unit will return to the main menu.
4. Press and release the POWER/ENTER button to confirm the setting and return to the main menu.

Restoring the Default Settings (RESTORE DEFAULT)

Each of the GX-6100 setup parameters, such as the span calibration values, zero and span settings, or parameters in Maintenance Mode, has a default setting. For the items in Maintenance Mode, the default settings are the same as the standard factory settings. If you want to return the GX-6100 to its default configuration, it is possible to do so by using the Default Settings menu item in Maintenance Mode. Returning the GX-6100 to its default configuration can be useful if various setup parameters have been changed in the field and you want to return the GX-6100 to its original configuration as shipped from the factory.

There are some special GX-6100 configurations that may have a different default configuration than the standard. Consult RKI Instruments, Inc. for information regarding non-standard default configurations.

WARNING: *When the GX-6100 is restored to its default configuration, the zero and span values for each channel are reset. You must recalibrate all active channels if you restore the GX-6100 to its default configuration.*

1. While in Maintenance Mode, press ▲ AIR or SHIFT ▼ (PANIC) to scroll to **RESTORE DEFAULT**.
2. Press and release POWER/ENTER. The Restore All? screen appears asking if you want to restore the default configuration.

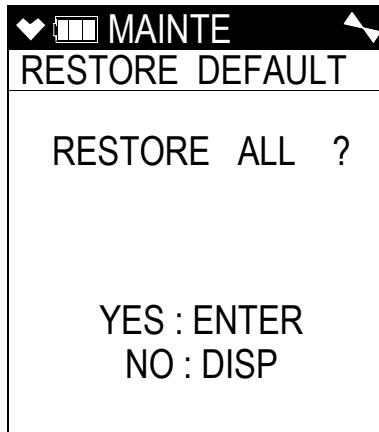

3. If you do not want to restore the default configuration, press and release DISP/LOCK to return to the main menu.
If you do want to restore the default configuration, continue with Step 4.
4. Press and release the POWER/ENTER button. A screen appears asking you to confirm that you want to restore the default configuration.

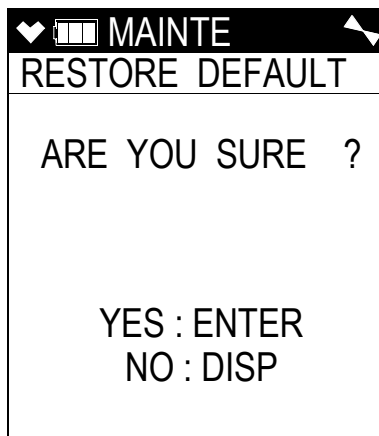

5. Press and release the POWER/ENTER button. The screen will indicate that the default configuration has been restored and return to the main menu.

Exiting Maintenance Mode (START MEASURE)

1. While in Maintenance Mode, press ▲ AIR or SHIFT ▼ (PANIC) to scroll to **START MEASURE**.
2. Press and release POWER/ENTER.
3. The unit will begin its start-up sequence.

Appendix B: Using the GX-6100 in Leak Check Mode

Overview

This chapter explains how to operate the GX-6100 in Leak Check Mode. Leak Check Mode is used to pinpoint small leaks of combustible gas from valves, flanges, connections, and other potential leak points. When the GX-6100 is in Leak Check Mode, only the MOS/catalytic sensor(s) and potentially the CO sensor or O₂ sensor, depending on the setting of the **Leak Display** parameter in the GX-6100 Configuration Program, will be active.

NOTE: If the **Leak Display** parameter in the GX-6100 Configuration Program is set to “with CO” or “with O₂”, the CO or O₂ channel, respectively, will appear in Leak Check Mode. If the **Leak Display** parameter is set to Peak Only (factory setting), the CO or O₂ channel will not appear in Leak Check Mode. All screens in this section do not show the CO channel. If your instrument’s **Leak Display** parameter is set to “with CO” or “with O₂”, your screens may appear different.

If a GX-6100 is intended for detecting leaks, it is shipped with Leak Check Mode enabled so that the operator must choose which operational mode to use when the unit is turned on.

A MOS and/or catalytic sensor must be installed to use the GX-6100 in Leak Check Mode. If a catalytic sensor is installed, the Leak Check Mode display will autorange between ppm and LEL. If a TC sensor is installed with the same target gas as the MOS sensor, the Leak Check Mode display will autorange between ppm, LEL, and %VOL, depending on the sensors installed.

Sensor Specifications, Leak Check Mode

The following specifications represent sensor performance *while in Leak Check Mode*.

Table 18: Sensor Specifications

	Methane (CH ₄)	Isobutane (C ₄ H ₁₀)
Range	0 - 5000 ppm	0 - 2000 ppm
Reading Increment	• MOS-type PPM sensors: 10 ppm • Catalytic-type sensors: 50 ppm	

MOS-Type PPM Sensor

NOTE: The MOS-type PPM sensor is used *only* while the GX-6100 is in Leak Check Mode.

The MOS sensor for the GX-6100 consists of a smart sensor base with a plug-in MOS sensor on top. The smart sensor base is different for methane and isobutane, but the plug-in sensor is the same for both target gases.

Start Up, Leak Check Mode

This section explains how to start up the GX-6100 in Leak Check Mode and get it ready for operation.

Turning On the GX-6100, Leak Check Mode

CAUTION: Only the combustible gas sensor(s) and potentially the CO sensor are active while the GX-6100 is in Leak Check Mode.

NOTE: A MOS and/or catalytic sensor must be installed to use the GX-6100 in Leak Check Mode. If a catalytic sensor is installed, the Leak Check Mode display will autorange between ppm and LEL. If a TC sensor is installed with the same target gas as the MOS sensor, the Leak Check Mode display will autorange between ppm, LEL, and %VOL, depending on the sensors installed.

NOTE: In order for **LEAK CHECK MODE** to appear as a selection in the Mode Select screen, Leak must be selected in the GX-6100 Configuration Program's Mode Selection section.

1. Connect the tapered rubber nozzle or the sample hose and probe to the GX-6100's quick connect inlet fitting.
2. Press and briefly hold down the POWER/ENTER button. Release the button when you hear a beep. The Mode Select screen displays.

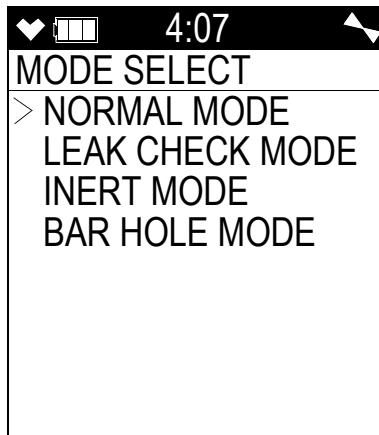

3. Use the ▲ AIR or SHIFT ▼ (PANIC) button to scroll to the Leak Check Mode Select screen. Press and release the POWER/ENTER button to begin the Leak Check Mode startup sequence.

NOTE: If no button is pressed for 20 seconds, the unit will enter whichever mode the cursor is next to.

4. See “Turning On the GX-6100” on page 28 for a description of the remainder of the warm-up sequence keeping the following in mind:
 - a. Even if **LUNCH BREAK** is set to **ON**, the Lunch Break screen will not appear.
 - b. The **Low Alarm**, **High Alarm**, **STEL**, and **TWA** screens will not appear.
 - c. If **all** Leak-Check compatible sensors (the catalytic or MOS sensor) fail, it is not possible to enter Leak Check Mode. Press and release the RESET button to acknowledge the failure(s) and return to the Mode Select screen. Replace the failed sensor(s).
If any other sensor that is installed fails, press and release the RESET button to acknowledge the failure and continue to Leak Check Mode. Change the failed sensor(s) as soon as possible for use in Normal Mode.
5. The GX-6100 is now monitoring for gas in Leak Check Mode. The pump is on and one of the following screens appears depending on the setting of the **Leak Display** parameter in the GX-6100 Configuration Program.

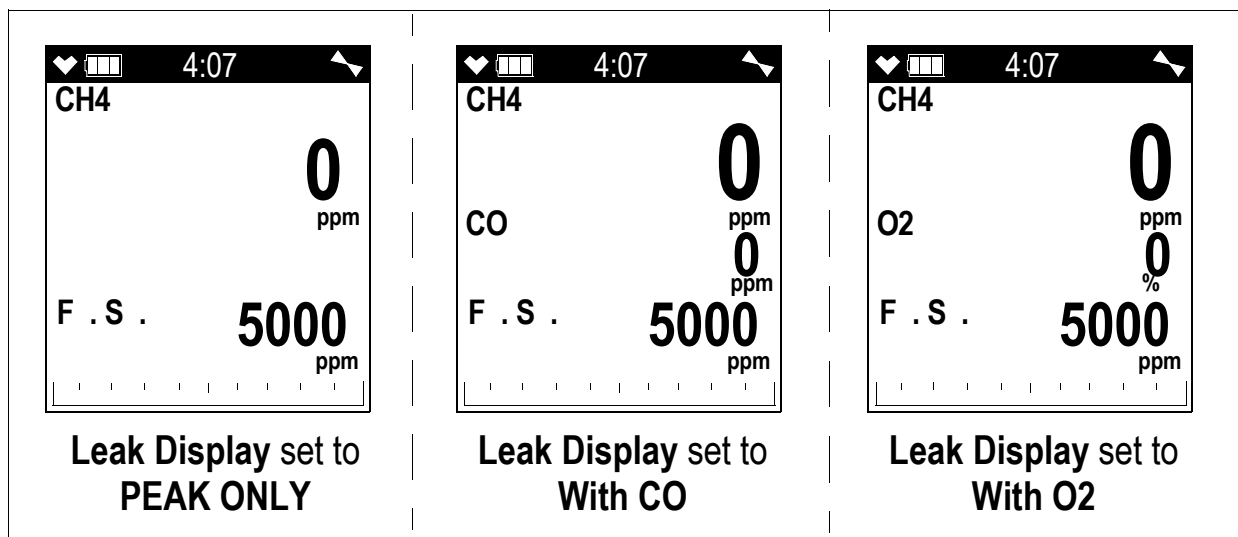

NOTE: For maximum sensor stability, allow 3-5 minutes for the sensor to warm up. The small increment size in the lower range of a ppm measurement can cause instability if the unit is not properly warmed up.

6. If you wish to change operating modes by returning to the Mode Select screen, press and hold the ▲ AIR and DISP/LOCK buttons for 5 seconds.

Performing a Demand Zero, Leak Check Mode

Before using the GX-6100, it is recommended to set the fresh air reading for the target gas by performing a demand zero. This will set the combustible gas channel to zero.

1. Find a fresh-air environment. This is an environment free of toxic or combustible gases and of normal oxygen content (20.9%).
2. Turn on the unit as described above in Turning On the GX-6100, Leak Check Mode.
3. Press and hold the ▲ AIR button. The display prompts you to hold the ▲ AIR button.

4. Continue to hold the ▲ AIR button until the display prompts you to release it. The GX-6100 will set the fresh air reading for the CH₄ channel. Start up is complete and the unit is now ready for monitoring.

Leak Testing

In Leak Check Mode, the GX-6100 only displays combustible gas readings unless the CO display is enabled. The increment of the reading is always 10 ppm for MOS sensors and 50 ppm for catalytic sensors but the display range can be adjusted by using the DISP/LOCK button. The display range choices are 500 ppm, 1000 ppm, 2000 ppm (max for sensors calibrated to isobutane), and 5000 ppm (max for sensors calibrated to methane). The readings are displayed in both numerical and bar graph form. As the gas concentration increases from 0 ppm, the alarm LEDs begin to blink in unison with the buzzer's pulsing. The blinking/pulsing rate increases as the gas reading increases.

In a low-light environment, press and release any of the buttons to turn on the display backlight. If Beep Select in the GX-6100 Configuration Program is set to **LED**, **Buzzer**, or **LED+Buzzer**, the GX-6100 beeps and/or flashes once every user-defined interval to confirm that it's operating.

Setting the Display Range Value

The GX-6100's Leak Check Mode has multiple display range ppm values to choose from: 500 ppm, 1000 ppm, 2000 ppm (max display concentration for isobutane), and 5000 ppm (max display concentration for CH₄).

NOTE: The GX-6100 is always detecting combustible gas up to full scale. The display range value is only adjusting the highest concentration (ppm) displayed on the LCD.

To change the display range value:

1. While in Leak Check Mode, press and release the DISP/LOCK button. The display range value displayed along the bottom of the screen will change.
2. Continue to press and release the DISP/LOCK button until the desired display range value is displayed.
3. The unit is now operating with the selected display range.

Turning the Alarm On and Off

The alarm buzzer can be turned off and on in Leak Check Mode. This setting only applies to Leak Check Mode and does not affect buzzer operation in Normal Mode. When the buzzer is turned off, **NO ALARM** appears at the top of the screen. If the buzzer is turned off, then it will remain off in Leak Check Mode even if you enter Normal Mode and return to Leak Check Mode or turn the unit off and on unless the buzzer is manually turned on.

To turn the buzzer off or on while in Leak Check Mode:

1. Press and hold the SHIFT ▼ (PANIC) and RESET buttons for 5 seconds.
2. Release the buttons when **NO ALARM** appears at the top of the screen.

Locating a Leak

1. Start up the GX-6100 as described above in “Turning On the GX-6100, Leak Check Mode” on page 165.
2. Move the probe tip or tapered nozzle tip back and forth along the area where a leak is suspected.
3. Observe the display reading. If the gas level increases, the numerical reading will increase, the bar graph level will increase, and the beeping and buzzer pulsing frequency will increase.
4. The gas reading may exceed the selected display range or the max display range. For a description of both scenarios, see the following section.
5. Use the increasing and decreasing of the reading to locate the leak point.
6. To exit Leak Check Mode and enter another mode, press and hold the ▲ AIR and DISP/ LOCK buttons for 5 seconds to access the Mode Select screen.

Overscale Conditions

If the gas level goes over the display range, the gas reading will be replaced with “OVER” and the LEDs and buzzer will pulse continuously until the overscale condition has cleared. Once the gas level gets low enough, the instrument will start showing ppm readings again.

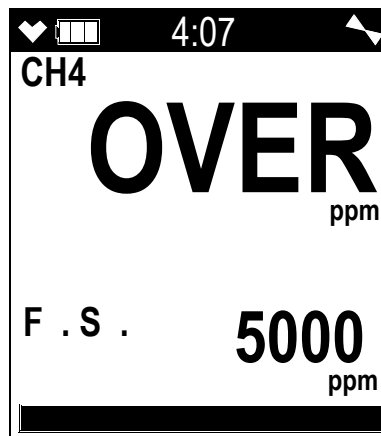

NOTE: Snap logs saved in Leak Check Mode will only save readings up to the display range concentration and log OVER for readings above the display range, even if the reading is below 2000 ppm (for isobutane) or 5000 ppm (for methane).

H₂S Interference

Exposure to H₂S will interfere with MOS sensor readings. For example, 25 ppm H₂S increases the MOS sensor reading by 25-50 ppm. Instruments with MOS sensors exposed to H₂S **will not recover unless they are recalibrated**.

NOTE: The MOS sensor(s) should be calibrated after all other sensors are calibrated.

MOS sensor readings will be artificially inflated after H₂S exposure. The presence of 150 ppm combustible gas could read as high as 2000 ppm (isobutane) or 5000 ppm (methane) if the MOS sensor is not recalibrated after H₂S exposure.

Autoranging in Overscale Conditions

If the gas level exceeds the max display range concentration (5000 ppm for **CH4** and 2000 ppm for **i-C4H10**) and a %LEL sensor is installed, the displayed unit of measurement will switch to %LEL. Once the gas level drops below the max display range, the instrument's displayed unit of measurement will return to parts per million (ppm).

NOTE: Snap logs saved in Leak Check Mode will only save readings up to the display range concentration and log OVER for readings above the display range, even if the reading is below 2000 ppm (for isobutane) or 5000 ppm (for methane).

Peak Hold Mode

Peak Hold Mode allows the user to view the peak reading for the operating session while viewing the current methane reading.

To enter Peak Hold Mode:

1. Turn the GX-6100 on as described in “Turning On the GX-6100, Leak Check Mode” on page 165. Select the desired display range. In the example below, 5000 ppm has been selected.
2. Press and release the RESET button. The Peak Hold Mode screen displays. The current methane reading is displayed on the first line. The peak reading is displayed on the second line. The display range is displayed on the third line.

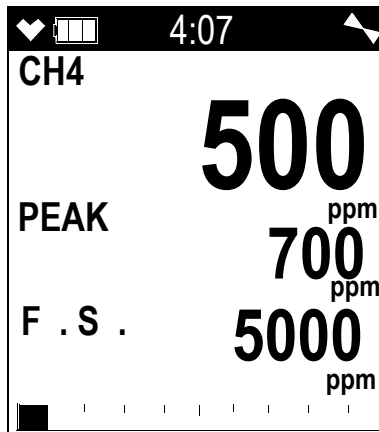

3. If the highest reading recorded is higher than the display range value, “OVER” will be displayed instead of a gas reading.
4. To exit Peak Hold Mode and return to Leak Check Mode, press and release the RESET button.

Snap Log Mode, Leak Check Mode Operation

The snap logging function in Snap Log Mode allows the user to record data at a specific time and have it saved to the data logger. The data is assigned a snap log ID and is saved with the station ID that was selected when the data was taken.

To enter Snap Log Mode and record snap log data:

1. Turn the GX-6100 on as described in “Turning On the GX-6100, Leak Check Mode” on page 165.
2. Select the desired display range. In this procedure, 5000 ppm has been selected.
3. Press and hold the SHIFT ▼ (PANIC) button, then press and hold the ▲ AIR button and hold both until you hear a beep. The Station ID Select screen will display and the current station ID will be in the middle of the screen.

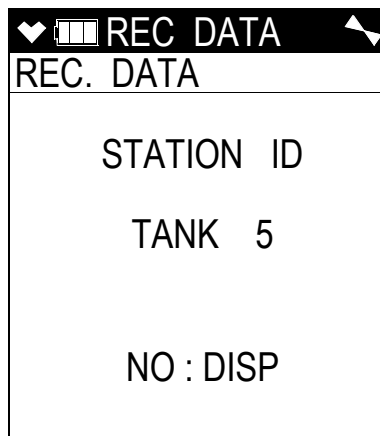

4. To exit Snap Log Mode and return to Leak Check Mode, press and release the DISP/LOCK button.
5. Use the ▲ AIR and SHIFT ▼ (PANIC) buttons to scroll to the desired station ID.

6. Press and release the POWER/ENTER button to continue to the Base Reading screen.

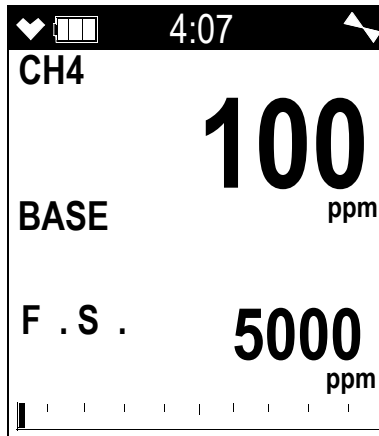

NOTE: If **Leak Display** parameter in the GX-6100 Configuration Program is set to **With CO** or **With O₂**, the CO or O₂ reading is saved during a snap log but will not be displayed in the Base Reading screen, Peak Reading screen, or while viewing snap log data at the instrument. However, the saved CO/O₂ reading(s) can be viewed using the GX-6100 Datalogging Program.

7. To return to the Station ID Select screen without taking a base reading, press and release the RESET button. To exit Snap Log Mode completely and return to Leak Check Mode, press and release the DISP/LOCK button.
8. In order to get a base, or background, reading, take the instrument a few feet away from where you intend to test. To save the base reading, press and release the POWER/ENTER button. If the gas concentration exceeds the display range in the Base Reading screen, the instrument will go into an overscale alarm, and “OVER” will be recorded when you press POWER/ENTER.
9. The unit will display **SAVED** before continuing to the Peak Reading screen.

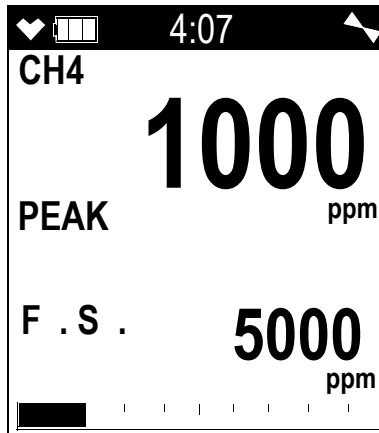

10. Take the instrument to the monitoring area. The instrument will retain and display the highest gas concentration encountered.
 To return to the Station ID Select screen without taking a peak reading, press and release the RESET button.
 To save the peak reading, press and release the POWER/ENTER button. The reading on the screen will be saved.
 If the gas concentration exceeds the max display reading in the Peak Reading screen, the instrument will go into an overscale alarm. The full scale display range value will be displayed and OVER will be recorded when you press POWER/ENTER.
11. The unit will display SAVED before returning to the **Station ID Select** screen.
12. Repeat Step 5 through Step 11 to take additional snap log data.
13. To exit Snap Log Mode at any time without taking a snap log or when you are finished recording snap logs, press and release the DISP/LOCK button. The unit will immediately return to the Leak Check Mode screen.
14. The data recorded in Snap Log Mode can be viewed in Display Mode. See the next section for more information.

Viewing Snap Log Data in Leak Check Mode Operation

Snap log data can be viewed while in Leak Check Mode. If snap log data was taken while in Measuring Mode, that data will also appear.

1. Turn the GX-6100 on as described in “Turning On the GX-6100, Leak Check Mode” on page 165.
2. Press and hold the RESET button and then press and hold the DISP/LOCK button and release both. The screen that appears will depend on whether or not any snap logs have been taken.

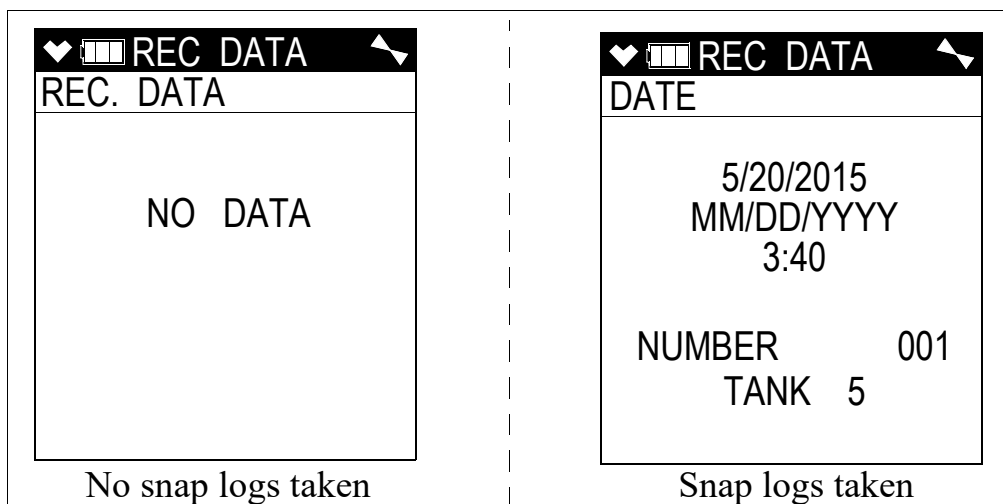

3. If snap logs have been taken, the screen indicates the year, month, day, and time that the most recent snap log was taken.

The number near the bottom of the screen indicates the snap log ID number. The first snap log that is taken is given an ID of **001**. The next snap log ID is **002**. The ID number increases sequentially with each set of snap log data.

The last line of the screen indicates the Station ID that was used for the snap log.

4. Press and release the DISP/LOCK button to return to Leak Check Mode.
5. Use the ▲ AIR and SHIFT ▼ (PANIC) buttons to scroll through different snap log IDs and view what time they were taken. Snap log data that was taken in Leak Check Mode operation will have two snap log ID numbers. One number is for the gas reading and the other is for the peak reading.

ID screen

Data screen

▼ REC DATA ▲

DATE

5/20/2015
MM/DD/YYYY
3:47

NUMBER 003
TANK 5

▼ REC DATA ▲ 4:07

CH4

1000
ppm

PEAK

F . S . **5000**
ppm

Leak Check
Mode Peak
Data

SHIFT ▼ ▲ AIR

SHIFT ▼ ▲ AIR

▼ REC DATA ▲

DATE

5/20/2015
MM/DD/YYYY
3:45

NUMBER 002
TANK 5

▼ REC DATA ▲ 4:07

CH4

100
ppm

BASE

F . S . **5000**
ppm

Leak Check
Mode Base
Data

SHIFT ▼ ▲ AIR

SHIFT ▼ ▲ AIR

▼ REC DATA ▲

DATE

5/20/2015
MM/DD/YYYY
3:40

NUMBER 001
TANK 5

▼ REC DATA ▲

CH4 0 %LEL	O2 20.9 %
H2S 0.0 ppm	CO 0 ppm
VOC 0 ppm	

Normal
Mode
Data

POWER/
ENTER

POWER/
ENTER

POWER/
ENTER

6. To view the data in a snap log ID, press and release the POWER/ENTER button. The gas readings that were taken during the snap log are displayed.

Snap log data that was taken in Leak Check Mode operation will have 2 sequential screens that are part of one data set. One screen is for the base reading and the other screen is for the peak reading. “**BASE**” and “**PEAK**” will appear in the gas reading screen for each type of reading, respectively. If a base data point appears without a peak data point after it, it is because a peak data point was not taken.

NOTE: Even when **Leak Display** in the GX-6100 Configuration Program is set to **With CO** or **With O₂** when the Leak Check snap logs were taken, the CO/O₂ readings will not be displayed. The CO/O₂ readings can be viewed using the GX-6100 Datalogging Program.

7. Use the ▲ AIR and SHIFT ▼ (PANIC) buttons to scroll through the different snap log data screens. The gas readings will change but the snap log ID is not visible from this screen.
8. You can also go back and forth between the ID and data screens by pressing and releasing the POWER/ENTER button.
9. To return to Leak Check Mode, press and release the DISP/LOCK button.

Turning Off the GX-6100, Leak Check Mode

1. Press and hold the POWER/ENTER button.
2. TURN OFF will appear on the display and the buzzer will pulse for about five seconds.
3. Release the button when **TURN OFF** disappears from the display.

MOS Sensor Calibration

NOTE: If the instrument is turned on in a cold environment or has not been turned on for several days, allow the unit 2-5 minutes to warm up before performing a fresh air adjustment and calibration.

See “Performing a Span Adjustment” on page 93 or “Setting Calibration Concentration Values (SETTING CAL-P)” on page 100 for instructions to perform a calibration.

However, when connecting the regulator to the GX-6100, a 24” humidifier tube must be used in place of the standard calibration tubing and the MOS sensor must be calibrated before the other sensors.

Maintenance

The plug-in MOS sensor SH-8661 may require replacement. Only the plug-in portion of the sensor needs to be removed. The sensor’s outer assembly will not likely need replacing. Refer to page 134 for the sensor replacement procedure.

Parts List

Part Number	Description
33-2001RK-02	Humidifier tube, 24"
SH-8661	Plug-in sensor, CH ₄ and isobutane
SHS-8661-CH4	Smart sensor, with plug-in sensor, for CH ₄
SHS-8661-ISO	Smart sensor, with plug-in sensor, for isobutane

Appendix C: Using the GX-6100 in Bar Hole Mode

Overview

This chapter explains how to operate the GX-6100 in Bar Hole Mode. Bar Hole Mode is used to perform consistent checks of bar holes when tracking down underground gas leaks. When the GX-6100 is in Bar Hole Mode, only the IR combustible and oxygen (if installed and active) channels are displayed.

If a GX-6100 is intended for bar hole testing, it is shipped with Bar Hole Mode enabled so that the operator must choose which operational mode to use when the unit is turned on.

In order to use a GX-6100 in Bar Hole Mode, an IR CH₄ or an IR HC sensor must be installed in the Smart Sensor 1 Position in the instrument. Bar Hole Mode will display an oxygen reading if an oxygen sensor is installed and active but an oxygen sensor is not required for Bar Hole Mode use.

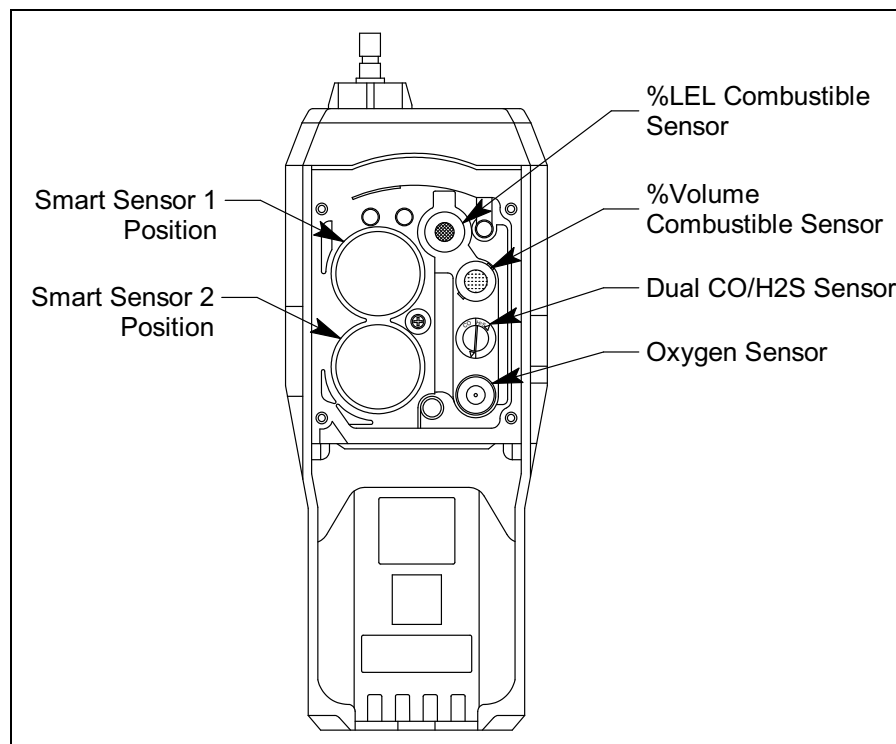

Figure 41: Sensor Location Diagram

Start Up, Bar Hole Mode

This section explains how to start up the GX-6100 in Bar Hole Mode and get it ready for operation.

Turning On the GX-6100, Bar Hole Mode

WARNING: *Gas alarms are not active when the GX-6100 is in Bar Hole Mode.*

CAUTION: *If any sensors other than an IR CH₄/IR HC or oxygen sensor is installed, these sensors will not be active while the GX-6100 is in Bar Hole Mode.*

NOTE: In order for **BAR HOLE MODE** to appear as a selection in the Mode Select screen, **Bar Hole** must be selected in the Mode selection section of the GX-6100 Configuration Program. The factory setting is **OFF**.

1. Connect the tapered rubber nozzle or the sample hose and probe to the GX-6100's quick connect inlet fitting.
2. Press and briefly hold down the POWER/ENTER button. Release the button when you hear a beep. The **MODE SELECT** screen displays.

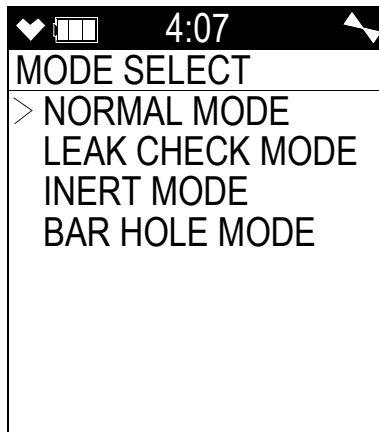

- Use the ▲ AIR or SHIFT ▼ (PANIC) button to scroll to the Bar Hole Mode Select screen.

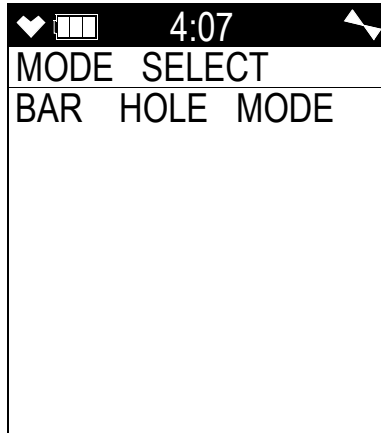

- With the Bar Hole Mode Select screen displayed, press and release the POWER/ENTER button to begin the Bar Hole Mode startup sequence.

NOTE: If no button is pressed for 20 seconds, the unit will proceed into whichever mode is displayed.

- See “Turning On the GX-6100” on page 28 for a description of the remainder of the warm-up sequence keeping the following in mind:
 - Even if **LUNCH BREAK** is set to **ON**, the Lunch Break screen will not appear.
 - The **Low Alarm**, **High Alarm**, **STEL**, and **TWA** screens will not appear.
 - If the IR CH₄ or IR HC (whichever is installed) sensor fails, it is not possible to enter Bar Hole Mode. Press and release the RESET button to acknowledge the failure and return to the Mode Select screen. Replace the failed sensor.

If oxygen sensor fails, press RESET to acknowledge the failure and then continue to Bar Hole Mode. No oxygen reading will be displayed. Replace the failed sensor as soon as possible.

If any other installed sensor fails, press and release the RESET button to acknowledge the failure and continue to Bar Hole Mode. Change the failed sensor(s) as soon as possible for use in Normal Mode.

6. The GX-6100 is now operating in Bar Hole Mode. The pump is off and the following screen appears.



The combustible gas and oxygen channels are displayed along with the battery charge level and station ID.

NOTE: If the oxygen sensor fails or if the oxygen channel is turned off, no oxygen indication will display on the Bar Hole Mode screen.

Performing a Fresh Air Adjustment, Bar Hole Mode

Before using the GX-6100, it is recommended to set the fresh air readings for the target gases by performing a fresh air adjustment. This will set the combustible gas channel to zero and the O₂ channel to 20.9%.

1. Find a fresh-air environment. This is an environment free of toxic or combustible gases and of normal oxygen content (20.9%).
2. Turn on the unit as described above in Turning On the GX-6100, Bar Hole Mode.
3. Press and hold the ▲ AIR button. The pump will start and the display will prompt you to hold the ▲ AIR button.
4. Continue to hold the ▲ AIR button until the display prompts you to release the ▲ AIR button. The GX-6100 will set the fresh air reading for the combustible gas and oxygen channels as it counts down from 8. Once the countdown has finished, start up is complete and the unit is ready for bar hole testing.

Bar Hole Testing

In Bar Hole Mode, you can initiate sampling for a fixed time period to monitor for combustible gas and oxygen in a bar hole. The factory set time is 30 seconds. To change the bar hole sampling time, use the GX-6100 Configuration Program. At the end of the sample period, the pump will shut off and the peak combustible gas and minimum oxygen levels monitored during the sample period will be displayed. Bar Hole Mode also allows you to initiate an air purge cycle to purge gas from the GX-6100 after a sample is taken.

In a low-light environment, press and release the SHIFT ▼ (PANIC) button to turn on the display backlight. Although the backlight will turn on when any button is pressed, other buttons may initiate an undesired operation sequence. See the GX-6100 Configuration Program to program backlight duration. If Beep Select in the GX-6100 Configuration Program is set to LED, Buzzer, or LED+Buzzer, the GX-6100 beeps and/or flashes once every user-defined interval to confirm that it's operating.

Performing a Bar Hole Test

1. Start up the GX-6100 as described in “Start Up, Bar Hole Mode” on page 178.
2. If you wish to change the station ID, press the SHIFT ▼ (PANIC) and DISP/LOCK buttons and release when you hear a beep. The current station ID will be displayed and it will be flashing. If you wish to exit the Station ID Select screen without making any changes, press and release the RESET button.

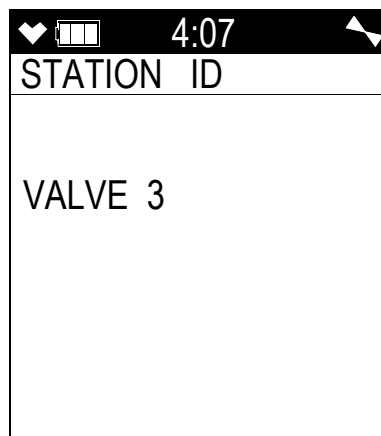

3. Use the ▲ AIR and SHIFT ▼ (PANIC) buttons to scroll to the desired station ID and press and release POWER/ENTER. The unit will return to the Bar Hole Measuring screen.



4. Take the GX-6100 to the bar hole that will be tested.

5. Insert the probe into the bar hole and press and release the POWER/ENTER button. The pump will turn on and the sample period will begin with the sample period counting down in seconds in the lower middle portion of the display. “MEASURE” will flash below the countdown. The combustible gas channel will automatically switch between %LEL or %vol based on the level of gas present. The combustible gas channel’s reading will also be displayed in graph format on the bottom of the screen. If you wish to cancel the measurement, press and release the RESET button.

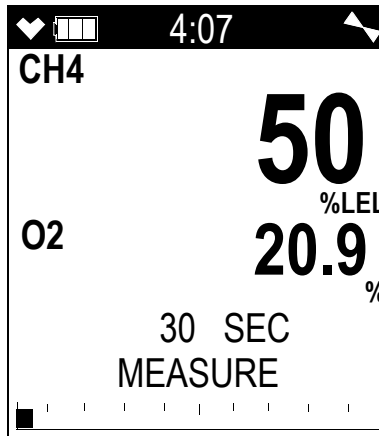

6. At the end of the sample period, the pump will shut off and the buzzer will sound, then the peak combustible gas reading and the minimum oxygen reading for the sample period will be displayed. The peak combustible gas reading will also be visually displayed on the graph along the bottom of the screen.

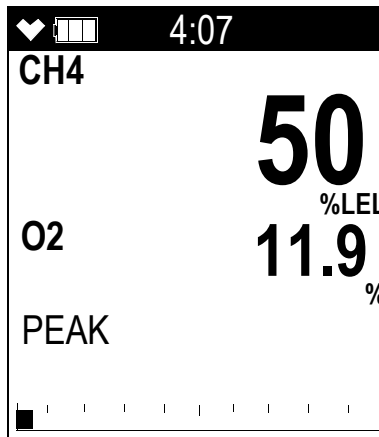

7. If a high concentration of combustible gas is encountered, a fresh air purge can be performed to purge the hose, probe and GX-6100 of gas before the next bar hole test. To perform a purge, do the following:
- Remove the probe from the barhole so the instrument will draw fresh air.

- Press and release the DISP/LOCK button. The display will now indicate PURGE along the bottom of the screen and the purge time will begin counting down from 30 seconds in the lower middle portion of the display. If you wish to cancel the purge, press and release the RESET button.

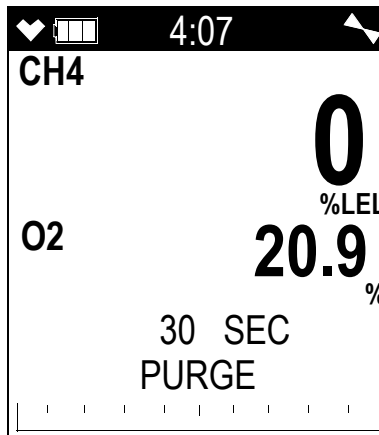

- When the purge is complete, the screen will return to the initial Bar Hole Mode screen.



8. If other bar holes will be tested, proceed to the next bar hole and repeat steps Step 5 - Step 7.
9. To cancel a bar hole measurement or fresh air purge that is in progress, press and release the RESET button.
10. To exit Leak Check Mode and enter another mode, press and hold the ▲ AIR and DISP/LOCK buttons for 5 seconds to access the Mode Select screen.

Turning Off the GX-6100, Bar Hole Mode

1. Press and hold the POWER/ENTER button.
2. The unit will initiate a bar hole measurement. Keep holding the POWER/ENTER button. The buzzer will pulse for about three seconds and TURN OFF will appear at the bottom of the screen.
3. Release the button when TURN OFF disappears.

Appendix D: Interference Information

ESR-A13i-H2S, H₂S Detection

Table 19: Interference Chart for ESR-A13i-H2S, H₂S Detection

Gas	Chemical Formula	Concentration	Indication Value
Acetone	C ₃ H ₆ O	0.54 VOL%	0.0 ppm
Acetylene	C ₂ H ₂	100 ppm	0.0 ppm
Ammonia	NH ₃	38.6 ppm	0.0 ppm
Benzene	C ₆ H ₆	0.30 VOL%	0.0 ppm
Carbon Dioxide	CO ₂	20.0 VOL%	0.0 ppm
Carbon Monoxide	CO	100.0 ppm	0.2 ppm
Chlorine	CL ₂	2.0 ppm	0.0 ppm
Cyclopentane	C ₅ H ₁₀	0.35 VOL%	0.0 ppm
Ethane	C ₂ H ₆	0.75 VOL%	0.0 ppm [*]
Ethanol	C ₂ H ₅ OH	0.83 VOL%	-0.5 ppm [*]
Ethyl Acetate	C ₄ H ₈ O ₂	0.53 VOL%	-0.1 ppm [*]
Fluorine	F ₂	1.6 ppm	0.0 ppm
Hydrogen	H ₂	500 ppm	0.2 ppm
Hydrogen Bromide	HBr	9.0 ppm	0.0 ppm
Hydrogen Chloride	HCl	3.2 ppm	0.0 ppm
Isobutane	i-C ₄ H ₁₀	0.45 VOL%	0.0 ppm
Isobuten	C ₄ H ₈	1000 ppm	0.1 ppm
Isopropyl Alcohol	C ₃ H ₈ O	2.0 VOL%	-0.5 ppm
Methane	CH ₄	1.26 VOL%	0.0 ppm
Methanol	CH ₃ OH	1.38 VOL%	-0.6 ppm [*]
Methyl Ethyl Ketone	C ₄ H ₈ O	0.45 VOL%	0.0 ppm
Methyl Isobutyl Ketone	C ₆ H ₁₂ O	0.30 VOL%	0.0 ppm
Methyl Methacrylate	C ₅ H ₈ O ₂	0.43 VOL%	0.1 ppm [*]
n-Hexane	n-C ₆ H ₁₄	0.30 VOL%	0.0 ppm

Table 19: Interference Chart for ESR-A13i-H2S, H₂S Detection

Gas	Chemical Formula	Concentration	Indication Value
Nitrogen Dioxide	NO ₂	5.0 ppm	-0.4 ppm
Nitrogen Monoxide	NO	99.2 ppm	2.6 ppm
Nonane	n-C ₉ H ₂₀	0.18 VOL%	0.0 ppm
Ozone	O ₃	0.48 ppm	0.0 ppm
Phosphine	PH ₃	2.51 ppm	1.0 ppm
Propane	C ₃ H ₈	0.49 VOL%	0.0 ppm
Propylene	C ₃ H ₆	0.5 VOL%	-0.2 ppm
Sulfur Dioxide	SO ₂	25.0 ppm	0.0 ppm
Tetrahydrofuran	C ₄ H ₈ O	0.50 VOL%	-0.4 ppm
Toluene	C ₇ H ₈	1.0 VOL%	0.0 ppm
Xylene	C ₈ H ₁₀	0.25 VOL%	0.0 ppm

* *The indicated value may fluctuate when exposed to this gas.*

ESR-A13P-CO, CO Detection

Table 20: Interference Chart for ESR-A13P-CO, CO Detection

Gas	Chemical Formula	Concentration	Indication Value
Acetone	$(\text{CH}_3)_2\text{CO}$	5380 ppm	0 ppm
Acetylene	C_2H_2	99.6 ppm	50 ppm
Ammonia	NH_3	255 ppm	1 ppm
Arsine	AsH_3	1.1 ppm	4 ppm
Benzene	C_6H_6	0.3 VOL%	-1 ppm
Carbon Dioxide	CO_2	100 VOL%	8 ppm
Chlorine	Cl_2	0.8 ppm	0 ppm
Cyclopentane	C_5H_{10}	0.35 VOL%	0 ppm
Diborane	B_2H_6	5.25 ppm	2 ppm
Ethane	C_2H_6	0.75 VOL%	-1 ppm
Ethanol	$\text{CH}_3\text{CH}_2\text{OH}$	0.825 VOL%	2 ppm *
Ethyl Acetate	$\text{CH}_3\text{COOCH}_2\text{CH}_3$	0.525 VOL%	-1 ppm
Fluorine	F_2	1.6 ppm	-1 ppm
Germane	GeH_4	10.2 ppm	3 ppm
Hydrogen	H_2	100 ppm	11 ppm
Hydrogen Chloride	HCl	11.7 ppm	-1 ppm
Hydrogen Cyanide	HCN	1.8 ppm	-1 ppm
Hydrogen Selenide	H_2Se	1 ppm	1 ppm
Hydrogen Sulfide	H_2S	30 ppm	0 ppm
Isobutane	C_4H_{10}	0.45 VOL%	-1 ppm
Isobuten	$(\text{CH}_3)_2\text{C}=\text{CH}_2$	1000 ppm	2 ppm
Isopropyl Alcohol	$(\text{CH}_3)_2\text{CHOH}$	0.5 VOL%	-1 ppm
Methane	CH_4	1.25 VOL%	0 ppm
Methanol	CH_3OH	1000 ppm	3 ppm
Methyl Ethyl Ketone	$\text{C}_4\text{H}_8\text{O}$	0.45 VOL%	-1 ppm

Table 20: Interference Chart for ESR-A13P-CO, CO Detection

Gas	Chemical Formula	Concentration	Indication Value
Methyl Isobutyl Ketone	C ₆ H ₁₂ O	3000 ppm	-1 ppm
Methyl Methacrylate	C ₅ H ₈ O ₂	0.425 VOL%	0 ppm
n-Heptane	CH ₃ (CH ₂) ₅ CH ₃	0.275 VOL%	-1 ppm
n-Hexane	CH ₃ (CH ₂) ₄ CH ₃	0.3 VOL%	0 ppm
Nitrogen Dioxide	NO ₂	50.5 ppm	1 ppm
Nitrogen Monoxide	NO	99.2 ppm	53 ppm
Nonane	CH ₃ (CH ₂) ₇ CH ₃	0.175 VOL%	0 ppm
Ozone	O ₃	1.8 ppm	0 ppm
Phosphine	PH ₃	2.5 ppm	3 ppm
Propane	C ₃ H ₈	0.5 VOL%	0 ppm
Propylene	C ₃ H ₆	5000 ppm	16 ppm
Silane	SiH ₄	29.9 ppm	27 ppm
Sulfur Dioxide	SO ₂	30 ppm	0 ppm
Tetrahydrofuran	C ₄ H ₈ O	0.5 VOL%	0 ppm
Toluene	C ₆ H ₅ CH ₃	3000 ppm	0 ppm
Xylene	C ₆ H ₄ (CH ₃) ₂	2500 ppm	0 ppm

* The indicated value may fluctuate when exposed to this gas.

ESR-A1CP-COH, H₂-Compensated CO Detection

Table 21: Interference Chart for ESR-A1CP-COH, H₂-Compensated CO Detection

Gas	Chemical Formula	Concentration	Indication Value
Acetone	C ₃ H ₆ O	0.54 VOL%	1 ppm
Acetylene	C ₂ H ₂	100 ppm	109 ppm
Ammonia	NH ₃	38.6 ppm	0 ppm
Benzene	C ₆ H ₆	0.30 VOL%	0 ppm
Carbon Dioxide	CO ₂	20.0 VOL%	0 ppm
Chlorine	Cl ₂	2.0 ppm	-1 ppm
Cyclopentane	C ₅ H ₁₀	0.35 VOL%	1 ppm
Ethane	C ₂ H ₆	0.75 VOL%	0 ppm
Ethanol	C ₂ H ₅ OH	0.83 VOL%	4 ppm*
Ethyl Acetate	C ₄ H ₈ O ₂	0.53 VOL%	1 ppm
Fluorine	F ₂	1.6 ppm	-1 ppm
Hydrogen	H ₂	500 ppm	7 ppm
Hydrogen Bromide	HBr	9.0 ppm	0 ppm
Hydrogen Chloride	HCl	15.8 ppm	0 ppm
Hydrogen Sulfide	H ₂ S	24.2 ppm	0 ppm
Isobutane	i-C ₄ H ₁₀	0.45 VOL%	0 ppm
Isobuten	C ₄ H ₈ O	1000 ppm	3 ppm
Isopropyl Alcohol	C ₃ H ₈ O	0.50 VOL%	0 ppm
Nitrogen Monoxide	NO	99.2 ppm	53 ppm
Nitrogen Dioxide	NO ₂	50.5 ppm	0 ppm
Methane	CH ₄	1.26 VOL%	1 ppm
Methanol	CH ₃ OH	1.38 VOL%	131 ppm*
Methyl Ethyl Ketone	C ₄ H ₈ O	0.45 VOL%	0 ppm
Methyl Isobutyl Ketone	C ₆ H ₁₂ O	0.30 VOL%	0 ppm

Table 21: Interference Chart for ESR-A1CP-COH, H₂-Compensated CO Detection

Gas	Chemical Formula	Concentration	Indication Value
Methyl Methacrylate	C ₅ H ₈ O ₂	0.43 VOL%	1 ppm
n-Hexane	n-C ₆ H ₁₄	0.30 VOL%	1 ppm
Nonane	n-C ₉ H ₂₀	0.18 VOL%	0 ppm
Ozone	O ₃	0.48 ppm	0 ppm
Phosphine	PH ₃	2.51 ppm	3 ppm
Propane	C ₃ H ₈	0.49 VOL%	0 ppm
Propylene	C ₃ H ₆	0.50 VOL%	78 ppm*
Sulfur Dioxide	SO ₂	25.0 ppm	1 ppm
Tetrahydrofuran	C ₄ H ₈ O	0.50 VOL%	1 ppm
Toluene	C ₇ H ₈	0.30 VOL%	1 ppm
Xylene	C ₈ H ₁₀	0.25 VOL%	0 ppm

* The indicated value may fluctuate when exposed to this gas.

ESR-A1DP-COHS, CO Detection

Table 22: Interference Chart for ESR-A1DP-COHS, CO Detection

Gas	Chemical Formula	Concentration	Indication Value
Acetone	$(\text{CH}_3)_2\text{CO}$	0.538 VOL%	-1 ppm
Acetylene	C_2H_2	99.6 ppm	84 ppm
Ammonia	NH_3	255 ppm	2 ppm
Arsine	AsH_3	1.1 ppm	4 ppm
Benzene	C_6H_6	0.3 VOL%	-1 ppm
Carbon Dioxide	CO_2	100 VOL%	8 ppm
Chlorine	Cl_2	0.8 ppm	-1 ppm
Cyclopentane	C_5H_{10}	0.35 VOL%	0 ppm
Diborane	B_2H_6	5.25 ppm	2 ppm
Ethane	C_2H_6	0.75 VOL%	0 ppm
Ethanol	$\text{CH}_3\text{CH}_2\text{OH}$	0.825 VOL%	25 ppm *
Ethyl Acetate	$\text{CH}_3\text{COOCH}_2\text{CH}_3$	0.525 VOL%	9 ppm *
Fluorine	F_2	1.6 ppm	0 ppm
Germane	GeH_4	10.2 ppm	7 ppm
Hydrogen	H_2	100 ppm	17 ppm
Hydrogen Chloride	HCl	11.7 ppm	-1 ppm
Hydrogen Cyanide	HCN	1.8 ppm	-1 ppm
Hydrogen Selenide	H_2Se	1 ppm	2 ppm
Hydrogen Sulfide	H_2S	30 ppm	2 ppm
Isobutane	C_4H_{10}	0.45 VOL%	0 ppm
Isobuten	$(\text{CH}_3)_2\text{C}=\text{CH}_2$	1000 ppm	9 ppm
Isopropyl Alcohol	$(\text{CH}_3)_2\text{CHOH}$	0.5 VOL%	15 ppm *
Methane	CH_4	1.25 VOL%	-1 ppm
Methanol	CH_3OH	1000 ppm	10 ppm *
Methyl Ethyl Ketone	$\text{C}_4\text{H}_8\text{O}$	0.45 VOL%	-1 ppm

Table 22: Interference Chart for ESR-A1DP-COHS, CO Detection

Gas	Chemical Formula	Concentration	Indication Value
Methyl Isobutyl Ketone	C ₆ H ₁₂ O	0.3 VOL%	0 ppm
Methyl Methacrylate	C ₅ H ₈ O ₂	0.425 VOL%	2 ppm
n-Heptane	CH ₃ (CH ₂) ₅ CH ₃	0.275 VOL%	-1 ppm
n-Hexane	CH ₃ (CH ₂) ₄ CH ₃	0.3 VOL%	0 ppm
Nitrogen Dioxide	NO ₂	50.5 ppm	1 ppm
Nitrogen Monoxide	NO	99.2 ppm	38 ppm
Nonane	CH ₃ (CH ₂) ₇ CH ₃	0.175 VOL%	0 ppm
Ozone	O ₃	1.8 ppm	0 ppm
Phosphine	PH ₃	2.5 ppm	3 ppm
Propane	C ₃ H ₈	0.5 VOL%	0 ppm
Propylene	C ₃ H ₆	0.5 VOL%	42 ppm *
Silane	SiH ₄	29.9 ppm	46 ppm
Sulfur Dioxide	SO ₂	30 ppm	3 ppm
Tetrahydrofuran	C ₄ H ₈ O	0.5 VOL%	21 ppm
Toluene	C ₆ H ₅ CH ₃	0.3 VOL%	0 ppm
Xylene	C ₆ H ₄ (CH ₃) ₂	0.25 VOL%	0 ppm

* The indicated value may fluctuate when exposed to this gas.

ESR-A1DP-COHS, H₂S Detection

Table 23: Interference Chart for ESR-A1DP-COHS, H₂S Detection

Gas	Chemical Formula	Concentration	Indication Value
Acetone	CH ₃ COCH ₃	0.538 VOL%	-0.1 ppm
Acetylene	C ₂ H ₂	99.6 ppm	-0.1 ppm
Ammonia	NH ₃	250 ppm	-0.1 ppm
Arsine	AsH ₃	1.1 ppm	0.5 ppm
Benzene	C ₆ H ₆	0.3 VOL%	-0.1 ppm

Table 23: Interference Chart for ESR-A1DP-COHS, H₂S Detection

Gas	Chemical Formula	Concentration	Indication Value
Carbon Dioxide	CO ₂	100 VOL%	-0.1 ppm
Carbon Monoxide	CO	1000 ppm	2.6 ppm
Chlorine	Cl ₂	0.8 ppm	-0.1 ppm
Cyclopentane	C ₅ H ₁₀	0.35 VOL%	-0.1 ppm
Diborane	B ₂ H ₆	5.25 ppm	0.2 ppm
Ethane	C ₂ H ₆	0.75 VOL%	0.0 ppm
Ethanol	CH ₃ CH ₂ OH	0.825 VOL%	0.5 ppm
Ethyl Acetate	CH ₃ COOH ₂ CH ₃	0.525 VOL%	-0.1 ppm
Fluorine	F ₂	1.6 ppm	-0.1 ppm
Germene	GeH ₄	10.2 ppm	0.3 ppm
Hydrogen	H ₂	2000 ppm	1.3 ppm
Hydrogen Chloride	HCl	11.7 ppm	-0.2 ppm
Hydrogen Cyanide	HCN	1.8 ppm	0.0 ppm
Hydrogen Selenide	H ₂ Se	1 ppm	0.3 ppm
Isobutane	C ₄ H ₁₀	0.45 VOL%	-0.1 ppm
Isobuten	CH ₂ CH(CH ₃) ₂	1000 ppm	0.1 ppm
Isopropyl Alcohol	CH ₃ C(OH)CH ₃	0.5 VOL%	0.0 ppm
Methane	CH ₄	1.25 VOL%	-0.1 ppm
Methanol	CH ₃ OH	1.375 VOL%	0.5 ppm
Methyl Ethyl Ketone	C ₄ H ₈ O	0.45 VOL%	0.3 ppm
Methyl Isobutyl Ketone	C ₆ H ₁₂ O	0.3 VOL%	-0.1 ppm
Methyl Methacrylate	C ₅ H ₈ O ₂	0.425 VOL%	-0.1 ppm
n-Heptane	CH ₃ (CH ₂) ₅ CH ₃	0.275 VOL%	-0.1 ppm
n-Hexane	CH ₃ (CH ₂) ₄ CH ₃	0.3 VOL%	-0.1 ppm
Nitrogen Dioxide	NO ₂	50.5 ppm	-4.6 ppm
Nitrogen Monoxide	NO	99.2 ppm	6.0 ppm

Table 23: Interference Chart for ESR-A1DP-COHS, H₂S Detection

Gas	Chemical Formula	Concentration	Indication Value
Nonane	CH ₃ (CH ₂) ₇ CH ₃	0.175 VOL%	0.2 ppm
Ozone	O ₃	1.8 ppm	-0.1 ppm
Phosphine	PH ₃	2.5 ppm	1.5 ppm
Propane	C ₃ H ₈	0.5 VOL%	-0.1 ppm
Propylene	C ₃ H ₆	0.5 VOL%	-0.1 ppm
Silane	SiH ₄	29.9 ppm	0.6 ppm
Sulfur Dioxide	SO ₂	30 ppm	-0.1 ppm
Tetrahydrofuran	C ₄ H ₈ O	0.5 VOL%	0.1 ppm
Toluene	C ₆ H ₅ CH ₃	0.3 VOL%	-0.1 ppm
Xylene	C ₆ H ₅ (CH ₃) ₂	0.25 VOL%	-0.1 ppm

Appendix E: Using the GX-6100 in Inert Mode

Inert Mode is used to measure the combustible gas and/or oxygen level in a purged environment. In order for the instrument to operate in Inert Mode, the oxygen alarm must be set to H-HH operation meaning that both alarms are increasing. The oxygen Low Alarm High Alarm points are factory set at 5.0% and 10.0%.

It is recommended that an IR CH₄ or IR HC sensor be installed if the instrument is going to be used in Inert Mode since these sensors do not require oxygen to work properly. The catalytic LEL sensor does not operate at oxygen concentrations below 10% volume. If it is necessary to use the catalytic LEL sensor while operating in Inert Mode, a dilution fitting must be installed. Installing a dilution fitting will affect the oxygen reading since you're introducing oxygen into the sample.

NOTE: **Inert** must be selected in the Mode selection section of the GX-6100 Configuration Program for Inert Mode to be an option in the Mode Select screen at startup.

Alarms

The oxygen channel alarm points in Inert Mode are different from those in Normal Mode. All other alarm points settings remain unchanged.

Since the application for Inert Mode is to detect a rising oxygen level in purged environments, both oxygen alarms are rising in Inert Mode. The factory set alarm points for Inert Mode are 5.0% (Alarm 1) and 10.0% (Alarm 2 and Alarm 3). These Inert Mode alarm points are user adjustable in User Mode.

1. Follow the steps described on page 106 to change the alarm points for Inert Mode. The only difference between what's described in that section and what the screen will look like is that **INERT** will be an option in the Alarm Points menu if Inert is selected in the Mode selection section of the GX-6100 Configuration Program.

NOTE: If Inert is deselected in the Mode Selection section of the GX-6100 Configuration Program, the **INERT** item will not appear in the Alarm Points Menu.

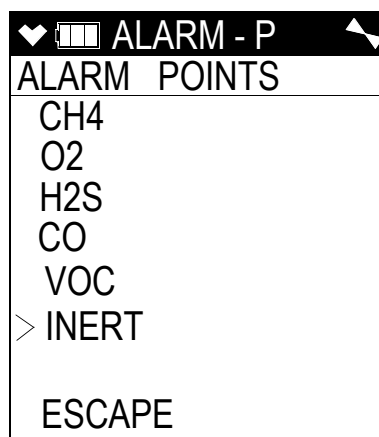

2. Select **INERT** (not **O2**) in order to view or change Inert Mode's oxygen alarm points.

Start Up and Operation

1. Connect the tapered rubber nozzle or the sample hose and probe to the GX-6100's quick connect inlet fitting.
2. Press and briefly hold down the POWER/ENTER button. Release the button when you hear a beep.
3. The Mode Select screen displays. Use the ▲ AIR or SHIFT ▼ (PANIC) button to scroll to the **INERT MODE** menu item.

NOTE: Inert must be selected in the Mode Selection section of the GX-6100 Configuration Program for Inert Mode to be an option in the Mode Select screen at startup. See the *GX-6100 Configuration Program Operator's Manual*.

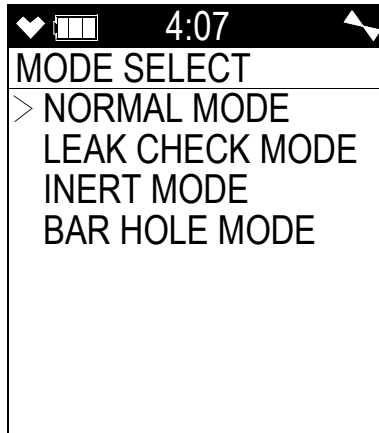

4. Press and release the POWER/ENTER button to begin the Inert Mode startup sequence.

NOTE: If no button is pressed for 20 seconds, the unit will proceed into whichever mode is displayed.

5. The warm-up will proceed as described in “Turning On the GX-6100” on page 28.

6. Once the warm-up sequence has finished, the instrument will be operating in Inert Mode. Since the oxygen concentration in fresh air is above both Inert Mode oxygen alarm points, the GX-6100 will go into alarm if turned on in a fresh air environment.

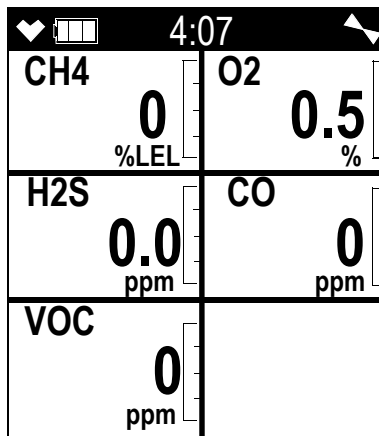

7. If you wish to change operating modes by returning to the Mode Select screen, press and hold the ▲ AIR and DISP/LOCK buttons for 5 seconds.

Appendix F: ESS-03 Toxic Sensors

Overview

The ESS-03 sensors are used to monitor levels of a variety of toxic gases. This appendix describes the GX-6100's ESS-03 sensors. It also includes instructions to replace an ESS-03 sensor. Table 24 below lists the available ESS-03 sensors.

Table 24: ESS-03 Sensor Specifications

Target Gas	Detection Range	Reading Increment	Alarm 1 Factory Setting	Alarm 2 Factory Setting	Alarm 3 Factory Setting	STEL	TWA	Response Time
Ammonia (NH ₃)	0 - 400 ppm	0.5 ppm	25 ppm	50 ppm	50 ppm	35 ppm	25 ppm	T90 in 30 sec.
Chlorine (Cl ₂)	0 - 10.0 ppm	0.05 ppm	0.50 ppm	1.00 ppm	1.00 ppm	1.00 ppm	0.50 ppm	
Hydrogen Cyanide (HCN)	0 - 15.0 ppm	0.1 ppm	5.00 ppm	10.0 ppm	10.0 ppm	4.7 ppm	N/A	
Nitrogen Dioxide (NO ₂)	0 - 20.00 ppm	0.05 ppm	3.00 ppm	6.00 ppm	6.00 ppm	N/A	3.00 ppm	
Phosphine (PH ₃)	0 - 20.00 ppm	0.01 ppm	0.30 ppm	1.0 ppm	1.0 ppm	1.0 ppm	0.3 ppm	
Sulfur Dioxide (SO ₂)	0 - 99.90 ppm	0.05 ppm	2.00 ppm	5.00 ppm	5.00 ppm	5.00 ppm	2.00 ppm	

NOTE: If you are attempting to detect chlorine, be sure the hose/probe does not have a particle filter installed. Also be sure that the hose is not longer than 30 feet.

Description

The ESS-03 is a smart sensor that stores sensor parameters including the target gas, detection range, alarm points, and calibration settings in its memory. So a sensor can be calibrated at the factory and shipped as a replacement sensor without the need to calibrate the sensor when it is installed as long as it is installed during the sensor's valid calibration period which is typically 3 months. In addition, you can change an existing ESS-03 channel from one type of ESS-03 sensor to another and the GX-6100 will automatically load all the sensor parameters and configure the ESS-03 channel for the new sensor. See page 201 for instructions to replace or change an ESS-03 sensor.

The ESS-03 sensor is a cylindrical sensor with a diffusion opening on the front and a connector on the back. The ESS-03 sensor is installed in one of the two smart sensor sockets and is held in place by the sensor gasket and the flow chamber.

Interference

Although the GX-6100 can support up to two ESS-03 sensors, many combinations are impractical for various reasons including sensor cross sensitivity to other gases.

The table below indicates some of the gases that can increase or decrease the target gas reading for the affected sensor. For example, if you are attempting to detect HCN but H₂ is also present, the instrument's HCN reading will be higher than the environment's actual HCN level.

Table 25: Sensor Interference List

Sensor	Affected By	Gas Concentration	Interference
Ammonia (NH ₃)	Chlorine (Cl ₂)	0.8 ppm	-1.4 ppm
	Hydrogen Cyanide (HCN)	7.8 ppm	-1.3 ppm
	Hydrogen Sulfide (H ₂ S)	100 ppm	-32 ppm
	Nitrogen Dioxide (NO ₂)	9 ppm	-5.7 ppm
	Sulfur Dioxide (SO ₂)	6 ppm	-3.5 ppm
Hydrogen Cyanide (HCN)	Carbon Monoxide (CO)	500 ppm	+1.1 ppm
	Chlorine (Cl ₂)	2 ppm	-2.0 ppm
	Hydrogen (H ₂)	2000 ppm	+4.7 ppm
	Hydrogen Sulfide (H ₂ S)	100 ppm	+225 ppm
	Ammonia (NH ₃)	75 ppm	+0.3 ppm
	Nitrogen Dioxide (NO ₂)	9 ppm	-20.8 ppm
	Phosphine (PH ₃)	0.5 ppm	+4.9 ppm
	Sulfur Dioxide (SO ₂)	6 ppm	+11.4 ppm
Nitrogen Oxide (NO ₂)	Carbon Monoxide (CO)	500 ppm	-2.0 ppm
	Hydrogen (H ₂)	2000 ppm	-0.3 ppm
	Sulfur Dioxide (SO ₂)	6 ppm	-3.8 ppm

Table 25: Sensor Interference List

Sensor	Affected By	Gas Concentration	Interference
Phosphine (PH ₃)	Carbon Monoxide (CO)	500 ppm	+0.12 ppm
	Chlorine (Cl ₂)	2 ppm	-1.4 ppm
	Hydrogen (H ₂)	2000 ppm	-0.3 ppm
	Hydrogen Sulfide (H ₂ S)	100 ppm	+25.4 ppm
	Ammonia (NH ₃)	75 ppm	+0.03 ppm
	Sulfur Dioxide (SO ₂)	6 ppm	+1.29 ppm
Sulfur Dioxide (SO ₂)	Carbon Monoxide (CO)	500 ppm	+2.3 ppm
	Hydrogen (H ₂)	2000 ppm	+3.4 ppm
	Nitrogen Dioxide (NO ₂)	9 ppm	-10.4 ppm

Start Up and Normal Operation

For instructions to startup and use a GX-6100 that includes an ESS-03 sensor, reference “Start Up” on page 28, “Measuring Mode, Normal Operation” on page 37, and “Measuring Mode, Alarms” on page 46. Follow these instructions keeping the following special considerations in mind:

- Some of the gases that are monitored with an ESS-03 may be absorbed in small amounts in the longer GX-6100 sample hoses. When detecting gases other than chlorine, do not use sample hoses that are longer than 50 feet without consulting RKI Instruments, Inc. When detecting chlorine, do not use sample hoses that are longer than 30 feet. If using a hose and probe to monitor toxic gases, be sure to calibrate the ESS-03 sensor with the hose and probe attached so that the calibration reflects any absorption that may be occurring.
- If you are attempting to detect chlorine, be sure the hose/probe does not have a particle filter installed.
- If your GX-6100 has more than one ESS-03 sensor installed, it is possible that both sensors will respond to some of the same gases at varying levels. Make sure you understand any issues like this that may exist in your particular instrument.
- The SO₂ and HCN ESS-03 sensors include an H₂S scrubber disk inside the sensor face. The H₂S scrubber disk prevents false SO₂ and HCN readings by removing any H₂S that would cause a response on the SO₂ and HCN sensors.
- If your GX-6100 has both an NH₃ and a CO₂ sensor installed, you will need to follow the instructions on page 212 to perform a demand zero instead of those in “Start Up” on page 28.

ESS-03 Calibration

NOTE: ESS-03 calibration must be done with the hose and probe attached. If you are calibrating a chlorine sensor, be sure the hose/probe does not have a particle filter installed.

See “Performing a Span Adjustment” on page 93 or “Setting Calibration Concentration Values (SETTING CAL-P)” on page 100 for instructions to perform a calibration.

See “Calibration Supplies and Equipment” on page 87 for a description of the necessary calibration supplies. See Table 27 on page 205 for available cylinders. Make sure your calibration cylinder is appropriate for the ESS-03 detection range.

NOTE: RKI Instruments, Inc. recommends that you dedicate a regulator for use with chlorine (Cl_2) gas and that you do not use that dedicated regulator for any other gases, particularly hydrogen sulfide (H_2S).

NOTE: Be sure to calibrate the ESS-03 sensor with the hose and probe attached.

NOTE: If your instrument has both an NH_3 sensor and a CO_2 sensor installed, follow the instructions on page 212 to perform a demand zero.

Keep the following items in mind when calibrating with alternate gases.

1. When you review the span calibration values, confirm that the ESS-03’s span calibration gas value matches the calibration cylinder.
 - a. If you need to change an HCN channel’s span calibration value, the procedure is slightly different since PH_3 can be used to calibrate the HCN channel. When you move the cursor to HCN in the Concentration screen and then press and release the POWER/ENTER button, the Alternative Gas screen will appear. The HCN concentration will be flashing.

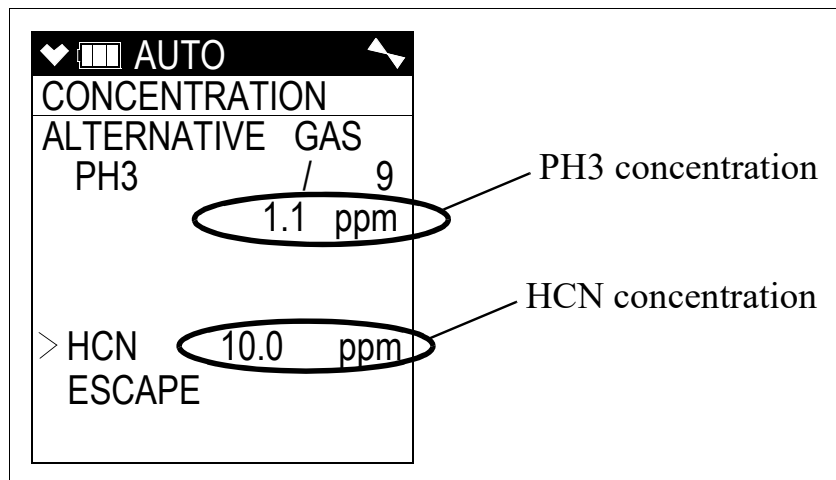

- b. Use the ▲ AIR and SHIFT ▼ (PANIC) buttons to change the HCN concentration. As the HCN concentration changes, the PH₃ concentration will also change. If you are using HCN to calibrate the HCN sensor, adjust the HCN concentration until it matches the concentration listed on your cylinder. If you are using PH₃ to calibrate the HCN sensor, adjust the HCN concentration until the PH₃ concentration matches the concentration listed on your cylinder.
2. If you are calibrating an HCN sensor, an Alternative Gas screen will appear. The HCN sensor can be calibrated using HCN or PH₃. This screen allows you to select which gas you want to use.

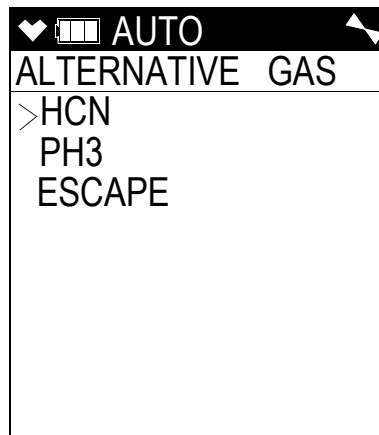

3. Use the ▲ AIR and SHIFT ▼ (PANIC) buttons to move the cursor in front of the gas you will use for calibration then press and release the POWER/ENTER button.

ESS-03 Bump Testing

See “Performing a Bump Test” on page 80 for instructions to perform a bump test.

NOTE: RKI Instruments, Inc. recommends that you dedicate a regulator for use with chlorine (Cl₂) gas and that you do not use that dedicated regulator for any other gases, particularly hydrogen sulfide (H₂S).

NOTE: RKI Instruments, Inc. recommends a bump test **GAS TIME** of **60** seconds for instruments with Cl₂ or NH₃.

Replacing the ESS-03 Sensor or Changing Sensor Type

When replacing a sensor, you may either replace it with another of the same sensor or you may install a different ESS-03 sensor. If a different one is installed, the GX-6100 will load the sensor parameters and configure the ESS-03 channel for the new sensor.

1. Follow the instructions listed on page 134 keeping the following exception in mind:

- A bias board is attached to the bottom of replacement ESS-03 sensors and must be removed before installing the sensor in the GX-6100. Properly dispose of the bias board once the sensor has been installed.

Be sure that the new sensor is installed in the same position as the old sensor and that the following sensor priority for the smart sensor 1 position is maintained.

Table 26: Priority for Smart Sensor 1 Position

High Priority ↓ Low Priority	10.6 eV low range PID
	10.0 eV/benzene PID
	11.7 eV PID
	10.6 eV high range PID
	ESS-03 Cl ₂
	MOS sensors
	ESS-03 NH ₃
	IR and other ESS-03 sensors

For example, if your instrument is a 4-gas + ESS-03 Cl₂ + ESS-03 NH₃, the Cl₂ sensor should be in the smart sensor 1 position and the NH₃ sensor should be in the smart sensor 2 position. If your instrument is a 4-gas + ESS-03 NH₃, the NH₃ sensor should be in the smart sensor 1 position and a dummy sensor should be installed in the smart sensor 2 position. See the figure below for the location of the smart sensor 1 and 2 positions.

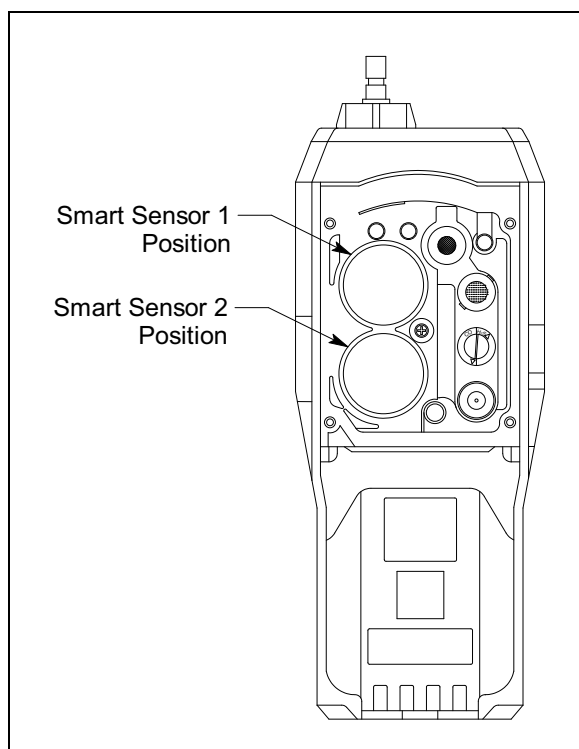

Figure 42: Smart Sensor Positions

Replacing the HCN or SO₂ Sensor's Filter Set

The H₂S-scrubbing filters installed over the HCN and SO₂ sensors' face are designed to last for 960 minutes of exposure to 25 ppm H₂S. This equates to roughly 6 years of 30 second bump tests if the instrument does not see H₂S during normal operation.

The filter should last the life of the sensor. However, if you notice the HCN or SO₂ channel responding to the presence of H₂S, you should replace the filters.

Materials

- Filter set for HCN (1 each 33-0176 and 33-7126)
- Filter set for SO₂ (1 each 33-0176 and 33-7135)
- Rubber gloves (do not touch the replacement filter set with bare hands)
- Stainless steel tweezers

Procedure

1. Verify that the GX-6100 is off.
2. Use a small Phillips screwdriver to unscrew the four screws holding the flow chamber to the rest of the GX-6100's case.
3. Grasp the sides of the flow chamber and lift it away from the rest of the case. The screws are captive screws and will not come out of the flow chamber.
4. Gently pull up the edges of the sensor gasket to loosen it from its connections. Be sure not to lose any of the filters that are in it. The sensors will be exposed.
5. Remove the HCN or SO₂ sensor from its socket.
6. Use tweezers to remove the Teflon filter and H₂S scrubber from the HCN or SO₂ sensor's face.

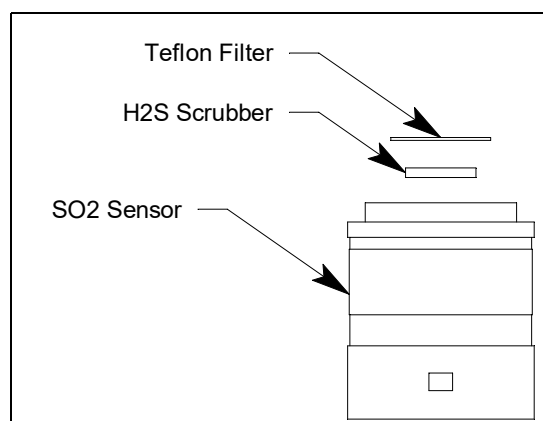

Figure 43: HCN and SO₂ Sensors' Filters

7. Be sure any filter material is completely removed from the sensor face.
8. Place the new H₂S filter in the sensor face's recess.

9. Peel the protective paper off of the Teflon filter.
10. Place the Teflon filter over the H₂S scrubber.
11. Gently press down on the Teflon filter. Be careful not to tear the filter.
12. Put the HCN or SO₂ sensor back into its socket.
13. Place the sensor gasket and filters back over the sensors ensuring that the sensor gasket seals with the sensors and the flow fittings. The flow fitting connections need to be facing up and cannot be skewed sideways. The gasket must be pushed down in the center and secured under the gasket aligning tabs.

NOTE: Failure to install the sensor gasket appropriately may result in inaccurate gas readings.

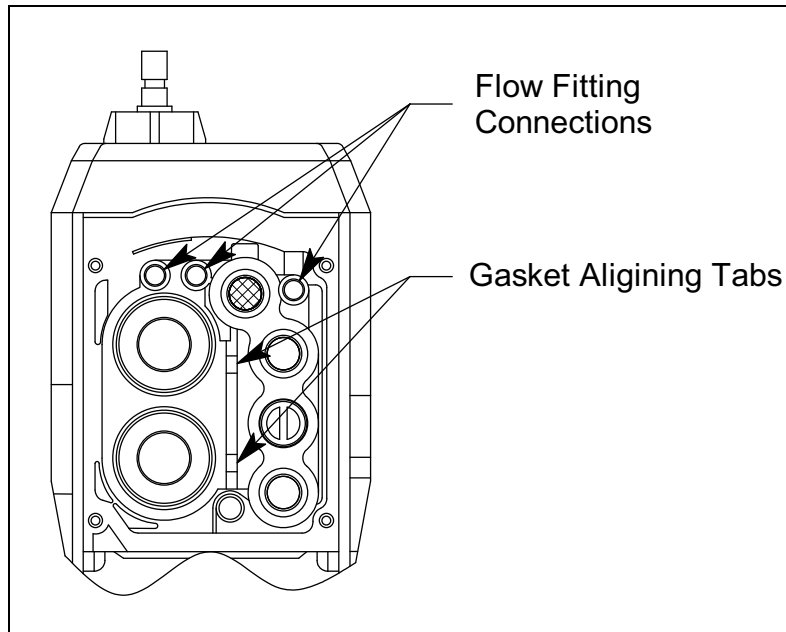

Figure 44: Sensor Gasket Seating

14. Insert the flow chamber back into the instrument.
15. Tighten the flow chamber's four screws that were loosened in Step 2.
16. Start up the GX-6100 by pressing and briefly holding the POWER/ENTER button.
17. To verify that the sensor gasket was inserted properly:
 - a. Plug the inlet with your finger.
 - b. Verify that the GX-6100 goes into low flow alarm. If the GX-6100 does not go into low flow alarm, turn the instrument off and attempt to seat the sensor gasket again.

Parts List

Table 27: ESS-03 GX-6100 Parts List

Part Number	Description
33-0176	Teflon filter for HCN and SO ₂ sensor (need to replace 33-0176 and 33-7126 [for SO ₂ sensor] or 33-0176 and 33-7135 [for HCN sensor] at the same time)
33-6092	VOC zero filter, charcoal with tubing stubs and plugs
33-7126	H ₂ S scrubber disk for HCN sensor (need to replace 33-0176 and 33-7126 at the same time)
33-7135	H ₂ S scrubber disk for SO ₂ sensor (need to replace 33-0176 and 33-7135 at the same time)
33-7135-05	H ₂ S scrubber disk for SO ₂ sensor, pack of 5 (need to replace 33-0176 and 33-7135 at the same time)
80-0006-XXP	Sample hose with integral probe, with hydrophobic filter and particle filter, no scrubber section. For use with NH₃, HCN, NO₂, PH₃, and SO₂ sensors. Replace “XX” with length in feet. 3 foot hose is standard. Available lengths for the GX-6100 are 3, 5, 10, 15, 20, 25, 30, 35, 40, 45, and 50 feet.
80-0006-XXP-01	Sample hose with integral probe, no particle filter, no scrubber section. For use with Cl₂ sensor. Replace “XX” with length in feet. 3 foot hose is standard. Available lengths for the GX-6100 are 3, 5, 10, 15, 20, 25, and 30 feet.
80-0172	Probe, with hydrophobic filter and particle filter, no scrubber section. For use with NH₃, HCN, NO₂, PH₃, and SO₂ sensors.
80-0172-01	Probe, with hydrophobic filter, no particle filter, no scrubber section. For use with Cl₂ sensor.
81-0142RK-02	Calibration cylinder, 5-gas (SO ₂ , CH ₄ , O ₂ , H ₂ S, CO), 58 liter
81-0142RK-04	Calibration cylinder, 5-gas (SO ₂ , CH ₄ , O ₂ , H ₂ S, CO), 34 liter aluminum
81-0170RK-02	Calibration cylinder, 5 ppm SO ₂ in nitrogen, 58 liter
81-0170RK-04	Calibration cylinder, 5 ppm SO ₂ in nitrogen, 34 liter aluminum
81-0176RK-02	Calibration cylinder, 25 ppm NH ₃ in nitrogen, 58 liter
81-0176RK-04	Calibration cylinder, 25 ppm NH ₃ in nitrogen, 34 liter aluminum
81-0182RK-02	Calibration cylinder, 5 ppm NO ₂ in air, 58 liter
81-0182RK-04	Calibration cylinder, 5 ppm NO ₂ in air, 34 liter aluminum
81-0185RK-02	Calibration cylinder, 0.5 ppm PH ₃ in nitrogen, 58 liter
81-0185RK-04	Calibration cylinder, 0.5 ppm PH ₃ in nitrogen, 34 liter aluminum

Part Number	Description
81-0190RK-02	Calibration cylinder, 5 ppm Cl ₂ in nitrogen, 58 liter
81-0190RK-04	Calibration cylinder, 5 ppm Cl ₂ in nitrogen, 34 liter aluminum
81-0196RK-02	Calibration cylinder, 10 ppm HCN in nitrogen, 58 liter
81-0196RK-04	Calibration cylinder, 10 ppm HCN in nitrogen, 34 liter
81-1054RK	Regulator, demand-flow type, for Cl ₂ , HCN, and NH ₃ in 34-liter aluminum, 58-liter, and 103-liter calibration cylinders (cylinders with internal threads)
81-1054RK-H2S	Regulator, demand-flow type, for CO, CO ₂ , H ₂ S, N ₂ , NO ₂ , PH ₃ , SO ₂ , zero air, and combustible gases in 34-liter aluminum, 58-liter, and 103-liter calibration cylinders (cylinders with internal threads)
81-1055RK	Regulator, demand-flow type, for all gases in 17- and 34-liter steel cylinders (cylinders with external threads)
ESS-03DH-HCN	Hydrogen cyanide sensor, 0 - 15.0 ppm
ESS-03DH-NO2	Nitrogen dioxide sensor, 0 - 20.00 ppm
ESS-03DH-PH3	Phosphine sensor, 0 - 20.00 ppm
ESS-03DH-SO2	Sulfur dioxide sensor, 0 - 99.90 ppm
ESS-B332-NH3	Ammonia sensor, 0 - 400 ppm
ESS-B335-CL2	Chlorine sensor, 0 - 10.0 ppm

Appendix G: Infrared Sensors

Overview

The infrared sensors are used to monitor levels of methane, combustible gas, and carbon dioxide. This appendix describes the GX-6100's infrared sensors and includes instructions to use a GX-6100 that has one or more infrared sensors installed. It also includes instructions to replace an infrared sensor. The table below lists the available infrared sensors along with their specifications.

Table 28: Infrared Sensor Specifications

Sensor	Range	Reading Increment	Alarm 1	Alarm 2	Alarm 3	STEL	TWA
IR CO ₂	0 - 10.00% vol	0.02% vol	0.50% vol	3.00% vol	3.00% vol	3.00% vol	0.50% vol
	0 - 10,000 ppm	20 ppm	5,000 ppm	N/A	N/A	N/A	5,000 ppm
IR HC %LEL	0 - 100% LEL	1% LEL	10% LEL	50% LEL	50% LEL	N/A	N/A
IR HC Auto-ranging	0 - 100% LEL	1% LEL	10% LEL	50% LEL	50% LEL	N/A	N/A
	2.0 - 30.0% vol	0.5% vol	N/A	N/A	N/A	N/A	N/A
IR CH ₄ %LEL	0 - 100% LEL	1% LEL	10% LEL	50% LEL	50% LEL	N/A	N/A
IR CH ₄ Auto-ranging	0 - 100% LEL	1% LEL	10% LEL	50% LEL	50% LEL	N/A	N/A
	5.0 - 100% vol	0.5% vol	N/A	N/A	N/A	N/A	N/A

IR HC Target Gases

The infrared HC sensor is a general hydrocarbon sensor. It is setup for and factory-calibrated to isobutane.

The infrared HC sensor is known to **not** or to poorly respond to the following combustible gases:

- acetylene
- benzene
- hydrogen

IR CH₄ Target Gases

The infrared methane sensor is setup for and factory-calibrated to methane. There are other gases that the sensor will still detect and respond to. There are also gases that the methane sensor will not detect or respond to. Lists of the gases falling in each of these respective categories can be found below. Consult RKI Instruments, Inc. for combustible gases not listed below.

The infrared methane sensor is known to respond to the following combustible gases:

- acetone
- ethane

- ethanol
- hexane
- IPA
- isobutane
- MEK
- methanol
- propane
- styrene
- toluene

The infrared methane sensor is known to **not** or to poorly respond to the following combustible gases:

- acetylene
- benzene
- hydrogen

Description

IR Sensor

The IR sensor is a smart sensor that stores sensor parameters including the target gas, detection range, alarm points, and calibration settings in its memory. So a sensor can be calibrated at the factory and shipped as a replacement sensor without the need to calibrate the sensor when it is installed as long as it is installed during the sensor's valid calibration period which is typically 6 months. In addition, you can change an existing IR channel from one type of IR sensor to another and the GX-6100 will automatically load all the sensor parameters and configure the IR channel for the new sensor. See "Replacing an IR Sensor" on page 213 for instructions to replace or change an IR sensor.

The IR sensor is a cylindrical sensor with a diffusion opening on the front and a connector on the back. The IR sensor is installed in one of the two smart sensor sockets and is held in place by the sensor gasket and the flow chamber.

CO₂ Scrubber

A carbon dioxide scrubber is factory-shipped with GX-6100s that have an IR CO₂ sensor installed.

The scrubber is for use when setting the carbon dioxide sensor's zero reading only. A single piece of tubing connects both ends of the scrubber when not in use. To prolong the life of the scrubber, be sure the tubing is connected to both ends of the scrubber while the scrubber is not in use or while it is being stored. Replace the scrubber when you notice the pellets in the scrubber tube beginning to break down into powder.

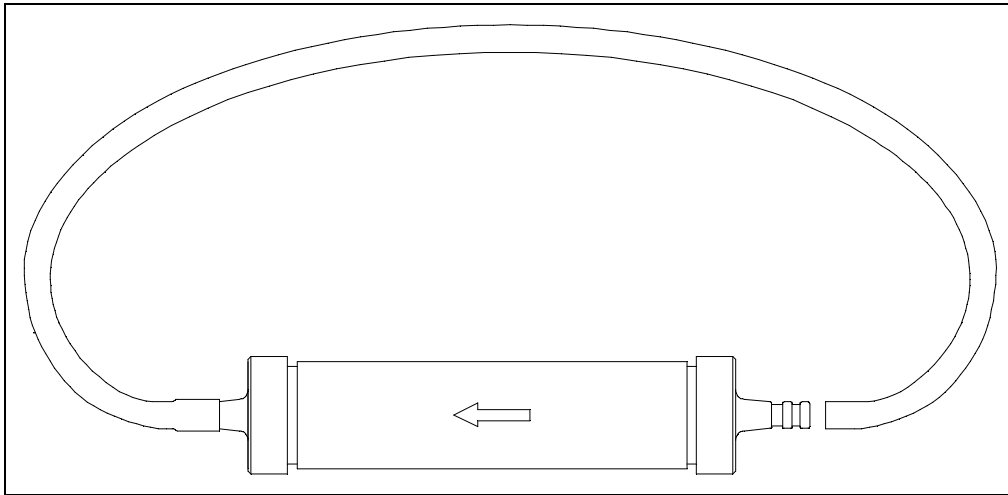

Figure 45: Carbon Dioxide Scrubber

VOC Zero Filter

If your instrument has an IR CO₂ sensor and a PID or an NH₃ sensor installed, a VOC zero filter is included as standard. The VOC zero filter scrubs out low levels of VOC gases using charcoal. Use the VOC zero filter when performing a fresh air adjustment on the instrument.

The filter comes with a tubing stub and plug on each end. Both plugs must be removed before using the filter and must be reinstalled for storage. The filter does not have a preferred flow direction.

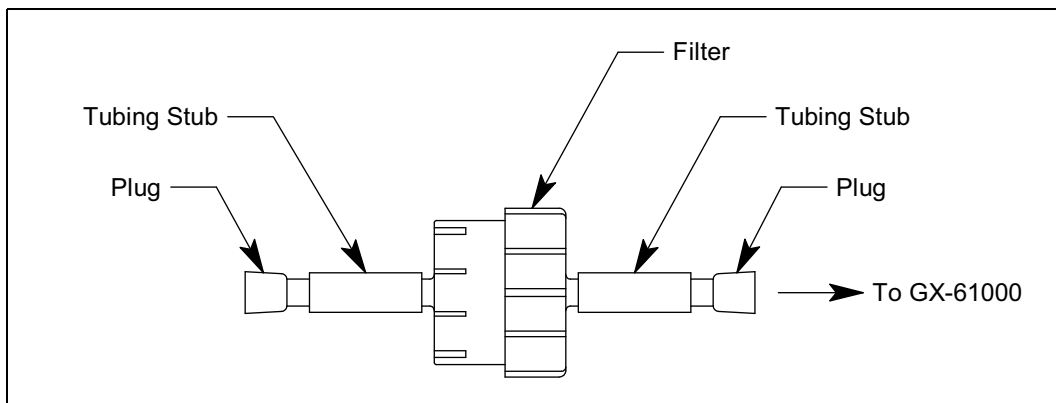

Figure 46: VOC Zero Filter

IR HC Start Up and Normal Operation

For instructions to startup and use a GX-6100 that includes an infrared hydrocarbon sensor, reference “Start Up” on page 28, “Measuring Mode, Normal Operation” on page 37, and “Measuring Mode, Alarms” on page 46.

0-100% LEL/2.0-30.0% vol Autoranging

The infrared hydrocarbon sensor can be factory set to detect gas in a 0-100% LEL configuration or an autoranging configuration. The autoranging configuration detects gas on a 0-100% LEL and a 2.0-30.0% vol scale. The gas reading will be displayed in %LEL until the gas level reaches 100% LEL, or 2.0% vol for isobutane. Once the gas reading is above 100% LEL, it is displayed in %VOL. Alarm points exist for the %LEL range but do not exist for the %vol range. If %LEL range alarms are not silenced (see page 109 for a description of the alarm silence feature) and the gas level increases to %VOL levels, the alarms will continue to sound but no new alarms will occur.

- If a CO sensor is installed and its charcoal filter becomes saturated, the presence of hydrocarbons may produce a reading on the CO channel.
- If a PID sensor is installed in your instrument, the presence of hydrocarbons that the IR HC sensor is intended to detect may produce upscale readings on the PID channel.

IR CH₄ Start Up and Normal Operation

For instructions to startup and use a GX-6100 that includes an infrared methane sensor, reference “Start Up” on page 28, “Measuring Mode, Normal Operation” on page 37, and “Measuring Mode, Alarms” on page 46.

0 - 100% LEL/5.0 - 100.0% vol Autoranging

The infrared methane sensor can be factory set to detect gas in a 0-100% LEL configuration or an autoranging configuration. The autoranging configuration detects gas on a 0-100% LEL and a 5.0-100.0% vol scale. The gas reading will be displayed in %LEL until the gas level reaches 100% LEL, or 5.0% vol for methane. Once the gas reading is above 100% LEL, it is displayed in %VOL. Alarm points exist for the %LEL range but do not exist for the %VOL range. If %LEL range alarms are not silenced (see page 109 for a description of the alarm silence feature) and the gas level increases to %VOL levels, the alarms will continue to sound but no new alarms will occur.

- If a PID sensor is installed in your instrument and concentrations of methane greater than 100% LEL are present in the monitoring environment, the PID channel’s reading will be suppressed.

IR CO₂ Start Up and Normal Operation

For instructions to startup and use a GX-6100 that includes an infrared CO₂ sensor, reference “Start Up” on page 28, “Measuring Mode, Normal Operation” on page 37, and “Measuring Mode, Alarms” on page 46. Follow these instructions keeping the following special considerations in mind:

- A background level of CO₂ exists in fresh air. Table 29 below indicates a typical gas reading in fresh air.

Table 29: Carbon Dioxide Fresh Air Readings

Sensor Range	Approximate Fresh Air Reading
0 - 10% vol	0.04% vol
0 - 10,000 ppm	400 ppm

- When you perform a demand zero during start up, operation, or calibration, you must use the CO₂ scrubber provided with the instrument to remove background CO₂ from the air being sampled. See Performing a Demand Zero for Carbon Dioxide Sensors below.

If you have a PID sensor or an NH₃ sensor in your instrument, see “Performing a Demand Zero for Instruments with a CO₂ and PID or NH₃ Sensor” on page 212.

- Since there is a background of CO₂ in air, do not use the Auto Fresh Air Adj feature that can be turned on and off in the GX-6100 Configuration Program. The factory setting for the feature is **OFF**.

Performing a Demand Zero for Carbon Dioxide Sensors

When setting the zero reading, the carbon dioxide scrubber shipped with the GX-6100 allows you to eliminate carbon dioxide normally found in fresh air. To perform a demand zero, do the following:

1. Remove the tubing from the side of the scrubber that does not have an arrow pointing to it.
2. Connect the tubing to the GX-6100’s inlet fitting. Be sure the arrow on the filter is pointing toward the inlet fitting.

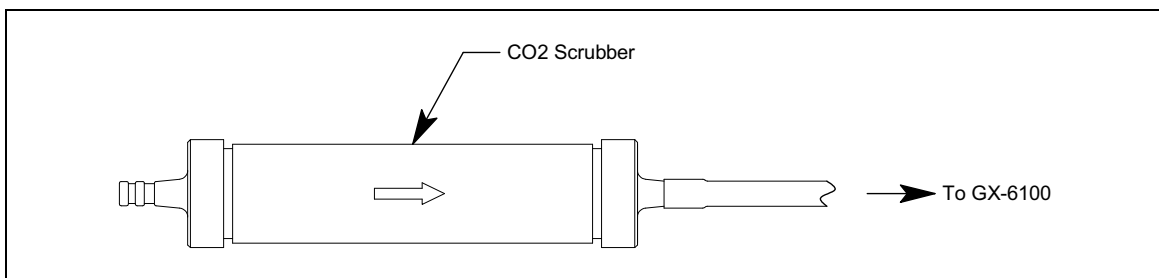

Figure 47: CO₂ Scrubber Connected to GX-6100

3. Wait one minute for the fresh air sample to flow through the carbon dioxide scrubber, then press and hold the ▲ AIR button to set the zero reading.
4. Remove the scrubber from the inlet fitting.
5. Reattach the tubing to the open end of the scrubber.

Performing a Demand Zero for Instruments with a CO₂ and PID or NH₃ Sensor

If your instrument has both an IR CO₂ sensor **and** a PID sensor or an NH₃ sensor, you will need to use both the carbon dioxide scrubber and the VOC zero filter to perform a demand zero.

1. Remove the CO₂ scrubber's tubing from the side that has an arrow pointing to it.
2. Remove both plugs from the tubing stubs on the VOC zero filter.
3. Connect the VOC zero filter to the GX-6100's inlet fitting. The filter does not have a preferred flow direction.
4. Connect the CO₂ scrubber to the tubing stub on the other side of the VOC zero filter. Be sure the arrow on the CO₂ scrubber is pointing toward the VOC zero filter. See the figure below for the scrubber setup.

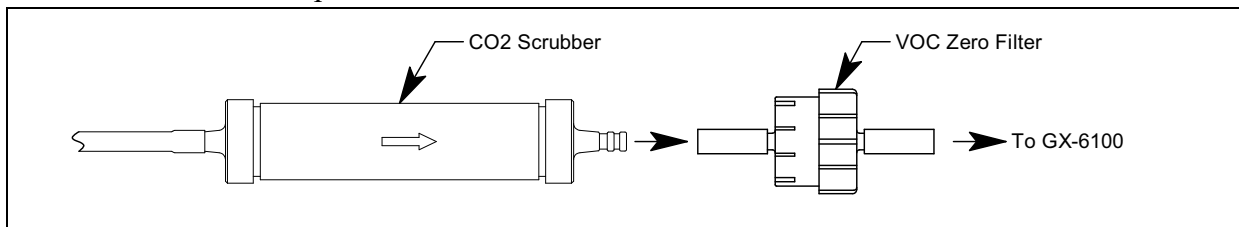

Figure 48: CO₂ Scrubber and VOC Zero Filter Combination

5. Wait one minute for the fresh air sample to flow through the scrubber setup.
6. Press and hold the ▲ AIR button to set the zero reading.
7. Remove the CO₂ scrubber from the VOC zero filter. Be sure the VOC zero filter's tubing stays on the VOC zero filter.
8. Reattach the CO₂ scrubber's tubing to the open end of the scrubber.
9. Remove the VOC zero filter from the GX-6100's inlet fitting.
10. Reinstall the plugs on each end of the VOC zero filter.

NOTE: Do not store the CO₂ scrubber and VOC zero filter connected together. They must be separated and appropriately plugged for storage.

IR Calibration

See “Performing a Span Adjustment” on page 93 or “Setting Calibration Concentration Values (SETTING CAL-P)” on page 100 for instructions to perform a calibration.

NOTE: If you are using the IR HC or IR CH₄ sensors in their autoranging configuration, be sure to calibrate the range you’d like the most accuracy in (either %LEL or %VOL).

NOTE: If there is a PID sensor installed in your instrument and you are calibrating an IR CH₄ sensor with %VOL concentrations, either calibrate the PID sensor first or allow enough time for the %VOL CH₄ gas to flush out before calibrating the PID sensor.

IR Bump Testing

See “Performing a Bump Test” on page 80 for instructions to perform a bump test.

Replacing an IR Sensor

When replacing a sensor, you may either replace it with another of the same sensor or you may install a different IR sensor. If a different one is installed, the GX-6100 will load the sensor parameters and configure the IR channel for the new sensor.

1. Follow the instructions listed in “Replacing a Sensor” on page 134.

Be sure that the new sensor is installed in the same position as the old sensor and that the following sensor priority for the smart sensor 1 position is maintained.

Table 30: Priority for Smart Sensor 1 Position

High Priority ↓ Low Priority	10.6 eV low range PID
	10.0 eV/benzene PID
	11.7 eV PID
	10.6 eV high range PID
	ESS-03 Cl ₂
	MOS sensors
	ESS-03 NH ₃
	IR and other ESS-03 sensors

For example, if your instrument is a 4-gas + high range PID + IR HC, the high range PID sensor should be in the smart sensor 1 position and the IR HC sensor should be in the smart sensor 2 position. If your instrument is a 4-gas + IR HC, the IR HC sensor should be in the smart sensor 1 position and a dummy sensor should be installed in the smart sensor 2 position. See the figure below for the location of the smart sensor 1 and 2 positions.

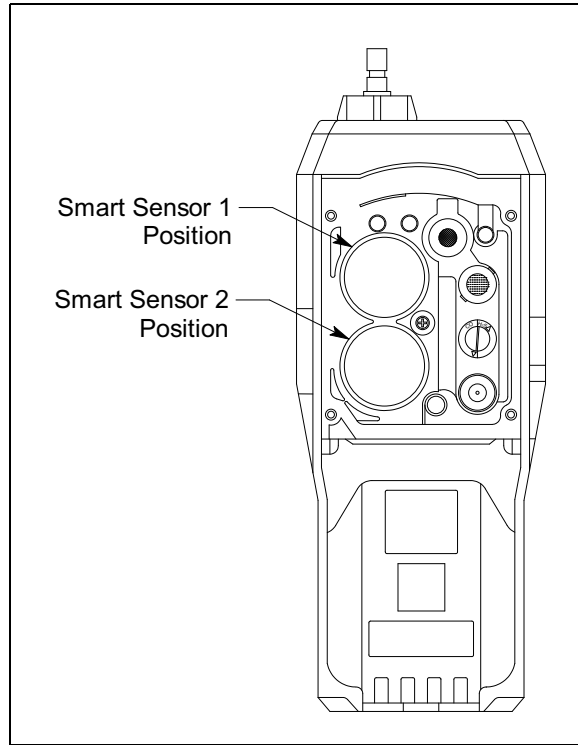

Figure 49: Smart Sensor Positions

Parts List

Table 31: Infrared Sensors Parts List

Part Number	Description
33-6015RK	CO ₂ scrubber
33-6092	VOC zero filter, charcoal, with tubing stubs and plugs (for instruments that include an IR CO ₂ sensor <u>and</u> a PID sensor)
81-0012RK-01	Calibration cylinder, 50% LEL CH ₄ in air, 34 liter steel
81-0012RK-03	Calibration cylinder, 50% LEL CH ₄ in air, 103 liter
81-0013RK-01	Calibration cylinder, 50% vol CH ₄ in nitrogen, 34 liter steel
81-0013RK-05	Calibration cylinder, 50% vol CH ₄ in nitrogen, 58 liter
81-0018RK-01	Calibration cylinder, 50% LEL isobutane in air, 34 liter steel
81-0018RK-03	Calibration cylinder, 50% LEL isobutane in air, 103 liter
81-0019RK	Calibration cylinder, 10% vol isobutane in nitrogen, 17 liter
81-0071RK-01	Calibration cylinder, 5,000 ppm CO ₂ in nitrogen, 34 liter
81-0071RK-03	Calibration cylinder, 5,000 ppm CO ₂ in nitrogen, 103 liter
81-0072RK-01	Calibration cylinder, 2.5 %VOL CO ₂ in nitrogen, 34 liter steel
81-0072RK-03	Calibration cylinder, 2.5 %VOL CO ₂ in nitrogen, 103 liter
81-1054RK	Regulator, demand-flow type, for Cl ₂ , HCN, and NH ₃ in 34-liter aluminum, 58-liter, and 103-liter calibration cylinders (cylinders with internal threads)
81-1054RK-H2S	Regulator, demand-flow type, for CO, CO ₂ , H ₂ S, N ₂ , NO ₂ , PH ₃ , SO ₂ , zero air, and combustible gases in 34-liter aluminum, 58-liter, and 103-liter calibration cylinders (cylinders with internal threads)
81-1055RK	Regulator, demand-flow type, for all gases in 17- and 34-liter steel cylinders (cylinders with external threads)
DES-3311-1	Infrared CO ₂ sensor, 0 - 10% vol
DES-3311-2	Infrared HC sensor, 0 - 100% LEL/2.0 - 30.0% vol autoranging
DES-3311-3	Infrared CH ₄ sensor, 0 - 100% LEL/5.0 - 100% vol autoranging
DES-3311-4	Infrared CO ₂ sensor, 0 - 10,000 ppm

Appendix H: 10.0 eV/Benzene PID Sensor

Overview

This appendix describes the GX-6100's 10.0 eV/benzene sensor (RKI part number PID-003L). Common applications for the 10.0 eV/benzene PID sensor include process monitoring where only benzene is present or petroleum industry monitoring where other VOCs may be present.

The 10.0 eV/benzene PID sensor can be ordered for 2 different purposes:

- general VOC detection (isobutylene calibration standard); does not come with filter tubes and is not intended for use with Benzene Select Mode

NOTE: Even though the 10.0 eV/benzene sensor can be used for general VOC detection, if your application is for general VOC detection and is not related to monitoring for benzene specifically, RKI Instruments, Inc. recommends that the low range or high range 10.6 eV PID sensor be used instead.

- benzene specific detection (benzene calibration standard); comes with filter tubes intended for use with Benzene Select Mode

NOTE: Regardless of the calibration gas, the 10.0 eV/benzene sensor will still detect and respond to a variety of volatile organic compounds (VOCs) while used in Measuring Mode.

See the table below for 10.0 eV/benzene sensor specifications.

Table 32: 10.0 eV/Benzene PID Sensor Specifications

	Measuring Mode Operation	Benzene Select Mode Operation
Detection Range	0 - 100.00 ppm	0 - 50.00 ppm
Reading Increment	0 - 10 ppm: 0.01 ppm 10 - 100 ppm: 0.1 ppm	0 - 10 ppm: 0.01 ppm 10 - 50 ppm: 0.1 ppm
Alarm 1 Factory Setting	5 ppm	N/A
Alarm 2 Factory Setting	10 ppm	N/A
STEL Alarm	60 ppm	N/A
TWA Alarm	40 ppm	N/A

Sensor Description

The PID sensor is a cylindrical sensor with a diffusion opening on the front and 3 pins on the back. It is installed in a white housing that has three sockets on the bottom that mate with the GX-6100 instrument. The PID sensor must always be installed in the first smart sensor position which is located in the top left corner of the sensor block.

Tube and Tube Holder

NOTE: The filter tube and tube holder come with 10.0 eV/benzene sensors ordered for benzene specific detection.

Benzene detection typically requires the use of a filter tube. The filter tube will scrub out most VOCs other than benzene but will not scrub out nitrobenzene, cyclohexane, n-octane, or n-pentane. The filter tube is installed in a tube holder and needs to be replaced regularly.

A tube holder and a box of tubes are included with 10.0 eV/benzene versions of the GX-6100.

Tube

Each tube has a 3/4 line on it. If the tube becomes discolored and if the discoloration extends beyond the 3/4 line, the tube is no longer effectively scrubbing non-benzene gases and needs to be replaced.

Tubes must be stored in a cool, dark place (0 - 25 °C/ 32 - 77 °F) and must be used before the expiration date that is printed on the box. If the tubes are being stored in a refrigerator, take them out of the refrigerator and let them sit overnight before using them.

Tubes do not contain cadmium, mercury, or chrome and may be disposed as general waste.

Tube Holder

The tube holder attaches to the GX-6100's inlet fitting. It has a breakaway feature ensuring that the GX-6100 will not be damaged by hitting the tube holder on something when it is installed. The tube holder should only be used in Benzene Select Mode or when performing a calibration in TUBE CAL. If the tube holder is attached to the instrument's inlet fitting in Measuring Mode, it will cause a low flow alarm.

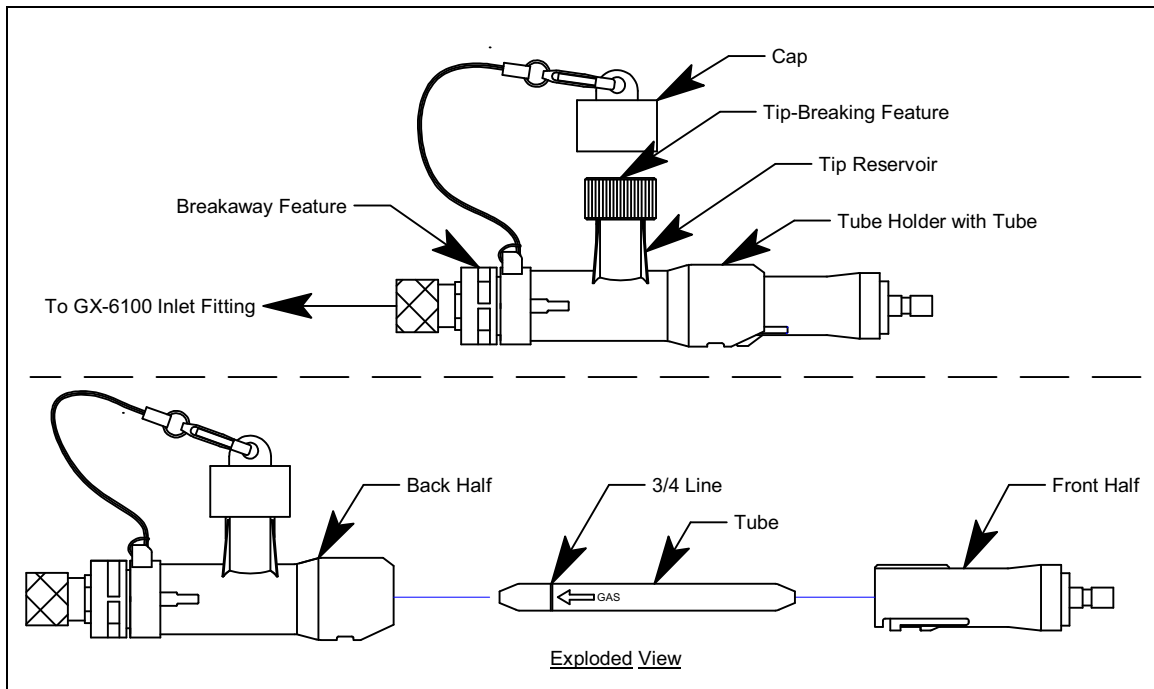
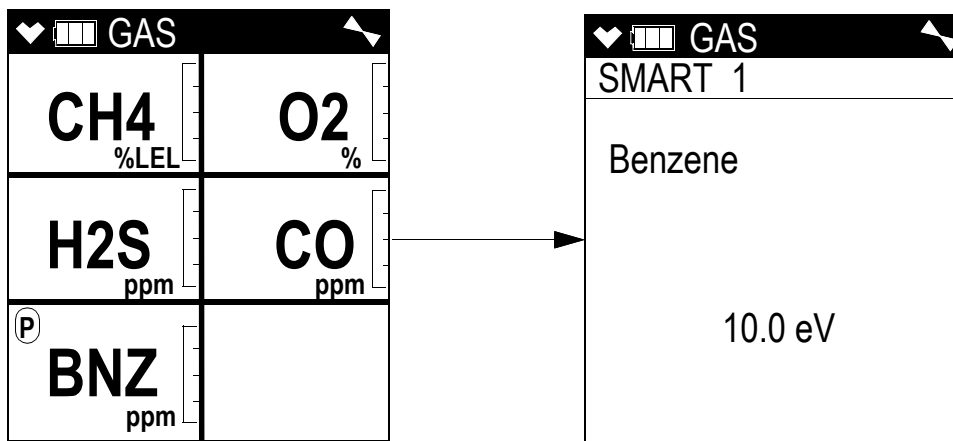

Figure 50: Tube Holder Component Location

Start Up

The instructions for starting up a GX-6100 with a 10.0 eV/benzene PID sensor installed are the same as described in “Start Up” on page 28 with the exception of the screens shown in Step 8. Those screens appear as shown below.



Display Mode

Display Mode for a 10.0 eV/benzene PID instrument appears and functions as described in “Chapter 4: Display Mode” on page 55 with the following exceptions:

- A Benzene Select Mode screen is now the first item in Display Mode. Benzene Select Mode is described in “Benzene Select Mode” on page 220.

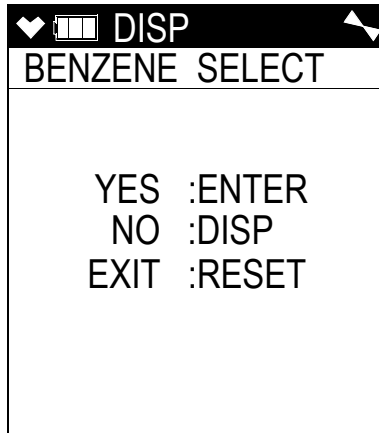

- The PID Gas Name screen operates as configured in “Select PID Gas Name Screen” on page 56 but is factory set up for and calibrated to benzene and appears as shown below. If there are 2 PID sensors installed in your GX-6100, the PID Gas Name screens will appear in Display Mode in the following order regardless of their position in the flow system: 10.0 eV/benzene, 10.6 eV, 11.7 eV.

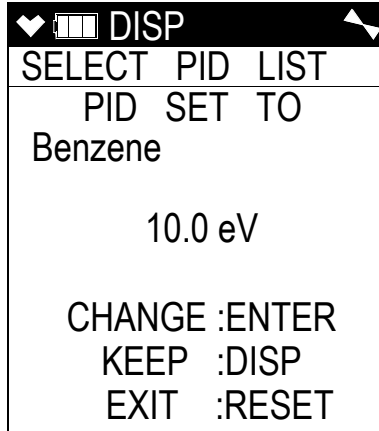

Measuring Mode

The 10.0 eV/benzene sensor detects VOCs in the 0-100.00 ppm range in Measuring Mode. See “Measuring Mode, Normal Operation” on page 37 for a complete description of Measuring Mode.

If the 10.0 eV/benzene PID sensor is one of two PID sensors installed in your instrument, as shipped from the factory, the 10.0 eV/benzene PID channel will say “BNZ” and the low or high range PID channel will say “VOC”.

If you change the target gas of the 10.0 eV/benzene PID sensor to something other than benzene in Display Mode, both channels will appear as “VOC”. In that case, the channel that appears first will be based on the following sensor priority.

High Priority ↓ Low Priority	10.6 eV low range PID
	10.0 eV/benzene PID
	11.7 eV PID
	10.6 eV high range PID
	ESS-03 Cl ₂
	MOS sensors
	ESS-03 NH ₃
	IR and other ESS-03 sensors

NOTE: If you have changed the factory-set channel assignments using the GX-6100 Configuration Program, the order of displayed sensors may be different and you will need to remember how you set your instrument up.

Benzene Select Mode

Benzene Select Mode allows the user to monitor for benzene in the 0-50.00 ppm range. Readings taken in Benzene Select Mode are saved to the instrument’s memory. See “Viewing Benzene Select Mode Data” on page 226 for a description of viewing data.

NOTE: A PID-003L 10.0 eV/benzene sensor must be installed in order for the Benzene Select Mode screen to appear.

A tube holder and filter tube (only included with 10.0 eV/benzene instruments ordered for benzene specific detection) are necessary for monitoring an area in Benzene Select Mode.

Be sure to perform an appropriate calibration for Benzene Select Mode use as described on page 229 before continuing.

WARNING: *If you take the GX-6100 to an area that is 10°F to 15°F different than the previous area, allow the instrument 45 minutes to acclimate before taking any readings. Failure to do so may cause the reading to be inaccurate.*

WARNING: *There are no alarm indications in Benzene Select Mode.*

1. Enter Display Mode by pressing the DISP/LOCK button while in Measuring Mode. The Benzene Select Mode screen appears.

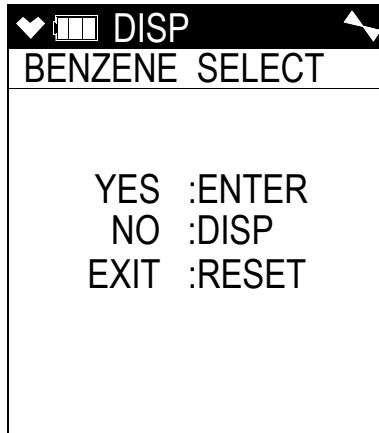

2. Press and release the POWER/ENTER button to enter Benzene Select Mode.
3. The pump will stop and the instrument will prompt you to install the filter tube and tube holder.

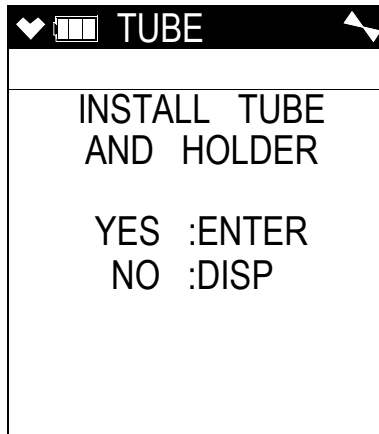

4. Be sure a filter tube is installed in the tube holder and then attach the tube holder to the instrument's inlet fitting. See page 236 for instructions.
5. Press and release the POWER/ENTER button to confirm the tube and holder have been installed.

6. You will be prompted to start a benzene measurement.

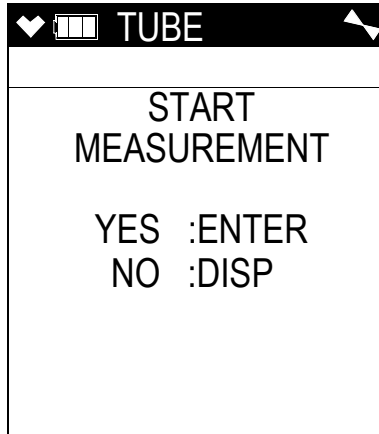

7. Press and release the POWER/ENTER button to start the benzene measurement.
8. The benzene reading is displayed at the top of the screen. An automatically-determined, temperature-based countdown is displayed at the bottom of the screen. The number to the left of the countdown ("5" in the example below) is the temperature code.

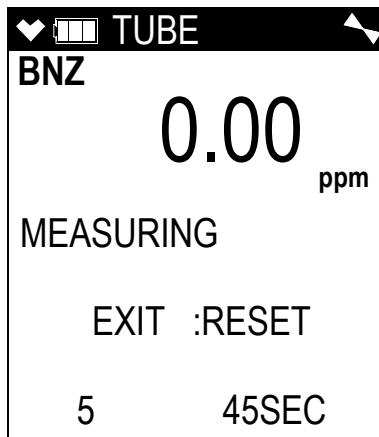

9. To cancel the measurement, press and release the RESET button.

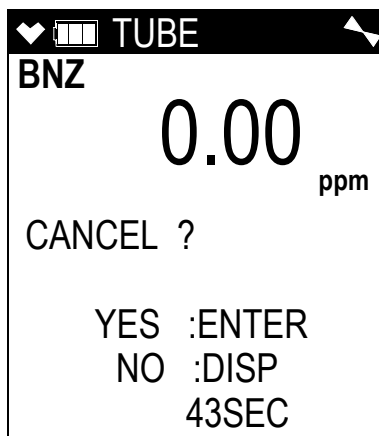

- Press the POWER/ENTER button to confirm the measurement cancel.
- Press the DISP/LOCK button to return to the measuring screen without canceling the measurement.

10. Once the measurement is over, the final reading is displayed and you are asked if you want to repeat the measurement.



- To repeat a measurement, continue to Step 11.
- To not repeat a measurement and return to Measuring Mode, continue to Step 12.
- To start a STEL measurement, continue to Step 13.

11. To start another measurement, press and release the POWER/ENTER button.

WARNING: *If you take the GX-6100 to an area that is 10°F to 15°F different than the previous area, allow the instrument 45 minutes to acclimate before taking any readings. Failure to do so may cause the reading to be inaccurate.*

- a. You will be prompted to change the tube before continuing. See page 236 for instructions.

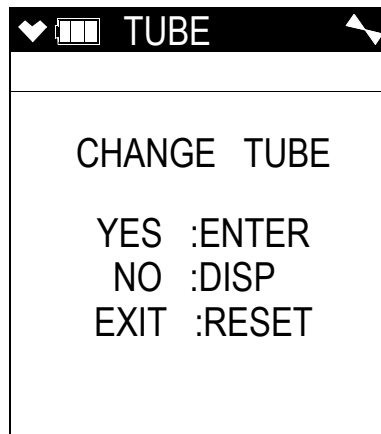

- b. Once the tube is changed, press and release the POWER/ENTER button to start the measurement. Return to Step 8.

12. To not start another measurement and to return to Measuring Mode, press and release the DISP/LOCK button.
- You will be prompted to remove the tube holder from the instrument's inlet fitting.

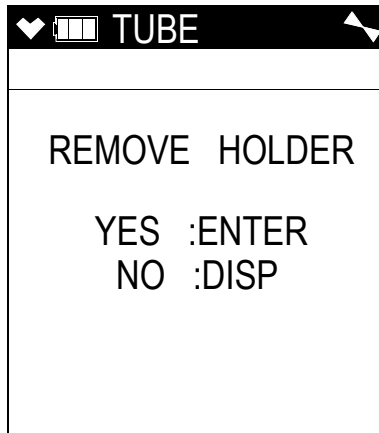

- Remove the tube holder from the GX-6100's inlet fitting.
 - Press and release the POWER/ENTER button.
13. To proceed with taking a STEL measurement, press and release the RESET button.

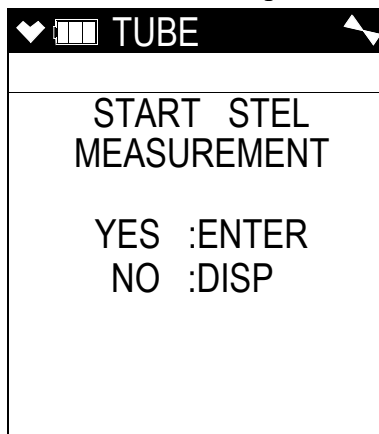

- Leave the tube holder installed but there is no need to change the tube.
- Press and release the POWER/ENTER button to start a STEL measurement.

- c. The STEL measurement takes 15 minutes and a countdown displays at the bottom of the screen. The STEL reading is displayed at the top of the screen and the instantaneous reading is displayed below it.

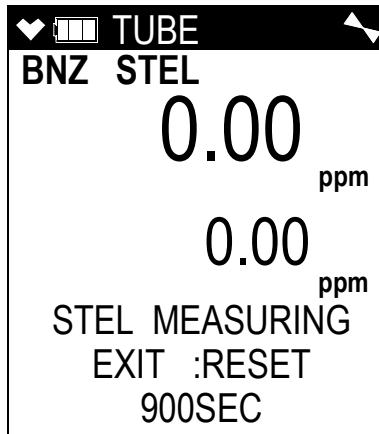

- d. To cancel the STEL measurement, press and release the RESET button. Then press and release the POWER/ENTER button.

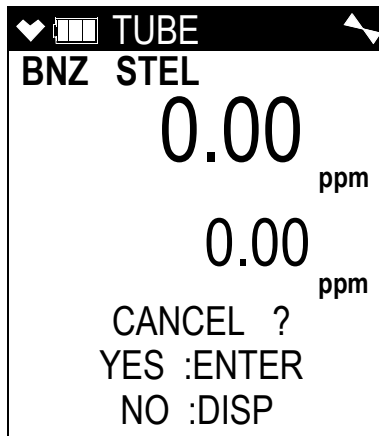

- e. At the end of the STEL countdown, the STEL reading displays.



- f. To repeat the STEL measurement, press and release POWER/ENTER.

- g. To return to Measuring Mode, press and release the DISP/LOCK button. You will be prompted to remove the tube holder from the instrument's inlet fitting.

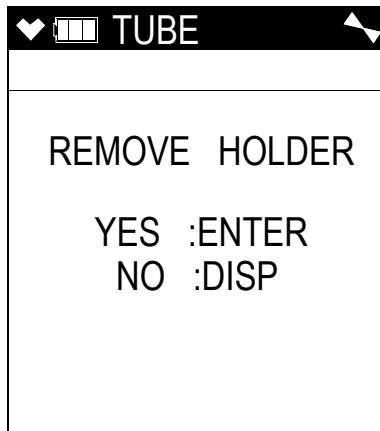

- h. Remove the tube holder from the GX-6100's inlet fitting.
i. Press and release the POWER/ENTER button.

Viewing Benzene Select Mode Data

Readings taken in Benzene Select Mode are saved to the snap logger. To view Benzene Select Mode readings, do the following:

1. From Measuring Mode, press and release the DISP/LOCK button to enter Display Mode.
2. Continue pressing the DISP/LOCK button until the snap logging screen appears.

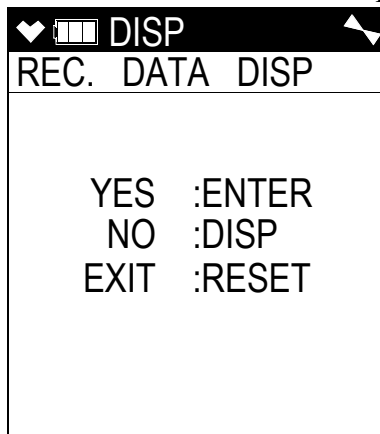

- Press and release the POWER/ENTER button. The screen that appears will depend on whether or not any data has been saved to the snap logger.

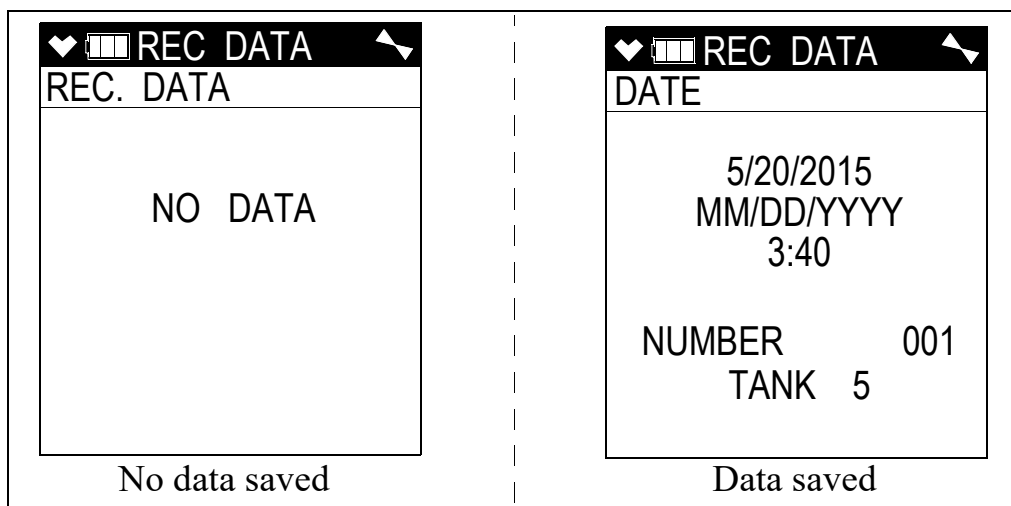

- If snap logs have been taken, the screen indicates the year, month, day, and time that the most recent snap log was taken.
The number near the bottom of the screen indicates the snap log ID number. The first snap log that is taken is given an ID of 001. The next snap log ID is 002. The ID number increases sequentially with each set of snap log data.
The last line of the screen indicates the Station ID that was used for the snap log.
- Use the ▲ AIR and SHIFT ▼ (PANIC) buttons to scroll through different snap log IDs. To view the data in a snap log ID, press and release the POWER/ENTER button.
- The instrument saves data from a Benzene Select Mode standard measurement and from a Benzene Select Mode STEL measurement (if performed). Data from a Benzene Select Mode standard measurement will say “BENZENE SELECT” below the reading. Data from a Benzene Select Mode STEL measurement will say “BENZENE SELECT” and “STEL” below the reading. They are separate files. Data may also be present from snap log data saved in Measuring Mode.
- Use the ▲ AIR and SHIFT ▼ (PANIC) buttons to scroll through the different snap log data screens. The gas readings will change but the snap log ID is not visible from this screen.
- You can also go back and forth between the ID and data screens by pressing and releasing the POWER/ENTER button.
- To return to the Snap Logging screen, press and release the DISP/LOCK button.
- To return to Measuring Mode, press and release the RESET button.

ID screen

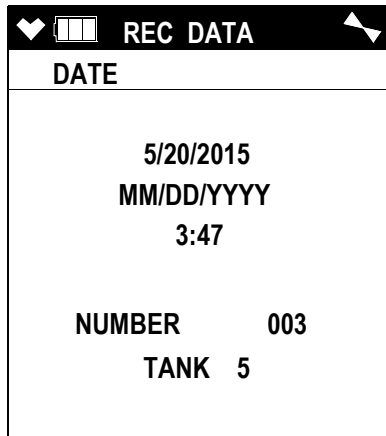

SHIFT ▼

▲ AIR

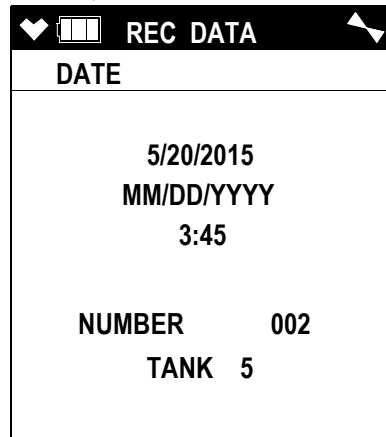

SHIFT ▼

▲ AIR

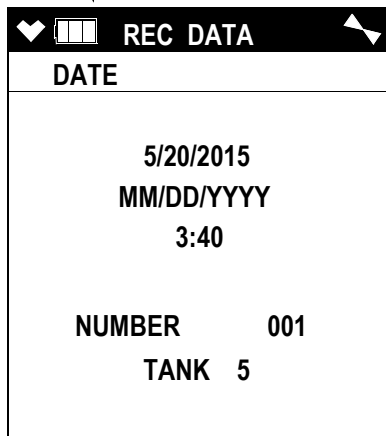

Data screen

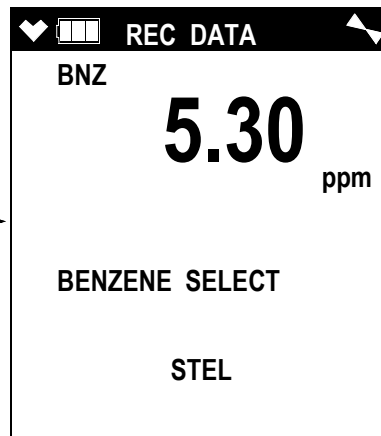

SHIFT ▼

▲ AIR

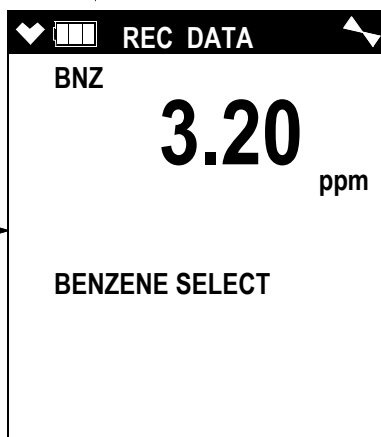

SHIFT ▼

▲ AIR

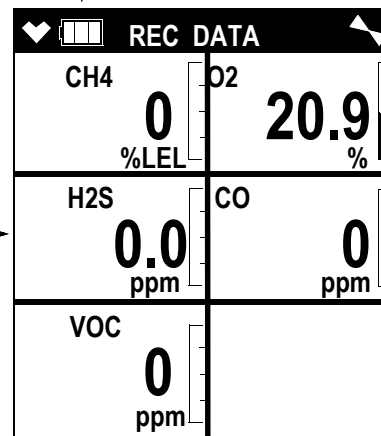

POWER/
ENTER

POWER/
ENTER

POWER/
ENTER

Benzene
Select Mode
STEL Data

Benzene
Select Mode
Standard Data

Measuring
Mode
Data

Calibrating the 10.0 eV/Benzene PID Sensor

Important Calibration Information

Calibration of the 10.0 eV/benzene PID sensor depends on your application and on the calibration gas you have available. The most accurate way to calibrate the sensor is to use benzene gas. If it is not practical or possible to use benzene gas, another gas, such as isobutylene, can be used as long as the calibration code indicated on the box of filter tubes is entered into the instrument.

If you start using a new box of filter tubes, you may need to recalibrate. See Step 7 on page 237 for further description.

See the table below for a summary of the calibration options and requirements.

Application	Calibration Options	
Benzene Select Mode benzene detection	Option 1	1. SPAN CAL with benzene, without tube and holder 2. TUBE CAL with benzene, with tube and holder
	Option 2	1. SPAN CAL with isobutylene (or other target gas)** 2. enter CAL CODE
Measuring Mode, benzene detection	SPAN CAL with benzene (no TUBE CAL or CAL CODE required)	
Measuring Mode, general VOC detection*	Option 1	SPAN CAL with benzene
	Option 2	SPAN CAL with isobutylene (or other target gas)**
<p>* Even though it is possible to use the 10.0 eV/benzene PID sensor for general VOC detection, RKI Instruments, Inc. recommends using the low range or high range 10.6 eV sensor instead.</p> <p>* In order to calibrate to a gas other than benzene or isobutylene, you must select that other gas for the 10.0 eV/benzene sensor in the PID Gas Name screen in Display Mode as described in “Select PID Gas Name Screen” on page 56. You must also select the appropriate calibration gas during the calibration procedure.</p>		

Setting the Fresh Air Reading

See “Setting the Fresh Air Reading” on page 87 for instructions to set the fresh air reading.

Performing a SPAN CAL

See “Performing a Span Adjustment” on page 93 for instructions to perform an automatic calibration while keeping the following in mind:

- Be sure that you are doing a complete calibration as appropriate for your application and for the calibration gas you have available (see page 229).
- If the 10.0 eV/benzene PID sensor is one of two PID sensors installed in your instrument, as shipped from the factory, the 10.0 eV/benzene PID channel will say “BNZ” and the low or high range PID channel will say “VOC”.

If you change the target gas of the 10.0 eV/benzene PID sensor to something other than benzene in Display Mode, both channels will appear as “VOC”. In that case, the channel that appears first will be based on the following sensor priority. Be sure to select the correct PID sensor for calibration.

High Priority ↓ Low Priority	10.6 eV low range PID
	10.0 eV/benzene PID
	11.7 eV PID
	10.6 eV high range PID
	ESS-03 Cl ₂
	MOS sensors
	ESS-03 NH ₃
	IR and other ESS-03 sensors

NOTE: If you have changed the factory-set channel assignments using the GX-6100 Configuration Program, the order of displayed sensors may be different and you will need to remember how you set your instrument up.

Performing a TUBE CAL

NOTE: A PID-003L 10.0 eV/benzene sensor must be installed in order for the **TUBE CAL** menu item to appear in User Mode but a **TUBE CAL** only needs to be performed if you ordered an instrument with a 10.0 eV/benzene sensor intending to use it specifically for benzene detection and have a tube and tube holder.

NOTE: If you begin to use filter tubes from a new box and if the calibration code shown on the new box is different than the calibration code shown on the old box, you must perform a **TUBE CAL** operation using one of the tubes from the new box.

WARNING: *If you take the GX-6100 to an area that is 10°F to 15°F different than the previous area, allow the instrument 45 minutes to acclimate before taking any readings. Failure to do so may cause the calibration to be inaccurate.*

To calibrate the 10.0 eV/benzene sensor in TUBE CAL, you will need:

- A benzene calibration cylinder. RKI Instruments, Inc. recommends a concentration of 5 ppm.
- A demand-flow regulator to provide adequate sample gas flow.
- Non-absorbent tubing.
- Tube holder and filter tube.

Be sure that you are doing a complete calibration as appropriate for your application and for the calibration gas you have available (see page 229).

1. To enter User Mode, while in Measuring Mode, press and hold the SHIFT ▼ (PANIC) button, then press the DISP/LOCK button and release both buttons.

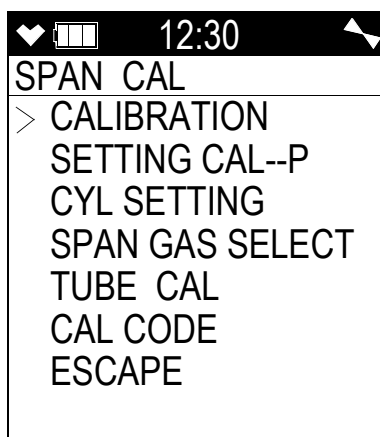

2. Use the SHIFT ▼ (PANIC) button to scroll to **TUBE CAL** and then press and release the POWER/ENTER button.

- The pump will stop and the instrument will prompt you to install the filter tube and tube holder.

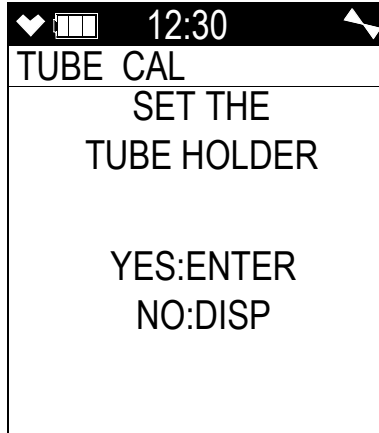

- Be sure a filter tube is installed in the tube holder and then attach the tube holder to the instrument's inlet fitting. See page 236 for instructions.
- Press and release the POWER/ENTER button to enter the **TUBE CAL** start screen.

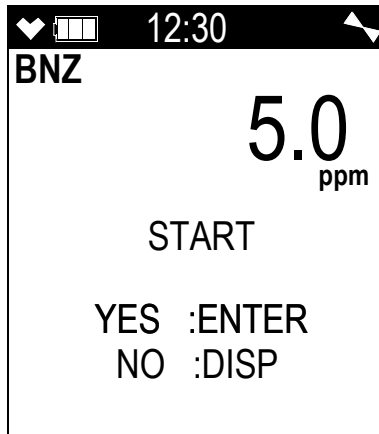

NOTE: The displayed calibration value can be adjusted by accessing the **SETTING CAL--P** menu in the **SPAN CAL** menu (see page 100).

- Screw the demand flow regulator onto the benzene calibration cylinder.
- Attach the calibration tubing to the demand flow regulator.
- Attach the other end of the calibration tubing to the tube holder's inlet fitting.

9. Press and release the POWER/ENTER button to start a calibration. An automatically-determined, temperature-based countdown is displayed at the bottom of the screen. The number to the left of the countdown (“5” in the example below) is the temperature code.

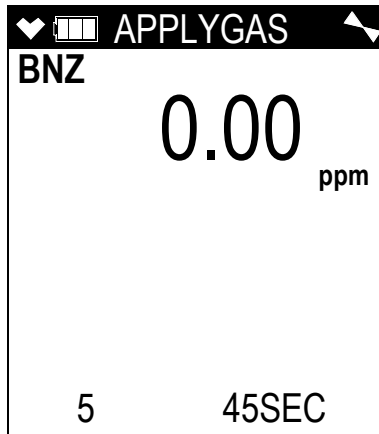

10. If the calibration passes, the screen will indicate PASS and will return you to the **TUBE CAL** start screen.

11. If the calibration fails, a failure screen will appear and the instrument will go into alarm.

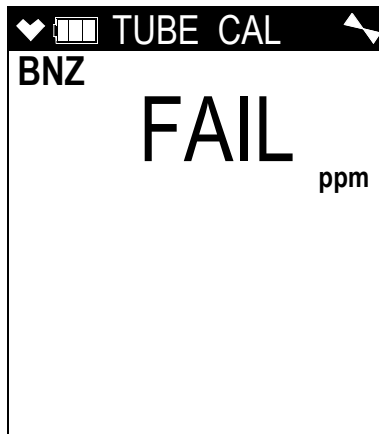

Press and release the RESET button to clear the alarm and return to the **TUBE CAL** start screen. See “Troubleshooting” on page 119.

12. Press and release the DISP button. You will be prompted to remove the filter tube and tube holder.

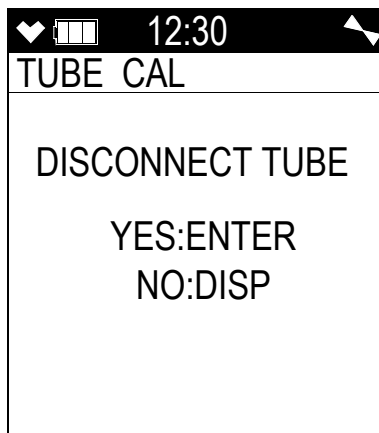

13. Remove the tube holder from the GX-6100's inlet fitting.
14. Press and release the POWER/ENTER button. You will return to the User Mode menu.
15. Use the SHIFT ▼ (PANIC) button to place the cursor next to the **NORMAL MODE** menu option, then press and release the POWER/ENTER button to return to Measuring Mode.
16. Detach the calibration tubing from the tube holder's inlet fitting.
17. Unscrew the demand flow regulator from the calibration cylinder.

Entering a CAL CODE

NOTE: A PID-003L 10.0 eV/benzene sensor must be installed in order for the **CAL CODE** menu item to appear in User Mode, but a **CAL CODE** only needs to be set if you ordered an instrument with a 10.0 eV/benzene sensor intending to use it specifically for benzene detection and have a tube and tube holder.

NOTE: If you begin to use filter tubes from a new box and if the calibration code shown on the new box is different than the calibration code shown on the old box, you must enter the new calibration code before using the new filter tubes.

An alternative to performing a **TUBE CAL** using a benzene calibration cylinder is to enter the calibration code found on the filter tube box. The cal code adjusts the instrument's reading in Benzene Select Mode to account for the effect that the filter tube has on the PID sensor's response to benzene. It is listed on the tube box's label and is a letter between A and J.

If you go through the **CAL CODE** procedure, there is no need to perform a **TUBE CAL** using a benzene calibration cylinder.

Be sure that you are doing a complete calibration as appropriate for your application and for the calibration gas you have available (see page 229).

1. To enter User Mode, press and hold the SHIFT ▼ (PANIC) button, then press the DISP/LOCK button and release both buttons.

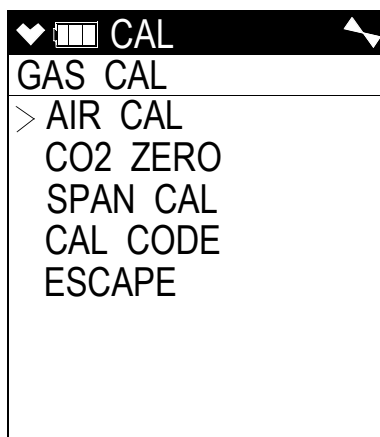

2. Use the SHIFT ▼ (PANIC) button to place the cursor next to **CAL CODE**.
3. Press and release the POWER/ENTER button.

- The current calibration code will be displayed and it will be flashing.

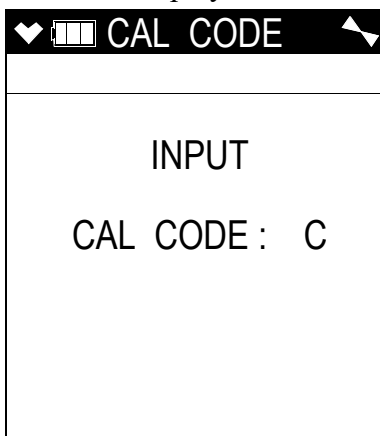

- Use ▲ AIR or SHIFT ▼ (PANIC) to adjust the calibration code to match the one listed on your filter tube box's label.
- Press and release the POWER/ENTER button to confirm the calibration code. The screen will show “END” and will return to the User Mode menu.
- Use the SHIFT ▼ (PANIC) button to place the cursor next to the **NORMAL MODE** menu option, then press and release the POWER/ENTER button to return to Measuring Mode.

Maintenance

Replacing a Sensor

See “Replacing a Sensor” on page 134 for sensor replacement instructions.

PID Sensor Maintenance

See page 138 for PID sensor maintenance instructions keeping in mind the following differences in spare parts.

Part Number	Description
33-0563	PID sensor electrode stack, 10.0 eV/benzene sensor
51-1503	PID sensor replacement lamp, 10.0 eV/benzene sensor
PID-003L	PID sensor, 10.0 eV/benzene

CAUTION: *The aluminum oxide cleaning kit described on page 138 is only for use with the 10.0 eV and 10.6 eV PID sensors' lamps. **DO NOT USE THE ALUMINUM OXIDE CLEANING KIT TO CLEAN THE 11.7 eV PID SENSOR'S LAMP!***

Replacing a Tube

When to Replace Tube

RKI Instruments, Inc. recommends that the tube be replaced before starting a new measurement in Benzene Select Mode. If discoloration of the filter material extends beyond the “3/4” line (into the side without the text and arrow), the tube needs to be replaced. Even though discoloration can be a measure of when to replace the tube, not all gases cause the filter material to discolor which is why RKI Instruments, Inc. recommends that the tube be replaced before starting a new measurement in Benzene Select Mode.

If the tubes are being stored in a refrigerator, take them out of the refrigerator and let them sit overnight before using them.

Instructions to Replace Tube

1. Remove the front of the tube holder by pushing on the locking mechanism and pulling the front half away from the back half, shown below.

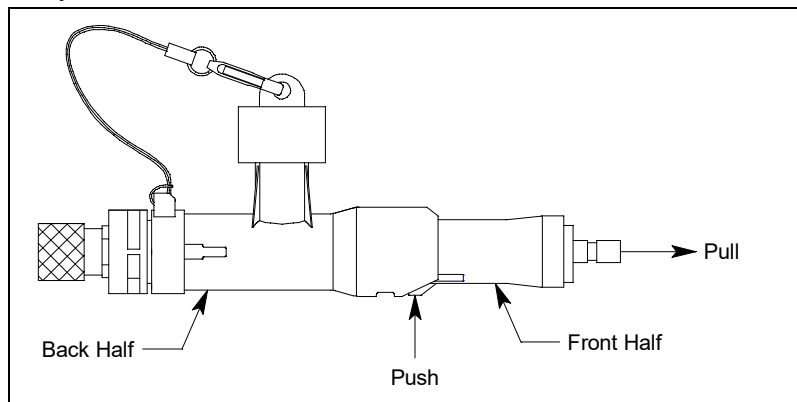

Figure 51: Replacing a Tube

2. Remove the used tube. Take care not to touch the broken ends of the tube.
3. Remove the cap from the tube holder.
4. Break off the tips of the new tube using the tube holder's tip-breaking feature. The reservoir can hold approximately 12 tips and will need to be periodically emptied.
5. Insert the new tube in the front half of the tube holder. The arrow on the tube should be pointing away from the front half.

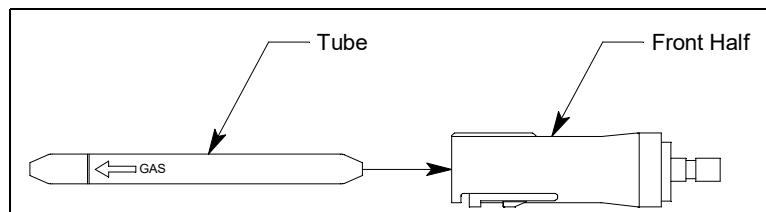

Figure 52: Inserting New Tube Into Front Half

6. Line up the locking feature in the front half with its mate in the back half and insert the front half/tube assembly into the back half making sure the locking feature engages.

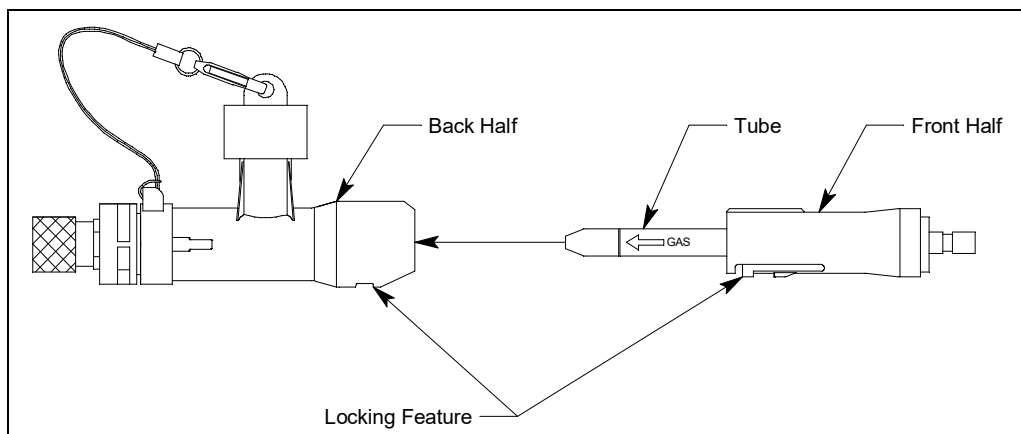

Figure 53: Reassembling Tube Holder

7. If you are replacing your old tube with a tube from a new box, compare the calibration code listed on the old box to the calibration code listed on the new box.
 - a. If the calibration codes match, there is no need to do anything else.
 - b. If the calibration codes do not match, you must either perform a TUBE CAL using a tube from the new box (see page 231) or you must enter the new calibration code into CAL CODE (see page 234), depending on what method of calibration you used with your old box of filter tubes. See page 229 for a description of calibration methods.
8. Tubes do not contain cadmium, mercury, or chrome and may be disposed as general waste.

Parts List for 10.0 eV/Benzene PID Instruments

Table 33: Spare Parts List for 10.0 eV/Benzene PID Instruments

Part Number	Description
33-0563	PID sensor electrode stack, 10.0 eV/benzene sensor
33-7128	Filter tubes, 1 box, 10 tubes per box
33-7128-05	Filter tubes, 5 boxes, 10 tubes per box
51-1503	PID sensor replacement lamp, 10.0 eV/benzene sensor
80-0174	Tube holder
81-0100RK-03	Calibration cylinder, benzene, 5 ppm in air, 103 liter
81-0100RK-04	Calibration cylinder, benzene, 5 ppm in air, 34 liter aluminum
81-0104RK-03	Calibration cylinder, isobutylene, 10 ppm in air, 103 liter
81-0104RK-04	Calibration cylinder, isobutylene, 10 ppm in air, 34 liter aluminum

Part Number	Description
81-1054RK	Regulator, demand-flow type, for Cl ₂ , HCN, and NH ₃ in 34-liter aluminum, 58-liter, and 103-liter calibration cylinders (cylinders with internal threads)
81-1054RK-H2S	Regulator, demand-flow type, for CO, CO ₂ , H ₂ S, N ₂ , NO ₂ , PH ₃ , SO ₂ , zero air, and combustible gases in 34-liter aluminum, 58-liter, and 103-liter calibration cylinders (cylinders with internal threads)
81-1055RK	Regulator, demand-flow type, for all gases in 17- and 34-liter steel cylinders (cylinders with external threads)
81-6XAX-DLV	Calibration kit: 34 liter 10 ppm IBL in air cylinder, demand flow regulator, calibration tubing
81-6XZX	Calibration kit: 103 liter 5 ppm benzene in air cylinder, demand flow regulator, calibration tubing
81-6XZX-DLV	Calibration kit: 34 liter 5 ppm benzene in air cylinder, demand flow regulator, calibration tubing
82-0300RK	Aluminum oxide powder PID lamp cleaning kit, with electrode stack removal tool, for 10.0 eV and 10.6 eV PID sensors' lamps ONLY
PID-003L	PID sensor, 10.0 eV/benzene

Appendix I: 11.7 eV PID Sensor

Overview

This appendix describes the GX-6100's 11.7 eV PID sensor (RKI part number PID-004).

The 11.7 eV PID sensor detects VOCs in the 0-1000 ppm range. The standard calibration for the 11.7 eV PID sensor is to isobutylene but it can be factory setup for and calibrated to other gases. Regardless of the calibration gas, the 11.7 eV PID sensor will still detect and respond to a variety of volatile organic compounds (VOCs) while used in Measuring Mode.

The 11.7 eV PID sensor is capable of detecting VOCs that the 10.6 eV low range and high range PID sensors are not, such as:

- acrylonitrile
- carbon tetrachloride
- chloroform
- methanol
- refrigerants (R-32A, R-143)

See the table below for 11.7 eV PID sensor specifications.

Table 34: 11.7 eV PID Sensor Specifications

Detection Range	0 - 1000 ppm
Reading Increment	0 - 100 ppm: 0.1 ppm 100 - 1000 ppm: 1 ppm
Alarm 1 Factory Setting	400 ppm
Alarm 2 Factory Setting	1000 ppm
STEL Alarm	60.0
TWA Alarm	40.0

11.7 eV PID Lamp Warranty

The PID-004 11.7 eV PID sensor's lamp (RKI P/N 51-1504) is susceptible to humidity and its service life is not as long as lamps in other PID sensors sold by RKI Instruments, Inc. For this reason, the PID-004 11.7 eV sensor's lamp is warranted for 2 months from the date of shipment.

Description

Instrument

A GX-6100 that contains an 11.7 eV PID sensor is shipped with a black rubber cap plugging the inlet fitting. This rubber cap helps prolong the life of the 11.7 eV PID sensor by preventing ambient moisture from entering the flow system. This rubber cap should be installed back onto the inlet fitting before storing the GX-6100. See page 242 for complete storage recommendations.

Sensor

The PID sensor is a cylindrical sensor with a diffusion opening on the front and 3 pins on the back. It is installed in a white housing that has three sockets on the bottom that mate with the GX-6100 instrument. The PID sensor must always be installed in the first smart sensor position which is located in the top left corner of the sensor block.

The 11.7 eV PID sensor's lamp is susceptible to humidity. Pg.242 outlines RKI Instruments, Inc.'s recommendations for prolonging the life of the sensor's lamp.

Dehumidifier Filter

Every GX-6100 that contains an 11.7 eV PID sensor is shipped with a calcium chloride dehumidifier filter. The dehumidifier filter is shipped with clear tubing connecting both ends together to preserve the life of the filter. Remove the tubing from one end of the filter and draw through the filter before turning off the GX-6100 in order to purge any moisture from the flow system.

The filter should be replaced when it appears wet.

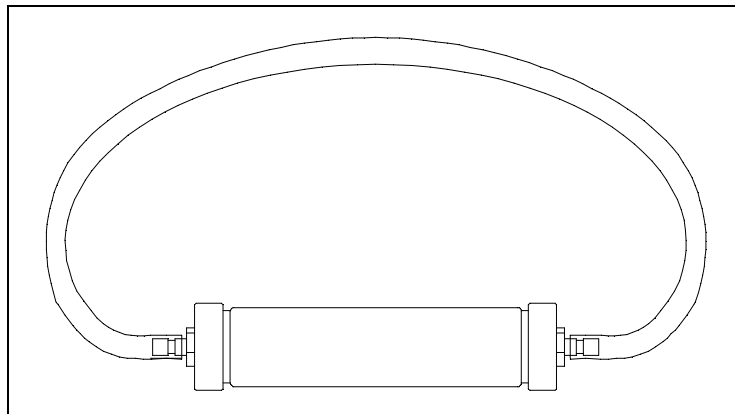

Start Up

The instructions for starting up a GX-6100 with a 11.7 eV PID sensor installed are the same as described in “Start Up” on page 28 with the following exceptions:

- Remove the black cap from the inlet fitting before turning on the instrument.
- The screens shown in Step 8 appear as shown below.

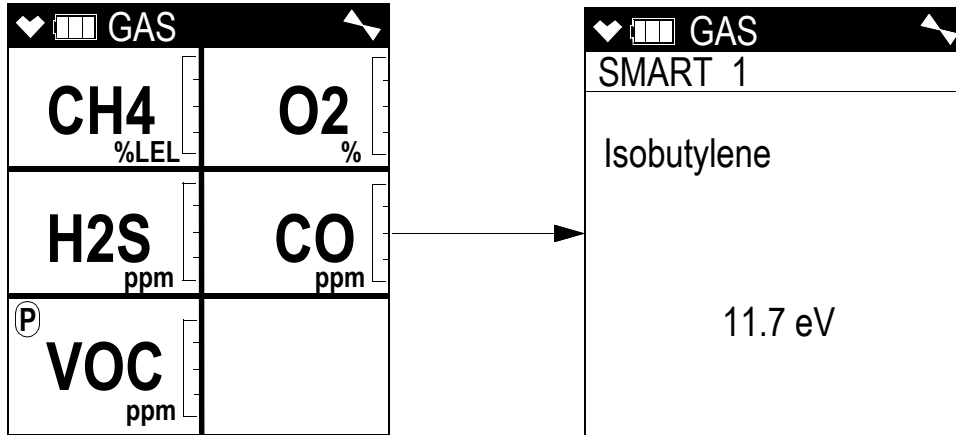

Display Mode

Display Mode for a 11.7 eV PID instrument appears and functions as described in “Chapter 4: Display Mode” on page 55 with the following exception:

- The PID Gas Name Screen operates as described on page 61 but appears as shown below. If there are 2 PID sensors installed in your GX-6100, the PID Gas Name Screens will appear in Display Mode in the following order regardless of their position in the flow system: 10.0 eV/benzene, 10.6 eV, 11.7 eV.

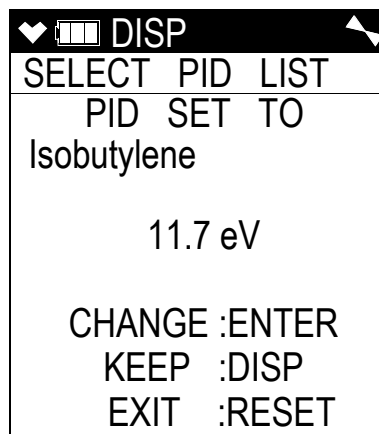

Measuring Mode

The 11.7 eV PID sensor detects VOCs in the 0-1000 ppm range. In the 0-100 ppm range, the reading increment is 0.1 ppm. In the 100-1000 ppm range, the reading increment is 1 ppm. See page 37 for a complete description of Measuring Mode.

Turning Off a GX-6100 with an 11.7 eV PID Sensor

Eliminating as much moisture from the flow system as possible before turning off the GX-6100 will help prolong the life of the 11.7 eV PID sensor's lamp.

1. Remove the tubing from one end of the dehumidifier filter. It does not matter which end you remove. The dehumidifier filter does not have a flow direction. Do not use the dehumidifier filter if it appears wet.
2. Connect the tubing to the GX-6100's inlet.

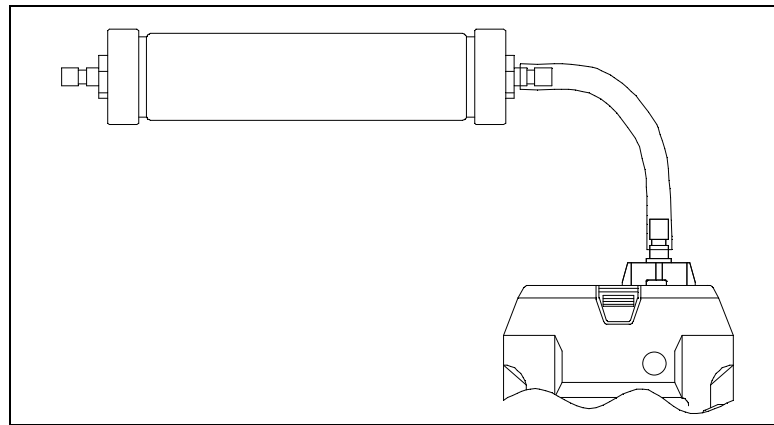

3. Allow the GX-6100 to draw through the filter for 30 seconds.
4. Turn off the GX-6100.
5. Remove the tubing from the inlet fitting and immediately plug the inlet fitting with the black rubber cap.

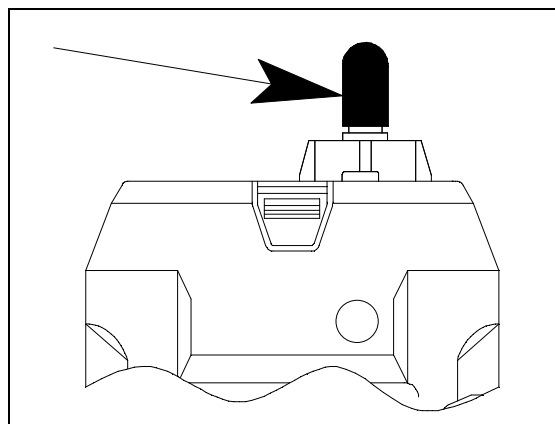

- Reconnect the tubing to the open end of the dehumidifier filter to help preserve its life. If the filter begins to appear wet, it needs to be replaced.

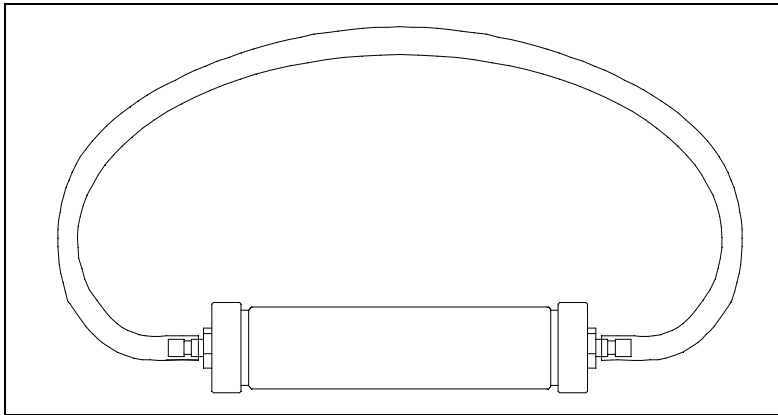

Calibrating the 11.7 eV PID Sensor

Setting the Fresh Air Reading

See “Setting the Fresh Air Reading” on page 87 for instructions to set the fresh air reading.

Performing a SPAN CAL

See “Performing a Span Adjustment” on page 93 for instructions to perform an automatic calibration while keeping the following in mind:

- If the 11.7 eV PID sensor is one of two PID sensors installed in your instrument, both channels may appear as “VOC”. The channel that appears first will be based on the following sensor priority. Be sure to select the correct PID sensor for calibration.

High Priority ↓ Low Priority	10.6 eV low range PID
	10.0 eV/benzene PID
	11.7 eV PID
	10.6 eV high range PID
	ESS-03 Cl ₂
	MOS sensors
	ESS-03 NH ₃
	IR and other ESS-03 sensors

NOTE: If you have changed the factory-set channel assignments using the GX-6100 Configuration Program, the order of displayed sensors may be different and you will need to remember how you set your instrument up.

- When turning off the GX-6100 after performing a calibration, follow the instructions on page 242.

Maintenance

Replacing the Dehumidifier Filter

RKI Instruments, Inc. recommends replacing the dehumidifier filter when it looks wet.

Replacing a Sensor

See page 134 for sensor replacement instructions.

Replacing the PID Sensor's Lamp and Electrode Stack

RKI Instruments, Inc. recommends that you replace the electrode stack every time you replace the lamp. However, if you replace only the lamp and notice that the instrument is operating properly, it is not necessary to change the electrode stack.

See page 142 and page 146 for PID sensor maintenance instructions keeping in mind the following differences in spare parts.

Part Number	Description
33-0564	PID sensor electrode stack, 11.7 eV sensor
51-1504	PID sensor replacement lamp, 11.7 eV sensor
PID-004	PID sensor, 11.7 eV

Cleaning the 11.7 eV PID Sensor's Lamp

Do not attempt to clean the 11.7 eV lamp. The cleaning process is likely to contaminate the lamp with moisture which shortens its service life.

Parts List for 11.7 eV PID Instruments

Table 35: Spare Parts List for 11.7 eV PID Instruments

Part Number	Description
07-0220	Rubber cap, black, for dehumidifier filter and inlet fitting
33-0560RK	PID sensor electrode stack, 11.7 eV sensor, 2 stacks

Part Number	Description
33-0560-01	PID sensor electrode stack, 11.7 eV sensor, 1 stack
33-2125-01	Dehumidifier filter with tubing
51-1504	PID sensor replacement lamp, 11.7 eV sensor
81-0103RK-03	Calibration cylinder, isobutylene, 100 ppm in air, 103 liter
81-0103RK-04	Calibration cylinder, isobutylene, 100 ppm in air, 34 liter aluminum
81-0143RK-02	Calibration cylinder, 5-gas (Proprietary blend of IBL, CH ₄ , O ₂ , H ₂ S, CO), 58 liter
81-0143RK-04	Calibration cylinder, 5-gas (Proprietary blend of IBL, CH ₄ , O ₂ , H ₂ S, CO), 34 liter aluminum
81-1054RK	Regulator, demand-flow type, for Cl ₂ , HCN, and NH ₃ in 34-liter aluminum, 58-liter, and 103-liter calibration cylinders (cylinders with internal threads)
81-1054RK-H2S	Regulator, demand-flow type, for CO, CO ₂ , H ₂ S, N ₂ , NO ₂ , PH ₃ , SO ₂ , zero air, and combustible gases in 34-liter aluminum, 58-liter, and 103-liter calibration cylinders (cylinders with internal threads)
81-1055RK	Regulator, demand-flow type, for all gases in 17- and 34-liter steel cylinders (cylinders with external threads)
81-6ABX-DLV	Calibration kit: 34 liter five-gas (IBL/CH ₄ /O ₂ /H ₂ S/CO) cylinder, demand flow regulator, calibration tubing
PID-004	PID sensor, 11.7 eV

Product Warranty

RKI Instruments, Inc. warrants the GX-6000 sold by us to be free from defects in materials, workmanship, and performance for a period of three years from the date of shipment from RKI Instruments, Inc. Original and replacement 4-gas sensors are warranted for 3 years. Original and replacement IR and ESS-03 sensors (except Cl₂) are warranted for 2 years. Original and replacement ESS-03 Cl₂, TC, and PID sensors (except for 11.7 eV) are warranted for 1 year. Replacement parts are warranted for 1 year from the date of their shipment from RKI Instruments, Inc. The 11.7 eV PID sensor's lamp is warranted for 2 months from date of shipment from RKI Instruments, Inc. Any parts found defective within their warranty period will be repaired or replaced, at our option, free of charge. This warranty does not apply to those items which by their nature are subject to deterioration or consumption in normal service, and which must be cleaned, repaired, or replaced on a routine basis. Examples of such items are:

- Absorbent cartridges
- Filter elements, disks, or sheets
- Pump diaphragms and valves
- PID sensor electrode stacks

Warranty is voided by abuse including mechanical damage, alteration, rough handling, or repair procedures not in accordance with instruction manual. This warranty indicates the full extent of our liability, and we are not responsible for removal or replacement costs, local repair costs, transportation costs, or contingent expenses incurred without our prior approval.

THIS WARRANTY IS EXPRESSLY IN LIEU OF ANY AND ALL OTHER WARRANTIES AND REPRESENTATIONS, EXPRESSED OR IMPLIED, AND ALL OTHER OBLIGATIONS OR LIABILITIES ON THE PART OF RKI INSTRUMENTS, INC. INCLUDING BUT NOT LIMITED TO, THE WARRANTY OF MERCHANTABILITY OR FITNESS FOR A PARTICULAR PURPOSE. IN NO EVENT SHALL RKI INSTRUMENTS, INC. BE LIABLE FOR INDIRECT, INCIDENTAL, OR CONSEQUENTIAL LOSS OR DAMAGE OF ANY KIND CONNECTED WITH THE USE OF ITS PRODUCTS OR FAILURE OF ITS PRODUCTS TO FUNCTION OR OPERATE PROPERLY.

This warranty covers instruments and parts sold to users only by authorized distributors, dealers and representatives as appointed by RKI Instruments, Inc.

We do not assume indemnification for any accident or damage caused by the operation of this gas monitor and our warranty is limited to replacement of parts or our complete goods.