



User Manual for HE-RCC6512



MAN1133-09.1-EN_RCC6512_UM

PREFACE

This manual explains how to use the RCC6512.

Copyright© 2018 Horner APG, LLC, 59 South State Avenue, Indianapolis, Indiana 46201. All rights reserved. No part of this publication may be reproduced, transmitted, transcribed, stored in a retrieval system, or translated into any language or computer language, in any form by any means, electronic, mechanical, magnetic, optical, chemical, manual or otherwise, without the prior agreement and written permission of Horner APG, Inc.

All software described in this document or media is also copyrighted material subject to the terms and conditions of the Horner Software License Agreement.

Information in this document is subject to change without notice and does not represent a commitment on the part of Horner APG.

Ethernet™ is a trademark of Xerox Corporation.
microSD™ and CompactFlash are registered trademarks of SanDisk Corporation.

For user manual updates, contact Technical Support:

North America:

Tel: (+) (317) 916-4274

Fax: (+) (317) 639-4279

Web: <http://www.hornerautomation.com>

Email: techsppt@heapg.com

Europe:

Tel: (+) 353-21-4321-266

Fax: (+) 353-21-4321-826

Web: <https://www.hornerautomation.eu/>

Email: technical.support@horner-apg.com

LIMITED WARRANTY AND LIMITATION OF LIABILITY

Horner APG, LLC, ("HE-APG") warrants to the original purchaser that the RCC6512 (HE-XP) OCS module manufactured by HE-APG is free from defects in material and workmanship under normal use and service. The obligation of HE-APG under this warranty shall be limited to the repair or exchange of any part or parts which may prove defective under normal use and service within two (2) years from the date of manufacture or eighteen (18) months from the date of installation by the original purchaser whichever occurs first, such defect to be disclosed to the satisfaction of HE-APG after examination by HE-APG of the allegedly defective part or parts. THIS WARRANTY IS EXPRESSLY IN LIEU OF ALL OTHER WARRANTIES EXPRESSED OR IMPLIED INCLUDING THE WARRANTIES OF MERCHANTABILITY AND FITNESS FOR USE AND OF ALL OTHER OBLIGATIONS OR LIABILITIES AND HE-APG NEITHER ASSUMES, NOR AUTHORIZES ANY OTHER PERSON TO ASSUME FOR HE-APG, ANY OTHER LIABILITY IN CONNECTION WITH THE SALE OF THIS RCC6512 module. THIS WARRANTY SHALL NOT APPLY TO THIS RCC6512 module OR ANY PART THEREOF WHICH HAS BEEN SUBJECT TO ACCIDENT, NEGLIGENCE, ALTERATION, ABUSE, OR MISUSE. HE-APG MAKES NO WARRANTY WHATSOEVER IN RESPECT TO ACCESSORIES OR PARTS NOT SUPPLIED BY HE-APG. THE TERM "ORIGINAL PURCHASER", AS USED IN THIS WARRANTY, SHALL BE DEEMED TO MEAN THAT PERSON FOR WHOM THE RCC6512 module IS ORIGINALLY INSTALLED. THIS WARRANTY SHALL APPLY ONLY WITHIN THE BOUNDARIES OF THE CONTINENTAL UNITED STATES.

In no event, whether as a result of breach of contract, warranty, tort (including negligence) or otherwise, shall HE-APG or its suppliers be liable of any special, consequential, incidental or penal damages including, but not limited to, loss of profit or revenues, loss of use of the products or any associated equipment, damage to associated equipment, cost of capital, cost of substitute products, facilities, services or replacement power, down time costs, or claims of original purchaser's customers for such damages.

To obtain warranty service, return the product to your distributor with a description of the problem, proof of purchase, postpaid, insured, and in a suitable package.

ABOUT PROGRAMMING EXAMPLES

Any example programs and program segments in this manual or provided on accompanying diskettes are included solely for illustrative purposes. Due to the many variables and requirements associated with any particular installation, Horner APG cannot assume responsibility or liability for actual use based on the examples and diagrams. It is the sole responsibility of the system designer utilizing the RCC6512 module to appropriately design the end system, to appropriately integrate the RCC6512 module and to make safety provisions for the end equipment as is usual and customary in industrial applications as defined in any codes or standards which apply.

NOTE: The programming examples shown in this manual are for illustrative purposes only. Proper machine operation is the sole responsibility of the system integrator.

VISUAL MAP OF KEY CHAPTERS

FIRST STEP of ANY TASK: DATASHEET			
<p>Each RCC6512 unit is sent with a datasheet in the box. The datasheet (MAN1134) is the first document to refer to for information related to RCC6512 model and other key installation information. To obtain updates to the datasheet, manual, and user documentation, visit a Horner website.</p> <p>North America http://www.hornerautomation.com Europe https://www.hornerautomation.eu/</p>			
QUICK START	INSTALLATION	PROGRAMMING	TROUBLESHOOTING
Safety / Compliance	Safety / Compliance	Safety / Compliance	Safety / Compliance
Introduction	Introduction	Introduction	Introduction
	Mechanical Installation	Serial Communications	Fail / Safe
	Electrical Installation	CAN Communications	Maintenance
		Ethernet Communications	Modbus Communication
		Removable Media	Troubleshooting
		General I/O	
		High Speed I/O	
		Cscape Configuration	
		Registers	
		Modbus Communications	

TABLE OF CONTENTS

PREFACE 2

LIMITED WARRANTY AND LIMITATION OF LIABILITY 3

ABOUT PROGRAMMING EXAMPLES..... 3

VISUAL MAP OF KEY CHAPTERS..... 4

TABLE OF CONTENTS 5

CHAPTER 1: SAFETY / COMPLIANCE 8

 1.1 Safety Warnings and Guidelines 8

 1.2 Grounding..... 9

 1.3 Compliance 9

CHAPTER 2: INTRODUCTION..... 10

 2.1 Visual Overview of RCC6512 OCS 10

 2.2 Connectivity to the RCC6512..... 12

 2.3 Features of RCC6512 13

 2.4 Required and Suggested Accessories 14

CHAPTER 3: MECHANICAL INSTALLATION..... 15

 3.1 Overview..... 15

 3.2 Mounting Requirements 15

 3.3 RCC6512 Dimensions 16

CHAPTER 4: ELECTRICAL INSTALLATION 18

 4.1 Grounding Definition 18

 4.2 Ground Specifications 18

 4.3 How to Test for Good Ground 19

 4.4 Primary Power Port 20

CHAPTER 5: REGISTERS..... 21

 5.1 Register Definitions 21

 5.2 Useful %S and %SR registers..... 21

 5.3 Register Map for RCC6512 I/O 30

 5.4 Resource Limits 30

CHAPTER 6: CSCAPE CONFIGURATION 31

 6.1 Overview..... 31

 6.2 Cscape Status Bar 31

 6.3 Establishing Communications 32

 6.4 Configuration 43

 6.5 Digital / HSC Input Configuration..... 44

 6.6 Digital / PWM Output Configuration..... 46

 6.7 Analog Input Configuration 47

 6.8 Analog Output Configuration 48

 6.9 Scaling Analog Inputs..... 49

CHAPTER 7: GENERAL I/O 51

 7.1 Overview..... 51

 7.2 I/O Overview..... 51

 7.3 Solid-State Digital Outputs 52

- 7.4 Digital Inputs..... 53
- 7.5 Analog Inputs 54
- 7.6 Analog Outputs..... 55
- CHAPTER 8: HIGH SPEED I/O (HSC / PWM) 56
 - 8.1 Overview..... 56
 - 8.2 Glossary..... 56
 - 8.3 High Speed Counter (HSC) Functions 57
 - 8.4 HSC Functions Register Map 60
 - 8.5 High Speed Output Functions 64
 - 8.6 High Speed Output Functions Register Map..... 65
 - 8.7 PWM Examples..... 66
- CHAPTER 9 SERIAL COMMUNICATIONS..... 68
 - 9.1 Overview..... 68
 - 9.2 Port Descriptions..... 68
 - 9.3 Serial Port Pinouts..... 68
 - 9.4 RS485 Termination and Biasing..... 69
 - 9.5 Cscape Programming via Serial Port 69
 - 9.6 Ladder-Controlled Serial Communication..... 69
- CHAPTER 10: CAN COMMUNICATIONS 70
 - 10.1 Overview..... 70
 - 10.2 Port Description..... 70
 - 10.3 Setting ID Switches 71
 - 10.4 CAN and Power Port Wiring..... 72
 - 10.5 Cscape Programming via CAN 72
 - 10.6 Ladder-Controlled CAN Communication 72
 - 10.7 Using CAN for I/O Expansion (Network I/O)..... **Error! Bookmark not defined.**
- CHAPTER 11: ETHERNET COMMUNICATION..... 73
 - 11.1 Ethernet Module Protocols and Features 73
 - 11.2 Ethernet System Requirements 73
 - 11.3 Ethernet Module Specifications..... 73
 - 11.4 Ethernet Module Configuration 74
- CHAPTER 12: REMOVABLE MEDIA 78
 - 12.1 Overview..... 78
 - 12.2 microSD Cards 78
 - 12.3 microSD File System..... 78
 - 12.4 Using Removable Media to Load and Save Applications 79
 - 12.5 Removable Media (RM) Function Blocks in Cscape..... 79
 - 12.6 Filenames used with the Removable Media (RM) Function Blocks 80
 - 12.7 System Registers used with RM 81
- CHAPTER 13: FAIL-SAFE SYSTEM 83
 - 13.1 Overview..... 83
 - 13.2 Settings..... 83
 - 13.3 Backup / Restore Data 84
 - 13.4 AutoLoad 86
 - 13.5 AutoRun..... 88
- CHAPTER 14: MAINTENANCE 89
 - 14.1 Firmware Updates..... 89
 - 14.2 Replacing Backup Battery 91
- CHAPTER 15: MODBUS COMMUNICATIONS..... 93

15.1	Modbus Overview	93
15.2	Modbus Slave Overview	93
15.3	Modbus Addressing Table for RCC Units.....	94
CHAPTER 16: TROUBLESHOOTING / TECHNICAL SUPPORT		95
16.1	LED - Normal Functionality	95
16.2	LED Load Program/Firmware Functionality.....	95
16.3	Switch - Normal Functionality	96
16.4	LED - Diagnostic Functionality.....	96
16.5	Connecting to the RCC6512	97
16.6	CsCAN Network.....	99
16.7	Removable Media - Basic Troubleshooting.....	100
16.8	Technical Support Contacts.....	100
MAIN INDEX		101

CHAPTER 1: SAFETY / COMPLIANCE

1.1 Safety Warnings and Guidelines

When found on the product, the following symbols specify:



Warning: Consult user documentation.



Warning: Electrical Shock Hazard.

WARNING - EXPLOSION HAZARD - Do not disconnect equipment unless power has been switched off or the area is known to be non-hazardous

WARNING: To avoid the risk of electric shock or burns, always connect the safety (or earth) ground before making any other connections.

WARNING: To reduce the risk of fire, electrical shock, or physical injury it is strongly recommended to fuse the voltage measurement inputs. Be sure to locate fuses as close to the source as possible.

WARNING: Replace fuse with the same type and rating to provide protection against risk of fire and shock hazards.

WARNING: In the event of repeated failure, do not replace the fuse again as a repeated failure indicates a defective condition that will not clear by replacing the fuse.

WARNING: EXPLOSION HAZARD—Substitution of components may impair suitability for Class I, Division 2.

WARNING: The USB parts are for operational maintenance only. Do not leave permanently connected unless area is known to be non-hazardous.

WARNING: EXPLOSION HAZARD—BATTERIES MUST ONLY BE CHANGED IN AN AREA KNOWN TO BE NON-HAZARDOUS

WARNING: Battery May Explode If Mistreated. Do Not Recharge, Disassemble or Dispose Of In Fire.

WARNING: Only qualified electrical personnel familiar with the construction and operation of this equipment and the hazards involved should install, adjust, operate, or service this equipment. Read and understand this manual and other applicable manuals in their entirety before proceeding. Failure to observe this precaution could result in severe bodily injury or loss of life.

- a. All applicable codes and standards need to be followed in the installation of this product.
- b. For I/O wiring (discrete), use the following wire type or equivalent: Belden 9918, 18 AWG, or larger.

Adhere to the following safety precautions whenever any type of connection is made to the module.

- a. Connect the green safety (earth) ground first before making any other connections.
- b. When connecting to electric circuits or pulse-initiating equipment, open their related breakers. Do not make connections to live power lines.
- c. Make connections to the module first; then connect to the circuit to be monitored.
- d. Route power wires in a safe manner in accordance with good practice and local codes.
- e. Wear proper personal protective equipment including safety glasses and insulated gloves when making connections to power circuits.
- f. Ensure hands, shoes, and floors are dry before making any connection to a power line.
- g. Make sure the unit is turned OFF before making connection to terminals. Make sure all circuits are de-energized before making connections.
- h. Before each use, inspect all cables for breaks or cracks in the insulation. Replace immediately if defective.

1.2 Grounding

Grounding is covered in various chapters within this manual.

1.3 Compliance

To check for compliance and updates, visit the Horner website.

North America <https://hornerautomation.com>
Europe <https://www.hornerautomation.eu/>

CHAPTER 2: INTRODUCTION

2.1 Visual Overview of RCC6512 OCS

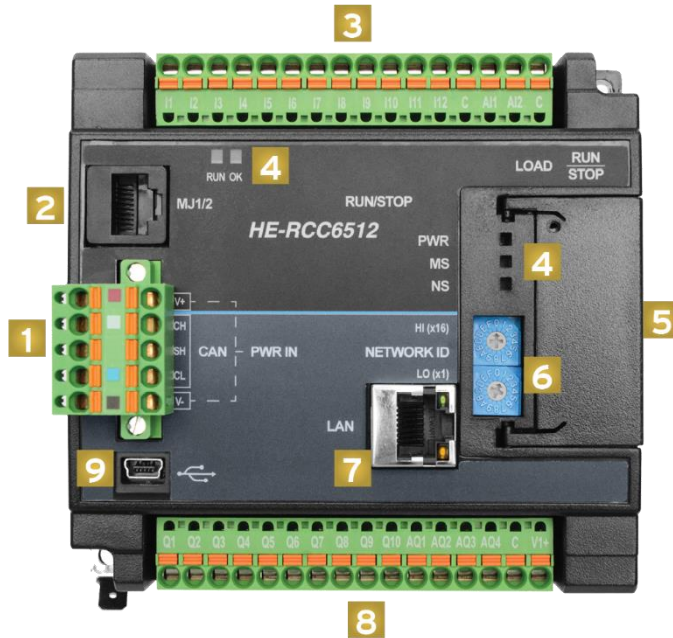

1. Power/CAN Connector
2. Serial Port
3. Input Connector - J2
4. Status LEDs
5. Door
6. Network ID Switches
7. Ethernet Port
8. Output Connector -J1
9. Mini USB Port
10. microSD Slot
11. LOAD / RUN|STOP buttons

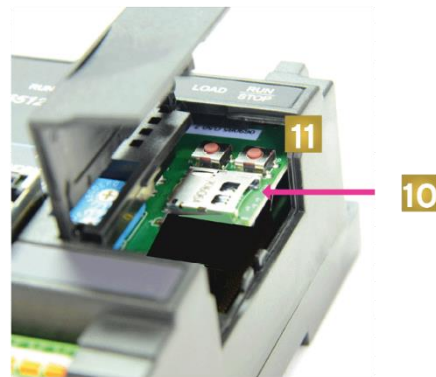

Figure 2.1 - Overview of the RCC6512

2.1.1 *Where to Find Information about the RCC6512*

a) **Datasheet [MAN1134]**- The **datasheet is the first document to refer to for key information** related to specific RCC6512 models.

1. The datasheets for all RCC6512 models are available on the Horner websites.
2. Datasheets contain pin-outs and other model specific information.

b) **User Manual** -This manual provides general information that is common to RCC6512 models and can be downloaded from our website to obtain user documentation and updates.

North America <http://www.hornerautomation.com>

Europe <https://www.hornerautomation.eu/>

2.1.2 *Four Main Types of Information are covered in this manual*

- a) Safety and Installation guidelines / instructions (Mechanical and Electrical)
- b) Descriptions of hardware features: serial ports, removable media, communication options, etc.
- c) Configuration and Use of the RCC6512
- d) Maintenance and Support

2.1.3 *Manual Index*

Major topics of interest may be found in the [Index](#) towards the end of this manual.

2.2 Connectivity to the RCC6512

The RCC6512 has excellent capabilities for connecting to a variety of devices. The diagram below shows some examples of devices that can be used with the RCC6512.

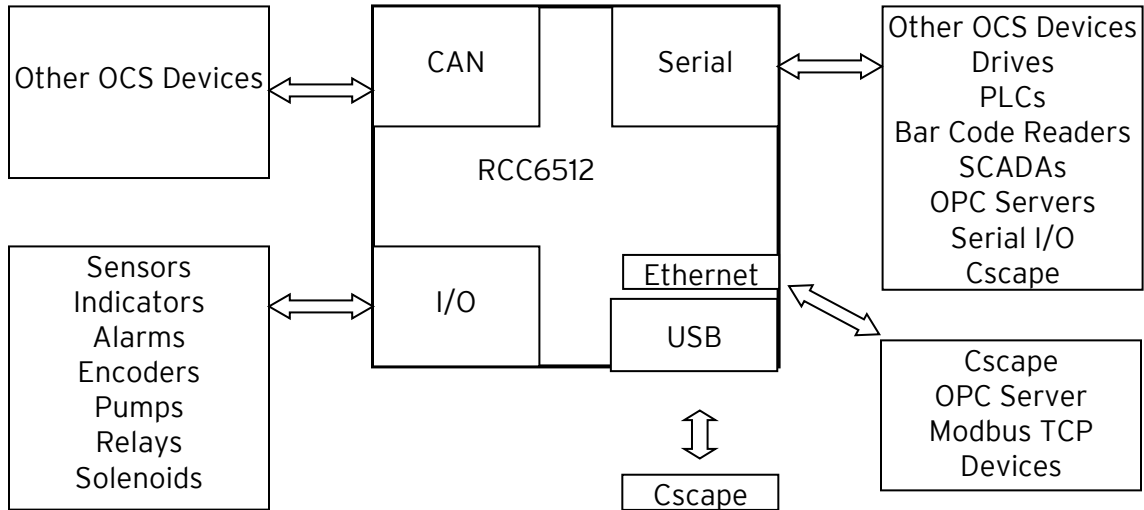

Figure 2.2 - Visual Overview of Types of Devices that can be connected to RCC6512

2.3 Features of RCC6512

The RCC6512 is a general purpose controller with specialized I/O to handle high speed applications. This device combines control, high-speed digital I/O, analog I/O and networking into a single, integrated package. Unique features of the RCC6512 include:

- High performance CPU for control processing and communications.
- Hardware high-speed I/O accelerator for handling high-speed input and outputs.
- Advanced control capabilities including floating point.
- Removable media for up to 32GB of storage of programs or data logging.
- CsCAN networking port for communication with remote I/O, other controllers or PCs.
- Rotary switches for network ID setting
- USB controller programming port.
- Two serial ports one RS232 the other RS485 in a single connector.
- Four -10V to +10V analog outputs
- Two 0V to +10V or 0mA to 20mA analog inputs
- Twelve high-speed inputs for counting applications.
- Ten sourcing high-speed outputs. Eight can be tied to PWM or HSC applications.
- Cscape programming software that allows all aspects of the RCC6512 to be programmed and configured from one integrated application.
- One on board Ethernet ports (10/100Mbps) for Cscape programming and application defined communication, with Auto MDI/MDI-X, Modbus TCP C/S, HTTP, FTP, SMTP, and Ethernet IP.
- Eight high-speed counters that support totalizing, frequency counting, pulse width measurement, period measurement or quadrature. Max High Speed Frequency is 500kHz.
- High speed disable, latch, load, clear, marker, and match options.
- Programmable polarity
- Programmable input threshold for zero cross, 5V, 12V and 24V signals
- Programmable input filtering for 500kHz, 50kHz, and 5kHz
- High speed output functions for PWM or camming

2.4 Required and Suggested Accessories

Please visit the Horner Control Accessories website for communication, programming, and I/O accessories.

North America <http://hornerautomation.com/product-category/home/control-accessories/>
Europe <http://www.horner-apg.com/en/products.aspx>

Visit our website to obtain user documentation, supplemental documents, certificates, and other documentation.

North America <https://hornerautomation.com>
Europe <https://www.hornerautomation.eu/>

CHAPTER 3: MECHANICAL INSTALLATION

NOTE: The datasheet is the first document to refer to for model-specific information related to the RCC6512. Visit the Horner websites to obtain datasheets, user documentation, and updates.

3.1 Overview

The mechanical installation greatly affects the operation, safety and appearance of the system. Information is provided to mechanically install the unit such as cut-out sizes, mounting procedures, and other recommendations for the proper mechanical installation of the unit.

3.2 Mounting Requirements

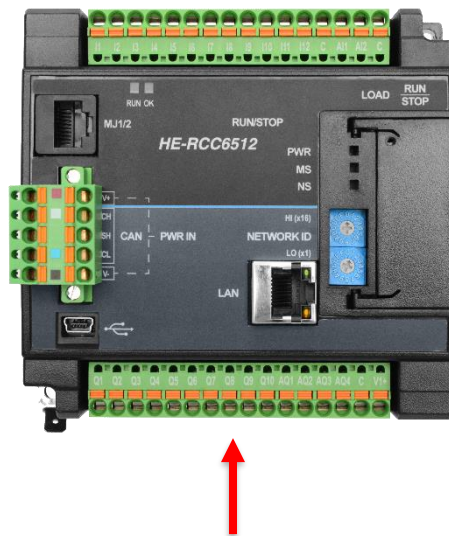

DIN Rail Clip is located on back of the unit.

NOTE: Screw holes and a spade connector for grounding are available for a mounting option.

DIN Rail Mounting

Be sure the DIN rail is in a horizontal position before installing the unit. The orientation shown to the right is necessary to prevent the unit from slipping off the DIN rail.

Align the unit on the DIN rail then push the DIN rail clip to until it clicks into place. Check to ensure that the unit is secure on the DIN rail.

Do NOT mount the unit on its side as this may cause the unit from slipping off the DIN rail.

3.3 RCC6512 Dimensions

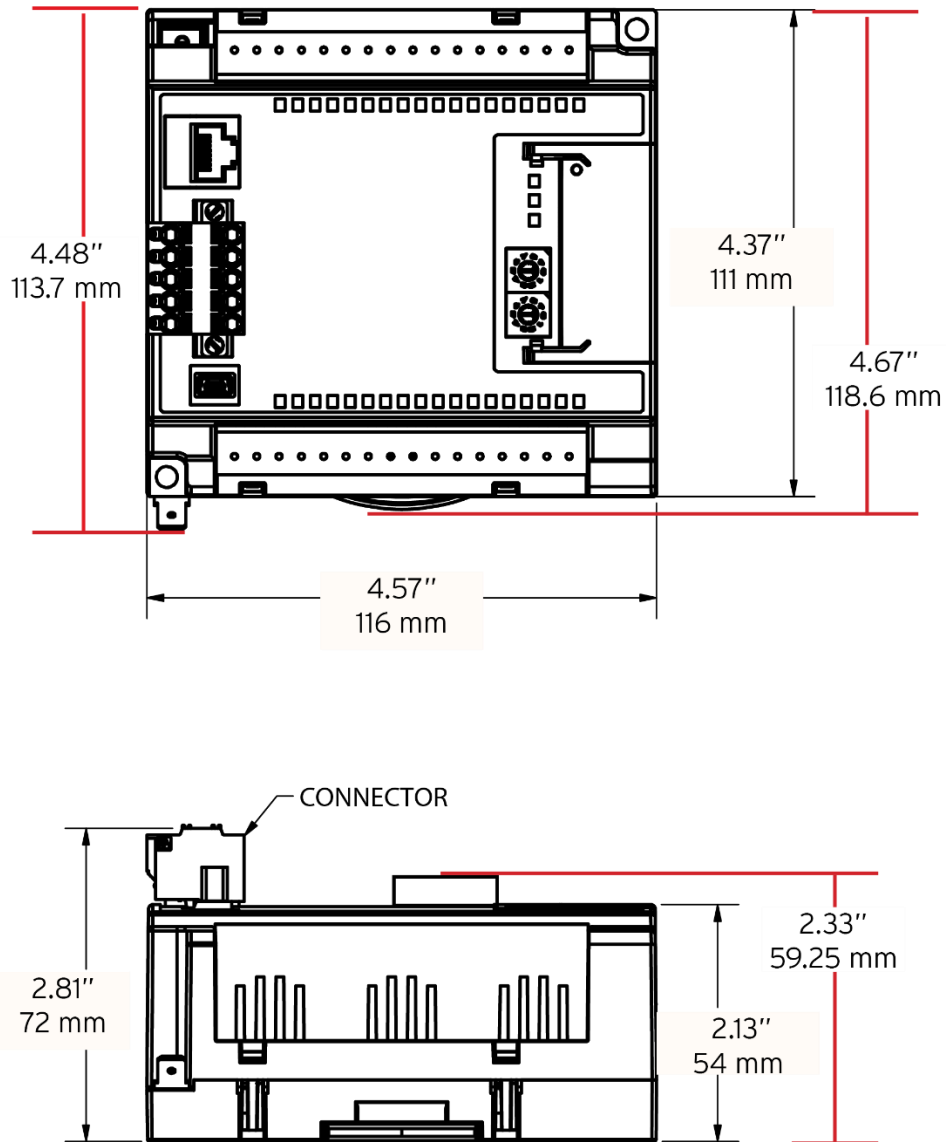

Figure 3.1- RCC6512 Dimensions

3.3.1 Temperature / Ventilation

Ensure that the DIN Rail layout design allows for adequate ventilation and maintains the specified ambient temperature range. Consider the impact on the design if operating at the extreme ends of the ambient temperature range. For example, if it is determined that a cooling device is required, allow adequate space and clearances for the device in the panel box or on the panel door if DIN rail is mounted inside.

3.3.2 Orientation

RCC should be mounted with locking DIN tab facing down.

3.3.3 Noise

Consider the impact on the panel layout design and clearance requirements if noise suppression devices are needed. Be sure to maintain an adequate distance between the RCC and noisy devices such as relays, motor starters, etc.

For details on output protection, especially when using contactors and solenoids see MAN0962.

3.3.4 Shock and Vibration

The RCC6512 has been designed to operate in typical industrial environments that may inflict some shock and vibration on the unit. For applications that may inflict excessive shock and vibration please use proper dampening techniques or relocate the RCC6512 to a location that minimizes shock and/or vibration.

CHAPTER 4: ELECTRICAL INSTALLATION

NOTE: The datasheet is the first document to refer to for model-specific information related to RCC6512 models such as pin-outs and other key installation information. Visit the Horner websites to obtain datasheets, user documentation, and updates.

4.1 Grounding Definition

Ground: The term *ground* is defined as a conductive connection between a circuit or piece of equipment and the earth. Grounds are fundamentally used to protect an application from harmful interference causing either physical damage such as by lightning or voltage transients or from circuit disruption often caused by radio frequency interference (RFI). Grounding is also for the safety of the user.

4.2 Ground Specifications

Ideally, a ground resistance measurement from equipment to earth ground is 0Ω . In reality, it typically is higher. The U.S. National Electrical Code (NEC) states the resistance to ground shall **not** exceed 25Ω . Horner APG recommends **less than** 15Ω resistance from our equipment to ground. Resistance **greater than** 25Ω can cause undesirable or harmful interference to the device.

4.3 How to Test for Good Ground

In order to test ground resistance, a Ground Resistance Tester must be used. A typical Ground Resistance Meter Kit contains a meter, two or three wire leads, and two ground rods. Instructions are supplied for either a two-point or three-point ground test.

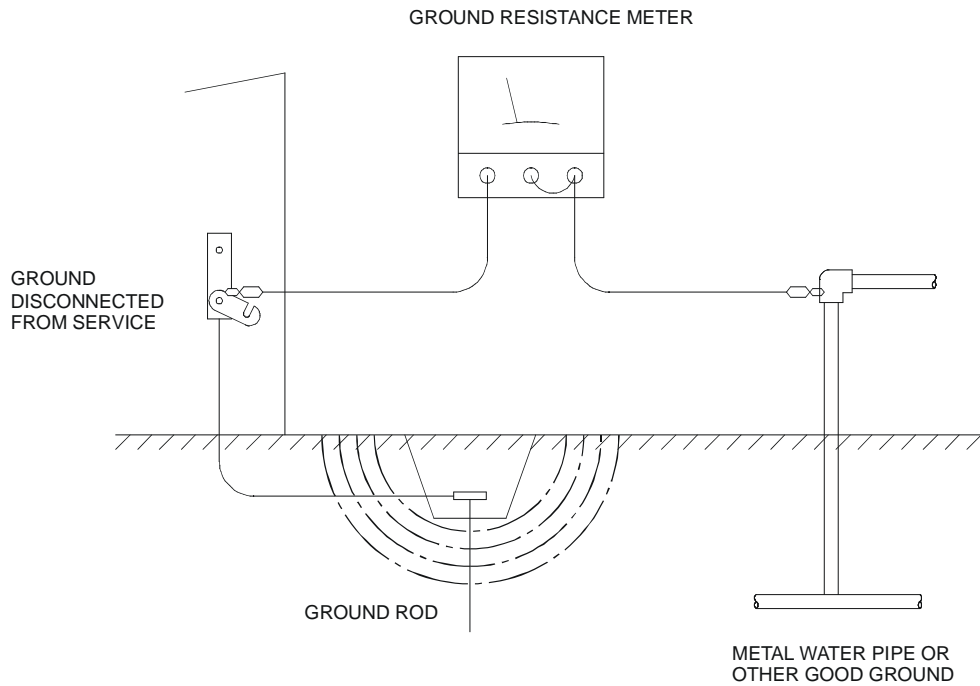

Figure 4.1 - Two-Point Ground Connection Test

4.4 Primary Power Port

The DC power is on the same connector as the CAN connections. Power is 10-28VDC.

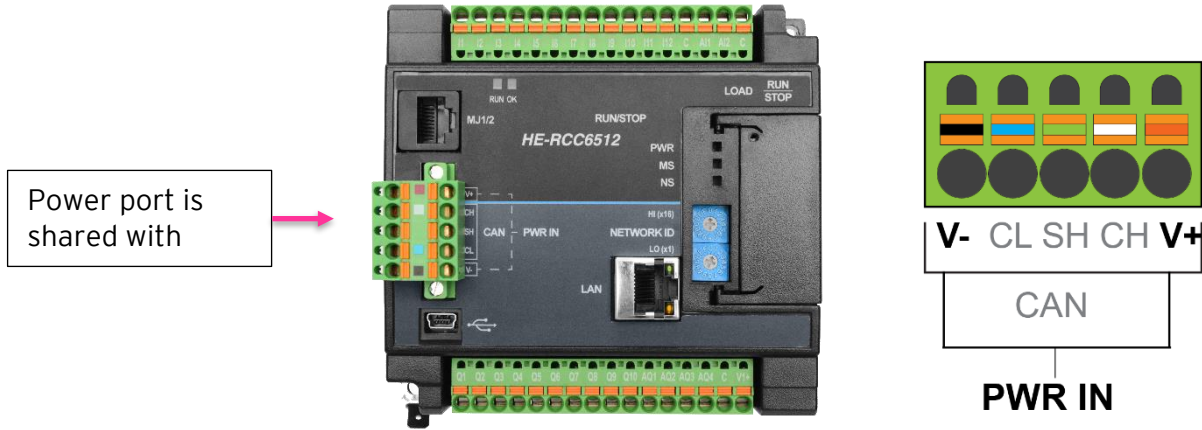

Figure 4.1 - Primary Power Port as Viewed Looking at the RCC6512

CHAPTER 5: REGISTERS

5.1 Register Definitions

When programming the RCC6512, data is stored in memory that is segmented into different types. This memory in the controller is referred to as registers. Different groups of registers are defined as either bits or words (16 bits). Multiple registers can usually be used to handle larger storage requirements. For example, 16 single bit registers can be used to store a word, or two 16-bit registers can be used to store a 32-bit value.

NOTE: The RCC6512 supports 256 retentive registers. Values such as setpoints, should be set via ladder programming, communications or loaded from the removable memory.

Table 5.1 - Types of Registers in the RCC6512	
%AI Analog Input	16-bit input registers used to gather analog input data such as voltages, temperatures, and speed settings coming from an attached device.
%AQ Analog Output	16-bit output registers used to send analog information such a voltages, levels or speed settings to an attached device.
%I Digital Input	Single-bit input registers. Typically, an external switch is connected to the registers.
%M Non-Retentive Bit	Non-retentive single-bit registers.
%Q Digital Output	Single-bit output registers. Typically, these bits are connected to an actuator, indicator light or other physical outputs.
%R General Purpose Register	2048 (256 Retentive)
%S System Bit	Single-bit bit coils predefined for system use.
%SR System Register	16-bit registers predefined for system use.
%T Temporary Bit	Non-retentive single-bit registers.

5.2 Useful %S and %SR registers

Table 5.2 - Common %S Register Definitions		
Register	Name	Description
%S1	FST_SCN	Indicate First Scan
%S2	NET_OK	Network is OK
%S3	T_10MS	10mS timebase
%S4	T_100MS	100mS timebase
%S5	T_1SEC	1 second timebase
%S6	IO_OK	I/O is OK
%S7	ALW_ON	Always ON
%S8	ALW_OFF	Always OFF
%S9	PAUSING_SCN	Pause 'n Load soon
%S10	RESUMED_SCN	Pause 'n load done
%S11	FORCE	I/O being forced
%S12	FORCE_EN	Forcing is enabled
%S13	NET_IO_OK	Network I/O is OK

Table 5.3 - %SR Registers - Master %SR Table Error! Bookmark not defined.

Register	Default I/O Name	Description	Min-Max Values	Program (Read/Write)	Display (Read/Write)
%SR1	USER_SCR	User Screen Number *Excludes RCC Units	0 to 1023	Read/Write	Read/Write
%SR2	ALRM_SCR	Alarm Screen Number (0=none) *Excludes RCC Units	0 to 1023	Read Only	Read Only
%SR3	SYS_SCR	System Screen Number 1= Main System Menu 2= Set Network ID, Network Status, (%SR29) 3= Set Network Baud (%SR30) 4= Set Contrast (%SR32) 5= View OCS Status 6= View OCS Diagnostics 7= View I/O Slots 8= Set Function Key Mode (%SR33) 9= Set Serial Ports (%SR34) 10= Set Time/Date (%SR44-%SR50) 11= Set Beeper (%SR183) 12= Set Screen (%SR185) 13= Removable Media 14= View Protocols 15= IP Address (ETN I/O Board) 16= Fail Safe System 17= Backup / Restore Data 18= Enable AutoRun 19= Enable AutoLoad 20= Clone Unit - 21= Touch Calibration 24= License Details *Excludes RCC Units	0 to 24	Read/Write	Read/Write
%SR4	SELF_TST	Self-Test Results		Read Only	Read Only
%SR4.1		Self-Test Results - BIOS Error		Read Only	Read Only
%SR4.2		Self-Test Results - Engine Error		Read Only	Read Only
%SR4.3		Self-Test Results - Ladder Error		Read Only	Read Only
%SR4.4		Self-Test Results - RAM Error		Read Only	Read Only
%SR4.5		Self-Test Results - Duplicate ID Error		Read Only	Read Only
%SR4.6		Self-Test Results - Bad ID Error		Read Only	Read Only
%SR4.7		Self-Test Results - I/O Configuration Error		Read Only	Read Only
%SR4.8		Self-Test Results - Bad Network Error		Read Only	Read Only
%SR4.9		Self-Test Results - Bad Logic Error		Read Only	Read Only
%SR4.10		Self-Test Results - Bad Clock Error		Read Only	Read Only
%SR4.11		Self-Test Results - DeviceNet Error		Read Only	Read Only
%SR4.12-16	Reserved				
%SR5	CS_MODE	Control Station Mode 0= Idle 1= Do I/O 2= Run 3= Online Change *Supported in Linux and XL+ units only	0 to 3	Read Only	Read/Write
%SR6		Average Scan Rate ms (/ 10)		Read Only	Read Only

Table 5.3 - %SR Registers - Master %SR Table Error! Bookmark not defined.

Register	Default I/O Name	Description	Min-Max Values	Program (Read/Write)	Display (Read/Write)
%SR7		Minimum Scan Rate ms (/ 10)		Read Only	Read Only
%SR8		Maximum Scan Rate ms (/ 10)		Read Only	Read Only
%SR9	TCH_PRESSURE	Current Touch Pressure	0 to 3000	Read Only	Read Only
%SR10	TCH_PRESSURE_TSH	Threshold Touch Pressure	0 to 3000	Read/Write	Read/Write
%SR11-12		Ladder Size (32-Bit DINT)		Read Only	Read Only
%SR13-14		User Text Screen Size (32-Bit DINT) *Excludes RCC Units		Read Only	Read Only
%SR15-16		System Text Screen Size (32-Bit DINT) *Excludes RCC Units		Read Only	Read Only
%SR17-18		I/O Configuration Table Size (32-Bit DINT)		Read Only	Read Only
%SR19-20		Network Config Table Size (32-Bit DINT)		Read Only	Read Only
%SR21-22		Security Data Table Size (32-Bit DINT)		Read Only	Read Only
%SR23		Ladder Code CRC		Read Only	Read Only
%SR24		User Text CRC		Read Only	Read Only
%SR25		System Text CRC		Read Only	Read Only
%SR26		I/O Configuration Table CRC		Read Only	Read Only
%SR27		Network Configuration Table CRC		Read Only	Read Only
%SR28		Security Data Table CRC		Read Only	Read Only
%SR29	NET_ID	Network ID		Read Only	Read / Write
		CsCAN Mode	1 to 253		
		DeviceNet Mode	0 to 63		
		CANOpen Mode	1 to 127		
%SR30		Network Baud Rate 0=125KB 1= 250kB 2= 5000KB 3= 1MB 4=50K	0 to 4	Read Only	Read/Write
%SR31		Network Required 0= Network <u>not</u> required 1= Network required; 2= Network optimized; 3= Network required and optimized	0 to 3	Read Only	Read Only
%SR32		LCD Display Contrast setting *Excludes RCC Units	0 to 255	Read Only	Read/Write
%SR33		Function Key Toggle Mode 0= Momentary 1= Toggle *Excludes RCC Units	0 to 1	Read/Write	Read/Write
%SR34		RS232 Serial Protocol Mode 0= Firmware Update (RISM) 1= CsCAN 2= Generic (Ladder- Controlled) 3= Modbus RTU 4= Modbus ASCII		Read Only	Read Only
%SR35-36		Unique Serial Number / Hexadecimal LAN1 MAC ID 00-E0-XX-XX-XX-XX SR36-High SR35-High SR36-Low SR35-Low		Read Only	Read Only

Table 5.3 - %SR Registers - Master %SR Table Error! Bookmark not defined.

Register	Default I/O Name	Description	Min-Max Values	Program (Read/Write)	Display (Read/Write)
%SR37		Model Number		Read Only	Read Only
%SR38		Engine Version (/100)		Read Only	Read Only
%SR39		BIOS Rev Number (/ 100)		Read Only	Read Only
%SR40		FPGA Image Rev Number (/ 10)		Read Only	Read Only
%SR41		Vertical Pixel Count *Excludes RCC Units		Read Only	Read Only
%SR42		Horizontal Pixel Count *Excludes RCC Units		Read Only	Read Only
%SR43		Keypad Type *Excludes RCC Units		Read Only	Read Only
%SR44	RTC_SEC	Real-Time-Clock Second	0 to 59	Read Only	Read Only
%SR45	RTC_MIN	Real-Time-Clock Minute	0 to 59	Read Only	Read Only
%SR46	RTC_HOUR	Real-Time-Clock Hour	0 to 23	Read Only	Read Only
%SR47	RTC_DATE	Real-Time-Clock Date	1 to 31	Read Only	Read Only
%SR48	RTC_MON	Real-Time-Clock Month	1 to 12	Read Only	Read Only
%SR49	RTC_YEAR	Real-Time-Clock Year	1996 to 2095	Read Only	Read Only
%SR50	RTC_DAY	Real-Time-Clock Day (1=Sunday)	1 to 7	Read Only	Read Only
%SR51		Network Error Count		Read Only	Read Only
%SR52		Watchdog-Tripped Error Count		Read Only	Read Only
%SR53-54	Reserved				
%SR55.13		Self-Test: Battery Low or Missing		Read Only	Read Only
%SR56	LAST_KEY	Key Currently Pressed No key = 0 (No key pressed since power-up) F1 = 1 F2 = 2 F3 = 3 F4 = 4 F5 = 5 F6 = 6 F7 = 7 F8 = 8 F9 = 9 F10 = 10 F11 = 11 F12 = 12 Enter = 13 + / - = 14 . (dot) = 15 0 = 16 1 = 17 2 = 18 3 = 19 4 = 20 5 = 21 6 = 22 7 = 23 8 = 24 9 = 25 System = 26 Escape = 27 Left = 28	0 to 255	Read Only	Read Only

Table 5.3 - %SR Registers - Master %SR Table Error! Bookmark not defined.

Register	Default I/O Name	Description	Min-Max Values	Program (Read/Write)	Display (Read/Write)
		Right = 29 Up = 30 Down = 31 Shift = 32 Soft Key 1 = 34 Soft Key 2 = 35 Soft Key 3 = 36 Soft Key 4 = 37 Soft Key 5 = 38 Soft Key 6 = 39 Soft Key 7 = 40 Soft Key 8 = 41 Release = 255 (Keys pressed since power-up but not currently) *Excludes RCC Units			
%SR57		LCD Backlight Dimmer Register 0-100 = 0% to 100% On 100-255 = 100% On *Excludes RCC Units	0 to 255	Read/Write	Read/Write
%57.16		Temporarily disable Screen Saver *Excludes RCC Units		Read/Write	Read/Write
%SR58	USER_LEDS	User LEDs		Read/Write	Read/Write
%SR59		Engine Build Number (Only last three numbers displayed)		Read Only	Read Only
%SR60		Build Option Build Test = 0 Build Beta = 1 Build Product = 2	0 to 2	Read Only	Read Only
%SR61	NUM_IDS	Number of CsCAN Network IDs		Read Only	Read Only
%SR62-100	Reserved				
%SR101.3		WebMI License Details - WebMI server status *XLEe, XLTe, X2, X4, & X7 only		Read Only	Read Only
%SR101.4		WebMI License Details - WebMI user logged in status *XLEe, XLTe, X2, X4, & X7 only		Read Only	Read Only
%SR101.8-101.16		WebMI License Details - Number of users *XLEe, XLTe, X2, X4, & X7 only		Read Only	Read Only
%SR102-107	Reserved				
%SR108		WebMI License Details - Number of webpages *XLEe, XLTe, X2, X4, & X7 only		Read Only	Read Only
%SR109		WebMI License Details - Number of datapoints *XLEe, XLTe, X2, X4, & X7 only		Read Only	Read Only
%SR110-112		WebMI License Details - Expiry date of WebMI license *XLEe, XLTe, X2, X4, & X7 only		Read Only	Read Only
%SR113-130	Reserved				
%SR131-135		OCS Model: ASCII, 10 characters		Read Only	Read Only

Table 5.3 - %SR Registers - Master %SR Table Error! Bookmark not defined.

Register	Default I/O Name	Description	Min-Max Values	Program (Read/Write)	Display (Read/Write)
%SR136		Communication Download Timeout		Read Only	Read Only
%SR137		Communication Idle Timeout		Read Only	Read Only
%SR138-148	Reserved				
%SR149-150		Free-running 10kHz count: 1 count = 0.1ms (32-Bit DINT)		Read Only	Read Only
%SR151	Reserved				
%SR152		RS-485 Termination		Read / Write	Read / Write
%SR152.1		MJ2 Termination Enable *Excludes RCC972		Read / Write	Read / Write
%SR152.2		MJ3 Termination Enable *XL+ Only RS485 Termination Enable * X4 & X7 Only		Read / Write	Read / Write
%SR152.3*		MJ1 Termination Enable *XL+, XLE, XLT, RCC2414 Only		Read / Write	Read / Write
%SR152.4*		MJ1 Biasing *XL+ Only CAN Termination Enable *X4 & X7 Only		Read / Write	Read / Write
%SR153-163	Reserved				
%SR164		FailSafe / Clone			
%SR164.1		RS485 Port Biasing #1 (MJ1 or MJ2)		Read / Write	Read / Write
%SR164.2		RS485 Port Biasing #2 (MJ2 or MJ3)		Read / Write	Read / Write
%SR164.3	AUTO_RESTRD	Indicates Automatic Restore Operation has been performed		Read Only	Read Only
%SR164.4	BCKUP_TAKN	Indicates Backup of Registers has been taken		Read Only	Read Only
%SR164.5	EN_AUTO_RN	Enable AUTORUN - Sets "Enable AutoRun" to "Yes" or "No"		Read / Write	Read / Write
%SR164.6	EN_AUTO_LD	Enable AUTOLOAD - Sets "Enable AutoLoad" to "Yes" or "No"		Read / Write	Read / Write
%SR164.7	STRT_BCKUP	Start Backup trigger bit - Setting TRUE starts backup of all register data		Read / Write	Read / Write
%SR164.8	CLR_BACKUP	Clear Backup trigger bit - Setting TRUE clears backup of all register data (if a backup was done previously)		Read / Write	Read / Write
%SR164.9	MAKE_CLONE	MAKE_CLONE trigger bit = Setting TRUE does a Load Clone (if a media card is present)		Read / Write	Read / Write
%SR164.10	LOAD_CLONE	LOAD_CLONE trigger bit - Setting TRUE does a LOAD CLONE (if a media card is present that contains clone files)		Read / Write	Read / Write
%SR164.11	MK_CLN_FL	Make Clone Fail (This bit goes high when Make/Create Clone fails)		Read / Write	Read / Write
%SR164.12	LD_CLN_FL	Load Clone Fail (This bit goes high when Load Clone fails)		Read / Write	Read / Write
%SR164.14		Set to 1 to restore data manually, and this in turn sets %SR164.15 to 1. Set to 0 to abort restore operation.		Read / Write	Read / Write

Table 5.3 - %SR Registers - Master %SR Table Error! Bookmark not defined.

Register	Default I/O Name	Description	Min-Max Values	Program (Read/Write)	Display (Read/Write)
		*RCC Units Only			
%SR164.15		Set to 1 for manual restore of data. Set to 0 to complete the restore operation. *RCC Units Only		Read / Write	Read / Write
%SR165-166	Reserved				
%SR167		Screen Update Time, Default= 5 *X4 & X7 Only - Default = 10	2 to 50	Read/Write	Read/Write
%SR168-170	Reserved				
%SR171		X-Coordinate Touched		Read Only	Read Only
%SR172		Y-Coordinate Touched		Read Only	Read Only
%SR173		System-Function Disable,	0 to 1	Read / Write	Read / Write
%SR174		Removable Media Protect		Read/Write	Read/Write
%SR174.1		Request Media Card be Removed		Read / Write	Read / Write
%SR174.2		Indicates safe to remove Media		Read / Write	Read / Write
%SR175		Removable Media - Status		Read Only	Read Only
%SR176-177		Removable Media Free Space (32-Bit DINT)		Read Only	Read Only
%SR178-179		Removable Media Total Space (32-Bit DINT)		Read Only	Read Only
%SR180	Reserved				
%SR181	ALM_UNACK	Bits 1-16 indicate Unacknowledged in Alarm Groups 1-16		Read Only	Read Only
%SR182	ALM_ACT	Bits 1-16 indicate Active in Alarm Groups 1-16		Read Only	Read Only
%SR183	SYS_BEEP	Beep on Keypress Enable 0= Disabled 1= Enabled	0 to 1	Read / Write	Read / Write
%SR184	USER_BEEP	Internal Beeper 0=OFF 1=ON	0 to 1	Read/Write	Read/Write
%SR185		Screen Saver Enabled 0= Disabled 1= Enabled NOTE: See %SR57.16	0 to 1	Read Only	Read Only
%SR186		Screen Saver Time in minutes (delay)	5 to 1200	Read Only	Read Only
%SR187	NET_USE	Network Usage (Avg)	0 to 1000	Read Only	Read Only
%SR188		Network Usage (Min)	0 to 1000	Read Only	Read Only
%SR189		Maximum Net Usage of all units on the CAN network	0 to 1000	Read Only	Read Only
%SR190	NT_TX_AVG	Network TX Usage % (/ 10) (Avg)	0 to 1000	Read Only	Read Only
%SR191		Network TX Usage % (/ 10) (Min)	0 to 1000	Read Only	Read Only
%SR192		Network TX Usage % (/ 10) (Max)	0 to 1000	Read Only	Read Only
EXTENDED SYSTEM REGISTERS					
%SR193	ONLINE_CHG	Online Change			
%SR193.1		TRUE if 2 programs in target FLASH		Read Only	Read Only
%SR193.2		TRUE to switch programs, FALSE when complete		Read Only	Read Only
%SR193.3		TRUE if executing program is temporary test		Read Only	Read Only
%SR193.4		TRUE during last scan of switched-from program		Read Only	Read Only

Table 5.3 - %SR Registers - Master %SR Table Error! Bookmark not defined.

Register	Default I/O Name	Description	Min-Max Values	Program (Read/Write)	Display (Read/Write)
%SR193.5		TRUE during first scan of switched-to program		Read Only	Read Only
%SR193.6		TRUE to revert to FLASH and delete all RAM; FALSE when complete		Read Only	Read Only
%SR193.9		TRUE if error in temporary program		Read Only	Read Only
%SR194		Battery Charge Temp Low *XL+ Only - Frequency in MHz		Read Only	Read Only
%SR195		Battery Charge Temp High *XL+ Only - in degree centigrade		Read Only	Read Only
%SR196		Charging State NOTE: Refer to MAN1142 for more details on Rechargeable Batteries 0=Waiting 1=Normal Charging 2=Hot Charge 3=Hot Charge 4= Battery Hot 5= Cold Charge 6=Battery Cold 7=No Battery 8= Not Charging (after 8 hours of charging) 9= CPU Hot, not charging 10 Battery voltage <2V, not charging 11= First 2 minutes Init Wait (Not Charging)	0 to 11	Read Only	Read Only
%SR197		Charging Current Max mA		Read Only	Read Only
%SR198		Battery Voltage is mV		Read Only	Read Only
%SR199	Reserved				
%SR200		InitRD Version (/100)		Read Only	Read Only
%SR201-205		Linux Kernel version: ASCII, 10 characters		Read Only	Read Only
%SR206-208	Reserved				
%SR209.3		WebMI Server Status. Bit 3 is ON if server running.		Read Only	Read Only
%SR209.4		WebMI User Logged in Status. Bit 4 is ON if 1 or more users logged in.		Read Only	Read Only
%SR209.9-209.16		Number of Users. Shows in upper byte in decimal format.		Read Only	Read Only
%SR210		Time Zone: set in minutes + / - UTC. (Ex: EST is -4 hours = -240 minutes)		Read/Write	Read/Write
%SR211		Daylight Saving: YES = 1 Daylight Saving: NO = 0 (If daylight saving is enabled, one hour will be added to the local time).		Read/Write	Read/Write
%SR212		UTC - Seconds		Read Only	Read Only
%SR213		UTC - Minutes		Read Only	Read Only
%SR214		UTC - Hours		Read Only	Read Only
%SR215		UTC - Date		Read Only	Read Only
%SR216		UTC - Month		Read Only	Read Only

Table 5.3 - %SR Registers - Master %SR Table Error! Bookmark not defined.					
Register	Default I/O Name	Description	Min-Max Values	Program (Read/Write)	Display (Read/Write)
%SR217		UTC - Year		Read Only	Read Only
%SR218		Number of Webpages, license detail (XLE/XLT, X2, X4, & X7 use %SR101 & %SR108-112 for WebMI License Details.)		Read Only	Read Only
%SR219		Number of Data Points, license detail. (XLE/XLT, X2, X4, & X7 use %SR101 & %SR108-112 for WebMI License Details)		Read Only	Read Only
%SR220-222		Expiration Date of WebMI License, license detail. (XLE/XLT, X2, X4, & X7 use %SR101 & %SR108-112 for WebMI License Details)		Read Only	Read Only

For additional information on system bits and registers, refer to the Help file in Cscape.

5.3 Register Map for RCC6512 I/O

Table 5.4 - Register Map for RCC6512 I/O		
Fixed Address	Digital/Analog I/O Function	RCC6512 Model
%I	Digital Inputs	1-12
	Reserved	13-31
	ESCP Alarm*	32
%Q	Digital Outputs	1-10
	Reserved	11-24
%AI	Analog Inputs	1-2
	Reserved	3-12
%AQ	Analog Outputs	1-4
	Reserved	n/a

*Electronic Short Circuit Protection [ESCP]

NOTE: The ESCP bit is set high when the output current is too high, and the output driver has shut down for thermal protection. This typically happens when outputs are shorted, or they are driving loads that are higher than the output rating.

5.4 Resource Limits

Table 5.5- Resource Limits	
Resource	Value
%M	Non-Retentive
%S	13
%SR	198
%T	1024
%R	2048 (256 retentive)
%I	512
%Q	512
%AI	256
%AQ	256

CHAPTER 6: CSCAPE CONFIGURATION

6.1 Overview

RCC6512 hardware is programmed with a Windows based PC application called Cscape. This application can be used to program, configure, monitor, and debug all aspects of the RCC6512 unit. Please see the on-line help provided with Cscape for additional details.

6.2 Cscape Status Bar

When the RCC6512 is connected to a PC using Cscape software a Status Bar appears at the bottom of the screen. The Cscape Status Bar can be used to determine if communications have been established between the RCC6512 and the Cscape program. Components of the Cscape Status Bar are explained below.

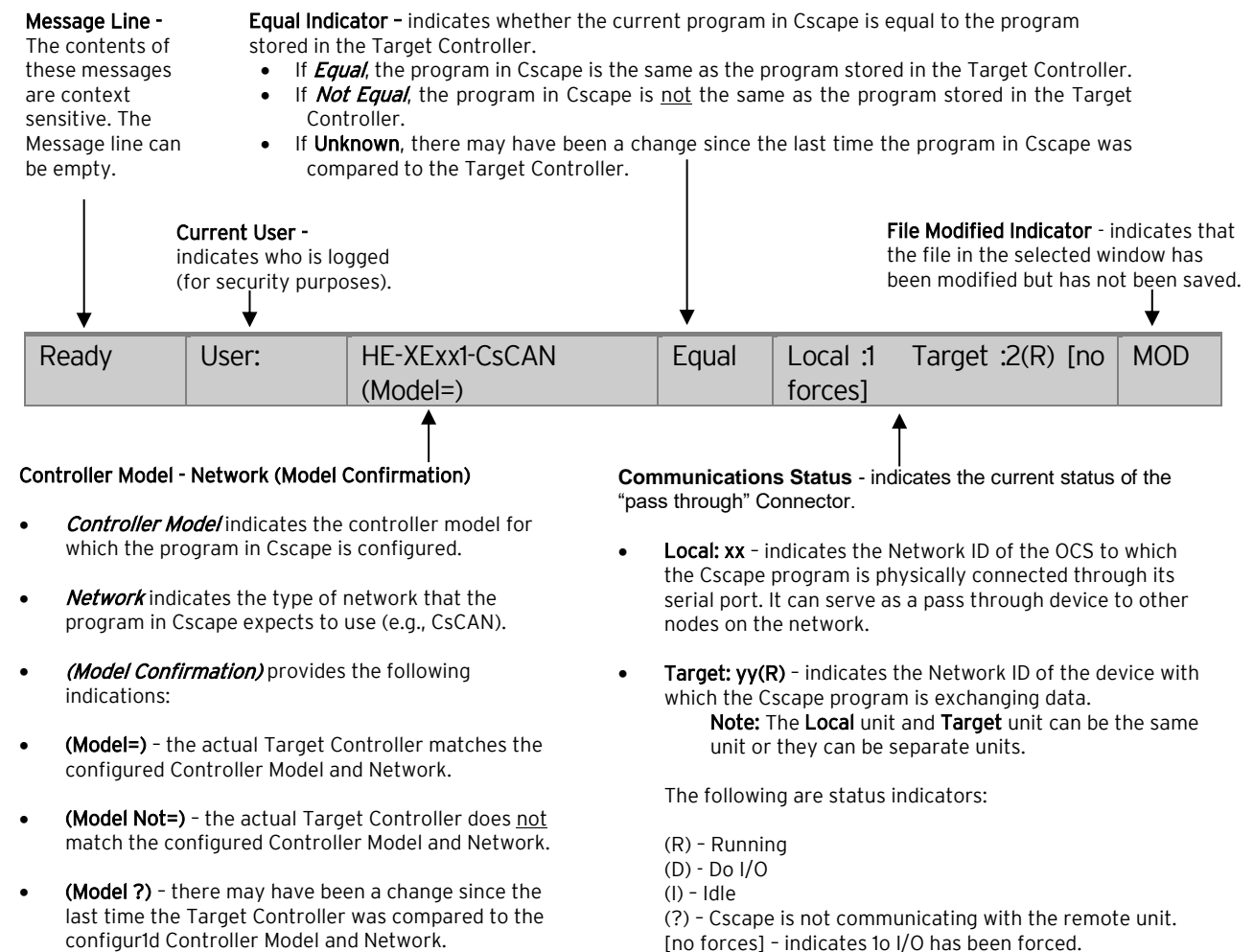

Figure 6.1 - Cscape Status Bar

6.3 Establishing Communications

The RCC6512 can communicate with Cscape using serial port communications via MJ1/MJ2 Port, Ethernet, USB mini-B port, or CAN (CsCAN).

To communicate with the RCC6512 via USB, you will need the automated driver installer located on the Horner APG web site.

Otherwise, the drivers may be loaded from the **HE-XEC Ethernet Utility / HTTP Web Server Demo / Communications Drivers** section of the support files page on our website, found here: <https://hornerautomation.com/support-files>.

Next, connect a PC's (Personal Computer running a Windows Microsoft operating system) USB port via USB cable to the USB mini B port on the RCC6512.



Figure 6.2 - USB Programming Connector

The PC will detect a new device has been plugged into the USB port.

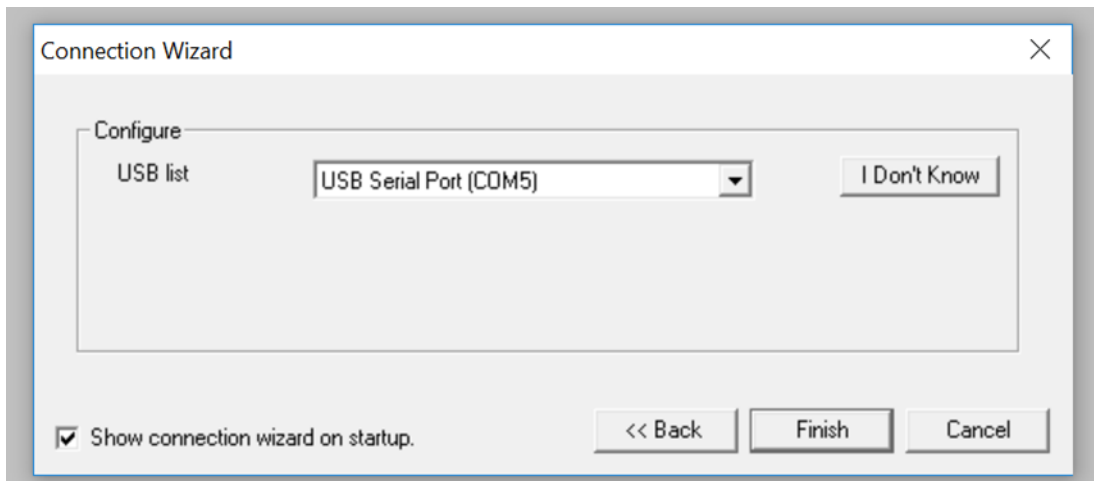
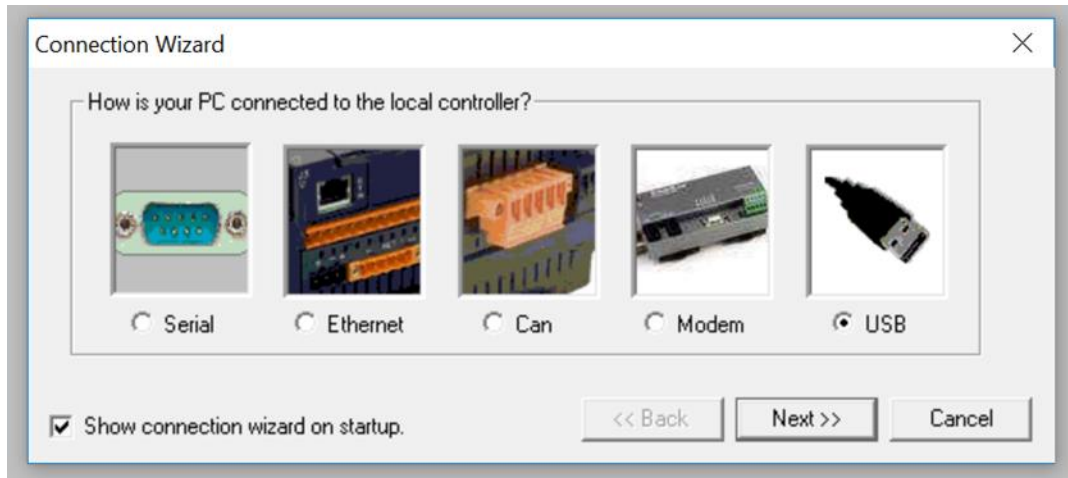

Figure 6.3 - Hardware Wizard Screenshots

Now that the RCC6512 is plugged in, go to the Cscope menu **Controller > Connection Wizard**, and choose connection method. For first time connection, connecting via USB is recommended.

If **Controller USB COM Port** is not present in the dropdown list, the Windows operating system has not yet recognized the OCS as an installed device. Be sure the installation process is complete and that the correct drivers are installed. The Connection Wizard must be completely closed and reopened to refresh the USB dropdown list.

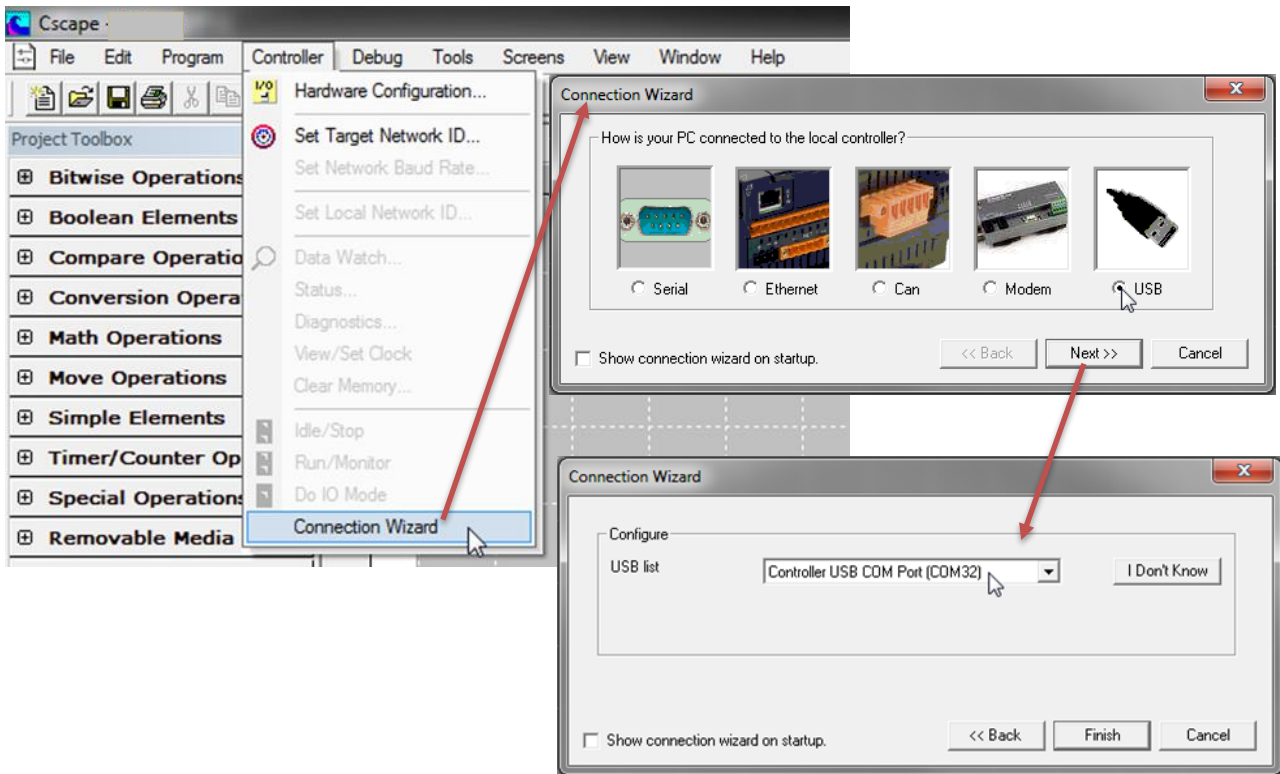

Figure 6.4 - Cscope Connection Wizard Screenshots

An alternate way to select the COM setting is to go to **Cscope** → **Tools** → **Application Settings** → **Communications** and choose connection method in **Add Target**.

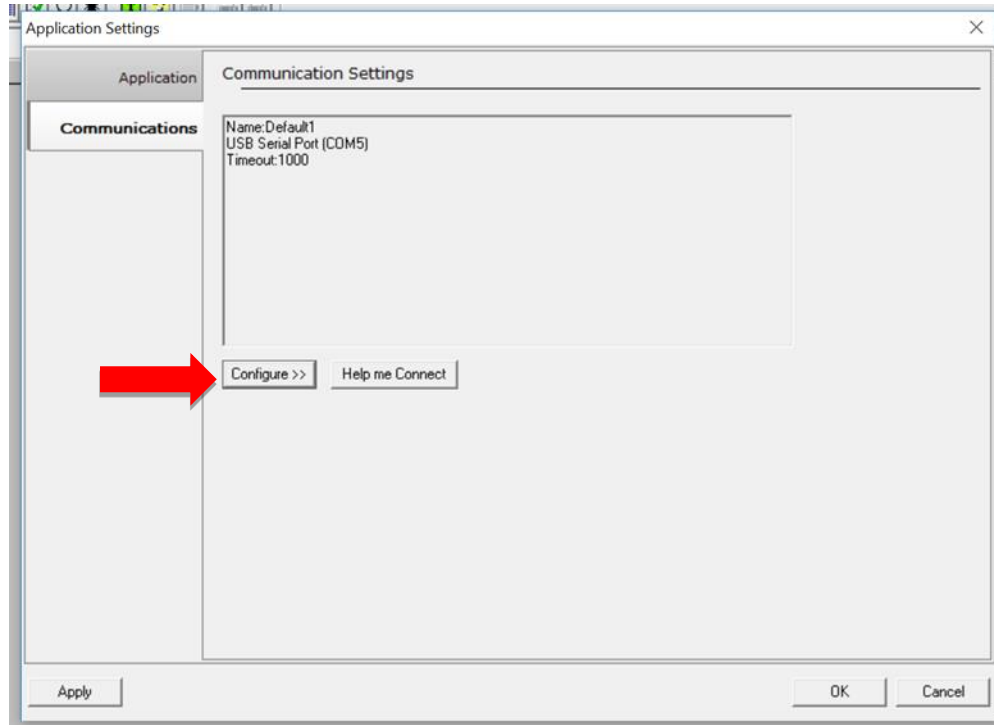
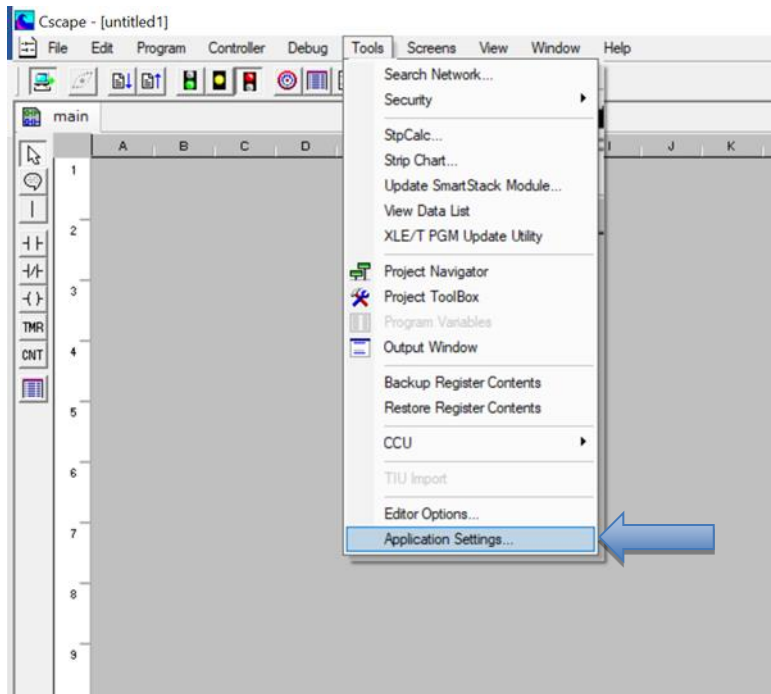

Figure 6.5 - Cscope: Alternative Connection Method Screenshot

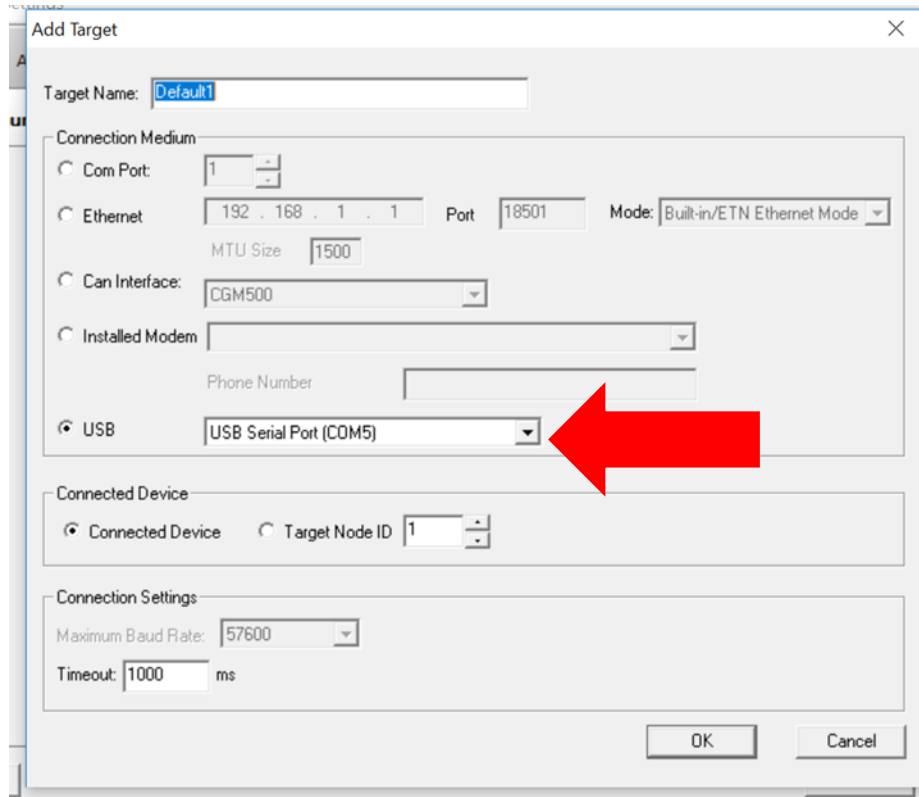

Figure 6.6 - Add Target Screenshot in Cscope

NOTE: The following fields need to be filled for communication configuration if Cscope Connection Wizard was not used. Table 6.1 explains the information needed in each field.

1. Target Name
2. Connection Medium
3. Connected Device
4. Connection Settings

Table 6.1–Communication Configuration Dialog	
Communication Configuration Dialog	
Target Name	Name for connection. This is not a mandatory column to be filled, by default Cscape will populate 'Default1' in edit box.
Connection Medium	
Com Port	Select this option to communicate over serial communication with the device. The port number can be configured here.
Ethernet	<p>Select this option to communicate over Ethernet. Provide the IP address of the device and select the mode: Built in/ ETN Ethernet mode, or HE XEC Ethernet mode.</p> <p>Select Built in/ ETN Ethernet mode if the device has on-board Ethernet port.</p> <p>NOTE: The controller should support the type of connectivity selected and configured for Ethernet communication.</p>
CAN Interface	Select this option to communicate over CAN. This option requires additional hardware to be installed with the PC to be able to do so. Select the type of hardware installed from the dropdown.
USB	Select this option to communicate over USB. Now Horner devices and Horner USB to serial converters are recognized and can be specifically selected.
Connected Device	
NOTE: This configuration is required if the controller to which Cscape is communicating is connected to a CsCAN network.	
Connected Device	By default, this option is selected and networking feature of Cscape is disabled.
Target Node ID	On selecting this option, Networking feature of Cscape is enabled. CsCAN ID for the target controller to be provide here.
Connection Settings (General Communication Settings)	
Maximum Baud Rate	Select the baud rate for serial communication.
Timeout	<p>Select the communication timeout.</p> <p>NOTE: Select a larger timeout for GPRS and installed modem communication configuration</p>

If communication is established, the target indicator will show the mode of the controller
Target: yy(R) as shown in the status section above in this chapter, section Cscape Status Bar.

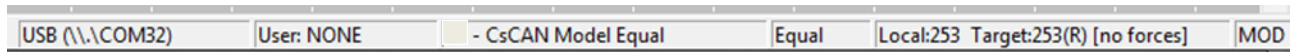

When connected directly to the controller to which Cscape communications are required, the **Local ID and the Target ID should match**.



Local ID and Target

ID Match

If the controller is not communicating, you may need to set the Target ID of the controller in Cscape or change the controllers ID on the unit itself. The **Target ID** allows directing communications to a particular unit when multiple units are connected via a CsCAN network. Units without CsCAN network ports respond to any network ID and do not require the ID to be configured.

To check or change the ID on adjust the rotary switch to a value of 0 to 253 (0xFD hex).

11.3.1 Communicating via MJ1 Serial Port

Start by configuring Cscape to use the correct communications port. This can be done using the **Tools → Options → Communication Port** dialog in Cscape.

Next, connect the PC's serial port to the port labeled MJ1/2 on the RCC6512.

If communications are successful, the target indicator should show the mode of the controller
Target: yy(R) as shown in the status section above.

If the controller is not communicating, it may be required to set the target ID of the controller in Cscape or on the unit. The Target ID allows directing communications to a particular unit when multiple units are connected via a CsCAN network. Units without CsCAN network ports respond to any network ID and do not require the ID to be configured.

To change the Target ID of Cscape use the **Controller → Set Target Network ID** dialog.

11.3.2 Communicating via Onboard Ethernet Port

From Cscape go to **Controller → Hardware Configuration** and do auto configuration for the connected controller, click on **Config of Ethernet → Module Setup**.

11.3.3 Communicating via On Board Ethernet Port

From the factory, the RCC OCS is set to the IP Address 192.168.254.128. To obtain Ethernet communications between Cscape and the RCC OCS using a single Ethernet cable between a PC and the RCC, or through an unmanaged Ethernet Switch, the PC will also need to be manually configured as follows (may require Administrator access on PC):

1. Access the Network Connections in the Control Panel (Shortcut: Press the Windows key  and type 'Network Connections'... select the resulting filtered link).
2. Double-click the connection being used to directly connect to the RCC to bring up the Connection Status.
3. Click **Properties**.
4. Double-click **Internet Protocol Version 4 (TCP/IPv4)** in the list of available protocols.
5. The PC may normally be set to "Obtain an IP address automatically". Click next to **Use the following IP address**:
6. Use the IP address 192.168.254.111 or something other than that of the RCC.
7. The Subnet Mask (255.255.255.0) should fill in automatically once the IP address has been entered.
8. The Default Gateway is not required for a direct connection.
9. Click OK all the way back to the Network Connections dialog.
10. Confirm the RCC is set to the default 192.168.254.128 address or something on the same network.
11. In Cscape, click **Tools → Application Settings → Communications → Configure**.
12. Select Ethernet, and then enter the IP address of the RCC.
NOTE: The MTU setting defaults to the maximum 1500. It needs to match the PC's MTU setting for the best results. A PC may be set to an MTU of 1300 or something other than the default maximum setting by a network administrator.
13. The **Port** for CsCAN over Ethernet is **18501**.
14. The **Mode** for any controller with built-in Ethernet is **Built-in/ETN Ethernet Mode**.
15. Change the **Timeout** value to **3000** for direct connections. Timeout values of 5000-30000+ may be common for access over the internet or via VPN or other more complex networks.
16. Click **OK** all the way back to the main Cscape window. It may take a moment to initialize the communications.
17. Check the status bar for successful communications.

ETN : 172.27.1.183	User: NONE	HERCC Model Equal	Equal	Local:253	Target:253(R) [no forces]	MOD
--------------------	------------	-------------------	-------	-----------	---------------------------	-----

See the next page for examples of the PC Ethernet setup and the Cscape Ethernet setup mentioned in the above steps.

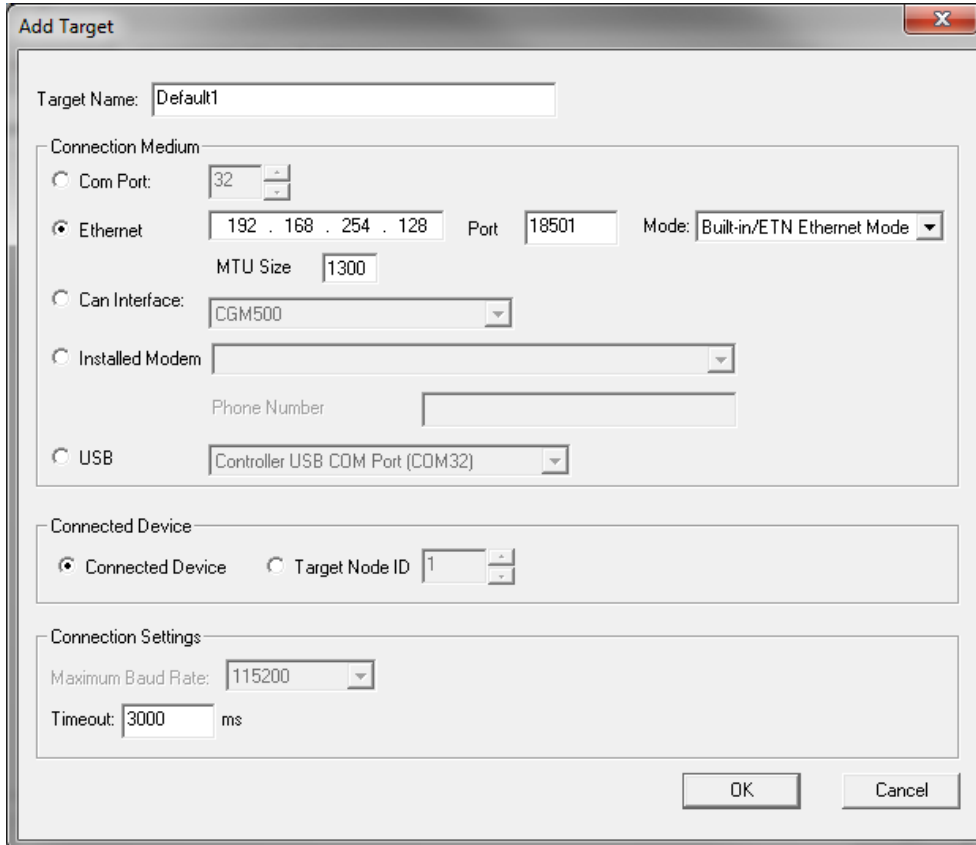
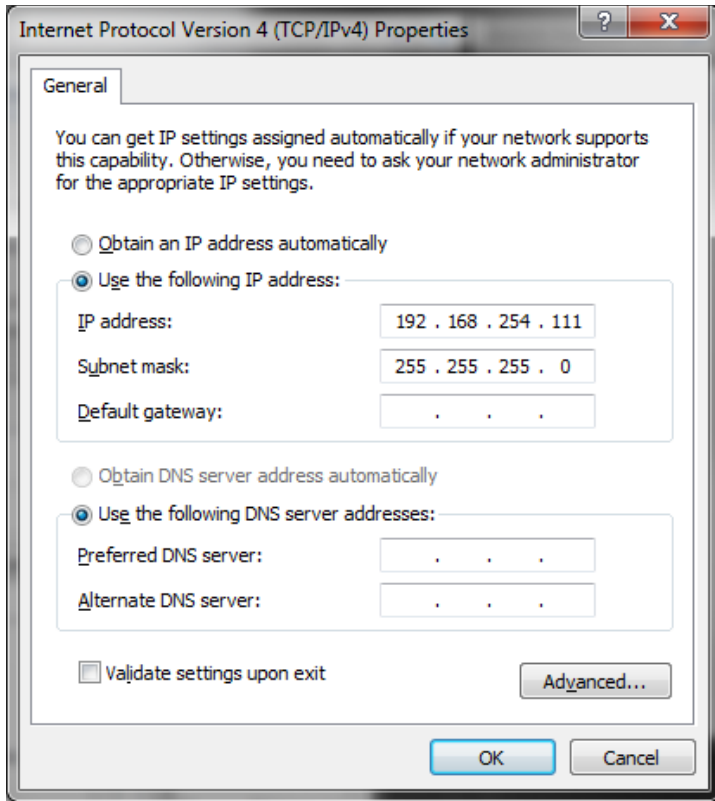

To configure the Ethernet settings of the RCC using Cscape, go to **Controller → Hardware Configuration**. If not already done, select the correct connected controller, or use the **Auto Config** button to automatically recognize a controller that is already successfully connected to Cscape.

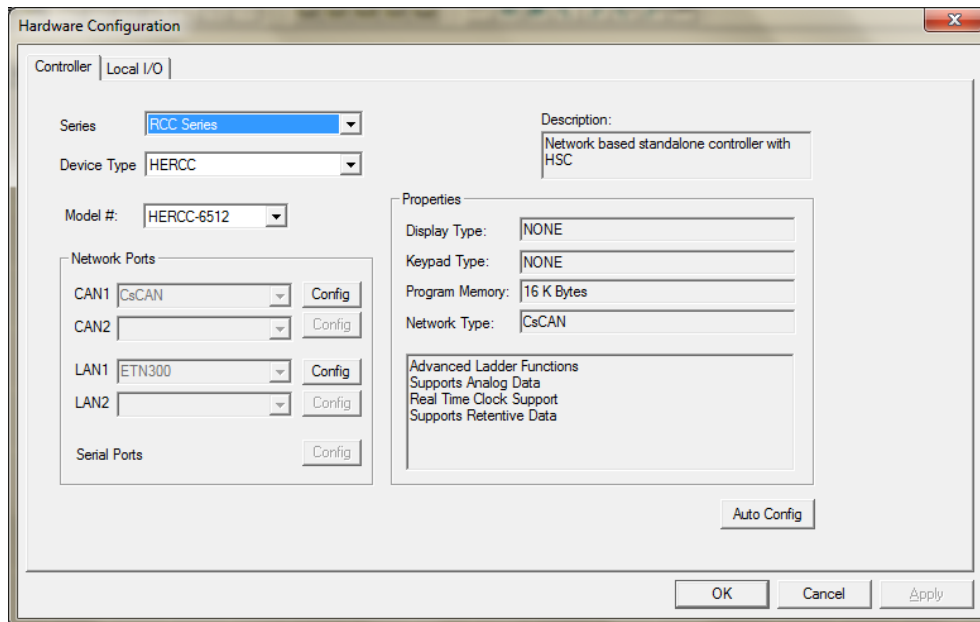

Below the main controller configuration, under **Network Ports**, find **LAN1** and click on the **Config** button to the right of the greyed-out ETN300.

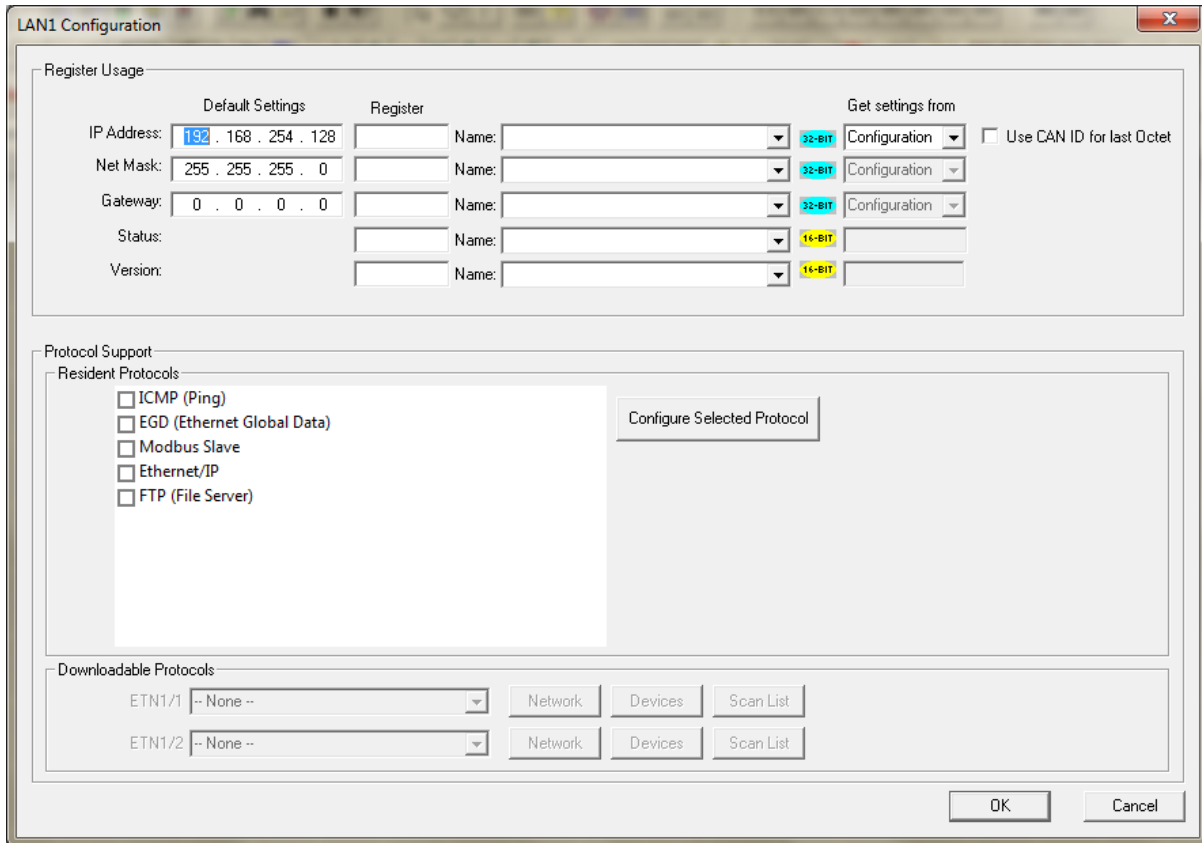

Figure 6.7- Ethernet Configuration Dialog

In the LAN1 Configuration, fill in the network setup for the RCC. In Module configuration dialog, go to IP Address field enter unused IP Address and configure unused registers in Register field & then click OK.

Download the configuration in to Controller. Connect LAN cable to the Controller in default LAN Port.

From Cscape go to **Tools → Editor Options → Communication Port → Configure**. Select Ethernet and enter IP address which is configured in the file. Select mode as RCC Series mode from drop down list.

The controller should get connected to Cscape. If communications are successful, the target indicator should show the mode of the controller Target: yy(R) as shown in the status section above.

6.4 Configuration

An overview of configuration:

1. Start the configuration by selecting the **Controller → Hardware Configuration** menu item.
2. If the RCC6512 is connected to the PC, press the **Auto Config System** button to automatically detect the Base model, I/O and any add-on communication options.
3. If the RCC6512 is not connected, press the **Config** button to the right of the top of the unit. This allows the base CPU to be selected.
4. Select either **RCC6512 CsCAN** from the type drop down box.
5. Once the type of RCC6512 is selected, the model # drop down box will provide the RCC6512 model numbers from which to choose from.
6. Once the RCC6512 CPU is selected, press **OK** to exit the dialog and configure the I/O that is present in the first slot.
7. The Hardware Configuration dialog (Specifically the **Module Setup** tab) provides four (4) buttons to configure all of the I/O. Go through each area of I/O and configure it. Access the Module Setup dialog by selecting **Hardware Configuration → Local I/O → Config → Module Setup**.

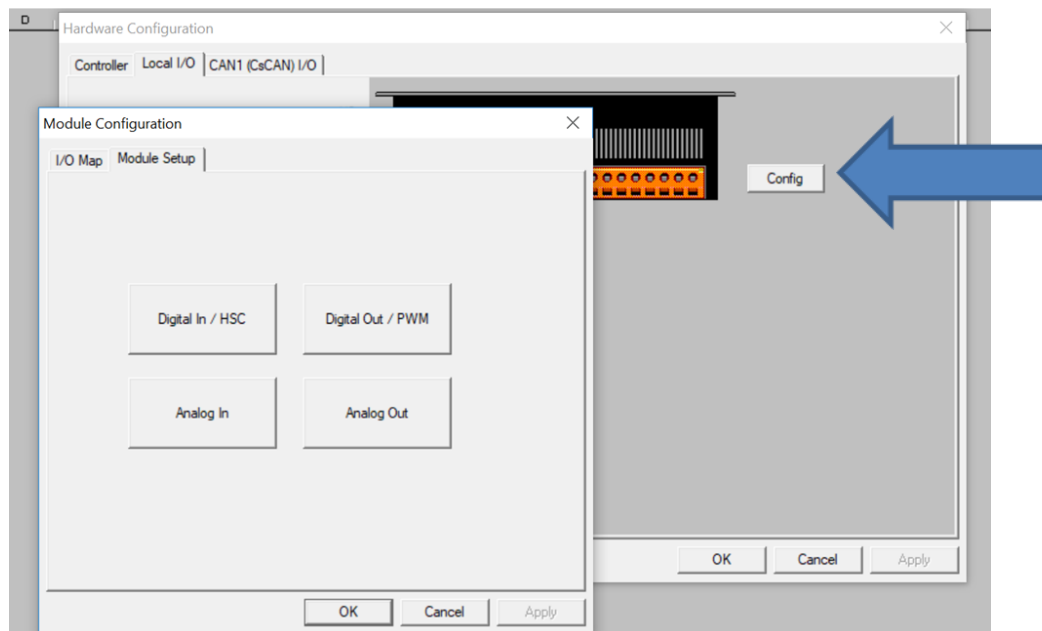

8. Once done configuring the I/O, **OK** out of configuration dialogs.

Configuring the RCC6512 I/O has four main portions that are covered in this chapter:

1. Digital in / HSC
2. Digital out / PWM
3. Analog in
4. Analog out

For additional information on I/O, refer to the chapters covering General I/O or High Speed I/O in this manual.

6.5 Digital / HSC Input Configuration

The following figure illustrates the **Digital / HSC Input Configuration** dialog.

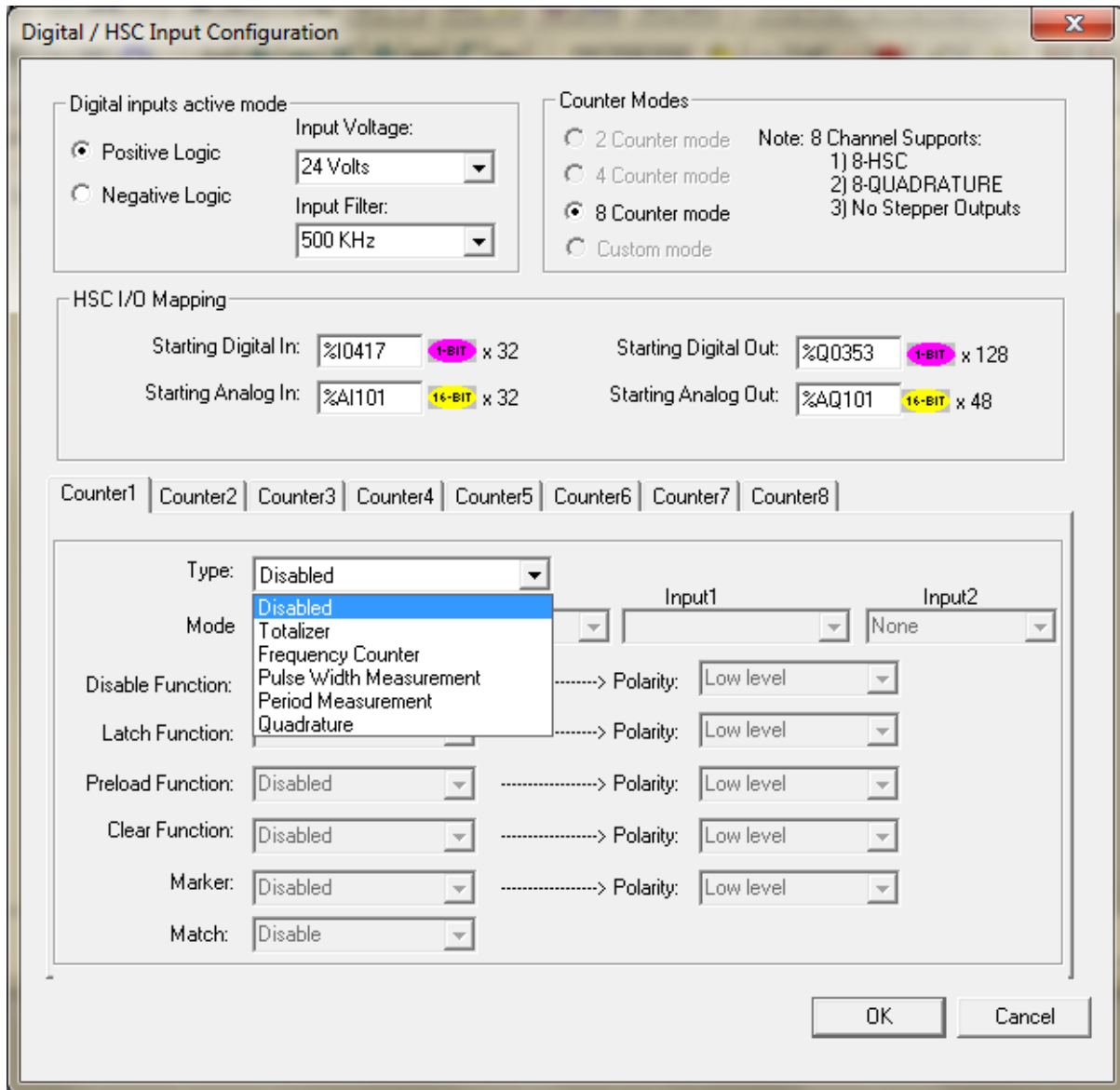

Figure 6.8 - Digital / HSC Input Configuration Dialog

The active mode group box allows the user to select if inputs are active high (Positive logic) or active low (Negative logic).

The High-Speed Counters group box contains all of the windows that are used for configuring the eight (8) available high-speed counters on the RCC6512. In configuring a counter, the user needs to set the type and mode.

The type drop down includes the following options:

- Disabled
- Totalizer
- Frequency Measurement
- Pulse Width Measurement
- Period Measurement
- Quadrature

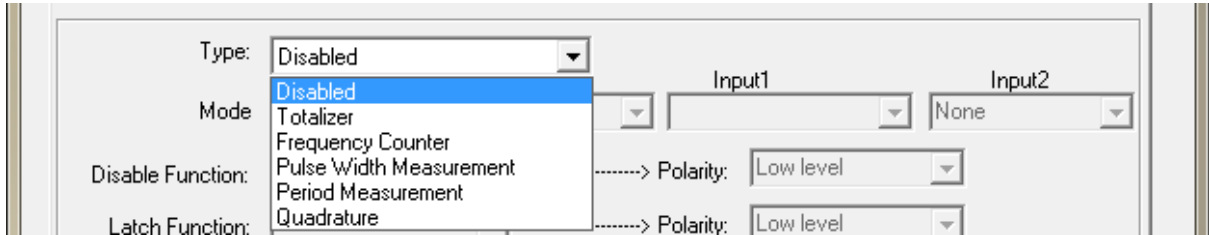

6.6 Digital / PWM Output Configuration

The following figure illustrates the **Digital / PWM Output Configuration** dialog.

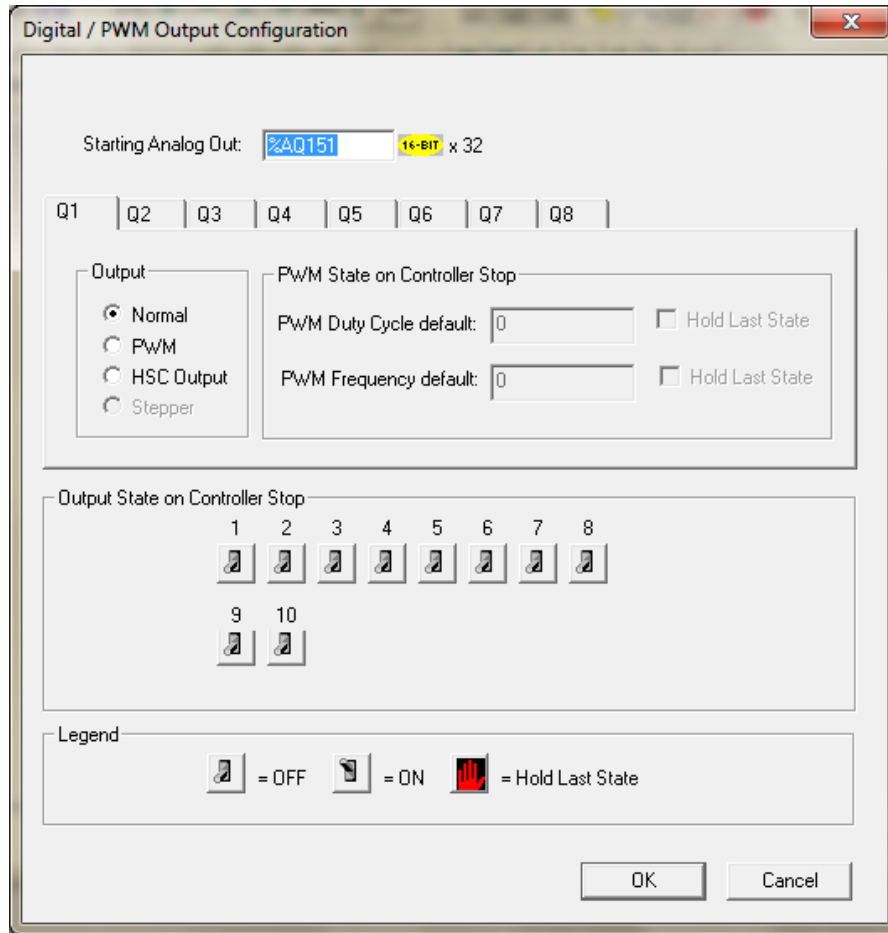

Figure 6.9 - Digital / PWM Output Configuration Dialog

The **Q1** and **Q2** group boxes allow the user to specify the operation of the multi-function outputs.

The **PWM State On Controller Stop** group box contains items that allow the user to specify how the PWM outputs behave when the controller is stopped. These items can either hold their value or default to some value when the controller is stopped.

NOTE: The PWM outputs are set to the OFF state at power-up and during program download and remain in that state until the unit is placed in RUN.

The **Output State On Controller Stop** group box contains items to allow the user to specify how the remaining digital outputs behave when the controller is stopped. These items can either hold their value or default to some value when the controller is stopped.

6.7 Analog Input Configuration

The following figure illustrates the **Analog Input Configuration** dialog.

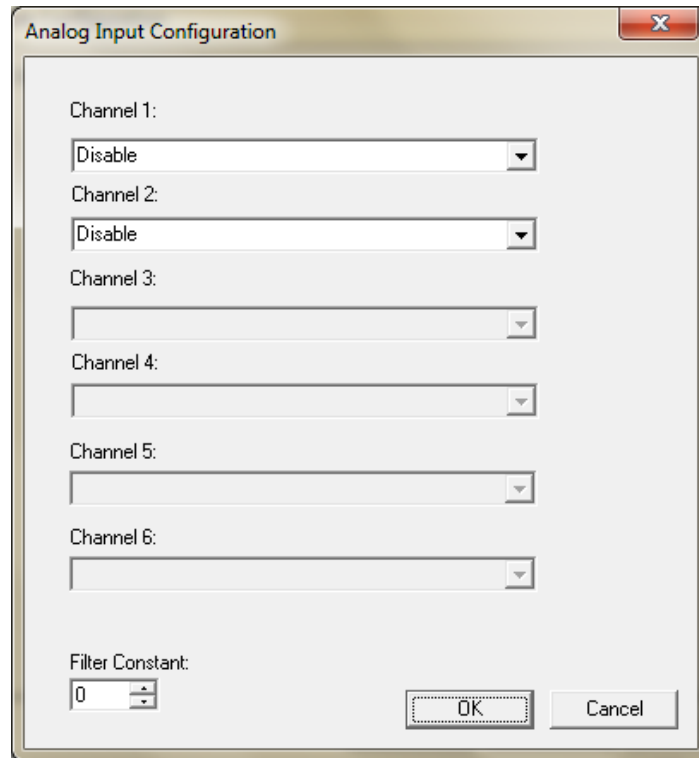

Figure 6.10 - Analog Input Configuration Dialog

The **Channel x** drop down windows allow the user to specify the mode for each analog input to operate. The **Channel x** drop down windows are enabled/disabled according to which model is being configured.

The **Filter Constant** provides filtering to all channels.

6.8 Analog Output Configuration

The following figure illustrates the **Analog Output Configuration** dialog.

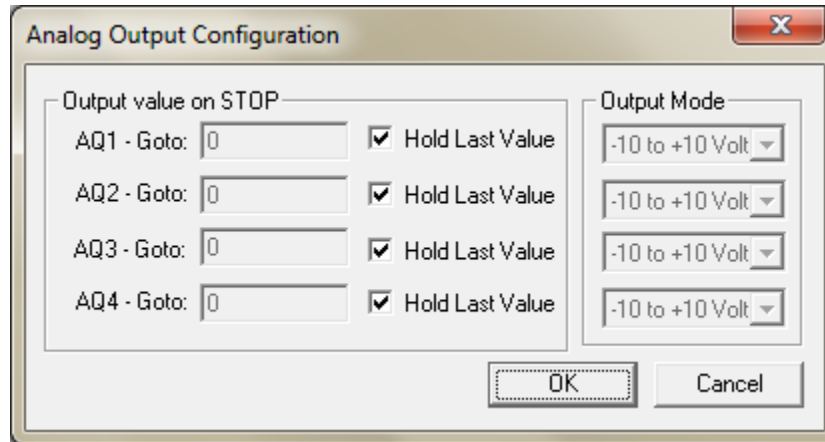

Figure 6.11 - Analog Output Configuration Dialog

The **Output value on Stop** group box contains items that allow the user to specify how the analog output channels behave when the controller is stopped. The outputs can either hold their value or default to a value when the controller is stopped.

The **Output Mode** group box allows the user to select the operating modes for each of the analog outputs. Analog Output mode supported is -10V to 10V.

The **Filter Constant** provides digital filtering to all channels. Valid filter values are 0-7. Refer to the datasheet [MAN1134] for more information on digital filtering.

6.9 Scaling Analog Inputs

To access the Advanced Math Scaling function, select **Tools** → **Project Toolbox**. This will open a side bar, and then select **Advanced Math** → **Scale**.

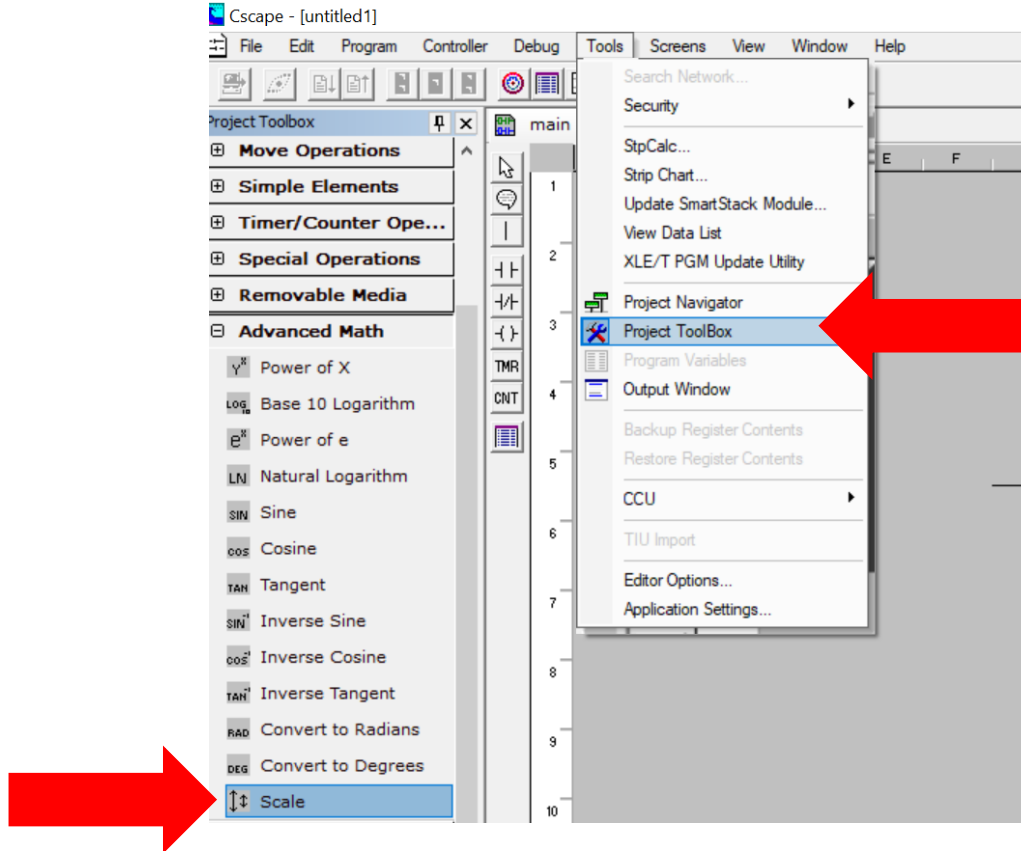
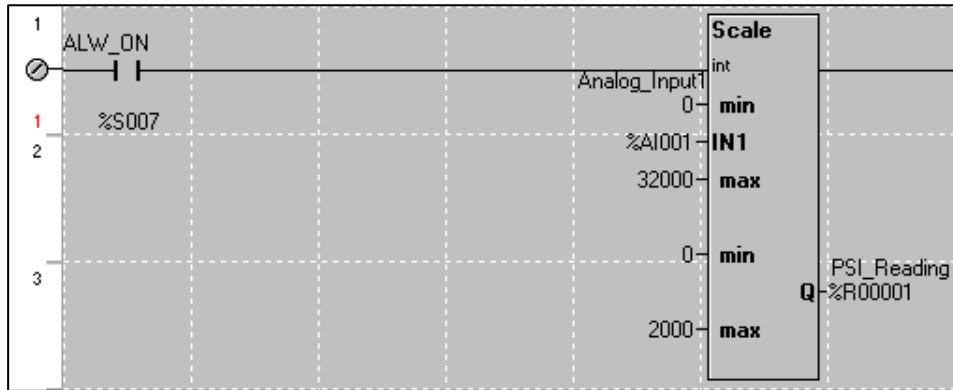

Figure 6.12 -Scaling Analog Inputs

Example 1

The Cscape Scale function, found in the Advanced Math functions, allows for very easy conversion of the raw input value into a meaningful reading. For example, a pressure transducer may be specified as a 4-20mA signal to signify a 0-2000 psi pressure reading. With the analog channel set to the 4..20mA range, the raw analog input value, which is in INT format ranges from 0 to 4mA to 32000 for 20mA. Use the Scale function to obtain an Integer pressure reading using the 0-32000 raw input range and the sensor's 0-2000psi output range.



Example 2:

If readings with fractions are required, the raw Integer input value must first be translated in REAL, or Floating Point format. The Cscape INT-to-REAL Conversion function may be used to convert the raw input value from INT to REAL format in an intermediate memory location. The SCALE function, specified as REAL type, may be used to scale the converted raw value into a reading that supports digits beyond the decimal place, i.e. 475.25psi.

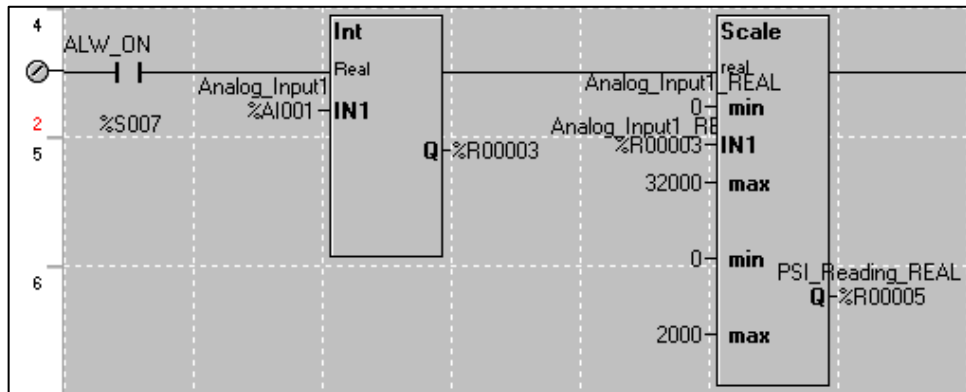

CHAPTER 7: GENERAL I/O

7.1 Overview

The RCC6512 is a compact unit that contains high density, very versatile I/O. Using the I/O properly requires wiring to the proper terminals and configuring Cscape properly. This section will offer some tips and suggestions to configure the I/O properly. For the register mapping of the I/O, refer to the [Index](#) at the end of this manual for the pages referencing register mapping.

7.2 I/O Overview

Table 7.1 - I/O and Model Overview						
Model	DC In	DC Out	HS In	HS Out	0-10V / 0-20mA In	-10 to +10V Out
HE-RCC6512	12	10	12	8	2	4

Table 7.2 - Standard I/O Register Map	
Registers	Function
%I1-12	Digital Inputs
%Q1-10	Digital Outputs (When not controlled via PWM or HSC)
%AI1-2	Voltage or Current Analog Input
%AQ1-4	Voltage Analog Output

7.3 Solid-State Digital Outputs

Solid-state digital outputs are generally used to activate lamps, low voltage solenoids, relays, and other low voltage and low current devices.

NOTE: The digital outputs used on the RCC6512 are “sourcing” outputs. This means the output applies a positive voltage to the output pin when turned ON. When turned off, the output applies approximately zero volts with respect to the I/O ground.

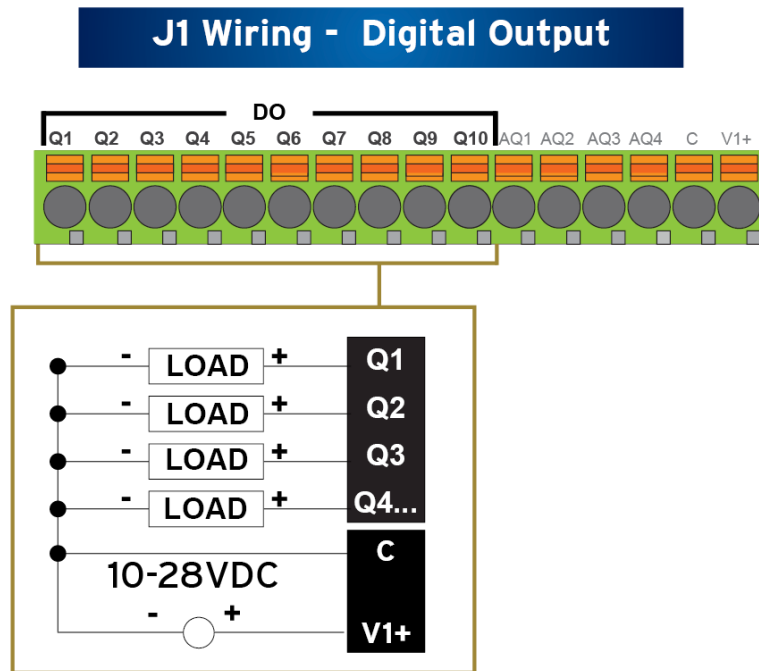

Figure 7.1 - Digital Output Wiring

The digital outputs used in the RCC6512 have electronic short circuit protection and current limiting. While these electronic protections work in most applications, some application may require external fusing on these outputs.

The digital outputs in the RCC6512 are typically controlled via %Q bits in the register mapping. Some of the outputs are designed for high-speed applications and can be used for PWM or frequency output applications. Please see the chapter on High Speed I/O for additional information.

When the controller is stopped, the operation of each output is configurable. The outputs can hold the state they were in before the controller stopped, or they can go to a predetermined state. By default digital outputs turn off. For more information on stop state see the [Index](#) to find pages referencing Cscape settings.

The digital outputs feature an output fault bit. %I32 will turn on if any of the outputs experience a short circuit, over-current or the output driver overheats.

7.4 Digital Inputs

NOTE: The digital inputs on the RCC6512 are designed for low voltage DC inputs. The inputs are designed to support both positive and negative input modes. The mode is set by a configuration parameter in Cscape. All the inputs on the unit must be configured to the same mode.

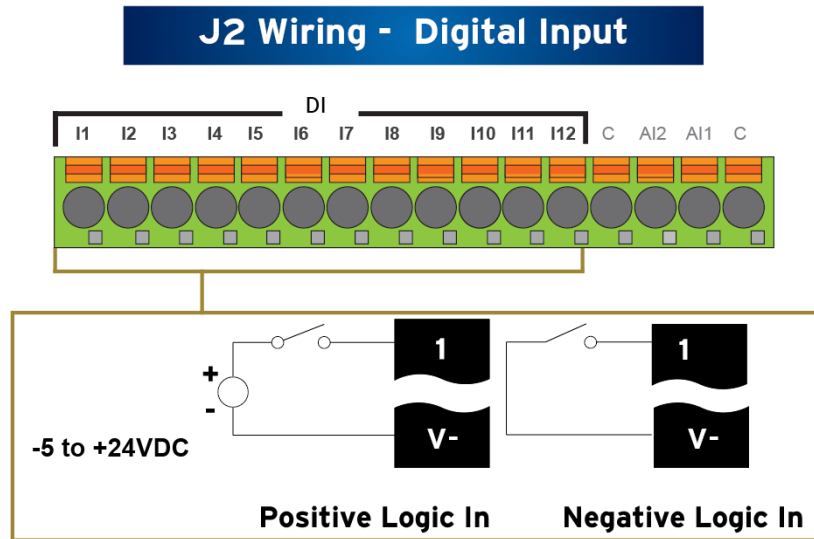

Figure 7.2 - Positive and Negative Inputs

In positive logic mode, a positive voltage applied to the input will turn the input. The internal design of this mode is basically a resistor from the input to I/O ground. This mode is sometimes called **sinking**.

In negative logic mode, connecting the input to the I/O ground or zero volts will turn the input on. The internal design of this mode is basically a resistor from the input to the positive I/O voltage (configurable for 24, 12, 5 or zero crossing). This mode is sometimes called **sourcing**.

All 12 of the digital inputs may support high-speed input functional such as counting or frequency measurement.

7.5 Analog Inputs

The analog inputs on the RCC6512 allow voltage measurement from a variety of devices.

The analog inputs have a digital filter that can be used to filter electrical noise that may be unavoidable in some installations. The downside to digital filtering is the inputs will respond more slowly to sudden changes in the actual input.

Each Analog Input may be specified separately in the Cscape configuration as having a range of 0-10VDC, 0-20mA DC, or 4-20mA DC. For whichever range is configured, the Analog Input registers %AI1 - %AI2 will contain values between 0 - 32000 to match measurements in that range. Using this raw value, the Scaling function in Cscape, and the connected sensor's given range, it is easy to get a measurement for display, alarming, datalogging, or any other purpose required. Alternately, the raw value may be used directly for PID loops.

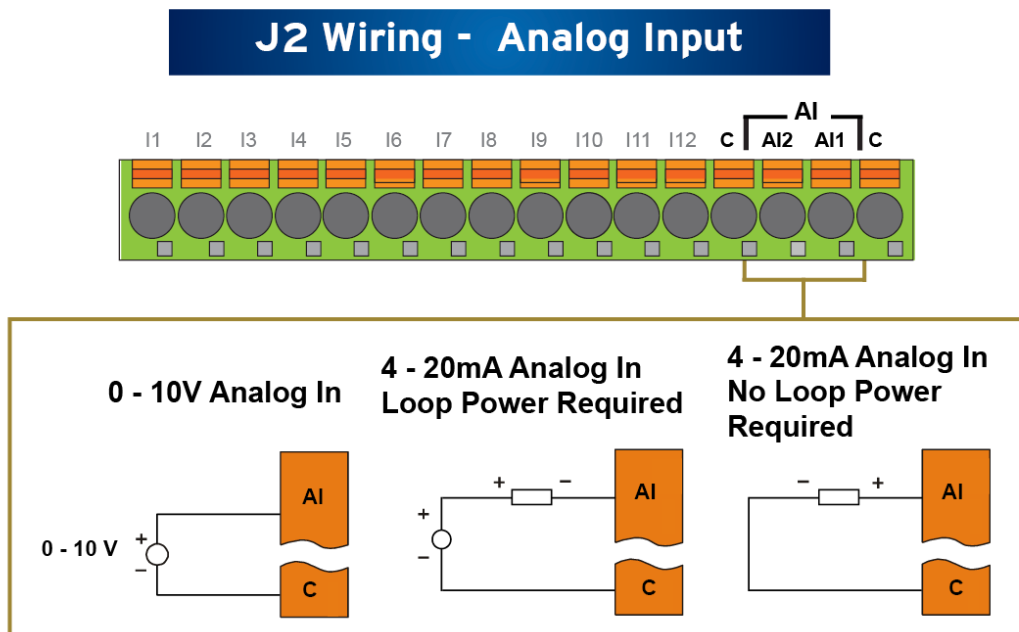

Figure 7.3 - Analog Input Wiring Options

7.6 Analog Outputs

The analog outputs on RCC6512 devices provide high resolution +/-10 V outputs.

When the controller is stopped, the operation of each output is configurable. The outputs can hold the state they were in before the controller stopped or they can go to a predetermined value. By default, analog outputs are set to a value of zero. For more information on Stop State, refer to the appropriate pages (see [Index](#)) for the configuration chapter for Cescape settings.

Each Analog Output may be specified for a range of -10VDC to +10VDC. The Analog Output registers %AQ1 - %AQ4 may be used to control the output by placing a value between - 32000 to +32000 into the register. This may be directly from a PID loop output, for example.

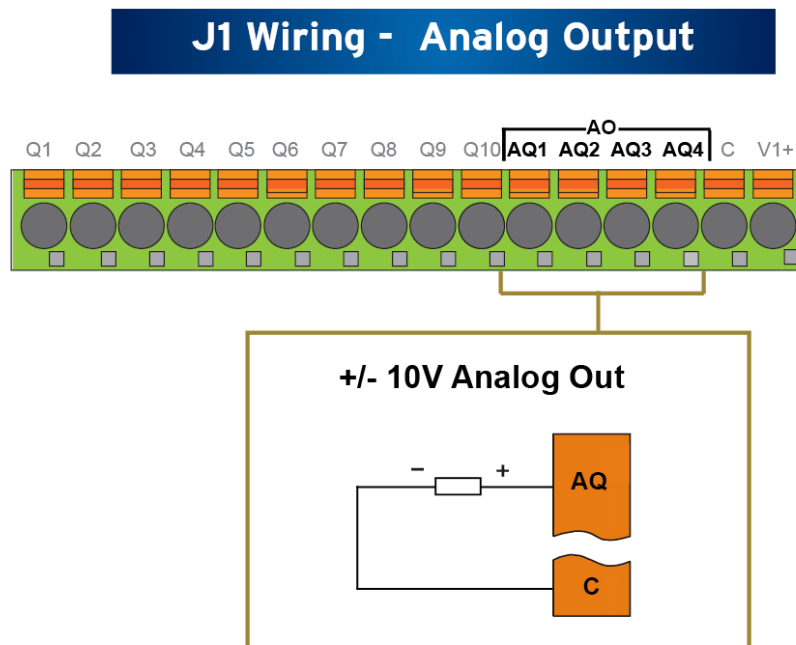

Figure 7.4 - Analog Out Wiring Options

CHAPTER 8: HIGH SPEED I/O (HSC / PWM)

8.1 Overview

In addition to the compliment of simple analog and digital I/O, several of the RCC6512 I/O modules support High Speed Counting (HSC) I/O functions and supports Pulse Width Modulation (PWM) Output functions. The HSC functions include internal timing, frequency, totalizing, pulse width/period, and quadrature measurement. The PWM functions include traditional PWM (with variable rate and duty cycle).

This chapter describes the operation of these high-level I/O functions. For configuration details of these functions, see [Cscape Configuration](#).

8.2 Glossary

Table 8.1 - Glossary of High Speed I/O Terms	
Accumulator	Register used to accumulate or store up a sum or count of many items or events.
Clear	A special function to zero out the value in a specific register. (Not used with Frequency or Period Measurement.)
Disable	A special function to prevent the counter from running.
Encoder	A sensor or transducer for converting rotary motion or position to a series of electronic pulses.
Frequency Input	The number of times an electromagnetic signal repeats an identical cycle in a unit of time, usually one second.
Latch (strobe)	A special function that uses a digital logic circuit to store one or more bits. A latch has a data input, a clock input and an output. When the clock input is active, data on the input is "latched" or stored and transferred to the output register either immediately or when the clock input goes inactive. The output retains its value until the clock goes active again.
Marker	Input into the OCS that indicates a particular position. Typically, an encoder has a marker output that represents a specific point in the rotation.
Polarity	A Polarity pull-down box is associated with each function and indicates the manner in which the trigger happens (e.g., High level, Low Level, Falling Edge, Rising Edge).
Preload (load)	A special function used to trigger loading of a value into a register upon an event. (Not used with Frequency or Period Measurement.)
Quadrature	A high-speed device that expresses the phase relationship between two periodic quantities of the same period when the phase difference between them is one fourth of a period. A coupler in which the two output signals are 90° out of phase.
Totalizer	A counter that sums the total number of cycles applied to its input.

8.3 High Speed Counter (HSC) Functions

The RCC6512 supports eight very high speed, configurable counters. There are twelve dedicated inputs that can be configured to a number of different options. Each of the eight counters can run in one of five modes. Those modes are Totalizer, Frequency Counter, Pulse Width Measurement, Period Measurement, and Quadrature measurement. For some modes, more than one HSC input may be consumed. The measurement values are provided to ladder in a %AI register (see page 49).

8.3.1 Frequency

In frequency mode, the frequency of the input signal is written to the accumulator in terms of Hertz (cycles/second). When using frequency mode, four update selections are provided which specify the width of the sample window. Note that selecting a shorter sample window provides a quicker measurement (faster response) but lowers the frequency accuracy (resolution) and increases the minimum frequency measurement limit. In this mode the Disable and Latch special functions are allowed. Please see the [HSC Glossary](#) for a description of these functions.

8.3.2 Totalize

In totalize mode, the accumulator is simply incremented or decremented each time the input transitions in a specific direction.

The totalizer supports the following modes:

Internal	This mode ties the input to the counter to an internal 10MHz or 1MHz clock. The special functions can be used to accurately time events.
Count Up	This increments the accumulator when the input is enabled. NOTE: Two inputs can be assigned. Either input can cause the counter to increment. The second input can also be disabled.
Count Down	This decrements the accumulator when the input is enabled. NOTE: Two inputs can be assigned. Either input can cause the counter to decrement. The second input can also be disabled.
Up/Down (Input 1 Up/Input 2 Down)	In this mode, input 1 (assigned to any of the four inputs) increments the counter, while input 2 (also assigned to any of the 4 inputs) decrements the counter.
Clk/Dir (Input 1 Clk, Input 2 Dir)	This mode uses input 1 as a clock signal to increment or decrement the counter and then uses input 2 to decide the direction. Input 2 disabled increments the counter, while input 2 enabled decrements the counter.

NOTE: The totalize mode enables the Disable, Latch, Preload, and Clear special functions. Please see the [HSC Glossary](#) for details.

8.3.3 Pulse Width Measurement

In pulse width measurement mode, the high-speed input can measure the width of a pulse stream in one of two modes and provides a continuous indication of the last sampled value. In this mode, the Disable and Latch special functions are allowed. Refer to the [HSC Glossary](#) for a description of these functions.

Width High 1 μ s Counts - In this sub-mode the accumulator value will contain the number of 1 μ s counts the pulse is high.

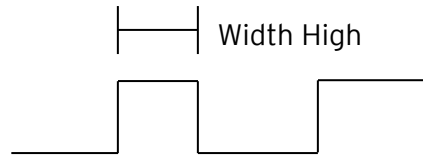

Width Low 1 μ s Counts - In this sub-mode the accumulator value will contain the number of 1 μ s counts the pulse is low.

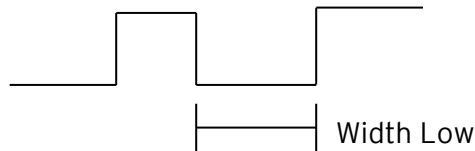

Figures 8.1-8.2 - Pulse Width Measurements, High & Low

8.3.4 Period Measurement

In period measurement mode, the high-speed input can measure the period of a pulse stream in one of two modes and provides a continuous indication of the last sampled value. In this mode the Disable and Latch special functions are allowed. Please see [HSC Glossary](#) for a description of these functions.

Period Rising Edges 1 μ s Counts - In this sub-mode the period of the input signal is reported in one (1) μ s units. The period measurement will start on the rising edge of the input.

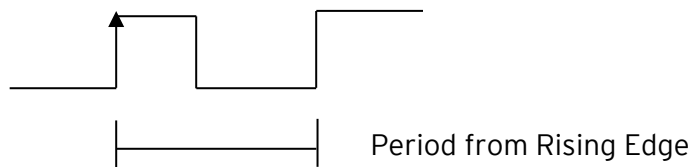

Period Falling Edges 1 μ s Counts - In this sub-mode the period of the input signal is reported in one (1) μ s units. The period measurement will start on the falling edge of the input.

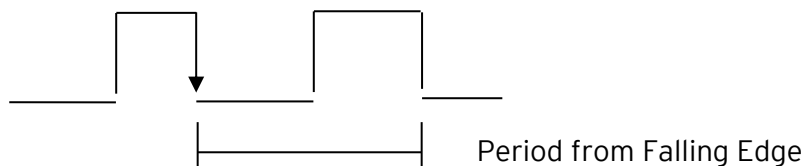

Figures 8.3-8.4 - Period Measurement, Rising Edges & Falling Edges

8.3.5 PWM Output Waveform

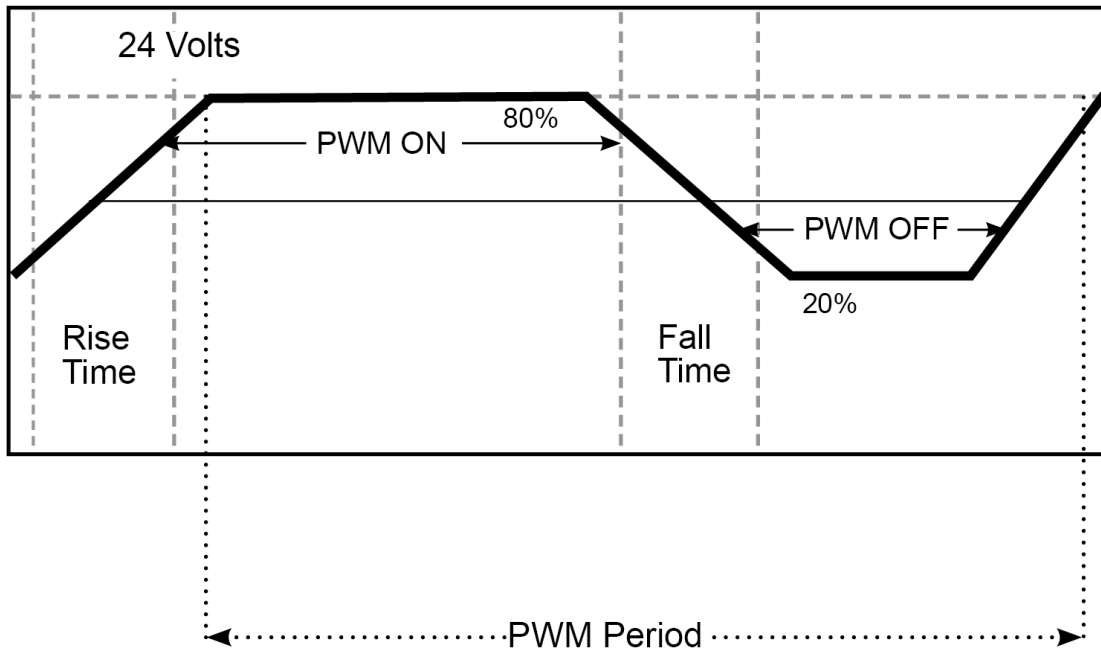

Figure 8.5 - PWM Output Waveform

Table 8.2 - PWM Output Waveform Table	
Rise Time	150ns Max
Fall Time	150ns Max
PWM Period	Frequency = $\frac{1}{Period}$

8.3.6 Register Match

All counter modes support a register match function. When the accumulator value matches the Match 1 or Match 2 value setup in %AQ registers, a high-speed output with either turn on, turn off, or toggle based on settings in Cescape.

8.4 HSC Functions Register Map

The register assignments for the high speed I/O can be moved via a setting in Cscape. The values shown are the DEFAULT values and may not match the same starting point as the values shown below.

Table 8.3 HSC Functions Register Map	
Register	Description
%AI101-102	HSC1 Accumulator
%AI103-104	HSC1 Latched Accumulator
%AI105-106	HSC2 Accumulator
%AI107-108	HSC2 Latched Accumulator
%AI109-110	HSC3 Accumulator
%AI111-112	HSC3 Latched Accumulator
%AI113-114	HSC4 Accumulator
%AI115-116	HSC4 Latched Accumulator
%AI117-118	HSC5 Accumulator
%AI119-120	HSC5 Latched Accumulator
%AI121-122	HSC6 Accumulator
%AI123-124	HSC6 Latched Accumulator
%AI125-126	HSC7 Accumulator
%AI127-128	HSC7 Latched Accumulator
%AI129-130	HSC8 Accumulator
%AI131-132	HSC8 Latched Accumulator
Register	Description
%AQ101-102	HSC1 Preload Value
%AQ103-104	HSC1 Match 1 Value
%AQ105-106	HSC1 Match 2 Value
%AQ107-108	HSC2 Preload Value
%AQ109-110	HSC2 Match 1 Value
%AQ111-112	HSC2 Match 2 Value
%AQ113-114	HSC3 Preload Value
%AQ115-116	HSC3 Match 1 Value
%AQ117-118	HSC3 Match 2 Value
%AQ119-120	HSC4 Preload Value
%AQ121-122	HSC4 Match 1 Value
%AQ123-124	HSC4 Match 2 Value
%AQ125-126	HSC5 Preload Value
%AQ127-128	HSC5 Match 1 Value
%AQ129-130	HSC5 Match 2 Value
%AQ131-132	HSC6 Preload Value

%AQ133-134	HSC6 Match 1 Value
%AQ135-136	HSC6 Match 2 Value
%AQ137-138	HSC7 Preload Value
%AQ139-140	HSC7 Match 1 Value
%AQ141-142	HSC7 Match 2 Value
%AQ143-144	HSC8 Preload Value
%AQ145-146	HSC8 Match 1 Value
%AQ147-148	HSC8 Match 2 Value
Register	Description
%Q353	HSC1 Latch Trigger
%Q354	HSC1 Preload Trigger
%Q355	HSC1 Clear Trigger
%Q356	HSC1 Disable Counter
%Q357	HSC1 Direction
%Q358	HSC1 Underflow/Overflow/HSCQ Reset (1-Reset)
%Q359	HSC1 Preload Disable (1-Disable)
%Q360	HSC1 Latch Disable (1-Disable)
%Q369	HSC2 Latch Trigger
%Q370	HSC2 Preload Trigger
%Q371	HSC2 Clear Trigger
%Q372	HSC2 Disable Counter
%Q373	HSC2 Direction
%Q374	HSC2 Underflow/Overflow/HSCQ Reset (1-Reset)
%Q375	HSC2 Preload Disable (1-Disable)
%Q376	HSC2 Latch Disable (1-Disable)
%Q385	HSC3 Latch Trigger
%Q386	HSC3 Preload Trigger
%Q387	HSC3 Clear Trigger
%Q388	HSC3 Disable Counter
%Q389	HSC3 Direction
%Q390	HSC3 Underflow/overflow/HSCQ Reset (1-Reset)
%Q391	HSC3 Preload Disable (1-Disable)
%Q392	HSC3 Latch Disable (1-Disable)
%Q401	HSC4 Latch Trigger
%Q402	HSC4 Preload Trigger
%Q403	HSC4 Clear Trigger
%Q404	HSC4 Disable Counter
%Q405	HSC4 Direction
%Q406	HSC4 Underflow/Overflow/HSCQ Reset (1-Reset)
%Q407	HSC4 Preload Disable (1-Disable)
%Q408	HSC4 Latch Disable (1-Disable)

%Q417	HSC5 Latch Trigger
%Q418	HSC5 Preload Trigger
%Q419	HSC5 Clear Trigger
%Q420	HSC5 Disable Counter
%Q421	HSC5 Direction
%Q422	HSC5 Underflow/Overflow/HSCQ Reset (1-Reset)
%Q423	HSC5 Preload Disable (1-Disable)
%Q424	HSC5 Latch Disable (1-Disable)
%Q433	HSC6 Latch Trigger
%Q434	HSC6 Preload Trigger
%Q435	HSC6 Clear Trigger
%Q436	HSC6 Disable Counter
%Q437	HSC6 Direction
%Q438	HSC6 Underflow/Overflow/HSCQ Reset (1-Reset)
%Q439	HSC6 Preload Disable (1-Disable)
%Q440	HSC6 Latch Disable (1-Disable)
%Q449	HSC7 Latch Trigger
%Q450	HSC7 Preload Trigger
%Q451	HSC7 Clear Trigger
%Q452	HSC7 Disable Counter
%Q453	HSC7 Direction
%Q454	HSC7 Underflow/Overflow/HSCQ Reset (1-Reset)
%Q455	HSC7 Preload Disable (1-Disable)
%Q456	HSC7 Latch Disable (1-Disable)
%Q465	HSC8 Latch Trigger
%Q466	HSC8 Preload Trigger
%Q467	HSC8 Clear Trigger
%Q468	HSC8 Disable Counter
%Q469	HSC8 Direction
%Q470	HSC8 Underflow/Overflow/HSCQ Reset (1-Reset)
%Q471	HSC8 Preload Disable (1-Disable)
%Q472	HSC8 Latch Disable (1-Disable)
Register	Description
%I417	HSC1 Overflow Flag
%I418	HSC1 Underflow Flag
%I419	HSC1 HSCQ
%I420	HSC1 Reserved
%I421	HSC2 Overflow Flag
%I422	HSC2 Underflow Flag
%I423	HSC2 HSCQ
%I424	HSC2 Reserved

%I425	HSC3 Overflow Flag
%I426	HSC3 Underflow Flag
%I427	HSC3 HSCQ
%I428	HSC3 Reserved
%I429	HSC4 Overflow Flag
%I430	HSC4 Underflow Flag
%I431	HSC4 HSCQ
%I432	HSC4 Reserved
%I433	HSC5 Overflow Flag
%I434	HSC5 Underflow Flag
%I435	HSC5 HSCQ
%I436	HSC5 Reserved
%I437	HSC6 Overflow Flag
%I438	HSC6 Underflow Flag
%I439	HSC6 HSCQ
%I440	HSC6 Reserved
%I441	HSC7 Overflow Flag
%I442	HSC7 Underflow Flag
%I443	HSC7 HSCQ
%I444	HSC7 Reserved
%I445	HSC8 Overflow Flag
%I446	HSC8 Underflow Flag
%I447	HSC8 HSCQ
%I448	HSC8 Reserved

8.5 High Speed Output Functions

Eight of the ten outputs can be configured for one of three modes of operation. Those modes are Normal, PWM and HSC Match.

8.5.1 Normal

When either Q1 to Q8 is configured for Normal operation, the digital output registers %Q1 to %Q8 drives that respective output.

8.5.2 PWM

When either Q1 to Q8 is configured for PWM, the PWM function drives that respective output. Both PWM channels may be individually enabled and can have independent frequency and duty cycles.

The PWMs require two parameters (%AQs) to be set for operation. These parameters may be set at run-time.

Duty Cycle - The Duty Cycle is a 32-bit value from 0 to 32,000 indicating the relative duty cycle of the output. For example, a value of 8000 would indicate a 25% duty cycle, a value of 16,000 would indicate a 50% duty cycle. The value 0 turns the output off, and 32,000 turns the output on.

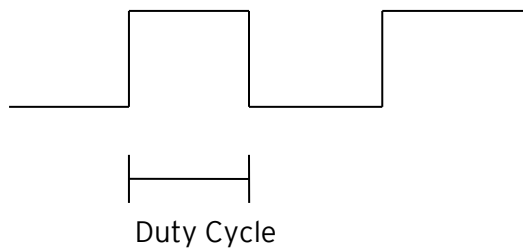

Frequency - The Frequency is a 32-bit value indicating the output frequency in Hertz. One over the frequency is the period.

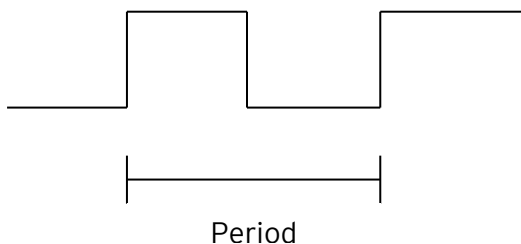

Figures 8.6 & 8.7 - PWM, Two Parameters: Duty Cycle and Frequency

At controller power-up or during a download, the PWM output is maintained at zero until both the Frequency and the Duty cycle are loaded with non-zero values. When the controller is placed in stop mode, the state of the PWM outputs is dependent on the *PWM State on Controller Stop* configuration. This configuration allows for either hold-last-state or specific frequency and duty cycle counts. Specifying zero for either the period or duty causes the PWM output to remain low during stop mode.

8.5.3 High Speed Counter Match

When either Q1 to Q8 is configured for HSC Output operation, their output state is based on a comparison between the counter accumulator and match registers. See details above in the high-speed input section.

8.6 High Speed Output Functions Register Map

The register assignments for the high speed I/O can be moved via a setting in Cscope. The values shown are the DEFAULT values and may not match the same starting point as the values shown below.

Table 8.4 PWM I/O Register Map	
Register	Description
%AQ151 - 152	PWM1 Duty Cycle
%AQ153 - 154	PWM1 Frequency
%AQ155 - 156	PWM2 Duty Cycle
%AQ157 - 158	PWM2 Frequency
%AQ159 - 160	PWM3 Duty Cycle
%AQ161 - 162	PWM3 Frequency
%AQ163 - 164	PWM4 Duty Cycle
%AQ165 - 166	PWM4 Frequency
%AQ167 - 168	PWM5 Duty Cycle
%AQ169 - 170	PWM5 Frequency
%AQ171 - 172	PWM6 Duty Cycle
%AQ173 - 174	PWM6 Frequency
%AQ175 - 176	PWM7 Duty Cycle
%AQ177 - 178	PWM7 Frequency
%AQ179 - 180	PWM8 Duty Cycle
%AQ181 - 182	PWM8 Frequency

8.7 PWM Examples

Example 1	Duty Cycle	Frequency
To get a 50% Duty Cycle @ 10kHz waveform on PWM1:	Set %AQ150-151 = 16,000	Set %AQ152-153 = 10,000
Example 2	Duty Cycle	Frequency
To get a 50% Duty Cycle on PWM1 and 90 % Duty Cycle on PWM2 @ 1kHz waveform:	Set %AQ150-151 = 16,000 Set %AQ154-155 = 28,800 (<i>duty cycle (32000 * 0.9)</i>)	Set %AQ152-153 = 1,000 Set %AQ156-157 = 1,000
Example 3	Duty Cycle	Frequency
To turn PWM 1 output ON all the time	Set %AQ150-151 = 32,000	Set %AQ152-153 = Any Value
Example 4	Duty Cycle	Frequency
To turn PWM 1 output OFF all the time	Set %AQ150-151 = 0	Set %AQ152-153 = Any Value

CHAPTER 9 SERIAL COMMUNICATIONS

9.1 Overview

RCC6512 models provide two independent serial ports on a single 8-pin modular RJ45 connectors, which is labeled MJ1/MJ2. RS-232 is available on MJ1, and RS-485 is available on MJ2. By default, MJ1 can be connected to the COM port of a PC running Cscope, for OCS programming. In addition, MJ1 and MJ2 can be used for application-specific communication, using a variety of standard data exchange protocols.

9.2 Port Descriptions

Two serial ports are provided via the single 8-position modular jack labeled “MJ1/2”. MJ1 defaults to one of several methods available to program the controller. It may instead be specified for RS-232 communications, such as for Modbus Master/Slave, or to communicate to devices such as bar code scanners.

MJ2 may only be used as a half-duplex (2-wire) RS-485. The most common use is for Modbus communications, either as a Modbus Master or Modbus Slave, though other options are also available.

9.3 Serial Port Pinouts

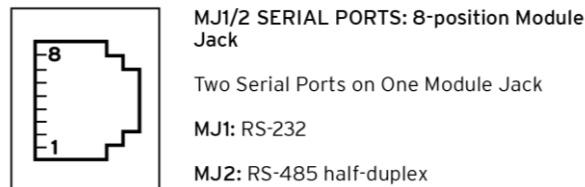

MJ1 PINS			MJ2 PINS	
PIN	SIGNAL	DIRECTION	SIGNAL	DIRECTION
8	TXD	OUT	-	-
7	RXD	IN	-	-
6	0V	GROUND	0V	GROUND
5	+5V @ 60mA	OUT	+5V @ 60mA	OUT
4	RTS	OUT		
3	CTS-	IN		
2	-	-	RX-/TX-	IN/OUT
1	-	-	RX+/TX+	IN/OUT

NOTE: Refer to connector pinout on product.

Figure 9.1 - Serial Port Pinouts

9.4 RS485 Termination and Biasing

Proper RS485 termination minimizes signal reflections and improves reliability.

MJ2 serial port allows an internal termination resistor to be placed across pins 1 and 2 by software control.

Only the two devices physically located at the endpoints of the RS485 network should be terminated.

RS485 biasing passively asserts a line-idle state when no device is actively transmitting, which is useful for multi-drop RS485 networking.

MJ2 serial port allows internal bias resistor to be activated by software control, pulling pin 1 up to 3.3V and pulling pin 2 down to ground.

If biasing is used, it should be enabled in only one of the devices attached to the RS485 network.

Below are the details:

- For MJ2 termination make high %SR152.1
- For MJ2 biasing make high %SR164.1

9.5 Cscape Programming via Serial Port

The RCC6512 MJ1 serial port supports CsCAN Programming Protocol. If a PC COM port is connected to the RCC6512 MJ1 port, Cscape can access the RCC6512 for programming and monitoring. Programming can also be done via the CAN port, USB mini-B port, or Ethernet.

9.6 Ladder-Controlled Serial Communication

Using Serial Communication function blocks, MJ1 and MJ2 serial ports support Generic Modbus Master and Modbus Slave Protocols. In addition, external modems can be connected and accessed using Modem function blocks.

CHAPTER 10: CAN COMMUNICATIONS

NOTE: For additional CAN information, refer to the CAN Networks manual (MAN0799) on the Horner websites.

10.1 Overview

All RCC6512 models provide one CAN network port, which is implemented with a 5-pin connector.

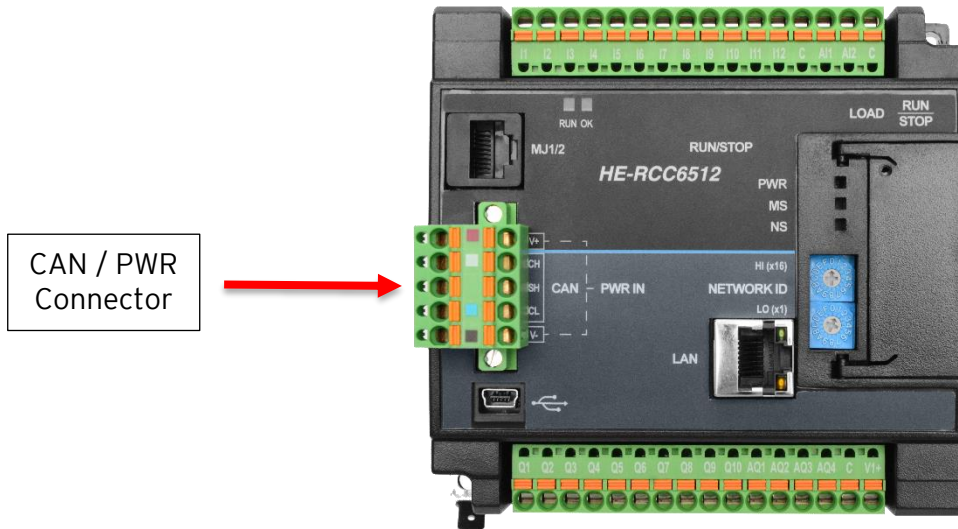

Figure 9.1 - CAN Connector Location

The CAN port allows the RCC6512 to exchange global data with other OCS/RCS controllers and to access remote Network I/O devices (SmartStix, Smart Blocks and Smart Rail Modules). The CAN port also supports pass-through communications for programming multiple OCS controllers over the CsCAN network.

10.2 Port Description

The RCC6512 CAN ports implement the ISO 11898-2 physical layer and the CAN 2.0A data link layer standards.

The CAN port is provided via two connection: CH and CL. Power for the unit is provided through CAN port as well through V+ and V-. The CAN port may be used to communicate with other OCS products using Horner's CsCAN protocol.

10.3 Setting ID Switches

CsCAN Network IDs are set using the hexadecimal number system from 01 to FD. The decimal equivalent is 1-253. Refer to the following Conversion Table, which shows the decimal equivalent of hexadecimal numbers. Set a unique Network ID by inserting a small Phillips screwdriver into the two identical switches.

NOTE: The CsCAN Baud Rate for SmartBlock I/O is fixed at 125kBd.

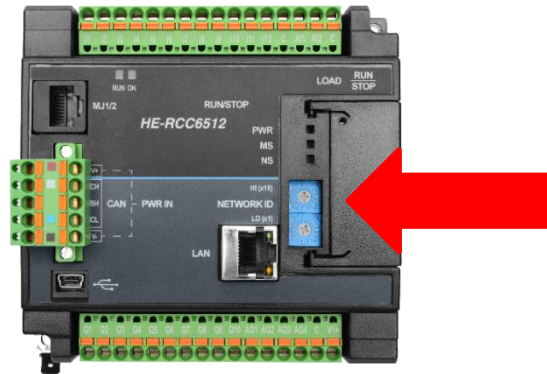

Dec	Hex		Dec	Hex		Dec	Hex		Dec	Hex		Dec	Hex		Dec	Hex		Dec	Hex		Dec	Hex				
	HI	LO		HI	LO		HI	LO		HI	LO		HI	LO		HI	LO		HI	LO		HI	LO			
1	0	1	29	1	D	57	3	9	86	5	6	114	7	2	142	8	E	170	A	A	198	C	6	226	E	2
2	0	2	30	1	E	58	3	A	87	5	7	115	7	3	143	8	F	171	A	B	199	C	7	227	E	3
3	0	3	31	1	F	59	3	B	88	5	8	116	7	4	144	9	0	172	A	C	200	C	8	228	E	4
4	0	4	32	2	0	60	3	C	89	5	9	117	7	5	145	9	1	173	A	D	201	C	9	229	E	5
5	0	5	33	2	1	61	3	D	90	5	A	118	7	6	146	9	2	174	A	E	202	C	A	230	E	6
6	0	6	34	2	2	62	3	E	91	5	B	119	7	7	147	9	3	175	A	F	203	C	B	231	E	7
7	0	7	35	2	3	63	3	F	92	5	C	120	7	8	148	9	4	176	B	0	204	C	C	232	E	8
8	0	8	36	2	4	64	4	0	93	5	D	121	7	9	149	9	5	177	B	1	205	C	D	233	E	9
9	0	9	37	2	5	65	4	1	94	5	E	122	7	A	150	9	6	178	B	2	206	C	E	234	E	A
10	0	A	38	2	6	66	4	2	95	5	F	123	7	B	151	9	7	179	B	3	207	C	F	235	E	B
11	0	B	39	2	7	67	4	3	96	6	0	124	7	C	152	9	8	180	B	4	208	D	0	236	E	C
12	0	C	40	2	8	68	4	4	97	6	1	125	7	D	153	9	9	181	B	5	209	D	1	237	E	D
13	0	D	41	2	9	69	4	5	98	6	2	126	7	E	154	9	A	182	B	6	210	D	2	238	E	E
14	0	E	42	2	A	70	4	6	99	6	3	127	7	F	155	9	B	183	B	7	211	D	3	239	E	F
15	0	F	43	2	B	72	4	7	100	6	4	128	8	0	156	9	C	184	B	8	212	D	4	240	F	0
16	1	0	44	2	C	73	4	8	101	6	5	129	8	1	157	9	D	185	B	9	213	D	5	241	F	1
17	1	1	45	2	D	74	4	A	102	6	6	130	8	2	158	9	E	186	B	A	214	D	6	242	F	2
18	1	2	46	2	E	75	4	B	103	6	7	131	8	3	159	9	F	187	B	B	215	D	7	243	F	3
19	1	3	47	2	F	76	4	C	104	6	8	132	8	4	160	A	0	188	B	C	216	D	8	244	F	4
20	1	4	48	3	0	77	4	D	105	6	9	133	8	5	161	A	1	189	B	D	217	D	9	245	F	5
21	1	5	49	3	1	78	4	E	106	6	A	134	8	6	162	A	2	190	B	E	218	D	A	246	F	6
22	1	6	50	3	2	79	4	F	107	6	B	135	8	7	163	A	3	191	B	F	219	D	B	247	F	7
23	1	7	51	3	3	80	5	0	108	6	C	136	8	8	164	A	4	192	C	0	220	D	C	248	F	8
24	1	8	52	3	4	81	5	1	109	6	D	137	8	9	165	A	5	193	C	1	221	D	D	249	F	9
25	1	9	53	3	5	82	5	2	110	6	E	138	8	A	166	A	6	194	C	2	222	D	E	250	F	A
26	1	A	54	3	6	83	5	3	111	6	F	139	8	B	167	A	7	195	C	3	223	D	F	251	F	B
27	1	B	55	3	7	84	5	4	112	7	0	140	8	C	168	A	8	196	C	4	224	E	0	252	F	C
28	1	C	56	3	8	85	5	5	113	7	1	141	8	D	169	A	9	197	C	5	225	E	1	253	F	D

10.4 CAN and Power Port Wiring

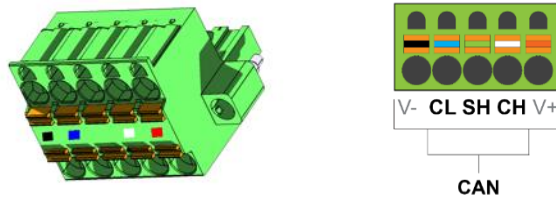

CAN Connector

Use the CAN Connector when using CsCAN or another CAN network.

Torque rating 4.5 – 7 in-lbs
(0.50 – 0.78 N-m).

CAN1 & CAN2 Port Pins		
Pin	Signal	Signal Description
1	V-	CAN and Device Ground - Black
2	CN_L	CAN Data Low - Blue
3	SHLD	Shield Ground - None
4	CN_H	CAN Data High - White
5	V+	Positive DC Voltage Input (10 - 28VDC) - Red

Figure 10.2 - CAN Port Pins

10.5 Cscape Programming via CAN

The CAN port supports CsCAN Programming Protocol. If a PC has a CAN interface installed (via PCI card or USB), and the PC CAN port is connected to the RCC6512 CAN1 port, Cscape can access the RCC6512 for programming and monitoring.

In addition, the RCC6512 supports single-point-programming of all RCC6512 and other OCS/RCS devices that are connected to the CAN1 port network. If the PC COM port is connected to the RCC6512 MJ1 serial port, the RCC6512 can act as a pass-through gateway allowing Cscape to access all RCC6512 and OCS/RCS devices that are attached to the CAN1 port network.

10.6 Ladder-Controlled CAN Communication

Using Put and Get Network Words function blocks, the CAN port can exchange digital and analog global data with other RCC6512 or OCS/RCS devices (nodes) attached to the CAN1 port network.

In addition, Put and Get Network Heartbeat function blocks allow nodes on the CAN port network to regularly announce their presence and to detect the presence (or absence) of other nodes on the network.

CHAPTER 11: ETHERNET COMMUNICATION

11.1 Ethernet Module Protocols and Features

The following table describes the Ethernet Module Protocols and features supported by the Ethernet port on the RCC6512.

Table 11.1 - Ethernet Module Protocols & Features	
Protocol / Feature	Protocol / Feature Description
ICMP (Ping)	Internet Control Message Protocol
EGD	Ethernet Global Data
CsCAN TCP Server	Horner APG CsCAN over Ethernet (for Cscape to OCS programming)
Modbus Slave	Modbus over Ethernet
Ethernet / IP Server	ODVA CIP over Ethernet
FTP (File Server)	File Transfer Protocol

11.2 Ethernet System Requirements

Full Ethernet functionality requires PC running Cscape Programming Software Version 9.8 SP1 or later (for configuration).

11.3 Ethernet Module Specifications

Table 11.2 - Ethernet Module Specifications	
Speeds	10 BaseT Ethernet (10Mbps) 100 BaseTx Fast Ethernet (100Mbps)
Modes	Half or Full Duplex
Auto-Negotiation	Both 10/100Mbps and Half/Full Duplex
Connector Type	Shielded RJ-45
Cable Type (Recommended)	CAT5 (or better) UTP
Port	Auto MDI/MDI-X (Auto Crossover)

11.4 Ethernet Module Configuration

NOTE: The following configuration is required for all applications regardless of the protocols used. Additional configuration procedures must be performed for each protocol used.

To configure the Ethernet Module, use Cscape Programming Software to perform the following steps:

1. On the main Cscape screen, select the **Controller** menu and its **Hardware Configuration** sub-menu to open the I/O Configuration dialog (Figure 11.1).
2. If configuring a different OCS Model than the one shown in the Hardware Configuration dialog, click on the topmost **Config** button, select the desired OCS Model, and then click **OK**.

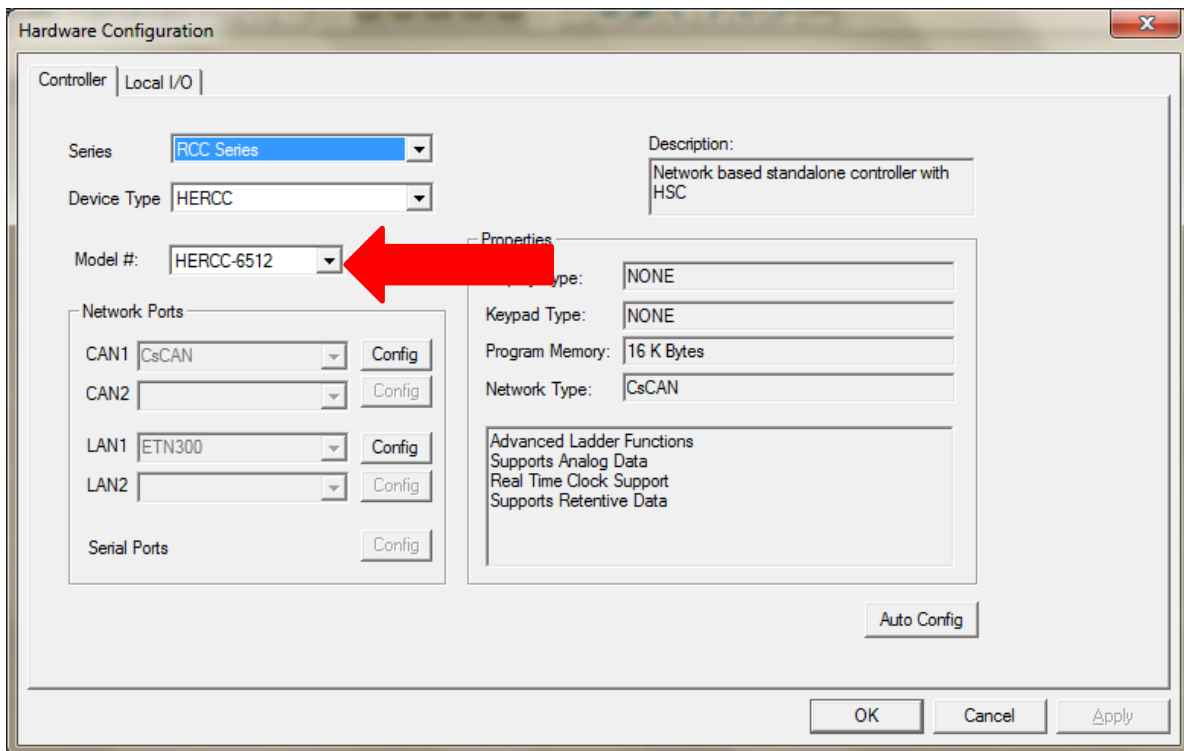

Figure 11.1 - Hardware Configuration Dialog

3. Click the **Config** button to the right of LAN1 for LAN 1, revealing the Ethernet Module Configuration dialog as shown in Figure 11.2

LAN1 Configuration

Register Usage

Default Settings	Register	Get settings from
IP Address: 192 . 168 . 254 . 128	Name:	Configuration
Net Mask: 255 . 255 . 255 . 0	Name:	Configuration
Gateway: 0 . 0 . 0 . 0	Name:	Configuration
Status:	Name:	
Version:	Name:	

Protocol Support

Resident Protocols

- ICMP (Ping)
- EGD (Ethernet Global Data)
- Modbus Slave
- Ethernet/IP
- FTP (File Server)

Downloadable Protocols

ETN1/1 -- None --	Network	Devices	Scan List
ETN1/2 -- None --	Network	Devices	Scan List

OK Cancel

Figure 11.2 - Ethernet Configuration

Configure the Ethernet Module parameters as follows:

IP Address: Enter the static IP Address for the Ethernet Module being configured.

NOTE: *IP Addresses are entered as four numbers, each ranging from 0 to 255. These four numbers are called octets, and they are always separated by decimal points.*

Net Mask: Enter the Net Mask (sometimes called Subnet Mask) being used by all nodes on the local network. Typical local networks use Class C IP Addresses, in which case the low octet (rightmost number) is used to uniquely identify each node on the local network. In this case, the default Net Mask value of 255.255.255.0 should be used.

Gateway: Enter the IP Address of a Gateway Server on the local network that allows for communication outside of the local network. To prevent the Ethernet Module from communicating outside the local network, set the Default Gateway IP Address to 0.0.0.0 (the default setting).

Status Register: Enter an OCS Register reference (such as %R100) to indicate which 16-bit OCS register will have the Ethernet Status Word written to it. Table 11.3 shows how this register value is formatted and explains the meaning of each bit in the Status Word.

Table 11.3 - Ethernet Status Word Register Format															
High Byte								Low Byte							
Bit 16	Bit 15	Bit 14	Bit 13	Bit 12	Bit 11	Bit 10	Bit 9	Bit 8	Bit 7	Bit 6	Bit 5	Bit 4	Bit 3	Bit 2	Bit 1
0	0	Dup	Spd	0	Rx	Tx	Link	TCP Connections							
Status Bit(s)		Status Indication						Status Values							
0		Reserved						Always 0							
Dup		Link Duplex (Auto-Negotiated)						0 = Half Duplex 1 = Full Duplex							
Spd		Link Speed (Auto-Negotiated)						0 = 10MHz 1 = 100MHz							
Rx		Receive State						0 = Inactive 1 = Active							
Tx		Transmit State						0 = Inactive 1 = Active							
Link		Link State						0 = Down 1 = Up							
TCP Connections		Total Number of Active TCP Connections (CsCAN, SRTP, Modbus, EIP, FTP, HTTP)						0 40							

Version Register: Enter a register reference (such as %R101) to indicate which 16-bit register will have the Ethernet Firmware Version written to it. The value stored in the Version Register is (Ethernet Firmware Version * 100). For example, for Ethernet Firmware Version 4.30, the Version Register will contain 430. This version will only change with a complete controller Firmware Update.

Ethernet Module Register Usage - Standard Configuration

To perform a standard configuration, fill in the **IP Address**, **Net Mask**, and **Gateway** with addresses that are valid for the network to which the controller is connected. If desired, registers may be specified in which these settings will be reflected.

NOTE: If registers are to be used to define the IP, use registers from the retentive set: %R1 - %R256. Assigning from the non-retentive set may be lost through a power cycle.

Leave the **Get settings from** selection set to **Configuration**.

Optionally, check the **Use CAN ID for last Octet** box in order to leave the last octet of the IP Address editable by way of changing the controllers CAN ID. This does not affect the Net Mask or Gateway settings.

NOTE: The low octet of the IP Address can be replaced with the unit's CAN Network ID, by checking the **Use CAN ID for last Octet** checkbox.

CHAPTER 12: REMOVABLE MEDIA

12.1 Overview

All RCC6512 models provide a Removable Media slot, labeled **Memory Card**, which supports standard microSD Flash memory cards. microSD cards can be used to save and load applications.

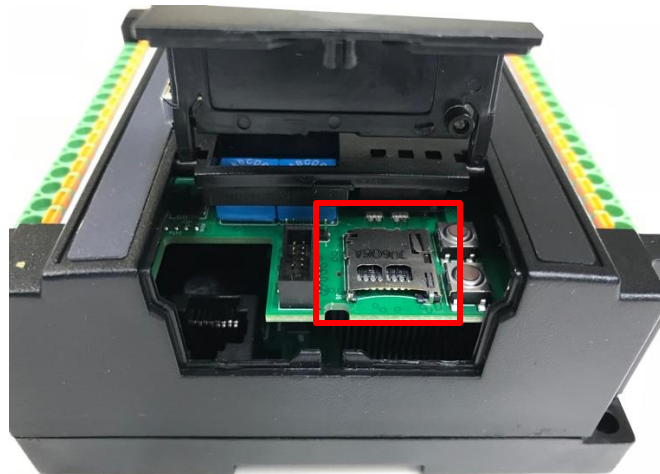

Figure 12.1 - Removable microSD Memory Card Slot

12.2 microSD Cards

The Memory Card slot is equipped with a “push-in, push-out” connector and a microSD card can be safely inserted into the memory card slot whether the RCC6512 power is On or Off.

To install a microSD card: Align its 8-pin gold edge connector down, facing the circuit board of the RCC6512 unit as shown in **Figure 12.1**; then carefully push it all the way into the Memory slot. Ensure that it clicks into place.

To remove the microSD card: Push in on the top of the card gently to release the spring. The card pops out for removal.

12.3 microSD File System

The microSD Memory slot supports SDHC IN FAT32 format up to 32GB max. The microSD slot can be used for program download (*.pgm), to save the downloaded program (*.pgm), for loading and logging data (*.csv). Long filenames are supported for program download.

12.4 Using Removable Media to Load and Save Applications

A special file type, with a .PGM extension, is used to store RCC6512 application programs on microSD.

Pressing and holding the **LOAD** button for three seconds upon power up will load the program that is stored on the microSD. Refer to the [Troubleshooting](#) chapter for more details.

Cscape can also save an application directly to a microSD card, which is plugged into the PC's microSD compatible card reader by selecting the Export to Removable Media item on the Cscape File menu.

12.5 Removable Media (RM) Function Blocks in Cscape

NOTE: For detailed information regarding RM function blocks and parameters, refer to the help file in Cscape Software.

The following RM functional blocks are available in Cscape Software. These function blocks will reference microSD when filename is prefixed with 'A:' or nothing.

Read RM csv	Allows reading of a comma-separated value file from the microSD interface into the controller register space.
Write RM csv	Allows writing of a comma-separated value file to the microSD interface from the controller register space.
Rename RM csv	Allows renaming a file on the RM card. The data in the file is not changed.
Delete RM csv	Allows deleting a file on the RM card
Copy RM csv	Allows copying a file on the RM card. The data in the file is not changed.

12.6 Filenames used with the Removable Media (RM) Function Blocks

The RM function blocks support the flash with a DOS/Windows standard FAT-16 file system. All names must be limited to the "8.3" format where the filename contains eight characters a period then a three-character extension. The entire filename including any path must be less than or equal to 147 characters.

When creating filenames and directories it is sometimes desirable to include parts of the current date or time. There are six special symbols that can be entered into a filename that are replaced by the OCS with current time and date information.

Table 12.1 - Filename Special Symbols		
Symbol	Description	Example
\$Y	Substitutes the current 2 digit year	2004 = 04
\$M	Substitutes the current month with a 2 digit code	March = 03
\$D	Substitutes the current day	22 nd = 22
\$h	Substitutes the current hour in 24 hour format	4 pm = 16
\$m	Substitutes the current minute	45 = 45
\$s	Substitutes the current second	34 = 34

NOTE: All the symbols start with the dollar sign (\$) character. Date symbols are in upper case, and time symbols are in lower case. The following are examples of the substituted time/date filenames:

Current date and time	= March 1, 2013 3:45:34 PM
Filename: Data\$M\$D.csv	= Data0301.csv
Filename: Year\$Y\Month\$M\aa\$D_\$h.csv	= Year04\Month03\aa01_15.csv
Filename: Month_\$M\Day_\$D\h_\$m_\$s.csv	= Month_03\Day_01\15_45_34.csv

12.7 System Registers used with RM

%SR174 Removable Media Protect	Write a 1 to %SR174 to prohibit read/write access to the removable media card. Write a zero (0) to allow access.
%SR175 Status	This shows the current status of the RM interface.
%SR176 Free Space	This 32-bit register shows the free space on the RM card in bytes.
%SR178 Card Capacity	This 32-bit register shows the total card capacity in kilobytes.

Possible status values are shown in the table:

Table 12.1 - RM Status Values	
0	RM interface OK
1	Card present but unknown format
2	No card in slot
3	Card present, but not supported
4	Card swapped before operation was complete
5	Unknown error

For additional status information, consult the Cscape Help file.

CHAPTER 13: FAIL-SAFE SYSTEM

13.1 Overview

The Fail-Safe System is a set of features that allow an application to continue running in the event of certain types of "soft" failures. These "soft" failures include:

- Battery power loss
- Battery-Backed Register RAM or Application flash corruption due to, for example, an excessive EMI event.

The Fail-Safe System has the following capabilities:

- Manually backup the current battery-backed RAM Register Settings into flash memory.
- Manually restore Register Settings from the values previously backed up in flash memory to battery-backed RAM.
- Detect corrupted Register Settings at power-up and then automatically restore them from flash.
- Detect corrupted or empty application in flash memory at power-up and then automatically load the AUTOLOAD.PGM application file from Removable Media (Compact flash or microSD).
- If an automatic Register Restore or Application Load occurs, the OCS can automatically be placed in RUN mode.

13.2 Settings

To use the Fail-Safe feature, the user needs to do the following:

1. From Cscape, create AUTOLOAD.PGM for the application program using 'Export to Removable Media'.
2. Place the Removable Media with AUTOLOAD.PGM in the device.
3. Set the 'Enable AutoLoad' option in the device to YES.
4. Set the 'Enable AutoRun' option to YES if the controller needs to be placed in RUN mode automatically after automatic restore of data or AutoLoad operation.
5. Backup the current battery-backed RAM Register contents in onboard flash memory.

13.3 Backup / Restore Data

Backup OCS Data:

When initiated, this will allow the user to manually copy battery-backed RAM contents on to the onboard flash memory of the OCS. This will have the effect of backing up all the registers and controller settings (Network ID, etc.) that would otherwise be lost due to a battery failure. %SR164.4 is set to 1 when backup operation is performed.

Restore OCS Data:

When initiated, this will allow the user to manually copy the backed-up data from the onboard flash to the battery-backed RAM.

A restore operation will be automatically initiated if 1) a backup has been previously created and 2) on power-up the battery-backed RAM registers fail their check.

The following process will be followed for restoring data:

- The controller will be placed in IDLE mode.
- Data will be copied from onboard flash memory to OCS battery-backed RAM
- The controller will reset.
- The controller will be put in RUN mode if the AutoRun setting is 'Yes', or else it will remain in IDLE mode.

%SR164.3 is set to 1 when an automatic restore operation is performed. This bit is reset to the value of "0" when a new backup is created.

Restoring of data can be manually performed by setting %SR164.14 to 1, this in turn sets %SR164.15 to 1. The user needs to set %SR164.15 to 0 complete the restore operation or set %SR164.14 to 0 to abort.

Clear Backup Data:

When initiated, the backup data will be erased from the onboard flash and no backup will exist. %SR164.4 and %SR164.3 is reset to 0 when backed up data is erased.

The OCS follows the following sequence in execution of Automatic Restore:

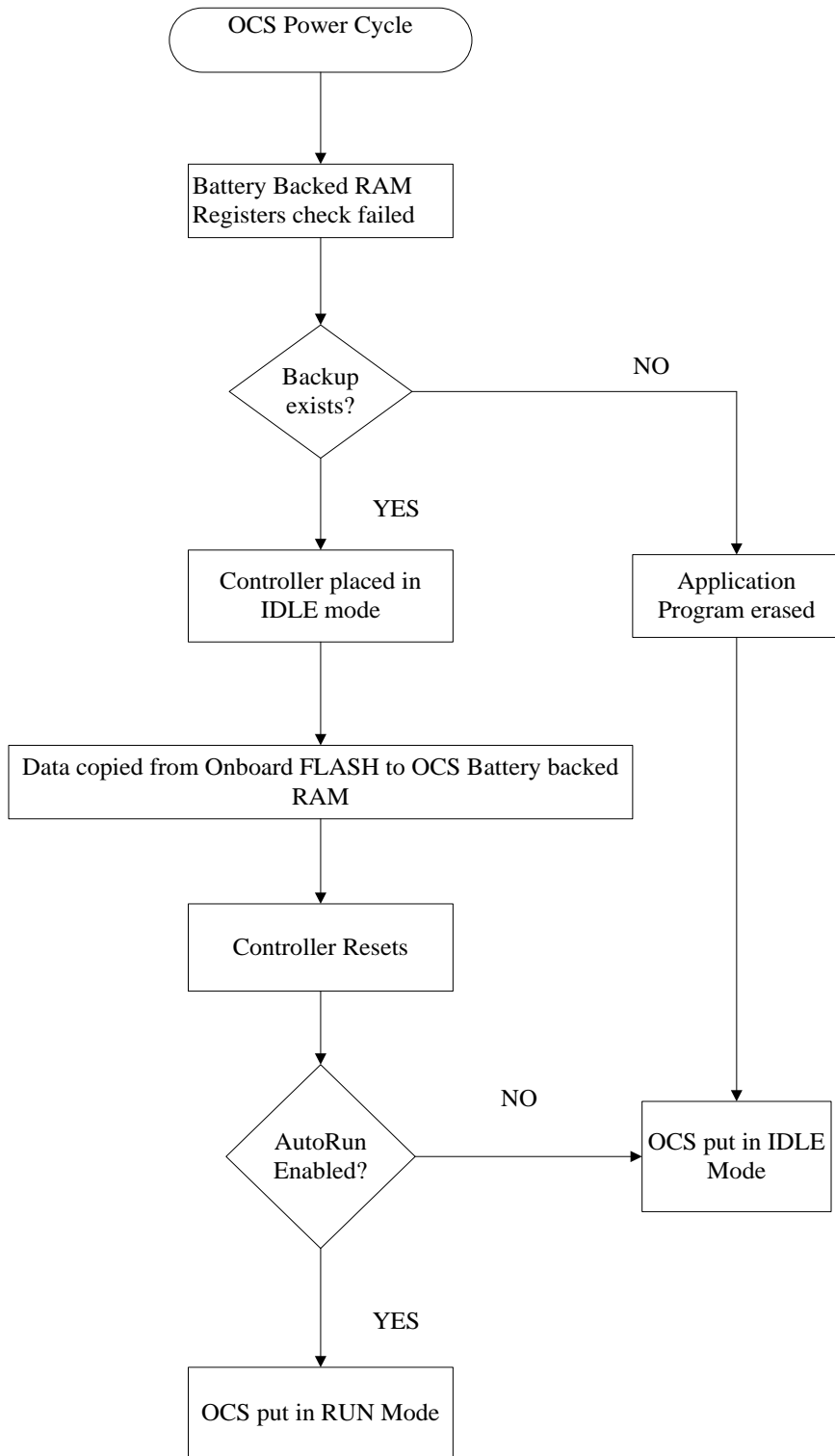

Figure 13.1 - Flow Chart for Automatic Restore

13.4 AutoLoad

This option allows the user to specify whether the OCS automatically loads the application AUTOLOAD.PGM located in Removable Media.

When the AutoLoad setting is enabled (set to YES), it can be automatically initiated at power-up.

The automatic initiation will happen only in the following two cases:

- When there is no application program in the OCS and a valid AUTOLOAD.PGM is available in the removable media of the device.
- When the program residing in onboard memory is corrupted and a valid AUTOLOAD.PGM is available in the removable media of the device.

When the AutoLoad setting is not enabled (set to NO), OCS will be in IDLE mode and the application is not loaded.

%SR164.6 can be set to enable AutoLoad feature.

The OCS follows the following sequence in execution of AutoLoad:

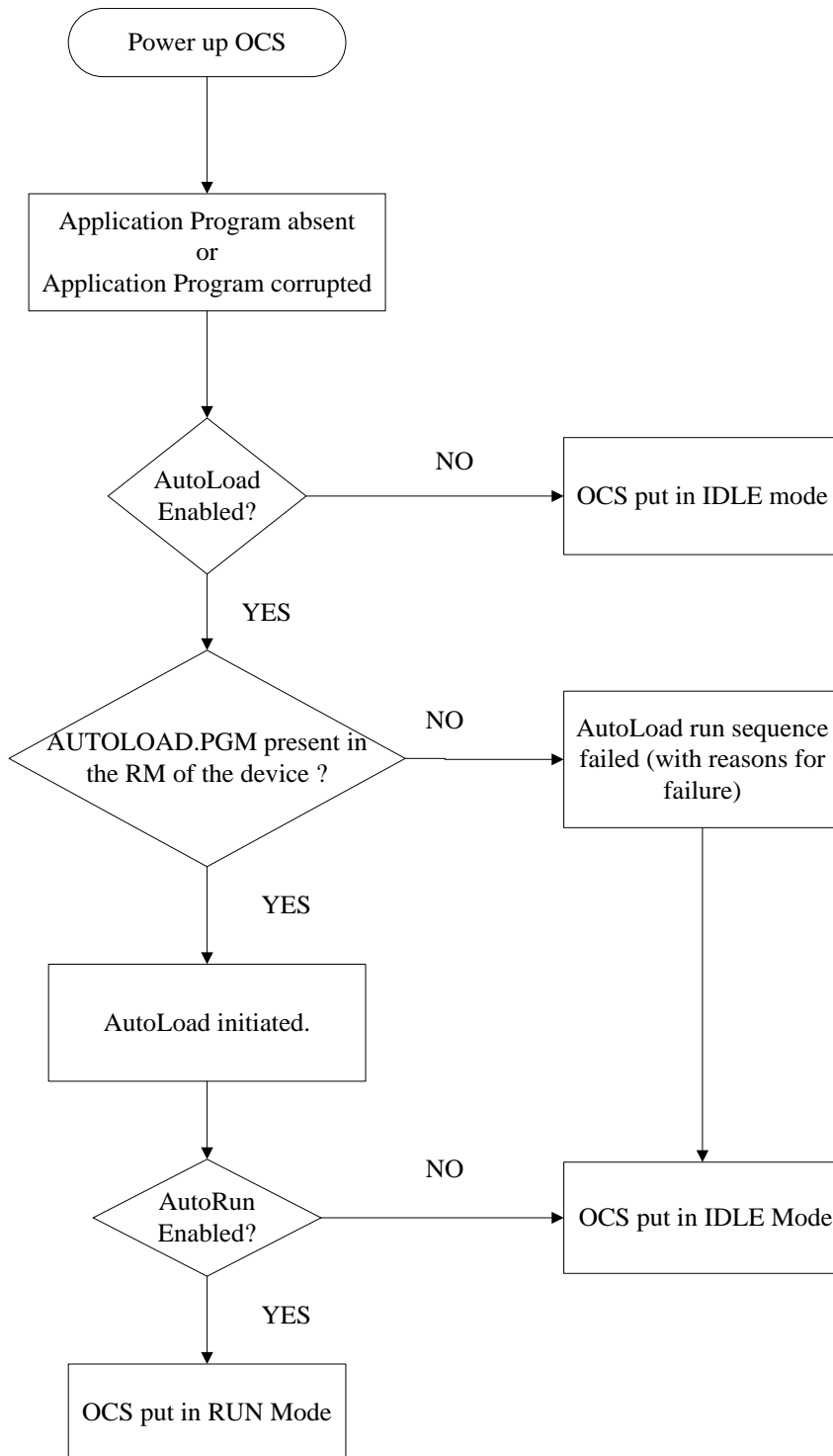

Figure 13.2 - Flow Chart for AutoLoad

13.5 AutoRun

This option, when enabled (YES), allows the user to automatically place the OCS into RUN mode after the AutoLoad operation or automatic Restore Data operation.

When the AutoRun setting is disabled (NO), the OCS remains in the IDLE mode after a Restore Data or AutoLoad operation.

%SR164.5 can be set for putting the system into RUN mode automatically, once an AutoLoad has been performed or an Automatic Restore has occurred.

CHAPTER 14: MAINTENANCE

14.1 Firmware Updates

The RCC6512 products contain field updatable firmware to allow new features to be added to the product later. Firmware updates should only be performed when a new feature or correction is required.

WARNING: Firmware updates should only be performed when the equipment being controlled by the RCC6512 is in a safe, non-operational state. Communication or hardware failures during the firmware update process can cause the controller to behave erratically resulting in injury or equipment damage. Make sure the functions of the equipment work properly after a firmware update before returning the device to an operational mode.

Steps for updating the firmware:

1. Establish communication between Cscape and the controller using a direct serial connection to MJ1.
2. Make sure your application is available on your PC or upload the application.
3. Make sure the machinery connected to the RCC6512 is in a safe state for firmware update (see warning above).
4. Start the firmware update by selecting **File → Firmware Update Wizard**.
5. The correct product type should be selected, if it is not select the type of controller from the drop-down list.
6. Wait for the firmware update to complete.
7. If there is a communication failure check the cable, connections and comm. port setting and try again.
8. Firmware updates typically delete the user applications to ensure compatibility. You will need to reload your application.
9. Test the operation of the equipment with the new firmware before returning the RCC6512 system to an operation mode.

LED	Off	ON	Flash (1Hz)
PWR	No power applied	10-28VDC applied	
OK	Self test fail	Self test pass	I/O forcing enabled.
RUN	Stop mode	Run Mode	Do I/O Mode.

Load switch

1. Pressing the **LOAD** switch during power-up boots from the microSD card. This starts a Firmware Load if the microSD is bootable and valid firmware files are found on it.
2. After boot-up, pressing the **LOAD** switch for three (3) seconds will load an Application file stored on the microSD. The application file name must be DEFAULT.PGM. When loading an application file from microSD, there should not be firmware files present on the microSD card.

NOTE: When pressing the LOAD switch for three seconds after boot-up, if firmware files present on the microSD card, it can trigger a firmware update that may not properly complete.

During the firmware update, the RUN and OK light will flash an alternating pattern. Once the firmware update is finished, load a program into the RCC and place in RUN mode.

14.2 Replacing Backup Battery

The RCC6512 has a battery backup system that uses a lithium coin battery with a harness assembly which is available from Horner Automation, part no. **BAT00013**. The battery backs the real time clock and retentive registers when power is removed.

The battery will generally last seven (7) to ten (10) years. Environmental conditions, including extreme temperatures and humidity, can affect battery life. If the battery is older than seven (7) to ten (10) years old, it is recommended that it be replaced as preventative maintenance.

WARNING: DO NOT USE IF BATTERY IS LEAKING OR HAS BEEN DAMAGED.

WARNING: LITHIUM BATTERIES MAY EXPLODE OR CATCH FIRE IF MISTREATED. DO NOT RECHARGE, DISASSEMBLE, HEAT ABOVE 100° C (212° F) INCINERATE, OR PUNCTURE.

WARNING: EXPLOSION HAZARD - BATTERIES MUST BE ONLY BE CHANGED IN A AREA KNOWN TO BE NON-HAZARDOUS.

WARNING: Disposal of lithium batteries must be done in accordance with federal, state, and local regulations. Be sure to consult with the appropriate regulatory agencies *before* disposing batteries. In addition, do not recharge, disassemble, heat or incinerate lithium batteries.

WARNING: Do not make substitutions for the battery. Be sure to only use the authorized part number to replace the battery.

NOTE: The battery comes as an assembly with harness that includes a two-pin connector, and the complete assembly is field replaceable.

Below are the steps to replace the battery:

1. Disconnect all power from the RCC6512 and remove from the DIN rail.
2. Remove all connectors, and then carefully use a flat head screwdriver to press and release the four clips. Remove the back cover.
3. The battery is connected to the I/O board by a two-pin connect. Carefully remove the battery and connector from the board.
4. Dispose of the battery properly, see the above warnings on disposal regulations.
5. Insert the two-pin connector of the new battery into the I/O board.
6. Replace the back cover over the unit and gently press each corner evenly to snap the clips back into place.
7. Apply power to the unit. If the battery is not functioning properly, remove the battery and contact Horner Technical Support.

CHAPTER 15: MODBUS COMMUNICATIONS

15.1 Modbus Overview

For complete Modbus instructions, please refer to the Help file in Cscape.

Modbus (serial) and Modbus TCP/Modbus UDP (Ethernet) are popular, de-facto standard protocols that allow industrial devices from multiple manufacturers to easily share data in real-time. For Modbus serial communications, the RCC can act as a Slave. For Modbus Ethernet communications, the RCC can act as a Server (Slave) for Ethernet.

Modbus protocol (serial or Ethernet) allows for multiple slaves. The master always initiates the conversation by sending a request to a particular slave. Only the addressed slave will send a response when the request is completed. Should the slave be unable to complete the request, it returns the appropriate error response. Should the slave be unable to respond, the master's timeout timer expires to provide an indication of **No Response**.

15.2 Modbus Slave Overview

For complete Modbus Slave instructions, please refer to the Help file in Cscape.

The Modbus function block, when used with the appropriate Modem and /or Open function blocks, allows the primary serial port on the controller to act as a Modbus/RTU slave. The Modbus function supports both ASCII and RTU modes of operation across a range of baud rates and protocol frames. Also supported is port activity status, an inactivity timer, support for call-on exception, and support for store and forward (repeater) operation for radio modems.

For Modbus Server (slave) over Ethernet, the Modbus/TCP protocol simply needs to be selected in the LAN1 section of the Hardware Configuration dialog box in Cscape - see [Section 11.3.2](#). The RCC will automatically reply to Read and Write requests from a Modbus TCP Client (master).

[Section 14.4](#) describes the supported Modbus Commands as well as the Modbus Map for RCC References. This map applies for both Modbus serial and Modbus over Ethernet.

15.3 Modbus Addressing Table for RCC Units

To access RCC registers, a Modbus Master must be configured with the appropriate register type and offset. This is usually accomplished with one of two methods:

1. The first method uses **Traditional Modbus References**, in which the high digit represents the register type and the lower digits represent the register offset (starting with Register 1 for each type). Since only four register types can be represented in this manner, RCC Modbus Function Blocks pack several RCC register types into each Modbus register type. Starting addresses of each RCC register type are shown in the **Traditional Modbus Reference** column of the Table 15.1.

2. The second method requires the Modbus Master to be configured with a specific **Modbus Command** and **Modbus Offset**. The supported Modbus commands and the associated offsets are also illustrated in Table 15.1.

Table 15.1 - Modbus Master Mapping					
RCC Reference	Maximum Range	Traditional Modbus Reference (5 Digits)	Expanded Modbus Ref. (6 Digits)	Modbus Commands	Modbus Offset
%I1	2048	10001	010001	Read Input Status (2)	0
%IG1	64	13001	013001		3000
%S1	13	14001	014001		4000
%K1	0	15001	015001		5000
<hr/>					
%Q1	2048	00001	000001	Read Coil Status (1) Force Coil (5) Force Multiple Coils (15)	0
%M1	2048	03001	003001		3000
%T1	2048	06001	006001		6000
%QG1	64	09001	009001		9000
<hr/>					
%AI1	512	30001	030001	Read Input Register (4)	0
%AIG1	32	33001	033001		3000
%SR1	200	34001	034001		4000
<hr/>					
%AQ1	512	40001	040001	Read Holding Register (3) Load Register (6) Load Multiple Registers (16)	0
%R1	2488	40513	040513		512
%R1	2048	43001	043001		3000
%AQG1	32	46001	046001		6000
%R1	4096	--	410001		10000

CHAPTER 16: TROUBLESHOOTING / TECHNICAL SUPPORT

Chapter 16 provides commonly requested **troubleshooting information and checklists** for the following topics.

- Connecting to the RCC6512 controller
- Local controller and local I/O
- CsCAN Network
- Removable media

If this information is not enough, please contact Technical Support at the locations indicated at the end of this chapter.

16.1 LED - Normal Functionality

Table 16.1 - LED: Normal Functionality				
LED Type	When OFF	When ON	When Flashing (1Hz)	When Toggling
PWR	No Power Applied	10-28VDC applied	N/A	N/A
OK	Self-Test Fail	Self-Test Pass	I/O Forcing Enabled	Application Loading from microSD
RUN	Stop Mode	Run Mode	Do I/O Mode	
LED	State	Description		
MS (Module Status)	Green	Module OK		
	Red	Real-Time Clock or I/O Configuration Error		
	Red Flashing	Illegal Ladder Instruction or Ladder CRC Error		
NS (CAN Network Status)	Green	Network OK		
	Red	Illegal ID, Duplicate ID, or No Response from Network Error		

16.2 LED Load Program/Firmware Functionality

Table 16.2 - LED Load Program/ Firmware Functionality			
LED OK & RUN	Flashing Alternately	Flashing Together	Flashing Stops
Load program or firmware	Download in Progress	Download fails, number of flashes indicates the error.	Download Complete, unit reboots (allow 30 seconds).

16.3 Switch - Normal Functionality

Load switch

- Used for program, as noted in previous section

Run/Stop switch

- After boot-up, pressing the **RUN/STOP** switch for three (3) seconds toggles the RCC between RUN and STOP modes.

Switch - Erase Program Function

Load and Run/Stop

- After boot-up, pressing both Load and Run/Stop switches for three (3) seconds performs an "Erase All" function, which deletes all application programs.

16.4 LED - Diagnostic Functionality

The LEDs are also used to indicate some fault conditions in the unit. The two LEDs, OK and RUN, will flash a specific number of times depending upon the fault. There will be a two-second gap and the pattern will be repeated. The number of flashes and the associated error are as follows:

No. of flashes	Table 16.3 - Diagnostic LED Flashing/ Fault Meaning
2	The MAC ID is empty.
3	The internal MAC file is corrupt.
4	The MAC ID TXT file is invalid.
5	The MAC ID file is not found or the USD card is empty or missing system files.

16.5 Connecting to the RCC6512

Cscape connects to the local controller automatically when the serial connection is made. The status bar below shows an example of a successful connection. This status bar is located in the bottom right hand corner of the Cscape window.

Local:253 Target:253(R) [no forces]

In general, the **Target** number should match the **Local** number. The exception to this is when the controller is being used as a "pass through" unit where other controllers on a CsCAN network could be accessed through the local controller.

Determine connection status by examining feedback next to **Local & Target** in the status bar of Cscape.

Table 16.4 - Cscape Target & Local Numbers	
Local: ###	If a number shows next to Local then communication is established to the local controller.
Local: No Port	Cscape is unable to access the COM port of the PC. This could mean that Cscape is configured for a COM port that is not present or that another program has control of the COM port. Only one Cscape window can access a port at a time. Subsequent instances of Cscape opened will indicate No Port.
Local: No Com	Cscape has accessed a PC COM port, but is not communicating with the controller. This typically occurs when the controller is not physically connected.
Local: ???	Unknown communication error. Close Cscape, power cycle the controller and reopen Cscape with a blank project. Check Local.
Target: #(I,R,D)	If I (idle), R (run), or D (do I/O) shows next to Target number then communication is established to the target controller.
Target: #(?)	Communication is not established to the target controller. Check node ID of controller and set Target to match. Make sure local connection is established.

16.5.1 Connecting Troubleshooting Checklist (serial port - MJ1 Programming)

1. Controller must be powered up.
2. Ensure that the correct COM port is selected in Cscope. **Tools → Applications Settings → Communications .**
3. Ensure that a cable with proper pinout is being used between PC and controller port MJ1.
4. Check that a Loaded Protocol or ladder is not actively using MJ1.
5. Successful communications with USB-to-serial adapters vary. If in doubt, Horner APG offers a USB to serial adapter. Part numbers HE-XCK and HE-CPK.

16.5.2 Connecting Troubleshooting Checklist (USB Port - Mini B Programming)

1. Controller must be powered up.
2. Ensure that the correct COM port is selected in Cscope. **Tools → Applications Settings → Communications.**
3. Be sure that the USB cable is connected between the PC and the controller. Check Windows Device Manager to ensure that the USB driver is properly installed and to verify the port number.

15.6.3 Connecting Troubleshooting Checklist (ETN port programming)

1. Controller must be powered up.
2. Ensure that the correct IP address is given in the Ethernet field and correct Mode is selected, in Cscope: **Tools → Application Settings → Communications .**
3. Ensure that an Ethernet connection has been established by pinging the controller from the Windows DOS prompt.

WARNING: Setting outputs ON in Do I/O mode can result in injury or cause machinery to engage in an unsafe manner depending on the application and the environment.

16.6 CsCAN Network

For complete information on setting up a CsCAN network, refer to CAN Networks manual (MAN0799) by visiting the Horner websites for the address to obtain documentation and updates.

16.6.1 CsCAN Network Troubleshooting Checklist

1. Use the proper Belden wire type or equivalent for the network as specified in MAN0799.
2. The RCC6512 does not provide 24VDC to the network. An external voltage source must be used for other devices such as SmartStix I/O.
3. Check voltage at both ends of the network to ensure that voltage meets specifications of attached devices.
4. Proper termination is required. Use 121 Ω (or 120 Ω) resistors at each end of the network. The resistors should be placed across the CAN_HI and CAN_LO terminals. The RCC6512 has a software selectable terminator.
5. Measure the resistance between CAN_HI and CAN_LO. If the network is properly wired and terminated, there should be around 60 Ω .
6. Check for duplicate node ID's.
7. Keep proper wires together. One twisted pair is for V+ and V- and the other twisted pair is used for CAN_HI and CAN_LO.
8. Make sure the baud rate is the same for all controllers on the network.
9. Assure shields are connected at one end of each segment -- they are not continuous through the network.
10. Do not exceed the maximum length determined by the baud rate and cable type.
11. Total drop length for each drop should not exceed 6 m (20'). A drop may include more than one node. The drop length adds to the overall network length.
12. Network should be wired in "straight line" fashion, not in a "star" pattern.
13. In applications requiring multiple power supplies, make sure the V- of all supplies is connected and to earth ground at one place only.
14. In some electrically noisy environments, it may be necessary to add repeaters to the network. Repeaters can be used to add additional nodes and/or distance to the network and protect the signal against noisy environments.

16.7 Removable Media - Basic Troubleshooting

Table 16.5 - Removable Media Troubleshooting	
Description	Action
RCC6512 does not read media card.	The media card should be formatted with the RCC6512.
RCC6512 will not download project file.	Make sure the project file is saved as a .pgm file and not a .csp file. In addition, to file must be .pgm, the file's I/O configuration must match the RCC6512 configuration for it to download.

16.8 Technical Support Contacts

For manual updates and assistance, contact Technical Support at the following locations:

North America:

Tel: (317) 916-4274

Fax: (317) 639-4279

Website: <https://hornerautomation.com>

Email: techsppt@heapg.com

Europe:

Tel: (+) 353-21-4321-266

Fax: (+353)-21-4321826

Website: <https://www.hornerautomation.eu/>

Email: technical.support@horner-apg.com

MAIN INDEX

- %Q bits, 52
- Accessories, 14
- accumulator, 57, 58
- Add Target Screenshot in Cscape, 36
- Analog Input Configuration Dialog, 47
- Analog Inputs, 54
- Analog Output Configuration Dialog, 48
- Analog Outputs, 55, 57
- AutoLoad, 86
- Automatic Restore, 85
- AutoRun, 88
- Backup / Restore, 84
- CAN Comm
 - Cscape Programming, 72
 - I/O Expansion (Network I/O), 72
 - Ladder-Controlled, 72
 - Overview, 70
 - Ports, 70
- CAN Communications, 70
- CAN1 & CAN2 Connector Locations, 70
- CAN1 / CAN2 Port Pins, 72
- CE, 9
- Clear Backup Data, 84
- COM, 72, 97, 98
- COM port, 97
- Communicating via MJ1 Serial Port, 38
- Communicating via On Board Ethernet Port, 39
- Communicating via Onboard Ethernet Port, 39
- Communication Configuration Dialog, 37
- Communication options, 73
- Communications Port, 33, 35, 98
- Compliance
 - CE, 9
- Count**, 64
- Cscape Program
 - Via Serial Port, 69
- Cscape, 13, 29, 31, 32, 38, 51, 52, 53, 55, 56, 69, 72, 79, 97, 98
 - Analog In Configuration, 47
 - Analog Out Configuration, 48
 - Configuration Procedures, 43
 - Digital In / HSC Configuration, 44
 - Digital Out / PWM Configuration, 46
 - Establishing Communications, 32
 - Overview, 31
 - Status Bar, 31
- CSCAPE CONFIGURATION, 31
- Cscape Connection Wizard Screenshots, 34
- Cscape Target & Local Numbers, 97
- CscapeStatus Bar, 31
- datasheet, 4
- Default Gateway, 76
- Device Manager, 98
- Devices to Connect to RCC6512, 12
- Digital Input / HSC Configuration Dialog, 42
- Digital Inputs, 53
- Dimensions, 16
- Duty Cycle, 66
- Duty Cycle Examples**, 66
- Electrical Installation, 18
- Ethernet, 32
- Ethernet Communication, 73
- Ethernet Module
 - Default Gateway, 76
 - IP Address, 76
 - Net Mask, 76
 - Status Register, 76
 - Version Register, 76
- Ethernet Module Configuration, 74, 75
- Ethernet Module Protocols & Features, 73
- Ethernet Module Protocols and Features, 73
- Ethernet Module Register Usage - Standard Configuration, 77
- Ethernet Module Specifications, 73
- Ethernet Status Word Register Format, 76
- Ethernet System Requirements, 73
- Fail Safe System Overview, 83
- Fail Safe System Settings, 83
- Features, 13
- Filename Special Symbols, 80
- Firmware Updates, 89
- Frequency, 57
- Front Panel and USB Programming Connector, 32
- fusing, 52
- General I/O
 - Overview, 51
- GENERAL I/O**, 51
- Glossary, High Speed I/O, 56
- Ground Specification, 18
- Grounding
 - Locations of Information, 9
- Grounding Definition, 18
- Hardware Configuration Dialog, 74
- Hardware Wizard Screenshots, 33
- High Speed
 - Frequency, 57

- High Speed / PWM
 - Overview, 56
- High Speed Counting, 56
- HIGH SPEED I/O, 56
- HSC, 43, 44, 56, 57, 60, 64, 65
- HSC Output Functions Register Map, 65
- IP Address, 76
- LED – Diagnostic Functionality, 96
- LED Load Program/ Firmware Functionality, 95
- LED Normal Functionality, 95
- LIMITED WARRANTY, 3
- Maintenance, 89
- Manual Index, 11
- MECHANICAL INSTALLATION, 15
- microSD Cards, 78
 - Installing / Removing, 78
- microSD System, 78
- Model / I/O Overview, 51
- Net Mask, 76
- Overview of the RCC6512, 10
- Panel Box
 - Noise, 17
 - Orientation, 17
 - Temperature, 17
- Panel Box Shock and Vibration, 17
- Primary Power Port, 20
- Primary Power Port as Viewed Looking at the RCC6512, 20
- PROGRAMMING EXAMPLES, 3
- Pulse, 58
- pulse mode, 58
- pulse stream, 58
- Pulse Width Modulation, 56, 64
- PWM, 43, 46, 52, 56, 64, 65, 66
 - Registers, 65
- Quadrature, 45, 57
- RCC6512 Dimensions, 16
- RCC6512 Manual PREFACE, 2
- register mapping, 51, 52
- Register Match, 59
- registers, 21
- Registers
 - %S / %SR, 21
 - Definitions, 21
 - I/O, 30
 - Resource Limits, 30
- Removable Media
 - Load / Save Applications, 79
 - Overview, 78
- Removable microSD Memory Card Slot, 78
- RM Status Values, 81
- RS-485 Termination, 69
- safety / compliance, 8
- Safety Warnings, Guidelines, 8
- Serial Comm
 - Cscape Programming, 69
 - Ladder-Controlled, 69
 - Overview, 68
 - Ports, 68
- SERIAL COMMUNICATIONS, 68
- Serial Port Pinouts, 68
- Solid-State Digital Outputs, 52
- sourcing, 52, 53
- stop state, 52
- Switch – Erase Program Function, 96
- Switch - Normal Functionality, 96
- System Registers used with RM, 81
- target ID, 38
- Target ID**, 38
- target indicator, 38, 42
- Technical Support**, 2, 95, 100
 - Contacts, 100
- Testing for Good Ground, 19
- totalize, 57
- Totalize, 57
- Troubleshooting
 - Common problems, 97
 - Connecting Checklist, 98
 - CsCAN Checklist, 99
 - CsCAN Network, 99
 - Removable Media, 100
- troubleshooting / technical support, 95
- Troubleshooting Checklist (serial port – MJ1) Programming, 98
- Troubleshooting Checklist (USB Port - Mini B) Programming, 98
- Troubleshooting Checklist (Ethernet port Programming), 98
- Two-Point Ground Connection Test, 19
- Types of Registers, 21
- Typical Output Wiring, 52
- USB, 32, 33, 72, 98
- Visual Overview of Types of Devices that can be connected to RCC6512, 12
- Where to Find Information, 11

Change Log

Date	Rev	Description	Location in Doc
12/17/2021	9.1	Removed Expansion I/O information (7061)	Removed from CAN Communications chapter.