

PhyMetrix®



PhyMetrix Loop-powered Moisture analyzer User's Manual for Models PLMa and PLMaEx

Read this manual before using the analyzer. For personal and system safety, and for optimum product performance, make sure you thoroughly understand the contents before installing, using, or maintaining this analyzer.

Please visit our website at www.phymetrix.com for other products that may be applicable to your needs.

Every effort has been made to ensure accuracy in the contents of this manual. Should there be any doubts to the accuracy of the content please contact the manufacturer.
The contents of this manual are subject to change without notice.

The instructions, procedures, drawings, specifications and concepts contained in this manual are the property of Phymetrix Inc., and shall not be used as the basis for the manufacture or sale of apparatus or services, or reproduced or copied or transmitted in any form or by any means without written permission.

Warranty

This instrument is warranted, to the original end-user purchaser, against defects in materials and workmanship. Liability under this warranty is limited to restoring the instrument to normal operation or replacing the analyzer, at the sole discretion of the manufacturer. This warranty is effective from the date of delivery to the original purchaser. If Phymetrix determines that the equipment was defective, the warranty period is:

- one year from delivery for electronic or mechanical failures
- one year from delivery for sensor shelf life

If Phymetrix determines that the equipment was damaged by misuse, improper installation, the use of unauthorized replacement parts, or operating conditions outside the guidelines specified, the repairs are not covered under this warranty.

Normal wear and tear, parts damaged by abuse, misuse, negligence or accidents are specifically excluded from the warranty.

Purchaser acknowledges that in accepting and using this analyzer, notwithstanding any contrary term or provision in the purchaser's purchase order or otherwise, the only warranty extended by Phymetrix is the express warranty contained herein. Purchaser further acknowledges that there are no other warranties expressed or implied, including without limitation, the warranty of merchantability or fitness for a particular purpose; that there are no warranties which extend beyond the description of the face hereof; that no oral warranties, representations, or guarantees of any kind have been made by Phymetrix, its distributors or the agents of either of them, that in any way alter the terms of this warranty; that Phymetrix and its distributors shall in no event be liable for any consequential or incidental damages, including but not limited to injury to the person or property of the purchaser or others, and from other losses or expenses incurred by the purchaser arising from the use, operation, storage or maintenance of the product covered by the warranty; that Phymetrix's liability under this warranty is restricted to repair or replacement of defective parts at Phymetrix sole option; and that Phymetrix neither assumes nor authorizes any other person to assume for it any other warranty. The warranty shall be void if serial numbers affixed to the products are removed, obliterated or defaced.

Return Policy / Procedures



If equipment malfunction is suspected or it is determined that the analyzer needs recalibration, please contact Phymetrix.

Communicate the instrument model number, serial number, application including dewpoint range being measured, and the details of the problem.

If the analyzer needs factory service you will be issued a RMA and shipping instructions.

The factory will diagnose the equipment and upon determining the problem will notify you whether the terms of the warranty cover the required repair. If the costs are not covered you will need to approve the estimated cost in order to proceed with the repair.

Table Of Contents

1	Introduction.....	1
2	Important Principles of Operation	2
2.1	Sensor Operating Principle	2
2.2	Sampling Mechanism Operating Principle	2
3	 Precautions 	3
4	Moisture System Considerations	4
4.1	Integrity of the Materials of the User's System	4
4.2	Moisture Back Diffusion (backflow) Along the Walls of the Exhaust Tubing	4
4.3	Temperature Dependant Equilibrium	5
5	Sampling Techniques.....	5
5.1	Choosing a Measurement Site	5
5.2	Sample Conditioning	5
5.3	Tubing and Fittings.....	6
5.4	Sample Pressure	6
5.5	Pressure Considerations	7
6	Installation.....	8
6.1	Mechanical Installation.....	8
6.1.1	PLMa Mechanical Installation.....	8
6.1.2	PLMaEx Mechanical Installation	8
6.1.3	PLMa-Probe-Ex Mechanical Installation	8
6.2	Electrical Connections: Power, 4/20mA Analog Output, Serial I/O	8
6.2.1	Powering the PLMa , PLMaEx or PLMa-Probe-Ex	8
6.2.2	Serial I/O RS-232.....	9
7	Digital Interface - HART	9
8	Troubleshooting and Maintenance.....	11
8.1	Cleaning.....	11
8.2	Self Diagnostics	11
8.3	Suspected Erroneous Measurements.....	11
9	Specifications.....	13
9.1	Model PLMa.....	13
9.2	Model PLMaEx and PLMa-Probe-Ex	13
Appendix A	PLMa Installation Drawing.....	14
Appendix B	PLMaEx Installation Drawing.....	16
Appendix C	PLMa Probe Ex Installation Drawing.....	17
Appendix D	Dewpoint Display	19
Appendix E	Analyzer Calibration Log	23

This page intentionally left blank

1 Introduction

Thank you for purchasing the state-of-the-art Phymetrix Loop-powered Moisture Analyzer model *PLMa* or *PLMaEx* or *PLMa-Probe-Ex*.

These analyzers measure moisture content in gasses in the range -110°Cdp to +20°Cdp and provide a 4-20mA output linear to the measurement units chosen. The factory default is 4mA= -100°Cdp and 20mA= +20°Cdp. Using the HART interface the defaults can be modified in value and units (available units: °C & °F dewpoint, ppmV, ppmW, mB H₂O vapor pressure, grams of H₂O / m³ and Lbs H₂O / 10⁶ standard cubic feet in Natural Gas). The *PLMa* is a Loop-Powered Blind (two wire) Transmitter; thus it has no display and the 4-20mA output is transmitted on the two power pins by consuming power in the range of 4mA to 20mA. In addition the *PLMa* is equipped with a HART interface which superimposes a digital communications signal on the 4-20mA loop.

This User's Manual describes the functions of these analyzers as well as the operating methods and handling precautions. There are also some sections that review general knowledge and concepts of water vapor science. Read this manual thoroughly before using the analyzer. There is a Quick Setup Manual describing the main functions and basic procedures for performing measuring operations. Check our website "www.phymetrix.com" for latest versions of documentation regarding these analyzers.

After reading this manual, keep it easily accessible for future reference. It may come in handy when there are some challenging measurements to be performed.

Conventions used in this manual:

- When using the word "system" in this manual we are referring to the user's system in which the moisture content is being measured. This could be a simple configuration of a pressurized gas bottle with a pressure regulator, or a complex system of dryers, filters, regulators, long tubing/pipes, valves etc.

Check to see that your analyzer has arrived intact with all accessories.



Models: *PLMa* & cable

OR



PLMaEx

OR



PLMa-Probe-Ex

Save the packing materials at least until you have verified that there is no concealed damage, it may also be useful for future transportation.

2 Important Principles of Operation

2.1 Sensor Operating Principle

The nanopore sensor utilized in this analyzer measures the amount of water vapor molecules that have entered its pores. This amount is directly proportional to the partial water vapor pressure in the gas surrounding the sensor, and the partial water vapor pressure is dependant on the water vapor content of the gas and the total pressure of the gas. Thus to compute the water vapor content of the gas under measurement the analyzer has to “know” the total pressure of the gas. Since there is no built-in pressure sensor, the user should enter the total pressure into the analyzer, this can be easily done by entering atmospheric pressure (the analyzer default setting) and measuring at atmospheric pressure by allowing the sample cell outlet (exhaust) port to vent without restrictions.

2.2 Sampling Mechanism Operating Principle

The **PLMa** is intended to be installed in the user’s system or in a sample cell. The PLMa is provided with 3/4”-16 parallel treads with O-ring seal, and with 1/4” Male NPT threads. See Appendix A.

The **PLMaEx** is equipped with a built-in sampling system which has the required tight seals to measure low moisture content; it consists of a stainless steel 100 micron filter and a flow control orifice (which may be placed at either the inlet or outlet of the sampling cell or removed). The gas under measurement is exposed only to the stainless steel walls of the sampling system. See Appendix B.

The **PLMa-Probe-Ex** is the first and only moisture analyzer probe designed to directly insert into a “live” pressurized pipeline, thus avoiding the need to shut down the pipeline when inserting or removing for re-calibration or pipeline service. It has an all stainless steel construction, is small enough to be installed on a 1/2” or larger Ball Valve, seals with 3/8“ Swagelok tube fittings and has sufficient travel for insertion even into the largest diameter pipelines.

The Phymetrix PLMa-Probe-Ex meets the new environmental requirements of not exhausting gas while making a measurement at a lower cost than an extractive sample system.

3 Precautions

- Observe the appropriate electrical safety codes and regulations. Consult with National Electrical Code, and/or other nationally or locally recognized procedures relevant to your location.
- When measuring flammable, explosive or toxic gasses; vent the sample outlet to a safe and appropriate location.
- When measuring high pressure samples (do not exceed 1000 psia); be sure that the system is depressurized before connecting or disconnecting the sample tubing.
- Corrosives such as Ammonia, HCl and Chlorine should be avoided; H₂S and SO₂ can be present if the moisture content is below 10 PPMv.
- Avoid extreme temperatures, pressures and mechanical vibration, refer to specifications.
- Do not disassemble the analyzer.
- Do not use with contaminants and liquids, refer to section 5.2 for sample conditioning.
- Avoid exposing the sensor to ambient air as it may slowdown your next measurement.
- The PLMa and its I/O connector are weatherproof.
- Save the shipping Tube to be used if the PLMa needs to be shipped for recalibration.

4 Moisture System Considerations

This section is offered as background information. There are several considerations in keeping your system at a stable and pure moisture level, free of contamination from ambient air moisture:

- The integrity of the materials isolating the pure gas from the external air, including leaks from poorly secured fittings.
- The back diffusion of moisture through the exhaust outlet, the exhausts of both the analyzer and the user system under measurement should be considered.
- The effects of temperature on the equilibrium of moisture and the surrounding materials, often observed as diurnal cycles in the measurement.

4.1 Integrity of the Materials of the User's System

Before considering the materials of a system where a specified dewpoint level must be maintained, one should review two concepts.

- Compared to the structure of solids the water molecule is much smaller. This is true compared to even the crystalline structure of metals but especially important in the polymer structure of plastics.
- Water vapor pressure in gasses obeys Dalton's law of partial pressures, which states that the overall pressure of a gas is the sum of its constituent gases. And each gas seeks to equilibrate its pressure across gradients of only its own gas pressure.

Let's consider air in a pipe at a total pressure of 100 psia, which has been dried down to -40°C dewpoint. The partial water vapor pressure in the pipe is 0.13mB. If the ambient temperature is 22°C with relative humidity of 30%, then the partial water vapor pressure in the surrounding atmosphere is 7.9mB or approximately 60 times greater than the partial water vapor pressure in the pipe. Thus even though the total pressure in the pipe is much greater than the pressure outside, the reverse is true for the water vapor pressure, and as we discussed earlier the water vapor seeks to equilibrate its pressure thus it "wants" to flow from the outside to the inside and will do so through the cracks in the joints (such as poorly tightened fittings, or NPT threads even if they are properly taped), as well as through the walls of pipes tubes and other vessels. The integrity of the system is extremely important in maintaining a stable low dewpoint; for dewpoints below -60°C always use stainless steel or PTFE, while for higher dewpoints you can use copper or galvanized steel; but never use rubber, Tygon, Nylon or other plastic tubing. Pressure regulators often use rubber diaphragms, check and if necessary replace with a stainless steel diaphragm regulator. Filter bowls should be stainless steel or glass, plastic bowls should be avoided. If a flow meter is placed at the inlet of the analyzer it should have a glass tube and be rated for the expected pressure levels, however in general it is best to place flow meters at the analyzer exhaust. Another material consideration relates to materials sealed in the system such as paper filters; these may not contribute to leaks but will greatly slow down the measurement because they will adsorb and desorb water molecules as the system dewpoint is changing.

4.2 Moisture Back Diffusion (backflow) Along the Walls of the Exhaust Tubing

The linear velocity of gas flowing in a tube is close to zero immediately along the wall of the tube. This coupled with the previously discussed "need" for the moisture to flow from the higher water vapor pressure to the lower one, allows for water molecules to flow against the flow through the exhaust outlet into the sampling chamber of the analyzer. The fact that water

molecules are highly polar further enhances their ability to migrate against the gas flow at the sampling chamber outlet. To prevent this backflow of moisture from influencing the measurement, the analyzer should have at least 12" in length of 1/8" dia. stainless steel tubing at its exhaust port, and a minimum flow of 2 SCFH (1 SLPM) should be maintained; higher flows will produce faster equilibrium time and thus are desirable for quick measuring. A small pigtail (coiled 1/8" dia. ss. tubing 12" long) can be connected to the exhaust port of the analyzer. Alternatively a short tube with attached flow meter can also provide protection from back diffusion of moisture.

4.3 Temperature Dependant Equilibrium

The effect of ambient temperature on the gas partial water vapor pressure of a system can change the moisture content of the gas. This is not the temperature sensitivity of the measuring analyzer, rather the actual change of partial water vapor pressure in the user's system due to increase in ambient temperature and thus the increase of energy of the water molecules on and in the walls of the system (tubing, vessels etc...). A typical example would be the observation of a daily cycling of the measurement in a system with tubing or other components exposed to direct sunlight. During the day as the sun transfers energy into the system, the dewpoint will appear to increase, while at night the dewpoint will appear to decrease. There may be other reasons for this daily dewpoint cycling such as the effect of sun/temperature on the efficiency of gas dryers etc. It is possible to minimize this effect using sun shields and tubing insulators. Alternatively one may study the response of the particular system to ambient temperature, by logging data over several days during different seasons, and compensating the measurements for this effect. The temperature effect will vary greatly depending on the size and materials of the system, for example stainless steel walls will have a much smaller effect than brass or copper walls.

5 Sampling Techniques

The amount of moisture measured will be influenced by the system moisture content as well as leaks in the system and transient effects of adsorption / desorption from materials in the system (as described in the previous sections).

5.1 Choosing a Measurement Site

The PLMa has been designed to perform extractive or in-situ measurements. The PLMaEx is designed for extractive measurements only. The PLMa-Probe-Ex is designed mainly for in-situ measurements. It is important to choose an appropriate sampling location that is representative of the moisture content of the system of interest. If you feel you need assistance, please call our application engineers.

5.2 Sample Conditioning

Particulate and liquid contaminants can effect the measurement, especially the response time. Sample conditioning may be necessary to remove contaminants and improve the measurement and the longevity of the sensor. Make sure that sample conditioning components are made of suitable materials. Avoid paper or other fiber filter elements, use stainless steel instead. For expected dewpoints below -50°Cdp (39 PPMv), avoid plastic filter bowls, use stainless steel or glass instead. Drain trapped liquids from filter bowls.

If the application is suspect of possible presence of liquids for example:

- Compressed air with possible oil and/or water,
- Gas Insulated Switchgear or Transformer, SF₆ or N₂ blanket with suspected oil carryover,
- Natural Gas with possible Triethylene Glycol carryover,

Consult with Phymetrix for specialized sampling systems.

5.3 Tubing and Fittings

Make sure all tubing is constructed of materials suitable for low dewpoint measurement, i.e. stainless steel or Teflon, do not use rubber or plastic tubing (refer to section 4.1 for more details).

Check for leaks after connecting.

Flow meters can be a source of moisture ingress especially if they have a plastic flow tube; ensure flow meters are connected at the analyzer exhaust, not at inlet. However metering valves should be at the inlet in order to maintain constant atmospheric pressure in the sampling chamber.

5.4 Sample Pressure

Pressure variations will effect the measurement. Higher pressure is more likely to produce condensation and thus erroneous readings or even damage the sensor. If the sample pressure needs to be reduced use a suitable pressure dropping device such as a stainless steel needle valve or pressure regulator with a stainless steel diaphragm or a flow control orifice. Make sure Joule-Thomson effects do not cool the gas below hydrocarbon and water dewpoints.

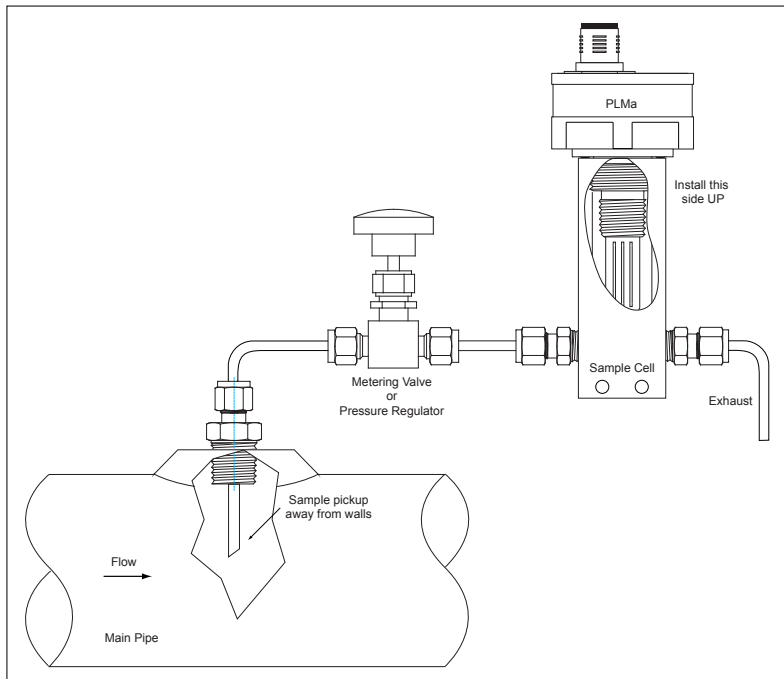

5.5 Pressure Considerations

When sampling gases from sources above 50 psia the user needs to exercise some caution.

The model **PLMaEx** has a built-in orifice. This orifice can be used to regulate the flow from various pressures.

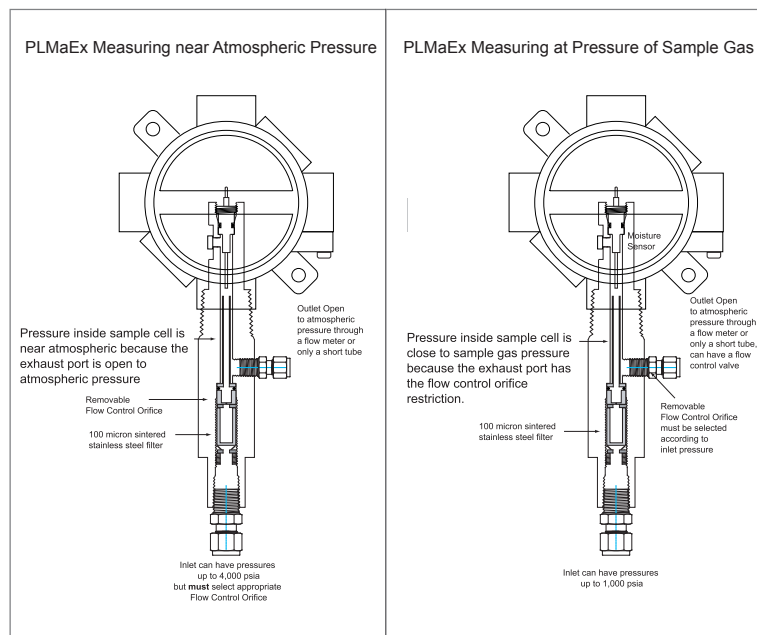

The inlet orifice eliminates the need for any pressure regulators while maintaining sufficient but not excessive flows throughout the pressure rating of the analyzer. For example 0.004” to 0.016” dia. orifices, produces flows described in the following table.

source pressure psia - (Bar)	flow SLPM 0.016” orifice	flow SLPM 0.012” orifice)	flow SLPM 0.008” orifice	flow SLPM 0.006” orifice	flow SLPM 0.004” orifice
15 - (1.03)	0.7	0.4	0.17	0.08	0.04
25 - (1.72)	2	1.3	0.6	0.3	0.1
35 - (2.4)	3	1.9	0.8	0.5	0.2
55 - (3.8)	4.8	3.0	1.4	0.7	0.3
75 - (5.2)	6.6	4.1	1.9	1.0	0.4
100 - (6.9)	8.9	5.5	2.6	1.4	0.6
150 - (10.3)	13.4	8.3	3.8	2.1	0.9
200 - (13.8)	17.9	11.0	5.1	2.7	1.1
300 - (20.7)	26.8	16.6	7.7	4.1	1.7
400 - (27.6)	35.7	22.1	10.3	5.5	2.3
500 - (34.5)	44.7	27.6	12.8	6.9	2.9
600 - (41.4)	53.6	33.1	15.4	8.2	3.4
700 - (48.3)	62.5	38.7	18.0	9.6	4.0
800 - (55.1)	71.5	44.2	20.5	11.0	4.6
900 - (62)	80.4	49.7	23.1	12.4	5.1
1000 - (68.9)	89.3	55.2	25.7	13.7	5.7
1500 - (103.4)	134.0	82.8	38.5	20.6	8.6
2000 - (137.9)	178.7	110.5	51.3	27.5	11.4

The grayed boxes are preferred operating points. Other orifices can be provided to accommodate different pressures and flows. Consult PhyMetrix support for its proper sizing.

Measuring with the PLMaEx, Near Atmospheric Pressure

It is recommended for most applications to perform the measurement at near atmospheric pressure. Placing the flow control orifice at the inlet and allowing the outlet to be unrestricted (other than the exhaust pigtail and flow meter), assures that the analyzer has sufficient but not excessive flow and the pressure inside the sampling chamber is near atmospheric. This approach guarantees safe conditions and eliminates the need for the optional pressure sensor. If there is no pressure sensor the analyzer can be set with atmospheric pressure 14.7psia for the Measuring setting of the pressure correction (refer to section factory default setting, the orifice and unrestricted outlet will guarantee repeatable conditions for all pressures within the rating of the orifice.

Measuring with the PLMaEx, at Pressure of Sample

If it is desired to perform the measurement at the same pressure as the sample, up to the rating of the analyzer (1000 psia standard), then place the orifice at the outlet.

When the analyzer is setup with the orifice at the outlet, the measuring chamber will be pressurized to the same pressure as your sample. To perform accurate measurements, you must know the pressure and enter it into the analyzer.

6 Installation

6.1 Mechanical Installation

6.1.1 PLMa Mechanical Installation

The PLMa can be mounted directly on a sample cell or any vessel equipped with 3/4"-16 parallel threads port or 1/4 NPT pipe threads. Refer to Appendix A PLMa Installation Drawing.

6.1.2 PLMaEx Mechanical Installation

The PLMaEx can be mounted directly on the pipe or can be mounted on a panel surface and connected with tubing. Refer to Appendix B PLMaEx Installation Drawing.

Connections for inlet and outlet of the gas being measured are made through a variety of available options e.g. 1/8" or 1/4" Swagelok® tubing compression fittings.

Refer to Mechanical Installation Drawing Appendix B.

6.1.3 PLMa-Probe-Ex Mechanical Installation

The PLMa-Probe-Ex is intended to be installed directly on the pipeline through a 1/2" or larger ball valve. Refer to Mechanical Installation Drawing and pictorial Installation Instructions in Appendix C.

6.2 Electrical Connections: Power, 4/20mA Analog Output, Serial I/O

6.2.1 Powering the PLMa , PLMaEx or PLMa-Probe-Ex

The PLMa, PLMaEx and PLMa-Probe-Ex are 4/20mA loop powered analyzers with a HART digital interface. The analyzer will operate from 5 VDC to 28VDC power and will draw 4mA to

20mA depending on the measurement and the analog output settings (factory default 4mA=-100°C and 20mA=+20°C).

Refer to the **PLMa Electrical Connection** diagram in Appendix A, for specific wiring connections.

The PLMa is equipped with a male M12 connector, which mates to all standard M12 connectors. The PLMa is supplied with a 3 meter cable with a molded right angle connector. The M12 connector on the PLMa and on the cable are weatherproof.

The PLMaEx and PLMa-Probe-Ex have a explosion proof junction box with pluggable screw terminal connector. Conduit can be connected to the junction boxes 3/4" NPT port.

6.2.2 Serial I/O RS-232

The PLMa can provide a RS-232 interface. Refer to the **PLMa Electrical Connection** diagram in Appendix A for connections.

7 Digital Interface - HART

The PLMa is equipped with a HART interface which overlays digital signals on the 4-20mA loop current. Thus the PLMa can be used in any 4-20mA loop and can simultaneously communicate digitally on the same two wires.

The PLMa responds to all of the HART Universal (Common Practice) Commands as well as some important setup and configuration commands.

HART Commands Implemented in the PLMa, PLMaEx and PLMa-Probe-Ex

HART Command		Description	
#	Name		
0	Read Unique Identifier	Read Device identification such as address, manufacturer, revision level etc.	
1	Read Primary Variable	Read the measurement of the Primary Variable (P.V.)	
2	Read Current and % of range	Read the current that is produced by the Primary Variable and the percent of range it represents. These depend on the command #51 measurement assigned to the P.V., the value of that measurement and the assignments of command #35.	
3	Read Dynamic Variables and P.V. current	Read the measurements of up to 4 measurement variables as assigned by command # 51.	
6	Write Polling Address	Assign a polling address to a device. An address (1-15) puts the device in fixed 4mA mode for multidrop connectivity. Address 0 puts the device in 4/20mA mode.	
11	Read Unique Identifier Associated with Tag	Find device that has the desired textual Tag assigned by command # 18.	
12	Read Message	Read information written by command # 17.	
13	Read Tag, Descriptor and Date	Read information written by command # 18.	
14	Read P.V. Sensor Information	Information on primary sensor Serial Number, range etc.	
15	Read P.V. Output Setup	Analog output range, alarms etc.	
16	Read Final Assembly Number	Read number written by command # 19.	
17	Write Message	For use by owner/operator to identify the device and its use.	
18	Write Tag, Descriptor and Date	For use by owner/operator to identify the device and its use. Can search for the Tag, with command # 11, on multidrop connections.	
19	Write Final Assembly Number	For use by owner/operator to identify the device and its use.	
35	Write Primary Variable Range Values	Setup the measurement units and values that correspond to 4mA and 20mA output of the loop.	
40	Analog Out Fixed	Forces the Analog Output DAC to a specified value.	
44	Write Primary Variable Units	Select the units of measure for the Primary Variable.	
45	Trim DAC Zero	Trims the DAC Zero by difference of Cmnd. #40 and observed value.	
46	Trim DAC Gain	Trims the DAC Gain by ratio of Cmnd. #40 and observed value.	
50	Read Dynamic Variable Assignments	Read the assignments of command # 51.	Measurement Variables and [available units]: 00 – Moisture Measurement °C & °F dewpoint, ppmV, mB H ₂ O vapor pressure, grams of H ₂ O / m ³ and Lbs H ₂ O /10 ⁶ standard cubic feet in Natural Gas 01 – Temperature of Gas [°C, °F] 02 – Temperature of Board [°C, °F] 03 – Pressure [psi, bar, mbar, kg/sqcm, pascal ...] 08 – Loop Voltage [mV] 09 – Status Bits
51	Write Dynamic Variable Assignments	Assign Measurement Variables to each of the four primary variables reported by the analyzer by command # 3.	
53	Write Transmitter Variable Units	Select Units of measure for each of the Variables.	
108	Write Burst Command Number	Select command number to burst.	
109	Burst Mode Control	Enable/Disable burst (continuous) transmissions.	

A free of charge program may be downloaded from our website www.phymetrix.com/hart.htm that allows communicating with the PLMa or PLMaEx or PLMa-Probe-Ex HART interface.

8 Troubleshooting and Maintenance

This analyzer is designed to be maintenance and trouble free. However should problems occur due to process conditions or other factors, use this chapter for troubleshooting purposes. If the encountered circumstances are not discussed in this manual please contact Phymetrix. Spare parts may be ordered through Phymetrix.

8.1 Cleaning

The analyzer enclosure may be cleaned using a moist cloth.

The flow control orifice of the PLMaEx can be removed and cleaned with solvents.

The sensor is not user serviceable and should not be cleaned by the user. If it is contaminated please acquire an RMA and send the analyzer for repair.

8.2 Self Diagnostics

The analyzer constantly performs self diagnostics to determine if all parts are operating properly. The results of the diagnostics are communicated based on the alarm selection settings of HART command #15. The factory default is that a fault will cause the current to go to its high value (20mA).

8.3 Suspected Erroneous Measurements

Some of the most common suspected erroneous conditions are listed in the following table included are common reasons and suggested remedies.

If the measurement is suspected to be erroneous, before calling for support, it may be helpful to have the following information:

- Type of gas being measured.
- Expected dewpoint.
- Nominal pressure (consider back pressure).
- Nominal temperature.
- Nominal flow rate through the analyzer.
- Flow diagram or description of system, showing items and their materials of construction. Include materials of filter elements, regulator diaphragms, and valve seats.
- Possible contaminants (particulates, liquids, oil, glycol, cleaning solutions, etc.).
- Are the pipes and analyzer purged before measuring? How long? Flow rate? With the same gas that will be measured?
- If other equipment was used to verify the dewpoint, what is the equipment (include model number)? What is its specified measuring range? When was it last calibrated/certified?
- If using bottled gas for reference: Manufacturer? Content and accuracy markings? What is the pressure in the bottle at time of comparison? What is the ambient temperature where the bottle is stored? What are the materials of construction of the pressure regulator, especially the diaphragm?

Table 2 Guide to Troubleshooting Measurements

Problem or Unexpected Observation Behavior	Likely Source of Problem	Analysis	Remedy
Measurement is drier than is expected.	Equilibrium	Before concluding that there is an incorrect measurement, make sure that the system is at equilibrium.	Graph the measurements and wait for equilibrium.
	Sampling point	Consider if the sampling point could be drier than the rest of the system.	If necessary find a more appropriate sample point
	Damage Corrosion, abrasion	Contaminants can damage the sensor.	Refer to sections: 3 Precautions and 5.2 Sample conditioning.
	Needs recalibration	Depending on the application recalibration may be yearly or in 5 years.	Consult with factory.
Measurement is wetter than is expected.	Equilibrium	Before concluding that there is an incorrect measurement, make sure that the system is at equilibrium.	Graph the measurements and wait for equilibrium.
	Sampling point	Consider if the sampling point could be wetter than the rest of the system.	If necessary find a more appropriate sample point
	Condensation	Refer to the “Measurement is not changing ” observation below	
	Damage Corrosion, abrasion	Contaminants can damage the sensor.	Refer to sections: 3 Precautions and 5.2 Sample conditioning.
	Incompatible materials in system with low dewpoint.	Refer to section 4.1 Integrity of the materials of the system.	Replace inappropriate materials.
	Leaks	Check for leaks around all interconnections.	Tighten fittings. Repair the leaks.
	Needs recalibration	Depending on the application recalibration may be yearly or in 5 years.	Consult with factory.
Measurement is changing slower than expected.	Equilibrium	The rate at which the system will reach equilibrium depends on the system particulars, such as ambient temperature, internal pressure, flow rates, system materials of construction, surface area of system internals.	Previous experience may be indicative of the system response time. It is common for systems to take hours to equilibrate.
	Sampling point	Is the sampling point in the direct flow of the system gas, or is it at a dead end of the distribution system?	Sample in the direct flow.
	Contamination	Are there hygroscopic contaminants?	Clean the sensor and install filters.
	Out-gassing	Are there materials in the system that could be out-gassing?	Replace the hygroscopic materials.
	Leaks	Check for leaks around all interconnections.	Tighten fittings. Repair the leaks.
	Large diameter sampling tubing	Larger diameter tubing have larger surfaces.	Use smallest practical tubing diameter, 1/8” recommended
	Low flow rate	Response time is normally greatly influenced by flow rate, but if the measurement value is influenced by flow rate there may be a leak.	Flow rate should be greater than 1 LPM.
Measurement is not changing , always shows a dewpoint close to ambient temperature.	Condensation	Condensation may have occurred from a slug of water or from previous conditions where the gas dewpoint was greater than the ambient temperature. Condensation typically accumulates in filter bowls or other low points in the system. Then evaporates and produces a high dewpoint.	Drain the condensate and allow the system to dry down.
Measurement has a daily cycle	Thermally induced water vapor pressure change.	Refer to section 4.3 Temperature dependant equilibrium	

9 Specifications

9.1 Model PLMa

Temperature Range	PLMa Analyzer: -20°C to +60°C Electronics: -40°C to +85°C Moisture Sensor: -20°C to +60°C
Moisture Sensor	Range -110°C to +20°C Accuracy: ±2°C temperature corrected Repeatability: 0.8°C Response time: 95% of step change in 3 min. Sample flow: >1 LPM
Temperature Sensor	-40°C to +70°C ±2°C
Electrical	4/20mA Loop Powered 5-28VDC with HART® additional TTL level outputs for either HART or Alarm indications
Mechanical	3/4"-16 parallel threads and 1/4" Male NPT threads All 316 Stainless Steel wetted parts, for fast response time. Enclosure Stainless Steel, IP66 & IP68 Dimensions SS enclosure- L: 2.77" (70mm) D: 1.625" (41mm) Weight Total: 6 oz. (0.17 Kg) Pressure: 5000 PSIA (345 Bar)
Miscellaneous Features	NIST traceable calibrations Units of measure: °C & °F dewpoint, ppmV, ppmW, mB H ₂ O vapor pressure, grams of H ₂ O / m ³ and Lbs H ₂ O /10 ⁶ standard cubic feet in Natural Gas

9.2 Model PLMaEx and PLMa-Probe-Ex

Temperature Range	PLMaEx Analyzer: -20°C to +60°C Electronics: -40°C to +85°C Moisture Sensor: -20°C to +60°C		
Moisture Sensor	Range -110°C to +20°C Accuracy: ±2°C temperature corrected Repeatability: 0.8°C Response time: 95% of step change in 3 min. Sample flow: >1 LPM		
Temperature Sensor	-40°C to +70°C ±2°C		
Electrical	4/20mA Loop Powered 5-28VDC with HART® additional TTL level outputs for either HART or Alarm indications		
Mechanical	<table border="1" style="width: 100%; border-collapse: collapse;"> <tr> <td style="width: 50%; vertical-align: top;"> PLMaEx 3/4" OD tube and 1/4" NPTF Inlet, 1/8" NPTF Outlet Flow Control Orifice can be placed at Inlet or Outlet; Built in serviceable/cleanable 100 micron Filter Pressure: 5000 PSIA (345 Bar) </td> <td style="width: 50%; vertical-align: top;"> PLMa-Probe-Ex 1/2"NPT male connection to pipeline valve. 3/8" Swagelok compression seal Pressure: 1000 PSIA (68 Bar) </td> </tr> </table> All 316 Stainless Steel wetted parts, Enclosure Stainless Steel, IP66 & IP68 FM/CSA Explosion Proof Certified Class I, Div I, Groups B, C And D Class II, III, Div 1, Groups E, F And G ATEX Explosion Proof Certified ATEX 2 GD, Exd I & IIC; IECEx, Exd I & IIC Dimensions SS enclosure- L: 8.375" (213mm) W: 4.250" (108mm) H: 2.625" (67mm) Weight Total: 4 Lbs (1.8 Kg)	PLMaEx 3/4" OD tube and 1/4" NPTF Inlet, 1/8" NPTF Outlet Flow Control Orifice can be placed at Inlet or Outlet; Built in serviceable/cleanable 100 micron Filter Pressure: 5000 PSIA (345 Bar)	PLMa-Probe-Ex 1/2"NPT male connection to pipeline valve. 3/8" Swagelok compression seal Pressure: 1000 PSIA (68 Bar)
PLMaEx 3/4" OD tube and 1/4" NPTF Inlet, 1/8" NPTF Outlet Flow Control Orifice can be placed at Inlet or Outlet; Built in serviceable/cleanable 100 micron Filter Pressure: 5000 PSIA (345 Bar)	PLMa-Probe-Ex 1/2"NPT male connection to pipeline valve. 3/8" Swagelok compression seal Pressure: 1000 PSIA (68 Bar)		
Miscellaneous Features	NIST traceable calibrations Units of measure: °C & °F dewpoint, ppmV, ppmW, mB H ₂ O vapor pressure, grams of H ₂ O / m ³ and Lbs H ₂ O /10 ⁶ standard cubic feet in Natural Gas		

Appendix A PLMa Installation Drawing

Note: Sample Cell, Manifold or other Mating Surface used with the 3/4-16 threads must have a sealing surface orthogonal to threads with a minimum of 1" dia. spot-face, free of radial nicks and scratches. Maximum thread countersink diameter of 0.750" to assure proper seating.

Measurement Calculations:
 The PLMa communicates the measured dewpoint to the user by drawing (using) between 4 and 20 mA of power. The user measures this current with a sensing resistor. Typically the sensing resistor R_s is 250 Ω , 200 Ω or 100 Ω . Use a precision resistor (1% or better) with a power rating of at least 1/4 Watt.

$$PLMa \text{ Measured Value} = L + \left(\left(\frac{V_{\text{sense}} \times 1000}{R_{\text{sense}}} \right) - 4 \right) \times (H - L)$$

Where:
 H = PV output Upper Range as set by HART command #35, read by #15 (factory default +20°C)
 L = PV output Lower Range as set by HART command #35, read by #15 (factory default -100°C)
The Measured Value is calculated in the same units as the HART settings for H and L.

Limitations:
 V_{analyzer} the Voltage across Analyzer (V_a), min 5 VDC max 28 VDC.
 Power rating of sensing resistor $P_r = I^2 \times R$; $I_{\text{max}} = 24\text{mA}$ for a single device
 Assuming $R_{\text{sense}} = 250 \Omega$. Then $P_r = 0.024 \times 0.024 \times 250 = 0.144\text{W}$
 thus should use a minimum 1/4 Watt rated resistor
 Since the voltage drop across the sense resistor can be $24\text{mA} \times 250 \Omega = 6\text{V}$ then in order to assure that V_a is not less than 5V, the power supply should be no less than 11V. One should also consider the total resistance of the cable when computing the voltage drops for the power supply requirement.

Top View

0.195" dia. cable

Top View with Molded Cable Connector Installed

Molded connector can be installed only in this direction. Screw terminal connectors can be oriented as needed.

signal and wire colors for molded cable:
 1 - brown LOOP +
 2 - white Tx out (TTL)
 3 - blue LOOP -
 4 - black Rx in (TTL)
 5 - green/yellow ground to housing, isolated from other 4 pins

PhyMetrix®

Unless otherwise specified dimensions are in inches
 x +/- 0.020"
 .xx +/- 0.010"
 .xxx +/- 0.005"

Title: PLMa Installation Drawing

Drawn by: BB

Date: 9/13/10

Scale: 1:1

Page: 1 of 1

Part Number:

Rev: 0

PLMa Installation Drawing

PLMa Installation Drawing

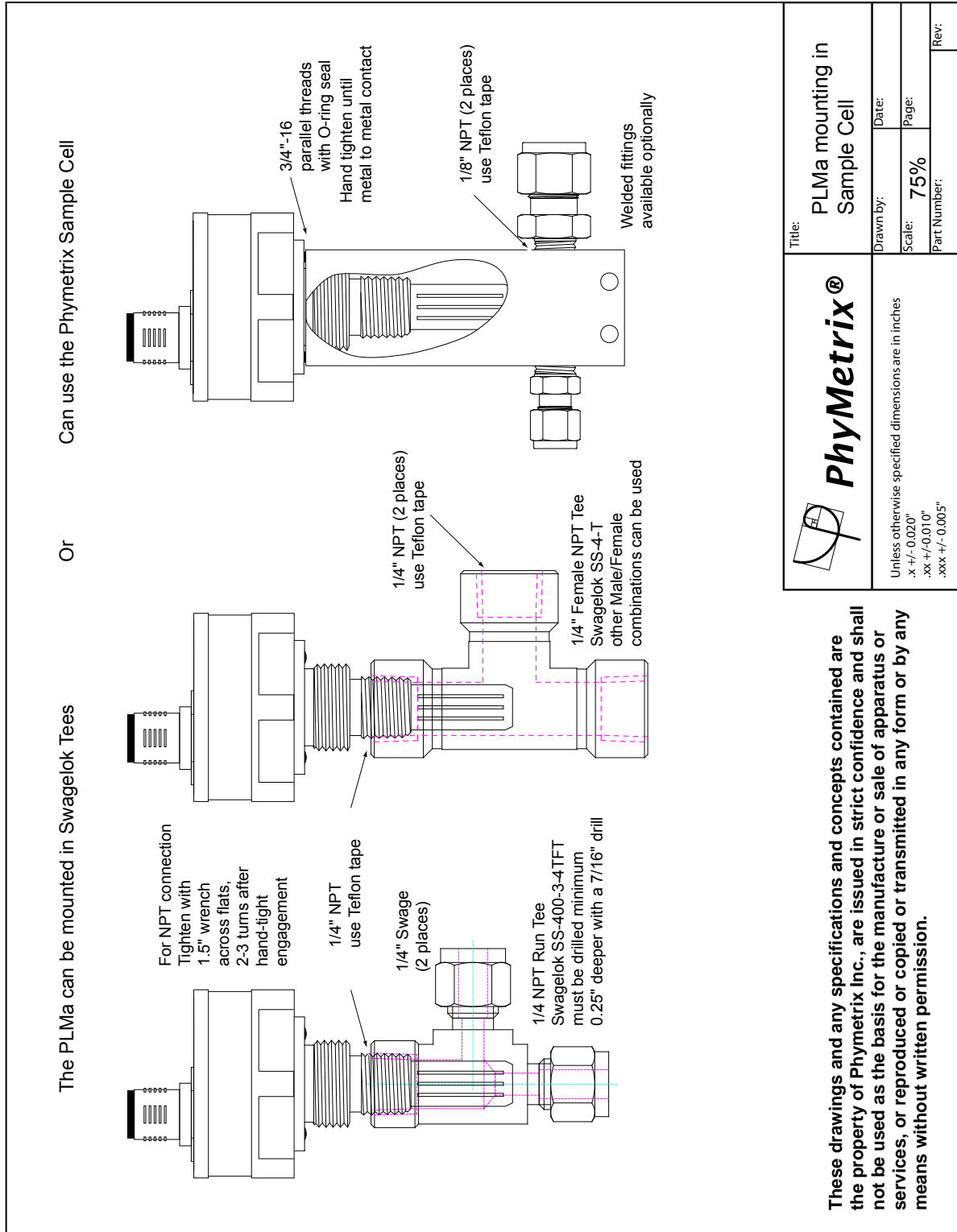

Appendix C PLMa Probe Ex Installation Drawing

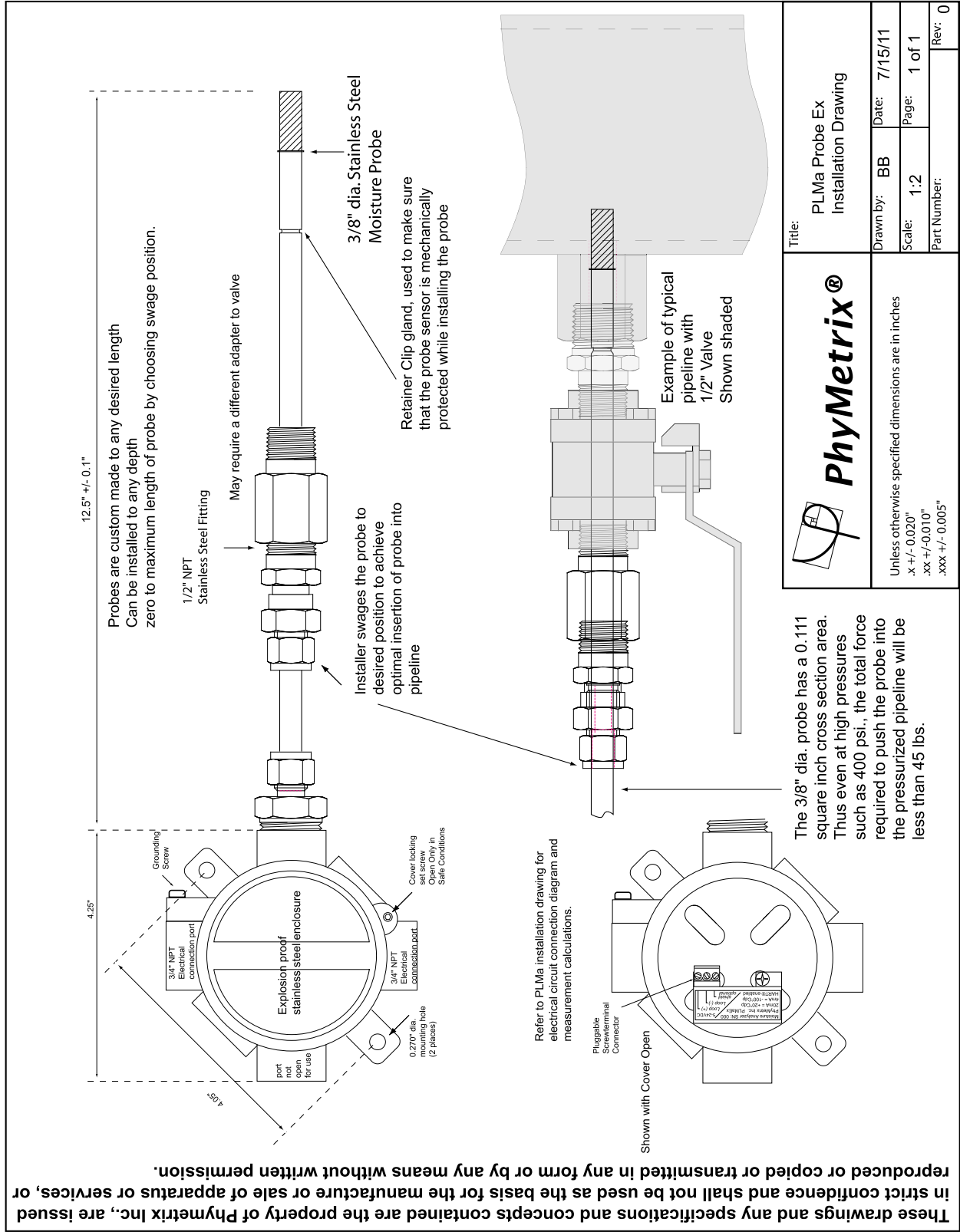

PhyMetrix PLMa-Ex Pipeline Probe Installation Instructions

Do not attempt to close valve while probe is inserted through valve. Both probe and valve can be damaged.

Valve can be closed only when probe is extracted and retaining clip is inserted into groove.

Fittings under probe housing have clear heat-shrink tubing over them. Do not remove this tubing, do not loosen these fittings

- Initially the pipeline valve is closed.
- Initially the probe retainer clip is inserted. This clip makes sure that the probe sensor is mechanically protected while installing the probe.
- Tape the probe NPT fitting, align to valve and tighten. Use adapters as necessary.
- Once the NPT fitting is properly tightened, open the pipeline valve. If the pipeline is pressurized some gas will begin to leak between the probe shaft and the Swagelok fitting.
- While supporting probe housing (so it does not drop) pull out retainer clip.
- Slowly lower the probe through the valve into the pipeline. Do not drop. The probe has a cross section of about 0.11 square inches thus will be pushed up with a force of 11% of the pipeline pressure. Therefore it may be necessary to slightly push the probe into the pipeline.
- Lower the probe until the 3/8"-tube Swagelok nut reaches fitting.
- Tighten the 3/8"-tube Swagelok nut, the gas leak will stop.
- Store the retainer clip between the Swagelok nuts.
- Open explosion proof housing cover. Connect 4/20mA loop wires to pluggable terminals marked +, - and earth ground. Observe label near the connection points for the 4/20mA units of measure and range setting.

At this point the sensor will reach into the appropriate measuring position in the pipeline.

Appendix D

Dewpoint Display

PhyMetrix Dewpoint Display 4 User Interface

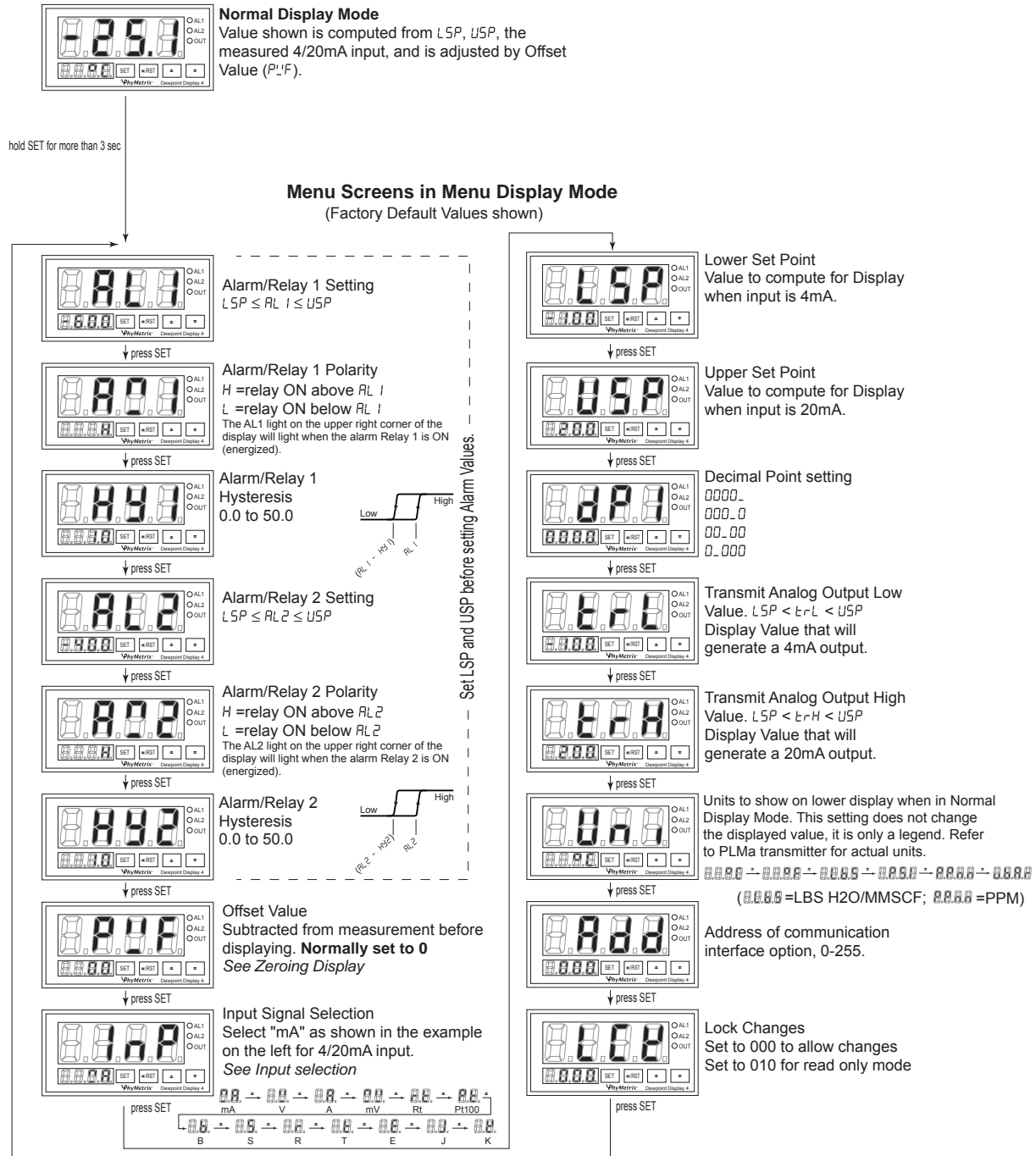

- When in any of the 16 Menu Screens "AL1" to "LCK":
- Press "SET" to store the selection and move to the next menu screen.
 - Press "<</RST" to select one of the digits on the lower display for change and then use the "▲" or "▼" buttons to make the change, press "<</RST" again to select a different digit.
 - If no buttons are pressed for 25 seconds the display will revert to Normal Display Mode.

- Troubleshooting and diagnostic messages**
- The upper screen will show "UUUU", if the input is more than 110% of USP-LSP range.
 - The upper and lower screen sections will flash "B.B.B.B.", if the display temperature range is exceeded.

Dewpoint Display 4 Rear View

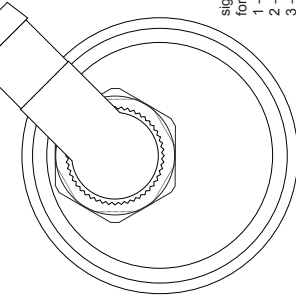
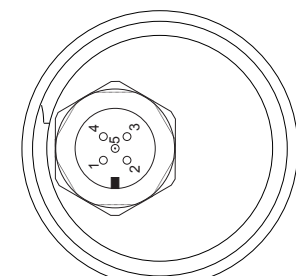
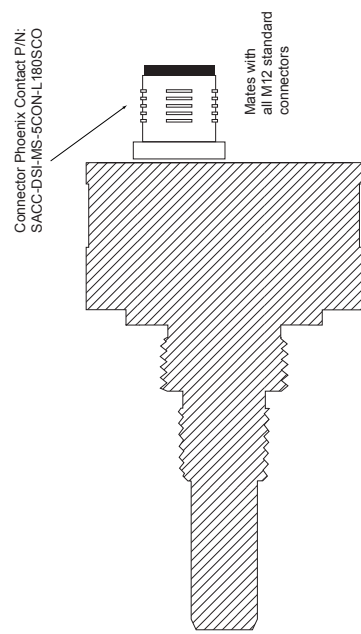
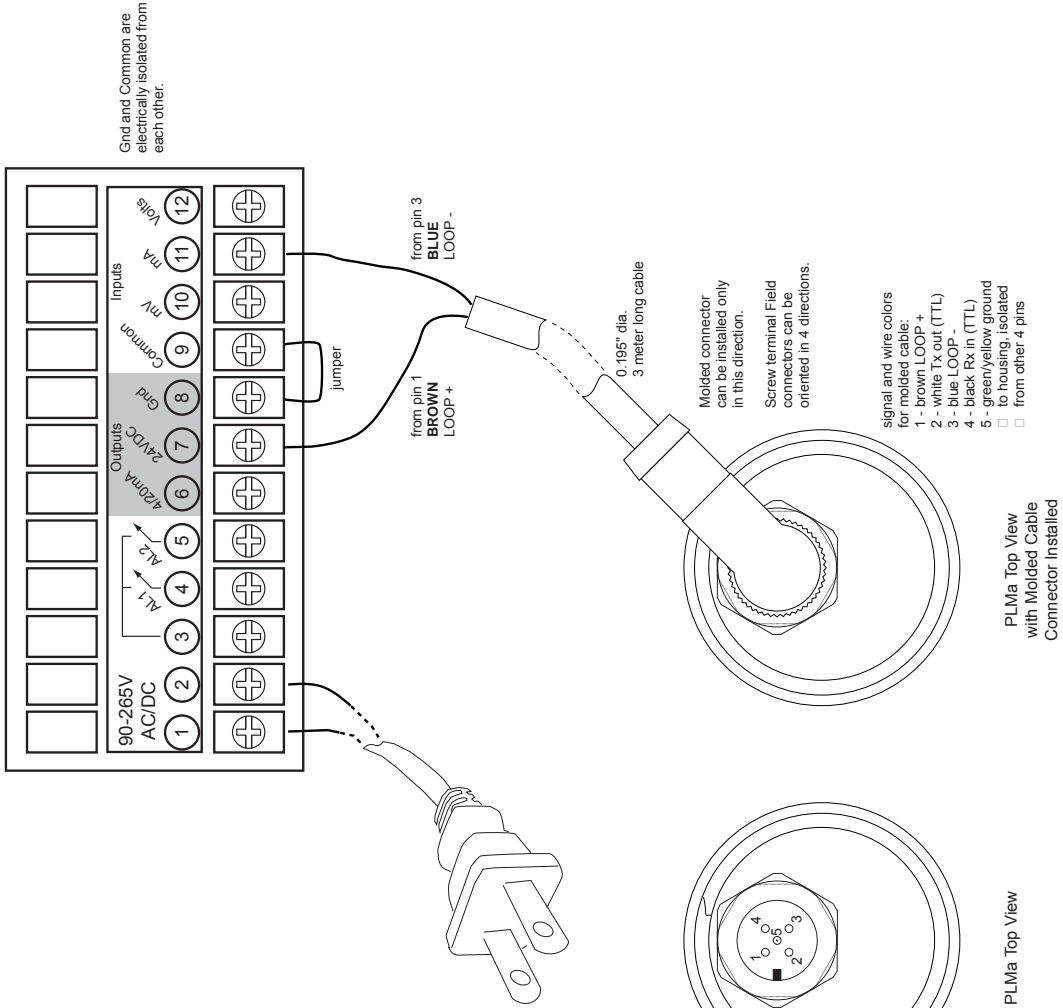
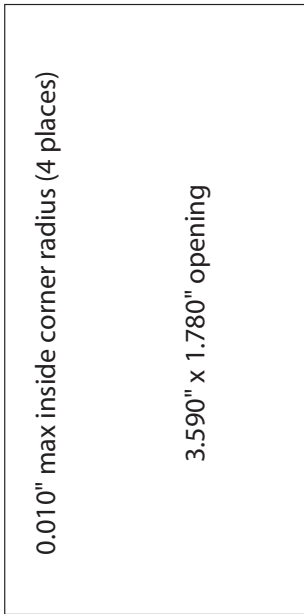

Moulded connector can be installed only in this direction.

Screw terminal Field connectors can be oriented in 4 directions.

signal and wire colors for moulded cable:

- 1 - brown LOOP +
- 2 - white Tx out (TTL)
- 3 - blue LOOP -
- 4 - black Rx in (TTL)
- 5 - green/yellow ground

□ to housing, isolated

□ from other 4 pins

0.195" dia.
3 meter long cable

PhyMetrix Dewpoint Display 5 User Interface

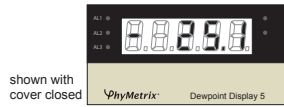

Normal Display Mode
Value shown is computed from LSP , USP , the measured 4/20mA input, and is adjusted by Offset Value ($P5$) & Gain Value (ϵ).

shown with cover closed

hold SET for more than 3 sec

Menu Screens in Menu Display Mode

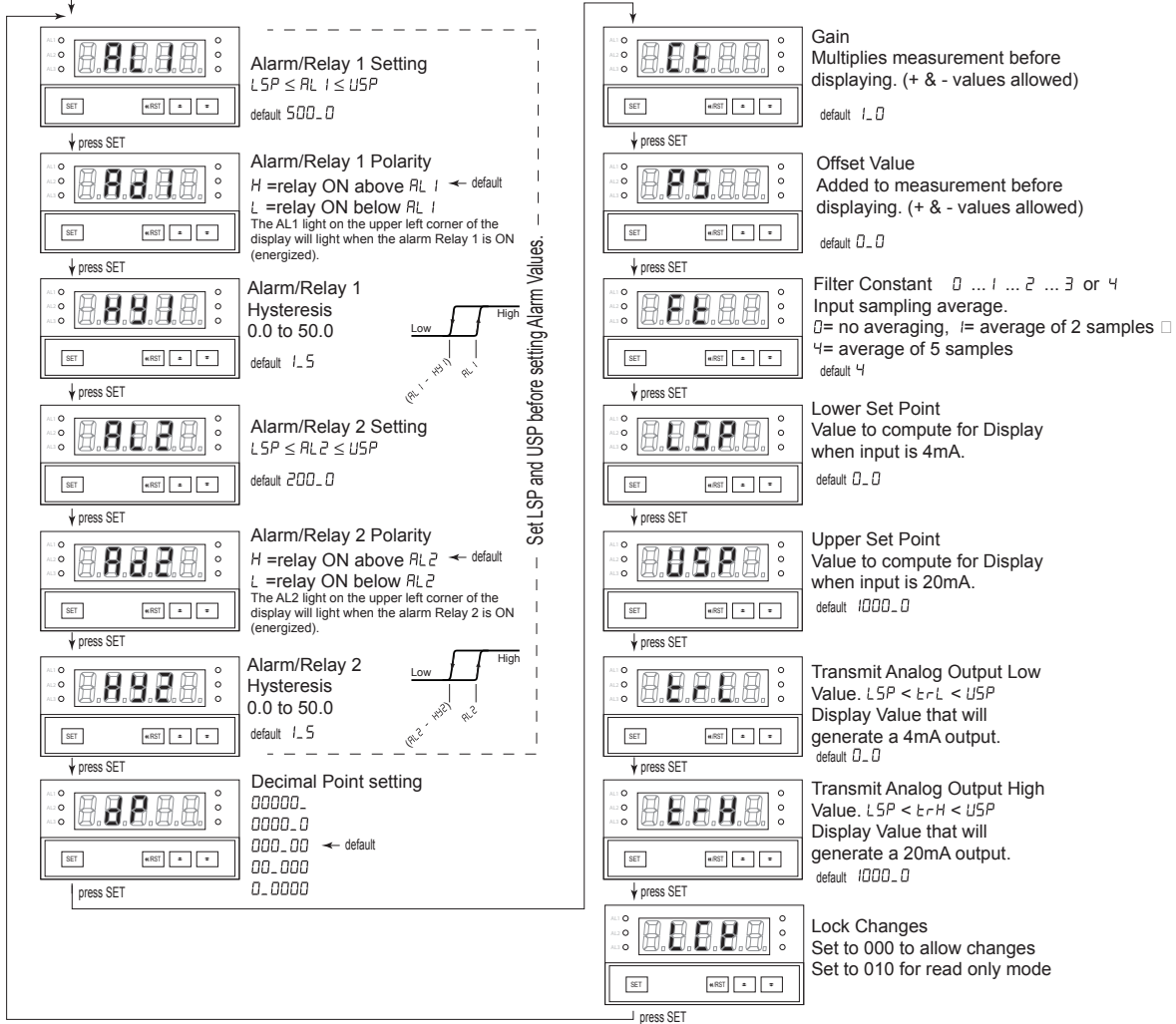

When in any of the 15 Menu Screens "AL 1" to "LCK":

- Press "SET" to store the selection and move to the next menu screen.
- Press "<</RST" to select one of the digits of the setting (value) for change and then use the "▲" or "▼" buttons to make the change, press "<</RST" again to select a different digit.
- If no buttons are pressed for 25 seconds the display will revert to Normal Display Mode.

Troubleshooting and diagnostic messages

- The value computed for display will not increase beyond 115% of the $USP - LSP$ range, even if the current exceeds 22.4mA
- The screen will flash "8.8.8.8.", if the display temperature range is exceeded.

Dewpoint Display 5 Rear View

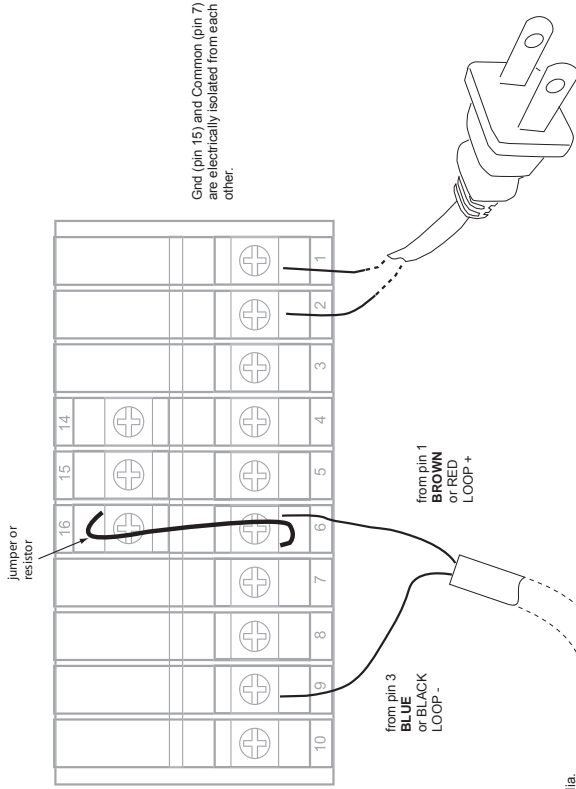

0.010" max inside corner radius (4 places)
 3.590" x 1.780" opening

0.195" dia.
 3 meter long cable

PLMa Top View
 with Molded Cable
 Connector Installed

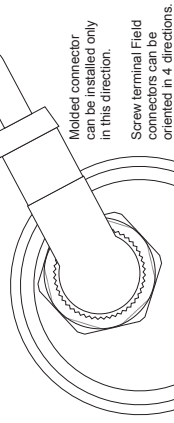

Molded connector
 can be installed only
 in this direction.
 Screw terminal Field
 connectors can be
 oriented in 4 directions.

- signal and wire colors
 for molded cable:
- 1 - brown LOOP +
 - 2 - white Tx out (TTL)
 - 3 - blue LOOP -
 - 4 - black Rx in (TTL)
 - 5 - green/yellow ground
 to housing, isolated
 from other 4 pins

PLMa Side View

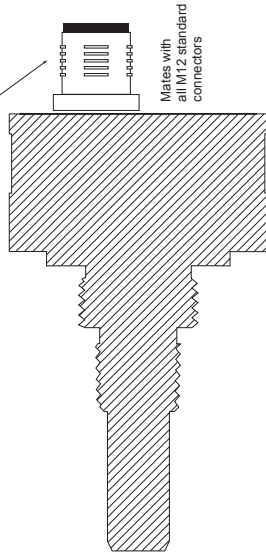

PLMa Top View

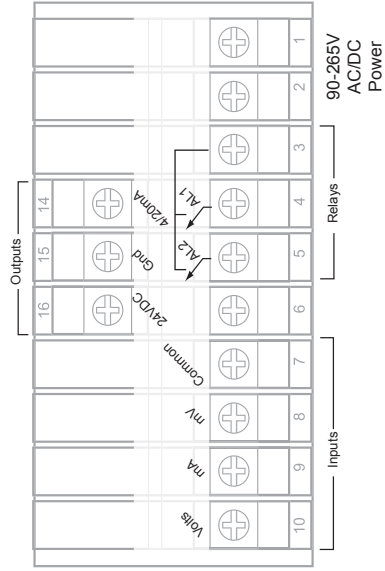
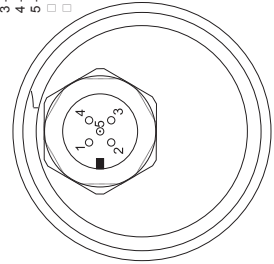

Moisture Measurement Innovation at Work

Integrating nanotechnology into moisture measurement

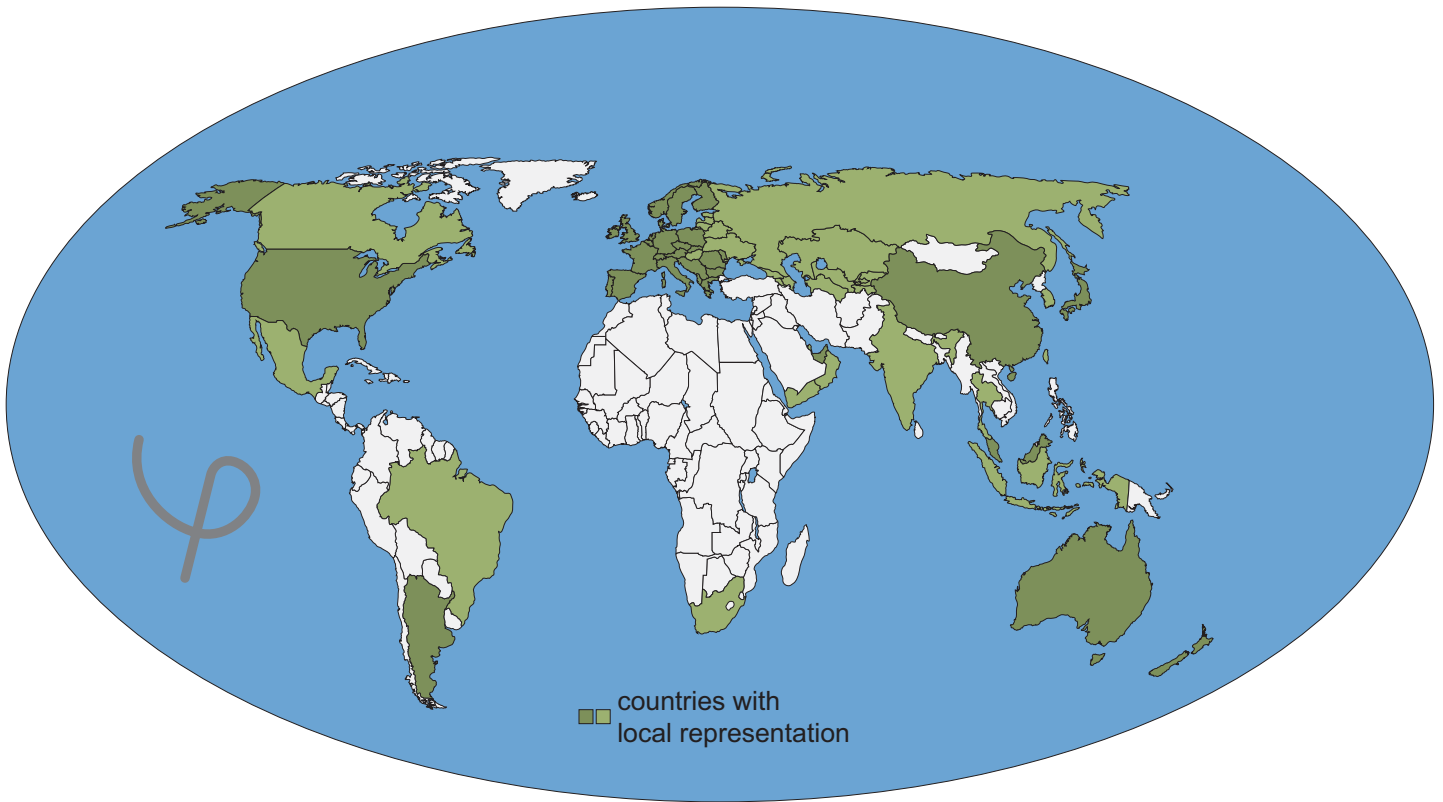
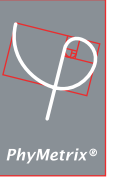

PhyMetrix Inc., 28C Industrial Blvd. Medford, NY 11763, USA, Tel:1-631-627-3950 Fax:1-631-627-3949



www.phymetrix.com • sales@phymetrix.com • service@phymetrix.com

