

# Rosemount™ DP Flow Meters and Primary Elements



- Multivariable capabilities allow for real-time fully compensated mass and energy flow
- Fully-integrated wireless flow meters allow for easy installation
- Minimize permanent pressure loss and save energy with Rosemount Annubar™ Averaging Pitot Tube Technology
- Reduce straight pipe requirements to two diameters upstream and downstream from most flow disturbances with Conditioning Orifice Technology
- Improve accuracy and repeatability in small line sizes with Integral Orifice Plate Technology

**Contents**

DP Flow Meter Selection Guide.....2

Rosemount 3051SF DP Flow Meters..... 6

Specifications..... 46

Product certifications ..... 65

Rosemount 3051CF Flow Meters..... 93

Specifications..... 128

Product certifications ..... 143

Rosemount 2051CF Flow Meters..... 159

Specifications..... 188

Product certifications..... 200

Rosemount 485 Annubar Primary Element..... 221

Specifications..... 229

Rosemount 486 Annubar Primary Element Mounting Hardware..... 235

Rosemount 585 Annubar Primary Element..... 240

Specifications..... 249

Rosemount 586 Annubar Primary Element Mounting Hardware..... 254

Rosemount 405 Compact Primary Element..... 261

Specifications..... 266

Rosemount 1595 Conditioning Orifice Plate..... 272

Specifications..... 277

Rosemount 1195 Integral Orifice Primary Element..... 282

Specifications..... 288

Rosemount 1495 Orifice Plate..... 292

Rosemount 1496 Orifice Flange Union..... 297

Specifications..... 302

Relevant documents..... 305

## DP Flow Meter Selection Guide

**Rosemount integrated DP Flow Meters arrive fully assembled, configured, and leak tested for out-of-the-box installation.**

**Rosemount 3051SF Flow Meters enable best-in-class flow measurement utilizing advanced functionality**



- Up to 0.80 percent mass flow rate accuracy
- Multivariable capabilities allow for real-time, fully compensated mass, and energy flow
- Advanced diagnostics predict and prevent abnormal process conditions
- Installation ready wireless flow solution
- Ultra for Flow measures percent-of-reading performance over 14:1 flow turndown
- 15-year stability, 15-year warranty
- SIL3 Capable: IEC 61508 certified by an accredited third party agency for use in safety instrumented systems up to SIL 3 (minimum requirement of single use [1oo1] for SIL 2 and redundant use [1oo2] for SIL 3)
- Available with 4–20 mA HART®, *WirelessHART*®, and FOUNDATION™ Fieldbus Protocols

**Rosemount 3051CF Flow Meters combine the proven 3051C Pressure Transmitter and the latest primary element technology**



- Up to 1.75 percent volumetric flow accuracy at 8:1 turndown
- Available with 4–20 mA HART, *WirelessHART*, and FOUNDATION™ Fieldbus Protocols
- 10-year stability
- SIL3 Capable: IEC 61508 certified by an accredited 3rd party agency for use in safety instrumented systems up to SIL 3 (minimum requirement of single use [1oo1] for SIL 2 and redundant use [1oo2] for SIL 3)

**Rosemount 2051CF Flow Meters combine the 2051C Pressure Transmitter and the latest primary element technology**



- Up to 2.00 percent volumetric flow accuracy at 5:1 turndown
- Available with HART, *WirelessHART*, and FOUNDATION™ Fieldbus Protocols
- 3-year stability

**Rosemount Annubar Primary Element Technology**

- Energy savings gained through minimal permanent pressure loss
- Innovative T-shape design providing accuracies up to  $\pm 0.75$  percent of flow rate (Rosemount 485 Annubar Primary Element)
- Variety of sensor materials for optimal compatibility with the process fluid
- Handles applications where conditions exceed the structural limitations of other primary elements
- Symmetrical sensor design allows bi-directional flow measurement (Rosemount 585 Annubar Primary Element)
- Rosemount 405A Compact Annubar primary element easily installs like an orifice plate
- Integral thermowell allows temperature measurement without additional pipe penetrations for Rosemount 485, 585, and 405A models.



**Rosemount Conditioning Orifice Plate Technology**

- Reduce straight pipe requirements to two diameters upstream and downstream from most flow disturbances
- Discharge coefficient uncertainty as low as  $\pm 0.5$  percent
- Integral thermowell allows temperature measurement without an additional pipe penetration with the compact design
- Reduce installation costs compared to traditional orifice plates with the compact design
- Conditioning orifice plate is based on AGA, ASME, and ISO industry standards
- Available in various plate styles providing installation flexibility



**Rosemount Integral Orifice Plate Technology**

- Improves accuracy and repeatability in  $\frac{1}{2}$  in., 1 in., and  $1\frac{1}{2}$  in. line sizes
- Self-centering plate design eliminates installation errors that are magnified in small line sizes
- Precision honed pipe sections allow accuracy of up to  $\pm 1.00$  percent of flow rate
- Installation flexibility with numerous process connections
- Integral thermowell allows temperature measurement without an additional pipe penetration

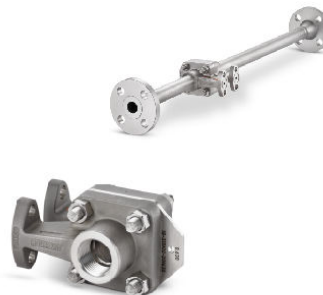

## Access information when you need it with asset tags

Newly shipped devices include a unique QR code asset tag that enables you to access serialized information directly from the device. With this capability, you can:

- Access device drawings, diagrams, technical documentation, and troubleshooting information in your MyEmerson account
- Improve mean time to repair and maintain efficiency
- Ensure confidence that you have located the correct device
- Eliminate the time-consuming process of locating and transcribing nameplates to view asset information

## Rosemount 3051SF DP Flow Meters



Rosemount 3051SFA



Rosemount 3051SFC



Rosemount 3051SFP

Rosemount 3051SF Flow Meters integrate the Rosemount 3051S with industry leading primary elements. Capabilities include:

- Flow meters are factory configured to meet your application needs ([Configuration Data Sheet](#) required)
- Multivariable capabilities allow scalable flow compensation (Measurement Types 1–4)
- 4–20 mA HART®, *WirelessHART*®, and FOUNDATION™ Fieldbus protocols
- Ultra for Flow for improved flow performance across wider flow ranges
- Integral temperature measurement (Option code T)
- Advanced diagnostics (Option code DA2)
- Direct or remote mount configurations available

Additional information

[Specifications](#)

[Relevant documents](#)

### Online product configurator

Many products are configurable online using our product configurator.

Select the **Configure** button or visit [Emerson.com/global](https://emerson.com/global) to start. With this tool's built-in logic and continuous validation, you can configure your products more quickly and accurately.

## Specifications and options

The purchaser of the equipment must specify and select the product materials, options, or components.

## Sizing and Selection Body

All Rosemount flow meters can be sized to meet your application specific requirements in the DP Flow sizing and selection tool. This tool will verify if a selected product meets your application requirements, provide a comparison between different primary elements, and generate a detailed accuracy comparison graph.

Once a sizing is completed, the configuration tool will help create a complete and valid model code to match your requirements and include any additional options or approvals.

## Optimizing lead time

The starred offerings (★) represent the most common options and should be selected for the fastest delivery times. The non-starred offerings are subject to additional delivery lead time.

## Rosemount 3051SFA Annubar™ Flow Meter



- Rosemount Annubar Flow Meters reduce permanent pressure loss by creating less blockage in the pipe
- Ideal for large line size installations when cost, size and weight of the flow meter are concerns
- Typical 3051SFA model code: **3051SFA D L 060 D C H P S 2 T 1 0 0 3 2 A A 1 A 3**

Specification and selection of product materials, options, or components must be made by the purchaser of the equipment.

CONFIGURE >

VIEW PRODUCT >

• = Available  
 — = Unavailable

## Required model components

### Model

Code	Description	Measurement type		
		D	1-7	
3051SFA	Annubar Flow Meter	•	•	★

Measurement type

Code	Description	Measurement type		
		D	1-7	
1	Fully compensated mass and energy flow calculations – differential and static pressures with temperature	—	•	★
2	Compensated flow calculations – differential and static pressures	—	•	★
3	Compensated flow calculations – differential pressure and temperature	—	•	★
4	Compensated flow calculations – differential pressure	—	•	★
5	Process variables only (no flow calculations) – differential and static pressures with temperature	—	•	★
6	Process variables only (no flow calculations) – differential and static pressures	—	•	★
7	Process variables only (no flow calculations) – differential pressure and temperature	—	•	★
D	Differential pressure	•	—	★

Fluid type

Code	Description	Measurement type		
		D	1-7	
L	Liquid	•	•	★
G	Gas	•	•	★
S	Steam	•	•	★

Line size

Actual units are built to customer supplied pipe ID and wall dimensions. Line size codes in model are used as a nominal size and auto-selected by the sizing program.

Code	Description	Measurement type		
		D	1-7	
020	2 in. (50 mm)	•	•	★
025	2½ in. (63.5 mm)	•	•	★
030	3 in. (80 mm)	•	•	★
035	3½ in. (89 mm)	•	•	★
040	4 in. (100 mm)	•	•	★
050	5 in. (125 mm)	•	•	★
060	6 in. (150 mm)	•	•	★
070	7 in. (175 mm)	•	•	★
080	8 in. (200 mm)	•	•	★
100	10 in. (250 mm)	•	•	★
120	12 in. (300 mm)	•	•	★
140	14 in. (350 mm)	•	•	
160	16 in. (400 mm)	•	•	
180	18 in. (450 mm)	•	•	

Code	Description	Measurement type		
		D	1-7	
200	20 in. (500 mm)	•	•	
240	24 in. (600 mm)	•	•	
300	30 in. (750 mm)	•	•	
360	36 in. (900 mm)	•	•	
420	42 in. (1066 mm)	•	•	
480	48 in. (1210 mm)	•	•	
600	60 in. (1520 mm)	•	•	
720	72 in. (1820 mm)	•	•	
780	78 in. (1950 mm)	•	•	
840	84 in. (2100 mm)	•	•	
900	90 in. (2250 mm)	•	•	
960	96 in. (2400 mm)	•	•	

**Pipe I.D. range**

Code	Description	Measurement type		
		D	1-7	
Z	Custom manufactured for customer-supplied pipe ID	•	•	★

**Pipe material/mounting assembly material**

Code	Description	Measurement type		
		D	1-7	
C	Carbon steel (A105)	•	•	★
S	316 stainless steel	•	•	★
0 <sup>(1)</sup>	No mounting <sup>(2)</sup>	•	•	★
G	Chrome-Moly Grade F-11	•	•	
N	Chrome-Moly Grade F-22	•	•	
J	Chrome-Moly Grade F-91	•	•	

(1) For customer supplied mounting or isolation valve, provide relevant dimension at time of sizing and order.

(2) Customer supplied.

**Piping orientation**

Code	Description	Measurement type		
		D	1-7	
H	Horizontal piping	•	•	★
D	Vertical piping with downwards flow	•	•	★
U	Vertical piping with upwards flow	•	•	★

**Annubar type**

Code	Description	Measurement type		
		D	1-7	
P	Pak-Lok	•	•	★
F	Flanged with opposite side support	•	•	★
L	Flange-Lok	•	•	
G	Gear-Drive Flo-Tap	•	•	
M	Manual Flo-Tap	•	•	

**Sensor material**

Code	Description	Measurement type		
		D	1-7	
S	316 Stainless steel	•	•	★
H	Alloy C-276	•	•	

**Sensor size**

Code	Description	Measurement type		
		D	1-7	
1	Sensor size 1 — Line sizes 2 in. (50 mm) to 8 in. (200 mm)	•	•	★
2	Sensor size 2 — Line sizes 6 in. (150 mm) to 96 in. (2400 mm)	•	•	★
3	Sensor size 3 — Line sizes greater than 12 in. (300 mm)	•	•	★

**Mounting type**

Code	Description	Measurement type		
		D	1-7	
T1	Compression/threaded connection	•	•	★
A1	Class 150 RF ASME B16.5	•	•	★
A3	Class 300 RF ASME B16.5	•	•	★
A6	Class 600 RF ASME B16.5	•	•	★
A9 <sup>(1)</sup>	Class 900 RF ASME B16.5	•	•	
AF <sup>(1)</sup>	Class 1500 RF ASME B16.5	•	•	
AT <sup>(1)</sup>	Class 2500 RF ASME B16.5	•	•	
D1	PN16 EN-1092-1 RF	•	•	★
D3	PN40 EN-1092-1 RF	•	•	★
D6	PN100 EN-1092-1 RF	•	•	★
R1	Class 150 RTJ ASME B16.5	•	•	
R3	Class 300 RTJ ASME B16.5	•	•	
R6	Class 600 RTJ ASME B16.5	•	•	

Code	Description	Measurement type		
		D	1-7	
R9 <sup>(1)</sup>	Class 900 RTJ ASME B16.5	•	•	
RF <sup>(1)</sup>	Class 1500 RTJ ASME B16.5	•	•	
RT <sup>(1)</sup>	Class 2500 RTJ ASME B16.5	•	•	

(1) Available in remote mount applications only.

### Opposite side support or packing gland

Code	Description			
0	No opposite side support or packing gland <sup>(1)</sup>	★		
<b>Opposite side support <sup>(2)</sup></b>				
C	NPT threaded opposite support assembly	★		
D	Welded opposite support assembly	★		
<b>Packing gland <sup>(3)</sup></b>				
	Packing gland material	Rod material	Packing material	
J <sup>(4)</sup>	Stainless steel packing gland/cage nipple	Carbon steel	PTFE	
K <sup>(4)</sup>	Stainless steel packing gland/cage nipple	Stainless steel	PTFE	
L <sup>(4)</sup>	Stainless steel packing gland/cage nipple	Carbon steel	Graphite	
N <sup>(4)</sup>	Stainless steel packing gland/cage nipple	Stainless steel	Graphite	
R	Alloy C-276 packing gland/cage nipple	Stainless steel	Graphite	

(1) Required for Pak-Lok and Flange-Lok models.

(2) Required for flanged models.

(3) Required for Flo-Tap models.

(4) The cage nipple is constructed of 304SST.

### Isolation valve for Flo-Tap models

Code	Description	Measurement type		
		D	1-7	
0 <sup>(1)</sup>	Not applicable or customer supplied	•	•	★
1	Gate valve, carbon steel	•	•	
2	Gate valve, stainless steel	•	•	
5	Ball valve, carbon steel	•	•	
6	Ball valve, stainless steel	•	•	

(1) For customer-supplied mounting or isolation valve, provide relevant dimension at time of sizing and order.

### Temperature measurement

Code	Description	Measurement type		
		D	1-7	
T <sup>(1)</sup>	Integral RTD <sup>(2)</sup>	•	•	★
0	No temperature sensor	•	•	★

Code	Description	Measurement type		
		D	1-7	
R <sup>(1)</sup>	Remote thermowell and RTD	•	•	

- (1) A temperature sensor is required for measurement types 1, 3, 5, and 7. If the temperature sensor will be customer-supplied, contact an Emerson representative for assistance.
- (2) Not available with flanged model greater than Class 600.

**Transmitter connection platform**

Code	Description	Measurement type		
		D	1-7	
3	Direct mount, integral 3-valve manifold <sup>(1)</sup>	•	•	★
5	Direct mount, 5-valve manifold <sup>(2)</sup>	•	•	★
6	Direct mount, high temperature 5-valve manifold <sup>(3)</sup>	•	•	
7	Remote mount NPT connections (½ in. FNPT)	•	•	★
8	Remote mount SW connections (½ in.)	•	•	

- (1) Not available with flanged model greater than Class 600.
- (2) Not available with flanged model greater than Class 600.
- (3) Not available with flanged model greater than Class 600.

**Differential pressure range**

Code	Description	Measurement type		
		D	1-7	
1	0 to 25 inH <sub>2</sub> O (0 to 62.16 mbar)	•	•	★
2	0 to 250 inH <sub>2</sub> O (0 to 621.60 mbar)	•	•	★
3	0 to 1000 inH <sub>2</sub> O (0 to 2.49 bar)	•	•	★

**Static pressure range**

Code	Description	Measurement type		
		D	1-7	
A <sup>(1)</sup>	None	•	•	★
D	Absolute (0 to 800 psia [0 to 55.16 bar])	—	•	★
E <sup>(2)</sup>	Absolute (0 to 3626 psia [0 to 250.0 bar])	—	•	★
J	Gage (-14.20 to 800 psig [-0.98 to 55.16 bar])	—	•	★
K <sup>(2)</sup>	Gage (-14.20 to 3626 psig [-0.98 to 250.0 bar])	—	•	★

- (1) Required for measurement type codes 3, 4, 7, and D.
- (2) For measurement type codes 1, 2, 5, and 6 with DP range 1, absolute limits are 0.5 to 2000 psi (0.03 to 137.9 bar) and gauge limits are -14.2 to 2000 psig (-0.98 to 137.9 bar).

**Transmitter output**

Code	Description	Measurement type		
		D	1-7	
A	4–20 mA with digital signal based on HART® protocol	•	•	★

Code	Description	Measurement type		
		D	1-7	
F <sup>(1)</sup>	FOUNDATION™ Fieldbus protocol <sup>(2)</sup>	•	•	★
X <sup>(3)(4)</sup>	Wireless <sup>(5)</sup>	•	•	★

(1) Transmitter output code F is only available with measurement type code 1, 2, 5, 6, and D.

(2) Requires Plantweb™ housing.

(3) Only intrinsically safe approval codes apply.

(4) Only available with measurement types D and 6.

(5) Requires wireless options and Wireless Plantweb housing.

### Transmitter housing style

Code	Description	Material	Conduit entry size	Measurement type		
				D	1-7	
00	None <sup>(1)</sup>	N/A	N/A	•	—	★
1A	Plantweb™ housing	Aluminum	½-14 NPT	•	•	★
1B	Plantweb housing	Aluminum	M20 x 1.5	•	•	★
1J	Plantweb housing	SST	½-14 NPT	•	•	★
1K	Plantweb housing	SST	M20 x 1.5	•	•	★
2A	Junction box housing	Aluminum	½-14 NPT	•	—	★
2B	Junction box housing	Aluminum	M20 x 1.5	•	—	★
2E	Junction box housing with output for remote display and interface	Aluminum	½-14 NPT	•	—	★
2F	Junction box housing with output for remote display and interface	Aluminum	M20 x 1.5	•	—	★
2J	Junction box housing	SST	½-14 NPT	•	—	★
2M	Junction box housing with output for remote display and interface	SST	½-14 NPT	•	—	★
5A <sup>(2)</sup>	Wireless Plantweb housing	Aluminum	½-14 NPT	•	•	★
5J <sup>(2)</sup>	Wireless Plantweb housing	SST	½-14 NPT	•	•	★
7J <sup>(3)(4)</sup>	Quick Connect (A size mini, 4-pin male termination)	N/A	N/A	•	—	★
1C	Plantweb housing	Aluminum	G½	•	•	
1L	Plantweb housing	SST	G½	•	•	
2C	Junction box housing	Aluminum	G½	•	—	
2G	Junction box housing with output for remote display and interface	Aluminum	G½	•	—	

(1) Customer-supplied electrical connection.

(2) Only available with transmitter output code X.

(3) Only intrinsically safe approval codes apply.

(4) Only available with transmitter output code A.

**Performance class**

For detailed specifications, see [Specifications](#).

Code	Description	Measurement type		
		D	1-7	
<b>Measurement types 1, 2, 5, and 6</b>				
3 <sup>(1)</sup>	Ultra for Flow: 0.8% flow rate accuracy, 14:1 flow turndown, 15-year stability, 15-year limited warranty	•	•	★
5	Classic MV: 1.15% flow rate accuracy, 8:1 flow turndown, 15-year stability	—	•	★
<b>Measurement types 3, 4, 7, and D</b>				
1	Ultra: up to 0.95% flow rate accuracy, 8:1 flow turndown, 15-year stability, 15-year limited warranty	•	—	★
2	Classic: up to 1.40% flow rate accuracy, 8:1 flow turndown, 15-year stability	•	—	★
3 <sup>(1)</sup>	Ultra for Flow: 0.8% flow rate accuracy, 14:1 flow turndown, 15-year stability, 15-year limited warranty	•	•	★

(1) Only available with differential pressure ranges 2 and 3, and silicone fill fluid.

**Wireless options**

**Update rate, operating frequency and protocol**

Code	Description	Measurement type		
		D	1-7	
WA3	User configurable update rate, 2.4 GHz DSSS, IEC 62591 ( <i>WirelessHART</i> ®)	•	•	★

**Omni-directional wireless antenna and SmartPower**

Long-life Power Module must be shipped separately; order Power Module 701PBKKE.

Code	Description	Measurement type		
		D	1-7	
WJ1	Remote antenna, adapter for Black Power Module (I.S. Power Module sold separately)	•	—	★
WK1	External antenna, adapter for Black Power Module (I.S. Power Module sold separately)	•	•	★
WM1	Extended range, external antenna, adapter for Black Power Module (I.S. Power Module sold separately)	•	•	★
WN1	High-gain, remote antenna, adapter for Black Power Module (I.S. Power Module sold separately)	•	•	

**Additional options**

**HART® revision configuration (requires HART Protocol output code A)**

Option HR7 configures the HART output to HART Revision 7. This option requires the selection of the Advanced Diagnostics (DA2) option. If desired, the device with this option can be field-configured to HART Revision 5 or 7.

Code	Description	Measurement type		
		D	1-7	
HR7	Configured for HART Revision 7	•	—	★

**Extended product warranty**

Code	Description	Measurement type		
		D	1-7	
WR3	3-year limited warranty	•	•	★
WR5	5-year limited warranty	•	•	★

**Pressure testing**

Code	Description	Measurement type		
		D	1-7	
P1	Hydrostatic testing with certificate	•	•	
PX	Extended hydrostatic testing	•	•	

**Special cleaning**

Code	Description	Measurement type		
		D	1-7	
P2	Cleaning for special processes	•	•	

**Material testing**

Code	Description	Measurement type		
		D	1-7	
V1	Dye penetrant exam	•	•	

**Material examination**

Code	Description	Measurement type		
		D	1-7	
V2	Radiographic examination	•	•	

**Flow calibration**

Code	Description	Measurement type		
		D	1-7	
W1	Flow calibration (average K)	•	•	

**Special inspection**

Code	Description	Measurement type		
		D	1-7	
QC1	Visual and dimensional inspection with certificate	•	•	★
QC7	Inspection and performance certificate	•	•	★

**Surface finish**

This surface finish option is auto-selected by the sizing tool as necessary.

Code	Description	Measurement type		
		D	1-7	
RL	Surface finish for low pipe Reynolds number in gas and steam	•	•	★
RH	Surface finish for high pipe Reynolds number in liquid	•	•	★

**Material traceability certification**

Instrument connections for remote mount options and isolation valves for flo-tap models are not included in the material traceability certification.

Code	Description	Measurement type		
		D	1-7	
Q8	Material traceability certificate per EN 10204:2004 3.1	•	•	★

**Positive material identification (PMI)**

For pressure retaining parts only. Isolation and instrument valves are not included.

Code	Description	Measurement type		
		D	1-7	
Q76	PMI verification and certificate	•	•	★

**Code conformance**

Code	Description	Measurement type		
		D	1-7	
J2	ANSI/ASME B31.1	•	•	
J3	ANSI/ASME B31.3	•	•	
J5 <sup>(1)(2)</sup>	Certificate of Compliance to NACE MR0175/ISO 15156 for wetted materials	•	•	
J6	European Pressure Directive (PED)	•	•	★
J1	Canadian Registration	•	•	
J8	Chinese Certificate of Special Equipment Type Test	•	•	

(1) *Materials of construction comply with metallurgical requirements within NACE MR0175/ISO 15156 for sour oil field production environments. Environmental limits apply to certain materials. Consult latest standard for details. Selected materials also conform to NACE MR0103 for sour refining environments.*

(2) *Selecting J5 option will provide Alloy C-276 transmitter diaphragms.*

**Installed in flanged pipe spool section**

Refer to Rosemount 485 specifications for spool section lengths and schedules.

Code	Description	Measurement type		
		D	1-7	
H3	Class 150 flanged connection with Rosemount standard length and schedule	•	•	
H4	Class 300 flanged connection with Rosemount standard length and schedule	•	•	
H5	Class 600 flanged connection with Rosemount standard length and schedule	•	•	

### Instrument connections for remote mount option

Code	Description	Measurement type		
		D	1-7	
G2	Needle valves, stainless steel	•	•	★
G6	OS and Y gate valves, stainless steel	•	•	★
G1	Needle valves, carbon steel	•	•	
G3	Needle valves, Alloy C-276	•	•	
G5	OS and Y gate valves, carbon steel	•	•	
G7	OS and Y gate valves, Alloy C-276	•	•	

### Special shipment

Requires 486 model to be ordered. Include Y1 option on 486 model also.

Code	Description	Measurement type		
		D	1-7	
Y1	Mounting hardware <sup>(1)</sup>	•	•	★

(1) *Shipped separately.*

### Special dimensions

Code	Description	Measurement type		
		D	1-7	
VM	Variable mounting	•	•	

### Transmitter calibration certification

Code	Description	Measurement type		
		D	1-7	
Q4	Calibration certificate for transmitter	•	•	★
QP	Calibration certificate and tamper evident seal	•	•	★

### Quality certification for safety

For option code A: 4–20 mA HART® only. Not available with housing code 7J.

Code	Description	Measurement type		
		D	1-7	
QT	Safety certified to IEC 61508 with certificate of FMEDA data	•	—	★

### Product certifications

Code	Description	Measurement type		
		D	1-7	
E1	ATEX Flameproof	•	•	★

Code	Description	Measurement type		
		D	1-7	
I1	ATEX Intrinsic Safety	•	•	★
IA <sup>(1)</sup>	ATEX FISCO Intrinsic Safety	•	•	★
N1	ATEX Type n	•	•	★
ND	ATEX Dust	•	•	★
K1	ATEX Flameproof, Intrinsic Safety, Type n, Dust (combination of E1, I1, N1, and ND)	•	•	★
I2	Brazil Intrinsic Safety	•	•	★
K2	Brazil Flameproof, Intrinsic Safety	•	•	★
E4	Japan Flameproof	•	•	★
E5	USA Explosion-proof, Dust Ignition-proof	•	•	★
I5	USA Intrinsically Safe; Nonincendive	•	•	★
IE <sup>(1)</sup>	USA FISCO Intrinsic Safety	•	•	★
K5	USA Explosion-proof, Dust Ignition-proof, Intrinsically Safe, Division 2 (combination of E5 and I5)	•	•	★
E6 <sup>(2)</sup>	Canada Explosion-proof, Dust Ignition-proof, Division 2	•	•	★
I6	Canada Intrinsically Safe	•	•	★
IF <sup>(1)</sup>	Canada FISCO Intrinsic Safety	•	•	★
K6 <sup>(2)</sup>	Canada Explosion-proof, Dust Ignition-proof, Intrinsically Safe, Division 2 (combination of E6 and I6)	•	•	★
E7	IECEX Flameproof, Dust Ignition-proof	•	•	★
I7	IECEX Intrinsic Safety	•	•	★
IG <sup>(1)</sup>	IECEX FISCO Intrinsic Safety	•	•	★
N7	IECEX Type n	•	•	★
K7	IECEX Flameproof, Dust Ignition-proof, Intrinsic Safety, Type n (combination of E7, I7, and N7)	•	•	★
E3	China Flameproof	•	•	★
I3	China Intrinsic Safety	•	•	★
EP	Republic of Korea Flameproof	•	•	★
IP	Republic of Korea Intrinsic Safety	•	•	★
KP	Republic of Korea Flameproof, Intrinsic Safety	•	•	★
KA <sup>(2)</sup>	ATEX and Canada Flameproof, Intrinsically Safe, Division 2 (combination of E1, I1, E6, and I6)	•	•	★
KB <sup>(2)</sup>	USA and Canada Explosion-proof, Dust Ignition-proof, Intrinsically Safe, Division 2 (combination of E5, E6, I5, and I6)	•	•	★
EM	Technical Regulations Customs Union (EAC) Flameproof	•	•	★
IM	Technical Regulations Customs Union (EAC) Intrinsic Safety	•	•	★
KM	Technical Regulations Customs Union (EAC) Flameproof, Intrinsic Safety	•	•	★
E2	Brazil Flameproof	•	•	★
KC	USA and ATEX Explosion-proof, Intrinsically Safe, Division 2 (combination of E5, E1, I5, and I1)	•	•	★
KD <sup>(2)</sup>	USA, Canada, and ATEX Explosion-proof, Intrinsically Safe (combination of E5, I5, E6, I6, E1, and I1)	•	•	★

(1) FISCO is only available with Transmitter output code F.

(2) Not available with M20 or G½ conduit entry size.

### Shipboard approvals

Code	Description	Measurement type		
		D	1-7	
SBS	American Bureau of Shipping	•	•	★
SBV	Bureau Veritas (BV) Type Approval	•	•	★
SDN	Det Norske Veritas (DNV) Type Approval	•	•	★
SLL	Lloyds Register (LR) Type Approval	•	•	★

### Sensor fill fluid and O-ring options

Code	Description	Measurement type		
		D	1-7	
L1	Inert sensor fill fluid	•	•	★
L2	Graphite-filled (PTFE) O-ring	•	•	★
LA	Inert sensor fill fluid and graphite-filled (PTFE) O-ring	•	•	★

### Digital display

Not available with housing code 7J.

Code	Description	Measurement type		
		D	1-7	
M5	Plantweb™ LCD display <sup>(1)</sup>	•	•	★
M7 <sup>(2)(3)(4)</sup>	Remote mount LCD display and interface, Plantweb housing, no cable; SST bracket	•	—	★
M8 <sup>(2)(3)</sup>	Remote mount LCD display and interface, Plantweb housing, 50 ft. (15 m) cable; SST bracket	•	—	★
M9 <sup>(2)(3)</sup>	Remote mount LCD display and interface, Plantweb housing, 100 ft. (31 m) cable; SST bracket	•	—	★

(1) Requires Plantweb housing.

(2) Not available with transmitter output code X. Only available with measurement type D.

(3) Not available with transmitter output code F, option code DA2, or option code QT.

(4) See the Rosemount 3051S [Reference Manual](#) for cable requirements. Contact an Emerson representative for additional information.

### Transient protection

Code	Description	Measurement type		
		D	1-7	
T1	Transient terminal block <sup>(1)</sup>	•	•	★

(1) This is not available with Housing code 00, 5A, 5J, or 7J. External ground screw assembly (option code D4) is included with the T1 option. The T1 option is not needed with FISCO Product Certifications.

### Manifold for remote mount option

Code	Description	Measurement type		
		D	1-7	
F2	3-valve manifold, stainless steel	•	•	★
F6	5-valve manifold, stainless steel	•	•	★

Code	Description	Measurement type		
		D	1-7	
F3	3-valve manifold, Alloy C-276	•	•	
F7	5-valve manifold, Alloy C-276	•	•	

**Plantweb control functionality**

Code	Description	Measurement type		
		D	1-7	
A01	FOUNDATION™ Fieldbus advanced control function block suite	•	•	★

**Plantweb diagnostics functionality**

Code	Description	Measurement type		
		D	1-7	
D01	FOUNDATION™ Fieldbus diagnostics suite (Process Intelligence, Plugged Impulse Line diagnostic)	•	—	★
DA2 <sup>(1)</sup>	Advanced HART® diagnostic suite (Process Intelligence, Loop Integrity, Plugged Impulse Line diagnostic, Process Alerts, Service Alerts, Variable Log, Event Log)	•	—	★

(1) Includes Hardware Adjustments (option code D1) as standard. Not available with transmitter output code X or F. Only available with measurement type D.

**Plantweb enhanced measurement functionality**

Requires Rosemount Engineering Assistant to configure. To ensure correct operation, download the Engineering Assistant software at [Emerson.com/Rosemount](https://emerson.com/Rosemount).

Code	Description	Measurement type		
		D	1-7	
H01	FOUNDATION™ Fieldbus fully compensated mass flow block	•	—	★

**Cold temperature**

Code	Description	Measurement type		
		D	1-7	
BRR	-58 °F (-50 °C) cold temperature start-up	—	•	★
BR6	-76 °F (-60 °C) cold temperature operation	•	—	★

**Alarm limit**

Not available with transmitter output code F or X.

Code	Description	Measurement type		
		D	1-7	
C4	NAMUR alarm and saturation levels, high alarm	•	•	★
C5	NAMUR alarm and saturation levels, low alarm	•	•	★
C6	Custom alarm and saturation levels, high alarm (requires C1 and <a href="#">Configuration Data Sheet</a> )	•	•	★

Code	Description	Measurement type		
		D	1-7	
C7	Custom alarm and saturation levels, low alarm (requires C1 and <a href="#">Configuration Data Sheet</a> )	•	•	★
C8	Low alarm (standard Rosemount alarm and saturation levels)	•	•	★

### Hardware adjustments and ground screw

Code	Description	Measurement type		
		D	1-7	
D1 <sup>(1)(2)(3)</sup>	Hardware adjustments (zero, span, alarm, security)	•	—	★
D4 <sup>(4)</sup>	External ground screw assembly	•	•	★
DA <sup>(1)(2)(3)</sup>	Hardware adjustments (zero, span, alarm, security) and external ground screw assembly	•	•	★

(1) Not available with transmitter output code X. Only available with measurement type D.

(2) Not available with transmitter output code F.

(3) Not available with housing codes 2E, 2F, 2G, 2M, 5A, 5J, or 7J.

(4) This assembly is included with options E1, E2, E3, E4,E7, EM, EP, K1, K2, K6, K7, KA, KC, KD, KP, KM, N1, N3, N7, ND, and T1.

### Conduit plug

Code	Description	Measurement type		
		D	1-7	
DO	316 SST conduit plug	•	•	★

### Conduit electrical connector

This is not available with housing code 5A, 5J, or 7J. Available with intrinsically Safe approvals only. For FM intrinsically Safe; Nonincendive (option code I5) or FM FISCO Intrinsically Safe (option code IE), install in accordance with Rosemount drawing 03151-1009.

Code	Description	Measurement type		
		D	1-7	
GE	M12, 4-pin, male connector (Eurofast <sup>®</sup> )	•	•	
GM	A size mini, 4-pin, male connector (Minifast <sup>®</sup> )	•	•	

## Rosemount 3051SFC Compact Flow Meter



• = Available  
 — = Unavailable

- Compact conditioning flow meters reduce straight piping requirements to 2D upstream and 2D downstream from most flow disturbances
- Simple installation of compact flow meters between any existing raised-face flanges
- Typical 3051SFC model code: **3051SFC 1 C S 060 N 065 T 3 2 J A 1A 3**

Specification and selection of product materials, options, or components must be made by the purchaser of the equipment.

For additional technical data and ordering information for Rosemount Annubar Primary Elements, refer to the Rosemount DP Flow meters and Primary Elements [Product Data Sheet](#).

CONFIGURE >

VIEW PRODUCT >

### Required model components

#### Model

Code	Description	Measurement type		
		D	1-7	
3051SFC	Compact Flow Meter	•	•	

#### Measurement type

Code	Description	Measurement type		
		D	1-7	
1	Fully compensated mass and energy flow calculations – differential and static pressures with temperature	—	•	★
2	Compensated flow calculations – differential and static pressures	—	•	★
3	Compensated flow calculations – differential pressure and temperature	—	•	★
4	Compensated flow calculations – differential pressure	—	•	★
5	Process variables only (no flow calculations) – differential and static pressures with temperature	—	•	★
6	Process variables only (no flow calculations) – differential and static pressures	—	•	★
7	Process variables only (no flow calculations) – differential pressure and temperature	—	•	★
D	Differential pressure	•	—	★

#### Primary element technology

Code	Description	Measurement type		
		D	1-7	
A	Annubar averaging pitot tube	•	•	★
C	Conditioning orifice plate	•	•	★
P	Orifice plate	•	•	★

**Material type**

Code	Description	Measurement type		
		D	1-7	
S	316 SST	•	•	★

**Line size**

Code	Description	Measurement type		
		D	1-7	
005 <sup>(1)</sup>	½ in. (15 mm)	•	•	★
010 <sup>(1)</sup>	1 in. (25 mm)	•	•	★
015 <sup>(1)</sup>	1½ in. (40 mm)	•	•	★
020	2 in. (50 mm)	•	•	★
030	3 in. (80 mm)	•	•	★
040	4 in. (100 mm)	•	•	★
060	6 in. (150 mm)	•	•	★
080	8 in. (200 mm)	•	•	★
100 <sup>(2)(3)</sup>	10 in. (250 mm)	•	•	★
120 <sup>(2)(3)</sup>	12 in. (300 mm)	•	•	★

- (1) Available with primary element technology P code only.
- (2) For the 10 in. (250 mm) and 12 in. (300 mm) line sizes, the alignment ring must be ordered (Installation Accessories).
- (3) 10 in. (250 mm) and 12 in. (300 mm) line sizes not available with primary element technology code A.

**Primary element type**

Code	Description	Measurement type		
		D	1-7	
N000	Annubar sensor size 1	•	•	★
N040	0.40 Beta ratio (β)	•	•	★
N050	0.50 Beta ratio (β)	•	•	★
N065 <sup>(1)</sup>	0.65 Beta ratio (β)	•	•	★

- (1) For 2 in. (50 mm) line size the beta ratio is 0.60 for primary element technology code C.

**Temperature measurement**

Code	Description	Measurement type		
		D	1-7	
T <sup>(1)</sup>	Integral RTD	—	•	★
0	No temperature sensor	•	•	★
R <sup>(1)</sup>	Remote thermowell and RTD	•	•	

- (1) A temperature sensor is required for measurement types 1, 3, 5, and 7. If the temperature sensor will be customer supplied, contact an Emerson representative for assistance.

**Transmitter connection platform**

Code	Description	Measurement type		
		D	1-7	
3	Direct mount, integral 3-valve manifold	•	•	★
7	Remote mount, NPT connections	•	•	★

**Differential pressure range**

Code	Description	Measurement type		
		D	1-7	
1	0 to 25 inH <sub>2</sub> O (0 to 62.16 mbar)	•	•	★
2	0 to 250 inH <sub>2</sub> O (0 to 621.60 mbar)	•	•	★
3	0 to 1000 inH <sub>2</sub> O (0 to 2.49 bar)	•	•	★

**Static pressure range**

Code	Description	Measurement type		
		D	1-7	
A <sup>(1)</sup>	None	•	•	★
D	Absolute (0 to 800 psia [0 to 55.16 bar])	—	•	★
E <sup>(2)</sup>	Absolute (0 to 3626 psia [0 to 250.0 bar])	—	•	★
J	Gage (-14.20 to 800 psig [-0.98 to 55.16 bar])	—	•	★
K <sup>(2)</sup>	Gage (-14.20 to 3626 psig [-0.98 to 250.0 bar])	—	•	★

(1) Required for measurement type codes 3, 4, 7, and D.

(2) For measurement type codes 1, 2, 5, and 6 with DP range 1, absolute limits are 0.5 to 2000 psi (0.03 to 137.9 bar) and gauge limits are -14.2 to 2000 psig (-0.98 to 137.9 bar).

**Transmitter output**

Code	Description	Measurement type		
		D	1-7	
A	4–20 mA with digital signal based on HART® protocol	•	•	★
F <sup>(1)(2)</sup>	FOUNDATION™ Fieldbus protocol	•	•	★
X <sup>(3)(4)</sup>	Wireless	•	—	★

(1) Requires Plantweb housing.

(2) Transmitter output code F is only available with Measurement type code 1, 2, 5, 6, and D.

(3) Only intrinsically safe approval codes apply.

(4) Only available with Measurement Types D and 6.

**Transmitter housing style**

Code	Description	Material	Conduit entry size	Measurement type		
				D	1-7	
00	None <sup>(1)</sup>	N/A	N/A	•	—	★
1A	Plantweb™ housing	Aluminum	½–14 NPT	•	•	★

Code	Description	Material	Conduit entry size	Measurement type		
				D	1-7	
1B	Plantweb housing	Aluminum	M20 x 1.5	•	•	★
1J	Plantweb housing	SST	½-14 NPT	•	•	★
1K	Plantweb housing	SST	M20 x 1.5	•	•	★
2A	Junction box housing	Aluminum	½-14 NPT	•	—	★
2B	Junction box housing	Aluminum	M20 x 1.5	•	—	★
2E	Junction box housing with output for remote display and interface	Aluminum	½-14 NPT	•	—	★
2F	Junction box housing with output for remote display and interface	Aluminum	M20 x 1.5	•	—	★
2J	Junction box housing	SST	½-14 NPT	•	—	★
2M	Junction box housing with output for remote display and interface	SST	½-14 NPT	•	—	★
5A <sup>(2)</sup>	Wireless Plantweb housing	Aluminum	½-14 NPT	•	•	★
5J <sup>(2)</sup>	Wireless Plantweb housing	SST	½-14 NPT	•	•	★
7J <sup>(3)(4)</sup>	Quick Connect (A size mini, 4-pin male termination)	N/A	N/A	•	—	★
1C	Plantweb housing	Aluminum	G½	•	•	
1L	Plantweb housing	SST	G½	•	•	
2C	Junction box housing	Aluminum	G½	•	—	
2G	Junction box housing with output for remote display and interface	Aluminum	G½	•	—	

(1) *Customer-supplied electrical connection.*

(2) *Only available with transmitter output code X.*

(3) *Only intrinsically safe approval codes apply.*

(4) *Only available with transmitter output code A.*

### Performance class

For detailed specifications, see [Specifications](#).

Code	Description	Measurement type		
		D	1-7	
<b>Measurement types 1, 2, 5, and 6</b>				
3 <sup>(1)</sup>	Ultra for Flow: 0.75% flow rate accuracy, 14:1 flow turndown, 15-year stability, 15-year limited warranty	•	•	★
5	Classic MV: 1.10% flow rate accuracy, 8:1 flow turndown, 15-year stability	—	•	★
<b>Measurement types 3, 4, 7, and D</b>				
1	Ultra: up to 0.90% flow rate accuracy, 8:1 flow turndown, 15-year stability, 15-year limited warranty	•	—	★
2	Classic: up to 1.40% flow rate accuracy, 8:1 flow turndown, 15-year stability	•	—	★
3 <sup>(1)</sup>	Ultra for Flow: 0.75% flow rate accuracy, 14:1 flow turndown, 15-year stability, 15-year limited warranty	•	•	★

(1) *Only available with differential pressure ranges 2 and 3, and silicone fill fluid.*

## Wireless options

### Update rate, operating frequency and protocol

Code	Description	Measurement type		
		D	1-7	
WA3	User configurable update rate, 2.4 GHz DSSS, IEC 62591 ( <i>WirelessHART</i> <sup>®</sup> )	•	•	★

### Omni-directional wireless antenna and SmartPower

Long-life Power Module must be shipped separately; order Power Module 701PBKKF.

Code	Description	Measurement type		
		D	1-7	
WJ1	Remote antenna, adapter for Black Power Module (I.S. Power Module sold separately)	•	—	★
WK1	External antenna, adapter for Black Power Module (I.S. Power Module sold separately)	•	•	★
WM1	Extended range, external antenna, adapter for Black Power Module (I.S. Power Module sold separately)	•	•	★
WN1	High-gain, remote antenna, adapter for Black Power Module (I.S. Power Module sold separately)	•	•	

## Additional options

### HART<sup>®</sup> revision configuration (requires HART Protocol output code A)

Option HR7 configures the HART output to HART Revision 7. This option requires the selection of the Advanced Diagnostics (DA2) option. If desired, the device with this option can be field-configured to HART Revision 5 or 7.

Code	Description	Measurement type		
		D	1-7	
HR7	Configured for HART Revision 7	•	—	★

### Extended product warranty

Code	Description	Measurement type		
		D	1-7	
WR3	3-year limited warranty	•	•	★
WR5	5-year limited warranty	•	•	★

### Installation accessories

Code	Description	Measurement type		
		D	1-7	
A <sup>(1)</sup>	ANSI alignment ring (Class 150)	•	•	★
C <sup>(1)</sup>	ANSI alignment ring (Class 300)	•	•	★
D <sup>(1)</sup>	ANSI alignment ring (Class 600)	•	•	★
G	DIN alignment ring (PN 16)	•	•	★
H	DIN alignment ring (PN 40)	•	•	★

Code	Description	Measurement type		
		D	1-7	
J	DIN alignment ring (PN 100)	•	•	★
B	JIS alignment ring (10K) <sup>(2)</sup>	•	•	
R	JIS alignment ring (20K)	•	•	
S	JIS alignment ring (40K)	•	•	

(1) Only required for 10 in. (250 mm) and 12 in. (300mm) line sizes.

(2) Not available on 12-in (300 mm) line size.

### Remote adapters

Code	Description	Measurement type		
		D	1-7	
E	Flange adapters 316 SST (½ in. NPT)	•	•	★

### High temperature applications

Code	Description	Measurement type		
		D	1-7	
T	Graphite valve packing (T <sub>max</sub> = 850 °F [454 °C])	•	•	

### Flow calibration

Code	Description	Measurement type		
		D	1-7	
WC <sup>(1)</sup>	Flow calibration, 3 pt. conditioning orifice option C	•	•	
WD <sup>(2)(3)</sup>	Flow calibration, 10 pt. conditioning orifice option C or Annubar option A	•	•	

(1) Available with primary element technology code C only.

(2) Available with primary element technology codes C or A only.

(3) Consult factory for pipe schedules other than SCH 40.

### Pressure testing

Code	Description	Measurement type		
		D	1-7	
P1	Hydrostatic testing with certificate	•	•	★

### Special cleaning

Available with primary element technology C or P only.

Code	Description	Measurement type		
		D	1-7	
P2	Cleaning for special processes	•	•	

**Special inspection**

Code	Description	Measurement type		
		D	1-7	
QC1	Visual and dimensional inspection with certificate	•	•	★
QC7	Inspection and performance certificate	•	•	★

**Transmitter calibration certification**

Code	Description	Measurement type		
		D	1-7	
Q4	Calibration certificate for transmitter	•	•	★
QP	Calibration certificate and tamper evident seal	•	•	★

**Quality certification for safety**

For option code A: 4–20 mA HART® only. Not available with housing code 7J.

Code	Description	Measurement type		
		D	1-7	
QT	Safety certified to IEC 61508 with certificate of FMEDA data	•	—	★

**Material traceability certification**

Code	Description	Measurement type		
		D	1-7	
Q8	Material traceability certificate per EN 10204:2004 3.1	•	•	★

**Positive material identification (PMI)**

Code	Description	Measurement type		
		D	1-7	
Q76	PMI verification and certificate	•	•	★

**Code conformance**

Code	Description	Measurement type		
		D	1-7	
J2	ANSI/ASME B31.1	•	•	
J3	ANSI/ASME B31.3	•	•	
J5 <sup>(1)(2)</sup>	Certificate of Compliance to NACE MR0175/ISO 15156 for wetted materials	•	•	

(1) *Materials of construction comply with metallurgical requirements within NACE MR0175/ISO 15156 for sour oil field production environments. Environmental limits apply to certain materials. Consult latest standard for details. Selected materials also conform to NACE MR0103 for sour refining environments.*

(2) *Selecting J5 option will provide Alloy C-276 transmitter diaphragms.*

## Country certification

Code	Description	Measurement type		
		D	1-7	
J1	Canadian Registration	•	•	
J8	Chinese certificate of special equipment type test	•	•	

## Product certifications

Code	Description	Measurement type		
		D	1-7	
E1	ATEX Flameproof	•	•	★
I1	ATEX Intrinsic Safety	•	•	★
IA <sup>(1)</sup>	ATEX FISCO Intrinsic Safety	•	•	★
N1	ATEX Type n	•	•	★
ND	ATEX Dust	•	•	★
K1	ATEX Flameproof, Intrinsic Safety, Type n, Dust (combination of E1, I1, N1, and ND)	•	•	★
I2	Brazil Intrinsic Safety	•	•	★
K2	Brazil Flameproof, Intrinsic Safety	•	•	★
IB	Brazil FISCO Intrinsic Safety	•	•	★
E4	Japan Flameproof	•	•	★
E5	USA Explosion-proof, Dust Ignition-proof	•	•	★
I5	USA Intrinsically Safe; Nonincendive	•	•	★
IE <sup>(1)</sup>	USA FISCO Intrinsic Safety	•	•	★
K5	USA Explosion-proof, Dust Ignition-proof, Intrinsically Safe, Division 2 (combination of E5 and I5)	•	•	★
E6 <sup>(2)</sup>	Canada Explosion-proof, Dust Ignition-proof, Division 2	•	•	★
I6	Canada Intrinsically Safe	•	•	★
IF <sup>(1)</sup>	Canada FISCO Intrinsic Safety	•	•	★
K6 <sup>(2)</sup>	Canada Explosion-proof, Dust Ignition-proof, Intrinsically Safe, Division 2 (combination of E6 and I6)	•	•	★
E7	IECEX Flameproof, Dust Ignition-proof	•	•	★
I7	IECEX Intrinsic Safety	•	•	★
IG <sup>(1)</sup>	IECEX FISCO Intrinsic Safety	•	•	★
K7	IECEX Flameproof, Dust Ignition-proof, Intrinsic Safety, Type n (combination of E7, I7, and N7)	•	•	★
E3	China Flameproof	•	•	★
I3	China Intrinsic Safety	•	•	★
EP	Republic of Korea Flameproof	•	•	★
IP	Republic of Korea Intrinsic Safety	•	•	★
KP	Republic of Korea Flameproof, Intrinsic Safety	•	•	★
KA <sup>(2)</sup>	ATEX and Canada Flameproof, Intrinsically Safe, Division 2 (combination of E1, I1, E6, and I6)	•	•	★

Code	Description	Measurement type		
		D	1-7	
KB <sup>(2)</sup>	USA and Canada Explosion-proof, Dust Ignition-proof, Intrinsically Safe, Division 2 (combination of E5, E6, I5, and I6)	•	•	★
EM	Technical Regulations Customs Union (EAC) Flameproof	•	•	★
IM	Technical Regulations Customs Union (EAC) Intrinsic Safety	•	•	★
KM	Technical Regulations Customs Union (EAC) Flameproof, Intrinsic Safety	•	•	★
E2	Brazil Flameproof	•	•	★
KC	USA and ATEX Explosion-proof, Intrinsically Safe, Division 2 (combination of E5, E1, I5, and I1)	•	•	★
KD <sup>(2)</sup>	USA, Canada, and ATEX Explosion-proof, Intrinsically Safe (combination of E5, I5, E6, I6, E1, and I1)	•	•	★
KL	USA, Canada, IECEX, ATEX Intrinsic Safety Combination	•	•	★
KS	USA, Canada, IECEX, ATEX Explosion Proof, Intrinsically Safe, Dust, Non-incendive, Type N, Div. 2	•	•	★

(1) FISCO is only available with Transmitter output code F.

(2) Not available with M20 or G½ conduit entry size.

**Shipboard approvals**

Code	Description	Measurement type		
		D	1-7	
SBS	American Bureau of Shipping	•	•	★
SBV	Bureau Veritas (BV) Type Approval	•	•	★
SDN	Det Norske Veritas (DNV) Type Approval	•	•	★
SLL	Lloyds Register (LR) Type Approval	•	•	★

**Sensor fill fluid and O-ring options**

Code	Description	Measurement type		
		D	1-7	
L1	Inert sensor fill fluid	•	•	★
L2	Graphite-filled (PTFE) O-ring	•	•	★
LA	Inert sensor fill fluid and graphite-filled (PTFE) O-ring	•	•	★

**Digital display**

Not available with housing code 7J.

Code	Description	Measurement type		
		D	1-7	
M5	Plantweb™ LCD display (requires Plantweb housing)	•	•	★
M7 <sup>(1)(2)(3)</sup>	Remote mount LCD display and interface, Plantweb housing, no cable; SST bracket	•	—	★
M8 <sup>(1)(2)</sup>	Remote mount LCD display and interface, Plantweb housing, 50 ft. (15 m) cable; SST bracket	•	—	★

Code	Description	Measurement type		
		D	1-7	
M9 <sup>(1)(2)</sup>	Remote mount LCD display and interface, Plantweb housing, 100 ft. (31 m) cable; SST bracket	•	—	★

(1) Not available with transmitter output code X. Only available with measurement type D.

(2) Not available with transmitter output code F, option code DA2, or option code QT.

(3) See the Rosemount 3051S [Reference Manual](#) for cable requirements. Contact an Emerson representative for additional information.

### Transient protection

Code	Description	Measurement type		
		D	1-7	
T1	Transient terminal block <sup>(1)</sup>	•	•	★

(1) This is not available with Housing code 00, 5A, 5J, or 7J. External ground screw assembly (option code D4) is included with the T1 option. The T1 option is not needed with FISCO Product Certifications.

### Manifold for remote mount option

Code	Description	Measurement type		
		D	1-7	
F2	3-valve manifold, SST	•	•	★
F6	5-valve manifold, SST	•	•	★

### Plantweb control functionality

Code	Description	Measurement type		
		D	1-7	
A01	FOUNDATION™ Fieldbus advanced control function block suite	•	•	★

### Plantweb diagnostics functionality

Code	Description	Measurement type		
		D	1-7	
D01	FOUNDATION™ Fieldbus diagnostics suite (Process Intelligence, Plugged Impulse Line diagnostic)	•	—	★
DA2 <sup>(1)</sup>	Advanced HART® diagnostic suite (Process Intelligence, Loop Integrity, Plugged Impulse Line diagnostic, Process Alerts, Service Alerts, Variable Log, Event Log)	•	—	★

(1) Includes Hardware Adjustments (option code D1) as standard. Not available with transmitter output code X or F. Only available with measurement type D.

### Plantweb enhanced measurement functionality

Requires Rosemount Engineering Assistant to configure. To ensure correct operation, download the Engineering Assistant software at [Emerson.com/Rosemount](https://emerson.com/Rosemount).

Code	Description	Measurement type		
		D	1-7	
H01	FOUNDATION™ Fieldbus fully compensated mass flow block	•	—	★

### Cold temperature

Code	Description	Measurement type		
		D	1-7	
BRR	-58 °F (-50 °C) cold temperature start-up	—	•	★
BR6	-76 °F (-60 °C) cold temperature operation	•	—	★

### Alarm limit

Not available with transmitter output code F or X.

Code	Description	Measurement type		
		D	1-7	
C4	NAMUR alarm and saturation levels, high alarm	•	•	★
C5	NAMUR alarm and saturation levels, low alarm	•	•	★
C6	Custom alarm and saturation levels, high alarm (requires C1 and <a href="#">Configuration Data Sheet</a> )	•	•	★
C7	Custom alarm and saturation levels, low alarm (requires C1 and <a href="#">Configuration Data Sheet</a> )	•	•	★
C8	Low alarm (standard Rosemount alarm and saturation levels)	•	•	★

### Hardware adjustments and ground screw

Code	Description	Measurement type		
		D	1-7	
D1 <sup>(1)(2)(3)</sup>	Hardware adjustments (zero, span, alarm, security)	•	—	★
D4 <sup>(4)</sup>	External ground screw assembly	•	•	★
DA <sup>(1)(2)(3)</sup>	Hardware adjustments (zero, span, alarm, security) and external ground screw assembly	•	—	★

(1) Not available with output code X. Only available with measurement type D.

(2) Not available with output protocol code F.

(3) Not available with housing codes 2E, 2F, 2G, 2M, 5A, 5J, or 7J.

(4) This assembly is included with options EP, KP, E1, N1, K1, ND, E4, E7, K7, E3, KA, KC, KD, IA, T1, EM, and KM.

### Conduit plug

Code	Description	Measurement type		
		D	1-7	
DO	316 SST conduit plug	•	•	★

### Conduit electrical connector

Not available with housing code 5A, 5J, or 7J. Available with Intrinsically Safe approvals only. For FM Intrinsically Safe; Nonincendive (option code I5) or FM FISCO Intrinsically Safe (option code IE), install in accordance with Rosemount drawing 03151-1009.

Code	Description	Measurement type		
		D	1-7	
ZE	M12, 4-pin, male connector (Eurofast <sup>®</sup> )	•	•	★
ZM	A size mini, 4-pin, male connector (Minifast <sup>®</sup> )	•	•	★

## Rosemount 3051SFP Integral Orifice Flow Meter



- Precision honed pipe section for increased accuracy in small line sizes
- Self-centering plate design prevents alignment errors that magnify measurement inaccuracies in small line sizes
- Typical 3051SFP model code: **3051SFP 1 F 010 W3 S 0150 D3 1 J A 1A 3 M5**

Specification and selection of product materials, options, or components must be made by the purchaser of the equipment.

[CONFIGURE >](#) [VIEW PRODUCT >](#)

• = Available  
 — = Unavailable

### Required model components

#### Model

Code	Description	Measurement type		
		D	1-7	
3051SFP	Integral Orifice Flow Meter	•	•	★

#### Measurement type

Code	Description	Measurement type		
		D	1-7	
1	Fully compensated mass and energy flow calculations – differential and static pressures with temperature	—	•	★
2	Compensated flow calculations – differential and static pressures	—	•	★
3	Compensated flow calculations – differential pressure and temperature	—	•	★
4	Compensated flow calculations – differential pressure	—	•	★
5	Process variables only (no flow calculations) – differential and static pressures with temperature	—	•	★
6	Process variables only (no flow calculations) – differential and static pressures	—	•	★
7	Process variables only (no flow calculations) – differential pressure and temperature	—	•	★
D	Differential pressure	•	—	★

#### Material type and body

Code	Description	Measurement type		
		D	1-7	
F	316 SST, enhanced support body	•	•	★

Line size

Code	Description	Measurement type		
		D	1-7	
005	½ in. (15 mm)	•	•	★
010	1 in. (25 mm)	•	•	★
015	1½ in. (40 mm)	•	•	★

Process connection

Code	Description	Measurement type		
		D	1-7	
T1	NPT female body (not available with thermowell and RTD)	•	•	★
S1 <sup>(1)</sup>	Socket weld body (not available with thermowell and RTD)	•	•	★
P1	Pipe ends: NPT threaded	•	•	★
P2	Pipe ends: beveled	•	•	★
D1	Pipe ends: flanged, PN16 EN-1092-1 RF, slip-on	•	•	★
D2	Pipe ends: flanged, PN40 EN-1092-1 RF, slip-on	•	•	★
D3	Pipe ends: flanged, PN100 EN-1092-1 RF, slip-on	•	•	★
W1	Pipe ends: flanged, Class 150 RF ASME B16.5, weld-neck	•	•	★
W3	Pipe ends: flanged, Class 300 RF ASME B16.5, weld-neck	•	•	★
W6	Pipe ends: flanged, Class 600 RF ASME B16.5, weld-neck	•	•	★
W9	Pipe ends: flanged, Class 900 RF ASME B16.5, weld-neck	•	•	★
A1	Pipe ends: flanged, Class 150 RF ASME B16.5, slip-on	•	•	
A3	Pipe ends: flanged, Class 300 RF ASME B16.5, slip-on	•	•	
A6	Pipe ends: flanged, Class 600 RF ASME B16.5, slip-on	•	•	
R1	Pipe ends: flanged, Class 150 RTJ ASME B16.5, slip-on	•	•	
R3	Pipe ends: flanged, Class 300 RTJ ASME B16.5, slip-on	•	•	
R6	Pipe ends: flanged, Class 600 RTJ ASME B16.5, slip-on	•	•	
R9	Pipe ends: flanged, Class 900 RTJ ASME B16.5, weld-neck	•	•	

(1) To improve pipe perpendicularity for gasket sealing, socket diameter is smaller than standard pipe O.D.

Orifice plate material

Code	Description	Measurement type		
		D	1-7	
S	316/316L SST	•	•	★
H	Alloy C-276	•	•	
M	Alloy 400	•	—	

## Bore size option

Code	Description	Measurement type		
		D	1-7	
0066	0.066 in. (1.68 mm) for ½ in. pipe	•	•	★
0109	0.109 in. (2.77 mm) for ½ in. pipe	•	•	★
0160	0.160 in. (4.06 mm) for ½ in. pipe	•	•	★
0196	0.196 in. (4.98 mm) for ½ in. pipe	•	•	★
0260	0.260 in. (6.60 mm) for ½ in. pipe	•	•	★
0340	0.340 in. (8.64 mm) for ½ in. pipe	•	•	★
0150	0.150 in. (3.81 mm) for 1 in. pipe	•	•	★
0250	0.250 in. (6.35 mm) for 1 in. pipe	•	•	★
0345	0.345 in. (8.76 mm) for 1 in. pipe	•	•	★
0500	0.500 in. (12.70 mm) for 1 in. pipe	•	•	★
0630	0.630 in. (16.00 mm) for 1 in. pipe	•	•	★
0800	0.800 in. (20.32 mm) for 1 in. pipe	•	•	★
0295	0.295 in. (7.49 mm) for 1½ in. pipe	•	•	★
0376	0.376 in. (9.55 mm) for 1½ in. pipe	•	•	★
0512	0.512 in. (13.00 mm) for 1½ in. pipe	•	•	★
0748	0.748 in. (19.00 mm) for 1½ in. pipe	•	•	★
1022	1.022 in. (25.96 mm) for 1½ in. pipe	•	•	★
1184	1.184 in. (30.07 mm) for 1½ in. pipe	•	•	★
0010	0.010 in. (0.25 mm) for ½ in. pipe	•	•	
0014	0.014 in. (0.36 mm) for ½ in. pipe	•	•	
0020	0.020 in. (0.51 mm) for ½ in. pipe	•	•	
0034	0.034 in. (0.86 mm) for ½ in. pipe	•	•	
XXXX	Special bore size (X.XXX in.)	•	•	

## Transmitter connection platform

Code	Description	Measurement type		
		D	1-7	
D3	Direct mount, 3-valve manifold, SST	•	•	★
D5	Direct mount, 5-valve manifold, SST	•	•	★
R3	Remote mount, 3-valve manifold, SST	•	•	★
R5	Remote mount, 5-valve manifold, SST	•	•	★
D4 <sup>(1)</sup>	Direct mount, 3-valve manifold, Alloy C-276	•	•	
D6 <sup>(1)</sup>	Direct mount, 5-valve manifold, Alloy C-276	•	•	
R4	Remote mount, 3-valve manifold, Alloy C-276	•	•	
R6	Remote mount, 5-valve manifold, Alloy C-276	•	•	

(1) Changes the transmitter orientation of the assembly. Please refer to the D4, D6 option for C-276 manifold assembly in the product drawing.

Differential pressure range

Code	Description	Measurement type		
		D	1-7	
1	0 to 25 inH <sub>2</sub> O (0 to 62.16 mbar)	•	•	★
2	0 to 250 inH <sub>2</sub> O (0 to 621.60 mbar)	•	•	★
3	0 to 1000 inH <sub>2</sub> O (0 to 2.49 bar)	•	•	★

Static pressure range

Code	Description	Measurement type		
		D	1-7	
A <sup>(1)</sup>	None	•	•	★
D	Absolute (0 to 800 psia [0 to 55.16 bar])	—	•	★
E <sup>(2)</sup>	Absolute (0 to 3626 psia [0 to 250.0 bar])	—	•	★
J	Gage (-14.20 to 800 psig [-0.98 to 55.16 bar])	—	•	★
K <sup>(2)</sup>	Gage (-14.20 to 3626 psig [-0.98 to 250.0 bar])	—	•	★

(1) Required for measurement type codes 3, 4, 7, and D.

(2) For measurement type codes 1, 2, 5, and 6 with DP range 1, absolute limits are 0.5 to 2000 psi (0.03 to 137.9 bar) and gauge limits are -14.2 to 2000 psig (-0.98 to 137.9 bar).

Transmitter output

Code	Description	Measurement type		
		D	1-7	
A	4–20 mA with digital signal based on HART® protocol	•	•	★
F <sup>(1)</sup>	FOUNDATION™ Fieldbus protocol <sup>(2)</sup>	•	•	★
X <sup>(3)(4)</sup>	Wireless <sup>(5)</sup>	•	•	★

(1) Transmitter output code F is only available with measurement type code 1, 2, 5, 6, and D.

(2) Requires Plantweb™ housing.

(3) Only intrinsically safe approval codes apply.

(4) Only available with measurement types D and 6.

(5) Requires wireless options and Wireless Plantweb housing.

Transmitter housing style

Code	Description	Material	Conduit entry size	Measurement type		
				D	1-7	
00	None <sup>(1)</sup>	N/A	N/A	•	—	★
1A	Plantweb™ housing	Aluminum	½–14 NPT	•	•	★
1B	Plantweb housing	Aluminum	M20 x 1.5	•	•	★
1J	Plantweb housing	SST	½–14 NPT	•	•	★
1K	Plantweb housing	SST	M20 x 1.5	•	•	★
2A	Junction box housing	Aluminum	½–14 NPT	•	—	★
2B	Junction box housing	Aluminum	M20 x 1.5	•	—	★

Code	Description	Material	Conduit entry size	Measurement type		
				D	1-7	
2E	Junction box housing with output for remote display and interface	Aluminum	½-14 NPT	•	—	★
2F	Junction box housing with output for remote display and interface	Aluminum	M20 x 1.5	•	—	★
2J	Junction box housing	SST	½-14 NPT	•	—	★
2M	Junction box housing with output for remote display and interface	SST	½-14 NPT	•	—	★
5A <sup>(2)</sup>	Wireless Plantweb housing	Aluminum	½-14 NPT	•	•	★
5J <sup>(2)</sup>	Wireless Plantweb housing	SST	½-14 NPT	•	•	★
7J <sup>(3)(4)</sup>	Quick Connect (A size mini, 4-pin male termination)	N/A	N/A	•	—	★
1C	Plantweb housing	Aluminum	G½	•	•	
1L	Plantweb housing	SST	G½	•	•	
2C	Junction box housing	Aluminum	G½	•	—	
2G	Junction box housing with output for remote display and interface	Aluminum	G½	•	—	

(1) Customer-supplied electrical connection.

(2) Only available with transmitter output code X.

(3) Only intrinsically safe approval codes apply.

(4) Only available with transmitter output code A.

### Performance class

For detailed specifications, see [Specifications](#).

Code	Description	Measurement type		
		D	1-7	
<b>Measurement types 1, 2, 5, and 6</b>				
3 <sup>(1)</sup>	Ultra for Flow: 0.95% flow rate accuracy, 14:1 flow turndown, 15-year stability, 15-year limited warranty	•	•	★
5	Classic MV: 1.25% flow rate accuracy, 8:1 flow turndown, 15-year stability	—	•	★
<b>Measurement types 3, 4, 7, and D</b>				
1	Ultra: up to 1.05% flow rate accuracy, 8:1 flow turndown, 15-year stability, 15-year limited warranty	•	—	★
2	Classic: up to 1.50% flow rate accuracy, 8:1 flow turndown, 15-year stability	•	—	★
3 <sup>(1)</sup>	Ultra for Flow: 0.95% flow rate accuracy, 14:1 flow turndown, 15-year stability, 15-year limited warranty	•	•	★

(1) Only available with differential pressure ranges 2 and 3, and silicone fill fluid.

### Wireless options

#### Update rate, operating frequency and protocol

Code	Description	Measurement type		
		D	1-7	
WA3	User configurable update rate, 2.4 GHz DSSS, IEC 62591 ( <i>WirelessHART</i> ®)	•	•	★

**Omni-directional wireless antenna and SmartPower**

Long-life Power Module must be shipped separately; order Power Module 701PBKKE.

Code	Description	Measurement type		
		D	1-7	
WJ1	Remote antenna, adapter for Black Power Module (I.S. Power Module sold separately)	•	—	★
WK1	External antenna, adapter for Black Power Module (I.S. Power Module sold separately)	•	•	★
WM1	Extended range, external antenna, adapter for Black Power Module (I.S. Power Module sold separately)	•	•	★
WN1	High-gain, remote antenna, adapter for Black Power Module (I.S. Power Module sold separately)	•	•	

**Additional options**

**HART® revision configuration (requires HART Protocol output code A)**

Option HR7 configures the HART output to HART Revision 7. This option requires the selection of the Advanced Diagnostics (DA2) option. If desired, the device with this option can be field-configured to HART Revision 5 or 7.

Code	Description	Measurement type		
		D	1-7	
HR7	Configured for HART Revision 7	•	—	★

**Extended product warranty**

Code	Description	Measurement type		
		D	1-7	
WR3	3-year limited warranty	•	•	★
WR5	5-year limited warranty	•	•	★

**Transmitter/body bolt material**

Code	Description	Measurement type		
		D	1-7	
G	High temperature option (850 °F [454 °C])	•	•	

**Temperature sensor**

Thermowell material is the same as the body material.

Code	Description	Measurement type		
		D	1-7	
T	Thermowell and RTD	•	•	★

**Optional connection**

Code	Description	Measurement type		
		D	1-7	
G1	DIN 19213 transmitter connection	•	•	★

**Pressure testing**

Code	Description	Measurement type		
		D	1-7	
P1	Hydrostatic testing with certificate <sup>(1)</sup>	•	•	

(1) Does not apply to process connection codes T1 and S1. Option P1 may not be ordered in combination with P2.

**Special cleaning**

Code	Description	Measurement type		
		D	1-7	
P2	Cleaning for special processes	•	•	

**Material testing**

Code	Description	Measurement type		
		D	1-7	
V1	Dye penetrant exam	•	•	

**Material examination**

Code	Description	Measurement type		
		D	1-7	
V2	Radiographic examination <sup>(1)</sup>	•	•	

(1) Available only with process connection code W1, W3, and W6.

**Flow calibration**

Code	Description	Measurement type		
		D	1-7	
WD	Discharge coefficient verification <sup>(1)</sup>	•	•	

(1) This is not available for bore sizes 0010, 0014, 0020, 0034, 0066, or 0109. This option does not apply to process connection codes T1 and S1.

**Special inspection**

Code	Description	Measurement type		
		D	1-7	
QC1	Visual and dimensional inspection with certificate	•	•	★
QC7	Inspection and performance certificate	•	•	★

**Material traceability certification**

Code	Description	Measurement type		
		D	1-7	
Q8	Material traceability certificate per EN 10204:2004 3.1	•	•	★

**Positive material identification (PMI)**

Code	Description	Measurement type		
		D	1-7	
Q76	PMI verification and certificate	•	•	★

**Code conformance**

Not available with DIN process connection codes D1, D2, or D3.

Code	Description	Measurement type		
		D	1-7	
J2 <sup>(1)</sup>	ANSI/ASME B31.1	•	•	
J3 <sup>(1)</sup>	ANSI/ASME B31.3	•	•	

<sup>(1)</sup> Changes the transmitter orientation of the assembly. For more information, refer to the J2, J3 options for B31 compliant assembly in the product drawing.

### Material conformance

Materials of construction comply with metallurgical requirements within NACE MR0175/ISO 15156 for sour oil field production environments. Environmental limits apply to certain materials. Consult latest standard for details. Selected materials also conform to NACE MR0103 for sour refining environments.

Selecting J5 option will provide Alloy C-276 transmitter diaphragms.

Code	Description	Measurement type		
		D	1-7	
J5	Certificate of Compliance to NACE MR0175/ISO 15156 for wetted materials	•	•	

### Country certification

Code	Description	Measurement type		
		D	1-7	
J6	European Pressure Directive (PED)	•	•	★
J1	Canadian Registration	•	•	

### Transmitter calibration certification

Code	Description	Measurement type		
		D	1-7	
Q4	Calibration certificate for transmitter	•	•	★

### Quality certification for safety

For option code A: 4–20 mA HART® only. Not available with housing code 7J.

Code	Description	Measurement type		
		D	1-7	
QT	Safety certified to IEC 61508 with certificate of FMEDA data	•	—	★

### Product certifications

Code	Description	Measurement type		
		D	1-7	
E1	ATEX Flameproof	•	•	★
I1	ATEX Intrinsic Safety	•	•	★
IA <sup>(1)</sup>	ATEX FISCO Intrinsic Safety	•	•	★
N1	ATEX Type n	•	•	★
ND	ATEX Dust	•	•	★
K1	ATEX Flameproof, Intrinsic Safety, Type n, Dust (combination of E1, I1, N1, and ND)	•	•	★
I2	Brazil Intrinsic Safety	•	•	★
IB	Brazil FISCO Intrinsic Safety	•	•	★
K2	Brazil Flameproof, Intrinsic Safety	•	•	★
E4	Japan Flameproof	•	•	★

Code	Description	Measurement type		
		D	1-7	
E5	USA Explosion-proof, Dust Ignition-proof	•	•	★
I5	USA Intrinsically Safe; Nonincendive	•	•	★
IE <sup>(1)</sup>	USA FISCO Intrinsic Safety	•	•	★
K5	USA Explosion-proof, Dust Ignition-proof, Intrinsically Safe, Division 2 (combination of E5 and I5)	•	•	★
E6 <sup>(2)</sup>	Canada Explosion-proof, Dust Ignition-proof, Division 2	•	•	★
I6	Canada Intrinsically Safe	•	•	★
IF <sup>(1)</sup>	Canada FISCO Intrinsic Safety	•	•	★
K6 <sup>(2)</sup>	Canada Explosion-proof, Dust Ignition-proof, Intrinsically Safe, Division 2 (combination of E6 and I6)	•	•	★
E7	IECEX Flameproof, Dust Ignition-proof	•	•	★
I7	IECEX Intrinsic Safety	•	•	★
IG <sup>(1)</sup>	IECEX FISCO Intrinsic Safety	•	•	★
N7	IECEX Type n	•	•	★
K7	IECEX Flameproof, Dust Ignition-proof, Intrinsic Safety, Type n (combination of E7, I7, and N7)	•	•	★
E3	China Flameproof	•	•	★
I3	China Intrinsic Safety	•	•	★
EP	Republic of Korea Flameproof	•	•	★
IP	Republic of Korea Intrinsic Safety	•	•	★
KP	Republic of Korea Flameproof, Intrinsic Safety	•	•	★
KA <sup>(2)</sup>	ATEX and Canada Flameproof, Intrinsically Safe, Division 2 (combination of E1, I1, E6, and I6)	•	•	★
KB <sup>(2)</sup>	USA and Canada Explosion-proof, Dust Ignition-proof, Intrinsically Safe, Division 2 (combination of E5, E6, I5, and I6)	•	•	★
EM	Technical Regulations Customs Union (EAC) Flameproof	•	•	★
IM	Technical Regulations Customs Union (EAC) Intrinsic Safety	•	•	★
KM	Technical Regulations Customs Union (EAC) Flameproof, Intrinsic Safety	•	•	★
E2	Brazil Flameproof	•	•	★
KC	USA and ATEX Explosion-proof, Intrinsically Safe, Division 2 (combination of E5, E1, I5, and I1)	•	•	★
KD <sup>(2)</sup>	USA, Canada, and ATEX Explosion-proof, Intrinsically Safe (combination of E5, I5, E6, I6, E1, and I1)	•	•	★

(1) FISCO is only available with Transmitter output code F.

(2) Not available with M20 or G½ conduit entry size.

**Shipboard approvals**

Code	Description	Measurement type		
		D	1-7	
SBS	American Bureau of Shipping	•	•	★
SBV	Bureau Veritas (BV) Type Approval	•	•	★
SDN	Det Norske Veritas (DNV) Type Approval	•	•	★
SLL	Lloyds Register (LR) Type Approval	•	•	★

### Sensor fill fluid and O-ring options

Code	Description	Measurement type		
		D	1-7	
L1	Inert sensor fill fluid	•	•	★
L2	Graphite-filled (PTFE) O-ring	•	•	★
LA	Inert sensor fill fluid and graphite-filled (PTFE) O-ring	•	•	★

### Digital display

Not available with housing code 7J.

Code	Description	Measurement type		
		D	1-7	
M5	Plantweb™ LCD display <sup>(1)</sup>	•	•	★
M7 <sup>(2)(3)(4)</sup>	Remote mount LCD display and interface, Plantweb housing, no cable, SST bracket	•	—	★
M8 <sup>(3)(4)</sup>	Remote mount LCD display and interface, Plantweb housing, 50 ft. (15 m) cable, SST bracket	•	—	★
M9 <sup>(3)(4)</sup>	Remote mount LCD display and interface, Plantweb housing, 100 ft. (31 m) cable, SST bracket	•	—	★

(1) Requires Plantweb housing.

(2) See the Rosemount 3051S [Reference Manual](#) for cable requirements. Contact an Emerson representative for additional information.

(3) Not available with output code F, option code DA2, or option code QT.

(4) Not available with output code X.

### Transient protection

This is not available with Housing code 00, 5A, 5J, or 7J. External ground screw assembly (option code D4) is included with the T1 option. The T1 option is not needed with FISCO Product Certifications.

Code	Description	Measurement type		
		D	1-7	
T1	Transient terminal block	•	•	★
T2	Terminal block with WAGO spring clamp terminals	•	•	★
T3	Transient terminal block with WAGO spring clamp terminals	•	•	★

### Plantweb control functionality

Code	Description	Measurement type		
		D	1-7	
A01	FOUNDATION™ Fieldbus advanced control function block suite	•	•	★

### Plantweb diagnostics functionality

Code	Description	Measurement type		
		D	1-7	
D01	FOUNDATION™ Fieldbus diagnostics suite (Process Intelligence, Plugged Impulse Line diagnostic)	•	—	★

Code	Description	Measurement type		
		D	1-7	
DA2 <sup>(1)</sup>	Advanced HART® diagnostic suite (Process Intelligence, Loop Integrity, Plugged Impulse Line diagnostic, Process Alerts, Service Alerts, Variable Log, Event Log)	•	—	★

(1) Includes Hardware Adjustments (option code D1) as standard. Not available with transmitter output code X or F. Only available with measurement type D.

**Plantweb enhanced measurement functionality**

Requires Rosemount Engineering Assistant to configure. To ensure correct operation, download the Engineering Assistant software at [Emerson.com/Rosemount](https://emerson.com/Rosemount).

Code	Description	Measurement type		
		D	1-7	
H01	FOUNDATION™ Fieldbus fully compensated mass flow block	•	—	★

**Cold temperature**

Code	Description	Measurement type		
		D	1-7	
BRR	-58 °F (-50 °C) cold temperature start-up	—	•	★
BR6	-76 °F (-60 °C) cold temperature operation	•	—	★

**Alarm limit**

Not available with transmitter output code F or X.

Code	Description	Measurement type		
		D	1-7	
C4	NAMUR alarm and saturation levels, high alarm	•	—	★
C5	NAMUR alarm and saturation levels, low alarm	•	—	★
C6	Custom alarm and saturation levels, high alarm (requires C1 and <a href="#">Configuration Data Sheet</a> )	•	—	★
C7	Custom alarm and saturation levels, low alarm (requires C1 and <a href="#">Configuration Data Sheet</a> )	•	—	★
C8	Low alarm (standard Rosemount alarm and saturation levels)	•	—	★

**Hardware adjustments and ground screw**

Code	Description	Measurement type		
		D	1-7	
D1 <sup>(1)(2)(3)</sup>	Hardware adjustments (zero, span, alarm, security)	•	—	★
D4 <sup>(4)</sup>	External ground screw assembly	•	•	★
DA <sup>(1)(2)(3)</sup>	Hardware adjustments (zero, span, alarm, security) and external ground screw assembly	•	•	★

- (1) Not available with transmitter output code X. Only available with measurement type D.
- (2) Not available with transmitter output code F.
- (3) Not available with housing codes 2E, 2F, 2G, 2M, 5A, 5j, or 7J.
- (4) This assembly is included with options E1, E2, E3, E4,E7, EM, EP, K1, K2, K6, K7, KA, KC, KD, KP, KM, N1, N3, N7, ND, and T1.

**Conduit plug**

Code	Description	Measurement type		
		D	1-7	
DO	316 SST conduit plug	•	•	★

**Conduit electrical connector**

This is not available with housing code 5A, 5J, or 7J. Available with intrinsically Safe approvals only. For FM intrinsically Safe; Nonincendive (option code I5) or FM FISCO Intrinsically Safe (option code IE), install in accordance with Rosemount drawing 03151-1009.

Code	Description	Measurement type		
		D	1-7	
GE	M12, 4-pin, male connector (Eurofast®)	•	•	
GM	A size mini, 4-pin, male connector (Minifast®)	•	•	

# Specifications

## Performance specification

Performance assumptions include: measured pipe ID, transmitter is trimmed for optimum flow accuracy, and performance is dependent on application parameters.

### Multivariable flow performance

**Note**

Measurement types 2–4 assume the unmeasured variables are constant. Additional uncertainty will depend on the variation in the unmeasured variables.

**Note**

Range 1 flow meters experience an additional uncertainty up to 0.9%. Consult your Emerson representative for exact specifications.

**Table 1: Flow performance - Flow reference accuracy**

Accuracy over range of use is always application dependent.

Mass, energy, actual volumetric, and totalized flow reference accuracy <sup>(1)</sup>		
Models	Ultra for flow	Classic MV <sup>(2)</sup>
<b>Annubar Flow Meter (3051SFA)</b>		
Ranges 2-3	±0.80% of flow rate at 14:1 flow turndown	±1.15% of flow rate at 8:1 flow turndown
<b>Compact Annubar Flow Meter (3051SFC_A)</b>		
Ranges 2-3		
Standard	±1.55% of flow rate at 14:1 flow turndown	±1.60% of flow rate at 8:1 flow turndown
Calibrated	±0.80% of flow rate at 14:1 flow turndown	±1.00% of flow rate at 8:1 flow turndown
<b>Compact Conditioning Orifice Flow Meter (3051SFC_C)</b>		
Ranges 2-3		
$\beta = 0.4$	±0.75% of flow rate at 14:1 flow turndown	±1.10% of flow rate at 8:1 flow turndown
$\beta = 0.50, 0.65$	±1.15% of flow rate at 14:1 flow turndown	±1.45% of flow rate at 8:1 flow turndown
<b>Compact Orifice Flow Meter(3051SFC_P)<sup>(3)</sup></b>		
Ranges 2-3	±1.30% of flow rate at 14:1 flow turndown	±1.45% of flow rate at 8:1 flow turndown
<b>Integral Orifice Flow Meter (3051SFP)</b>		
Ranges 2-3		
Bore < 0.160	±2.55% of flow rate at 14:1 flow turndown	±2.65% of flow rate at 8:1 flow turndown
0.160 ≤ Bore < 0.500	±1.55% of flow rate at 14:1 flow turndown	±1.70% of flow rate at 8:1 flow turndown
0.500 ≤ Bore ≤ 1.000	±1.05% of flow rate at 14:1 flow turndown	±1.25% of flow rate at 8:1 flow turndown
1.000 < Bore	±1.55% of flow rate at 14:1 flow turndown	±1.70% of flow rate at 8:1 flow turndown

(1) Energy, actual volumetric, and totalized flow not available with transmitter output code F.

(2) Differential pressure calibrated at up to 1/10th full scale for optimum flow accuracy/rangeability.

(3) For line sizes less than 2 in. (50 mm) or greater than 8 in. (200 mm) add an additional 0.5% uncertainty.

## Uncompensated flow performance

**Note**

For measurement types 5-7, refer to the reference accuracy specification for the Rosemount 3051SMV with measurement type P.

**Note**

These flow measurement accuracies assume a constant density, viscosity, and expansibility factor.

**Note**

Range 1 flow meters experience an additional uncertainty up to 0.9%. Consult your Emerson representative for exact specifications.

Flow performance specifications assume the device only uses DP readings without pressure and temperature compensation.

Models	Ultra	Classic	Ultra for flow
<b>Annubar flow meter (3051SFA)</b>			
Ranges 2-3	±0.95% of flow rate at 8:1 flow turndown	±1.25% of flow rate at 8:1 flow turndown	±0.80% of flow rate at 14:1 flow turndown
<b>Compact annubar flow meter (3051SFC_A)</b>			
Ranges 2-3			
Standard	±1.65% of flow rate at 8:1 flow turndown	±1.70% of flow rate at 8:1 flow turndown	±1.55% of flow rate at 14:1 flow turndown
Calibrated	±0.95% of flow rate at 8:1 flow turndown	±1.25% of flow rate at 8:1 flow turndown	±0.80% of flow rate at 14:1 flow turndown
<b>Compact conditioning orifice flow meter (3051SFC_C)</b>			
Ranges 2-3			
$\beta = 0.4$	±0.90% of flow rate at 8:1 flow turndown	±1.10% of flow rate at 8:1 flow turndown	±0.75% of flow rate at 14:1 flow turndown
$\beta = 0.50, 0.65$	±1.25% of flow rate at 8:1 flow turndown	±1.40% of flow rate at 8:1 flow turndown	±1.15% of flow rate at 14:1 flow turndown
<b>Compact orifice flow meter(3051SFC_P)<sup>(1)</sup></b>			
Ranges 2-3	±1.35% of flow rate at 8:1 flow turndown	±1.80% of flow rate at 8:1 flow turndown	±1.30% of flow rate at 14:1 flow turndown
<b>Integral orifice flow meter (3051SFP)</b>			
Ranges 2-3			
Bore < 0.160	±2.65% of flow rate at 8:1 flow turndown	±2.70% of flow rate at 8:1 flow turndown	±2.60% of flow rate at 14:1 flow turndown
0.160 ≤ Bore < 0.500	±1.70% of flow rate at 8:1 flow turndown	±1.80% of flow rate at 8:1 flow turndown	±1.60% of flow rate at 14:1 flow turndown
0.500 ≤ Bore ≤ 1.000	±1.25% of flow rate at 8:1 flow turndown	±1.35% of flow rate at 8:1 flow turndown	±1.15% of flow rate at 14:1 flow turndown
1.000 < Bore	±1.70% of flow rate at 8:1 flow turndown	±1.80% of flow rate at 8:1 flow turndown	±1.60% of flow rate at 14:1 flow turndown

(1) For line sizes less than 2 in. (50 mm) or greater than 8 in. (200 mm), add an additional 5% uncertainty.

**Long term stability**

Models		Ultra, Enhanced, and Ultra for flow <sup>(1)</sup>	Classic and Classic MV
3051SMV_3,4	Ranges 2-5	±0.15% of URL for 15 years; for ±50 °F (28 °C) temperature changes, up to 1000 psi (68.95 bar) line pressure	±0.20% of URL for 15 years; for ±50 °F (28 °C) temperature changes, up to 1000 psi (68.95 bar) line pressure
3051SF_D,3,4	Ranges 2-5		
3051SMV_1,2	DP Ranges 2-5		
3051SF_1,2	AP and GP Ranges 3-4		

(1) *Ultra is only available for Rosemount 3051S, 3051SMV\_3 and 4, 3051SF\_3, 4, 7, and D. Ultra for Flow is only available on 3051S\_CD ranges 2-3, 3051SMV DP ranges 2-4, and 3051SF DP ranges 2-3.*

**Process temperature**

Specifications for process temperature are for the transmitter portion only. The transmitter is compatible with any Pt 100 (100 ohm platinum) RTD. Examples of compatible RTDs include the Rosemount Series 214C RTD Temperature Sensors.

Models		
3051SMV 3051SF	RTD Interface	The greater of ±0.185 °F (0.103 °C) or 0.1% of reading per 5 years. <sup>(1)</sup>

(1) *Excludes RTD sensor stability.*

**Warranty**

**Note**

Warranty details can be found in Emerson Terms and Conditions of Sale.

Models	Ultra, Enhanced, and Ultra for flow <sup>(1)</sup>	Classic and Classic MV <sup>(2)</sup>	Optional extended warranty <sup>(3)</sup>
All Rosemount 3051S Products	15-year limited warranty	1-year limited warranty	WR3: 3-year limited warranty WR5: 5-year limited warranty

- (1) *Rosemount Ultra and Ultra for Flow transmitters have a limited warranty of 15 years from date of shipment. All other provisions of Emerson standard limited warranty remain the same.*
- (2) *Goods are warranted for 12 months from the date of initial installation or 18 months from the date of shipment by seller, whichever period expires first.*
- (3) *Rosemount extended warranties have a limited warranty of three or five years from date of shipment.*

**Dynamic performance**

**Total time response at 75 °F (24 °C), includes dead time**

**Note**

For FOUNDATION Fieldbus (output code F), add 52 ms to stated values (not including segment macro-cycle). For option code DA2, add 45 ms (nominal) to stated values.

3051SF_D	3051SF_1, 2, 5, or 6	3051SF_3, 4, or 7
DP ranges 2-5: 100 ms Range 1: 255 ms Range 0: 700 ms	DP range 1: 310 ms DP range 2: 170 ms DP range 3: 155 ms AP and GP: 240 ms	DP ranges 2-5: 145 ms DP range 1: 300 ms DP range 0: 745 ms

**Dead time**

For option code DA2, dead time is 90 milliseconds (nominal).

3051S_C and 3051SF_D	3051SMV and 3051SF_1-7
45 ms (nominal)	DP: 100 ms AP and GP: 140 ms RTD Interface: 1 s

**Sensor update rate**

**Note**

Does not apply to wireless (output code X). See “[IEC 62591 \(Wireless HART® protocol\)](#)” for wireless update rate.

3051_C and 3051SF_D	3051SMV and 3051SF_1-7
22 updates per sec.	DP: 22 updates per sec. AP and GP: 11 updates per sec. RTD Interface: 1 update per sec. Calculated variables: <sup>(1)</sup> Mass/volumetric flow rate: 22 updates per sec. Energy flow rate: 22 updates per sec. Totalized flow: 1 update per sec.

(1) Energy, Volumetric, and Totalized flow not available with transmitter output code F.

**Ambient temperature effects**

**Transmitter with Coplanar Sensor Module (Single Variable)**

**Table 2: Differential Pressure: (3051S\_CD, 3051SMV\_3 or 4)**

	Ultra per 50 °F (28 °C)	Classic per 50 °F (28 °C)	Ultra for flow <sup>(1)</sup> -40 to 185 °F (-40 to 85 °C)
Ranges 2-5 <sup>(2)</sup>	$\pm(0.009\% \text{ URL} + 0.025\% \text{ span})$ from 1:1 to 10:1; $\pm(0.018\% \text{ URL} + 0.08\% \text{ span})$ from >10:1 to 200:1	$\pm(0.0125\% \text{ URL} + 0.0625\% \text{ span})$ from 1:1 to 5:1; $\pm(0.025\% \text{ URL} + 0.125\% \text{ span})$ from >5:1 to 150:1	$\pm 0.13\%$ of reading up to 8:1 DP turndown from URL; $\pm(0.0187\% \text{ URL} + 0.13\% \text{ reading}) > 8:1$ and $\leq 100:1$ DP turndown from URL
Range 0	$\pm(0.25\% \text{ URL} + 0.05\% \text{ span})$ from 1:1 to 30:1	$\pm(0.25\% \text{ URL} + 0.05\% \text{ span})$ from 1:1 to 30:1	N/A
Range 1	$\pm(0.1\% \text{ URL} + 0.25\% \text{ span})$ from 1:1 to 50:1	$\pm(0.1\% \text{ URL} + 0.25\% \text{ span})$ from 1:1 to 50:1	N/A

(1) Ultra for Flow is only available for Rosemount 3051S\_CD Ranges 2-3 and 3051SMV DP Ranges 2-3.

(2) Use Classic specification for Rosemount 3051SMV DP Range 5 Ultra and 3051S\_CD Range 5 Ultra.

**Ambient Temperature Effect for Transmitter with Multivariable Sensor Module**

**Table 3: Differential Pressure and Static Pressure (3051SMV\_1 or 2)**

Models	Ultra for flow -40 to 185 °F (-40 to 85 °C) <sup>(1)</sup>	Classic MV Per 50 °F (28 °C)
DP Ranges 2-3 <sup>(2)</sup>	$\pm 0.13$ reading up to 8:1 DP turndown from URL; $\pm(0.13 + 0.0187[\text{URL}/\text{Reading}])\%$ reading to 100:1 DP turndown from URL	$\pm(0.0125\% \text{ URL} + 0.0625\% \text{ span})$ from 1:1 to 5:1; $\pm(0.025\% \text{ URL} + 0.125\% \text{ span})$ for >5:1 to 100:1
DP Range 2, SP Range 5	$\pm 0.35\%$ of reading less than or equal to 5:1 $\pm[0.35 + 0.050 (\text{URL}/\text{RDG})]\%$ of reading greater than 5:1	$\pm(0.025\% \text{ URL} + 0.100\% \text{ span})$ from 1:1 to 5:1 $\pm(0.025\% \text{ URL} + 0.125\% \text{ span})$ from 5:1 to 100:1

**Table 3: Differential Pressure and Static Pressure (3051SMV\_1 or 2) (continued)**

DP Range 3, SP Range 5	±0.25% of reading less than or equal to 5:1 ±[0.25 + 0.045 (URL/RDG)]% of reading greater than 5:1	±(0.025% URL + 0.0750% span) from 1:1 to 5:1 ±(0.025% URL + 0.125% span) from 5:1 to 100:1
DP Range 4	±0.130% of reading less than or equal to 3:1 ±(0.050 + 0.065 [URL/RDG])% of reading greater than 3:1	±(0.025% URL + 0.125% span) from 1:1 to 30:1 ±(0.035% URL + 0.125% span) from 30:1 to 100:1
DP Range 5	N/A	±(0.025% URL + 0.125% span) from 1:1 to 30:1 ±(0.035% URL + 0.125% span) from 30:1 to 100:1
DP Range 1	N/A	±(0.1% URL + 0.25% span) from 1:1 to 50:1
AP and GP	±(0.009% URL + 0.025% span) from 1:1 to 10:1; ±(0.018% URL + 0.08% span) for >10:1 <sup>(3)</sup>	±(0.0125% URL + 0.0625% span) from 1:1 to 10:1; ±(0.025% URL + 0.125% span) for >10:1 to 100:1

- (1) Temperature limit for 3051SMV with static pressure range 5 is -20 to 185 °F (-29 to 85 °C).
- (2) Only applies to SP ranges 3 and 4.
- (3) For DP range 4 or 5, Ultra for Flow ambient temperature effect on static pressure is ±(0.0125% URL + 0.0625% Span) from 1:1 to 10:1; ±(0.025% URL + 0.125% Span) for >10:1.

**Process temperature RTD interface**

**Table 4: Process Temperature (3051SMV\_1 or 3)**

**Note**

Lower process temperature limit for Rosemount 3051SMV static pressure range 5 is -20 °F (-28 °C).

Specifications for process temperature are for the transmitter portion only. The transmitter is compatible with any Pt 100 (100 ohm platinum) RTD. Examples of compatible RTDs include Rosemount series 214C RTD Temperature Sensors.

Classic MV Per 50 °F (28 °C)	Ultra for flow -40 to 185 °F (-40 to 85 °C)
±0.39 °F (0.216 °C) per 50 °F (28 °C)	±0.39 °F (0.216 °C) per 50 °F (28 °C)

**Line pressure effect**

**Note**

The line pressure effect specifications also apply to option code P9, where applicable.

3051S_CD 3051SMV (DP measurement only) <sup>(1)</sup>	Ultra and Ultra for flow	Classic and classic MV
<b>Zero error<sup>(2)</sup></b>		
Range 2-3 <sup>(3)</sup>	± 0.025% URL per 1000 psi (68.95 bar)	± 0.05% URL per 1000 psi (68.95 bar)
DP Range 2, SP range 5	± 0.075% of reading per 1000 psi (68.95 bar)	± 0.1% of reading per 1000 psi (68.95 bar)
DP Range 3, SP range 5	± 0.025% URL per 1000 psi (68.95 bar)	± 0.05% URL per 1000 psi (68.95 bar)
Range 0	± 0.125% URL per 100 psi (6.89 bar)	± 0.125% URL per 100 psi (6.89 bar)
Range 1	± 0.25% URL per 1000 psi (68.95 bar)	± 0.25% URL per 1000 psi (68.95 bar)
<b>Span error<sup>(4)</sup></b>		
Range 2-3 <sup>(3)</sup>	± 0.1% of reading per 1000 psi (68.95 bar)	± 0.1% of reading per 1000 psi (68.95 bar)
DP Range 2, SP range 5	± 0.2% of reading per 1000 psi (68.95 bar)	± 0.2% of reading per 1000 psi (68.95 bar)
DP Range 3, SP range 5	± 0.1% of reading per 1000 psi (68.95 bar)	± 0.1% of reading per 1000 psi (68.95 bar)
Range 0	± 0.15% of reading per 100 psi (6.89 bar)	± 0.15% of reading per 100 psi (6.89 bar)

3051S_CD 3051SMV (DP measurement only) <sup>(1)</sup>	Ultra and Ultra for flow	Classic and classic MV
Range 1	± 0.4% of reading per 1000 psi (68.95 bar)	± 0.4% of reading per 1000 psi (68.95 bar)

- (1) Lower process temperature limit for Rosemount 3051SMV static pressure range 5 is -20 °F (-28 °C).
- (2) Zero error can be removed by performing a zero trim at line pressure.
- (3) Only available with SP ranges 3 and 4.
- (4) Specifications for option code P0 are two times those shown above.

### Mounting position effects

Rosemount models	Ultra, Ultra for flow, classic and classic MV	
3051S_CD, 3051SMV_ 3 or 4, 3051SF_3, 4, 7, or D	Zero shifts up to ±1.25 inH <sub>2</sub> O (3,11 mbar), which can be zeroed span: no effect	
3051SMV_ 1 or 2 3051SF_1, 2, 5, or 6	DP sensor:	Zero shifts up to ±1.25 inH <sub>2</sub> O (3,11 mbar), which can be zeroed span: no effect
	GP/AP sensor:	Zero shifts to ±2.5 inH <sub>2</sub> O (6,22 mbar), which can be zeroed span: no effect

### Vibration effect

#### Rosemount 3051SFC

- **Vibration Structural Limits**
  - Qualified per the requirements of IEC61298-3 (2008) for field with general application or pipeline with low vibration level (10–1000 Hz test frequency range, 0.15 mm displacement peak amplitude, 20 m/s<sup>2</sup> acceleration amplitude).
  - The weight and length of the transmitter assembly shall not exceed 9.8 lb (4,45 kg) and 8.60 in. (218,44 mm).
- **Vibration Performance Specifications**
  - Less than ±0.1 percent of URL when tested per the requirements of IEC60770-1 field or pipeline with high vibration level (10–60 Hz 0.21 mm displacement peak amplitude/60–2000 Hz 3g).

#### Note

SST temperature housing is not recommended with primary element technology A in application with mechanical vibration.

#### Rosemount 3051SFA

- **Vibration Structural Limits**
  - Due to wide variation in Annubar™ flow meter models, no structural limits are specified. Please contact your local Emerson representative for application questions.
- **Vibration Performance Specifications**
  - Less than ±0.1 percent of URL when tested per the requirements of IEC60770-1 field or pipeline with high vibration level (10–60 Hz 0.21 mm displacement peak amplitude/60–2000 Hz 3g).

#### Rosemount 3051SFP

- **Vibration Structural Limits**
  - Qualified per the requirements of IEC60068-2-6 (2007) for field with general application or pipeline with low vibration level (10 to 1000 Hz test frequency range, 0.075 mm displacement peak amplitude, 10 m/s<sup>2</sup> acceleration amplitude).
  - The weight of the transmitter assembly shall not exceed 12.6 lb (5,72 kg).
- **Vibration Performance Specifications**

- Less than ±0.1 percent of URL when tested per the requirements of IEC60770-1 field or pipeline with high vibration level (10–60 Hz 0.21 mm displacement peak amplitude/60–2000 Hz 3g).

**Power supply effect**

Less than ±0.005 percent of calibrated span per volt change in voltage at the transmitter terminals

**Electromagnetic compatibility (EMC)**

Meets all industrial environment requirements of EN61326 and NAMUR NE-21. Maximum deviation < 1% Span during EMC disturbance.

**Note**

NAMUR NE-21 does not apply to Wireless (Transmitter output code X) or FOUNDATION™ Fieldbus (Transmitter output code F) or ERS configurations or junction nox or remote display (housing styles 2A-2C, 2E-2G, 2J, 2M).

**Note**

During surge event, device may exceed maximum EMC deviation limit or reset; however, device will self-recover and return to normal operation within specified start-up time.

**Note**

During ESD event, Wireless device (transmitter output code X) may exceed maximum EMC deviation limit or reset, however, device will self-recover and return to normal operation within specified start-up time.

**Note**

For devices with junction box housing or remote display (housing styles 2A-2C, 2E-2G, 2J, 2M), testing must be performed with shielded cable.

**Note**

Rosemount 3051SF Measurement Type 1, 3, 5, and 7 require shielded cable for the process temperature connection.

**Transient protection (option T1)**

Tested in accordance with IEEE C62.41.2-2002, Location Category B

- 6 kV crest (0.5 μs – 100 kHz)
- 3 kA crest (8 × 20 μs)
- 6 kV crest (1.2 × 50 μs)

**Functional specifications**

**Range and sensor limits**

**Flow meter with coplanar sensor module**

Range	DP sensor (Rosemount 3051SF_3, 4, or 7)	
	Lower (LRL)	Upper (URL)
1	0 inH <sub>2</sub> O (0 mbar)	25.00 inH <sub>2</sub> O (62,16 mbar)
2	0 inH <sub>2</sub> O (0 bar)	250.00 inH <sub>2</sub> O (621,60 mbar)
3	0 inH <sub>2</sub> O (0 bar)	1000.00 inH <sub>2</sub> O (2,48 bar)

**Flow meter with multivariable sensor module**

Range	DP sensor	
	Lower (LRL)	Upper (URL)
1	0 inH <sub>2</sub> O (0 mbar)	25.00 inH <sub>2</sub> O (62.3 mbar)
2	0 inH <sub>2</sub> O (0 mbar)	250.00 inH <sub>2</sub> O (0.62 bar)
3	0 inH <sub>2</sub> O (0 mbar)	1000.00 inH <sub>2</sub> O (2.49 bar)

**Static pressure sensor (GP/AP)**

**Table 5:**

Range	Lower (LRL)	Upper (URL) <sup>(1)</sup>
3	GP <sup>(2)(3)</sup> : -14.20 psig (-0.98 bar) AP: 0.50 psia (34.5 mbar)	GP: 800 psig (55.16 bar) AP: 800 psia (55.16 bar)
4	GP <sup>(2)(3)</sup> : -14.20 psig (-0.98 bar) AP: 0.50 psia (34.5 mbar)	GP: 3626 psig (250.0 bar) AP: 3626 psia (250.0 bar)

- (1) For SP Range 4 with DP Range 1, the URL is 2000 psi (137.9 bar).
- (2) Inert fill: minimum pressure = 1.5 psia (0.10 bar) or -13.2 psig (-0.91 bar).
- (3) Assumes atmospheric pressure of 14.7 psia (1 bar-a).

**Process Temperature RTD Interface (Rosemount 3051SF\_1, 3, 5 or 7)**

**Note**

Transmitter is compatible with any Pt 100 RTD sensor. Examples of compatible RTDs include Rosemount Series 214C RTD Temperature Sensors.

Lower (LRL)	Upper (URL)
-328 °F (-200 °C)	1562 °F (850 °C)

**Minimum span limits**

**Transmitter with coplanar sensor module (single variable)**

Range	DP sensor (Rosemount 3051SF_D, 3, 4 or 7)	
	Ultra and ultra for flow	Classic
1	0.5 inH <sub>2</sub> O (1,24 mbar)	0.5 inH <sub>2</sub> O (1,24 mbar)
2	1.25 inH <sub>2</sub> O (3,11 mbar)	1.67 inH <sub>2</sub> O (4,14 mbar)
3	1.0 inH <sub>2</sub> O (2.49 mbar)	6.67 inH <sub>2</sub> O (16,58 mbar)

**Transmitter with multivariable sensor module**

Range	DP sensor (Rosemount 3051SF_1, 2, 5, or 6)	
	Ultra for flow	Classic MV
1	N/A	0.5 inH <sub>2</sub> O (1,24 mbar)
2	1.3 inH <sub>2</sub> O (3,23 mbar)	2.5 inH <sub>2</sub> O (6,22 mbar)
3	5.0 inH <sub>2</sub> O (12,43 mbar)	10.0 inH <sub>2</sub> O (24,86 mbar)
Range	Static pressure sensor (GP/AP)	
3	4.0 psi (275,79 mbar)	8.0 psi (551,58 mbar)

Range	DP sensor (Rosemount 3051SF_1, 2, 5, or 6)	
	Ultra for flow	Classic MV
4	18.13 psi (1,25 bar)	36.26 psi (2,50 bar)

**Process temperature RTD interface (Rosemount 3051SF\_1, 3, 5 or 7)**

Minimum span = 50 °F (28 °C)

**Service**

**Rosemount 3051S, 3051SMV\_P, 3051SAM, and 3051SF\_5, 6, 7, or D (Direct Process Variable Output)**

Liquid, gas, and vapor applications

**Rosemount 3051SMV\_M and 3051SF\_1, 2, 3, or 4 (Mass and Energy Flow Output)**

**Note**

For option code A: 4-20mA HART® only.

Some fluid types are only supported by certain measurement types.

**Table 6: Fluid Compatibility with Pressure and Temperature Compensation**

• Available — Not available

Code	Measurement type	Fluid types			
		Liquids	Saturated steam	Superheated steam	Gas and natural gas
1	DP/P/T (full compensation)	•	•	•	•
2	DP/P	•	•	•	•
3	DP/T	•	•	—	—
4	DP only	•	•	—	—

**4–20 mA HART protocol**

**Zero and span adjustment**

Zero and span values can be set anywhere within the range. Span must be greater than or equal to the minimum span.

**Output**

The 2-wire 4–20 mA is user-selectable for linear or square root output. Digital process variable superimposed on 4–20 mA signal is available to any host that conforms to the HART protocol.

**Power supply**

External power supply required.

- Rosemount 3051S and 3051SF\_D: 10.5 to 42.4 Vdc with no load
- Rosemount 3051S and 3051SF\_D with Advanced HART Diagnostics Suite: 12 to 42.4 Vdc with no load
- Rosemount 3051SMV and 3051SF\_1-7: 12 to 42.4 Vdc with no load

**Load limitations**

Maximum loop resistance is determined by the voltage level of the external power supply, as described by:

**Figure 1: Rosemount 3051S and 3051SF\_D**

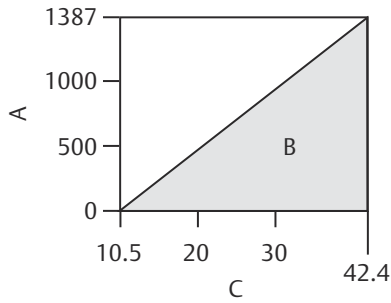

Maximum Loop Resistance =  $43.5 \times (\text{Power Supply Voltage} - 10.5)$

The Field Communicator requires a minimum loop resistance of 250 Ω for communication.

- A. Load (ohms)
- B. Operating region
- C. Voltage (Vdc)

**Figure 2: Rosemount 3051SMV and 3051SF\_1-7, 3051S and 3051SF\_D with HART® Diagnostics (option code DA2)**

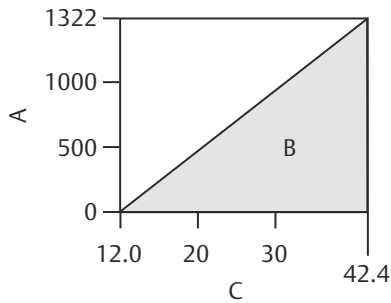

Maximum Loop Resistance =  $43.5 \times (\text{Power Supply Voltage} - 12.0)$

The Field Communicator requires a minimum loop resistance of 250 Ω for communication.

- A. Load (ohms)
- B. Operating region
- C. Voltage (Vdc)

**Selectable HART revisions (option code HR7)**

The 2-wire 4–20 mA is user-selectable for linear or square root output. Digital process variable superimposed on 4–20 mA signal is available to any host that conforms to HART protocol. The Rosemount 3051S with Advanced HART Diagnostics (DA2) comes with Selectable HART revisions. Digital communications based on HART Revision 7 (with option code HR7 selected) or Revision 5 (default) protocol can be selected. The HART revision can be switched in the field using any HART-based configuration. See the Rosemount 3051S [Reference Manual](#) for instructions on how to switch HART revision.

**Advanced HART diagnostics suite (Option Code DA2)**

The Process Intelligence diagnostic provides statistical data (standard deviation, mean, coefficient of variation) that can be used to detect process and process equipment anomalies including but not limited to:

- Furnace flame instability
- Pump cavitation
- Distillation column flooding
- Fluid composition change
- Entrained air

- Agitation loss
- Process leak

This diagnostic allows you to take preventative measures before abnormal process situations result in unscheduled downtime or rework.

The Loop Integrity diagnostic pro-actively detects and notifies you of changes in the electrical loop before they affect your process operation. Example loop problems that can be detected include water in the terminal compartment, corrosion of terminals, improper grounding, and unstable power supplies.

The Plugged Impulse Line diagnostic uses the same statistical processing technology as Process Intelligence to detect plugging in impulse piping that may prevent the transmitter from obtaining an accurate process reading. It can also detect and alert you to other process connection issues, such as plugged Annubar or orifice plate process taps.

The Device Dashboard presents the diagnostics in a graphical, task-based interface that provides single click access to critical process/device information and descriptive graphical troubleshooting.

Suite includes: Process Intelligence, Loop Integrity, Plugged Impulse Line, Status Log, Variable Log, Advanced Process Alerts, Service Alerts, and Time Stamp capability.

## FOUNDATION™ Fieldbus protocol

### Power supply

External power supply required; transmitters operate on 9.0–32.0 Vdc (9.0–17.5 Vdc for FISCO) transmitter terminal voltage.

### Current draw

17.5 mA for all configurations (including LCD display option)

Parameters:

- Schedule entries: 22 (max.)
- Links: 25 (max.)
- Virtual Communications Relationships (VCR): 20 (max.)

### Standard function blocks

<b>Resource block</b>	Contains hardware, electronics, and diagnostic information.
<b>Transducer block</b>	Contains actual sensor measurement data including the sensor diagnostics and the ability to trim the pressure sensor or recall factory defaults.
<b>LCD display block</b>	Configures the local display.
<b>Analog Input blocks</b>	Processes the measurements for input into other function blocks. The output value is in engineering or custom units and contains a status indicating measurement quality.
<b>PID block with auto-tune</b>	Contains all logic to perform PID control in the field including cascade and feedforward. Auto-tune capability allows for superior tuning for optimized control performance.

### Backup Link Active Scheduler (LAS)

The transmitter can function as a Link Active Scheduler if the current link master device fails or is removed from the segment.

### Software upgrade in the field

Software for the Rosemount 3051S with FOUNDATION Fieldbus is easy to upgrade in the field using the FOUNDATION Fieldbus Common Device Software Download procedure.

### Plantweb alerts

Enable the full power of the Plantweb digital architecture by diagnosing instrumentation issues, communicating advisory, maintenance, and failure details, and recommending a solution.

**Advanced control function block suite (option code A01)**

- Input selector block**      Selects between inputs and generates an output using specific selection strategies such as minimum, maximum, midpoint, average, or first “good.”
- Arithmetic block**      Provides pre-defined application-based equations including flow with partial density compensation, electronic remote sensors, hydrostatic tank gauging, ratio control and others.
- Signal characterizer block**      Characterizes or approximates any function that defines an input/output relationship by configuring up to twenty X, Y coordinates. The block interpolates an output value for a given input value using the curve defined by the configured coordinates.
- Integrator block**      Compares the integrated or accumulated value from one or two variables to pre-trip and trip limits and generates discrete output signals when the limits are reached. This block is useful for calculating total flow, total mass, or volume over time.
- Output splitter block**      Splits the output of one PID or other control block so that the PID will control two valves or other actuators.
- Control selector block**      Selects one of up to three inputs (highest, middle, or lowest) that are normally connected to the outputs of PID or other control function blocks.

Block	Execution time
Resource	N/A
Transducer	N/A
LCD Display Block	N/A
Analog Input 1	20 milliseconds
PID with Auto-tune	35 milliseconds
Input Selector	20 milliseconds
Arithmetic	20 milliseconds
Signal Characterizer	20 milliseconds
Integrator	20 milliseconds
Output Splitter	20 milliseconds
Control Selector	20 milliseconds

**FOUNDATION Fieldbus diagnostics suite (option code D01)**

**Note**

Only applies to Rosemount 3051S with transmitter output code F.

Process Intelligence provides statistical data (standard deviation and mean) that can be used to detect process and process equipment anomalies, including:

- furnace flame instability
- pump cavitation
- distillation column flooding
- fluid composition change
- entrained air
- agitation loss
- process leak

This diagnostic allows you to take preventative measures before abnormal process situations result in unscheduled downtime or rework.

The Plugged Impulse Line diagnostic uses the same statistical processing technology as Process Intelligence to detect plugging in impulse piping that may prevent the transmitter from obtaining an accurate process reading. It can also detect and alert you to other process connection issues, such as plugged Annubar or orifice plate process taps.

The Device Dashboard presents the diagnostics in a graphical, task-based interface that provides single click access to critical process/device information and descriptive graphical troubleshooting.

Suite includes: Process Intelligence and Plugged Impulse Line diagnostics.

## IEC 62591 (*Wireless HART*<sup>®</sup> protocol)

### Output

IEC 62591 (*Wireless HART*), 2.4 GHz DSSS

### Radio frequency power output from antenna

- External antenna (WK option): Maximum of 10 mW (10 dBm) EIRP
- Extended range, external antenna (WM option): Maximum of 18 mW (12.5 dBm) EIRP
- Remote (WJ option) antenna: Maximum of 17 mW (12.3 dBm) EIRP
- High-gain, remote antenna (WN option): Maximum of 40 mW (16 dBm) EIRP

### Local display

The optional seven-digit LCD display can display user-selectable information such as primary variable in engineering units, percent of range, sensor module temperature, and electronics temperature. The display updates based on the wireless update rate.

### Update rate

User selectable 1 second to 60 minutes.

### Power module

Field replaceable, keyed connection eliminates the risk of incorrect installation, Intrinsically Safe Lithium-thionyl chloride Power Module with Polybutadiene Terephthalate (PBT) enclosure. Ten-year life at one minute update rate.<sup>(1)(2)</sup>

## Overpressure limits

Transmitters withstand the following limits without damage:

### Coplanar sensor module (single variable)

Range	DP <sup>(1)</sup>
	3051S_CD, 3051SMV_3, or 4 3051SF_3, 4, 7, or D
1	2000 psi (137.90 bar)
2	3626 psi (250.00 bar)
3	

(1) The overpressure limit of a DP Sensor with the P9 option is 4500 psig (310,26 bar). The overpressure limit of a DP Sensor with the P0 option is 6092 psig (420,00 bar).

(1) Reference conditions are 70 °F (21 °C), and routing data for three additional network devices. Note: Continuous exposure to ambient temperature limits of -40 °F or 185 °F (-40 °C or 85 °C) may reduce specified life by less than 20 percent.  
 (2) 6.5-year life at one minute update rates when used with 3051SMV.

**Coplanar multivariable sensor module (3051SMV\_1 or 2, 3051SF\_1, 2, 5, or 6)**

DP range	Static pressure range <sup>(1)</sup>	
	3	4
1	1600 psi (110.32 bar)	2000 psi (137.90 bar)
2	1600 psi (110.32 bar)	3626 psi (250.00 bar)
3	1600 psi (110.32 bar)	3626 psi (250.00 bar)

(1) Pressure can be applied to one or both sides.

**Static pressure limits**

**Coplanar sensor module**

Operates within specifications between static line pressures of:

Range	DP sensor <sup>(1)</sup>
	3051SMV_3 or 4 3051SF_3, 4, 7, or D
1	0.5 psia to 2000 psig (0,03 to 137,90 bar)
2	0.5 psia to 3626 psig (0,03 to 250,00 bar)
3	

(1) The static pressure limit of a DP sensor with the P9 option is 4500 psig (310,26 bar). The static pressure limit of a DP Sensor with the P0 option is 6092 psig (420,00 bar).

**Coplanar multivariable sensor module (Rosemount 3051SF\_1, 2, 5, or 6)**

Operates within specifications between static line pressures of 0.5 psia (0,03 bar) and the values in the table below:

DP range	Static pressure range (GP/AP)	
	3	4
1	800 psi (55.15 bar)	2000 psi (137.90 bar)
2	800 psi (55.15 bar)	3626 psi (250.00 bar)
3	800 psi (55.15 bar)	3626 psi (250.00 bar)

**Maximum working pressure limits**

Maximum working pressure is the maximum pressure allowed for normal transmitter operation. For a differential pressure transmitter, the maximum working pressure is the static line pressure under which the transmitter can safely operate. If one side of the transmitter is exposed to the full static line pressure due to mis-valving, the transmitter will experience an output shift and must be re-zeroed. For a gauge or absolute pressure transmitter, the maximum working pressure is the same as the Upper Range Limit (URL). The maximum working pressure of transmitters with assemble-to options is limited by the lowest maximum pressure rating of the individual components.

**Table 7: Rosemount 3051S Maximum Working Pressure**

Range	3051S_CD
0	750 psi 51.7 bar 5.17 mPa
1	2000 psi 138 bar 13.8 mPa

**Table 7: Rosemount 3051S Maximum Working Pressure**  
(continued)

Range	3051S_CD
2	3626 psi 250 bar 25 mPa
3	3626 psi 250 bar 25 mPa
4	3626 psi 250 bar 25 mPa
5	3626 psi 250 bar 25 mPa

**Note**

The maximum working pressure limit of a DP Sensor with the P9 option is 4500 psig (310,26 bar). The maximum working pressure limit of a DP Sensor with the P0 option is 6092 psig (420,00 bar).

**Table 8: Rosemount 3051SMV Maximum Working Pressure**

DP range	Static pressure range (GP/AP)		
	3	4	5
1	800 psi 55.2 bar 5.52 mPa	2000 psi 138 bar 13.8 mPa	N/A
2	800 psi 55.2 bar 5.52 mPa	3626 psi 250 bar 25 mPa	6092 psi 420 bar 42.0 mPa
3	800 psi 55.2 bar 5.52 mPa	3626 psi 250 bar 25 mPa	6092 psi 420 bar 42.0 mPa
4	N/A	3626 psi 250 bar 25 mPa	6092 psi 420 bar 42.0 mPa
5	N/A	3626 psi 250 bar 25 mPa	N/A

**Burst pressure limits**

**Coplanar sensor module (3051S\_C, 3051SMV, 3051SF, 3051SAM\_\_G or A)**

10000 psig (689.47 bar)

**Temperature limit**

**Ambient**

-40 to 185 °F (-40 to 85 °C)

With LCD display<sup>(3)</sup>: -40 to 176 °F (-40 to 80 °C)  
 With option code P0: -20 to 185 °F (-28 to 85 °C)  
 With option code BR6: -76 to 185 °F (-60 to 85 °C)

### Storage

-50 to 185 °F (-46 to 85 °C)  
 With LCD display: -40 to 185 °F (-40 to 85 °C)  
 With wireless output: -40 to 185 °F (-40 to 85 °C)  
 With option code BR6: -76 to 185 °F (-60 to 85 °C)

## Process temperature limits

### Rosemount 3051SFA

<b>Direct mount transmitter</b>	500 °F (260 °C) 750 °F (398 °C) when used with a direct mount, high temperature 5-valve manifold (transmitter connection platform code 6). Maximum temperature limit for steam processes with Flange-Lok and Pak-Lok connections is 600 °F (316 °C).
<b>Remote mount transmitter</b>	1250 °F (677 °C) – Alloy C-276 sensor material (for superheated steam applications above 1,000 °F [538 °C], it is recommended that the Rosemount 585 with alloy 800H sensor material is used.) 850 °F (454 °C) – SST sensor material, Pak-Lok, Flange-Lok, or Flo-Tap models

### Rosemount 3051SFC

<b>Direct mount transmitter</b>	-40 to 450 °F (-40 to 232 °C)
<b>Remote mount transmitter</b>	-315 to 850 °F (-192 to 454 °C)

### Rosemount 3051SFP

<b>Standard (direct mount)</b>	-40 to 550 °F (-40 to 288 °C)
<b>Standard (Remote mount with PTFE O-rings)</b>	-40 to 572°F (-40 to 300°C)
<b>Extended (remote mount only with option code G)</b>	-112 to 850 °F (-80 to 454 °C)

### Note

Consult factory for all-welded design for extended temperatures.

## Humidity limits

0–100 percent relative humidity

## Turn-on time

When power is applied to the transmitter during startup, performance will be within specifications per the time period described below:

### Note

Does not apply to wireless option code X.

For option code F, device will communicate on a segment in less than 20 seconds.

(3) LCD display may not be readable and LCD display updates will be slower at temperatures below -4 °F (-20 °C).

Transmitter	Turn-on time (typical)
3051S, 3051SF_D	2 seconds
Diagnostics	5 seconds
3051SMV, 3051SF_1-7	

### Volumetric displacement

Less than 0.005 in<sup>3</sup> (0,08 cm<sup>3</sup>)

### Damping

#### Note

Does not apply to wireless option code X.

Analog output response time to a step change is user-selectable from 0 to 60 seconds for one time constant. For Rosemount 3051SMV, 3051SF\_1-7, each variable can be individually adjusted. Software damping is in addition to sensor module response time.

### Failure mode alarm

#### 4–20 mA HART® (output option code A)

If self-diagnostics detect a gross transmitter failure, the analog signal will be driven offscale to alert the user. Rosemount standard (default), NAMUR, and custom alarm levels are available (see [Alarm configuration](#)).

High or low alarm signal is software-selectable or hardware-selectable via the optional switch (option D1).

#### Alarm configuration

Configuration	High alarm	Low alarm
Default	≥ 21.75 mA	≤ 3.75 mA
NAMUR compliant <sup>(1)</sup>	≥ 22.5 mA	≤ 3.6 mA
Custom levels <sup>(2)(3)</sup>	20.2 - 23.0 mA	3.4 - 3.8 mA

(1) Analog output levels are compliant with NAMUR recommendation NE 43, see option codes C4 or C5.

(2) Low alarm must be 0.1 mA less than low saturation and high alarm must be 0.1 mA greater than high saturation.

(3) For Rosemount 3051SMV and option code DA2, low alarm custom values are 3.57 - 3.8 mA.

## Physical specifications

### Material selection

Emerson provides a variety of Rosemount products with various product options and configurations, including materials of construction that can be expected to perform well in a wide range of applications. The Rosemount product information presented is intended as a guide for the purchaser to make an appropriate selection for the application. It is the purchaser's sole responsibility to make a careful analysis of all process parameters (such as all chemical components, temperature, pressure, flow rate, abrasives, contaminants, etc.), when specifying product, materials, options, and components for the particular application. Emerson is not in a position to evaluate or guarantee the compatibility of the process fluid or other process parameters with the product, options, configuration, or materials of construction selected.

### Electrical connections

½–14 NPT, G½, and M20 × 1½ conduit. HART® interface connections fixed to terminal block for Output code A and X.

**Process connections**

<b>Coplanar sensor module (Rosemount 3051S_C, 3051SMV, or 3051SF)</b>	
Standard	¼-18 NPT on 2½ in. centers
Flange Adapters	½-14 NPT and RC½ on 2 in. (50.8 mm), 2½ in. (54.0 mm), or 2¾ in. (57.2 mm) centers

**Process-wetted parts**

**Rosemount 3051SFA wetted parts - Rosemount Annubar sensor material**

- 316 SST
- Alloy C-276

**Note**

Cage nipple is made from 304 SST.

**Rosemount 3051SFC wetted parts - material of construction**

<b>Body/plate</b>	316/316L SST 50 micro-inch Ra surface finish
<b>Manifold head/valves</b>	316 SST
<b>Flange studs and nuts</b>	Customer supplied Available as a spare part
<b>Transmitter connection studs and nuts</b>	Studs- 300 Series Stainless Steel Nuts- A194 Grade 8M.
<b>Gasket and O-rings</b>	Gaskets are customer supplied. Durlon 8500 fiber gaskets are recommended. Consult an Emerson representative for use with other gaskets. Available as a spare part

**Note**

It is recommended that gaskets and O-rings be replaced when the Rosemount 405 is disassembled.

**Rosemount 3051SFP wetted parts - material construction**

<b>Orifice plate</b>	316/316L SST Alloy C-276 Alloy 400
<b>Body</b>	A312 Gr 316/316L
<b>Pipe material (if applicable)</b>	A312 Gr 316/316L
<b>Flange</b>	A182 Gr 316/316L Flange pressure limits are per ANSI B16.5 Flange face finish per ANSI B16.5, 125 to 250 RMS
<b>Body bolts/studs</b>	300 Series Stainless Steel ASTM A193 Gr B8M Class 2 body studs provided for high temperature option code G ASTM A193 Gr B8M Class 2 body studs provided for 1-1/2-in (code 015) line size units ordered with high pressure process connection option codes W9, R9, T1, S1, or P2.
<b>Transmitter connection studs</b>	300 Series Stainless Steel

**Gaskets/O-rings**            Glass filled PTFE  
                                  Alloy X-750 provided for high temperature option code G  
                                  Gaskets and O-rings must be replaced each time the Rosemount 3051SFP is disassembled for installation or maintenance

**Coplanar sensor module (3051S\_C, 3051SMV)**

316L SST (UNS S31603), Alloy C-276 (UNS N10276), Alloy 400 (UNS N04400), Tantalum (UNS R05440), Gold-Plated Alloy 400, Gold-plated 316L SST

**Drain/vent valves**

316 SST, Alloy C-276, or Alloy 400/K-500 material

Drain vent seat: Alloy 400

Drain vent stem: Alloy K-500

**Process flanges and flange adapters**

- Plated CS
- SST: CF-8M (Cast 316 SST) per ASTM A743
- Cast C-276: CW-12MW per ASTM A494
- Cast alloy 400: M-30C per ASTM A494

**Wetted O-rings**

Glass-filled PTFE

**Non-wetted parts**

**Electronic housing**            Low-copper aluminum or CF-8M (cast version of 316 SST). Enclosures meet NEMA® type 4X, IP66, and IP68 when properly installed.  
                                  Housing material code P: PBT/PC with NEMA 4X and IP66/67/68

**Coplanar sensor module housing**    CF-3M (Cast version of 316L SST, material per ASTM-A743)

- Bolts**
- Plated CS per ASTM A449, Type 1
  - Austenitic 316 SST per ASTM F593
  - ASTM A193, Grade B7M alloy steel
  - Alloy K-500

**Sensor module fill fluid**    Silicone or inert halocarbon

**Paint**                            Polyurethane

- Cover O-rings**
- Buna-N
  - Silicone (for wireless option code X)

**Wireless antenna**            External antenna (WK/WM): PBT/PC integrated omni-directional antenna  
                                  Remote antenna (WN): Fiberglass omni-directional antenna

**Power module**                Field replaceable, keyed connection eliminates the risk of incorrect installation, Intrinsically Safe Lithium-thionyl chloride Power module with PBT enclosure.

# Product certifications

## Rosemount 3051S/3051SFx/3051S-ERS

Rev 3.11

### European Directive Information

A copy of the EU Declaration of Conformity can be found at the end of the Quick Start Guide. The most recent revision of the EU Declaration of Conformity can be found at [Emerson.com/Rosemount](https://www.emerson.com/Rosemount).

### Ordinary Location Certification

As standard, the transmitter has been examined and tested to determine that the design meets the basic electrical, mechanical, and fire protection requirements by a nationally recognized test laboratory (NRTL) as accredited by the Federal Occupational Safety and Health Administration (OSHA).

### Installing Equipment in North America

The US National Electrical Code® (NEC) and the Canadian Electrical Code (CEC) permit the use of Division marked equipment in Zones and Zone marked equipment in Divisions. The markings must be suitable for the area classification, gas, and temperature class. This information is clearly defined in the respective codes.

## USA

### E5 US Explosion-proof (XP) and Dust Ignition-proof (DIP)

**Certificate** FM16US0090

**Standards** FM Class 3600 – 2018, FM Class 3615 – 2018, FM Class 3616 – 2011, FM Class 3810 – 2018, ANSI/NEMA 250 – 2003

**Markings** XP CL I, DIV 1, GP B, C, D; DIP CL II, DIV 1, GP E, F, G; CL III; T5(-50 °C ≤ T<sub>a</sub> ≤ +85 °C); Factory Sealed; Type 4X

### I5 US Intrinsic Safety (IS) and Nonincendive (NI)

**Certificate** FM16US0089X

**Standards** FM Class 3600: 2018, FM Class 3610: 2010, FM Class 3611: 2004, FM Class 3616: 2011, FM Class 3810: 2018, ANSI/ISA-60079-0: 2013, ANSI/ISA-60079-11: 2013, ANSI/ISA-61010-1: 2004, NEMA 250: 1991 (3051SFA only) or NEMA 250: 2003

**Markings** IS CL I, DIV 1, GP A, B, C, D; CL II, DIV 1, GP E, F, G; Class III; Class 1, Zone 0 AEx ia IIC T4; NI CL 1, DIV 2, GP A, B, C, D;  
T4 (-58 °F [-50 °C] ≤ T<sub>a</sub> ≤ 158 °F [70 °C]) [HART®];  
T4 (-58 °F [-50 °C] ≤ T<sub>a</sub> ≤ 140 °F [60 °C]) [Fieldbus];  
When connected per Rosemount drawing 03151-1006; Type 4X

### Special Condition for Safe Use (X):

The Model 3051S/3051S-ERS Pressure Transmitter contains aluminum and is considered to constitute a potential risk of ignition by impact or friction. Care must be taken into account during installation and use to prevent impact and friction.

### Note

Transmitters marked with NI CL 1, DIV 2 can be installed in Division 2 locations using general Division 2 wiring methods or Nonincendive Field Wiring (NIFW). See Drawing 03151-1006.

### US Intrinsic Safety (IS) and Nonincendive (NI)

**Certificate** 1143113

**Standards** FM Class 3600: 2011, FM Class 3610: 2010, FM Class 3611: 2004, FM Class 3810: 2005, UL50E (1<sup>st</sup> Ed.)

**Markings** IS Class I/II/III, Division 1, Groups A, B, C, D, T4/ E, F, and G T 275 F (135 °C); Class I, Zone 0 AEx ia IIC T4 Ga; T4 (-58 °F [-50 °C] ≤ T<sub>a</sub> ≤ 158 °F [70 °C]) [HART®];  
T4 (-58 °F [-50 °C] ≤ T<sub>a</sub> ≤ 140 °F [60 °C]) [Fieldbus];  
When connected per Rosemount drawing 03151-1016; Type 4X

### IE US FISCO

**Certificate** FM16US0089X

**Standards** FM Class 3600 – 2011, FM Class 3610 – 2010, FM Class 3611 – 2004, FM Class 3810 – 2005, NEMA 250 – 2003

**Markings** IS CL I, DIV 1, GP A, B, C, D; T4 (-58 F [-50 °C] ≤ T<sub>a</sub> ≤ 140 F [60 °C]); when connected per Rosemount drawing 03151-1006; Type 4X

### Special Condition for Safe Use (X):

The Model 3051S/3051S-ERS Pressure Transmitter contains aluminum and is considered to constitute a potential risk of ignition by impact or friction. Care must be taken into account during installation and use to prevent impact and friction.

### US FISCO

**Certificate** 1143113

**Standards** FM Class 3600: 2011, FM Class 3610: 2010, FM Class 3611: 2004, FM Class 3810: 2005, UL50E (1<sup>st</sup> Ed.)

**Markings** IS Class I/II/III, Division 1, Groups A, B, C, D, T4/ E, F, and G T 275 F (135 °C); Class I, Zone 0 AEx ia IIC T4 Ga; T4 (-58 °F [-50 °C] ≤ T<sub>a</sub> ≤ 158 °F [70 °C]) [HART];  
T4 (-58 °F [-50 °C] ≤ T<sub>a</sub> ≤ 140 °F [60 °C]) [Fieldbus];  
When connected per Rosemount drawing 03151-1016; Type 4X

## Canada

### E6 Canada Explosion-proof, Dust Ignition-proof, and Division 2

**Certificate** 1143113

**Standards** CAN/CSA C22.2 No. 0-10, CSA Std C22.2 No. 25-1966, CSA Std C22.2 No. 30-M1986, CAN/CSA C22.2 No. 94-M91, CSA Std C22.2 No. 142-M1987, CSA Std C22.2 No. 213-M1987, ANSI/ISA 12.27.01-2003, CSA Std C22.2 No. 60529:05

**Markings** Explosion-proof Class I, Division 1, Groups B, C, D; Dust-Ignitionproof Class II, Division 1, Groups E, F, G; Class III; suitable for Class I, Zone 1, Group IIB+H2, T5; suitable for Class I, Division 2, Groups A, B, C, D; suitable for Class I, Zone 2, Group IIC, T5; when connected per Rosemount drawing 03151-1013; Type 4X

### I6 Canada Intrinsically Safe

**Certificate** 1143113

**Standards** CAN/CSA C22.2 No. 0-10, CSA Std C22.2 No. 30-M1986, CAN/CSA C22.2 No. 94-M91, CSA Std C22.2 No. 142-M1987, CSA Std C22.2 No. 157-92, ANSI/ISA 12.27.01-2003, CSA Std C22.2 No. 60529:05

**Markings** Intrinsically Safe Class I, Division 1; Groups A, B, C, D; suitable for Class 1, Zone 0, IIC, T3C; when connected per Rosemount drawing 03151-1016 [3051S] 03151-1313 [ERS]; Type 4X

### IF Canada FISCO

**Certificate** 1143113

**Standards** CAN/CSA C22.2 No. 0-10, CSA Std C22.2 No. 30-M1986, CAN/CSA C22.2 No. 94-M91, CSA Std C22.2 No. 142-M1987, CSA Std C22.2 No. 157-92, ANSI/ISA 12.27.01-2003, CSA Std C22.2 No. 60529:05

**Markings** FISCO Intrinsically Safe Class I, Division 1; Groups A, B, C, D; suitable for Class 1, Zone 0, IIC, T3C; when connected per Rosemount drawing 03151-1016 [3051S] 03151-1313 [ERS]; Type 4X

## Europe

### E1 ATEX/UKEX Flameproof

**ATEX Certificate** KEMA 00ATEX2143X

**UKEX Certificate** DEKRA 21UKEX0293X

**Standards** EN IEC 60079-0:2018, EN 60079-1:2014, EN 60079-26:2015

**Markings**  II ½ G Ex db IIC T6...T4 Ga/Gb, T6 (-60 °C ≤ T<sub>a</sub> ≤ +70 °C), T5/T4 (-60 °C ≤ T<sub>a</sub> ≤ +80 °C)

**Table 9: Process Temperature**

Temperature class	Process temperature
T6	-60 °C to +70 °C
T5	-60 °C to +80 °C
T4	-60 °C to +120 °C

### Special Conditions for Safe Use (X):

1. This device contains a thin wall diaphragm less than 1 mm thickness that forms a boundary between Category 1 (process connection) and Category 2 (all other parts of the equipment). The model code and datasheet are to be consulted for details of the diaphragm material. Installation, maintenance and use shall take into account the environmental conditions to which the diaphragm will be subjected. The manufacturer's instructions for installation and maintenance shall be followed in detail to assure safety during its expected lifetime.
2. Flameproof joints are not intended for repair.
3. Non-standard paint options may cause risk from electrostatic discharge. Avoid installations that could cause electrostatic build-up on painted surfaces, and only clean the painted surfaces with a damp cloth. If paint is ordered through a special option code, contact the manufacturer for more information.
4. Appropriate cable, glands and plugs need to be suitable for a temperature of 5 °C greater than maximum specified temperature for location where installed.

### I1 ATEX Intrinsic Safety

**Certificate** BAS01ATEX1303X

**Standards** EN IEC 60079-0: 2018, EN 60079-11: 2012

**Markings**  II 1 G Ex ia IIC T4 Ga, T4 (-60 °C ≤ T<sub>a</sub> ≤ +70 °C)

**Table 10: Input Parameters**

	U <sub>i</sub>	I <sub>i</sub>	P <sub>i</sub>	C <sub>i</sub>	L <sub>i</sub>
SuperModule	30 V	300 mA	1.0 W	30 nF	0
3051S...A; 3051SF...A; 3051SAL...C	30 V	300 mA	1.0 W	12 nF	0
3051S...F; 3051SF...F	30 V	300 mA	1.3 W	0	0
3051S ...A...M7, M8, or M9; 3051SF ...A...M7, M8, or M9; 3051SAL...C... M7, M8, or M9	30 V	300 mA	1.0 W	12 nF	60 μH
3051SAL or 3051SAM	30 V	300 mA	1.0 W	12 nF	33 μH
3051SAL...M7, M8, or M9 3051SAM...M7, M8, or M9	30 V	300 mA	1.0 W	12 nF	93 μH

**Table 10: Input Parameters (continued)**

	<b>U<sub>i</sub></b>	<b>I<sub>i</sub></b>	<b>P<sub>i</sub></b>	<b>C<sub>i</sub></b>	<b>L<sub>i</sub></b>
RTD Option for 3051SF	5 V	500 mA	0.63 W	N/A	N/A

**Special Conditions for Safe Use (X):**

1. The Model 3051S Transmitters fitted with transient protection are not capable of withstanding the 500V test as defined in Clause 6.3.13 of EN 60079-11:2012. This must be taken into account during installation.
2. The terminal pins of the Model 3051S SuperModule must be provided with a degree of protection of at least IP20 in accordance with IEC/EN 60529.
3. The Model 3051S enclosure may be made of aluminum alloy and given a protective polyurethane paint finish; however, care should be taken to protect it from impact or abrasion if located in a zone 0 area.

**IA ATEX FISCO**

**Certificate**               BAS01ATEX1303X  
**Standards**               EN IEC 60079-0: 2018, EN 60079-11: 2012  
**Markings**               ⊕ II 1 G Ex ia IIC T4 Ga, T4 (-60 °C ≤ T<sub>a</sub> ≤ +70 °C)

**Table 11: Input Parameters**

<b>Parameter</b>	<b>FISCO</b>
Voltage U <sub>i</sub>	17.5 V
Current I <sub>i</sub>	380 mA
Power P <sub>i</sub>	5.32 W
Capacitance C <sub>i</sub>	0
Inductance L <sub>i</sub>	0

**Special Conditions for Safe Use (X):**

1. The Model 3051S Transmitters fitted with transient protection are not capable of withstanding the 500 V test as defined in Clause 6.3.13 of EN 60079-11:2012. This must be taken into account during installation.
2. The terminal pins of the Model 3051S SuperModule must be provided with a degree of protection of at least IP20 in accordance with IEC/EN 60529.
3. The Model 3051S enclosure may be made of aluminum alloy and given a protective polyurethane paint finish; however, care must be taken to protect it from impact or abrasion if located in a Zone 0 area.

**ND ATEX Dust**

**Certificate**               BAS01ATEX1374X  
**Standards**               EN 60079-0: 2012+A11:2013, EN 60079-31: 2009  
**Markings**               ⊕ II 1 D Ex ta IIIC T105 °C T<sub>500</sub> 95 °C Da, (-20 °C ≤ T<sub>a</sub> ≤ +85 °C), V<sub>max</sub> = 42.4 V

**Special Conditions for Safe Use (X):**

1. Cable entries must be used which maintain the ingress protection of the enclosure to at least IP66.
2. Unused cable entries must be filled with suitable blanking plugs which maintain the ingress protection of the enclosure to at least IP66.
3. Cable entries and blanking plugs must be suitable for the ambient temperature range of the apparatus and capable of withstanding a 7 J impact test.
4. The SuperModule(s) must be securely screwed in place to maintain the ingress protection of the enclosure(s).

**N1 ATEX Type n**

<b>Certificate</b>	BAS01ATEX3304X
<b>Standards</b>	EN IEC 60079-0: 2018, EN 60079-15: 2010
<b>Markings</b>	⊕ II 3 G Ex nA IIC T5 Gc, (-40 °C ≤ T <sub>a</sub> ≤ +85 °C), V <sub>max</sub> = 45 V

**Special Condition for Safe Use (X):**

The equipment is not capable of withstanding the 500V insulation test required by clause 6.5 of EN 60079-15:2010. This must be taken into account when installing the equipment.

**Note**

RTD Assembly is not included with the 3051SFx Type n Approval.

**International****E7 IECEx Flameproof and Dust**

<b>Certificate</b>	IECEx KEM 08.0010X (Flameproof)
<b>Standards</b>	IEC 60079-0:2017, IEC 60079-1:2014, IEC 60079-26:2014
<b>Markings</b>	Ex db IIC T6...T4 Ga/Gb, T6 (-60 °C ≤ T <sub>a</sub> ≤ +70 °C), T5/T4 (-60 °C ≤ T <sub>a</sub> ≤ +80 °C)

**Table 12: Process Temperature**

Temperature class	Process temperature
T6	-60 °C to +70 °C
T5	-60 °C to +80 °C
T4	-60 °C to +120 °C

**Special Conditions for Safe Use (X):**

1. This device contains a thin wall diaphragm less than 1 mm thickness that forms a boundary between EPL Ga (process connection) and EPL Gb (all other parts of the equipment). The model code and datasheet are to be consulted for details of the diaphragm material. Installation, maintenance and use shall take into account the environmental conditions to which the diaphragm will be subjected. The manufacturer's instructions for installation and maintenance shall be followed in detail to assure safety during its expected lifetime.
2. Flameproof joints are not intended for repair.
3. Non-standard paint options may cause risk from electrostatic discharge. Avoid installations that could cause electrostatic build-up on painted surfaces, and only clean the painted surfaces with a damp cloth. If paint is ordered through a special option code, contact the manufacturer for more information.
4. Appropriate cable, glands and plugs need to be suitable for a temperature of 5 °C greater than maximum specified temperature for location where installed.

<b>Certificate</b>	IECEx BAS 09.0014X (Dust)
<b>Standards</b>	IEC 60079-0:2011, IEC 60079-31:2008
<b>Markings</b>	Ex ta IIIC T105 °C T50095 °C Da, (-20 °C ≤ T <sub>a</sub> ≤ +85 °C), V <sub>max</sub> = 42.4 V

**Special Conditions for Safe Use (X):**

1. Cable entries must be used which maintain the ingress protection of the enclosure to at least IP66.
2. Unused cable entries must be filled with suitable blanking plugs which maintain the ingress protection of the enclosure to at least IP66.

3. Cable entries and blanking plugs must be suitable for the ambient temperature range of the apparatus and capable of withstanding a 7 J impact test.
4. The 3051S SuperModule must be securely screwed in place to maintain the ingress protection of the enclosure.

**I7 IECEx Intrinsic Safety**

**Certificate**                    IECEx BAS 04.0017X  
**Standards**                    IEC 60079-0: 2017, IEC 60079-11: 2011  
**Markings**                    Ex ia IIC T4 Ga, T4 (-60 °C ≤ T<sub>a</sub> ≤ +70 °C)

**Table 13: Input Parameters**

	U <sub>i</sub>	I <sub>i</sub>	P <sub>i</sub>	C <sub>i</sub>	L <sub>i</sub>
SuperModule	30 V	300 mA	1.0 W	30 nF	0
3051S...A; 3051SF...A; 3051SAL...C	30 V	300 mA	1.0 W	12 nF	0
3051S...F; 3051SF...F	30 V	300 mA	1.3 W	0	0
3051S ...A...M7, M8, or M9; 3051SF ... A...M7, M8, or M9; 3051SAL...C... M7, M8, or M9	30 V	300 mA	1.0 W	12 nF	60 µH
3051SAL or 3051SAM	30 V	300 mA	1.0 W	12 nF	33 µH
3051SAL...M7, M8, or M9 3051SAM... M7, M8, or M9	30 V	300 mA	1.0 W	12 nF	93 µH
RTD Option for 3051SF	5 V	500 mA	0.63 W	N/A	N/A

**Special Conditions for Safe Use (X):**

1. The Model 3051S Transmitters fitted with transient protection are not capable of withstanding the 500 V test as defined in Clause 6.3.13 of EN 60079-11:2012. This must be taken into account during installation.
2. The terminal pins of the Model 3051S SuperModule must be provided with a degree of protection of at least IP20 in accordance with IEC/EN 60529.
3. The Model 3051S enclosure may be made of aluminum alloy and given a protective polyurethane paint finish; however, care should be taken to protect it from impact or abrasion if located in a zone 0 area.

**I7 IECEx Intrinsic Safety - Group I - Mining (I7 with Special A0259)**

**Certificate**                    IECEx TSA 14.0019X  
**Standards**                    IEC 60079-0: 2011, IEC 60079-11: 2011  
**Markings**                    Ex ia I Ma (-60 °C ≤ T<sub>a</sub> ≤ +70 °C)

**Table 14: Input Parameters**

	U <sub>i</sub>	I <sub>i</sub>	P <sub>i</sub>	C <sub>i</sub>	L <sub>i</sub>
SuperModule	30 V	300 mA	1.0 W	30 nF	0
3051S...A; 3051SF...A; 3051SAL...C	30 V	300 mA	1.0 W	12 nF	0
3051S...F; 3051SF...F	30 V	300 mA	1.3 W	0	0
3051S ...A...M7, M8, or M9; 3051SF ... A...M7, M8, or M9; 3051SAL...C... M7, M8, or M9	30 V	300 mA	1.0 W	12 nF	60 µH
3051SAL or 3051SAM	30 V	300 mA	1.0 W	12 nF	33 µH
3051SAL...M7, M8, or M9 3051SAM... M7, M8, or M9	30 V	300 mA	1.0 W	12 nF	93 µH

**Table 14: Input Parameters (continued)**

	$U_i$	$I_i$	$P_i$	$C_i$	$L_i$
RTD Option for 3051SF	5 V	500 mA	0.63 W	N/A	N/A

**Special Conditions for Safe Use (X):**

1. If the apparatus is fitted with optional 90 V transient suppressor, it is not capable of withstanding the 500 V insulation test required by Clause 6.3.13 of IEC60079-11. This must be taken into account when installing the apparatus.
2. It is a condition of safe use that the above input parameters shall be taken into account during installation.
3. It is a condition of manufacture that only the apparatus fitted with housing, covers and sensor module housing made out of stainless steel are used in Group I applications.

**IG IECEX FISCO**

<b>Certificate</b>	IECEX BAS 04.0017X
<b>Standards</b>	IEC 60079-0: 2017, IEC 60079-11: 2011
<b>Markings</b>	Ex ia IIC T4 Ga, T4(-60 °C ≤ T <sub>a</sub> ≤ +70 °C)

**Table 15: Input Parameters**

Parameter	FISCO
Voltage $U_i$	17.5 V
Current $I_i$	380 mA
Power $P_i$	5.32 W
Capacitance $C_i$	0
Inductance $L_i$	0

**Special Conditions for Safe Use (X):**

1. The Model 3051S Transmitters fitted with transient protection are not capable of withstanding the 500 V test as defined in Clause 6.3.13 of EN 60079-11:2012. This must be taken into account during installation.
2. The terminal pins of the Model 3051S SuperModule must be provided with a degree of protection of at least IP20 in accordance with IEC/EN 60529.
3. The Model 3051S enclosure may be made of aluminum alloy and given a protective polyurethane paint finish; however, care should be taken to protect it from impact or abrasion if located in a zone 0 area.

**IG IECEX Intrinsic Safety - Group I - Mining (IG with Special A0259)**

<b>Certificate</b>	IECEX TSA 14.0019X
<b>Standards</b>	IEC 60079-0: 2011, IEC 60079-11: 2011
<b>Markings</b>	FISCO FIELD DEVICE Ex ia I Ma, (-60 °C ≤ T <sub>a</sub> ≤ +70 °C)

**Table 16: Input Parameters**

Parameter	FISCO
Voltage $U_i$	17.5 V
Current $I_i$	380 mA
Power $P_i$	5.32 W
Capacitance $C_i$	0

**Table 16: Input Parameters**  
*(continued)*

Inductance $L_i$	0
------------------	---

**Special Conditions for Safe Use (X):**

1. If the apparatus is fitted with optional 90 V transient suppressor, it is not capable of withstanding the 500 V insulation test required by Clause 6.3.13 of IEC60079-11. This must be taken into account when installing the apparatus.
2. It is a condition of safe use that the above input parameters shall be taken into account during installation.
3. It is a condition of manufacture that only the apparatus fitted with housing, covers and sensor module housing made out of stainless steel are used in Group I applications.

**N7 IECEx Type n**

<b>Certificate</b>	IECEX BAS 04.0018X
<b>Standards</b>	IEC 60079-0: 2017, IEC 60079-15: 2010
<b>Markings</b>	Ex nA IIC T5 Gc, (-40 °C ≤ T <sub>a</sub> ≤ +85 °C)

**Special Condition for Safe Use (X):**

The equipment is not capable of withstanding the 500 V insulation test required by clause 6.5 of EN 60079-15:2010. This must be taken into account when installing the equipment.

**Brazil**

**E2 Brazil Flameproof**

<b>Certificate</b>	UL-BR 15.0393X
<b>Standards</b>	ABNT NBR IEC 60079-0:2013, ABNT NBR IEC 60079-1:2016, ABNT NBR IEC 60079-26:2016
<b>Markings</b>	Ex db IIC T6...T4 Ga/Gb, T6 (-60 °C ≤ T <sub>a</sub> ≤ +70 °C), T5/T4 (-60 °C ≤ T <sub>a</sub> ≤ +80 °C), IP66

Temperature Class	Ambient Temperature	Process Connection Temperature
<b>T6</b>	-60°C to +70°C	-60°C to +70°C
<b>T5</b>	-60°C to +80°C	-60°C to +80°C
<b>T4</b>	-60°C to +80°C	-60°C to +120°C

**Special Conditions for Safe Use (X):**

1. The device contains a thin wall diaphragm less than 1mm thick that forms a boundary between EPL Ga (process connection) and EPL Gb (all other parts of the equipment). The model code and datasheet are to be consulted for details of the diaphragm material. Installation, maintenance, and use shall take into account the environmental conditions to which the diaphragm will be subjected. The manufacturer’s instructions for maintenance shall be followed in detail to assure safety during its expected lifetime.
2. Flameproof joints are not intended for repair.
3. Non-standard paint options may cause risk from electrostatic discharge. Avoid installations that could cause electrostatic build-up on painted surfaces, and only clean the painted surfaces with a damp cloth. If paint is ordered through a special option code, contact the manufacturer for more information.

**I2/IB Brazil Intrinsic Safety/FISCO**

<b>Certificate</b>	UL-BR 15.0392X
--------------------	----------------

**Standards** ABNT NBR IEC 60079-0:2013, ABNT NBR IEC 60079-11:2013

**Markings** Ex ia IIC T4 Ga (-60 °C ≤ T<sub>a</sub> ≤ +70 °C), IP66

**Special Conditions for Safe Use (X):**

1. The surface resistivity of the antenna is greater than 1 GΩ. To avoid electrostatic charge build-up, it must not be rubbed or cleaned with solvents or a dry cloth.
2. The Model 701PBKPF Power Module may be replaced in a hazardous area. The Power Module has a surface resistivity greater than 1 GΩ and must be properly installed in the wireless device enclosure. Care must be taken during transportation to and from the point of installation to prevent electrostatic charge build-up.
3. The 3051S enclosure may be made of aluminium alloy and given a protective polyurethane paint finish; however, care must be taken to protect it from impact or abrasion if located in areas that requires EPL Ga.

**Table 17: Input Parameters**

	U <sub>i</sub>	I <sub>i</sub>	P <sub>i</sub>	C <sub>i</sub>	L <sub>i</sub>
SuperModule	30 V	300 mA	1.0 W	30 nF	0
3051S...A; 3051SF...A; 3051SAL...C	30 V	300 mA	1.0 W	12 nF	0
3051S...F; 3051SF...F	30 V	300 mA	1.3 W	0	0
3051S...F...IB; 3051SF...F...IB	17.5 V	380 mA	5.32 W	0	0
3051S ...A...M7, M8, or M9; 3051SF ...A...M7, M8, or M9; 3051SAL...C... M7, M8, or M9	30 V	300 mA	1.0 W	12 nF	60 μH
3051SAL or 3051SAM	30 V	300 mA	1.0 W	12 nF	33 μH
3051SAL... M7, M8, or M9 3051SAM... M7, M8, or M9	30 V	300 mA	1.0 W	12 nF	93 μH
RTD Option for 3051SF	5 V	500 mA	0.63 W	N/A	N/A

## China

### E3 China Flameproof and Dust Ignition-proof

**Certificate** 3051S: GYJ21.1120X  
3051SFx: GYJ21.3300X  
3051S-ERS: GYJ20.1489X

**Standards** 3051S: GB3836.1-2010, GB3836.2-2010, GB3836.20-2010, GB12476.1-2013, GB12476.5-2013  
3051SFx: GB3836.1-2010, GB3836.2-2010, GB12476.1-2013, GB 12476.5-2013  
3051S-ERS: GB3836.1-2010, GB3836.2-2010, GB3836.20-2010

**Markings** 3051S: Ex d IIC T6...T4; Ex tD A20 T105°C T50095°C; IP66  
3051SFx: Ex d IIC T4~T6 Ga/Gb; Ex tD A20 IP66 T105°C T50095°C; IP66  
3051S-ERS: Ex d IIC T4~T6 Ga/Gb

产品安全使用特殊条件

- 证书编号后缀“X”表明产品具有安全使用特殊条件: 涉及隔爆接合面的维修须联系产品制造商。
- 产品使用注意事项
  1. 用于爆炸性气体环境中, 产品使用环境温度与温度组别和介质温度的关系为:

温度组别	环境温度	过程温度
T6	-60 °C ≤ T <sub>a</sub> ≤ +70 °C	-60 °C ≤ T <sub>a</sub> ≤ +70 °C

温度组别	环境温度	过程温度
T5	$-60\text{ °C} \leq T_a \leq +80\text{ °C}$	$-60\text{ °C} \leq T_a \leq +80\text{ °C}$
T4	$-60\text{ °C} \leq T_a \leq +80\text{ °C}$	$-60\text{ °C} \leq T_a \leq +120\text{ °C}$

- 用于爆炸性粉尘环境中, 产品使用环境温度为:  $-20\text{ °C} \leq T_a \leq +85\text{ °C}$ .
- 产品外壳设有接地端子, 用户在使用时应可靠接地.
- 安装现场应不存在对产品外壳有腐蚀作用的有害气体.
- 现场安装时, 电缆引入口须选用国家指定的防爆检验机构按检验认可, 具有 Ex dIIC, Ex tD A20 IP66 防爆等级的电缆引入装置或堵封件, 冗余电缆引入口须用堵封件有效密封.
- 用于爆炸性气体环境中, 现场安装, 使用和维护必须严格遵守“断电后开盖!”的警告语. 用于爆炸性粉尘环境中, 现场安装, 使用和维护必须严格遵守“爆炸性粉尘场所严禁开盖!”的警告语.
- 用于爆炸性粉尘环境中, 产品外壳表面需保持清洁, 以防粉尘堆积, 但严禁用压缩空气吹扫.
- 用户不得自行更换该产品的零部件, 应会同产品制造商共同解决运行中出现的故障, 以杜绝损坏现象的发生.
- 产品的安装, 使用和维护应同时遵守产品使用说明书, GB3836.13-2013“爆炸性环境 第 13 部分: 设备的修理, 检修, 修复和改造”, GB3836.15-2000“爆炸性气体环境用电气设备 第 15 部分: 危险场所电气安装 (煤矿除外)”, GB3836.16-2006“爆炸性气体环境用电气设备 第 16 部分: 电气装置的检查和维护 (煤矿除外)”, GB50257-2014“电气装置安装工程爆炸和火灾危险环境电力装置施工及验收规范”和 GB15577-2007“粉尘防爆安全规程”, GB12476.2-2010“可燃性粉尘环境用电气设备 第 2 部分: 选型和安装”的有关规定.

### I3 China Intrinsic Safety

<b>Certificate</b>	3051S: GYJ21.1121X [Mfg USA, China, Singapore] 3051SFx: GYJ21.3301X [Mfg USA, China, Singapore] 3051S-ERS: GYJ21.1122X [Mfg USA, China, Singapore]
<b>Standards</b>	3051S: GB3836.1-2010, GB3836.4-2010, GB3836.20-2010 3051SFx: GB3836.1-2010, GB3836.4-2010, GB3836.20-2010 3051S-ERS: GB3836.1-2010, GB3836.4-2010, GB3836.20-2010
<b>Markings</b>	3051S : Ex ia IIC T4 Ga 3051SF: Ex ia IIC T4 Ga 3051S-ERS: Ex ia IIC T4 G

产品安全使用特殊条件:

- 证书编号后缀“X”表明产品具有安全使用特殊条件:
  - 产品外壳含有轻金属, 用于 0 区时需注意防止由于冲击或摩擦产生的点燃危险.
  - 当选择 T1 瞬态抑制端子时, 此设备不能承受 GB3836.4-2010 标准中第 6.3.12 条规定的 500 V 交流有效值试验电压的介电强度试验.
  - Transmitter output 为 X 时, 天线表面电阻大于  $1\text{ G}\Omega$ , 为了避免静电积聚, 不允许用溶剂或者干布擦拭; 电源模块表面电阻大于  $1\text{ G}\Omega$ , 如果在危险区域更换, 则需要避免静电积聚; 只能使用由原制造厂提供的 P/N 753-9220-XXXX 电池.
- 产品使用注意事项:
  - 产品使用环境温度为:
    - 用于爆炸性气体环境中, 产品使用环境温度为:  $-60\text{ °C} \leq T_a \leq +70\text{ °C}$
    - 用于爆炸性粉尘环境中, 产品使用环境温度为:  $-20\text{ °C} \leq T_a \leq +85\text{ °C}$
  2. 本安电气参数:

型号	端子	最高输入电压 $U_i$ (V)	最大输入电流 $I_i$ (mA)	最大输入功率 $P_i$ (W)	最大内部等效参数	
					$C_i$ (nF)	$L_i$ ( $\mu$ H)
3051SAL_C	+, -, CAN	30	300	1	12	0
3051SAL_C... M7/M8/M9	+, -	30	300	1	12	60
3051SAL, 3051SAM	+, -, CAN	30	300	1	12	33
3051SAL... M7/M8/M9 3051SAM... M7/M8/M9	+, -	30	300	1	12	93

变送器输出	端子	最高输入电压 $U_i$ (V)	最大输入电流 $I_i$ (mA)	最大输入功率 $P_i$ (W)	最大内部等效参数	
					$C_i$ (nF)	$L_i$ ( $\mu$ H)
Super module	+, -, CAN	30	300	1	30	0
A	+, -, CAN	30	300	1	12	0
A 配 M7, M8 或 M9 显示	+, -	30	300	1	12	60
F	+, -	30	300	1.3	0	0
FISCO	+, -	17.5	380	5.32	0	0
RTD 选项	-	5	500	0.63	-	-

注: 本安电气参数符合 GB3836.19-2010 对 FISCO 现场仪表的参数要求。

- 选择 Remote Mount 选项 M7, M8, M9 时, 电缆分布电容小于 24nF, 分布电感小于 60 $\mu$ H。
- 该产品必须与已通过防爆认证的关联设备配套共同组成本安防爆系统方可使用于爆炸性气体环境。其系统接线必须同时遵守本产品 and 所配关联设备的使用说明书要求, 接线端子不得接错。
- 用户不得自行更换该产品的零部件, 应会同产品制造商共同解决运行中出现的故障, 以杜绝损坏现象的发生。
- 用于爆炸性粉尘环境中, 电缆引入口须选用国家指定的防爆检验机构按检验认可, 具有 Ex tD A20 IP66 防爆等级的电缆引入装置或堵封件, 冗余电缆引入口须用堵封件有效密封。
- 产品的安装, 使用和维护应同时遵守产品使用说明书, GB3836.13-2013 “爆炸性环境 第 13 部分: 设备的修理, 检修, 修复和改造”, GB3836.15-2000 “爆炸性气体环境用电气设备 第 15 部分: 危险场所电气安装 (煤矿除外)”, GB3836.16-2006 “爆炸性气体环境用电气设备 第 16 部分: 电气装置的检查和维护 (煤矿除外)”, GB3836.18-2010 “爆炸性环境 第 18 部分: 本质安全系统” 和 GB50257-2014 “电气装置安装工程爆炸和火灾危险环境电力装置施工及验收规范” 和 GB15577-2007 “粉尘防爆安全规程”, GB12476.2-2010 “可燃性粉尘环境用电气设备 第 2 部分”: 选型和安装的有关规定。

### N3 China Type n

**Certificate** 3051S, 3051SHP: GYJ23.1241X  
3051SFx: GYJ23.1245X

**Markings** Ex ec IIC T5 Gc

#### 产品安全使用特殊条件

- 产品防爆合格证号后缀 “X” 代表产品安全使用有特殊条件: 产品选用瞬态保护端子板 (c 中包含 T1 选项) 时, 设备不能承受 500V 对地电压试验 1 分钟, 安装时需考虑在内。
- 产品使用注意事项
  - 产品使用环境温度范围为:  $-40\text{ }^{\circ}\text{C} \leq T_a \leq +85\text{ }^{\circ}\text{C}$ 。
  - 最高输入电压: 45V。

3. 现场安装时, 电缆引入口须选用经国家指定的防爆检验机构检验认可的, 具有 Ex eIIC Gb 或 Ex nA IIC Gc 防爆等级的电缆引入装置或堵封件, 冗余电缆引入口须用堵封件有效密封.
4. 安装现场确认无可燃性气体存在时方可维修.
5. 用户不得自行更换该产品的零部件, 应会同产品制造商共同解决运行中出现的故障, 以杜绝损坏现象的发生.
6. 产品的安装, 使用和维护应同时遵守产品使用说明书, GB3836.13-2013 “爆炸性环境 第 13 部分: 设备的修理, 检修, 修复和改造”, GB3836.15-2000 “爆炸性气体环境用电气设备 第 15 部分: 危险场所电气安装 (煤矿除外)”, GB3836.16-2006 “爆炸性气体环境用电气设备 第 16 部分: 电气装置的检查和维护 (煤矿除外)”, GB50257-2014 “电气装置安装工程爆炸和火灾危险环境电力装置施工及验收规范” 的有关规定.

## Technical Regulation Custom Union (EAC)

### EM EAC Flameproof and Dust Ignition-proof

**Certificate** EAЭC KZ 7500525.01.01.00672  
**Markings** 0/1 Ex db IIC T6...T4 Ga/Gb X  
 Ex ta IIIC T105°C T50095°C Da X

### IM EAC Intrinsic Safety

**Certificate** EAЭC KZ 7500525.01.01.00672  
**Markings** 0Ex ia IIC T4 Ga X

### IN EAC Intrinsic Safety

**Certificate:** EAЭC KZ 7500525.01.01.00672  
**Markings:** 0Ex ia IIC T4 Ga X

## Japan

### E4 Japan Flameproof

**Certificate** CML 17JPN1147X  
**Markings** Ex db IIC T6...T4 Ga/Gb

Temperature class	Ambient temperature	Process temperature
T6	-60 to +70 °C	-60 to +70 °C
T5	-60 to +80 °C	-60 to +80 °C
T4	-60 to +80 °C	-60 to +120 °C

### Special Conditions for Safe Use:

1. This device contains a thin wall diaphragm less than 1mm thickness that forms a boundary between EPL Ga (process connection) and EPL Gb (all other parts of the equipment). The model code and datasheet are to be consulted for details of the diaphragm material. Installation, maintenance, and use shall consider the environmental conditions to which the diaphragm will be subjected. The manufacturer’s instructions for installation and maintenance shall be followed in detail to assure safety during its expected lifetime.
2. Flameproof joints are not intended for repair.
3. Non-standard paint options may cause risk from electrostatic discharge. Avoid installations that could cause electrostatic build-up on painted surfaces, and only clean the painted surfaces with a damp cloth. If paint is ordered through a special option code, contact the manufacturer for more information.

## Republic of Korea

### EP Republic of Korea Flameproof

**Certificate** 19-KA4BO-0913X [Mfg USA], 12-KB4BO-0180X [Mfg USA], 11-KB4BO-0068X [Mfg Singapore]

**Markings** Ex d IIC T6...T4 Ga/Gb

### IP Republic of Korea Intrinsic Safety

**Certificate** 12-KB4BO-0202X [HART® – Mfg USA], 12-KB4BO-0204X [Fieldbus – Mfg USA], 19-KA4BO-0844X [HART – Mfg USA], 19-KA4BO-0845X [Fieldbus – Mfg USA], 12-KB4BO-0203X [HART – Mfg Singapore], 13-KB4BO-0296X [Fieldbus – Mfg Singapore], 19-KA4BO-0845X [Fieldbus- Mfg USA], 19-KA4BO-0844X [HART- Mfg USA]

**Markings** Ex ia IIC T4

## Combinations

<b>K1</b>	Combination of E1, I1, N1, and ND
<b>K2</b>	Combination of E2 and I2
<b>K5</b>	Combination of E5 and I5
<b>K6</b>	Combination of E6 and I6
<b>K7</b>	Combination of E7, I7, and N7
<b>KA</b>	Combination of E1, I1, E6, and I6
<b>KB</b>	Combination of E5, I5, E6, and I6
<b>KC</b>	Combination of E1, I1, E5, and I5
<b>KD</b>	Combination of E1, I1, E5, I5, E6, and I6
<b>KG</b>	Combination of IA, IE, IF, and IG
<b>KM</b>	Combination of EM and IM
<b>KP</b>	Combination of EP and IP

## Additional certifications

### SBS American Bureau of Shipping (ABS) Type Approval

**Certificate** 17-RJ1679518-PDA

**Intended Use** Measure gauge or absolute pressure of liquid, gas or vapor applications on ABS classed vessels, marine, and offshore installations.

### SBV Bureau Veritas (BV) Type Approval

**Certificate** 31910 BV

**Requirements** Bureau Veritas Rules for the Classification of Steel Ships

**Application** Class Notations: AUT-UMS, AUT-CCS, AUT-PORT and AUT-IMS.

### SDN Det Norske Veritas (DNV) Type Approval

**Certificate** TAA00000K9

**Intended Use** Det Norske Veritas' Rules for Classification of Ships, High Speed & Light Craft, and Det Norske Veritas' Offshore Standards

**Application**

Location classes	
Type	3051S
Temperature	D
Humidity	B
Vibration	A
EMC	A
Enclosure	D/IP66/IP68

**SLL Lloyds Register (LR) Type Approval**

**Certificate** LR21173788TA  
**Application** Environmental categories ENV1, ENV2, ENV3, and ENV5

**D3 Custody Transfer - Measurement Canada Accuracy Approval [3051S Only]**

**Certificate** AG-0501, AV-2380C

## Rosemount 3051S and 3051SMV Wireless

Rev 2.10

### European directive information

A copy of the EC Declaration of Conformity can be found at the end of the Quick Start Guide. The most recent revision of the EC Declaration of Conformity can be found at [Emerson.com/Rosemount](https://emerson.com/Rosemount).

### Telecommunication Compliance

All wireless devices require certification to ensure that they adhere to regulations regarding the use of the RF spectrum. Nearly every country requires this type of product certification.

Emerson is working with governmental agencies around the world to supply fully compliant products and remove the risk of violating country directives or laws governing wireless device usage.

### FCC and IC

This device complies with Part 15 of the FCC Rules. Operation is subject to the following conditions: This device may not cause harmful interference. This device must accept any interference received, including interference that may cause undesired operation. This device must be installed to ensure a minimum antenna separation distance of 20 cm from all persons.

### Ordinary location certification

As standard, the transmitter has been examined and tested to determine that the design meets the basic electrical, mechanical, and fire protection requirements by a Nationally Recognized Test Laboratory (NRTL) as accredited by the Federal Occupational Safety and Health Administration (OSHA).

### Installing Equipment in North America

The US National Electrical Code (NEC) and the Canadian Electrical Code (CEC) permit the use of Division marked equipment in Zones and Zone marked equipment in Divisions. The markings must be suitable for the area classification, gas, and temperature class. This information is clearly defined in the respective codes.

## USA

### IS USA Intrinsically Safe (IS), Nonincendive (NI), and Dust-Ignitionproof (DIP)

**Certificate** FM18US0009X

**Standards** FM Class 3600 – 2011, FM Class 3610 – 2010, FM Class 3611 – 2004, FM Class 3810 – 2005, NEMA 250 – 2003

**Markings** IS CL I, DIV 1, GP A, B, C, D; CL II, DIV 1, GP E, F, G; CL III T4; CL 1, Zone 0 AEx ia IIC T4; NI CL 1, DIV 2, GP A, B, C, D T4; DIP CL II, DIV 1, GP E, F, G; CL III, T5; T4 (-58 °F [-50 °C] ≤ T<sub>a</sub> ≤ 158 °F [70 °C])/ T5 (-58 °F -50 °C ≤ T<sub>a</sub> ≤ 185 °F [85 °C]); when connected per Rosemount drawing 03151-1000; Type 4X

### Special Conditions for Safe Use (X):

1. The Rosemount 3051S and SMV Wireless Transmitters shall only be used with the 701PBKKF Rosemount SmartPower Battery Pack (P/N 00753-9220-0001), Computational Systems Inc Battery Pack (P/N MHM-89004) or alternatively the Perpetuum Intelligent Power Module Vibration Harvester (P/N IPM71008).
2. The transmitter may contain more than 10% aluminum and is considered a potential risk of ignition by impact or friction. Care must be taken into account during installation and use to prevent impact and friction.
3. The surface resistivity of the antenna is greater than 1GΩ. To avoid electrostatic charge build-up, it must not be rubbed or cleaned with solvents or a dry cloth.

## Canada

### I6 Canada Intrinsically Safe

**Certificate** CSA 1143113

**Standards** CAN/CSA C22.2 No. 0-10, CSA Std C22.2 No. 30-M1986, CAN/CSA C22.2 No. 94-M91, CSA Std C22.2 No. 142-M1987, CSA Std C22.2 No. 157-92, ANSI/ISA 12.27.01-2003, CSA Std C22.2 No. 60529:05

**Markings** Intrinsically Safe Class I, Division 1; suitable for Class 1, Zone 0, IIC, T3C; when connected per Rosemount drawing 03151-1010; Type 4X

## Europe

### I1 ATEX Intrinsic Safety

**Certificate** Baseefa13ATEX0127X

**Standards** EN 60079-0: 2012, EN 60079-11: 2012

**Markings**  II 1 G Ex ia IIC T4 Ga, T4(-60 °C ≤ T<sub>a</sub> ≤ +70 °C)

#### Special Conditions for Safe Use (X):

1. The Rosemount 3051S Wireless and Rosemount 3051SMV Wireless enclosure may be made of aluminum alloy and given a protective polyurethane paint finish; however, care must be taken to protect it from impact or abrasion if located in a zone 0 area.
2. The surface resistivity of the antenna is greater than 1 GΩ. To avoid electrostatic charge build-up, it must not be rubbed or cleaned with solvents or dry cloth.

## International

### I7 IECEx Intrinsic Safety

**Certificate** IECEx BAS 13.0068X

**Standards** IEC 60079-0:2011, IEC 60079-11:2011

**Markings** Ex ia IIC T4 Ga, T4(-60 °C ≤ T<sub>a</sub> ≤ +70 °C)

#### Special Conditions for Safe Use (X):

1. The Rosemount 3051S Wireless and Rosemount 3051SMV Wireless enclosure may be made of aluminum alloy and given a protective polyurethane paint finish; however, care should be taken to protect it from impact or abrasion if located in a zone 0 area.
2. The surface resistivity of the antenna is greater than 1GΩ . To avoid electrostatic charge build-up, it must not be rubbed or cleaned with solvents or dry cloth.

## Brazil

### I2 Brazil Intrinsic Safety

**Certificate** UL-BR 14.0760X

**Standards** ABNT NBR IEC60079-0:2008 + Errata 1:2011, ABNT NBR IEC60079-11: 2009

**Markings** Ex ia IIC T4 Ga, T4(-60 °C ≤ T<sub>a</sub> ≤ +70 °C)

#### Special Condition for Safe Use (X):

See certificate.

## China

### I3 China Intrinsic Safety

<b>Certificate</b>	3051S Wireless: GYJ21.1121X 3051SFX: GYJ21.3301X [flow meters]
<b>Standards</b>	GB3836.1-2010, GB3836.4-2010, GB3836.20-2010
<b>Markings</b>	Ex ia IIC T4 Ga, T4(-60..70 °C)

#### Special Condition for Safe Use (X):

See appropriate certificate.

#### Note

Not currently available on the Rosemount 3051S MultiVariable Wireless Transmitter.

## Japan

### I4 CML Intrinsically Safe

<b>Certificate</b>	CML20JPN2011X
<b>Markings</b>	Ex ia IIC T4 Ga (-60 °C ≤ T <sub>a</sub> ≤ +70 °C), Ex ia IIC T5 Ga (-60 °C ≤ T <sub>a</sub> ≤ +40 °C)

## EAC – Belarus, Kazakhstan, Russia

### IM EAC Intrinsic Safety

<b>Certificate</b>	EAЭC RU C-US.AA87.B.00587-20
<b>Markings</b>	0Ex ia IIC T4 Ga X (-60 °C ≤ T <sub>a</sub> ≤ +70 °C)

#### Special Condition for Safe Use (X):

See certificate for special conditions.

## Republic of Korea

### IP Republic of Korea Intrinsic Safety

<b>Certificate</b>	12-KB4BO-0202X, 12-KB4BO-0203X
<b>Markings</b>	Ex ia IIC T4, (-60 °C ≤ T <sub>a</sub> ≤ +70 °C)

#### Special Condition for Safe Use (X):

See certificate for special conditions.

#### Note

Not currently available on the 3051S MultiVariable Wireless Transmitter.

## Combinations

<b>KQ</b>	Combination of I1, I5, and I6
-----------	-------------------------------

## Rosemount 3051SMV/3051SFX

Rev 2.14

**European directive information**

A copy of the EU Declaration of Conformity can be found at the end of the Quick Start Guide. The most recent revision of the EU Declaration of Conformity can be found at [Emerson.com/Rosemount](https://www.emerson.com/Rosemount).

**Ordinary location certification**

As standard, the transmitter has been examined and tested to determine that the design meets the basic electrical, mechanical, and fire protection requirements by a Nationally Recognized Test Laboratory (NRTL) as accredited by the Federal Occupational Safety and Health Administration (OSHA).

**Installing Equipment in North America**

The US National Electrical Code (NEC) and the Canadian Electrical Code (CEC) permit the use of Division marked equipment in Zones and Zone marked equipment in Divisions. The markings must be suitable for the area classification, gas, and temperature class. This information is clearly defined in the respective codes.

**USA****E5 US Explosionproof (XP) and Dust-Ignitionproof (DIP)**

**Certificate** FM16US0089X

**Standards** FM Class 3600 – 2011, FM Class 3615 – 2006, FM Class 3616 – 2011, FM Class 3810 – 2005, ANSI/NEMA 250 – 2003

**Markings** XP CL I, DIV 1, GP B, C, D; T5; DIP CL II, DIV 1, GP E, F, G; CL III; T5 (-58 °F [-50 °C] ≤ T<sub>a</sub> ≤ 185 °F [85 °C]); Factory Sealed; Type 4X

**I5 US Intrinsically Safe (IS) and Nonincendive (NI)**

**Certificate** FM16US0233

**Standards** FM Class 3600 – 2011, FM Class 3610 – 2007, FM Class 3611 – 2004, FM Class 3616 – 2006, FM Class 3810 – 2005, NEMA 250 – 1991

**Markings** IS CL I, DIV 1, GP A, B, C, D; CL II, DIV 1, GP E, F, G; Class III; Class 1, Zone 0 AEx ia IIC T4; NI CL 1, DIV 2, GP A, B, C, D; T4 (-58 °F [-50 °C] ≤ T<sub>a</sub> ≤ 158 °F [70 °C]) when connected per Rosemount drawing 03151-1206; Type 4X

**Note**

Transmitters marked with NI CL 1, DIV 2 can be installed in Division 2 locations using general Division 2 wiring methods or Nonincendive Field Wiring (NIFW). See [Drawing 03151-1206](https://www.emerson.com/Drawing/03151-1206).

**US Intrinsic Safety (IS) and Nonincendive (NI)**

**Certificate:** 1143113

**Standards:** FM Class 3600:2011, FM Class 3610:2010, FM Class 3611:2004, FM Class 3810:2005, UL50E (1st Ed.)

**Markings:** IS Class I/II/III, Division 1, Groups A, B, C, D, T4/ E, F, and G T135 °C; Class I, Zone 0 AEx ia IIC T4 Ga; T4 (-50 °C ≤ T<sub>a</sub> ≤ +70 °C) [HART®]; T4 (-50 °C ≤ T<sub>a</sub> ≤ +60 °C) [Fieldbus]; when connected per Rosemount drawing 03151-1207; Type 4X

**IE US FISCO Intrinsically Safe**

**Certificate** FM16US0233

**Standards** FM Class 3600 – 2011, FM Class 3610 – 2010, FM Class 3611 – 2004, FM Class 3616 – 2006, FM Class 3810 – 2005, NEMA 250 – 1991

**Markings** IS CL I, DIV 1, GP A, B, C, D; T4 (-58 °F [-50 °C] ≤ T<sub>a</sub> ≤ 158 °F [70 °C]); when connected per Rosemount drawing 03151-1006; Type 4X

**US FISCO Intrinsically Safe****Certificate:** 1143113**Standards:** FM Class 3600:2011, FM Class 3610:2010, FM Class 3611:2004, FM Class 3810:2005, UL50E (1st Ed.)**Markings:** IS Class I/II/III, Division 1, Groups A, B, C, D, T4/ E, F, and G T135 °C; Class I, Zone 0 AEx ia IIC T4 Ga;  
T4 (-50 °C ≤ T<sub>a</sub> ≤ +70 °C) [HART®];  
T4 (-50 °C ≤ T<sub>a</sub> ≤ +60 °C) [Fieldbus];  
when connected per Rosemount drawing 03151-1207; Type 4X**Canada****E6 Canada Explosionproof, Dust Ignition-proof, Division 2****Certificate** 1143113**Standards** CAN/CSA C22.2 No. 0-10, CSA Std C22.2 No. 25-1966, CSA Std C22.2 No. 30-M1986, CSA C22.2 No. 94.2-07 ,  
CSA Std C22.2 No. 213-M1987, CAN/CSA C22.2 60079-11:14, CAN/CSA-C22.2 No. 61010-1-12, ANSI/ISA  
12.27.01-2003, CSA Std C22.2 No. 60529:05 (R2010)**Markings** Explosionproof Class I, Division 1, Groups B, C, D; Dust-Ignitionproof Class II, Division 1, Groups E, F, G;  
Class III; suitable for Class I, Division 2, Groups A, B, C, D; Type 4X**I6 Canada Intrinsically Safe****Certificate** 1143113**Standards** CAN/CSA C22.2 No. 0-10, CSA Std C22.2 No. 25-1966, CSA Std C22.2 No. 30-M1986, CSA C22.2 No. 94.2-07 ,  
CSA Std C22.2 No. 213-M1987, CAN/CSA C22.2 60079-11:14, CAN/CSA-C22.2 No. 61010-1-12, ANSI/ISA  
12.27.01-2003, CSA Std C22.2 No. 60529:05 (R2010)**Markings** Intrinsically Safe Class I, Division 1; Groups A, B, C, D; suitable for Class 1, Zone 0, IIC, T3C, T<sub>a</sub> = 70 °C; when  
connected per Rosemount drawing 03151-1207; Type 4X**IF Canada FISCO Intrinsically Safe****Certificate** 1143113**Standards** CAN/CSA C22.2 No. 0-10, CSA Std C22.2 No. 25-1966, CSA Std C22.2 No. 30-M1986, CSA C22.2 No. 94.2-07 ,  
CSA Std C22.2 No. 213-M1987, CAN/CSA C22.2 60079-11:14, CAN/CSA-C22.2 No. 61010-1-12, ANSI/ISA  
12.27.01-2003, CSA Std C22.2 No. 60529:05 (R2010)**Markings** FISCO Intrinsically Safe Class I, Division 1; Groups A, B, C, D; suitable for Class I, Zone 0; T3C, T<sub>a</sub> = 70 °C;  
when installed per Rosemount drawing 03151-1207; Type 4X**Europe****E1 ATEX/UKEX Flameproof****ATEX Certificate** KEMA 00ATEX2143X**UKEX Certificate** DEKRA 21UKEX0293X**Standards** EN IEC 60079-0:2018, EN 60079-1: 2014, EN 60079-26:2015**Markings** Ex II 1/2 G Ex db IIC T6...T4 Ga/Gb, T6 (-60 °C ≤ T<sub>a</sub> ≤ +70 °C), T5/T4 (-60 °C ≤ T<sub>a</sub> ≤ +80 °C)

Temperature class	Process temperature
T6	-60 °C to +70 °C
T5	-60 °C to +80 °C
T4	-60 °C to +120 °C

**Special Conditions for Safe Use (X):**

1. This device contains a thin wall diaphragm less than 1 mm thickness that forms a boundary between Category 1 (process connection) and Category 2 (all other parts of the equipment). The model code and datasheet are to be consulted for details of the diaphragm material. Installation, maintenance, and use shall take into account the environmental conditions to which the diaphragm will be subjected. The manufacturer's instructions for installation and maintenance shall be followed in detail to assure safety during its expected lifetime.
2. Flameproof joints are not intended for repair.
3. Non-standard paint options may cause risk from electrostatic discharge. Avoid installations that could cause electrostatic build-up on painted surfaces, and only clean the painted surfaces with a damp cloth. If paint is ordered through a special option code, contact the manufacturer for more information.
4. Appropriate cable, glands, and plugs need to be suitable for a temperature of 5 °C greater than maximum specified temperature for location where installed.

**I1 ATEX Intrinsic Safety**

**Certificate** Baseefa08ATEX0064X  
**Standards** EN 60079-0:2012, EN 60079-11:2012  
**Markings** Ex II 1 G Ex ia IIC T4 Ga, T4 (-60 °C ≤ T<sub>a</sub> ≤ +70 °C)

Parameter	HART®	FOUNDATION™ Fieldbus	SuperModule™ only	RTD (for 3051SFx)	
				HART	Fieldbus
Voltage U <sub>i</sub>	30 V	30 V	7.14 V	30 V	30 V
Current I <sub>i</sub>	300 mA	300 mA	300 mA	2.31 mA	18.24 mA
Power P <sub>i</sub>	1 W	1.3 W	887 mW	17.32 mW	137 mW
Capacitance C <sub>i</sub>	14.8 nF	0	0.11 µF	0	0.8 nF
Inductance L <sub>i</sub>	0	0	0	0	1.33 mH

**Special Conditions for Safe Use (X):**

1. If the equipment is fitted with the optional 90 V transient suppressor, it is incapable of withstanding the 500 V isolation from earth test and this must be taken into account during installation.
2. The enclosure may be made of aluminum alloy and given a protective polyurethane paint finish; however, care must be taken to protect it from impact or abrasion if located in a Zone 0 environment.

**IA ATEX FISCO**

**Certificate** Baseefa08ATEX0064X  
**Standards** EN 60079-0:2012, EN 60079-11:2012  
**Markings** Ex II 1 G Ex ia IIC T4 Ga, T4 (-60 °C ≤ T<sub>a</sub> ≤ +70 °C)

Parameter	FISCO
Voltage U <sub>i</sub>	17.5 V
Current I <sub>i</sub>	380 mA
Power P <sub>i</sub>	5.32 W
Capacitance C <sub>i</sub>	0
Inductance L <sub>i</sub>	0

**ND ATEX Dust**

<b>Certificate</b>	BAS01ATEX1374X
<b>Standards</b>	EN 60079-0:2012+A11:2013, EN 60079-31:2009
<b>Markings</b>	Ex II 1 D Ex ta IIIC T105 °C T <sub>500</sub> 95 °C Da, (-20 °C ≤ T <sub>a</sub> ≤ +85 °C), V <sub>max</sub> = 42.4 V

**Special Conditions for Safe Use (X):**

1. Cable entries must be used which maintain the ingress protection of the enclosure to at least IP66.
2. Unused cable entries must be filled with suitable blanking plugs which maintain the ingress protection of the enclosure to at least IP66.
3. Cable entries and blanking plugs must be suitable for the ambient temperature range of the apparatus and capable of withstanding a 7J impact test.
4. The SuperModule(s) must be securely screwed in place to maintain the ingress protection of the enclosure(s).

**N1 ATEX Type n**

<b>Certificate</b>	Baseefa08ATEX0065X
<b>Standards</b>	EN 60079-0:2012, EN 60079-15:2010
<b>Markings</b>	Ex II 3 G Ex nA IIC T4 Gc, (-40 °C ≤ T <sub>a</sub> ≤ 70 °C), V <sub>max</sub> = 45 V

**Special Condition for Safe Use (X):**

If fitted with a 90 V transient suppressor, the equipment is not capable of withstanding the 500 V electrical strength test as defined in Clause 6.5.1 of EN 60079-15:2010. This must be taken into account during installation.

**International****E7 IECEx Flameproof and Dust**

<b>Certificate</b>	IECEX KEM 08.0010X (Flameproof)
<b>Standards</b>	IEC 60079-0:2017, IEC 60079-1:2014, IEC 60079-26:2014
<b>Markings</b>	Ex db IIC T6...T4 Ga/Gb, T6 (-60 °C ≤ T <sub>a</sub> ≤ +70 °C), T5/T4 (-60 °C ≤ T <sub>a</sub> ≤ +80 °C)

Temperature class	Process temperature
T6	-60 °C to +70 °C
T5	-60 °C to +80 °C
T4	-60 °C to +120 °C

**Special Conditions for Safe Use (X):**

1. This device contains a thin wall diaphragm less than 1 mm thickness that forms a boundary between EPL Ga (process connection) and EPL Gb (all other parts of the equipment). The model code and datasheet are to be consulted for details of the diaphragm material. Installation, maintenance and use shall take into account the environmental conditions to which the diaphragm will be subjected. The manufacturer's instructions for installation and maintenance shall be followed in detail to assure safety during its expected lifetime.
2. Flameproof joints are not intended for repair.
3. Non-standard paint options may cause risk from electrostatic discharge. Avoid installations that could cause electrostatic build-up on painted surfaces, and only clean the painted surfaces with a damp cloth. If paint is ordered through a special option code, contact the manufacturer for more information.
4. Appropriate cable, glands and plugs need to be suitable for a temperature of 5 °C greater than maximum specified temperature for location where installed.

**Certificate** IECEx BAS 09.0014X (Dust)  
**Standards** IEC 60079-0:2011, IEC 60079-31:2008  
**Markings** Ex ta IIIC T105 °C T<sub>500</sub> 95 °C Da, (-20 °C ≤ T<sub>a</sub> ≤ +85 °C), V<sub>max</sub> = 42.4 V

**Special Conditions for Safe Use (X):**

1. Cable entries must be used which maintain the ingress protection of the enclosure to at least IP66.
2. Unused cable entries must be filled with suitable blanking plugs which maintain the ingress protection of the enclosure to at least IP66.
3. Cable entries and blanking plugs must be suitable for the ambient temperature range of the apparatus and capable of withstanding a 7J impact test.
4. The Rosemount 3051S SuperModule™ must be securely screwed in place to maintain the ingress protection of the enclosure.

**I7 IECEx Intrinsic Safety**

**Certificate** IECEx BAS 08.0025X  
**Standards** IEC 60079-0:2011, IEC 60079-11:2011  
**Markings** Ex ia IIC T4 Ga, T4 (-60 °C ≤ T<sub>a</sub> ≤ +70 °C)

Parameter	HART®	FOUNDATION™ Fieldbus	SuperModule™ only	RTD (for 3051SFx)	
				HART	Fieldbus
Voltage U <sub>i</sub>	30 V	30 V	7.14 V	30 V	30 V
Current I <sub>i</sub>	300 mA	300 mA	300 mA	2.31 mA	18.24 mA
Power P <sub>i</sub>	1 W	1.3 W	887 mW	17.32 mW	137 mW
Capacitance C <sub>i</sub>	14.8 nF	0	0.11 µF	0	0.8 nF
Inductance L <sub>i</sub>	0	0	0	0	1.33 mH

**Special Conditions for Safe Use (X):**

1. If the equipment is fitted with the optional 90 V transient suppressor, it is incapable of withstanding the 500 V isolation from earth test and this must be taken into account during installation.
2. The enclosure may be made of aluminum alloy and given a protective polyurethane paint finish; however, care must be taken to protect it from impact or abrasion if located in a Zone 0 environment.

**IG IECEx FISCO**

**Certificate** IECEx BAS 08.0025X  
**Standards** IEC 60079-0:2011, IEC 60079-11:2011  
**Markings** Ex ia IIC T4 Ga, T4 (-60 °C ≤ T<sub>a</sub> ≤ +70 °C)

Parameter	FISCO
Voltage U <sub>i</sub>	17.5 V
Current I <sub>i</sub>	380 mA
Power P <sub>i</sub>	5.32 W
Capacitance C <sub>i</sub>	0
Inductance L <sub>i</sub>	0

**N7 IECEx Type n**

<b>Certificate</b>	IECEx BAS 08.0026X
<b>Standards</b>	IEC 60079-0:2011, IEC 60079-15:2010
<b>Markings</b>	Ex nA IIC T5 Gc, (-40 °C ≤ T <sub>a</sub> ≤ +70 °C)

**Special Condition for Safe Use (X):**

If fitted with a 90 V transient suppressor, the equipment is not capable of withstanding the 500 V electrical strength test as defined in Clause 6.5.1 of IEC 60079-15:2010. This must be taken into account during installation.

**Brazil**

**E2 Brazil Flameproof**

<b>Certificate</b>	UL-BR 15.0393X
<b>Standards</b>	ABNT NBR IEC 60079-0:2013, ABNT NBR IEC 60079-1:2016, ABNT NBR IEC 60079-26:2016
<b>Markings</b>	Ex db IIC T6...T4 Ga/Gb, T6 (-60 °C ≤ T <sub>a</sub> ≤ +70 °C), T5/T4 (-60 °C ≤ T <sub>a</sub> ≤ +80 °C), IP66

Temperature class	Ambient temperature	Process connection temperature
T6	-60 °C to +70 °C	-60 °C to +70 °C
T5	-60 °C to +80 °C	-60 °C to +80 °C
T4	-60 °C to +80 °C	-60 °C to +120 °C

**Special Conditions for Safe Use (X):**

1. The device contains a thin wall diaphragm less than 1 mm thick that forms a boundary between EPL Ga (process connection) and EPL Gb (all other parts of the equipment). The model code and datasheet are to be consulted for details of the diaphragm material. Installation, maintenance, and use shall take into account the environmental conditions to which the diaphragm will be subjected. The manufacturer’s instructions for maintenance shall be followed in detail to assure safety during its expected lifetime.
2. Flameproof joints are not intended for repair.
3. Non-standard paint options may cause risk from electrostatic discharge. Avoid installations that could cause electrostatic build-up on painted surfaces, and only clean the painted surfaces with a damp cloth. If paint is ordered through a special option code, contact the manufacturer for more information.

**I2 Brazil Intrinsic Safety**

<b>Certificate</b>	UL-BR 15.0357X
<b>Standards</b>	ABNT NBR IEC 60079-0:2008 + Addendum 1:2011, ABNT NBR IEC 60079-11:2009
<b>Markings</b>	Ex ia IIC T4 Ga (-60 °C ≤ T <sub>a</sub> ≤ +70 °C)

**Special Conditions for Safe Use (X):**

1. If the equipment is fitted with the optional 90 V transient suppressor, it is incapable of withstanding the 500 V isolation from earth test and this must be taken into account during installation.
2. The enclosure may be made of aluminium alloy and given a protective polyurethane paint finish; however, care must be taken to protect it from impact or abrasion if located in a Zone 0 environment, areas requiring EPL Ga.

Parameter	HART®		Fieldbus	
	Input	RTD	Input	RTD
Voltage U <sub>i</sub>	30 V	30 V	30 V	30 V

Current I <sub>i</sub>	300 mA	2.31 mA	300 mA	18.24 mA
Power P <sub>i</sub>	1 W	17.32 mW	1.3 W	137 mW
Capacitance C <sub>i</sub>	14.8 nF	0	0	0.8 nF
Inductance L <sub>i</sub>	0	0	0	1.33 mH

## China

### E3 China Flameproof and Dust Ignition-proof

<b>Certificate</b>	3051SMV: GYJ23.1243X [Mfg USA, China, Singapore] 3051SFx: GYJ21.3300X [Mfg USA, China, Singapore]
<b>Standards</b>	3051SMV: GB/T 3836.1-2021, GB/T 3836.2-2021, GB/T 3836.20-2010 3051SFx: GB3836.1-2010, GB3836.2-2010, GB12476.1-2013, GB12476.5-2013
<b>Markings</b>	3051SMV: Ex d IIC T6... T4 Ga/Gb 3051SFx: Ex d IIC T4...T6 Ga/Gb; Ex tD IP66 A20 T105°C T <sub>500</sub> 95°C

### Special Conditions for Safe Use (X):

#### 一、产品安全使用特殊条件

证书编号后缀“X”表明产品具有安全使用特殊条件:

1. 涉及隔爆接合面的维修须联系产品制造商。
2. 产品使用厚度小于 1mm 的隔膜作为 0 区（过程连接）和 1 区（产品其他部分）的隔离，安装和维护时需严格遵守制造商提供的说明书，以确保安全性。
3. 产品外部涂层可能产生静电危险，使用时须防止产生静电火花，只能用湿布清理。

#### 二、产品使用注意事项

1. 产品温度组别和使用环境温度之间的关系为:

温度组别	使用环境温度	过程温度
T6	-60 °C to +70 °C	-60 °C to +70 °C
T5	-60 °C to +80 °C	-60 °C to +80 °C
T4	-60 °C to +80 °C	-60 °C to +120 °C

2. 用于爆炸性粉尘环境中，产品使用环境温度为： $-20\text{ °C} \leq T_a \leq +85\text{ °C}$ 。
3. 产品外壳设有接地端子，用户在使用时应可靠接地。
4. 安装现场应不存在对产品外壳有腐蚀作用的有害气体。
5. 现场安装时，电缆引入口须选用经国家指定的防爆检验机构检验认可、具有 Ex dIIC Gb, Ex tD A20 IP66 防爆等级的电缆引入装置或堵封件，冗余电缆引入口须用堵封件有效密封。
6. 用于爆炸性气体环境中，现场安装、使用和维护必须严格遵守“严禁带电开盖！”的警告语。
7. 用于爆炸性粉尘环境中，产品外壳表面需保持清洁，以防粉尘堆积，但严禁用压缩空气吹扫。
8. 用户不得自行更换该产品的零部件，应会同产品制造商共同解决运行中出现的故障，以杜绝损坏现象的发生。
9. 产品的安装、使用和维护应同时遵守产品使用说明书、GB3836.13-2013“爆炸性环境 第 13 部分：设备的修理、检修、修复和改造”、GB/T3836.15-2017“爆炸性环境 第 15 部分：电气装置的设计、选型和安装”、GB/T3836.16-2017“爆炸性环境 第 16 部分：电气装置的检查与维护”和 GB50257-2014“电气装置安装工程爆炸和火灾危险环境电力装置施工及验收规范”和 GB15577-2007“粉尘防爆安全规程”、GB12476.2-2010“可燃性粉尘环境用电气设备 第 2 部分：选型和安装”的有关规定。

### I3 China Intrinsic Safety

**Certificate** 3051SMV: GYJ23.1243X [Mfg USA, China, Singapore]  
3051SFx: GYJ21.3301X [Mfg USA, China, Singapore]

**Standards** 3051SMV: GB/T 3836.1-2021, GB/T 3836.2-2021, GB/T 3836.20-2010  
3051SFx: GB3836.1-2010, GB3836.4-2010, GB3836.20-2010

**Markings** 3051SMV: Ex ia IIC T4 Ga  
3051SFx: Ex ia IIC T4 Ga;

c 输出代码	防爆标志
A, F	Ex iaIIC T4 Ga, Ex tD A20 IP66 T105 °C T500 95 °C
X	Ex iaIIC T4 Ga

#### 一、产品安全使用特殊条件

产品防爆合格证号后缀“X”代表产品安全使用有特殊条件:

1. 产品外壳含有轻金属，用于 0 区时需注意防止由于冲击或摩擦产生的点燃危险。
2. 此设备不能承受 GB3836.4-2010 标准中第 6.3.12 条规定的 500V 交流有效值试验电压的介电强度试验。
3. c 为 X 时，天线表面电阻大于 1 GΩ，为了避免静电积聚，不允许用溶剂或者干布擦拭；电源模块表面电阻大于 1 GΩ，如果在危险区域更换，则需要避免静电积聚；只能使用由原制造厂提供的 P/N 753-9220-XXXX 电池。

#### 二、产品使用注意事项

1. 用于爆炸性气体环境中，产品使用环境温度为： $-60\text{ °C} \leq T_a \leq +70\text{ °C}$  用于爆炸性粉尘环境中，产品使用环境温度为： $-20\text{ °C} \leq T_a \leq +85\text{ °C}$
2. 本安电气参数：

c 输出代码	端子	最高输入电压 $U_i$ (V)	最大输入电流 $I_i$ (mA)	最大输入功率 $P_i$ (W)	最大内部等效参数	
					$C_i$ (nF)	$L_i$ (μH)
SuperModule	+, -, CAN	30	300	1	30	0
A	+, -, CAN	30	300	1	12	0
A 配 M7、M8 或 M9 显示	+, -	30	300	1	12	60
F	+, -	30	300	1.3	0	0
FISCO	+, -	17.5	380	5.32	0	0

d 代码为 A 时

	最高输出电压 $U_o$ (V)	最大输出电流 $I_o$ (mA)	最大输出功率 $P_o$ (mW)	最大内部等效参数	
				$C_i$ (nF)	$L_i$ (μH)
RTD	30	2.31	17.32	0	0
SuperModule	7.14	300	887	110	0

注: 本安电气参数符合 GB3836.19-2010 对 FISCO 现场仪表的参数要求。

3. 选择 Remote Mount 选项 M7、M8、M9 时，电缆分布电容小于 24 nF，分布电感小于 60 μH。
4. 该产品必须与已通过防爆认证的关联设备配套共同组成本安防爆系统方可用于爆炸性气体环境。其系统接线必须同时遵守本产品和所配关联设备的使用说明书要求，接线端子不得接错。

5. 用于爆炸性粉尘环境中，电缆引入口须选用国家指定的防爆检验机构按检验认可、具有 Ex tD A20 IP66 防爆等级的电缆引入装置或堵封件，冗余电缆引入口须用堵封件有效密封。
6. 用户不得自行更换该产品的零部件，应会同产品制造商共同解决运行中出现的故障，以杜绝损坏现象的发生。
7. 产品的安装、使用和维护应同时遵守产品使用说明书、GB3836.13-2013“爆炸性环境 第 13 部分：设备的修理、检修、修复和改造”、GB/T3836.15-2017“爆炸性环境 第 15 部分：电气装置的设计、选型和安装”、GB/T3836.16-2017“爆炸性环境 第 16 部分：电气装置的检查与维护”、GB/T 3836.18-2017“爆炸性环境 第 18 部分：本质安全电气系统”、GB50257-2014“电气装置安装工程爆炸和火灾危险环境电力装置施工及验收规范” GB12476.2-2010“可燃性粉尘环境用电气设备 第 2 部分：选型和安装”的有关规定。

## EAC – Belarus, Kazakhstan, Russia

### EM Technical Regulation Customs Union (EAC) Flameproof and Dust Ignition-proof

**Certificate** EAЭC KZ 7500525.01.01.00672  
**Markings** 0/1 Ex db IIC T6...T4 Ga/Gb X  
 Ex ta IIIC T105°C T<sub>500</sub>95°C Da X

### IM Technical Regulation Customs Union (EAC) Intrinsic Safety

**Certificate** EAЭC KZ 7500525.01.01.00672  
**Markings** 0Ex ia IIC T4 Ga X

## Japan

### E4 Japan Flameproof

**Certificate** CML 17JPN1147X  
**Markings** Ex db IIC T6...T4 Ga/Gb

Temperature class	Ambient temperature	Process temperature
T6	-60 to +70 °C	-60 to +70 °C
T5	-60 to +80 °C	-60 to +80 °C
T4	-60 to +80 °C	-60 to +120 °C

### Special Conditions for Safe Use (X):

1. This device contains a thin wall diaphragm less than 1 mm thickness that forms a boundary between EPL Ga (process connection) and EPL Gb (all other parts of the equipment). The model code and datasheet are to be consulted for details of the diaphragm material. Installation, maintenance, and use shall consider the environmental conditions to which the diaphragm will be subjected. The manufacturer’s instructions for installation and maintenance shall be followed in detail to assure safety during its expected lifetime.
2. Flameproof joints are not intended for repair.
3. Non-standard paint options may cause risk from electrostatic discharge. Avoid installations that could cause electrostatic build-up on painted surfaces, and only clean the painted surfaces with a damp cloth. If paint is ordered through a special option code, contact the manufacturer for more information.

## Republic of Korea

### EP Republic of Korea Flameproof

**Certificate** 19-KA4BO-0913X [Mfg USA], 12-KB4BO-0180X [Mfg USA], 11-KB4BO-0068X [Mfg Singapore]

**Markings** Ex d IIC T6...T4 Ga/Gb

**IP Republic of Korea Intrinsic Safety [HART® Only]**

**Certificate** 10-KB4BO-0021X [Mfg SMMC], 16-KB4BO-0440X [Mfg USA], 19-KA4BO-0911X [Mfg USA]

**Markings** Ex ia IIC T4

**Combinations**

- K1** Combination of E1, I1, N1, and ND
- K2** Combination of E2 and I2
- K5** Combination of E5 and I5
- K6** Combination of E6 and I6
- K7** Combination of E7, I7, and N7
- KA** Combination of E1, I1, E6, and I6
- KB** Combination of E5, I5, E6, and I6
- KC** Combination of E1, I1, E5, and I5
- KD** Combination of E1, I1, E5, I5, E6, and I6
- KM** Combination of EM and IM
- KP** Combination of EP and IP

**Additional certifications**

**SBS American Bureau of Shipping (ABS) Type Approval**

**Certificate** 17-RJ1679518-PDA

**Intended Use** Measure gauge or absolute pressure of liquid, gas or vapor applications on ABS classed vessels, marine, and offshore installations. [HART only]

**SBV Bureau Veritas (BV) Type Approval**

**Certificate** 31910 BV

**Requirements** Bureau Veritas Rules for the Classification of Steel Ships

**Application** Class Notations: AUT-UMS, AUT-CCS, AUT-PORT and AUT-IMS. [HART only]

**SDN Det Norske Veritas (DNV) Type Approval**

**Certificate** TAA00000K9

**Intended Use** Det Norske Veritas’ Rules for Classification of Ships, High Speed and Light Craft, and Det Norske Veritas’ Offshore Standards. [HART® only]

**Application**

Location classes	
Type	3051S
Temperature	D
Humidity	B
Vibration	A
EMC	A

Enclosure	D/IP66/IP68
-----------	-------------

**SLL Lloyds Register (LR) Type Approval**

- Certificate**      LR21173788TA
- Application**    Environmental categories ENV1, ENV2, ENV3, and ENV5. [HART® only]

# Rosemount 3051CF Flow Meters

## Online product configurator

Many products are configurable online using our product configurator.

Select the **Configure** button or visit [Emerson.com/global](https://emerson.com/global) to start. With this tool's built-in logic and continuous validation, you can configure your products more quickly and accurately.

## Specifications and options

The purchaser of the equipment must specify and select the product materials, options, or components.

## Sizing and Selection Body

All Rosemount flow meters can be sized to meet your application specific requirements in the DP Flow sizing and selection tool. This tool will verify if a selected product meets your application requirements, provide a comparison between different primary elements, and generate a detailed accuracy comparison graph.

Once a sizing is completed, the configuration tool will help create a complete and valid model code to match your requirements and include any additional options or approvals.

## Optimizing lead time

The starred offerings (★) represent the most common options and should be selected for the fastest delivery times. The non-starred offerings are subject to additional delivery lead time.

## Rosemount 3051CFA Annubar™ Flow Meter



The Rosemount 3051CFA Annubar Flow Meter uses the T-shaped sensor design that delivers best in class accuracy and performance while meeting the needs of diverse process applications, whether it is high accuracy for precision control or high strength for severe flow applications.

- Up to 1.8 percent of flow rate accuracy.
- Available in 2 to 96 in. (50 to 2400 mm) line.
- Fully assembled and leak tested for out-of-the-box installation.
- Simplified flow configuration with clearly displayed flow rate and added totalizer (code M6, BLE, D1, DA1, T9, or RK).
- Loop Integrity and Plugged Impulse Line Diagnostics detect issues that might compromise the integrity of the output signal (code DA1).
- Bluetooth® enables efficient, reliable, and safe configuration and maintenance (code BLE).
- Back-lit Graphical Display with Local Language Capability (code M6).
- Safety certification and proof testing (code QT and T9).
- Typical 3051CFA model code: **3051CFA D L 060 D C H P S 2 T1 0 0 0 3 2 A A 1**

[CONFIGURE >](#)

[VIEW PRODUCT >](#)

### Online product configurator

Many products are configurable online using our product configurator.

Select the **Configure** button or visit [Emerson.com/global](https://emerson.com/global) to start. With this tool's built-in logic and continuous validation, you can configure your products more quickly and accurately.

### Specifications and options

The purchaser of the equipment must specify and select the product materials, options, or components.

### Sizing and selection

All Rosemount flow meters can be sized to meet your application specific requirements in the DP Flow sizing and selection tool. This tool will verify if a selected product meets your application requirements, provide a comparison between different primary elements, and generate a detailed accuracy comparison graph.

Once a sizing is completed, the configuration tool will help create a complete and valid model code to match your requirements and include any additional options or approvals.

### Model codes

Model codes contain the details related to each product. Exact model codes will vary; an example of a typical model code is shown in Figure 3.

Figure 3: Model Code Example

**3051CFADL060ZSHPS1T100072AA1 WR5M6BLEDA1RK**

**1**

**2**

- A. Required model components <sup>(4)</sup>
- B. Additional options <sup>(5)</sup>.

### Optimizing lead time

The starred offerings (★) represent the most common options and should be selected for the fastest delivery times. The non-starred offerings are subject to additional delivery lead time.

### Required model components

#### Model

Code	Description	
3051CFA	Annubar Flow Meter	★

#### Measurement type

Code	Description	
D	Differential pressure	★

#### Fluid type

Code	Description	
L	Liquid	★
G	Gas	★
S	Steam	★

#### Line size

Actual units are built to customer supplied pipe ID and wall dimensions. Line size codes in model are used as a nominal size and auto-selected by the sizing program.

Code	Description	
020	2 in. (50 mm)	★
025	2½ in. (63.5 mm)	★

(4) Choices available on most.

(5) Variety of features and functions that may be added to products

Code	Description	
030	3 in. (80 mm)	★
035	3½ in. (89 mm)	★
040	4 in. (100 mm)	★
050	5 in. (125 mm)	★
060	6 in. (150 mm)	★
070	7 in. (175 mm)	★
080	8 in. (200 mm)	★
100	10 in. (250 mm)	★
120	12 in. (300 mm)	★
140	14 in. (350 mm)	
160	16 in. (400 mm)	
180	18 in. (450 mm)	
200	20 in. (500 mm)	
240	24 in. (600 mm)	
300	30 in. (750 mm)	
360	36 in. (900 mm)	
420	42 in. (1066 mm)	
480	48 in. (1210 mm)	
600	60 in. (1520 mm)	
720	72 in. (1820 mm)	
780	78 in. (1950 mm)	
840	84 in. (2100 mm)	
900	90 in. (2250 mm)	
960	96 in. (2400 mm)	

**Pipe ID range**

Code	Description	
Z	Custom manufactured for customer-supplied pipe ID	★

**Pipe material/mounting assembly material**

Code	Description	
C	CS (A105)	★
S	316 SST	★
0 <sup>(1)</sup>	No mounting <sup>(2)</sup>	★
G	Chrome-moly grade F-11	
N	Chrome-moly grade F-22	
J	Chrome-moly grade F-91	

(1) For customer-supplied mounting or isolation valve, provide relevant dimension at time of sizing and order.

(2) Customer-supplied.

**Piping orientation**

Code	Description	
H	Horizontal piping	★
D	Vertical piping with downward flow	★
U	Vertical piping with upward flow	★

**Annubar type**

Code	Description	
P	Pak-Lok	★
F	Flanged with opposite side support	★
L	Flange-Lok	
G	Gear-drive Flo-Tap	
M	Manual Flo-Tap	

**Sensor material**

Code	Description	
S	316 SST	★
H	Alloy C-276	

**Sensor size**

Code	Description	
1	Sensor size 1 — Line sizes 2 to 8 in. (50 to 200 mm)	★
2	Sensor size 2 — Line sizes 6 to 96 in. (150 to 2400 mm)	★
3	Sensor size 3 — Line sizes greater than 12 in. (300 mm)	★

**Mounting type**

Code	Description	
T1	Compression or threaded connection	★
A1	Class 150 RF ASME B16.5	★
A3	Class 300 RF ASME B16.5	★
A6	Class 600 RF ASME B16.5	★
A9 <sup>(1)</sup>	Class 900 RF ASME B16.5	
AF <sup>(1)</sup>	Class 1500 RF ASME B16.5	
AT <sup>(1)</sup>	Class 2500 RF ASME B16.5	
D1	PN16 EN-1092-1 RF	★
D3	PN40 EN-1092-1 RF	★
D6	PN100 EN-1092-1 RF	★
R1	Class 150 RTJ ASME B16.5	

Code	Description	
R3	Class 300 RTJ ASME B16.5	
R6	Class 600 RTJ ASME B16.5	
R9 <sup>(1)</sup>	Class 900 RTJ ASME B16.5	
RF <sup>(1)</sup>	Class 1500 RTJ ASME B16.5	
RT <sup>(1)</sup>	Class 2500 RTJ ASME B16.5	

(1) Available in remote mount applications only.

**Opposite side support or packing gland**

Code	Description			
0	No opposite side support or packing gland <sup>(1)</sup>	★		
<b>Opposite side support <sup>(2)</sup></b>				
C	NPT threaded opposite support assembly	★		
D	Welded opposite support assembly	★		
<b>Packing gland <sup>(3)</sup></b>				
	Packing gland material	Rod material	Packing material	
J <sup>(4)</sup>	Stainless steel packing gland/cage nipple	Carbon steel	PTFE	
K <sup>(4)</sup>	Stainless steel packing gland/cage nipple	Stainless steel	PTFE	
L <sup>(4)</sup>	Stainless steel packing gland/cage nipple	Carbon steel	Graphite	
N <sup>(4)</sup>	Stainless steel packing gland/cage nipple	Stainless steel	Graphite	
R	Alloy C-276 packing gland/cage nipple	Stainless steel	Graphite	

(1) Required for Pak-Lok and Flange-Lok models.

(2) Required for flanged models.

(3) Required for Flo-Tap models.

(4) The cage nipple is constructed of 304SST.

**Isolation valve for Flo-Tap models**

Code	Description	
0 <sup>(1)</sup>	Not applicable or customer-supplied	★
1	Gate valve, CS	
2	Gate valve, SST	
5	Ball valve, CS	
6	Ball valve, SST	

(1) For customer-supplied mounting or isolation valve, provide relevant dimension at time of sizing and order.

**Temperature measurement**

Code	Description	
T	Integral RTD <sup>(1)</sup>	★
0	No temperature sensor	★
R	Remote thermowell and RTD	

(1) Not available with flanged model greater than Class 600.

### Transmitter connection platform

Code	Description	
3	Direct-mount, integral 3-valve manifold- not available with flanged model greater than Class 600	★
5	Direct-mount, 5-valve manifold - not available with flanged model greater than Class 600	★
7	Remote-mount NPT connections (½ in. NPT)	★
6	Direct-mount, high temperature 5-valve manifold - not available with flanged model greater than Class 600	
8	Remote-mount SW connections (½ in.)	

### Differential pressure range

Code	Description	
1	0 to 25 in H <sub>2</sub> O (0 to 62.16 mbar)	★
2	0 to 250 in H <sub>2</sub> O (0 to 621.60 mbar)	★
3	0 to 1000 in H <sub>2</sub> O (0 to 2.49 bar)	★

### Transmitter output

Code	Description	
A	4–20 mA with digital signal based on HART® Protocol	★
F	FOUNDATION™ Fieldbus Protocol	★
W <sup>(1)</sup>	PROFIBUS® PA Protocol	★
X <sup>(2)</sup>	Wireless <sup>(3)</sup>	★
M <sup>(4)</sup>	Low-power, 1–5 Vdc with digital signal based on HART® Protocol	

(1) For local addressing and configuration, M4 (LOI) is required. Not available with product certification codes E4, EM, EP, I6, IM, KD, KL, KM, KP, KS, and N3.

(2) This option is only available with intrinsically safe approvals.

(3) Requires wireless options and engineered polymer housing.

(4) Only available with C6, E2, E5, I5, K5, KB, EM, IM, KM, EP, and E8 product certifications.

### Housing material

Code	Description	Conduit entry size	
A	Aluminum	½–14 NPT	★
B	Aluminum	M20 x 1.5	★
J	SST	½–14 NPT	★
K	SST	M20 x 1.5	★
P <sup>(1)</sup>	Engineered polymer	No conduit entries	★
D <sup>(2)</sup>	Aluminum	G½	
M <sup>(2)</sup>	SST	G½	

(1) Only available with wireless output (code X).

(2) Transmitter conduit entry will be ½ NPT and a ½ NPT to G½ thread adapter will be provided. These options are only available with product certifications options I1, I2, I3, I7, IA, IB, IM, KA, N1, N3, and N7. Product certifications options E4 and IG are available with aluminum only (option D).

**Transmitter performance class**

Code	Description	
1	1.75 percent flow rate accuracy, 8:1 flow turndown, 5-year stability	★

**Wireless options**

Requires wireless output (code X) and engineered polymer housing (code P).

**Wireless transmit rate, operating frequency, and protocol**

Code	Description	
WA3	User configurable transmit rate, 2.4 GHz <i>Wireless HART</i> ®	★

**Antenna and SmartPower™**

Code	Description	
WP5	Internal antenna, compatible with Green Power Module (1)	★

(1) *IS Power Module sold separately.*

**Additional options**

**Local wireless device access**

Code	Description	
BLE(1)	Bluetooth® configuration and maintenance	★

(1) *Requires the Graphical LCD Display (code M6).*

**Extended product warranty**

Code	Description	
WR3	3-year limited warranty	★
WR5	5-year limited warranty	★

**Alternate transmitter diaphragm material**

Code	Description	
ID2	316 SST	
ID3	Alloy C-276	
ID4(1)	Alloy 400	
ID5(1)	Tantalum	
ID6 (1)	Gold-plated Alloy 400 (2)	
ID7(1)	Gold-plated SST	

(1) *Not available with wireless output (code X).*

(2) *Includes graphite-filled PTFE O-ring.*

**Pressure testing**

Code	Description	
P1	Hydrostatic testing with certificate	

Code	Description	
PX	Extended hydrostatic testing	

### Special cleaning

Code	Description	
P2	Cleaning for special processes	

### Material testing

Code	Description	
V1	Dye penetrant exam	

### Material examination

Code	Description	
V2	Radiographic examination	

### Flow calibration

Code	Description	
W1	Flow calibration (Average K)	

### Special inspection

Code	Description	
QC1	Visual and dimensional inspection with certificate	★
QC7	Inspection and performance certificate	★

### Surface finish

This surface finish option is auto-selected by the sizing tool as necessary.

Code	Description	
RL	Surface finish for low pipe Reynolds number in gas and steam	★
RH	Surface finish for high pipe Reynolds number in liquid	★

### Material traceability certification

Instrument connections for remote mount options and isolation valves for Flo-Tap models are not included in the Material Traceability Certification.

Code	Description	
Q8	Material Traceability Certification per EN 10474:2004 3.1	★

**Positive material identification (PMI)**

Code	Description	
Q76	PMI verification and certificate	★

**Code conformance**

This option is not available with transmitter connection platform 6.

Code	Description	
J2	ANSI/ASME B31.1	
J3	ANSI/ASME B31.3	

**Materials conformance**

Materials of Construction comply with metallurgical requirements within NACE MR0175/ISO for sour oil field production environments. Environmental limits apply to certain materials. Consult latest standard for details. Selected materials also conform to NACE MR0103 for sour refining environments.

Selecting J5 option will provide Alloy C-276 transmitter diaphragms.

Code	Description	
J5	Certificate of Compliance to NACE MR0175/ISO 15156 for wetted materials	

**Country certification**

Code	Description	
J6	European Pressure Directive (PED)	★
J1	Canadian Registration	
J8	Chinese Certificate of Special Equipment Type Test	

**Installed in flanged pipe spool section**

Refer to [Rosemount 485](#) specifications section for spool section lengths and schedules

Code	Description	
H3	Class 150 flanged connection with Rosemount standard length and schedule	
H4	Class 300 flanged connection with Rosemount standard length and schedule	
H5	Class 600 flanged connection with Rosemount standard length and schedule	

**Instrument connections for remote mount options**

Code	Description	
G2	Needle valves, SST	★
G6	OS&Y gate valves, SST	★
G1	Needle valves, CS	
G3	Needle valves, alloy C-276	
G5	OS&Y gate valves, CS	
G7	OS&Y gate valves, alloy C-276	

**Special shipment**

Code	Description	
Y1	Mounting hardware shipped separately	★

**Special dimensions**

Code	Description	
VM	Variable mounting	

**Plantweb™ control functionality**

Code	Description	
A01	FOUNDATION™ Fieldbus control function block suite	★

**Plantweb™ diagnostic functionality**

Code	Description	
DA0 <sup>(1)</sup>	Loop Integrity Diagnostic	★
DA1 <sup>(1)</sup>	Loop Integrity and Plugged Impulse Line Diagnostics	★
D01	FOUNDATION™ Fieldbus Diagnostics Suite	★

(1) Only available with 4-20 mA HART® protocol (code A).

**Product certifications**

Code	Description	
E8	ATEX Flameproof and Dust Certification	★
I1 <sup>(1)</sup>	ATEX Intrinsic Safety and Dust	★
IA	ATEX FISCO Intrinsic Safety; for FOUNDATION™ Fieldbus or PROFIBUS® PA Protocol only	★
N1	ATEX Type n Certification and Dust	★
K8	ATEX Flameproof, Intrinsic Safety, Type n, Dust (combination of E8, I1 and N1)	★
E4	Japan Flame-proof	★
I4	Japan Intrinsic Safety	★
E5	USA Explosion-proof, Dust Ignition-Proof	★
I5 <sup>(2)</sup>	USA Intrinsically Safe, Nonincendive	★
K5	USA Explosion-proof, Dust Ignition-Proof, Intrinsically Safe, and Division 2	★
E6	Canada Explosion-proof, Dust Ignition-proof, Division 2	★
I6 <sup>(3)</sup>	Canada Intrinsic Safety	★
N7	IECEX Type n Certification	★
C6	Canada Explosion-proof, Dust Ignition-proof, Intrinsically Safe, and Division 2	★
K6	Canada and ATEX Explosion-proof, Intrinsically Safe, and Division 2 (combination of C6, E8, and I1)	★
E7	IECEX Flameproof, Dust Ignition-proof	★
I7	IECEX Intrinsic Safety	★
K7	IECEX Flame-proof, Dust Ignition-proof, Intrinsic Safety, and Type n (combination of I7, N7, and E7)	★
E2	Brazil Flameproof	★

I2	Brazil Intrinsic Safety	★
IB	Brazil FISCO intrinsically safe; for FOUNDATION Fieldbus or PROFIBUS PA Protocols only	★
K2	Brazil Flameproof, Intrinsic Safety	★
E3	China Flameproof	★
I3	China Intrinsic Safety	★
EM	Technical Regulations Customs Union (EAC) Flameproof	★
IM	Technical Regulations Customs Union (EAC) Intrinsic Safety	★
KM	Technical Regulations Customs Union (EAC) Flameproof and Intrinsic Safety	★
KB	USA and Canada Explosion-proof, Dust Ignition Proof, Intrinsically Safe, and Division 2 (combination of K5 and C6)	★
KD	USA, Canada, and ATEX Explosion-proof, Intrinsically Safe (combination of K5, C6, I1, and E8)	★

- (1) *Dust approval not applicable to wireless transmitter output (code X).*
- (2) *Nonincendive certification not provided with wireless transmitter output (code X).*
- (3) *Only available with wireless transmitter output (code X).*

**Sensor fill fluid and O-ring options**

Code	Description	
L1 <sup>(1)</sup>	Inert sensor fill fluid <sup>(2)</sup>	★
L2	Graphite-filled (PTFE) O-ring	★
LA <sup>(1)</sup>	Inert sensor fill fluid and graphite-filled (PTFE) O-ring	★

- (1) *Not available with wireless output (code X).*
- (2) *Silicone fill fluid is standard.*

**Shipboard approvals**

Code	Description	
SBS	American Bureau of Shipping <sup>(1)</sup>	★

- (1) *Not available with wireless output (code X).*

**Display and interface options**

Code	Description	
M6 <sup>(1)</sup>	Graphical LCD display	★
M5	LCD display	★
M4 <sup>(2)</sup>	LCD display with LOI	★

- (1) *Only available with 4-20 mA HART® output (code A).*
- (2) *Only available with 4-20 mA HART output (code A) and PROFIBUS®-PA output (code W).*

**Transmitter calibration certification**

Code	Description	
Q4	Calibration certificate for transmitter	★

**Quality certification for safety**

These options are only available with 4–20 mA HART (output code A).

Code	Description	
QT	Safety certified to IEC 61508 with certificate of FMEDA	★

### Transient protection

This option is not available with wireless output (code X). The T1 option is not needed with FISCO Product Certifications; transient protection is included with the FISCO Product Certification (codes IA, IB, and IE).

Code	Description	
T1	Transient terminal block	★

### Manifold for remote mount option

Code	Description	
F2	3-valve manifold, SST	★
F6	5-valve manifold, SST	★
F3	3-valve manifold, alloy C-276	
F7	5-valve manifold, alloy C-276	

### Lower power output

Code	Description	
C2	0.8–3.2 Vdc output with digital signal based on HART® Protocol <sup>(1)</sup>	

(1) Available with low power HART output code M only.

### Alarm levels

These options are only available with 4–20 mA HART output (code A).

Code	Description	
C4 <sup>(1)</sup>	NAMUR alarm and saturation levels, high alarm	★
CN <sup>(1)</sup>	NAMUR alarm and saturation levels, low alarm	★
CR	Custom alarm and saturation signal levels, high alarm (see Rosemount 3051 <a href="#">Configuration Data Sheet</a> )	★
CS	Custom alarm and saturation signal levels, low alarm (see Rosemount 3051 <a href="#">Configuration Data Sheet</a> )	★
CT	Rosemount standard low alarm	★

(1) NAMUR-compliant operation is preset at the factory and can be changed to standard operation in the field for the standard Rosemount 3051.

### Enhanced safety

Only available with HART 4–20 mA output (Code A).

Code	Description	
T9	Enhanced SIS proof testing and logging	★

### Configuration buttons

Code	Description	
D1 <sup>(1)</sup>	Quick service buttons	★
D4 <sup>(2)</sup>	Analog zero and span	★
DZ <sup>(3)</sup>	Digital zero trim	★

(1) Only available with Graphical LCD Display (code M6).

(2) Only available with 4–20 mA HART® (output code A).

(3) Only available with 4–20 mA HART (output code A) and wireless (output code X).

**Ground screw**

This option is not available with wireless output (code X). The V5 option is not needed with the T1 option; external ground screw assembly is included with the T1 option.

Code	Description	
V5	External ground screw assembly	★

**Enhanced software**

Enhanced software enables application specific configuration, expanded process alerts, and logging capabilities.

Code	Description	
RK	Enhanced software	★

## Rosemount 3051CFC Compact Flow Meter ordering information



Rosemount 3051CFC Compact Flow Meters provide a quick, reliable installation between existing raised face flanges. Depending on your application needs, you can reduce energy loss with the Compact Annubar™ or minimize straight run requirements with the Conditioning Orifice.

- Up to 1.75 percent of flow rate accuracy.
- Available in ½ to 12 in. (15 to 300 mm) line sizes.
- Fully assembled and leak tested for out-of-the-box installation.
- Simplified flow configuration with clearly displayed flow rate and added totalizer (code M6, BLE, D1, DA1, T9, or RK).
- Loop Integrity and Plugged Impulse Line Diagnostics detect issues that might compromise the integrity of the output signal (code DA1).
- Bluetooth® enables efficient, reliable, and safe configuration and maintenance (code BLE).
- Back-lit Graphical Display with Local Language Capability (code M6).
- Safety certification and proof testing (code QT and T9).
- Typical 3051CFC model code: **3051CFC D C S 060 N 065 0 3 2 X P 1 WA3 WP5 WC M5 DZ**

[CONFIGURE >](#)
[VIEW PRODUCT >](#)

### Online product configurator

Many products are configurable online using our product configurator.

Select the **Configure** button or visit [Emerson.com/global](https://emerson.com/global) to start. With this tool's built-in logic and continuous validation, you can configure your products more quickly and accurately.

### Specifications and options

The purchaser of the equipment must specify and select the product materials, options, or components.

### Sizing and selection

All Rosemount flow meters can be sized to meet your application specific requirements in the DP Flow sizing and selection tool. This tool will verify if a selected product meets your application requirements, provide a comparison between different primary elements, and generate a detailed accuracy comparison graph.

Once a sizing is completed, the configuration tool will help create a complete and valid model code to match your requirements and include any additional options or approvals.

### Model codes

Model codes contain the details related to each product. Exact model codes will vary; an example of a typical model code is shown in [Figure 4](#).

**Figure 4: Model code example**

**3051CFADL060ZSHPS1T100072AA1 WR5M6BLEDA1RK**

**1**

**2**

1. Required model components <sup>(6)</sup>
2. Additional options <sup>(7)</sup>

### Optimizing lead time

The starred offerings (★) represent the most common options and should be selected for the fastest delivery times. The non-starred offerings are subject to additional delivery lead time.

### Required model components

#### Model

Code	Description	
3051CFC	Compact flow meter	★

#### Measurement type

Code	Description	
D	Differential pressure	★

#### Primary element technology

Code	Description	
A	Annubar averaging pitot tube	★
C	Conditioning orifice plate	★
P	Orifice plate	★

#### Material type

Code	Description	
S	316 SST	★

#### Line size

Code	Product description	
005 <sup>(1)</sup>	½ in. (15 mm)	★
010 <sup>(1)</sup>	1 in. (25 mm)	★
015 <sup>(1)</sup>	1½ in. (40 mm)	★
020	2 in. (50 mm)	★
030	3 in. (80 mm)	★
040	4 in. (100 mm)	★
060	6 in. (150 mm)	★
080	8 in. (200 mm)	★

(6) Choices available on most.

(7) Variety of features and functions that may be added to products.

Code	Product description	
100 <sup>(2)</sup>	10 in. (250 mm)	★
120 <sup>(2)</sup>	12 in. (300 mm)	★

(1) Available with orifice plate (code P) only.

(2) 10 in. (250 mm) and 12 in. (300 mm) line sizes not available with annubar (code A).

### Primary element type

Code	Description	
N000	Rosemount Annubar sensor size 1	★
N040	0.40 beta ratio	★
N050	0.50 beta ratio	
N065 <sup>(1)</sup>	0.65 beta ratio	★

(1) For 2 in. (50 mm) line sizes, the Primary Element Type is 0.60 for conditioning orifice plate (code C).

### Temperature measurement

Code	Description	
T <sup>(1)</sup>	Integral temperature	
0	No temperature sensor	★
R	Remote thermowell and RTD	

(1) Available with annubar (code A) only.

### Transmitter connection platform

Code	Description	
3	Direct-mount, integral 3-valve manifold	★
7	Remote-mount, NPT connections	★

### Differential pressure range

Code	Description	
1	0 to 25 in H <sub>2</sub> O (0 to 62.16 mbar)	★
2	0 to 250 in H <sub>2</sub> O (0 to 621.60 mbar)	★
3	0 to 1000 in H <sub>2</sub> O (0 to 2.49 bar)	★

### Transmitter output

Code	Description	
A	4–20 mA with digital signal based on HART <sup>®</sup> Protocol	★
F	FOUNDATION <sup>™</sup> Fieldbus Protocol	★
W <sup>(1)</sup>	PROFIBUS <sup>®</sup> PA Protocol	★
X <sup>(2)</sup>	Wireless <sup>(3)</sup>	★
M <sup>(4)</sup>	Low-power, 1–5 Vdc with digital signal based on HART <sup>®</sup> Protocol	

(1) For local addressing and configuration, M4 (LOI) is required. Not available with product certification codes E4, EM, EP, I6, IM, KD, KL, KM, KP, KS, and N3.

(2) This option is only available with intrinsically safe approvals.

- (3) Requires wireless options and engineered polymer housing.
- (4) Only available with C6, E2, E5, I5, K5, KB, EM, IM, KM, EP, and E8 product certifications.

**Housing material**

Code	Description	Conduit entry size	
A	Aluminum	½-14 NPT	★
B	Aluminum	M20 x 1.5	★
J	SST	½-14 NPT	★
K	SST	M20 x 1.5	★
P <sup>(1)</sup>	Engineered polymer	No conduit entries	★
D <sup>(2)</sup>	Aluminum	G½	
M <sup>(2)</sup>	SST	G½	

- (1) Only available with wireless output (code X).
- (2) Transmitter conduit entry will be ½ NPT and a ½ NPT to G½ thread adapter will be provided. These options are only available with product certifications options I1, I2, I3, I7, IA, IB, IM, KA, N1, N3, and N7. Product certifications options E4 and IG are available with aluminum only (option D).

**Transmitter performance class**

Code	Description	
1	Up to ±1.75% flow rate accuracy, 8:1 flow turndown, 5-year stability	★

**Wireless options**

Requires wireless output (code X) and engineered polymer housing (code P).

**Wireless transmit rate, operating frequency, and protocol**

Code	Description	
WA3	User configurable transmit rate, 2.4 GHz WirelessHART®	★

**Antenna and SmartPower™**

Code	Description	
WP5	Internal antenna, compatible with Green Power Module <sup>(1)</sup>	★

- (1) IS Power Module sold separately.

**Additional options**

**Local wireless device access**

Code	Description	
BLE <sup>(1)</sup>	Bluetooth® configuration and maintenance	★

- (1) Requires the Graphical LCD Display (code M6).

**Extended product warranty**

Code	Description	
WR3	3-year limited warranty	★
WR5	5-year limited warranty	★

**Alternate transmitter diaphragm material**

Code	Description	
ID2	316 SST	
ID3	Alloy C-276	
ID4 <sup>(1)</sup>	Alloy 400	
ID5 <sup>(1)</sup>	Tantalum	
ID6 <sup>(1)</sup>	Gold-plated Alloy 400 <sup>(2)</sup>	
ID7 <sup>(1)</sup>	Gold-plated SST	

(1) Not available with wireless output (code X).

(2) Includes graphite-filled PTFE O-ring.

**Installation accessories**

Code	Description	
AB <sup>(1)</sup>	ANSI alignment ring (Class 150)	★
AC <sup>(1)</sup>	ANSI alignment ring (Class 300)	★
AD <sup>(1)</sup>	ANSI alignment ring (Class 600)	★
DG	DIN alignment ring (PN16)	★
DH	DIN alignment ring (PN40)	★
DJ	DIN alignment ring (PN100)	★
JB	JIS alignment ring (10K) <sup>(2)</sup>	
JR	JIS alignment ring (20K)	
JS	JIS alignment ring (40K)	

(1) Only required for 10 in. (250 mm) and 12 in. (300 mm) line sizes.

(2) Not available on 12-in (300mm) line size.

**Remote adapters**

Code	Description	
FE	Flange adapters 316 SST (½-in NPT)	★

**High temperature application**

Code	Description	
HT	Graphite valve packing (T <sub>max</sub> = 850 °F [454 °C])	

**Flow calibration**

Code	Description	
WC	Flow calibration, 3 pt, conditioning orifice option C	
WD <sup>(1)</sup>	Flow calibration, 10 pt, conditioning option C, Annubar option A	

(1) Consult factory for pipe schedules other than schedule 40.

**Pressure testing**

Code	Description	
P1	Hydrostatic testing with certificate	

**Special cleaning**

Available with Primary Element Technology C or P only.

Code	Description	
P2	Cleaning for special processes	

**Special inspection**

Code	Description	
QC1	Visual and dimensional inspection with certificate	★
QC7	Inspection and performance certificate	★

**Transmitter calibration certification**

Code	Description	
Q4	Calibration certificate for transmitter	★

**Quality certification for safety**

Only available with HART® 4–20 mA output (code A).

Code	Description	
QT	Safety certified to IEC 61508 with certificate of FMEDA	★

**Material traceability certification**

Code	Description	
Q8	Material traceability certification per EN 10204:2004 3.1	★

**Positive material identification (PMI)**

Code	Description	
Q76	PMI verification and certificate	★

**Code conformance**

Code	Description	
J2	ANSI/ASME B31.1	
J3	ANSI/ASME B31.3	

### Materials conformance

Materials of Construction comply with metallurgical requirements within NACE MR0175/ISO for sour oil field production environments. Environmental limits apply to certain materials. Consult latest standard for details. Selected materials also conform to NACE MR0103 for sour refining environments.

Selecting J5 option will provide Alloy C-276 transmitter diaphragms.

Code	Description
J5	Certificate of Compliance to NACE MR0175/ISO 15156 for wetted materials

### Country certification

Code	Description
J1	Canadian Registration
J8	Chinese Certificate of Special Equipment Type Test

### Product certifications

Code	Description	
E8	ATEX Flameproof and Dust Certification	★
I1 <sup>(1)</sup>	ATEX Intrinsic Safety and Dust	★
IA	ATEX FISCO Intrinsic Safety; for FOUNDATION™ Fieldbus or PROFIBUS® PA Protocol only	★
N1	ATEX Type n Certification and Dust	★
K8	ATEX Flameproof, Intrinsic Safety, Type n, Dust (combination of E8, I1 and N1)	★
E5	USA Explosion-proof, Dust Ignition-Proof	★
I5 <sup>(2)</sup>	USA Intrinsically Safe, Nonincendive	★
K5	USA Explosion-proof, Dust Ignition-Proof, Intrinsically Safe, and Division 2	★
E6	Canada Explosion-proof, Dust Ignition-proof, Division 2	★
I6 <sup>(3)</sup>	Canada Intrinsic Safety	★
C6	Canada Explosion-proof, Dust Ignition-proof, Intrinsically Safe, and Division 2	★
K6	Canada and ATEX Explosion-proof, Intrinsically Safe, and Division 2 (combination of C6, E8, and I1)	★
E7	IECEX Flameproof, Dust Ignition-proof	★
I7	IECEX Intrinsic Safety	★
N7	IECEX Type n Certification	★
K7	IECEX Flame-proof, Dust Ignition-proof, Intrinsic Safety, and Type n (combination of I7, N7, and E7)	★
E2	Brazil Flameproof	★
I2	Brazil Intrinsic Safety	★
IB	Brazil FISCO intrinsically safe; for FOUNDATION Fieldbus or PROFIBUS PA Protocols only	★
K2	Brazil Flameproof, Intrinsic Safety	★
E3	China Flameproof	★
I3	China Intrinsic Safety	★
EP	Republic of Korea Flameproof	★
IP	Republic of Korea Intrinsic Safety	★
EM	Technical Regulations Customs Union (EAC) Flameproof	★

IM	Technical Regulations Customs Union (EAC) Intrinsic Safety	★
KM	Technical Regulations Customs Union (EAC) Flameproof and Intrinsic Safety	★
KB	USA and Canada Explosion-proof, Dust Ignition Proof, Intrinsically Safe, and Division 2 (combination of K5 and C6)	★
KD	USA, Canada, and ATEX Explosion-proof, Intrinsically Safe (combination of K5, C6, I1, and E8)	★
KP	Republic of Korea Flameproof and Intrinsic Safety	★

- (1) *Dust approval not applicable to wireless (output code X).*
- (2) *Nonincendive certification not provided with wireless (output code X).*
- (3) *Only available with wireless output (code X).*

**Sensor fill fluid and O-ring options**

Code	Description	
L1 <sup>(1)</sup>	Inert sensor fill fluid	★
L2	Graphite-filled (PTFE) O-ring	★
LA <sup>(1)</sup>	Inert sensor fill fluid and graphite-filled (PTFE) O-ring	★

- (1) *Not available with wireless output (code X).*

**Shipboard approvals**

Not available with wireless output (code X).

Code	Description	
SBS	American Bureau of Shipping	★

**Display and interface options**

Code	Description	
M6 <sup>(1)</sup>	Graphical LCD display	★
M5	LCD display	★
M4 <sup>(2)</sup>	LCD display with LOI	★

- (1) *Only available with 4-20 mA HART® output (code A).*
- (2) *Only available with 4-20 mA HART output (code A) and PROFIBUS®-PA (code W).*

**Transient protection**

This option is not available with wireless output code X. The T1 option is not needed with FISCO Product Certifications; transient protection is included with the FISCO Product Certification code IA, IB, and IE.

Code	Description	
T1	Transient terminal block	★

**Manifold for remote mount option**

Code	Description	
F2	3-valve manifold, SST	★
F6	5-Valve Manifold, SST	★

**Plantweb™ control functionality**

Code	Description	
A01	FOUNDATION™ Fieldbus control function block suite	★

**Plantweb™ diagnostic functionality**

Code	Description	
DA0 <sup>(1)</sup>	Loop Integrity Diagnostic	★
DA1 <sup>(1)</sup>	Loop Integrity and Plugged Impulse Line Diagnostics	★
D01	FOUNDATION™ Fieldbus Diagnostics Suite	★

(1) Only available with 4-20 mA HART® protocol (code A).

**Low power output**

Code	Description	
C2	0.8–3.2 Vdc output with digital signal based on HART® Protocol <sup>(1)</sup>	

(1) Available with output code M only.

**Alarm levels**

Only available with HART 4–20 mA output (code A).

Code	Description	
C4 <sup>(1)</sup>	NAMUR alarm and saturation levels, high alarm	★
CN <sup>(1)</sup>	NAMUR alarm and saturation levels, low alarm	★
CR	Custom alarm and saturation signal levels, high alarm (See Rosemount 3051 <a href="#">Configuration Data Sheet</a> )	★
CS	Custom alarm and saturation signal levels, low alarm (See Rosemount 3051 <a href="#">Configuration Data Sheet</a> )	★
CT	Rosemount standard low alarm	★

(1) NAMUR-compliant operation is preset at the factory and can be changed to standard operation in the field for the standard Rosemount 3051.

**Ground screw**

Code	Description	
V5	External ground screw assembly <sup>(1)</sup>	★

(1) The V5 option is not needed with the T1 option; external ground screw assembly is included with the T1 option.

**Enhanced safety**

Code	Description	
T9	Enhanced SIS proof testing and logging <sup>(1)</sup>	★

(1) Only available with HART 4-20 mA output (Code A).

**Configuration buttons**

Code	Description	
D1 <sup>(1)</sup>	Quick service buttons	★
D4 <sup>(2)</sup>	Analog zero and span	★

DZ <sup>(3)</sup>	Digital zero trim	★
-------------------	-------------------	---

- (1) Only available with Graphical LCD Display (code M6).
- (2) Only available with HART 4-20 mA (output code A).
- (3) Only available with HART 4-20 mA (output code A) and wireless (output code X).

**Enhanced software**

Enhanced software enables application specific configuration, expanded process alerts, and logging capabilities.

Code	Description	
RK	Enhanced software	★

## Rosemount 3051CFP Integral Orifice Flow Meter ordering information

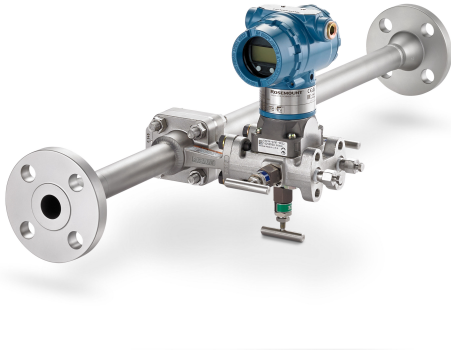

Rosemount 3051CFP Integral Orifice Flow Meters enable highly accurate flow measurement in small line sizes. Internal pipe diameter variation in combination with plate centering issues can greatly magnify flow measurement errors in small line sizes. Integral Orifice Flow Meters use a precision honed pipe section to minimize internal pipe diameter variation along with a self-centering plate design to eliminate alignment errors.

- Up to 1.75 percent of flow rate accuracy.
- Available in ½ to 1½ in. (15 - 40 mm) line sizes.
- Fully assembled and leak tested for out-of-the-box installation.
- Simplified flow configuration with clearly displayed flow rate and added totalizer (code M6, BLE, D1, DA1, T9, or RK).
- Loop Integrity and Plugged Impulse Line Diagnostics detect issues that might compromise the integrity of the output signal (code DA1).
- Bluetooth® enables efficient, reliable, and safe configuration and maintenance (code BLE).
- Back-lit Graphical Display with Local Language Capability (code M6).
- Safety certification and proof testing (code QT and T9).
- Typical 3051CFP model code: **3051CFP D F010 W1 S 0500 D3 2 AA 1 E5 M5**

[CONFIGURE >](#)
[VIEW PRODUCT >](#)

### Online product configurator

Many products are configurable online using our product configurator.

Select the **Configure** button or visit [Emerson.com/global](https://emerson.com/global) to start. With this tool's built-in logic and continuous validation, you can configure your products more quickly and accurately.

### Specifications and options

The purchaser of the equipment must specify and select the product materials, options, or components.

### Sizing and selection

All Rosemount flow meters can be sized to meet your application specific requirements in the DP Flow sizing and selection tool. This tool will verify if a selected product meets your application requirements, provide a comparison between different primary elements, and generate a detailed accuracy comparison graph.

Once a sizing is completed, the configuration tool will help create a complete and valid model code to match your requirements and include any additional options or approvals.

### Model codes

Model codes contain the details related to each product. Exact model codes will vary; an example of a typical model code is shown in Figure 5.

Figure 5: Model Code Example

**3051CFADL060ZSHPS1T100072AA1 WR5M6BLEDA1RK**

**1**

**2**

A. Required model components <sup>(8)</sup>

B. Additional options <sup>(9)</sup>

### Optimizing lead time

The starred offerings (★) represent the most common options and should be selected for the fastest delivery times. The non-starred offerings are subject to additional delivery lead time.

### Required model components

#### Model

Code	Description	
3051CFP	Integral Orifice Flow Meter	★

#### Measurement type

Code	Product description	
D	Differential pressure	★

#### Material type and body

Code	Description	
F	316 SST, enhanced support body	★

#### Line size

Code	Description	
005	½ in. (15 mm)	★
010	1 in. (25 mm)	★
015	1½ in. (40 mm)	★

(8) Choices available on most.

(9) Variety of features and functions that may be added to products.

**Process connection**

Code	Description	
T1	NPT female body (not available with remote thermowell and RTD)	★
S1 <sup>(1)</sup>	Socket weld body (not available with remote thermowell and RTD)	★
P1	Pipe ends: NPT threaded	★
P2	Pipe ends: beveled	★
D1	Pipe ends: flanged, PN16 EN-1092-1 RF, slip-on	★
D2	Pipe ends: flanged, PN40 EN-1092-1 RF, slip-on	★
D3	Pipe ends: flanged, PN100 EN-1092-1 RF, slip-on	★
W1	Pipe ends: flanged, Class 150 RF ASME B16.5, weld-neck	★
W3	Pipe ends: flanged, Class 300 RF ASME B16.5, weld-neck	★
W6	Pipe ends: flanged, Class 600 RF ASME B16.5, weld-neck	★
W9	Pipe ends: flanged, Class 900 RF ASME B16.5, weld-neck	
A1	Pipe ends: flanged, Class 150 RF ASME B16.5, slip-on	
A3	Pipe ends: flanged, Class 300 RF ASME B16.5, slip-on	
A6	Pipe ends: flanged, Class 600 RF ASME B16.5, slip-on	
R1	Pipe ends: flanged, Class 150 RTJ ASME B16.5, slip-on	
R3	Pipe ends: flanged, Class 300 RTJ ASME B16.5, slip-on	
R6	Pipe ends: flanged, Class 600 RTJ ASME B16.5, slip-on	
R9	Pipe ends: flanged, Class 900 RTJ ASME B16.5, weld-neck	

(1) To improve pipe perpendicularity for gasket sealing, socket diameter is smaller than standard pipe O.D.

**Orifice plate material**

Code	Description	
S	316 SST	★
H	Alloy C-276	
M	Alloy 400	

**Bore size option**

Code	Description	
0010	0.010 in. (0.25 mm) for ½ in. pipe	
0014	0.014 in. (0.36 mm) for ½ in. pipe	
0020	0.020 in. (0.51 mm) for ½ in. pipe	
0034	0.034 in. (0.86 mm) for ½ in. pipe	
0066	0.066 in. (1.68 mm) for ½ in. pipe	★
0109	0.109 in. (2.77 mm) for ½ in. pipe	★
0160	0.160 in. (4.06 mm) for ½ in. pipe	★
0196	0.196 in. (4.98 mm) for ½ in. pipe	★
0260	0.260 in. (6.60 mm) for ½ in. pipe	★

Code	Description	
0340	0.340 in. (8.64 mm) for ½ in. pipe	★
0150	0.150 in. (3.81 mm) for 1 in. pipe	★
0250	0.250 in. (6.35 mm) for 1 in. pipe	★
0345	0.345 in. (8.76 mm) for 1 in. Pipe	★
0500	0.500 in. (12.70 mm) for 1 in. pipe	★
0630	0.630 in. (16.00 mm) for 1 in. pipe	★
0800	0.800 in. (20.32 mm) for 1 in. pipe	★
0295	0.295 in. (7.49 mm) for 1½ in. pipe	★
0376	0.376 in. (9.55 mm) for 1½ in. pipe	★
0512	0.512 in. (13.00 mm) for 1½ in. pipe	★
0748	0.748 in. (19.00 mm) for 1½ in. pipe	★
1022	1.022 in. (25.96 mm) for 1½ in. pipe	★
1184	1.184 in. (30.07 mm) for 1½ in. pipe	★
XXXX	Special bore size (X.XXX in.)	

**Transmitter connection platform**

Code	Description	
D3	Direct-mount, 3-valve manifold, SST	★
D5	Direct-mount, 5-valve manifold, SST	★
R3	Remote-mount, 3-valve manifold, SST	★
R5	Remote-mount, 5-valve manifold, SST	
D4 <sup>(1)</sup>	Direct-mount, 3-valve manifold, alloy C-276	
D6 <sup>(1)</sup>	Direct-mount, 5-valve manifold, alloy C-276	
R4	Remote-mount, 3-valve manifold, alloy C-276	
R6	Remote-mount, 5-valve manifold, alloy C-276	

(1) *Changes the transmitter orientation of the assembly. For more information, refer to the D4, D6 option for C-276 manifold assembly in the product drawing.*

**Differential pressure range**

Code	Description	
1	0 to 25 in H <sub>2</sub> O (0 to 62.16 mbar)	★
2	0 to 250 in H <sub>2</sub> O (0 to 621.60 mbar)	★
3	0 to 1000 in H <sub>2</sub> O (0 to 2.49 bar)	★

**Transmitter output**

Code	Description	
A	4–20 mA with digital signal based on HART® Protocol	★
F	FOUNDATION™ Fieldbus Protocol	★
W <sup>(1)</sup>	PROFIBUS® PA Protocol	★

X <sup>(2)</sup>	Wireless <sup>(3)</sup>	★
M <sup>(4)</sup>	Low-power, 1–5 Vdc with digital signal based on HART® Protocol	

- (1) For local addressing and configuration, M4 (LOI) is required. Not available with product certification codes E4, EM, EP, I6, IM, KD, KL, KM, KP, KS, and N3.
- (2) This option is only available with intrinsically safe approvals.
- (3) Requires wireless options and engineered polymer housing.
- (4) Only available with C6, E2, E5, I5, K5, KB, EM, IM, KM, EP, and E8 product certifications.

### Housing material

Code	Description	Conduit entry size	
A	Aluminum	½–14 NPT	★
B	Aluminum	M20 x 1.5	★
J	SST	½–14 NPT	★
K	SST	M20 x 1.5	★
P <sup>(1)</sup>	Engineered polymer	No conduit entries	★
D <sup>(2)</sup>	Aluminum	G½	
M <sup>(2)</sup>	SST	G½	

- (1) Only available with wireless output (code X).
- (2) Transmitter conduit entry will be ½ NPT and a ½ NPT to G½ thread adapter will be provided. These options are only available with product certifications options I1, I2, I3, I7, IA, IB, IM, KA, N1, N3, and N7. Product certifications options E4 and IG are available with aluminum only (option D).

### Transmitter performance class

Code	Description	
1	Up to ±1.75% flow rate accuracy, 8:1 flow turndown, 5-year stability	★

### Wireless options

Requires wireless output (code X) and engineered polymer housing (code P).

### Wireless transmit rate, operating frequency, and protocol

Code	Description	
WA3	User configurable transmit rate, 2.4 GHz WirelessHART®	★

### Antenna and SmartPower™

Code	Description	
WP5	Internal antenna, compatible with Green Power Module <sup>(1)</sup>	★

- (1) IS Power Module sold separately.

### Additional options

#### Local wireless device access

Code	Description	
BLE <sup>(1)</sup>	Bluetooth® configuration and maintenance	★

- (1) Requires the Graphical LCD Display (code M6).

**Extended product warranty**

Code	Description	
WR3	3-year limited warranty	★
WR5	5-year limited warranty	★

**Alternate transmitter diaphragm material**

Code	Description	
ID2	316 SST	
ID3	Alloy C-276	
ID4 <sup>(1)</sup>	Alloy 400	
ID5 <sup>(1)</sup>	Tantalum	
ID6 <sup>(1)</sup>	Gold-plated Alloy 400 <sup>(2)</sup>	
ID7 <sup>(1)</sup>	Gold-plated SST	

(1) Not available with wireless output (code X).

(2) Includes graphite-filled PTFE O-ring.

**Transmitter body/bolt material**

Code	Description	
GT	High temperature (850 °F/454 °C)	

**Temperature sensor**

Thermowell material is the same as the body material.

Code	Description	
RT	Thermowell and RTD	★

**Optional connection**

Code	Description	
G1	DIN 19213 transmitter connection	

**Pressure testing**

Code	Description	
P1	Hydrostatic testing with certificate <sup>(1)</sup>	

(1) This option does not apply to process connection codes T1 and S1. Option P1 may not be ordered in combination with P2.

**Special cleaning**

Code	Description	
P2	Cleaning for special processes	

**Material testing**

Code	Description	
V1	Dye penetrant exam	

**Material examination**

Code	Description	
V2	Radiographic examination	

**Flow calibration**

Code	Description	
WD	Discharge coefficient verification <sup>(1)</sup>	

(1) This option is not available for bore sizes 0010, 0014, 0020, 0034, 0066, or 0109. This option does not apply to process connection codes T1 and S1.

**Special inspection**

Code	Description	
QC1	Visual and dimensional inspection with certificate	★
QC7	Inspection and performance certificate	★

**Material traceability certification**

Code	Description	
Q8	Material traceability certification per EN 10204: 2004 3.1	★

**Positive material identification (PMI)**

Code	Description	
Q76	PMI verification and certificate	★

**Code conformance**

This option is not available with DIN Process Connection codes D1, D2, or D3.

Code	Description	
J2 <sup>(1)</sup>	ANSI/ASME B31.1	
J3 <sup>(1)</sup>	ANSI/ASME B31.3	

(1) Changes the transmitter orientation of the assembly. Please refer to the J2, J3 options for B31 compliant assembly in the product drawing.

**Materials conformance**

Materials of Construction comply with metallurgical requirements within NACE MR0175/ISO for sour oil field production environments. Environmental limits apply to certain materials. Consult latest standard for details. Selected materials also conform to NACE MR0103 for sour refining environments.

Selecting J5 option will provide Alloy C-276 transmitter diaphragms.

Code	Description	
J5	Certificate of Compliance to NACE MR0175/ISO 15156 for wetted materials	

**Country certification**

Code	Description	
J1	Canadian Registration	★
J6	European Pressure Directive (PED)	★

**Transmitter calibration certification**

Code	Description	
Q4	Calibration certificate for transmitter	★

**Quality certification for safety**

Code	Description	
QT	Safety certified to IEC 61508 with certificate of FMEDA <sup>(1)</sup>	★

(1) This option is only available with HART® 4-20 mA output (code A).

**Product certification**

Code	Description	
E8	ATEX Flameproof and Dust Certification	★
I1 <sup>(1)</sup>	ATEX Intrinsic Safety and Dust	★
IA	ATEX FISCO Intrinsic Safety; for FOUNDATION™ Fieldbus or PROFIBUS® PA Protocol only	★
N1	ATEX Type n Certification and Dust	★
K8	ATEX Flameproof, Intrinsic Safety, Type n, Dust (combination of E8, I1 and N1)	★
E5	USA Explosion-proof, Dust Ignition-Proof	★
I5 <sup>(2)</sup>	USA Intrinsically Safe, Nonincendive	★
K5	USA Explosion-proof, Dust Ignition-Proof, Intrinsically Safe, and Division 2	★
E6	Canada Explosion-proof, Dust Ignition-proof, Division 2	★
I6 <sup>(3)</sup>	Canada Intrinsic Safety	★
C6	Canada Explosion-proof, Dust Ignition-proof, Intrinsically Safe, and Division 2	★
IE	USA FISCO Intrinsically Safe	★
K6	Canada and ATEX Explosion-proof, Intrinsically Safe, and Division 2 (combination of C6, E8, and I1)	★
E7	IECEX Flameproof, Dust Ignition-proof	★
I7	IECEX Intrinsic Safety	★
IG	IECEX FISCO Intrinsically Safe; for FOUNDATION Fieldbus or PROFIBUS PA Protocols only	
N7	IECEX Type n Certification	★
K7	IECEX Flame-proof, Dust Ignition-proof, Intrinsic Safety, and Type n (combination of I7, N7, and E7)	★
E2	Brazil Flameproof	★
I2	Brazil Intrinsic Safety	★

Code	Description	
IB	Brazil FISCO intrinsically safe; for FOUNDATION Fieldbus or PROFIBUS PA Protocols only	★
K2	Brazil Flameproof, Intrinsic Safety	★
E3	China Flameproof	★
I3	China Intrinsic Safety	★
EP	Republic of Korea Flameproof	
IP	Republic of Korea Intrinsic Safety	
EM	Technical Regulations Customs Union (EAC) Flameproof	★
IM	Technical Regulations Customs Union (EAC) Intrinsic Safety	★
KM	Technical Regulations Customs Union (EAC) Flameproof and Intrinsic Safety	★
KB	USA and Canada Explosion-proof, Dust Ignition Proof, Intrinsically Safe, and Division 2 (combination of K5 and C6)	★
KD	USA, Canada, and ATEX Explosion-proof, Intrinsically Safe (combination of K5, C6, I1, and E8)	★
KP	Republic of Korea Flameproof, Intrinsic Safety	

- (1) *Dust approval not applicable to transmitter wireless (output code X).*  
(2) *Nonincendive certification not provided with transmitter wireless (output code X).*  
(3) *Only available with transmitter wireless (output code X).*

### Sensor fill fluid and O-ring options

Code	Description	
L1 <sup>(1)</sup>	Inert sensor fill fluid <sup>(2)</sup>	★
L2	Graphite-filled (PTFE) O-ring	★
LA <sup>(1)</sup>	Inert sensor fill fluid and graphite-filled (PTFE) O-ring	★

- (1) *Not available with wireless output (code X).*  
(2) *Silicone fill fluid is standard.*

### Shipboard approvals

Code	Description	
SBS	American Bureau of Shipping <sup>(1)</sup>	★

- (1) *Not available with wireless output (code X).*

### Display and interface options

Code	Description	
M6 <sup>(1)</sup>	Graphical LCD display	★
M5	LCD display	★
M4 <sup>(2)</sup>	LCD display with LOI	★

- (1) *Only available with 4-20 mA HART® output (code A).*  
(2) *Only available with 4-20 mA HART output (code A) and PROFIBUS®-PA (code W).*

### Transient protection

This option is not available with wireless output (code X). The T1 option is not needed with FISCO Product Certifications; transient protection is included with the FISCO Product Certification (codes IA, IB, and IE).

Code	Description	
T1	Transient terminal block	★

**Plantweb™ control functionality**

Code	Description	
A01	FOUNDATION™ Fieldbus control function block suite	★

**Plantweb™ diagnostic functionality**

Code	Description	
DA0 <sup>(1)</sup>	Loop Integrity Diagnostic	★
DA1 <sup>(1)</sup>	Loop Integrity and Plugged Impulse Line Diagnostics	★
D01	FOUNDATION™ Fieldbus Diagnostics Suite	★

(1) Only available with 4-20 mA HART® protocol (code A).

**Low power output**

Code	Description	
C2	0.8–3.2 Vdc output with digital signal based on HART® Protocol <sup>(1)</sup>	

(1) Available with output code M only.

**Alarm levels**

Only available with HART 4–20 mA output (code A).

Code	Description	
C4 <sup>(1)</sup>	NAMUR alarm and saturation levels, high alarm	★
CN <sup>(1)</sup>	NAMUR alarm and saturation levels, low alarm	★
CR	Custom alarm and saturation signal levels, high alarm (See Rosemount 3051 <a href="#">Configuration Data Sheet</a> )	★
CS	Custom alarm and saturation signal levels, low alarm (See Rosemount 3051 <a href="#">Configuration Data Sheet</a> )	★
CT	Rosemount standard low alarm	★

(1) NAMUR-compliant operation is preset at the factory and can be changed to standard operation in the field for the standard Rosemount 3051.

**Ground screw**

Code	Description	
V5	External ground screw assembly <sup>(1)</sup>	★

(1) The V5 option is not needed with the T1 option; external ground screw assembly is included with the T1 option.

**Enhanced safety**

Code	Description	
T9	Enhanced SIS proof testing and logging <sup>(1)</sup>	★

(1) Only available with HART 4-20 mA output (Code A).

### Configuration buttons

Code	Description	
D1 <sup>(1)</sup>	Quick service buttons	★
D4 <sup>(2)</sup>	Analog zero and span	★
DZ <sup>(3)</sup>	Digital zero trim	★

(1) Only available with Graphical LCD Display (code M6).

(2) Only available with HART 4-20 mA (output code A).

(3) Only available with HART 4-20 mA (output code A) and wireless (output code X).

### Enhanced software

Enhanced software enables application specific configuration, expanded process alerts, and logging capabilities.

Code	Description	
RK	Enhanced software	★

# Specifications

## Performance specifications

### Flow performance - Flow reference accuracy

**Note**

Accuracy over range of use is always application dependent. Range 1 flow meters may experience an additional uncertainty up to 0.9 percent. Consult your Emerson representative for exact specifications.

Rosemount 3051CFA Annubar™ Flow Meter		
Ranges 2-3		±1.80% of flow rate at 8:1 flow turndown
Rosemount 3051CFC_A Compact Annubar Flow Meter – Rosemount Annubar Option A		
Ranges 2-3	Standard	±2.10% of flow rate at 8:1 flow turndown
	Calibrated	±1.80% of Flow Rate at 8:1 flow turndown
Rosemount 3051CFC_C Compact Orifice Flow Meter – Conditioning Option C		
Ranges 2-3	β = 0.4	±1.75% of flow rate at 8:1 flow turndown
	β = 0.50, 0.65	±1.95% of flow rate at 8:1 flow turndown
Rosemount 3051CFC_P Compact Orifice Flow Meter – Orifice Type Option P <sup>(1)</sup>		
Ranges 2-3		±2.00% of flow rate at 8:1 flow turndown
Rosemount 3051CFP Integral Orifice Flow Meter		
Ranges 2-3	Bore < 0.160	±3.00% of flow rate at 8:1 flow turndown
	0.160 ≤ Bore < 0.500	±1.95% of flow rate at 8:1 flow turndown
	0.500 ≤ Bore ≤ 1.000	±1.75% of flow rate at 8:1 flow turndown
	1.000 < Bore	±2.15% of flow rate at 8:1 flow turndown

(1) For line size less than 2 in. (50mm) or greater than 8 in. (200 mm), add an additional 0.5 percent uncertainty.

### Total performance

Total performance is based on combined errors of reference accuracy, ambient temperature effect, and static pressure effect at normal operating conditions (70 percent of span typical reading, 740 psi (51,02 bar) line pressure).

For ±50 °F (28 °C) temperature changes; 0–100 percent relative humidity, from 1:1 to 5:1 rangedown

Models	Total performance <sup>(1)</sup>
Rosemount 3051C Ranges 2-5	± 0.14% of span

(1) For output code W, F, and M, total performance is ±0.15 percent of span.

### Long term stability

Models	Long term stability
Rosemount 3051C	
Ranges 2-5	±0.2% of URL for 10 years ±50 °F (28 °C) temperature changes, and up to 1000 psi (68.95 bar) line pressure.

Models	Long term stability
Rosemount 3051 CD Low/Draft Range Ranges 0-1	±0.2% of URL for 1 year

### Dynamic performance

	4 - 20 mA HART <sup>®</sup> (1)	FOUNDATION <sup>™</sup> Fieldbus and PROFIBUS <sup>®</sup> PA Protocols(2)	Typical HART transmitter response time
Total Response Time ( $T_d + T_c$ )(3):			
3051C Ranges 2-5(4)	85 ms	152 ms	
3051C Range 1	255 ms	307 ms	
3051C Range 0	700 ms	N/A	
Dead time ( $T_d$ )	45 ms (nominal)	97 ms	
Update rate(5)	22 times per second	22 times per second	

- (1) Dead time and update rate apply to all models and ranges; analog output only.
- (2) Transducer block response time, Analog Input block execution time not included.
- (3) Nominal total response time at 75 °F (24 °C) reference conditions.
- (4) With option code RK, response time is 85 ms. All other options response time is 100 ms.
- (5) Does not apply to wireless (output code X). See [Wireless \(output code X\)](#) for wireless update rate.

### Line pressure effect per 1000 psi (68.95 bar)

For line pressures above 2000 psi (137.90 bar) and Ranges 4–5, see the following documents. For HART<sup>®</sup>, see the Rosemount 3051 [Reference Manual](#). For *Wireless* HART, see the Rosemount 3051 [Wireless Reference Manual](#).

For FOUNDATION<sup>™</sup> Fieldbus, see the Rosemount 3051 [Reference Manual](#). For PROFIBUS<sup>®</sup> PA, see the Rosemount 3051 [Reference Manual](#).

**Table 18: Rosemount 3051CD and 3051CF Line Pressure Effect**

Range	Line pressure effect
<b>Zero error</b>	
Ranges 2–3	±0.05% of URL/1000 psi (68.95 bar) for line pressures from 0 to 2000 psi (0 to 137.90 bar)
Range 1	±0.25% of URL/1000 psi (68.95 bar) for line pressures from 0 to 2000 psi (0 to 137.90 bar)
Range 0	±0.125% of URL/100 psi (6.89 bar) for line pressures from 0 to 750 psi (0 to 51.71 bar)
<b>Span error</b>	
Ranges 2–3	±0.1% of reading/1000 psi (68.95 bar)
Range 1	±0.4% of reading/1000 psi (68.95 bar)
Range 0	±0.15% of reading/100 psi (6.895 bar)

### Ambient temperature effect per 50 °F (28 °C)

#### Rosemount 3051C

- Ranges 2-5** ±(0.0125% URL + 0.0625% span) from 1:1 to 5:1  
±(0.025% URL + 0.125% span) from 5:1 to 150:1
- Range 1** ±(0.1% URL + 0.25% span) from 1:1 to 30:1

	$\pm(0.14\% \text{ URL} + 0.15\% \text{ span})$ from 30:1 to 50:1
<b>Range 0</b>	$\pm(0.25\% \text{ URL} + 0.05\% \text{ span})$ from 1:1 to 30:1

## Mounting position effect

**Rosemount 3051C:** Zero shifts up to  $\pm 1.25$  inH<sub>2</sub>O (3,11 mbar), which can be calibrated out. No span effect.

## Vibration effect

### Rosemount 3051CFC

#### ■ Vibration Structural Limits

- Qualified per the requirements of IEC61298-3 (2008) for field with general application or pipeline with low vibration level (10–1000 Hz test frequency range, 0.15 mm displacement peak amplitude, 20 m/s<sup>2</sup> acceleration amplitude).
- The weight and length of the transmitter assembly shall not exceed 9.8 lb (4,45 kg) and 8.60 in. (218,44 mm).

#### ■ Vibration Performance Specifications

- Less than  $\pm 0.1$  percent of URL when tested per the requirements of IEC60770-1 field or pipeline with high vibration level (10–60 Hz 0.21 mm displacement peak amplitude/60–2000 Hz 3g).

---

### Note

SST temperature housing is not recommended with Primary Element Technology A in applications with mechanical vibration.

---

### Rosemount 3051CFA

#### ■ Vibration Structural Limits

- Due to wide variation in Annubar™ flow meter models, no structural limits are specified. For more information about application questions, contact your local Emerson representative.

#### ■ Vibration Performance Specifications

- Less than  $\pm 0.1$  percent of URL when tested per the requirements of IEC60770-1 field or pipeline with high vibration level (10–60 Hz 0.21 mm displacement peak amplitude/60–2000 Hz 3 g).

### Rosemount 3051CFP

#### ■ Vibration Structural Limits

- Qualified per the requirements of IEC60068-2-6 (2007) for field with general application or pipeline with low vibration level (10 to 1000 Hz test frequency range, 0.075 mm displacement peak amplitude, 10 m/s<sup>2</sup> acceleration amplitude).
- The weight of the transmitter assembly shall not exceed 12.6 lb (5,72 kg).

#### ■ Vibration Performance Specifications

- Less than  $\pm 0.1$  percent of URL when tested per the requirements of IEC60770-1 field or pipeline with high vibration level (10–60 Hz 0.21 mm displacement peak amplitude/60–2000 Hz 3g).

## Power supply effect

Less than  $\pm 0.005$  percent of calibrated span per volt change.

## Electromagnetic compatibility

Meets all industrial environment requirements of EN61326 and NAMUR NE-21. Maximum deviation  $< 1\%$  span during EMC disturbance.

**Note**

NAMUR NE-21 does not apply to Low-Power (Transmitter output option code M) or Wireless (Transmitter output code X).

**Note**

During surge event, device with 4–20mA (Transmitter output option code A) may exceed maximum EMC deviation limit or reset; however, device will self-recover and return to normal operation within specified start-up time.

**Transient protection (option code T1)**

Tested in accordance with IEEE C62.41.2-2002, location category B

- 6 kV crest (0.5 μs - 100 kHz)
- 3 kA crest (8 x 20 μs)
- 6 kV crest (1.2 x 50 μs)

**Functional specifications**

**Range and sensor limits**

Range	Minimum span Rosemount 3051CD, 3051CF	Range and sensor limits	
		Upper (URL)	Lower (LRL)
			Rosemount 3051CD Differential, 3051CF Flow Meters
1	0.50 inH <sub>2</sub> O (1.24 mbar)	25.00 inH <sub>2</sub> O (62.16 mbar)	0 inH <sub>2</sub> O (0 mbar)
2	1.67 inH <sub>2</sub> O (4.15 mbar)	250.00 inH <sub>2</sub> O (621.60 mbar)	0 inH <sub>2</sub> O (0 mbar)
3	6.67 inH <sub>2</sub> O (16.58 mbar)	1000.00 inH <sub>2</sub> O (2.48 bar)	0 inH <sub>2</sub> O (0 mbar)

**Service**

Liquid, gas, and vapor applications.

**4–20 mA HART® (output code A)**

**Power supply**

External power supply required. Standard transmitter (4–20 mA) operates on 10.5–42.4 Vdc with no load.

**Load limitations**

Maximum loop resistance is determined by the voltage level of the external power supply described by:

Max. loop resistance = 43.5 (power supply voltage - 10.5)

Communication requires a minimum loop resistance of 250 ohms.

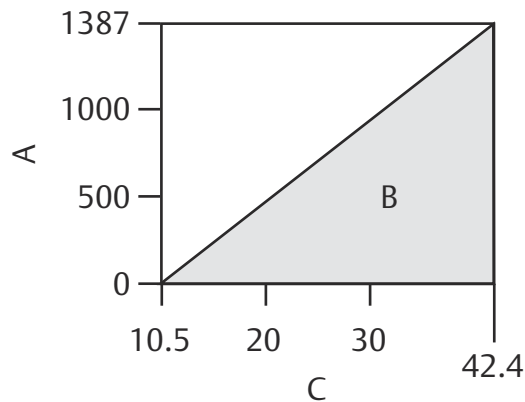

- A. Load ( $\Omega$ s)  
 B. Operating region  
 C. Voltage (Vdc)

---

**Note**

For CSA approval, power supply must not exceed 42.4 V.

---

**Indication**

Optional 2-line LCD/LOI Display

Optional 3-line Graphical Display with Backlight and Local Language

- Languages include: English, Chinese, French, German, Italian, Portuguese, Russian, and Spanish

**Optional configuration buttons**

Configuration buttons need to be specified:

- Quick service buttons (option D1) allow for straightforward commissioning using a simple menu without needing to remove the housing cover. The quick service button option allows users to zero, rerange their device, perform a loop test, view configuration, and flip the graphical LCD display screen in the field.
- Digital Zero trim (option code DZ) changes digital value of the transmitter and is used for performing a sensor zero trim.
- Analog Zero and Span (option code D4) changes analog value and can be used to rerange the transmitter with an applied pressure.

**Output**

Two-wire 4–20 mA, user selectable for linear or square root output. Digital process variable superimposed on 4–20 mA signal, available to any host that conforms to HART® Protocol.

**Bluetooth® Connectivity**

Typical Range: At least 50 ft. (15 m) line of sight. Maximum communication range will vary depending on orientation, obstacles (person, metal, wall, etc.), or electromagnetic environment.

**Output**

Two-wire 4–20 mA, user selectable for linear or square root output. Digital process variable superimposed on 4–20 mA signal, available to any host that conforms to HART® Protocol.

**FOUNDATION™ Fieldbus (output code F)**

**Power supply**

External power supply required; transmitters operate on 9.0 to 32.0 Vdc transmitter terminal voltage. FISCO transmitters operate on 9.0 to 17.5 Vdc.

**Current draw**

17.5 mA for all configurations (including display option)

**Indication**

Optional two-line LCD display

**FOUNDATION Fieldbus block execution times**

Block	Execution time
Resource	N/A
Sensor and SPM transducer	N/A
LCD display	N/A
Analog input 1, 2	20 milliseconds
PID	25 milliseconds
Input selector	20 milliseconds
Arithmetic	20 milliseconds
Signal characterizer	20 milliseconds
Integrator	20 milliseconds
Output splitter	20 milliseconds
Control selector	20 milliseconds

**FOUNDATION Fieldbus parameters**

- Links:** 25 max.
- Virtual communications relationship (VCR):** 20 max.

**FOUNDATION Fieldbus function blocks (option A01)**

- Resource block** The resource block contains diagnostic, hardware, and electronics information. There are no linkable inputs or outputs to the resource block.
- Sensor transducer block** The sensor transducer block contains sensor information and the ability to calibrate the pressure sensor or recall factory calibration.
- LCD transducer block** The LCD display transducer block is used to configure the LCD display meter.
- Analog input block** The Analog Input (AI) function block processes the measurements from the sensor and makes them available to other function blocks. The output value from the AI block is in engineering units and contains a status indicating the quality of the measurement. The AI block is widely used for scaling functionality.
- Input selector block** The Input Selector (ISEL) function block can be used to select the first good, hot backup, maximum, minimum, or average of as many as eight input values and place it at the output. The block supports signal status propagation.
- Integrator block** The Integrator (INT) function block integrates one or two variables over time. The block compares the integrated or accumulated value to pre-trip and trip limits and generates discrete output

signals when the limits are reached. The INT function block is used as a totalizer. This block will accept up to two inputs, has six options how to totalize the inputs, and two trip outputs.

<b>Arithmetic block</b>	The Arithmetic (ARTH) function block provides the ability to configure a range extension function for a primary input. It can also be used to compute nine different arithmetic functions including flow with partial density compensation, electronic remote seals, hydrostatic tank gaging, ratio control, and others.
<b>Signal characterizer block</b>	The Signal Characterizer (SGCR) function block characterizes or approximates any function that defines an input/output relationship. The function is defined by configuring as many as 20 X,Y coordinates. The block interpolates an output value for a given input value using the curve defined by the configured coordinates. Two separate analog input signals can be processed simultaneously to give two corresponding separate output values using the same defined curve.
<b>PID block</b>	The PID function block combines all of the necessary logic to perform proportional/integral/derivative PID control. The block supports mode control, signal scaling and limiting, feed forward control, override tracking, alarm limit detection, and signal status propagation.
<b>Control selector block</b>	The control selector function block selects one of two or three inputs to be the output. The inputs are normally connected to the outputs of PID or other function blocks. One of the inputs would be considered normal and the other two overrides.
<b>Output splitter block</b>	The output splitter function block provides the capability to drive two control outputs from a single input. It takes the output of one PID or other control block to control two valves or other actuators.

### Backup Link Active Scheduler (LAS)

The transmitter can function as an LAS if the current link master device fails or is removed from the segment.

### FOUNDATION Fieldbus Diagnostics Suite (option code D01)

The Rosemount 3051C FOUNDATION Fieldbus Diagnostics Suite features SPM technology to detect changes in the process, process equipment, or installation conditions (such as plugged impulse lines) of the transmitter. This is done by modeling the process noise signature (using the statistical values of mean and standard deviation) under normal conditions and then comparing the baseline values to current values over time. If a significant change in the current values is detected, the transmitter can generate an alert.

## PROFIBUS® PA (output code W)

### Profile version

3.02

### Power supply

External power supply required; transmitters operate on 9.0 to 32.0 Vdc transmitter terminal voltage. FISCO transmitters operate on 9.0 to 17.5 Vdc.

### Current draw

17.5 mA for all configurations (including LCD display option)

### Output update rate

Four times per second

### Standard function block

<b>Analog input (AI block)</b>	The AI function block processes the measurements and makes them available to the host device. The output value from the AI block is in engineering units and contains a status indicating the quality of the measurement. The AI block is widely used for scaling functionality.
--------------------------------	--

---

**Note**

The channel, Set XD\_Scale, Set L\_Type, and sometimes Set Out\_Scale are typically configured by instrument personnel. Other AI block parameters, block links, and schedule are typically configured by the control systems configuration engineer.

---

**Indication**

Optional two-line LCD display

**LOI**

The LOI uses a two-button menu with external configuration buttons.

**Wireless (output code X)****Output**

IEC 62591 (*WirelessHART*®), 2.4 GHz DSSS

**Wireless radio (internal antenna, WP5 option)**

- Frequency: 2.400 – 2.485 GHz
- Channels: 15
- Modulation: IEEE 802.15.4 compliant DSSS
- Transmission: Maximum of 10 dBm EIRP

**Local display**

The optional three-line, seven-digit LCD display can display user-selectable information, such as primary variable in engineering units, scaled variable, percent of range, sensor module temperature, and electronics temperature. The display updates based on the wireless update rate.

**Digital zero trim**

Digital zero trim (option DZ) is an offset adjustment to compensate for mounting position effects, up to 5 percent of URL.

**Update rate**

User selectable 1 second to 60 minute.

**Wireless sensor module for in-line transmitters**

The Rosemount 3051 Wireless Transmitter requires the engineered polymer housing to be selected. The standard sensor module will come with aluminum material. If SST is required, you must select the option WSM.

**Power module**

Field replaceable, keyed connection eliminates the risk of incorrect installation, Intrinsically Safe Lithium-thionyl chloride Power Module with PBT/PC enclosure. Ten-year life at one minute update rate<sup>(10)</sup>.

---

**Note**

Continuous exposure to ambient temperature limits of -40 °F or 185 °F (-40 °C or 85 °C) may reduce specified life by less than 20 percent.

---

---

(10) Reference conditions are 70 °F (21 °C), and routing data for three additional network devices.

## Low power output

### 1–5 Vdc HART® low power (output code M)

#### Output

The default three-wire 1–5 Vdc is a user-selectable output. Also user selectable for linear or square root output configuration. Digital process variable superimposed on voltage signal, available to any host conforming to the HART Protocol. Low-power transmitter operates on 6–12 Vdc with no load. Option code C2 changes the output from 1–5 Vdc to 0.8–3.2 Vdc.

#### Power consumption

3.0 mA, 18–36 mW

#### Minimum load impedance

100 k $\Omega$  ( $V_{out}$  wiring)

#### Indication

Optional five-digit LCD display

## Overpressure limits

### Rosemount 3051CD/CF

- Range 1: 2000 psig (137.90 bar)
- Ranges 2–5: 3626 psig (250.00 bar), 4500 psig (310.26 bar) for option code P9

## Static pressure limit

### Rosemount 3051CD only

Operates within specifications between static line pressures of 0.5 psia and 3626 psig (4500 psig (310.26 bar) for option code P9).

Range 0: 0.5 psia and 750 psig (0.03 bar and 51.71 bar)

Range 1: 0.5 psia and 2000 psig (0.03 bar and 137.90 bar)

## Burst pressure limits

### Rosemount 3051C, 3051CF coplanar or traditional transmitter flange

10081 psig (695,06 bar)

### Rosemount 3051T in-line

- Ranges 0–4: 11016 psi (759.53 bar)
- Range 5: 26016 psig (1793.74 bar)
- Range 6: 46092 psi (3177.93 bar)

## Failure mode alarm

### HART 4–20 mA (output option code A)

If self-diagnostics detect a sensor or microprocessor failure, the analog signal is driven either high or low to alert the user. High or low failure mode is user-selectable with a jumper/switch on the transmitter. The values to which the transmitter drives its output in failure mode depend on whether it is configured to standard, NAMUR-compliant, or custom levels. The values for each are as follows:

**Table 19: Failure mode alarm**

	High alarm	Low alarm
Default	$\geq 21.75^{(1)}$ mA	$\leq 3.75$ mA
NAMUR compliant <sup>(2)</sup>	$\geq 22.5$ mA	$\leq 3.6$ mA
Custom levels <sup>(3)</sup>	20.2 – 23.0 mA	3.6 – 3.8 mA

(1) High Alarm default is  $\geq 22.5$  mA for some options (codes M6, DA1, T9, RK).

(2) See option codes C4 or CN.

(3) Low alarm must be 0.1 mA less than low saturation and high alarm must be 0.1 mA greater than high saturation.

### Output code M

If self-diagnostics detect a gross transmitter failure, the analog signal will be driven either below 0.94 V or above 5.4 V to alert the user (below 0.75 V or above 4.4 V for Option C2). High or low alarm signal is user-selectable by internal jumper.

### Output code F, W, and X

If self-diagnostics detect a gross transmitter failure, that information gets passed as an alert and a status along with the process variable.

## Temperature Limits

### Ambient

- -40 to 185 °F (-40 to 85 °C)
- With display<sup>(11)(12)(13)</sup>: -40 to 176 °F (-40 to 80 °C)
- With option code BR5: -58 to 185 °F (-50 to 85 °C)
- With option code BR6: -76 to 185 °F (-60 to 85 °C)

### Storage

#### Note

If storage temperature is above 185 °F (85 °C), perform a sensor trim prior to installation.

- -76 to 230 °F (-60 to 110 °C)
- With display: -76 to 185 °F (-60 to 85 °C)
- With wireless output: -40 °F to 185 °F (-40 °C to 85 °C)

### Rosemount 3051CFA temperature limits

#### Process temperature limits

- |                                 |   |
|---------------------------------|---|
| <b>Direct mount transmitter</b> | <ul style="list-style-type: none"> <li>▪ 500 °F (260 °C)</li> <li>▪ 750 °F (398 °C) when used with a direct mount, high temperature 5-valve manifold (transmitter connection platform code 6). Maximum temperature limit for steam processes with Flange-Lok and Pak-Lok connections is 600 °F (316 °C).</li> </ul> |
| <b>Remote mount transmitter</b> | <ul style="list-style-type: none"> <li>▪ 1250 °F (677 °C) – Alloy C-276 sensor material <sup>(14)</sup></li> <li>▪ 850 °F (454 °C) – SST sensor material</li> </ul>   |

(11) LCD display may not be readable and LCD display updates will be slower at temperatures below -22 °F (-30 °C).

(12) Wireless LCD display may not be readable and LCD display updates will be slower at temperature below -4 °F (-20 °C).

(13) Graphical LCD display updates will be slower at temperatures below 32 °F (0 °C). Graphical LCD display may not be readable below -22 °F (-30 °C).

(14) For superheated steam applications above 1,000 °F (538 °C), it is recommended that the Rosemount 585 with alloy 800H sensor material is used.

**Pressure and temperature limits**

**Note**

Static pressure selection may effect pressure limitations.

- Direct mount transmitter**
  - Up to Class 600 ANSI (1440 psig at 100 °F [99 bar at 38 °C])
  - Integral temperature measurement is not available with flanged mounting type greater than Class 600
- Remote mount transmitter**
  - Up to Class 2500 ANSI (6000 psig at 100 °F [416 bar at 38 °C])

**Rosemount 3051CFC temperature limits**

**Process temperature limits**

- Direct mount transmitter** ■ -40 to 450 °F (-40 to 232 °C)
- Remote mount transmitter** ■ -315 to 850 °F (-192 to 454 °C)

**Rosemount 3051CFP temperature limits**

**Process temperature limits**

- Standard (direct mount)** ■ -40 to 550 °F (-40 to 288 °C)
- Standard (Remote mount with PTFE O-rings)** ■ -40 to 572°F (-40 to 300°C)
- Extended (remote mount only with option code G)**
  - -112 to 850 °F (-80 to 454 °C)
  - Consult factory for all-welded design for extended temperature.

**Process connection temperature limits**

At atmospheric pressures and above.

Rosemount 3051CD and 3051CF	
Silicone fill sensor <sup>(1)</sup>	
With coplanar flange	-40 to 250 °F (-40 to 121 °C) <sup>(2)</sup>
Inert fill sensor <sup>(1)(3)</sup>	-40 to 185 °F (-40 to 85 °C) <sup>(4)</sup>
With Option Code BR6, coplanar flange	-76 to 250 °F (-60 to 121 °C) <sup>(2)</sup>

(1) Process temperatures above 185 °F (85 °C) require derating the ambient limits by a 1.5:1 ratio.  
 (2) 220 °F (104 °C) limit in vacuum service; 130 °F (54 °C) for pressures below 0.5 psia.  
 (3) Inert fill with traditional flange on Range 0: limits are 32 to 185 °F (0 to 85 °C).  
 (4) 160 °F (71 °C) limit in vacuum service.

**Humidity limits**

0-100 percent relative humidity

**Turn-on time**

Performance within specifications less than 2.0 seconds (20.0 seconds for PROFIBUS® PA and FOUNDATION™ Fieldbus Protocols) after power is applied to the transmitter.

**Note**

Does not apply to wireless option code X.

## Volumetric displacement

Less than 0.005-in<sup>3</sup> (0.08 cm<sup>3</sup>)

## Damping

### 4–20 mA HART®

Analog output response to a step input change is user-enterable from 0.0 to 60 seconds for one time constant. This software damping is in addition to sensor module response time.

### FOUNDATION™ Fieldbus

- Transducer block: User configurable
- AI Block: User configurable

### PROFIBUS® PA

AI Block only: User configurable

## Physical specifications

### Material selection

Emerson provides a variety of Rosemount products with various product options and configurations including materials of construction that can be expected to perform well in a wide range of applications. The Rosemount product information presented is intended as a guide for the purchaser to make an appropriate selection for the application. It is the purchaser's sole responsibility to make a careful analysis of all process parameters (such as all chemical components, temperature, pressure, flow rate, abrasives, contaminants, etc.), when specifying product materials, options, and components for the particular application. Emerson is not in a position to evaluate or guarantee the compatibility of the process fluid or other process parameters with the product options, configuration, or materials of construction selected.

### Electrical connections

½–14 NPT, G½, and M20 x 1.5 conduit. The polymer housing (code P) has no conduit entries. HART interface connections fixed to terminal block for output code A and to 701P Power Module for output code X.

### Process connection

#### Rosemount 3051C

- ¼–18 NPT on 2½ in. centers
- ½–14 NPT on 2-, 2⅞, or 2¼ in. centers

### Process-wetted parts

#### Rosemount 3051CFA - Rosemount Annubar sensor material

- 316 SST
- Alloy C-276

---

#### Note

Cage nipple is made from 304 SST.

---

**Rosemount 3051CFC - Material of construction**

- |  |  |
|--|--|
| <b>Body/plate</b>                            | <ul style="list-style-type: none"> <li>■ 316/316L SST</li> <li>■ 50 micro-inch Ra surface finish</li> </ul>  |
| <b>Manifold head/valves</b>                  | <ul style="list-style-type: none"> <li>■ 316 SST</li> </ul>  |
| <b>Flange studs and nuts</b>                 | <ul style="list-style-type: none"> <li>■ Customer supplied</li> <li>■ Available as a spare part</li> </ul>   |
| <b>Transmitter connection studs and nuts</b> | <ul style="list-style-type: none"> <li>■ Studs- 300 Series Stainless Steel</li> <li>■ Nuts- A194 Grade 8M</li> </ul>   |
| <b>Gasket and O-rings</b>                    | <ul style="list-style-type: none"> <li>■ Gaskets are customer supplied</li> <li>■ Durlon 8500 fiber gaskets are recommended. Consult an Emerson representative for use with other gaskets.</li> <li>■ Available as a spare part</li> </ul> |

**Rosemount 3051CFP - material of construction**

- |                                      |  |
|--------------------------------------|--|
| <b>Orifice plate</b>                 | <ul style="list-style-type: none"> <li>■ 316/316L SST</li> <li>■ Alloy C-276</li> <li>■ Alloy 400</li> </ul>   |
| <b>Body</b>                          | <ul style="list-style-type: none"> <li>■ A312 Gr 316/316L</li> </ul>   |
| <b>Pipe material (if applicable)</b> | <ul style="list-style-type: none"> <li>■ A312 Gr 316/316L</li> </ul>   |
| <b>Flange</b>                        | <ul style="list-style-type: none"> <li>■ A182 Gr 316/316L</li> <li>■ Flange pressure limits are per ANSI B16.5 or DIN EN 1092-1</li> <li>■ Flange face finish per ANSI B16.5 or DIN EN 1092-1, 125, to 250 RMS</li> </ul>  |
| <b>Body bolts/studs</b>              | <ul style="list-style-type: none"> <li>■ 300 Series Stainless Steel</li> <li>■ ASTM A193 Gr B8M Class 2 body studs provided for high temperature option code GT</li> <li>■ ASTM A193 Gr B8M Class 2 body studs provided for 1-½-in. (code 015) line size units ordered with high pressure process connection option codes W9, R9, T1, S1, or P2</li> </ul> |
| <b>Transmitter connection studs</b>  | <ul style="list-style-type: none"> <li>■ 300 Series Stainless Steel</li> </ul>   |
| <b>Gaskets/O-rings</b>               | <ul style="list-style-type: none"> <li>■ Glass filled PTFE</li> <li>■ Alloy X-750 provided for high temperature option code GT</li> <li>■ Gaskets and O-rings must be replaced each time the Rosemount 3051CFP is disassembled for installation or maintenance</li> </ul>  |

**Orifice type****Square edge – Orifice bore sizes**

0.066 in. and larger

**Quadrant edge – Orifice bore sizes (for ½ in. [15 mm] line size only)**

- 0.034 in. (0.86 mm)

- 0.020 in. (0.51 mm)
- 0.014 in. (0.35 mm)
- 0.010 in. (0.25 mm)

**Note**

Integral orifice bodies contain corner tapped pressure ports.

**Transmitter process-wetted parts****Drain/vent valves**

316 SST, alloy C-276, or alloy 400 material

**Transmitter flanges and adapters**

- Plated CS
- SST: CF-8M (Cast 316 SST) per ASTM A743
- Cast C-276: CW-12MW per ASTM A494
- Cast Alloy 400: M-30C per ASTM A494

**Wetted O-rings**

Glass-filled PTFE or graphite-filled PTFE

**Isolating diaphragm material 3051CD/3051CD2**

- 316L SST (UNS S31603)
- Alloy C-276 (UNS N10276)
- Alloy 400 (UNS N04400)
- Tantalum (UNS R05440)
- Gold-plated alloy 400
- Gold-plated 316L SST

**Non-wetted parts****Electronics housing**

Low-copper aluminum or CF-8M (cast version of 316 SST). Enclosures meet NEMA type 4X, IP66, and IP68 when properly installed.

Housing material code P: PBT/PC with NEMA 4X and IP66/67/68

**Coplanar sensor module housing**

CF-3M (Cast version of 316L SST, material per ASTM-A743)

**Bolts**

- TM A449, type 1 (zinc-cobalt plated CS)
- ASTM F593G, condition CW1 (austenitic 316 SST)
- ASTM A193, grade B7M (zinc plated alloy steel)
- Alloy K-500

**Sensor module fill fluid**

Silicone oil (D.C. 200)

### **Paint**

Polyurethane

### **Cover O-rings**

- Buna-N
- Silicone (for wireless option code X)

### **Power module**

Field replaceable, keyed connection eliminates the risk of incorrect installation, Intrinsically Safe lithium-thionyl chloride power module with PBT enclosure.

# Product certifications

## Rosemount 3051 product certifications

Rev 2.19

### European directive information

A copy of the EU Declaration of Conformity can be found at the end of the Quick Start Guide. The most recent revision of the EU Declaration of Conformity can be found at [Emerson.com/global](https://emerson.com/global).

### Federal Communication Commission (FCC) notice

This device complies with Part 15 of the Federal Communication Commission Rules.

Operation is subject to the following conditions: This device may not cause harmful interference; this device must accept any interference received, including interference that may cause undesired operation. This device must be installed to ensure a minimum antenna separation distance of 7.9 in. (20 cm) from all persons. Changes or modification to the equipment not expressly approved by Rosemount, Inc. could void the user's authority to operate the equipment.

### Innovation, Science, and Economic Development (ISED) notice

This device contains license-exempt transmitter(s)/receiver(s) that comply with Innovation, Science, and Economic Development Canada's license-exempt RSS(s). Operation is subject to the following two conditions: This device may not cause interference. This device must accept any interference, including interference that may cause undesired operation of the device.

*Cet appareil est conforme à la norme RSS-247 Industrie Canada exempt de licence. Son fonctionnement est soumis aux deux conditions suivantes: (1) cet appareil ne doit pas provoquer d'interférences et (2) cet appareil doit accepter toute interférence, y compris les interférences pouvant causer un mauvais fonctionnement du dispositif.*

### Ordinary location certification

As standard, the transmitter has been examined and tested to determine that the design meets the basic electrical, mechanical, and fire protection requirements by a Nationally Recognized Test Laboratory (NRTL) as accredited by the Federal Occupational Safety and Health Administration (OSHA).

## North America

### E5 USA Explosion-proof (XP) and Dust-Ignition-proof (DIP)

<b>Certificate</b>	FM16US0121 Range 1-5 (HART® only)
<b>Standards</b>	FM 3600: 2018, FM 3615: 2018, FM 3616: 2011, FM 3810: 2005, ANSI/NEMA® 250: 2008
<b>Markings</b>	XP: CL I, DIV 1, GP B, C, D, T5; DIP: CL II, DIV 1, GP E, F, G; CL III; T5 (-58 °F [-50 °C] ≤ T <sub>a</sub> ≤ 185 °F [85 °C]) Type 4X
<b>Certificate</b>	1053834 Ranges 1-6
<b>Standards</b>	FM 3600: 2022, FM 3610: 2021, FM 3615: 2022, FM 3616: 2022, ANSI/UL 61010-1-2019 Third Edition, ANSI-ISA-12.27.01-2022, ANSI/UL 50E (First Edition)
<b>Markings</b>	XP: CL I, DIV 1, GP B, C, D T5;

Seal not required  
 DIP: CL II, DIV 1, GP E, F, G; CL III T5;  
 (-58 °F [50 °C] ≤ T<sub>a</sub> ≤ 185 °F [85 °C])  
 Type 4X, IP 68  
 Optional: single seal

#### Specific Conditions for Use:

1. The Model 3051 transmitter housing may contain aluminum and is considered a potential risk of ignition by impact or friction. Care must be taken during installation and use to prevent impact and friction.
2. Equipment evaluated for atmospheric pressure range between 80 kPa (0.8 bar) to 110 kPa (1.1 bar).
3. Process temperature limits shall be in accordance with 03031-1053.
4. Flameproof joints are not intended for repair.

#### IS USA Intrinsic Safety (IS) and Nonincendive (NI)

**Certificate** FM16US0120X  
 Ranges 1-5 (HART® only)

**Standards** FM 3600: 2011, FM 3610: 2010, FM 3611: 2004, FM 3810: 2005, ANSI/NEMA 250: 2008

**Markings** IS: CL I, DIV 1, GP A, B, C, D T4  
 CL II, DIV 1, GP E, F, G; CL III  
 NI: CL 1, DIV 2, GP A, B, C, D; T4  
 HART: (-50 °C ≤ T<sub>a</sub> ≤ +70 °C)  
 FOUNDATION™ Fieldbus/PROFIBUS®-PA: (-58 °F [-50 °C] ≤ T<sub>a</sub> ≤ 140 °F [60 °C])  
 Install per 03031-1019.  
 Type 4X

#### Special Conditions for Safe Use (X):

1. The Rosemount 3051 Transmitter housing contains aluminum and is considered a potential risk of ignition by impact or friction. Care must be taken into account during installation and use to prevent impact and friction.
2. The Rosemount 3051 Transmitter with the transient terminal block (option code T1) will not pass the 500 Vrms dielectric strength test, and this must be taken into account during installation.

**Certificate** 1053834  
 Ranges 1-6

**Standards** FM 3600: 2022, FM 3610: 2018, FM 3611: 2021, ANSI/UL 61010-1-2019 Third Edition, ANSI/UL 60079-0: 2017, ANSI/UL 60079-11: 2013, ANSI-ISA-12.27.01-2022, ANSI/UL 50E (First Edition)

**Markings** IS: CL I GP ABCD T4  
 IS: CL II GP EFG; CL III T4  
 CL I ZN 0 AEx ia IIC T4 Ga  
 NI: CL I DIV 2 GP ABCD T4  
 -76 °F (-60 °C) ≤ T<sub>a</sub> ≤ 158 °F (70 °F)  
 Optional: single seal  
 Type 4X IP 68  
 INSTALL PER 03031-1024

#### Specific Conditions for Use

1. The Rosemount 3051 Transmitter housing contains aluminum and is considered a potential risk of ignition by impact or friction. Care must be taken into account during installation and use to prevent impact and friction.

2. The Rosemount 3051 Transmitter with the transient terminal block (option code T1) will not pass the 500 Vrms dielectric strength test, and this must be taken into account during installation.
3. Equipment evaluated for atmospheric pressure range between 80 kPa (0.8 bar) to 110 kPa (1.1 bar).
4. Maximum process temperature limits shall be in accordance with 03031-1053.

### IE USA FISCO

<b>Certificate</b>	FM16US0120X Ranges 1-5
<b>Standards</b>	FM 3600: 2011, FM 3610: 2010, FM 3611: 2004, FM 3810: 2005, ANSI/NEMA® 250: 2008
<b>Markings</b>	IS: CL I, DIV 1, GP A, B, C, D T4; CL II, DIV 1, GP E, F, G; CL III -58 °F (-50 °C) ≤ T <sub>a</sub> ≤ 140 °F (60 °C) FISCO Install per 03031-1019 Type 4X

### Special Conditions for Safe Use (X):

1. The Rosemount 3051 Transmitter housing contains aluminum and is considered a potential risk of ignition by impact or friction. Care must be taken into account during installation and use to prevent impact and friction.

<b>Certificate</b>	1053834
<b>Standards</b>	FM 3600: 2022, FM 3610: 2018, FM 3611: 2021, ANSI/UL 61010-1-2019 Third Edition, ANSI/UL 60079-0: 2017, ANSI/UL 60079-11: 2013, ANSI-ISA-12.27.01-2022, ANSI/UL 50E (First Edition)
<b>Markings</b>	IS: CL I GP ABCD T4 CL I ZN 0 AEx ia IIC T4 Ga 140 °F (-60 °C) ≤ T <sub>a</sub> ≤ 158 °F (70 °C) FISCO Optional: single seal Type 4X, IP 68 Install per 03031-1024.

### Specific Conditions for Use

1. The Rosemount 3051 Transmitter housing contains aluminum and is considered a potential risk of ignition by impact or friction. Care must be taken into account during installation and use to prevent impact and friction.
2. Equipment evaluated for atmospheric pressure range between 80 kPa (0.8 bar) to 110 kPa (1.1 bar).
3. Process temperature limits shall be in accordance with 03031-1053.

### C6 Canada Explosion-proof, Dust Ignition-proof, Intrinsic Safety, and Nonincendive

<b>Certificate</b>	1053834
<b>Standards</b>	CAN/CSA C22.2 No. 61010-1-12, CAN/CSA C22.2 No. 94.2-20, CSA C22.2 No. 25-17, CAN/CSA C22.2 No. 30:20, CAN/CSA C22.2 No. 213-17 +UPD1 (2018)+UPD2 (2019)+UPD3 (2021), CAN/CSA C22.2 No. 60079-0:19, CAN/CSA C22.2 No. 60079-1:16, CAN/CSA-60079-11:14, ANSI-ISA-12.27.01-2021
<b>Markings</b>	XP: CL I, DIV 1, GP B, C, D T5 Ex db IIC T5 Gb Seal not required (-50 °C ≤ T <sub>a</sub> ≤ +85 °C); DIP: CL II, DIV 1, GP E, F, G; CL III T5;

T5:  $-50\text{ °C} \leq T_a \leq +85\text{ °C}$   
 IS: CL I DIV 2 GP ABCD T4  
 T4:  $-60\text{ °C} \leq T_a \leq +70\text{ °C}$ ;  
 Install per 03031-1024 (IS/NI only)  
 Single seal - temp limits 03031-1053  
 Type 4X, IP 68

**Specific Conditions for Use:**

1. The Rosemount 3051 Transmitter housing contains aluminum and is considered a potential risk of ignition by impact or friction. Care must be taken into account during installation and use to prevent impact and friction.
2. Equipment evaluated for atmospheric pressure range between 80 kPa (0.8 bar) to 110 kPa (1.1 bar).
3. The Rosemount 3051 Transmitter with the transient terminal block (option code T1) will not pass the 500 Vrms dielectric strength test, and this must be taken into account during installation.
4. Flame-proof joints are not intended for repair.

**E6 Canada Explosion-proof, Dust Ignition-proof, and Division 2**

**Certificate** 1053834

**Standards** CAN/CSA C22.2 No. 61010-1-12, CAN/CSA C22.2 No. 94.2-20, CSA C22.2 No. 25-17, CAN/CSA C22.2 No. 30:20, CAN/CSA C22.2 No. 213-17 +UPD1 (2018) +UPD2 (2019) +UPD3 (2021), CAN/CSA C22.2 No. 60079-0:19, CAN/CSA C22.2 No. 60079-1:16, ANSI-ISA-12.27.01-2021

**Markings** XP: CL I, DIV 1, GP B, C, D T5  
 Ex db IIC T5 Gb  
 Seal not required  
 DIP: CL II, DIV 1, GP E, F, G; CL III T5;  
 T5:  $-50\text{ °C} \leq T_a \leq +85\text{ °C}$   
 NI: CL I DIV 2 GP ABCD T4  
 T4:  $-60\text{ °C} \leq T_a \leq +70\text{ °C}$ ;  
 Single seal - temp limits per 03031-1053  
 Type 4X, IP 68



**Specific Conditions for Use:**

1. The Rosemount 3051 Transmitter housing contains aluminum and is considered a potential risk of ignition by impact or friction. Care must be taken into account during installation and use to prevent impact and friction.
2. Equipment evaluated for atmospheric pressure range between 80 kPa (0.8 bar) to 110 kPa (1.1 bar).
3. Flame-proof joints are not intended for repair.

**Europe****E8 ATEX Flame-proof and Dust**

**ATEX Certificate** KEMA00ATEX2013X (Ex db); Baseefa11ATEX0275X (Ex ta)

**Standards Used** EN IEC 60079-0: 2018, EN 60079-1: 2014, EN 60079-26: 2015, EN 60079-31: 2014

**Markings**  II ½ G Ex db IIC T6...T4 Ga/Gb T6  
 T6:  $-60\text{ °C} \leq T_a \leq +70\text{ °C}$   
 T4/T5:  $-60\text{ °C} \leq T_a \leq +80\text{ °C}$ ;  
 II 1 D Ex ta IIIC T<sub>500</sub>105 °C Da

$$-20\text{ °C} \leq T_a \leq +85\text{ °C}$$



**Table 20: Process temperature**

Temperature class	Process connection temperature	Ambient temperature
T6	-60 °C to +70 °C	-60 °C to +70 °C
T5	-60 °C to +80 °C	-60 °C to +80 °C
T4	-60 °C to +120 °C	-60 °C to +80 °C

**Special Conditions for Safe Use (X):**

1. This device contains a thin wall diaphragm less than 1 mm thick that forms a boundary between Category 1G (process connection) and Category 2G (all other parts of the equipment). The model code and datasheet are to be consulted for details of the diaphragm material. During installation, maintenance, and use, the environmental conditions to which the diaphragm will be subjected shall be taken into account. The manufacturer's instructions for installation and maintenance shall be followed in detail to assure safety during its expected lifetime.
2. Flameproof joints are not intended to be repaired.
3. Non-standard paint options may cause risk from electrostatic discharge. Avoid installations that could cause electrostatic build-up on painted surfaces and only clean the painted surfaces with a damp cloth. If paint is ordered through a special option code, contact the manufacturer for more information.
4. Some variants of the equipment have reduced markings on the nameplate. Refer to the Certificate for full equipment marking.
5. Variants with a paint finish must not be installed in a dust-laden airflow.

**I1 ATEX Intrinsic Safety and Dust**

<b>Certificate</b>	BAS97ATEX1089X; Baseefa11ATEX0275X
<b>Standards</b>	EN IEC 60079-0: 2018, EN60079-11: 2012, EN60079-31: 2014
<b>Markings</b>	IS:  II 1 G Ex ia IIC T4 Ga HART®: -60 °C ≤ T <sub>a</sub> ≤ +70 °C Fieldbus/PROFIBUS®: -60 °C ≤ T <sub>a</sub> ≤ +60 °C Dust:  II 1 D Ex ta IIIC T <sub>500</sub> 105 °C Da -20 °C ≤ T <sub>a</sub> ≤ +85 °C

**Table 21: Input parameters**

	HART	Fieldbus/PROFIBUS
Voltage U <sub>i</sub>	30 V	30 V
Current I <sub>i</sub>	200 mA	300 mA
Power P <sub>i</sub>	1.0 W	1.3 W
Capacitance C <sub>i</sub>	0.012 μF	0 μF
Inductance L <sub>i</sub>	0 mH	0 mH

**Specific Conditions of Use (X):**

1. The apparatus is not capable of withstanding the 500 V insulation test required by clause 6.3.12 of EN60079-11: 2012. This must be taken into account when installing the apparatus.
2. The enclosure may be made of aluminum alloy and given a protective polyurethane paint finish; however, care must be taken to protect it from impact or abrasion if located in Zone 0.

3. Some variants of the equipment have reduced markings on the nameplate. Refer to the Certificate for full equipment marking.
4. Non-standard paint options may cause risk from electrostatic discharge. Avoid installations that could cause electrostatic build-up on painted surfaces and only clean the painted surfaces with a damp cloth. If paint is ordered through a special option code, contact the manufacturer for more information.

**IA ATEX FISCO**

**Certificate** BAS97ATEX1089X  
**Standards** EN IEC 60079-0: 2018, EN60079-11: 2012  
**Markings**  II 1 G Ex ia IIC T4 Ga  
 -60 °C ≤ T<sub>a</sub> ≤ +60 °C



**Table 22: Input parameters**

	Fieldbus/PROFIBUS®
Voltage U <sub>i</sub>	17.5 V
Current I <sub>i</sub>	380 mA
Power P <sub>i</sub>	5.32 W
Capacitance C <sub>i</sub>	≤ 5 nF
Inductance L <sub>i</sub>	≤ 10 μH

**Specific Conditions for Safe Use (X):**

1. The apparatus is not capable of withstanding the 500 V insulation test required by clause 6.3.12 of EN60079-11: 2012. This must be taken into account when installing the apparatus.
2. The enclosure may be made of aluminum alloy and given a protective polyurethane paint finish; however, care should be taken to protect it from impact or abrasion if located in Zone 0.
3. Some variants of the equipment have reduced markings on the nameplate. Refer to the Certificate for full equipment marking.

**N1 ATEX Type n and Dust**

**Certificate** BAS00ATEX3105X; Baseefa11ATEX0275X  
**Standards** EN IEC 60079-0: 2018, EN60079-15: 2010, EN60079-31: 2014  
**Markings**  II 3 G Ex nA IIC T5 Gc  
 -40 °C ≤ T<sub>a</sub> ≤ +70 °C;  
 II 1 D Ex ta IIIC T<sub>500</sub> 105 °C Da  
 -20 °C ≤ T<sub>a</sub> ≤ +85 °C

**Specific Conditions for Safe Use (X):**

1. The apparatus is not capable of withstanding the 500 V insulation test required by EN 60079-15: 2010. This must be taken into account when installing the apparatus.
2. The enclosure may be made of aluminum alloy and given a protective polyurethane paint finish; however, care must be taken to protect it from impact or abrasion if located in Zone 0.
3. Variants with a paint finish must not be installed in a dust-laden airflow.
4. Some variants of the equipment have reduced markings on the nameplate. Refer to the Certificate for full equipment marking.

## International

### E7 IECEx Flame-proof and Dust

<b>Certificate</b>	IECEX KEM 09.0034X; IECEX BAS 10.0034X
<b>Standards</b>	IEC 60079-0: 2017, IEC 60079-1: 2014-06, IEC 60079-26: 2014-10, IEC 60079-31: 2013
<b>Markings</b>	Ex db IIC T6...T4 Ga/Gb T6: $-60\text{ °C} \leq T_a \leq +70\text{ °C}$ ; T4/T5: $-60\text{ °C} \leq T_a \leq +80\text{ °C}$ ; Ex ta IIIC T <sub>500</sub> 105 °C Da $-20\text{ °C} \leq T_a \leq +85\text{ °C}$

**Table 23: Process temperature**

Temperature class	Process connection temperature
T6	-60 °C to +70 °C
T5	-60 °C to +80 °C
T4	-60 °C to +80 °C

### Specific Conditions of Use:

1. This device contains a thin wall diaphragm less than 1 mm thick that forms a boundary between EPL Ga (process connection) and EPL Gb (all other parts of the equipment). The model code and datasheet are to be consulted for details of the diaphragm material. During installation, maintenance, and use, the environmental conditions to which the diaphragm will be subjected shall be taken into account. The manufacturer's instructions for installation and maintenance shall be followed in detail to assure safety during its expected lifetime.
2. Flameproof joints are not intended to be repaired.
3. Non-standard paint options may cause risk from electrostatic discharge. Avoid installations that could cause electrostatic build-up on painted surfaces and only clean the painted surfaces with a damp cloth. If paint is ordered through a special option code, contact the manufacturer for more information.
4. Some variants of the equipment have reduced markings on the nameplate. Refer to the Certificate for full equipment marking.

### I7 IECEx Intrinsic Safety

<b>Certificate</b>	IECEX BAS 09.0076X
<b>Standards</b>	IEC 60079-0: 2017, IEC60079-11: 2011
<b>Markings</b>	Ex ia IIC T4 Ga HART®: $-60\text{ °C} \leq T_a \leq +70\text{ °C}$ Fieldbus/PROFIBUS®: $-60\text{ °C} \leq T_a \leq +60\text{ °C}$

**Table 24: Input parameters**

	HART	Fieldbus/PROFIBUS
Voltage U <sub>i</sub>	30 V	30 V
Current I <sub>i</sub>	200 mA	300 mA
Power P <sub>i</sub>	1.0 W	1.3 W
Capacitance C <sub>i</sub>	0.012 μF	0 μF
Inductance L <sub>i</sub>	0 mH	0 mH

**Specific Conditions of Use:**

1. If the apparatus is fitted with an optional 90 V transient suppressor, it is not capable of withstanding the 500 V insulation test required by clause 6.3.12 of IEC 60079-11. This must be taken into account when installing the apparatus.
2. The enclosure may be made of aluminum alloy and given a protective polyurethane paint finish; however, care must be taken to protect it from impact or abrasion if located in Zone 0.

**IECEX Mining (Special A0259)**

<b>Certificate</b>	IECEX TSA 14.0001X
<b>Standards</b>	IEC 60079-0 :2011, IEC 60079-11: 2011
<b>Markings</b>	Ex ia I Ma (-60 °C ≤ T <sub>a</sub> ≤ +70 °C)

**Table 25: Input parameters**

	<b>HART</b>	<b>Fieldbus/PROFIBUS</b>	<b>FISCO</b>
Voltage U <sub>i</sub>	30 V	30 V	17.5 V
Current I <sub>i</sub>	200 mA	300 mA	380 mA
Power P <sub>i</sub>	0.9 W	1.3 W	5.32 W
Capacitance C <sub>i</sub>	0.012 μF	0 μF	< 5 nF
Inductance L <sub>i</sub>	0 mH	0 mH	< 10 μH

**Specific Conditions of Use:**

1. If the apparatus is fitted with an optional 90 V transient suppressor, it is not capable of withstanding the 500 V insulation test required by IEC60079-11. This must be taken into account when installing the apparatus.
2. It is a condition of safe use that the above input parameters shall be taken into account during installation.
3. It is a condition of manufacture that only the apparatus fitted with housing, covers, and sensor module housing made out of stainless steel are used in Group 1 applications.

**IG IECEX FISCO**

<b>Certificate</b>	IECEX BAS 09.0076X
<b>Standards</b>	IEC 60079-0: 2017, IEC60079-11: 2011
<b>Markings</b>	Ex ia IIC T4 Ga -60 °C ≤ T <sub>a</sub> ≤ +60 °C

**Table 26: Input parameters**

	<b>Fieldbus/PROFIBUS®</b>
Voltage U <sub>i</sub>	17.5 V
Current I <sub>i</sub>	380 mA
Power P <sub>i</sub>	5.32 W
Capacitance C <sub>i</sub>	≤ 5 nF
Inductance L <sub>i</sub>	≤ 10 μH

**Specific Conditions for Safe Use:**

1. If the apparatus is fitted with an optional 90 V transient suppressor, it is not capable of withstanding the 500 V insulation test required by clause 6.3.12 of IEC 60079-11. This must be taken into account when installing the apparatus.

- The enclosure may be made of aluminum alloy and given a protective polyurethane paint finish; however, care must be taken to protect it from impact or abrasion if located in Zone 0.

### N7 IECEx Type n

<b>Certificate</b>	IECEx BAS 09.0077X
<b>Standards</b>	IEC60079-0: 2017, IEC60079-15: 2010
<b>Markings</b>	Ex nA IIC T5 Gc (-40 °C ≤ T <sub>a</sub> ≤ +70 °C)

#### Specific Condition for Safe Use (X):

- The apparatus is not capable of withstanding the 500 V insulation test required by clause 6.5.1 of IEC 60079-15. This must be taken into account when installing the apparatus.

## Brazil

### E2 Brazil Flame-proof

<b>Certificate</b>	UL-BR 13.0643X
<b>Standards</b>	ABNT NBR IEC 60079-0: 2013; ABNT NBR IEC 60079-1: 2016; ABNT NBR IEC 60079-26: 2016
<b>Markings</b>	Ex db IIC T6...T4 Ga/Gb T6: -60 °C ≤ T <sub>a</sub> ≤ +70 °C T4/T5: -60 °C ≤ T <sub>a</sub> ≤ +80 °C

#### Special Conditions for Safe Use (X):

- This device contains a thin wall diaphragm with less than 1 mm thickness that forms a boundary between zone 0 (process connection) and zone 1 (all other parts of the equipment). The model code and datasheet are to be consulted for details of the diaphragm material. Installation, maintenance, and use shall take into account the environmental conditions to which the diaphragm will be subjected. The manufacturer's instructions for installation and maintenance shall be followed in detail to assure safety during its expected lifetime.
- Flameproof joints are not intended to be repaired.
- Non-standard paint options may cause risk from electrostatic discharge. Avoid installations that could cause electrostatic build-up on painted surfaces and only clean the painted surfaces with a damp cloth. If paint is ordered through a special option code, contact the manufacturer for more information.

### I2 Brazil Intrinsic Safety

<b>Certificate</b>	UL-BR 13.0584X
<b>Standards</b>	ABNT NBR IEC60079-0: 2013, ABNT NBR IEC60079-11: 2013
<b>Markings</b>	HART <sup>®</sup> : Ex ia IIC T5/T4 Ga, T5 (-60 °C ≤ T <sub>a</sub> ≤ +40 °C), T4 (-60 °C ≤ T <sub>a</sub> ≤ +70 °C) Fieldbus/PROFIBUS <sup>®</sup> : Ex ia IIC T4 Ga (-60 °C ≤ T <sub>a</sub> ≤ +60 °C)

**Table 27: Input parameters**

	HART	Fieldbus/PROFIBUS
Voltage U <sub>i</sub>	30 V	30 V
Current I <sub>i</sub>	200 mA	300 mA
Power P <sub>i</sub>	0.9 W	1.3 W
Capacitance C <sub>i</sub>	0.012 μF	0 μF
Inductance L <sub>i</sub>	0 mH	0 mH

**Special Conditions for Safe Use (X):**

1. If the equipment is fitted with an optional 90 V transient suppressor, it is not capable of withstanding the 500 V insulation test required by ABNT NBR IRC 60079-11. This must be taken into account when installing the equipment.
2. The enclosure may be made of aluminum alloy and given protective polyurethane paint finish; however, care must be taken to protect it from impact or abrasion if equipment requires EPL Ga.

**IB Brazil FISCO**

**Certificate** UL-BR 13.0584X  
**Standards** ABNT NBR IEC60079-0: 2013, ABNT NBR IEC60079-11: 2013  
**Markings** Ex ia IIC T4 Ga (-60 °C ≤ T<sub>a</sub> ≤ +60 °C)

**Table 28: Input parameters**

	<b>FISCO</b>
Voltage U <sub>i</sub>	17.5 V
Current I <sub>i</sub>	380 mA
Power P <sub>i</sub>	5.32 W
Capacitance C <sub>i</sub>	≤ 5 nF
Inductance L <sub>i</sub>	≤ 10 μH

**Special Conditions for Safe Use (X):**

1. If the equipment is fitted with an optional 90 V transient suppressor, it is not capable of withstanding the 500 V insulation test required by ABNT NBR IRC 60079-11. This must be taken into account when installing the equipment.
2. The enclosure may be made of aluminum alloy and given protective polyurethane paint finish; however, care must be taken to protect it from impact or abrasion if equipment requires EPL Ga.

**China**

**E3 China Flame-proof**

**Certificate** GYJ24.1006X [Transmitters]; GYJ20.1486X [Flow meters]  
**Standards** GB/T 3836.1-2021, GB/T 3836.2-2021, GB/T 3836.20-2021, GB/T 3836.31-2021  
**Markings** 3051 Series: Ex db IIC T6~T4 Ga/Gb, Ex ta IIIC T200 105 °C Da (-20 °C ≤ T<sub>a</sub> ≤ 85 °C)  
 3051CF Series: Ex d IIC T6~T4 Ga/Gb

**I3 China Intrinsic Safety**

**Certificate** GYJ23.1139X; GYJ20.1488X [Flow meters]  
**Standards** GB/T 3836.1-2021, GB/T 3836.4-2021, GB/T 3836.31-2021  
**Markings** 3051 Series: Ex ia IIC T4 Ga, Ex ta IIIC T500 105 °C Da  
 3051CF Series: Ex ia IIC T4 Ga, Ex ta IIIC T500 105 °C Da

**N3 China Type n**

**Certificate** GYJ20.1110X  
**Standards** GB/T 3836.1-2021, GB/T 3836.3-2021  
**Markings** Ex ec IIC T5 Gc

## Japan

### E4 Japan Flame-proof

**Certificate** CML20JPN1098X

**Markings** Ex db IIC T6...T4 Ga/Gb, T6 (-60 °C ≤ Ta ≤ +70 °C), T5/T4 (-60 °C ≤ Ta ≤ +80 °C)

#### Special Conditions for Safe Use (X):

1. This device contains a thin wall diaphragm less than 1 mm thick that forms a boundary between EPL Ga (process connection) and EPL Gb (all other parts of the equipment). The model code and datasheet are to be consulted for details of the diaphragm material. During installation, maintenance, and use, the environmental conditions to which the diaphragm will be subjected shall be taken into account. The manufacturer's instructions for installation and maintenance shall be followed in detail to assure safety during its expected lifetime.
2. Flameproof joints are not intended to be repaired.
3. Non-standard paint options may cause risk from electrostatic discharge. Avoid installations that could cause electrostatic build-up on painted surfaces and only clean the painted surfaces with a damp cloth. If paint is ordered through a special option code, contact the manufacturer for more information.

## Republic of Korea

### EP Republic of Korea Flame-proof

**Certificate** 11-KB4BO-0188X [Manufacturing Singapore], 19-KA4BO-079X [Manufacturing USA]

**Markings** Ex d IIC T6...T4 Ga/Gb

### IP Republic of Korea Intrinsic Safety

**Certificate** 13-KB4BO-0203X [HART® – Manufacturing USA], 13-KB4BO-0204X [Fieldbus – Manufacturing USA], 10-KB4BO-0138X [HART – Manufacturing Singapore], 13-KB4BO-0206X [Fieldbus – Manufacturing Singapore], 18-KA4BO-0354X [HART – Manufacturing USA], 18-KA4BO-0355X [Fieldbus – Manufacturing USA]

**Markings** Ex ia IIC T5/T4 (HART); Ex ia IIC T4 (Fieldbus)

## Combinations

<b>K2</b>	Combination of E2 and I2
<b>K5</b>	Combination of E5 and I5
<b>K6</b>	Combination of C6, E8, and I1
<b>K7</b>	Combination of E7, I7, and N7
<b>K8</b>	Combination of E8, I1, and N1
<b>KB</b>	Combination of E5, I5, and C6
<b>KD</b>	Combination of E8, I1, E5, I5, and C6
<b>KM</b>	Combination of EM and IM
<b>KP</b>	Combination of EP and IP

## Additional certifications

### SBS American Bureau of Shipping (ABS) Type Approval

**Certificate** 18-HS1814795-PDA

**Intended use** Marine and offshore applications – Measurement of either gauge or absolute pressure for liquid, gas, and vapor.

**SBV Bureau Veritas (BV) Type Approval**

**Certificate** 23155

**Requirements** Bureau Veritas rules for the classification of steel ships

**Application** Class notations: AUT-UMS, AUT-CCS, AUT-PORT, and AUT-IMS; Pressure transmitter type 3051 cannot be installed on diesel engines.

**SDN Det Norske Veritas (DNV) Type Approval**

**Certificate** TAA000004F

**Intended Use** DNV GL rules for classification - ships and offshore units

**Application** **Table 29: Location classes**

Temperature	D
Humidity	B
Vibration	A
Electromagnetic compatibility (EMC)	B
Enclosure	D

**SLL Lloyds Register (LR) Type Approval**

**Certificate** LR21173788TA

**Application** Environmental categories ENV1, ENV2, ENV3, and ENV5

**C5 Custody Transfer - Measurement Canada Accuracy Approval**

**Certificate** AG-0226; AG-0454; AG-0477

## Rosemount 3051 Wireless product certifications

Rev 1.12

### European Directive information

A copy of the EU Declaration of Conformity can be found at the end of the Quick Start Guide. The most recent revision of the EU Declaration of Conformity can be found at [Emerson.com/Rosemount](https://www.emerson.com/Rosemount).

### Telecommunication compliance

All wireless devices require certification to ensure they adhere to regulations regarding the use of the radio frequency (RF) spectrum. Nearly every country requires this type of product certification.

Emerson is working with governmental agencies around the world to supply fully compliant products and remove the risk of violating country directives or laws governing wireless device usage.

### Federal Communications Commission (FCC) and Industry Canada (IC)

This device complies with Part 15 of the FCC Rules. Operation is subject to the following conditions: This device may not cause harmful interference; this device must accept any interference received, including interference that may cause undesired operation. This device must be installed to ensure a minimum antenna separation distance of 7.9 in. (20 cm) from all persons.

### Ordinary location certification

As standard, the transmitter has been examined and tested to determine that the design meets the basic electrical, mechanical, and fire protection requirements by a Nationally Recognized Test Laboratory (NRTL) as accredited by the Federal Occupational Safety and Health Administration (OSHA).

### Installing equipment in North America

The US National Electrical Code® (NEC) and the Canadian Electrical Code (CEC) permit the use of Division marked equipment in Zones and Zone marked equipment in Divisions. The markings must be suitable for the area classification, gas, and temperature class. This information is clearly defined in the respective codes.

## USA

### I5 USA Intrinsically Safe (IS)

#### Ranges 1-5

**Certificate** FM19US0050X

**Standards** FM Class 3600:2018, FM Class 3610:2018, FM Class 3810:2018, ANSI/ISA 60079-0:2013, ANSI/UL 60079-11:2014, NEMA 250:2003, ANSI/IEC 60529:2014, ANSI/UL 61010:2016

**Markings** IS CL I, DIV 1, GP A, B, C, D T4; CL 1, Zone 0 AEx ia IIC T4; T4 (-40 ° F [-40 ° C] ≤ T<sub>a</sub> ≤ 158 ° F [70 ° C]) when installed per Rosemount drawing 03031-1062; Type 4X/IP66/IP68

#### Special Conditions for Safe Use (X):

1. The Rosemount 3051 Wireless Pressure Transmitter shall only be used with the 701PGNKF Rosemount SmartPower™ Battery Pack.
2. The inline pressure sensor may contain more than 10 percent aluminum and is considered a potential risk of ignition by impact or friction. Care must be taken into account during installation and used to prevent impact and friction.

- The surface resistivity of the transmitter housing is greater than one gigaohm. To avoid electrostatic charge build-up, it must not be rubbed or cleaned with solvents or a dry cloth.

### Range 6

**Certificate** CSA 2526009

**Standards** FM Class 3600 - 2011, FM Class 3610 - 2010, FM Class 3810 - 2005, ANSI/ISA 60079-0 - 2009, ANSI/ISA 60079-11 - 2009, UL 61010-1 (3rd edition), UL50E (1st Edition)

**Markings** IS CL I, DIV 1, GP A, B, C, D T4; CL 1, Zone 0 AEx ia IIC T4; T4 (-40 ° F [-40 ° C] ≤ T<sub>a</sub> ≤ 158 ° F [70 ° C]) when installed per Rosemount drawing 03031-1063; Type 4X/IP66/IP68

## Canada

### I6 Canada Intrinsically Safe

**Certificate** CSA 2526009

**Standards** CAN/CSA C22.2 No. 0-M91, CAN/CSA C22.2 No.94-M91, CSA Std C22.2 No. 142-M1987, CSA Std C22.2 No. 157-92, CSA Std C22.2 No. 60529:05

**Markings** Intrinsically Safe for Class I, Division 1, Groups A, B, C, D, T4 when installed per Rosemount drawing 03031-1063; Type 4X/IP66/IP68

## Europe

### I1 ATEX Intrinsic Safety

**Certificate** Baseefa12ATEX0228X

**Standards** EN 60079-0: 2012, EN 60079-11: 2012

**Markings** ⓂEx II 1 G Ex ia IIC T4 Ga, T4 (-76 ° F [60 ° C] ≤ T<sub>a</sub> ≤ 158 ° F [70 ° C]) IP66/IP68

#### Special Conditions for Safe Use (X):

- The plastic enclosure may constitute a potential electrostatic ignition risk and must not be rubbed or cleaned with a dry cloth.
- The Model 701PGNKF Power Module may be replaced in a hazardous area. The power module has a surface resistivity greater than 1 GΩ and must be properly installed in the wireless device enclosure. Care must be taken during transportation to and from the point of installation to prevent electrostatic charge build-up.

## International

### I7 IECEx Intrinsic Safety

**Certificate** IECEx BAS 12.0124X

**Standards** IEC 60079-0: 2011, IEC 60079-11: 2011

**Markings** Ex ia IIC T4 Ga, T4 (-60 ° C ≤ T<sub>a</sub> ≤ +70 ° C) IP66/IP68

#### Special Conditions for Safe Use (X):

- The plastic enclosure may constitute a potential electrostatic ignition risk and must not be rubbed or cleaned with a dry cloth.
- The Emerson 701PGNKF Power Module may be replaced in a hazardous area. The power module has a surface resistivity greater than 1 GΩ and must be properly installed in the wireless device enclosure. Care must be taken during transportation to and from the point of installation to prevent electrostatic charge build-up.

## Brazil

### I2 Brazil Intrinsic Safety

<b>Certificate</b>	UL-BR 13.0534X
<b>Standards</b>	ABNT NBR IEC 60079-0:2013, ABNT NBR IEC 60079-11:2013
<b>Markings</b>	Ex ia IIC T4 IP66 Ga, T4 ( $-40\text{ °C} \leq T_a \leq +70\text{ °C}$ )

**Special Condition for Safe Use (X):**

See certificate for special conditions.

## China

### I3 China Intrinsic Safety

<b>Certificate</b>	GYJ18.1419X; GYJ20.1488X [Flow Meters]
<b>Standards</b>	GB3836.1-2010, GB3836.4-2010, GB3836.20-2010
<b>Markings</b>	Ex ia IIC T4 Ga, T4 ( $-60 \sim +70\text{ °C}$ )

**Special Condition for Safe Use (X):**

See certificate for special conditions.

## Japan

### I4 Japan Intrinsic Safety

<b>Certificate</b>	TC22022X (Rosemount 3051C/L), TC22023X (Rosemount 3051T), TC22024X (Rosemount 3051CFx)
<b>Markings</b>	Ex ia IIC T4 Ga, T4 ( $-20 \sim +60\text{ °C}$ )

**Special Condition for Safe Use (X):**

See certificate for special conditions.

## Korea

### IP Korea Intrinsic Safety

<b>Certificate</b>	13-KB4BO-0295X
<b>Markings</b>	Ex ia IIC T4 ( $-40\text{ °C} \leq T_a \leq +70\text{ °C}$ )

**Special Conditions for Safe Use (X):**

See certificate for special conditions.

## Additional Certifications

### SBS American Bureau of Shipping (ABS) Type Approval

<b>Certificate</b>	15-HS1405241-PDA
<b>Intended Use</b>	Marine & Offshore Applications - Measurement of either gauge or absolute pressure for liquid, gas, and vapor.

### SBV Bureau Veritas (BV) Type Approval

<b>Certificate</b>	23155
--------------------	-------

**Requirements** Bureau Veritas Rules for the Classification of Steel Ships

**Application** Class notations: AUT-UMS, AUT-CCS, AUT-PORT and AUT-IMS; Pressure transmitter type 3051 cannot be installed on diesel engines

**SDN Det Norske Veritas (DNV) Type Approval**

**Certificate** TAA000004F

**Intended Use** DNV GL Rules for Classification - Ships and offshore units

**Application:**

Location classes	
Temperature	D
Humidity	B
Vibration	A
EMC	B
Enclosure	D

# Rosemount 2051CF Flow Meters

## Online product configurator

Many products are configurable online using our product configurator.

Select the **Configure** button or visit [Emerson.com/global](https://emerson.com/global) to start. With this tool's built-in logic and continuous validation, you can configure your products more quickly and accurately.

## Specifications and options

The purchaser of the equipment must specify and select the product materials, options, or components.

## Sizing and Selection Body

All Rosemount flow meters can be sized to meet your application specific requirements in the DP Flow sizing and selection tool. This tool will verify if a selected product meets your application requirements, provide a comparison between different primary elements, and generate a detailed accuracy comparison graph.

Once a sizing is completed, the configuration tool will help create a complete and valid model code to match your requirements and include any additional options or approvals.

## Optimizing lead time

The starred offerings (★) represent the most common options and should be selected for the fastest delivery times. The non-starred offerings are subject to additional delivery lead time.

## Rosemount 2051 CFA Annubar™ ordering information



- Patented T-shape Annubar creates a fixed separation point for DP signal improvement over a wider flow rate
- Complete flow assemblies are leak-tested and calibrated to reduce leak points up to 70 percent and simplify installation
- T-shape design of averaging pitot tube ensures very low permanent pressure loss
- Local operator interface offers easy-to-use menus and built-in configuration buttons for streamlined commissioning
- Sensor stagnation zone positioned to reduce noise, measurement inaccuracies and keeps particulates from clogging
- SIL 2/3 certified to IEC 61508 (via 3rd party) and prior-use certificate of FMEDA data for safety installations

[CONFIGURE >](#)

[VIEW PRODUCT >](#)

## Online product configurator

Many products are configurable online using our product configurator.

Select the **Configure** button or visit [Emerson.com/global](https://emerson.com/global) to start. With this tool's built-in logic and continuous validation, you can configure your products more quickly and accurately.

## Specifications and options

The purchaser of the equipment must specify and select the product materials, options, or components.

## Required model components

### Model

Code	Description	
2051CFA	Annubar Flow Meter	★

### Measurement type

Code	Description	
D	Differential pressure	★

### Fluid type

Code	Description	
L	Liquid	★
G	Gas	★
S	Steam	★

### Line size

Actual units are built to customer supplied pipe ID and wall dimensions. Line size codes in model are used as a nominal size and auto-selected by the sizing program.

Code	Description	
020	2 in. (50 mm)	★
025	2½ in. (63.5 mm)	★
030	3 in. (80 mm)	★
035	3½ in. (89 mm)	★
040	4 in. (100 mm)	★
050	5 in. (125 mm)	★
060	6 in. (150 mm)	★
070	7 in. (175 mm)	★
080	8 in. (200 mm)	★
100	10 in. (250 mm)	★
120	12 in. (300 mm)	★
140	14 in. (350 mm)	
160	16 in. (400 mm)	
180	18 in. (450 mm)	
200	20 in. (500 mm)	

240	24 in. (600 mm)	
300	30 in. (750 mm)	
360	36 in. (900 mm)	
420	42 in. (1066 mm)	
480	48 in. (1210 mm)	
600	60 in. (1520 mm)	
720	72 in. (1820 mm)	
780	78 in. (1950 mm)	
840	84 in. (2100 mm)	
900	90 in. (2250 mm)	
960	96 in. (2400 mm)	

### Pipe ID range

Code	Description	
Z	Custom manufactured for customer-supplied pipe ID	★

### Pipe material/Mounting assembly material

Code	Description	
C	CS (A105)	★
S	316 SST	★
0 <sup>(1)</sup>	No mounting <sup>(2)</sup>	★
G	Chrome-moly grade F-11	
N	Chrome-moly grade F-22	
J	Chrome-moly grade F-91	

(1) For customer-supplied mounting, provide relevant dimension at time of sizing and order.

(2) Customer supplied.

### Pipe orientation

Code	Description	
H	Horizontal piping	★
D	Vertical piping with downward flow	★
U	Vertical piping with upward flow	★

### Rosemount Annubar type

Code	Description	
P	Pak-lok	★
F	Flanged with opposite side support	★

### Sensor material

Code	Description	
S	316 SST	★

### Sensor size

Code	Description	
1	Sensor size 1 — Line sizes 2 to 8 in. (50 to 200 mm)	★
2	Sensor size 2 — Line sizes 6 to 96 in. (150 to 2400 mm)	★
3	Sensor size 3 — Line sizes greater than 12 in. (300 mm)	★

### Mounting type

Code	Description	
T1	Compression or threaded connection	★
A1	Class 150 RF ASME B16.5	★
A3	Class 300 RF ASME B16.5	★
A6	Class 600 RF ASME B16.5	★
D1	PN16 EN-1092-1 RF	★
D3	PN40 EN-1092-1 RF	★
D6	PN100 EN-1092-1 RF	★
R1	Class 150 RTJ ASME B16.5	
R3	Class 300 RTJ ASME B16.5	
R6	Class 600 RTJ ASME B16.5	

### Opposite side support or packing gland

Code	Description	
0	No opposite side support or packing gland <sup>(1)</sup>	★
<b>Opposite side support <sup>(2)</sup></b>		
C	NPT threaded opposite support assembly	★
D	Welded opposite support assembly	★

(1) Required for pak-lok models.

(2) Required for flanged models.

### Isolation valve

Code	Description	
0	Not applicable or customer supplied	★

### Temperature measurement

Code	Description	
T	Integral RTD <sup>(1)</sup>	★

0	No temperature sensor	★
R	Remote thermowell and RTD	

(1) Not available with flanged model greater than Class 600.

### Transmitter connection platform

Code	Description	
3	Direct mount, Integral 3-valve manifold — not available with flanged model greater than Class 600	★
5	Direct mount, 5-valve manifold — not available with flanged model greater than Class 600	★
7	Remote mount NPT connections (½ in. FNPT)	★
8	Remote mount SW connections (½ in.)	

### Differential pressure range

Code	Description	
1	0 to 25 inH <sub>2</sub> O (0 to 62.16 mbar)	★
2	0 to 250 inH <sub>2</sub> O (0 to 621.6 mbar)	★
3	0 to 1000 inH <sub>2</sub> O (0 to 2.49 bar)	★

### Transmitter output

Code	Description	
A <sup>(1)</sup>	4–20 mA with digital signal based on HART® Protocol	★
F	FOUNDATION™ Fieldbus Protocol	★
W <sup>(2)</sup>	PROFIBUS® PA Protocol	★
X <sup>(3)</sup>	Wireless	★
M <sup>(4)</sup>	Low-power, 1–5 Vdc with digital signal based on HART Protocol	

(1) HART Revision 5 is the default HART output. The Rosemount 2051 with Selectable HART can be factory or field configured to HART Revision 7. To order HART Revision 7 factory configured, add option code HR7.

(2) For local addressing and configuration, M4 (LOI) is required. Not available with product certification codes E4, EM, EP, I6, IM, KD, KL, KM, KP, KS, N3.

(3) Only available with intrinsically safe approvals.

(4) Only available with Housing Codes A and J and with C6, E2,E5, I5, K5, EM, EP, KB, and E8 product certifications.

### Transmitter housing material

Code	Description	Conduit entry size	
A	Aluminum	½–14 NPT	★
B	Aluminum	M20 x 1.5	★
J	SST	½–14 NPT	★
K	SST	M20 x 1.5	★
P <sup>(1)</sup>	Engineered polymer	No conduit entries	★
D <sup>(2)</sup>	Aluminum	G½	
M <sup>(2)</sup>	SST	G½	

(1) Only available with output code X.

(2) Transmitter conduit entry will be ½ NPT and a ½ NPT to G½ thread adapter will be provided. This option is only available with product certifications options I1, I2, I3, I7, IA, IB, IM, KA, N1, N3, N7. Housing code D is also available with E4, and IG.

### Transmitter performance class

Code	Description	
1	2.0% flow rate accuracy, 5:1 flow turndown, 2-year stability	★

### Wireless options

Requires wireless output code X and engineered polymer housing code P.

#### Wireless transmit rate, operating frequency, and protocol

Code	Description	
WA3	User configurable transmit rate, 2.4 GHz <b>Wireless</b> HART®	★

#### Antenna and SmartPower™

Code	Description	
WP5	Internal antenna, compatible with Green Power Module (1)	★

(1) IS Power Module sold separately.

### Additional options

#### Extended product warranty

Code	Description	
WR3	3-year limited warranty	★
WR5	5-year limited warranty	★

#### Alternate transmitter diaphragm material

Code	Description	
ID2	316L SST	
ID3	Alloy C-276	
ID5(1)(2)	Tantalum	

(1) Available in ranges 2-5 only.

(2) Not available with output code X.

#### Pressure testing

Code	Description	
P1	Hydrostatic testing with certificate	★
PX	Extended hydrostatic testing	

### Special cleaning

Code	Description	
P2	Cleaning for special processes	

### Material testing

Code	Description	
V1	Dye penetrant exam	

### Material examination

Code	Description	
V2	Radiographic examination	

### Special inspection

Code	Description	
QC1	Visual and dimensional inspection with certificate	★
QC7	Inspection and performance certificate	★

### Surface finish

This surface finish option is auto selected by the sizing tool as necessary.

Code	Description	
RL	Surface finish for low pipe Reynolds number in gas and steam	★
RH	Surface finish for high pipe Reynolds number in liquid	★

### Material traceability certification

Instrument connections for remote mount options are not included in the Material Traceability Certification.

Code	Description	
Q8	Material traceability certification per EN 10474:2004 3.1	★

### Positive material identification (PMI)

Code	Description	
Q76	PMI verification and certificate	★

### Code conformance

Code	Description	
J2	ANSI/ASME B31.1	
J3	ANSI/ASME B31.3	

## Materials conformance

Materials of Construction comply with metallurgical requirements within NACE MR0175/ISO for sour oil field production environments. Environmental limits apply to certain materials. Consult latest standard for details. Selected materials also conform to NACE MR0103 for sour refining environments.

Selecting J5 option will provide Alloy C-276 transmitter diaphragms.

Code	Description	
J5	Certificate of Compliance to NACE MR0175/ISO 15156 for wetted materials	

## Country certification

Code	Description	
J6	European Pressure Directive (PED)	★
J1	Canadian Registration	
J8	Chinese Certificate of Special Equipment Type Test	

## Instrument connections for remote mount options

Code	Description	
G2	Needle valves, SST	★
G6	OS&Y gate valves, SST	★
G1	Needle valves, CS	
G3	Needle valves, alloy C-276	
G5	OS&Y gate valves, CS	
G7	OS&Y gate valves, alloy C-276	

## Special shipment

Code	Description	
Y1	Mounting hardware shipped separately <sup>(1)</sup>	★

(1) Requires 486 model to be ordered. Include Y1 option on 486 model also.

## Product certifications

Code	Description	
E8	ATEX Flameproof	★
I1 <sup>(1)</sup>	ATEX Intrinsic Safety	★
IA	ATEX FISCO Intrinsic Safety; for FOUNDATION™ Fieldbus or PROFIBUS® PA Protocol only	★
N1	ATEX Type n Certification	★
K8	ATEX Flameproof, Intrinsic Safety, Type n, Dust (combination of E8, I1 and N1)	★
E4 <sup>(2)</sup>	Japan Flameproof	★
E5	USA Explosion-proof, Dust Ignition-proof	★
I5 <sup>(3)</sup>	USA Intrinsically Safe, Nonincendive	★
K5	USA Explosion-proof, Dust Ignition-proof, Intrinsically Safe, and Division 2	★
E6	Canada Explosion-proof, Dust Ignition-proof, Division 2	★

I6	Canada Intrinsic Safety	★
C6	Canada Explosion-proof, Dust Ignition-proof, Intrinsically Safe, and Division 2	★
K6	Canada and ATEX Explosion-proof, Intrinsically Safe, and Division 2 (combination of C6, E8, and I1)	★
E7	IECEX Flameproof	★
I7	IECEX Intrinsic Safety	★
N7	IECEX Type n Certification	★
K7	IECEX Flameproof, Dust Ignition-proof, Intrinsic Safety, and Type n (combination of I7, N7, and E7)	★
IG	IECEX FISCO Intrinsically Safe; for FOUNDATION Fieldbus or PROFIBUS PA Protocols only	★
E2	Brazil Flameproof	★
I2	Brazil Intrinsic Safety	★
IB	Brazil FISCO intrinsically safe; for FOUNDATION Fieldbus or PROFIBUS PA Protocols only	★
K2	Brazil Flameproof, Intrinsic Safety	★
E3	China Flameproof	★
I3	China Intrinsic Safety	★
EM	Technical Regulations Customs Union (EAC) Flameproof	★
IM	Technical Regulations Customs Union (EAC) Intrinsic Safety	★
KM	Technical Regulations Customs Union (EAC) Flameproof and Intrinsic Safety	★
KB	USA and Canada Explosion-proof, Dust Ignition-proof, Intrinsically Safe, and Division 2 (combination of K5 and C6)	★
KD	USA, Canada, and ATEX Explosion-proof, Intrinsically Safe (combination of K5, C6, I1, and E8)	★
KL <sup>(4)</sup>	USA, Canada, IECEX, ATEX Intrinsic Safety Combination	★
KS	USA, Canada, IECEX, ATEX Explosion-proof, Intrinsically Safe, Dust, Non-Incendive, Type-N, Div. 2	★
EP	Republic of Korea Flameproof	★
IP	Republic of Korea Intrinsic Safety	★
KP	Republic of Korea Flameproof, Intrinsic Safety	★

- (1) *Dust approval not applicable to wireless (output code X). See [Rosemount 3051 product certifications](#) for wireless approvals.*  
(2) *Only available with 4-20 mA HART® (output code A), FOUNDATION™ Fieldbus (output code F), or PROFIBUS® PA (output code W). Only available with aluminum housing and G½ conduit entry size (housing material code D).*  
(3) *Nonincendive certification not provided with wireless (output code X).*  
(4) *Only available with wireless (output code X).*

## Shipboard approval

Code	Description	
SBS	American Bureau of Shipping <sup>(1)</sup>	★

- (1) *Not available with wireless (output code X).*

## Sensor fill fluid and O-ring options

Code	Description	
L1 <sup>(1)</sup>	Inert sensor fill fluid	★
L2	Graphite-filled (PTFE) O-ring	★
LA <sup>(1)</sup>	Inert sensor fill fluid and graphite-filled (PTFE) O-ring	★

- (1) *Not available with output code X.*

## Display and interface options

Code	Description	
M4 <sup>(1)</sup>	LCD display with LOI	★
M5	LCD display	★

(1) Not available with FOUNDATION™ Fieldbus (output code F) or wireless (output code X).

## Transmitter calibration certification

Code	Description	
Q4	Calibration certificate for transmitter	★

## Quality certification for safety

Code	Description	
QT	Safety certified to IEC 61508 with certificate of FMEDA <sup>(1)</sup>	★

(1) The quality certification for safety is only available with HART® 4–20 mA output (code A).

## Transient protection

Code	Description	
T1	Transient terminal block <sup>(1)</sup> <sup>(2)</sup>	★

(1) This option is not available with output code X.

(2) This option is not available with housing code 00, 5A, or 7J. The T1 option is not needed with FISCO Product Certifications, transient protection is included with the FISCO Product Certification code IA.

## Manifold for remote mount option

Code	Description	
F2	3-valve manifold, SST	★
F6	5-valve manifold, SST	★

## Configuration buttons

Code	Description	
D4 <sup>(1)</sup>	Zero and span hardware adjustments	★
DZ <sup>(2)</sup>	Digital zero trim	★

(1) Only available with 4–20 mA HART® (output codes A and M).

(2) Only available with 4–20 mA HART (output codes A and M) and wireless output (code X).

## Alarm limit

This option is only available with 4–20 mA HART® (output codes A and M).

Code	Description	
C4	NAMUR alarm and saturation levels, high alarm	★
CN	NAMUR alarm and saturation levels, low alarm	★
CR	Custom alarm and saturation signal levels, high alarm (requires C1 and Configuration Data Sheet)	★

CS	Custom alarm and saturation signal levels, low alarm (requires C1 and Configuration Data Sheet)	★
CT	Low alarm (standard Rosemount alarm and saturation levels)	★

### Ground screw

The V5 option is not needed with the T1 option; external ground screw assembly is included with the T1 option.

Code	Description	
V5	External ground screw assembly	★

### HART® revision configuration

This option is only available with 4–20 mA HART (output codes A and M).

Code	Description	
HR5 <sup>(1)</sup>	Configured for HART Revision 5	★
HR7 <sup>(2)</sup>	Configured for HART Revision 7	★

(1) Configures the HART output to HART Revision 5. The device can be field configured to HART Revision 7 if needed.

(2) Configures the HART output to HART Revision 7. The device can be field configured to HART Revision 5 if needed.

## Rosemount 2051CFC Compact Flow Meter ordering information



- Complete flow assemblies are leak-tested and calibrated to reduce leak points up to 70% and simplify installation
- Primary element design delivers reliable and accurate flow measurement for gas, liquid and steam service
- Orifice plate available in ½ to 12 in. (15-300 mm) line sizes for application flexibility
- Local operator interface offers easy-to-use menus and built-in configuration buttons for streamlined commissioning
- SIL 2/3 certified to IEC 61508 (via 3rd party) and prior-use certificate of FMEDA data for safety installations

CONFIGURE >
VIEW PRODUCT >

### Online product configurator

Many products are configurable online using our product configurator.

Select the **Configure** button or visit [Emerson.com/global](https://emerson.com/global) to start. With this tool's built-in logic and continuous validation, you can configure your products more quickly and accurately.

### Specifications and options

The purchaser of the equipment must specify and select the product materials, options, or components.

### Required model components

#### Model

Code	Description	
2051CFC	Compact flow meter	★

#### Measurement type

Code	Description	
D	Differential pressure	★

#### Primary element technology

Code	Description	
A	Rosemount Annubar™ averaging pitot tube	
C	Conditioning orifice plate	★
P	Orifice plate	★

## Material type

Code	Description	
S	316 SST	★

## Line size

Code	Description	
005 <sup>(1)</sup>	½ in. (15 mm)	★
010 <sup>(1)</sup>	1 in. (25 mm)	★
015 <sup>(1)</sup>	1½ in. (40 mm)	★
020	2 in. (50 mm)	★
030	3 in. (80 mm)	★
040	4 in. (100 mm)	★
060	6 in. (150 mm)	★
080	8 in. (200 mm)	★
100 <sup>(2)(3)</sup>	10 in. (250 mm)	★
120 <sup>(2)(3)</sup>	12 in. (300 mm)	★

(1) Only available with Primary Element Technology P.

(2) For the 10 and 12 in. (250 and 300 mm) line size, the alignment ring must be ordered (installation accessories).

(3) 10 and 12 in. (250 and 300 mm) line sizes not available with primary element technology A.

## Primary element type

Code	Description	
N000	Rosemount Annubar sensor size 1	★
N040	0.40 beta ratio	★
N050	0.50 beta ratio	★
N065 <sup>(1)</sup>	0.65 beta ratio	★

(1) For 2 in. (50 mm) line sizes the primary element type is 0.60 for primary element technology code C.

## Temperature measurement

Code	Description	
0	No temperature sensor	★
T <sup>(1)</sup>	Integral RTD	
R	Remote thermowell and RTD	

(1) Available with primary element technology A only.

## Transmitter connection platform

Code	Description	
3	Direct mount, integral 3-valve manifold	★
7	Remote mount, NPT connections	★

## Differential pressure range

Code	Description	
1	0 to 25 inH <sub>2</sub> O (0 to 62.16 mbar)	★
2	0 to 250 inH <sub>2</sub> O (0 to 621.6 mbar)	★
3	0 to 1000 inH <sub>2</sub> O (0 to 2.49 bar)	★

## Transmitter output

Code	Description	
A <sup>(1)</sup>	4–20 mA with digital signal based on HART® Protocol	★
F	FOUNDATION™ Fieldbus Protocol	★
W <sup>(2)</sup>	PROFIBUS® PA Protocol	★
X <sup>(3)</sup>	Wireless	★
M <sup>(4)</sup>	Low-power, 1–5 Vdc with digital signal based on HART Protocol	

- (1) HART Revision 5 is the default HART output. The Rosemount 2051 with Selectable HART can be factory or field configured to HART Revision 7. To order HART Revision 7 factory configured, add option code HR7.
- (2) For local addressing and configuration, M4 (LOI) is required. Not available with product certification codes E4, EM, EP, I6, IM, KD, KL, KM, KP, KS, N3.
- (3) Only available with intrinsically safe approvals.
- (4) Only available with Housing Codes A and J and with C6, E2,E5, I5, K5, EM, EP, KB, and E8 product certifications.

## Transmitter housing material

Code	Description	Conduit entry size	
A	Aluminum	½–14 NPT	★
B	Aluminum	M20 x 1.5	★
J	SST	½–14 NPT	★
K	SST	M20 x 1.5	★
P <sup>(1)</sup>	Engineered polymer	No conduit entries	★
D <sup>(2)</sup>	Aluminum	G½	
M <sup>(2)</sup>	SST	G½	

- (1) Only available with output code X.
- (2) Transmitter conduit entry will be ½ NPT and a ½ NPT to G½ thread adapter will be provided. This option is only available with product certifications options I1, I2, I3, I7, IA, IB, IM, KA, N1, N3, N7. Housing code D is also available with E4, and IG.

## Transmitter performance class

Code	Description	
1	Up to ±2.25% flow rate accuracy, 5:1 flow turndown, 2-year stability	★

## Wireless options

Requires wireless output code X and engineered polymer housing code P.

### Wireless transmit rate, operating frequency, and protocol

Code	Description	
WA3	User configurable transmit rate, 2.4 GHz <b>Wireless</b> HART®	★

### Antenna and SmartPower™

Code	Description	
WP5	Internal antenna, compatible with Green Power Module <sup>(1)</sup>	★

(1) IS Power Module sold separately.

## Additional options

### Extended product warranty

Code	Description	
WR3	3-year limited warranty	★
WR5	5-year limited warranty	★

### Alternate transmitter diaphragm material

Code	Description	
ID2	316L SST	
ID3	Alloy C-276	
ID5 <sup>(1)(2)</sup>	Tantalum	

(1) Available in ranges 2–5 only.

(2) Not available with output code X.

### Installation accessories

Code	Description	
AB <sup>(1)</sup>	ANSI alignment ring (Class 150)	★
AC <sup>(1)</sup>	ANSI alignment ring (Class 300)	★
AD <sup>(1)</sup>	ANSI alignment ring (Class 600)	★
DG	DIN alignment ring (PN 16)	★
DH	DIN alignment ring (PN 40)	★
DJ	DIN alignment ring (PN 100)	★
JB	JIS alignment ring (10K) <sup>(2)</sup>	
JR	JIS alignment ring (20K)	

JS	JIS alignment ring (40K)	
----	--------------------------	--

- (1) Only required for 10 in. (250 mm) and 12 in. (300 mm) line sizes.
- (2) Not available on 12 in (300mm) line size.

**Remote adapters**

Code	Description	
FE	Flange adapters 316 SST (½ in. NPT)	★

**High temperature application**

Code	Description	
HT	Graphite valve packing (T <sub>max</sub> = 850 °F [454 °C])	

**Flow calibration**

Consult factory for pipe schedules other than schedule 40.  
 This option is not available with primary element technology P.

Code	Description	
WC	Flow calibration, 3 Pt, conditioning orifice option C	
WD	Flow calibration, 10 Pt, conditioning option C, Rosemount Annubar option A	

**Pressure testing**

Code	Description	
P1	Hydrostatic testing with certificate	

**Special cleaning**

Available with primary element technology C or P only.

Code	Description	
P2	Cleaning for special processes	

**Special inspection**

Code	Description	
QC1	Visual and dimensional inspection with certificate	★
QC7	Inspection and performance certificate	★

**Transmitter calibration certification**

Code	Description	
Q4	Calibration certificate for transmitter	★

### Quality certification for safety

Code	Description	
QT	Safety certified to IEC 61508 with certificate of FMEDA <sup>(1)</sup>	★

(1) The quality certification for safety is only available with HART® 4–20 mA output (code A).

### Material traceability certification

Code	Description	
Q8	Material traceability certification per EN 10204:2004 3.1	★

### Positive material identification (PMI)

Code	Description	
Q76	PMI verification and certificate	★

### Code conformance

Code	Description	
J2	ANSI/ASME B31.1	
J3	ANSI/ASME B31.3	

### Materials conformance

Materials of Construction comply with metallurgical requirements within NACE MR0175/ISO for sour oil field production environments. Environmental limits apply to certain materials. Consult latest standard for details. Selected materials also conform to NACE MR0103 for sour refining environments.

Selecting J5 option will provide Alloy C-276 transmitter diaphragms.

Code	Description	
J5	Certificate of Compliance to NACE MR0175/ISO 15156 for wetted materials	

### Country certification

Code	Description	
J1	Canadian Registration	
J8	Chinese Certificate of Special Equipment Type Test	

### Product certifications

Code	Description	
E8	ATEX Flameproof	★
I1 <sup>(1)</sup>	ATEX Intrinsic Safety	★
IA	ATEX FISCO Intrinsic Safety; for FOUNDATION™ Fieldbus or PROFIBUS® PA Protocol only	★
N1	ATEX Type n Certification	★
K8	ATEX Flameproof, Intrinsic Safety, Type n, Dust (combination of E8, I1 and N1)	★
E4 <sup>(2)</sup>	Japan Flameproof	★

E5	USA Explosion-proof, Dust Ignition-proof	★
I5 <sup>(3)</sup>	USA Intrinsically Safe, Nonincendive	★
K5	USA Explosion-proof, Dust Ignition-proof, Intrinsically Safe, and Division 2	★
E6	Canada Explosion-proof, Dust Ignition-proof, Division 2	★
I6	Canada Intrinsic Safety	★
C6	Canada Explosion-proof, Dust Ignition-proof, Intrinsically Safe, and Division 2	★
K6	Canada and ATEX Explosion-proof, Intrinsically Safe, and Division 2 (combination of C6, E8, and I1)	★
E7	IECEX Flameproof	★
I7	IECEX Intrinsic Safety	★
N7	IECEX Type n Certification	★
K7	IECEX Flameproof, Dust Ignition-proof, Intrinsic Safety, and Type n (combination of I7, N7, and E7)	★
IG	IECEX FISCO Intrinsically Safe; for FOUNDATION Fieldbus or PROFIBUS PA Protocols only	★
E2	Brazil Flameproof	★
I2	Brazil Intrinsic Safety	★
IB	Brazil FISCO intrinsically safe; for FOUNDATION Fieldbus or PROFIBUS PA Protocols only	★
K2	Brazil Flameproof, Intrinsic Safety	★
E3	China Flameproof	★
I3	China Intrinsic Safety	★
EM	Technical Regulations Customs Union (EAC) Flameproof	★
IM	Technical Regulations Customs Union (EAC) Intrinsic Safety	★
KM	Technical Regulations Customs Union (EAC) Flameproof and Intrinsic Safety	★
KB	USA and Canada Explosion-proof, Dust Ignition-proof, Intrinsically Safe, and Division 2 (combination of K5 and C6)	★
KD	USA, Canada, and ATEX Explosion-proof, Intrinsically Safe (combination of K5, C6, I1, and E8)	★
KL <sup>(4)</sup>	USA, Canada, IECEX, ATEX Intrinsic Safety Combination	★
KS	USA, Canada, IECEX, ATEX Explosion-proof, Intrinsically Safe, Dust, Non-Incendive, Type-N, Div. 2	★
EP	Republic of Korea Flameproof	★
IP	Republic of Korea Intrinsic Safety	★
KP	Republic of Korea Flameproof, Intrinsic Safety	★

- (1) Dust approval not applicable to wireless (output code X). See [Rosemount 3051 product certifications](#) for wireless approvals.
- (2) Only available with 4-20 mA HART® (output code A), FOUNDATION™ Fieldbus (output code F), or PROFIBUS® PA (output code W). Only available with aluminum housing and G½ conduit entry size (housing material code D).
- (3) Nonincendive certification not provided with wireless (output code X).
- (4) Only available with wireless (output code X).

### Shipboard approval

Code	Description	
SBS	American Bureau of Shipping <sup>(1)</sup>	★

- (1) Not available with wireless (output code X).

### Sensor fill fluid and O-ring options

Code	Description	
L1 <sup>(1)</sup>	Inert sensor fill fluid	★
L2	Graphite-filled (PTFE) O-ring	★
LA <sup>(1)</sup>	Inert sensor fill fluid and graphite-filled (PTFE) O-ring	★

(1) Not available with output code X.

### Display and interface options

Code	Description	
M4 <sup>(1)</sup>	LCD display with LOI	★
M5	LCD display	★

(1) Not available with FOUNDATION™ Fieldbus (output code F) or wireless (output code X).

### Transient protection

Code	Description	
T1	Transient terminal block <sup>(1)</sup> <sup>(2)</sup>	★

(1) This option is not available with output code X.

(2) This option is not available with housing code 00, 5A, or 7J. The T1 option is not needed with FISCO Product Certifications, transient protection is included with the FISCO Product Certification code IA.

### Manifold for remote mount option

Code	Description	
F2	3-valve manifold, SST	★
F6	5-valve manifold, SST	★

### Alarm limit

This option is only available with 4–20 mA HART® (output codes A and M).

Code	Description	
C4	NAMUR alarm and saturation levels, high alarm	★
CN	NAMUR alarm and saturation levels, low alarm	★
CR	Custom alarm and saturation signal levels, high alarm (requires C1 and Configuration Data Sheet)	★
CS	Custom alarm and saturation signal levels, low alarm (requires C1 and Configuration Data Sheet)	★
CT	Low alarm (standard Rosemount alarm and saturation levels)	★

### Plantweb control functionality

Code	Description	
A01	FOUNDATION Fieldbus advanced control function block suite <sup>(1)</sup>	★

(1) This option is only valid with FOUNDATION™ Fieldbus (output code F).

## Configuration buttons

Code	Description	
D4 <sup>(1)</sup>	Zero and span hardware adjustments	★
DZ <sup>(2)</sup>	Digital zero trim	★

(1) Only available with 4–20 mA HART® (output codes A and M).

(2) Only available with 4–20 mA HART (output codes A and M) and wireless output (code X).

## Ground screw

The V5 option is not needed with the T1 option; external ground screw assembly is included with the T1 option.

Code	Description	
V5	External ground screw assembly	★

## HART® revision configuration

This option is only available with 4–20 mA HART (output codes A and M).

Code	Description	
HR5 <sup>(1)</sup>	Configured for HART Revision 5	★
HR7 <sup>(2)</sup>	Configured for HART Revision 7	★

(1) Configures the HART output to HART Revision 5. The device can be field configured to HART Revision 7 if needed.

(2) Configures the HART output to HART Revision 7. The device can be field configured to HART Revision 5 if needed.

## Rosemount 2051CFP Integral Orifice Flow Meter ordering information

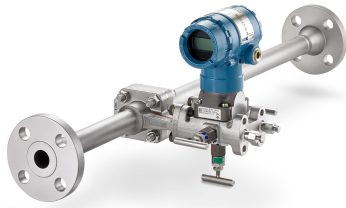

- Complete flow assemblies are leak-tested and calibrated to reduce leak points up to 70 percent and simplify installation
- Primary element integrated in a meter run for ease of installation
- Orifice plate suitable for small line sizes 0.5 1.5 in. (15 - 40 mm) for flow measurement accuracy and repeatability
- Local operator interface offers easy-to-use menus and built-in configuration buttons for streamlined commissioning
- SIL 2/3 certified to IEC 61508 (via 3rd party) and prior-use certificate of FMEDA data for safety installations

CONFIGURE >
VIEW PRODUCT >

### Online product configurator

Many products are configurable online using our product configurator.

Select the **Configure** button or visit [Emerson.com/global](https://emerson.com/global) to start. With this tool's built-in logic and continuous validation, you can configure your products more quickly and accurately.

### Specifications and options

The purchaser of the equipment must specify and select the product materials, options, or components.

### Required model components

#### Model

Code	Description	
2051CFP	Integral orifice flow meter	★

#### Measurement type

Code	Description	
D	Differential pressure	★

#### Material type and body

Code	Description	
F	316 SST, enhanced support body	★

#### Line size

Code	Description	
005	½ in. (15 mm)	★
010	1 in. (25 mm)	★
015	1½ in. (40 mm)	★

**Process connections**

Code	Description	
T1	NPT female body (not available with thermowell and RTD)	★
S1 <sup>(1)</sup>	Socket weld body (not available with thermowell and RTD)	★
P1	Pipe ends: NPT threaded	★
P2	Pipe ends: beveled	★
D1	Pipe ends: flanged, PN16 EN-1092-1 RF, slip-on	★
D2	Pipe ends: flanged, PN40 EN-1092-1 RF, slip-on	★
D3	Pipe ends: flanged, PN100 EN-1092-1 RF, slip-on	★
W1	Pipe ends: flanged, Class 150 RF ASME B16.5, weld-neck	★
W3	Pipe ends: flanged, Class 300 RF ASME B16.5, weld-neck	★
W6	Pipe ends: flanged, Class 600 RF ASME B16.5, weld-neck	★
W9	Pipe ends: flanged, Class 900 RF ASME B16.5, weld-nec	
A1	Pipe ends: flanged, Class 150 RF ASME B16.5, slip-on	
A3	Pipe ends: flanged, Class 300 RF ASME B16.5, slip-on	
A6	Pipe ends: flanged, Class 600 RF ASME B16.5, slip-on	
R1	Pipe ends: flanged, Class 150 RTJ ASME B16.5, slip-on	
R3	Pipe ends: flanged, Class 300 RTJ ASME B16.5, slip-on	
R6	Pipe ends: flanged, Class 600 RTJ ASME B16.5, slip-on	
R9	Pipe ends: flanged, 900# RTJ ASME B16.5, weld-neck	

(1) To improve pipe perpendicularity for gasket sealing, socket diameter is smaller than standard pipe O.D.

**Orifice plate material**

Code	Description	
S	316/316L SST	★

**Bore size**

Code	Description	
0066	0.066 in. (1,68 mm) for ½ in. pipe	★
0109	0.109 in. (2,77 mm) for ½ in. pipe	★
0160	0.160 in. (4,06 mm) for ½ in. pipe	★
0196	0.196 in. (4,98 mm) for ½ in. pipe	★
0260	0.260 in. (6,60 mm) for ½ in. pipe	★
0340	0.340 in. (8,64 mm) for ½ in. pipe	★
0150	0.150 in. (3,81 mm) for 1 in. pipe	★
0250	0.250 in. (6,35 mm) for 1 in. pipe	★
0345	0.345 in. (8,76 mm) for 1 in. pipe	★
0500	0.500 in. (12,70 mm) for 1 in. pipe	★
0630	0.630 in. (16,00 mm) for 1 in. pipe	★
0800	0.800 in. (20,32 mm) for 1 in. pipe	★

Code	Description	
0295	0.295 in. (7,49 mm) for 1½ in. pipe	★
0376	0.376 in. (9,55 mm) for 1½ in. pipe	★
0512	0.512 in. (13,00 mm) for 1½ in. pipe	★
0748	0.748 in. (19,00 mm) for 1½ in. pipe	★
1022	1.022 in. (25,96 mm) for 1½ in. pipe	★
1184	1.184 in. (30,07 mm) for 1½ in. pipe	★
0010	0.010 in. (0,25 mm) for ½ in. pipe	
0014	0.014 in. (0,36 mm) for ½ in. pipe	
0020	0.020 in. (0,51 mm) for ½ in. pipe	
0034	0.034 in. (0,86 mm) for ½ in. pipe	
XXXX	Special bore size (X.XXX in.)	

### Transmitter connection platform

Code	Description	
D3	Direct mount, 3-valve manifold, SST	★
D5	Direct mount, 5-valve manifold, SST	★
R3	Remote mount, 3-valve manifold, SST	★
R5	Remote mount, 5-valve manifold, SST	★

### Differential pressure range

Code	Description	
1	0 to 25 inH <sub>2</sub> O (0 to 62.16 mbar)	★
2	0 to 250 inH <sub>2</sub> O (0 to 621.6 mbar)	★
3	0 to 1000 inH <sub>2</sub> O (0 to 2.49 bar)	★

### Transmitter output

Code	Description	
A <sup>(1)</sup>	4–20 mA with digital signal based on HART® Protocol	★
F	FOUNDATION™ Fieldbus Protocol	★
W <sup>(2)</sup>	PROFIBUS® PA Protocol	★
X <sup>(3)</sup>	Wireless	★
M <sup>(4)</sup>	Low-power, 1–5 Vdc with digital signal based on HART Protocol	

(1) HART Revision 5 is the default HART output. The Rosemount 2051 with Selectable HART can be factory or field configured to HART Revision 7. To order HART Revision 7 factory configured, add option code HR7.

(2) For local addressing and configuration, M4 (LOI) is required. Not available with product certification codes E4, EM, EP, I6, IM, KD, KL, KM, KP, KS, N3.

(3) Only available with intrinsically safe approvals.

(4) Only available with Housing Codes A and J and with C6, E2,E5, I5, K5, EM, EP, KB, and E8 product certifications.

**Transmitter housing material**

Code	Description	Conduit entry size	
A	Aluminum	½-14 NPT	★
B	Aluminum	M20 x 1.5	★
J	SST	½-14 NPT	★
K	SST	M20 x 1.5	★
P <sup>(1)</sup>	Engineered polymer	No conduit entries	★
D <sup>(2)</sup>	Aluminum	G½	
M <sup>(2)</sup>	SST	G½	

(1) Only available with output code X.

(2) Transmitter conduit entry will be ½ NPT and a ½ NPT to G½ thread adapter will be provided. This option is only available with product certifications options I1, I2, I3, I7, IA, IB, IM, KA, N1, N3, N7. Housing code D is also available with E4, and IG.

**Transmitter performance class**

Code	Description	
1	Up to ±2.25% flow rate accuracy, 5:1 flow turndown, 2-year stability	★

**Wireless options**

Requires wireless output code X and engineered polymer housing code P.

**Wireless transmit rate, operating frequency, and protocol**

Code	Description	
WA3	User configurable transmit rate, 2.4 GHz <b>Wireless</b> HART®	★

**Antenna and SmartPower™**

Code	Description	
WP5	Internal antenna, compatible with Green Power Module <sup>(1)</sup>	★

(1) IS Power Module sold separately.

**Additional options**

**Extended product warranty**

Code	Description	
WR3	3-year limited warranty	★
WR5	5-year limited warranty	★

**Alternate transmitter diaphragm material**

Code	Description	
ID2	316L SST	
ID3	Alloy C-276	
ID5 <sup>(1)(2)</sup>	Tantalum	

(1) Available in ranges 2-5 only.

(2) Not available with output code X.

### Temperature sensor

Thermowell material is the same as the body material.

Code	Description	
RT	Thermowell and RTD	

### Optional connection

Code	Description	
G1	DIN 19213 transmitter connection	★

### Pressure testing

Code	Description	
P1	Hydrostatic testing with certificate <sup>(1)</sup>	

(1) This option does not apply to process connection codes T1 and S1. Option P1 may not be ordered in combination with P2.

### Special cleaning

Code	Description	
P2	Cleaning for special processes	

### Material testing

Code	Description	
V1	Dye penetrant exam	

### Material examination

Code	Description	
V2	Radiographic examination	

### Flow calibration

Code	Description	
WD	Discharge coefficient verification <sup>(1)</sup>	

(1) This option is not available for bore sizes 0010, 0014, 0020, 0034, 0066, or 0109. This option does not apply to process connection codes T1 and S1.

### Special inspection

Code	Description	
QC1	Visual and dimensional inspection with certificate	★
QC7	Inspection and performance certificate	★

**Material traceability certification**

Code	Description	
Q8	Material traceability certification per EN 10204:2004 3.1	★

**Positive material identification (PMI)**

Code	Description	
Q76	PMI verification and certificate	★

**Code conformance**

This option is not available with DIN process connection codes D1, D2, or D3.

Code	Description	
J2 <sup>(1)</sup>	ANSI/ASME B31.1	
J3 <sup>(1)</sup>	ANSI/ASME B31.3	

(1) *Changes the transmitter orientation of the assembly. Please refer to the J2, J3 options for B31 compliant assembly in the product drawing.*

**Materials conformance**

Materials of Construction comply with metallurgical requirements within NACE MR0175/ISO for sour oil field production environments. Environmental limits apply to certain materials. Consult latest standard for details. Selected materials also conform to NACE MR0103 for sour refining environments.

Selecting J5 option will provide Alloy C-276 transmitter diaphragms.

Code	Description	
J5	Certificate of Compliance to NACE MR0175/ISO 15156 for wetted materials	

**Country certification**

Code	Description	
J6	European Pressure Directive (PED)	★
J1	Canadian Registration	

**Transmitter calibration certification**

Code	Description	
Q4	Calibration certificate for transmitter	★

**Quality certification for safety**

Code	Description	
QT	Safety certified to IEC 61508 with certificate of FMEDA <sup>(1)</sup>	★

(1) *The quality certification for safety is only available with HART® 4–20 mA output (code A).*

**Product certifications**

Code	Description	
E8	ATEX Flameproof	★

I1 <sup>(1)</sup>	ATEX Intrinsic Safety	★
IA	ATEX FISCO Intrinsic Safety; for FOUNDATION™ Fieldbus or PROFIBUS® PA Protocol only	★
N1	ATEX Type n Certification	★
K8	ATEX Flameproof, Intrinsic Safety, Type n, Dust (combination of E8, I1 and N1)	★
E4 <sup>(2)</sup>	Japan Flameproof	★
E5	USA Explosion-proof, Dust Ignition-proof	★
I5 <sup>(3)</sup>	USA Intrinsically Safe, Nonincendive	★
K5	USA Explosion-proof, Dust Ignition-proof, Intrinsically Safe, and Division 2	★
E6	Canada Explosion-proof, Dust Ignition-proof, Division 2	★
I6	Canada Intrinsic Safety	★
C6	Canada Explosion-proof, Dust Ignition-proof, Intrinsically Safe, and Division 2	★
K6	Canada and ATEX Explosion-proof, Intrinsically Safe, and Division 2 (combination of C6, E8, and I1)	★
E7	IECEX Flameproof	★
I7	IECEX Intrinsic Safety	★
N7	IECEX Type n Certification	★
K7	IECEX Flameproof, Dust Ignition-proof, Intrinsic Safety, and Type n (combination of I7, N7, and E7)	★
IG	IECEX FISCO Intrinsically Safe; for FOUNDATION Fieldbus or PROFIBUS PA Protocols only	★
E2	Brazil Flameproof	★
I2	Brazil Intrinsic Safety	★
IB	Brazil FISCO intrinsically safe; for FOUNDATION Fieldbus or PROFIBUS PA Protocols only	★
K2	Brazil Flameproof, Intrinsic Safety	★
E3	China Flameproof	★
I3	China Intrinsic Safety	★
EM	Technical Regulations Customs Union (EAC) Flameproof	★
IM	Technical Regulations Customs Union (EAC) Intrinsic Safety	★
KM	Technical Regulations Customs Union (EAC) Flameproof and Intrinsic Safety	★
KB	USA and Canada Explosion-proof, Dust Ignition-proof, Intrinsically Safe, and Division 2 (combination of K5 and C6)	★
KD	USA, Canada, and ATEX Explosion-proof, Intrinsically Safe (combination of K5, C6, I1, and E8)	★
KL <sup>(4)</sup>	USA, Canada, IECEX, ATEX Intrinsic Safety Combination	★
KS	USA, Canada, IECEX, ATEX Explosion-proof, Intrinsically Safe, Dust, Non-Incendive, Type-N, Div. 2	★
EP	Republic of Korea Flameproof	★
IP	Republic of Korea Intrinsic Safety	★
KP	Republic of Korea Flameproof, Intrinsic Safety	★

(1) Dust approval not applicable to wireless (output code X). See [Rosemount 3051 product certifications](#) for wireless approvals.

(2) Only available with 4-20 mA HART® (output code A), FOUNDATION™ Fieldbus (output code F), or PROFIBUS® PA (output code W). Only available with aluminum housing and G½ conduit entry size (housing material code D).

(3) Nonincendive certification not provided with wireless (output code X).

(4) Only available with wireless (output code X).

**Shipboard approval**

Code	Description	
SBS	American Bureau of Shipping <sup>(1)</sup>	★

(1) Not available with wireless (output code X).

**Sensor fill fluid and O-ring options**

Code	Description	
L1 <sup>(1)</sup>	Inert sensor fill fluid	★
L2	Graphite-filled (PTFE) O-ring	★
LA <sup>(1)</sup>	Inert sensor fill fluid and graphite-filled (PTFE) O-ring	★

(1) Not available with output code X.

**Display and interface options**

Code	Description	
M4 <sup>(1)</sup>	LCD display with LOI	★
M5	LCD display	★

(1) Not available with FOUNDATION™ Fieldbus (output code F) or wireless (output code X).

**Transient protection**

Code	Description	
T1	Transient terminal block <sup>(1)</sup> <sup>(2)</sup>	★

(1) This option is not available with output code X.

(2) This option is not available with housing code 00, 5A, or 7J. The T1 option is not needed with FISCO Product Certifications, transient protection is included with the FISCO Product Certification code IA.

**Alarm limit**

This option is only available with 4–20 mA HART® (output codes A and M).

Code	Description	
C4	NAMUR alarm and saturation levels, high alarm	★
CN	NAMUR alarm and saturation levels, low alarm	★
CR	Custom alarm and saturation signal levels, high alarm (requires C1 and Configuration Data Sheet)	★
CS	Custom alarm and saturation signal levels, low alarm (requires C1 and Configuration Data Sheet)	★
CT	Low alarm (standard Rosemount alarm and saturation levels)	★

**Plantweb diagnostic functionality**

Code	Description	
D01	FOUNDATION™ Fieldbus Diagnostics Suite	★

**Configuration buttons**

Code	Description	
D4 <sup>(1)</sup>	Zero and span hardware adjustments	★

DZ <sup>(2)</sup>	Digital zero trim	★
-------------------	-------------------	---

(1) Only available with 4–20 mA HART® (output codes A and M).

(2) Only available with 4–20 mA HART (output codes A and M) and wireless output (code X).

### Ground screw

The V5 option is not needed with the T1 option; external ground screw assembly is included with the T1 option.

Code	Description	
V5	External ground screw assembly	★

### HART® revision configuration

This option is only available with 4–20 mA HART (output codes A and M).

Code	Description	
HR5 <sup>(1)</sup>	Configured for HART Revision 5	★
HR7 <sup>(2)</sup>	Configured for HART Revision 7	★

(1) Configures the HART output to HART Revision 5. The device can be field configured to HART Revision 7 if needed.

(2) Configures the HART output to HART Revision 7. The device can be field configured to HART Revision 5 if needed.

# Specifications

## Performance specifications

### Flow performance

Performance assumptions include: measured pipe ID, transmitter is trimmed for optimum flow accuracy, and performance is dependent on application parameters.

### Flow reference accuracy

Range 1 flow meters may experience an additional uncertainty up to 0.9%. Consult your Emerson Representative for exact specifications.

Rosemount 2051CFA Annubar Flow Meter		
Ranges 2-3		±2.00 percent of flow rate at 5:1 flow turndown
Rosemount 2051CFC_A Compact Annubar Flow Meter — Annubar option A		
Ranges 2-3	Standard	±2.60 percent of flow rate at 5:1 flow turndown
	Calibrated	±2.30 percent of flow rate at 5:1 flow turndown
Rosemount 2051CFC Compact Orifice Flow Meter — conditioning option C		
Ranges 2-3	$\beta = 0.4$	±2.25 percent of flow rate at 5:1 flow turndown
	$\beta = 0.65$	±2.45 percent of flow rate at 5:1 flow turndown
Rosemount 2051CFC Compact Orifice Flow Meter — Orifice Type Option P <sup>(1)</sup>		
Ranges 2-3		±2.50 percent of flow rate at 5:1 flow turndown
Rosemount 2051CFP Integral Orifice Flow Meter		
Ranges 2-3	Bore < 0.160	±3.10 percent of flow rate at 5:1 flow turndown
	0.160 ≤ bore < 0.500	±2.75 percent of flow rate at 5:1 flow turndown
	0.500 ≤ bore ≤ 0.1000	±2.25 percent of flow rate at 5:1 flow turndown
	0.1000 < bore	±3.00 percent of flow rate at 5:1 flow turndown

(1) For smaller line sizes, see Rosemount Compact Orifice.

### Long-term stability

±50 °F (28 °C) temperature changes and up to 1000 psi. (6,9 MPa) line pressure.

Models	Standard	High performance option, P8
Rosemount 2051C		
Range 1 (CD)	±0.2 percent of URL for 1 year	±0.175 percent of URL for 7 years
Ranges 2-5	±0.125 percent of URL for 5 years	

### Dynamic performance

4–20 mA HART <sup>®</sup> (1) 1–5 Vdc HART Low Power		FOUNDATION Fieldbus and PROFIBUS PA Protocols(2)	Typical HART Transmitter Response Time
Total response time ( $T_d + T_c$ ):			<p>Transmitter Output vs. Time</p> <p>Pressure released</p> <p>100%</p> <p>36.8%</p> <p>0%</p> <p>Time</p> <p><math>T_d</math> = Dead time <math>T_c</math> = Time constant Response time = <math>T_d + T_c</math></p> <p>63.2% of total step change</p>
Rosemount 2051C			
Range 3–5:	115 ms	152 ms	
Range 1:	270 ms	307 ms	
Range 2:	130 ms	152 ms	
Dead time ( $T_d$ )	60 ms (nominal <sup>(3)</sup> )	97 ms	
Update rate <sup>(4)</sup>	22 times per second		

- (1) Dead time and update rate apply to all models and ranges; analog output only.
- (2) Transducer block response time, analog input block execution time not included.
- (3) Nominal total response time at 75 °F (24 °C) reference conditions.
- (4) Does not apply to wireless (output code X). See [Wireless \(output code X\)](#) for wireless update rate.

### Line pressure effect per 1000 psi (6,9 MPa)

For line pressures above 2000 psi (13,7 MPa) and ranges 4–5, see Rosemount 2051 [Reference Manual](#) for HART<sup>®</sup>, Rosemount 2051 [Reference Manual](#) for Wireless HART<sup>®</sup>, Rosemount 2051 [Reference Manual](#) for FOUNDATION<sup>™</sup> Fieldbus, and Rosemount 2051 [Reference Manual](#) PROFIBUS<sup>®</sup> PA.

Models	Line pressure effect	
Rosemount 2051CD, 2051CF	Zero Error <sup>(1)</sup>	Span error
Range 1	±0.25 percent of URL/1000 psi (68,9 bar)	±0.4 percent of reading/1,000 psi (68,9 bar)
Ranges 2–3	±0.05 percent of URL/1000 psi (68,9 bar) for line pressures from 0 to 2000 psi (0 to 13,7 MPa)	±0.1 percent of reading/1,000 psi (68,9 bar)

- (1) Can be calibrated out at line pressure.

### Ambient temperature effect per 50 °F (28 °C)

Models	Ambient temperature effect
Rosemount 2051C, 2051CF	
Ranges 2–5	±(0.025% URL + 0.125% span) from 1:1 to 5:1 ±(0.05% URL + 0.25% span) from 5:1 to 100:1
Range 1	±(0.1% URL + 0.25% span) from 1:1 to 30:1

### Mounting position effects

Models	Mounting position effects
Rosemount 2051C	Zero shifts up to ±1.25 inH <sub>2</sub> O (3,1 mbar), which can be calibrated out. No span effect.

### Vibration effect

#### Rosemount 2051CFC

- Vibration Structural Limits

- Qualified per the requirements of IEC61298-3 (2008) for field with general application or pipeline with low vibration level (10–1000 Hz test frequency range, 0.15 mm displacement peak amplitude, 20 m/s<sup>2</sup> acceleration amplitude).
- The weight and length of the transmitter assembly shall not exceed 9.8 lb (4,45 kg) and 8.60 in. (218,44 mm).

#### ■ **Vibration Performance Specifications**

- Less than ±0.1 percent of URL when tested per the requirements of IEC60770-1 field or pipeline with high vibration level (10–60 Hz 0.21 mm displacement peak amplitude/60–2000 Hz 3g).

---

#### **Note**

SST temperature housing is not recommended with primary element technology A in applications with mechanical vibration.

---

#### **Rosemount 2051CFA**

##### ■ **Vibration Structural Limits**

- Due to wide variation in Annubar™ flow meter models, no structural limits are specified. Please contact your local Emerson representative for application questions.

##### ■ **Vibration Performance Specifications**

- Less than ±0.1 percent of URL when tested per the requirements of IEC60770-1 field or pipeline with high vibration level (10–60 Hz 0.21 mm displacement peak amplitude/60–2000 Hz 3 g).

#### **Rosemount 2051CFP**

##### ■ **Vibration Structural Limits**

- Qualified per the requirements of IEC60068-2-6 (2007) for field with general application or pipeline with low vibration level (10 to 1000 Hz test frequency range, 0.075 mm displacement peak amplitude, 10 m/s<sup>2</sup> acceleration amplitude).

- The weight of the transmitter assembly shall not exceed 12.6 lb (5,72 kg).

##### ■ **Vibration Performance Specifications**

- Less than ±0.1 percent of URL when tested per the requirements of IEC60770-1 field or pipeline with high vibration level (10–60 Hz 0.21 mm displacement peak amplitude/60–2000 Hz 3g).

### **Power supply effect**

Less than ±0.005 percent of calibrated span per volt.

### **Electromagnetic compatibility**

Meets all industrial environment requirements of EN61326 and NAMUR NE-21. Maximum deviation <1 % span during EMC disturbance.

---

#### **Note**

NAMUR NE-21 does not apply to Low-Power (Transmitter output option code M) or Wireless (Transmitter output code X).

---

#### **Note**

During surge event, device with 4–20mA (Transmitter output option code A) may exceed maximum EMC deviation limit or reset; however, device will self-recover and return to normal operation within specified start-up time.

---

### **Transient protection (option code T1)**

Meets IEEE C62.41, category location B

- 6 kV crest (0.5 μs–100 kHz)
- 3 kA crest (8 x 20 microseconds)

- 6 kV crest (1.2 x 50 microseconds)

## Functional specifications

### Range and sensor limits

Table 30: Rosemount 2051CD and 2051CF

Range	Minimum span	Upper (URL)	Lower (LRL)
			Rosemount 2051C Differential, 2051CF Flow Meters
1	0.5 inH <sub>2</sub> O (1,2 mbar)	25 inH <sub>2</sub> O (62,3 mbar)	0 inH <sub>2</sub> O (0 mbar)
2	2.5 inH <sub>2</sub> O (6,2 mbar)	250 inH <sub>2</sub> O (0,62 bar)	0 inH <sub>2</sub> O (0 mbar)
3	10 inH <sub>2</sub> O (24,9 mbar)	1000 inH <sub>2</sub> O (2,49 bar)	0 inH <sub>2</sub> O (0 mbar)

### Service

Liquid, gas, and vapor applications

### 4–20 mA HART®(output code A)

#### Power supply

External power supply required. Standard transmitter operates on 10.5–42.4 Vdc with no load.

#### Load limitations

Maximum loop resistance is determined by the voltage level of the external power supply described by:

Max. loop resistance = 43.5 (power supply voltage - 10.5)

Communication requires a minimum loop resistance of 250 ohms.

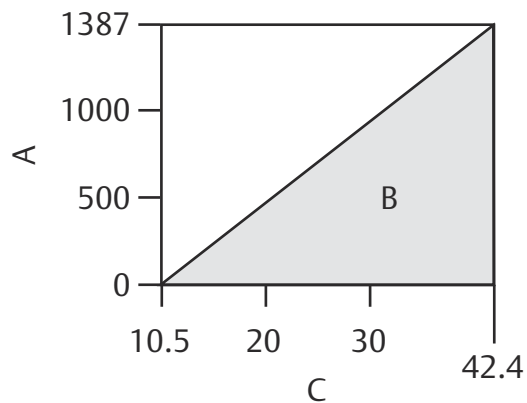

- A. Load ( $\Omega$ s)
- B. Operating region
- C. Voltage (Vdc)

**Note**

For CSA approval, power supply must not exceed 42.4 V.

**Indication**

Optional two line LOI/LCD display

**Zero and span adjustment requirements**

Zero and span values can be set anywhere within the range limits stated in [Range and sensor limits](#). Span must be greater than or equal to the minimum span stated.

**FOUNDATION™ Fieldbus (output code F)**

**Power supply**

External power supply required; transmitters operate on 9.0–32.0 Vdc transmitter terminal voltage for non-I.S. applications, 9.0–30 Vdc for entity model intrinsically safe applications and 9.0–17.5 Vdc for FISCO intrinsically safe applications.

**Current draw**

17.5 mA for all configurations (including LCD display option)

**Indication**

Optional two-line LCD display

**FOUNDATION Fieldbus Function block Execution times**

Block	Execution time
Resource	N/A
Transducer	N/A
LCD display block	N/A
Analog input 1, 2	20 milliseconds
PID	25 milliseconds
Arithmetic	20 milliseconds
Input selection	20 milliseconds
Signal characterizer	20 milliseconds
Integrator	20 milliseconds
Output splitter	20 milliseconds
Control selector	20 milliseconds

**FOUNDATION Fieldbus parameters**

Schedule entries	Links	Virtual communications relationships (VCR)
7 (max.)	25 (max.)	20 (max.)

**Standard function blocks**

**Analog input (AI) block**

The AI function block processes the measurements from the sensor and makes them available to other function blocks. The output value from the AI block is in engineering units and contains a status indicating the quality of the measurement. The AI block is widely used for scaling functionality.

---

**Note**

The channel, Set XD\_Scale, Set L\_Type, and sometimes Set Out\_Scale are typically configured by instrument personnel. Other AI block parameters, block links, and schedule are typically configured by the control systems configuration engineer.

---

**PROFIBUS® PA (output code W)****Profile version**

3.02

**Power supply**

External power supply required; transmitters operate on 9.0–32.0 Vdc transmitter terminal voltage for non-IS applications, 9.0–30 Vdc for entity model intrinsically safe applications and 9.0–17.5 Vdc for FISCO intrinsically safe applications.

**Current draw**

17.5 mA for all configurations (including LCD display option)

**Output update rate**

Four times per second

**Standard function blocks****Analog input (AI) block**

The AI function block processes the measurements from the sensor and makes them available to other function blocks. The output value from the AI block is in engineering units and contains a status indicating the quality of the measurement. The AI block is widely used for scaling functionality.

---

**Note**

The channel, Set XD\_Scale, Set L\_Type, and sometimes Set Out\_Scale are typically configured by instrument personnel. Other AI block parameters, block links, and schedule are typically configured by the control systems configuration engineer.

---

**Indication**

Optional two-line LCD display

**LOI**

Optional external configuration buttons

**Wireless (output code X)****Output**

IEC 62591 (*Wireless HART*®), 2.4 GHz DSSS

**Wireless radio (internal antenna, WP5 option)**

- Frequency: 2.400–2.485 GHz
- Channels: 15
- Modulation: IEEE 802.15.4 compliant DSSS
- Transmission: Maximum of 10 dBm EIRP

### Local display

The optional three-line, seven-digit LCD display can display user-selectable information such as primary variable in engineering units, scaled variable, percent of range, sensor module temperature, and electronics temperature. The display updates based on the wireless update rate.

### Digital zero trim

Digital zero trim (option DZ) is an offset adjustment to compensate for mounting position effects, up to 5 percent of URL.

### Update rate

User selectable 1 second to 60 minutes

### Wireless sensor module for in-line transmitters

The Rosemount 2051 Wireless Transmitter requires the engineered polymer housing to be selected. The standard sensor module will come with aluminum material. If SST is required, the option WSM must be selected.

### Power module

Field replaceable, keyed connection eliminates the risk of incorrect installation, Intrinsically Safe Lithium-thionyl chloride Power Module with PBT/PC enclosure. 10-year life at one minute update rate.

---

### Note

Reference conditions are 70 °F (21 °C), and routing data for three additional network devices. Continuous exposure to ambient temperature limits of -40 to 185 °F (-40 to 85 °C) may reduce specified life by less than 20 percent.

---

## HART® 1-5 Vdc low power (output code M)

### Output

Three-wire 1-5 Vdc output, user-selectable for linear or square root output. Digital process variable superimposed on voltage signal, available to any host conforming to the HART Protocol.

### Power consumption

3.0 mA, 27-84 mW

### Output load

100 kΩ or greater (meter input impedance)

### Turn-on time

Performance within specifications less than two seconds after power is applied to the transmitter.

## Overpressure limits

Transmitters withstand the following limits without damage:

### Rosemount 2051C, 2051CF

- Ranges 2-5: 3,626 psig (250 bar) 4,500 psig (310,3 bar) for option code P9
- Range 1: 2,000 psig (137,9 bar)

## Static pressure limit

### Rosemount 2051CD, 2051CF

- Operates within specifications between static line pressures of -14.2 and 3626 psig (0,034 and 250 bar)
- For option code P9, 4500 psig (310,3 bar)
- Range 1: 0.5 psia to 2000 psig (34 mbar and 137,9 bar)

## Burst pressure limits

### Rosemount 2051C, 2051CF coplanar or traditional transmitter flange

10,000 psig (689.5 bar)

## Temperature limits

### Ambient

-40 to 185 °F (-40 to 85 °C)

with LCD display: -40 to 175 °F (-40 to 80 °C)

### Note

Rosemount 2051 LCD display may not be readable and LCD display updates may be slower at temperatures below -22 °F (-30 °C).

### Note

Wireless LCD display may not be readable and LCD display updates will be slower at temperatures below -4 °F (-20 °C).

### Storage

-50 to 230 °F (-46 to 110 °C)

with LCD display: -40 to 185 °F (-40 to 85 °C)

with Wireless output: -40 to 185 °F (-40 to 85 °C)

### Rosemount 2051CFA process temperature limits

- |                                 |   |
|---------------------------------|---|
| <b>Direct mount transmitter</b> | <ul style="list-style-type: none"> <li>■ 500 °F (260 °C)</li> <li>750 °F (398 °C) when used with a direct mount, high temperature 5-valve manifold (transmitter connection platform code 6). Maximum temperature limit for steam processes with Flange-Lok and Pak-Lok connections is 600 °F (316 °C).</li> </ul> |
| <b>Remote mount transmitter</b> | <ul style="list-style-type: none"> <li>■ 1250 °F (677 °C) – Alloy C-276 sensor material (for superheated steam applications above 1,000 °F (538 °C), it is recommended that the Rosemount 585 with alloy 800H sensor material is used.)</li> <li>■ 850 °F (454 °C) – SST sensor material</li> </ul>               |

### Pressure and temperature limits

Static pressure selection may effect pressure limitations.

- |                                 |  |
|---------------------------------|--|
| <b>Direct mount transmitter</b> | <ul style="list-style-type: none"> <li>■ Up to Class 600 ANSI (2160 psig at 100 °F [149 bar at 38 °C])</li> <li>■ Integral temperature measurement is not available with flanged mounting type greater than Class 600</li> </ul> |
| <b>Remote mount transmitter</b> | Up to Class 2500 ANSI (6000 psig at 100 °F [416 bar at 38 °C]).  |

### Rosemount 2051CFC process temperature limits

**Direct mount transmitter** -40 to 450 °F (-40 to 232 °C)

**Remote mount transmitter** -315 to 850 °F (-192 to 454 °C)

### Rosemount 2051CFC process temperature limits

Consult factory for all-welded design for extended temperatures.

**Standard (direct/remote mount)** -40 to 450 °F (-40 to 232 °C)

**Extended (remote mount only with option code GT)** -112 to 850 °F (-80 to 454 °C)

**Process**

**Table 31: Process Temperature Limits**

Rosemount 2051C, 2051CF	
<b>Silicone fill sensor<sup>(1)</sup></b>	
with coplanar flange	-40 to 250 °F (-40 to 121 °C) <sup>(2)</sup>
Inert fill sensor <sup>(1)</sup>	-40 to 185 °F (-40 to 85 °C) <sup>(3)</sup>

- (1) Process temperatures above 185 °F (85 °C) require derating the ambient limits by a 1.5:1 ratio.
- (2) 220 °F (104 °C) limit in vacuum service; 130 °F (54 °C) for pressures below 0.5 psia.
- (3) 160 °F (71 °C) limit in vacuum service.

**Humidity limits**

0-100 percent relative humidity

**Volumetric displacement**

Less than 0.005 in<sup>3</sup> (0,08 cm<sup>3</sup>)

**Damping**

**4-20 mA HART<sup>®</sup> Protocol**

Analog output response to a step input change is user-enterable from 0-60 seconds for one time constant. This software damping is in addition to sensor module response time.

**FOUNDATION<sup>™</sup> Fieldbus Protocol**

Transducer block: User configurable  
 AI block: User configurable

**PROFIBUS<sup>®</sup> PA Protocol**

AI block only: User configurable

**Failure mode alarm**

**4-20 mA HART<sup>®</sup> Protocol (output code A)**

If self-diagnostics detect a sensor or microprocessor failure, the analog signal is driven either high or low to alert the user. High or low failure mode is user-selectable with a jumper on the transmitter. The values to which the transmitter drives its output in failure mode depend on whether it is factory-configured to standard or NAMUR-compliant operation. The values for each are as follows:

**Table 32: Standard Operation**

Output code	Linear output	Fail high	Fail low
A	$3.9 \leq I \leq 20.8$	$I \geq 21.75 \text{ mA}$	$I \leq 3.75 \text{ mA}$
M	$0.97 \leq V \leq 5.2$	$V \geq 5.4 \text{ V}$	$V \leq 0.95 \text{ V}$

**Table 33: NAMUR-Compliant Operation**

Output code	Linear output	Fail high	Fail low
A	$3.8 \leq I \leq 20.5$	$I \geq 22.5 \text{ mA}$	$I \leq 3.6 \text{ mA}$

### Output code F and X

If self-diagnostics detect a gross transmitter failure, that information gets passed as a status along with the process variable.

## Physical specifications

### Material selection

Emerson provides a variety of Rosemount product with various product options and configurations including materials of construction that can be expected to perform well in a wide range of applications. The Rosemount product information presented is intended as a guide for the purchaser to make an appropriate selection for the application. It is the purchaser's sole responsibility to make a careful analysis of all process parameters (such as all chemical components, temperature, pressure, flow rate, abrasives, contaminants, etc.), when specifying product, materials, options, and components for the particular application. Emerson is not in a position to evaluate or guarantee the compatibility of the process fluid or other process parameters with the product, options, configuration or materials of construction selected.

### Electrical connections

½–14 NPT, G½, and M20 x 1.5 conduit

### Process connections

#### Rosemount 2051C

- ¼–18 NPT on 2½ in. centers
- ½–14 NPT and RC½ on 2 in. (50,8 mm), 2½ in. (54,0 mm), or 2¾ in. (57,2 mm) centers (process adapters)

### Process-wetted parts

#### Rosemount 2051CFA wetted parts-

<b>Rosemount Annubar sensor material</b>	<ul style="list-style-type: none"> <li>■ 316 SST</li> <li>■ Alloy C-276</li> </ul>
--	--

---

#### Note

Cage nipple is made from 304 SST.

---

#### Rosemount 2051CFC wetted parts

<b>Body/plate</b>	316/316L SST 50 micro-inch Ra surface finish
<b>Manifold head/valves</b>	316 SST
<b>Flange studs and nuts</b>	Customer supplied Available as a spare part
<b>Transmitter connection studs and nuts</b>	Studs– 300 Series Stainless Steel Nuts– A194 Grade 8M
<b>Gasket and O-rings</b>	Gaskets are customer supplied. Durlon 8500 fiber gaskets are recommended. Consult an Emerson representative for use with other gaskets Available as a spare part

**Note**

It is recommended that gaskets and O-rings be replaced when the Rosemount 405 is disassembled.

**Rosemount 2051CFP wetted parts-material of construction**

<b>Orifice plate</b>	316/316L SST Alloy C-276 Alloy 400
<b>Body</b>	A312 Gr 316/316L
<b>Pipe material (if applicable)</b>	A312 Gr 316/316L
<b>Flange</b>	A182 Gr 316/316L Flange pressure limits are per ANSI B16.5 Flange face finish per ANSI B16.5, 125 to 250 RMS
<b>Body bolts/studs</b>	300 Series Stainless Steel ASTM A193 Gr B8M Class 2 body studs provided for 1-½-in. (code 015) line size units ordered with high pressure process connection option codes W9, R9, T1, S1, or P2.
<b>Transmitter connection studs</b>	300 Series Stainless Steel
<b>Gaskets/O-rings</b>	Glass filled PTFE Gaskets and O-rings must be replaced each time the Rosemount 2051CFP is disassembled for installation or maintenance.

**Rosemount 2051C process wetted parts****Drain/vent valves**

316 SST or alloy C-276

**Transmitter flanges and adapters**

Plated CS, SST CF-8M (cast version of 316 SST, material per ASTM-A743), or CW2M (cast version of alloy C)

**Wetted O-rings**

Glass-filled PTFE or graphite-filled PTFE

**Process isolating diaphragms**

316L SST, alloy C-276, or tantalum

**Non-wetted parts****Electronics housing**

Low-copper aluminum or CF-8M (cast version of 316 SST) Enclosures meet NEMA Type 4X, IP66, and IP68 when properly installed.

Housing material code P: PBT/PC with NEMA 4X and IP66/67/68

**Paint for aluminum housing**

Polyurethane

**Coplanar sensor module housing**

CF-3M (cast version of 316L SST)

**Bolts**

ASTM A449, Type 1 (zinc-cobalt plated CS) ASTM F593G, Condition CW1 (austenitic 316 SST) ASTM A193, Grade B7M (zinc plated alloy steel) Alloy K-500

**Sensor module fill fluid**

Silicone or inert halocarbon

**Cover O-rings**

Buna-N

Silicone (for wireless option code X)

**Power module**

Field replaceable, keyed connection eliminates the risk of incorrect installation, Intrinsically Safe Lithium-thionyl chloride power module with PBT enclosure.

# Product certifications

## Rosemount 2051 product certifications

Rev 1.31

### European Directive information

A copy of the EU Declaration of Conformity can be found at the end of the Quick Start Guide. The most recent revision of the EU Declaration of Conformity can be found at [Emerson.com/Rosemount](https://www.emerson.com/Rosemount).

### Ordinary location certification

As standard, the transmitter has been examined and tested to determine that the design meets the basic electrical, mechanical, and fire protection requirements by a Nationally Recognized Test Laboratory (NRTL) as accredited by the Federal Occupational Safety and Health Administration (OSHA).

### Hazardous location certification

#### NOTICE

Device ambient temperature ratings and electrical parameters may be limited to the levels dictated by the hazardous location certificate parameters.

## North America

### E5 USA Explosionproof (XP) and Dust Ignition-proof (DIP)

<b>Certificate</b>	2041384
<b>Standards</b>	FM 3600: 2022, FM 3615: 2022, FM 3616: 2022, ANSI/UL 61010-1-2019 Third Edition, ANSI/UL 12.27.01: 2022 (Fourth Edition), ANSI/UL 50E (First Edition)
<b>Markings</b>	XP CL I, DIV I, GP B, C, & D T5; Seal not required DIP CL II, DIV I, GP E, F, & G; CL III T5; T5: (-50 °C ≤ Ta ≤ +85 °C) Type 4X, IP 68 Optional: single seal

#### Specific Conditions of Use:

1. The Rosemount 2051 transmitter housing may contain aluminum and is considered a potential risk of ignition by impact or friction. Care must be taken during installation and use to prevent impact and friction.
2. Equipment evaluated for atmospheric pressure range between 80 kPa (0.8 bar) to 110 kPa (1.1 bar).
3. Process temperature limits shall be in accordance with 03031-1053.

### I5 USA Intrinsic Safety (IS), Nonincendive (NI)

<b>Certificate</b>	2041384
<b>Standards</b>	FM3600: 2022, FM3610: 2021, FM3611: 2021, ANSI/UL61010-1-2019 Third Edition, ANSI/UL60079-0: 2017, ANSI/UL60079-11: 2013, ANSI/UL12.27.01: 2022 (Fourth Edition), ANSI/UL50E (First Edition)
<b>Markings</b>	IS: CL I GP A, B, C, D T4; CL II GP EFG; CL III T4; CL I ZN 0 AEx ia IIC T4 Ga;

NI: CL I DIV 2 GP ABCD T4;  
 (-50 °C ≤ Ta ≤ +70 °C)  
 Install per 02051-1008.  
 Type 4X, IP 68  
 Optional: single seal

**Specific Conditions of Use:**

1. The Model 2051 transmitter housing may contain aluminum and is considered a potential risk of ignition by impact or friction. Care must be taken during installation and use to prevent impact and friction.
2. The Model 2051 with the transient terminal block (Option code T1) will not pass the 500 VRMS dielectric strength test; this must be considered during installation.
3. Equipment evaluated for atmospheric pressure range between 80 kPa (0.8 bar) to 110 kPa (1.1 bar).
4. Maximum process temperature limits shall be in accordance with 03031-1053.

**IE USA FISCO**

**Certificate** 2041384

**Standards** FM 3600: 2022, FM 3610: 2021, FM 3611: 2021, ANSI/UL 61010-1-2019 Third Edition, ANSI/UL 60079-0: 2017, ANSI/UL 60079-11: 2013, ANSI/UL 12.27.01: 2022 (Fourth Edition), ANSI/UL 50E (First Edition)

**Markings** IS: CL I GP ABCD T4  
 CL I ZN 0 AEx ia IIC T4 Ga  
 -50 °C ≤ Ta ≤ +60 °C  
 FISCO  
 Type 4X, IP 68  
 Install per 02051-1008  
 Optional: single seal

**Specific Conditions of Use:**

1. The Model 2051 transmitter housing may contain aluminum and is considered a potential risk of ignition by impact or friction. Care must be taken during installation and use to prevent impact and friction.
2. Equipment evaluated for atmospheric pressure range between 80 kPa (0.8 bar) to 110 kPa (1.1 bar).
3. Maximum process temperature limits shall be in accordance with 03031-1053.

**E6 Canada Explosionproof, Dust Ignition-proof**

**Certificate** 2041384

**Standards** CAN/CSA C22.2 No. 61010-1-12, CAN/CSA C22.2 No. 94.2-07, CSA C22.2 No. 25-17, CAN/CSA C22.2 No. 30:20, CAN/CSA C22.2 No. 60079-0:19, CAN/CSA C22.2 No. 60079-1:16, ANSI/UL 12.27.01: 2022 (Fourth Edition)

**Markings:** XP: CL I, DIV I, GP B,C, D T5;  
 Ex db IIC T5 Gb;  
 Seal not required  
 DIP: CL II, DIV I, GP E, F, & G; CL III T5;  
 -50 °C ≤ Ta ≤ +85 °C  
 Single seal - temp limits 03031-1053  
 Type 4X, IP 68

**Specific Conditions of Use:**

1. The Model 2051 transmitter housing may contain aluminum and is considered a potential risk of ignition by impact or friction. Care must be taken during installation and use to prevent impact and friction.
2. Equipment evaluated for atmospheric pressure range between 80 kPa (0.8 bar) to 110 kPa (1.1 bar).

**I6 Canada Intrinsic Safety (IS)**

<b>Certificate</b>	2041384
<b>Standards</b>	C22.2 No. 61010-1-12, C22.2 No. 25-17, C22.2 No. 94.2-20 Third Edition, CSA Std C22.2 No. 213-17 + UPD 1 (2018) + UPD 2 (2019) + UPD 3 (2021), CAN/CSA-60079-0:19, CAN/CSA-60079-11:14, ANSI/UL 122701: 2022 (Fourth Edition), ANSI/UL 50E (First Edition)
<b>Markings</b>	IS: CL I GP A, B, C, D T4; CL II GP E, F, G, CL III T4; Ex ia IIC T4 Ga; NI: CL I DIV 2 GP A, B, C, D -50 °C ≤ Ta ≤ +70 °C Install per 02051-1008 Single seal - temp limits per 03031-1053 Type 4X, IP 68

**Specific Conditions of Use:**

1. The Model 2051 transmitter housing may contain aluminum and is considered a potential risk of ignition by impact or friction. Care must be taken during installation and use to prevent impact and friction.
2. The Model 2051 with the transient terminal block (Option code T1) will not pass the 500 VRMS dielectric strength test; this must be considered during installation.
3. Equipment evaluated for atmospheric pressure range between 80 kPa (0.8 bar) to 110 kPa (1.1 bar).

**IF Canada FISCO**

<b>Certificate</b>	2041384
<b>Standards</b>	C22.2 No. 61010-1-12, C22.2 No. 25-17, C22.2 No. 94.2-20 Third Edition, CSA Std C22.2 No. 213-17 + UPD 1 (2018) + UPD 2 (2019) + UPD 3 (2021), CAN/CSA-60079-0:19, CAN/CSA-60079-11:14, ANSI/UL 12.27.01:2022 (Fourth Edition), ANSI/UL 50E (First Edition)
<b>Markings:</b>	IS: CL I GP ABCD T4; Ex ia IIC T4 Ga -50 °C ≤ Ta ≤ +60 °C FISCO Install per 02051-1008 Single seal - temp limits per 03031-1053 Type 4X, IP 68

**Specific Conditions of Use:**

1. The Model 2051 transmitter housing may contain aluminum and is considered a potential risk of ignition by impact or friction. Care must be taken during installation and use to prevent impact and friction.
2. Equipment evaluated for atmospheric pressure range between 80 kPa (0.8 bar) to 110 kPa (1.1 bar).

## Europe

### E1 ATEX/UKEX Flameproof

**ATEX Certificate** KEMA 08ATEX0090X

**UKEX Certificate** DEKRA 21UKEX0288X

**Standards** EN IEC 60079-0: 2018, EN 60079-1: 2014, EN 60079-26: 2015

**Markings:** Ⓜ II 1/2 G Ex db IIC Ga/Gb T6 (-60 °C ≤ Ta ≤ +70 °C), T4/T5 (-60 °C ≤ Ta ≤ +80 °C)

**Table 34: Process connection temperature**

Temperature class	Process connection temperature	Ambient temperature
T6	-60 °C to +70 °C	-60 °C to +70 °C
T5	-60 °C to +80 °C	-60 °C to +80 °C
T4	-60 °C to +120 °C	-60 °C to +80 °C

### Special Conditions for Safe Use (X):

1. Appropriate cable, glands, and plugs need to be suitable for a temperature of 5 °C greater than maximum specified temperature for location where installed.
2. Non-standard paint options may cause risk from electrostatic discharge. Avoid installations that could cause electrostatic build-up on painted surfaces and only clean the painted surfaces with a damp cloth. If paint is ordered through a special option code, contact the manufacturer for more information.
3. This device contains a thin wall diaphragm less than 1 mm thick that forms a boundary between Category 1G (process connection) and Category 2G (all other parts of the equipment). The model code and datasheet are to be consulted for details of the diaphragm material. During installation, maintenance, and use, the environmental conditions to which the diaphragm will be subjected shall be taken into account. The manufacturer's instructions for installation and maintenance shall be followed in detail to assure safety during its expected lifetime.
4. Flameproof joints are not intended to be repaired.

### Conduit/cable entries

Unless otherwise marked, the conduit/cable entries in the housing enclosure use a ½-14 NPT form. Only use plugs, adapters, glands, or conduit with a compatible thread form when closing these entries. Entries marked M20 are M20 x 1.5 thread form. On devices with multiple conduit entries, all entries will have the same thread form. When installing in a hazardous location, use only appropriately listed or Ex certified plugs, glands, or adapters in cable/conduit entries.

### I1 ATEX Intrinsic Safety

**Certificate** Baseefa08ATEX0129X

**Standards** EN IEC 60079-0: 2018, EN60079-11: 2012

**Markings** Ⓜ II 1 G Ex ia IIC T4 Ga (-60 °C ≤ Ta ≤ +70 °C)

**Table 35: Input parameters**

	HART®	Fieldbus/PROFIBUS®
Voltage U <sub>i</sub>	30 V	30 V
Current I <sub>i</sub>	200 mA	300 mA
Power P <sub>i</sub>	1 W	1.3 W
Capacitance C <sub>i</sub>	0.012 μF	0 μF
Inductance L <sub>i</sub>	0 mH	0 mH

**Special Conditions for Safe Use (X):**

1. If the equipment is fitted with an optional 90 V transient suppressor, it is incapable of withstanding the 500 V isolation from earth test, and this must be taken into account during installation.
2. The enclosure may be made of aluminum alloy and given a protective polyurethane paint finish; however, care must be taken to protect it from impact or abrasion if located in Zone 0.

**IA ATEX FISCO**

**Certificate** Baseefa08ATEX0129X  
**Standards** EN IEC 60079-0: 2018, EN60079-11: 2012  
**Markings** Ⓢ II 1 G Ex ia IIC T4 Ga (-60 °C ≤ Ta ≤ +60 °C)

**Table 36: Input parameters**

	<b>FISCO</b>
Voltage $U_i$	17.5 V
Current $I_i$	380 mA
Power $P_i$	5.32 W
Capacitance $C_i$	0 μF
Inductance $L_i$	0 mH

**Special Conditions for Safe Use (X):**

1. If the equipment is fitted with an optional 90 V transient suppressor, it is incapable of withstanding the 500 V isolation from earth test, and this must be taken into account during installation.
2. The enclosure may be made of aluminum alloy and given a protective polyurethane paint finish; however, care must be taken to protect it from impact or abrasion if located in Zone 0.

**N1 ATEX Type n**

**Certificate** Baseefa08ATEX0130X  
**Standards** EN IEC 60079-0: 2018, EN60079-15: 2010  
**Markings** Ⓢ II 3 G Ex nA IIC T4 Gc (-40 °C ≤ Ta ≤ +70 °C)

**Special Conditions for Safe Use (X):**

1. If the equipment is fitted with an optional 90 V transient suppressor, it is incapable of withstanding the 500 V electrical strength test as defined in clause 6.5.1 of by EN 60079-15: 2010. This must be taken into account during installation.

**ND ATEX Dust**

**Certificate** Baseefa08ATEX0182X  
**Standards** EN IEC 60079-0: 2018, EN60079-31: 2014  
**Markings** Ⓢ II 1 D Ex ta IIIC T<sub>500</sub> 105 °C Da (-20 °C ≤ Ta ≤ +85 °C)

**Special Conditions for Safe Use (X):**

1. If the equipment is fitted with an optional 90 V transient suppressor, it is incapable of withstanding the 500 V isolation from earth test, and this must be taken into account during installation.
2. Variants with a paint finish must not be installed in a dust-laden airflow.

- Non-standard paint options may cause risk from electrostatic discharge. Avoid installations that could cause electrostatic build-up on painted surfaces and only clean the painted surfaces with a damp cloth. If paint is ordered through a special option code, contact the manufacturer for more information.

**International**

**E7 IECEx Flameproof**

**Certificate** IECExKEM08.0024X  
**Standards** IEC 60079-0: 2017, IEC 60079-1: 2014-06, IEC 60079-26: 2014-10  
**Markings** Ex db IIC T6...T4 Ga/Gb T6 (-60 °C ≤ Ta ≤ +70 °C), T4/T5 (-60 °C ≤ Ta ≤ +80 °C)

**Table 37: Process connection temperature**

Temperature class	Process connection temperature	Ambient temperature
T6	-60 °C to +70 °C	-60 °C to +70 °C
T5	-60 °C to +80 °C	-60 °C to +80 °C
T4	-60 °C to +120 °C	-60 °C to +80 °C

**Special Conditions for Safe Use (X):**

- This device contains a thin wall diaphragm less than 1 mm thick that forms a boundary between EPL Ga (process connection) and EPL Gb (all other parts of the equipment). The model code and datasheet are to be consulted for details of the diaphragm material. During installation, maintenance, and use, the environmental conditions to which the diaphragm will be subjected shall be taken into account. The manufacturer's instructions for installation and maintenance shall be followed in detail to assure safety during its expected lifetime.
- Appropriate cable, glands, and plugs need to be suitable for a temperature of 5 °C greater than maximum specified temperature for location where installed.
- Flameproof joints are not intended to be repaired.
- Non-standard paint options may cause risk from electrostatic discharge. Avoid installations that could cause electrostatic build-up on painted surfaces and only clean the painted surfaces with a damp cloth. If paint is ordered through a special option code, contact the manufacturer for more information.

**Conduit/cable entries**

Unless otherwise marked, the conduit/cable entries in the housing enclosure use a ½-14 NPT form. Only use plugs, adapters, glands, or conduit with a compatible thread form when closing these entries. Entries marked M20 are M20 x 1.5 thread form. On devices with multiple conduit entries, all entries will have the same thread form. When installing in a hazardous location, use only appropriately listed or Ex certified plugs, glands, or adapters in cable/conduit entries.

**I7 IECEx Intrinsic Safety**

**Certificate** IECEx BAS 08.0045X  
**Standards** IEC 60079-0: 2017, IEC 60079-11: 2011  
**Marking:** Ex ia IIC T4 Ga (-60 °C ≤ Ta ≤ +70 °C)

**Table 38: Input parameters**

	HART®	Fieldbus/PROFIBUS®
Voltage $U_i$	30 V	30 V
Current $I_i$	200 mA	300 mA
Power $P_i$	1 W	1.3 W
Capacitance $C_i$	12 nF	0 $\mu$ F
Inductance $L_i$	0 mH	0 mH

**Special Conditions for Safe Use (X):**

1. If the equipment is fitted with an optional 90 V transient suppressor, it is incapable of withstanding the 500 V isolation from earth test, and this must be taken into account during installation.
2. The enclosure may be made of aluminum alloy and given a protective polyurethane paint finish; however, care must be taken to protect it from impact or abrasion if located in Zone 0.
3. The equipment contains thin wall diaphragms. The installation, maintenance, and use shall take into account the environmental conditions to which the diaphragms will be subjected. The manufacturer’s instructions for installation and maintenance shall be followed in detail to assure safety during its expected lifetime.

**IG IECEx FISCO**

**Certificate** IECEx BAS 08.0045X  
**Standards** IEC 60079-0: 2017, IEC60079-11: 2011  
**Markings** Ex ia IIC T4 Ga (-60 °C ≤ Ta ≤ +60 °C)

**Table 39: Input parameters**

	FISCO
Voltage $U_i$	17.5 V
Current $I_i$	380 mA
Power $P_i$	5.32 W
Capacitance $C_i$	0 nF
Inductance $L_i$	0 $\mu$ H

**Special Conditions for Safe Use (X):**

1. If the equipment is fitted with an optional 90 V transient suppressor, it is incapable of withstanding the 500 V isolation from earth test, and this must be taken into account during installation.
2. The enclosure may be made of aluminum alloy and given a protective polyurethane paint finish; however, care must be taken to protect it from impact or abrasion if located in Zone 0.
3. The equipment contains thin wall diaphragms. The installation, maintenance, and use shall take into account the environmental conditions to which the diaphragms will be subjected. The manufacturer’s instructions for installation and maintenance shall be followed in detail to assure safety during its expected lifetime.

**N7 IECEx Type n**

**Certificate** IECEx BAS 08.0046X  
**Standards** IEC 60079-0: 2017, IEC60079-15: 2010  
**Markings** Ex nA IIC T4 Gc (-40 °C ≤ Ta ≤ +70 °C)

**Special Conditions for Safe Use (X):**

1. If fitted with a 90 V transient suppressor, the equipment is not capable of withstanding the 500 V electrical strength test as defined in clause 6.5.1 of IEC60079-15: 2010. This must be taken into account during installation.

**Brazil****E2 Brazil Flameproof**

<b>Certificate</b>	UL-BR 14.0375X (Sorocaba, Sao Pao Paulo, Brazil), UL-BR22.3806X (Shakopee, MN, USA) UL-BR22.3807X (Singapore)
<b>Standards</b>	ABNT NBR IEC 60079-0, ABNT NBR IEC 60079-1, ABNT NBR IEC 60079-26
<b>Markings:</b>	Ex db IIC T6...T4 Ga/Gb IP66, T6 (-60 °C ≤ Ta ≤ +70 °C), T4/T5 (-60 °C ≤ Ta ≤ +80 °C)

**Special Conditions for Safe Use (X):**

1. This device contains a thin wall diaphragm with less than 1 mm thickness that forms a boundary between zone 0 (process connection) and zone 1 (all other parts of the equipment). The model code and datasheet are to be consulted for details of the diaphragm material. Installation, maintenance, and use shall take into account the environmental conditions to which the diaphragm will be subjected. The manufacturer's instructions for installation and maintenance shall be followed in detail to assure safety during its expected lifetime.
2. Flameproof joints are not intended to be repaired.
3. Non-standard paint options may cause risk from electrostatic discharge. Avoid installations that could cause electrostatic build-up on painted surfaces and only clean the painted surfaces with a damp cloth. If paint is ordered through a special option code, contact the manufacturer for more information.

**I2 Brazil Intrinsic Safety**

<b>Certificate</b>	UL-BR 14.0759X
<b>Standards</b>	ABNT NBR IEC 60079-0: 2013; ABNT NBR IEC 60079-11: 2013
<b>Markings</b>	Ex ia IIC T4 Ga (-60 °C ≤ Ta ≤ +70 °C)

**Table 40: Input parameters**

	HART®	Fieldbus/PROFIBUS®
Voltage $U_i$	30 V	30 V
Current $I_i$	200 mA	300 mA
Power $P_i$	1 W	1.3 W
Capacitance $C_i$	12 nF	0
Inductance $L_i$	0	0

**Special Conditions for Safe Use (X):**

1. If the equipment is fitted with an optional 90 V transient suppressor, it is incapable of withstanding the 500 V insulation from earth test, and this must be taken into account during installation.
2. The enclosure may be made of aluminum alloy and given a protective polyurethane finish; however, care should be taken to protect it from impact and abrasion when located in atmospheres that require EPL Ga.

**IB Brazil FISCO**

<b>Certificate</b>	UL-BR 14.0759X
<b>Standards</b>	ABNT NBR IEC 60079-0: 2008 + Errata 1: 2011; ABNT NBR IEC 60079-11: 2009

**Markings** Ex ia IIC T4 Ga (-60 °C ≤ Ta ≤ +60 °C)

**Table 41: Input parameters**

	<b>FISCO</b>
Voltage $U_i$	17.5 V
Current $I_i$	380 mA
Power $P_i$	5.32 W
Capacitance $C_i$	0 nF
Inductance $L_i$	0 μH

**Special Conditions for Safe Use (X):**

1. If the equipment is fitted with an optional 90 V transient suppressor, it is incapable of withstanding the 500 V insulation from earth test, and this must be taken into account during installation.
2. The enclosure may be made of aluminum alloy and given a protective polyurethane finish; however, care should be taken to protect it from impact and abrasion when located in atmospheres that require EPL Ga.

**China**

**China Flameproof**

**Certificate** GYJ23.1236X; GYJ20.1485X [Flow meters]  
**Standards** GB/T 3836.1-2021 ,GB/T 3836.2-2021, GB 3836.20-2010  
**Markings** Pressure transmitter: Ex db IIC T6~T4 Ga/Gb  
 Flow meter: Ex d II C T6~T4 Ga/Gb

**I3 China Intrinsic Safety**

**Certificate** GYJ22.1834X; GYJ20.1487X [Flow meters]  
**Standards** GB3/T 3836.1-2021, GB/T 3836.4-2021, GB3836.20-2010  
**Markings** Ex ia IIC T4 Ga, FISCO :Ex iaIICT4 Ga,Ex db+ib/ibIICT4 Ga/Gb

**Korea**

**EP Korea Flameproof**

**Certificate** 12-KB4BO-0342X, 12-KB4BO-0344X, 19-KB4BO-0978X  
**Markings** Ex d IIC T6...T4 Ga/Gb, T4/T5 (-60 °C ≤ Ta ≤ +80 °C), T6 (-60 °C ≤ Ta ≤ +70 °C)

**Special Conditions for Safe Use (X):**

See certificate for special conditions.

**IP Korea Intrinsic Safety**

**Certificate** 12-KB4BO-0343X, 12-KB4BO-0345X, 13-KB4BO-0205X, 13-KB4BO-0207X, 18-KA4BO-0309X  
**Markings** Ex ia IIC T4 (-60 °C ≤ Ta ≤ +70 °C)

**Special Conditions for Safe Use (X):**

See certificate for special conditions.

## Japan

### E4 Japan Flameproof

**Certificate** CML20JPN112X

**Markings** Ex db IIC T6...T4 Ga/Gb, T6 (-60 °C ≤ Ta ≤ +70 °C), T5/T4 (-60 °C ≤ Ta ≤ +80 °C )

#### Special Conditions for Safe Use (X):

1. This device contains a thin wall diaphragm less than 1 mm thick that forms a boundary between EPL Ga (process connection) and EPL Gb (all other parts of the equipment). The model code and datasheet are to be consulted for details of the diaphragm material. During installation, maintenance, and use, the environmental conditions to which the diaphragm will be subjected shall be taken into account. The manufacturer's instructions for installation and maintenance shall be followed in detail to assure safety during its expected lifetime.
2. Flameproof joints are not intended to be repaired.
3. Non-standard paint options may cause risk from electrostatic discharge. Avoid installations that could cause electrostatic build-up on painted surfaces and only clean the painted surfaces with a damp cloth. If paint is ordered through a special option code, contact the manufacturer for more information.

## Combinations

<b>K1</b>	Combination of E1, I1, N1, and ND
<b>K2</b>	Combination of E2 and I2
<b>K5</b>	Combination of E5 and I5
<b>K6</b>	Combination of E6 and I6
<b>K7</b>	Combination of E7, I7, N7, and IECEx Dust

### IECEX Dust

**Certificate** IECEx BAS 08.0058X

**Standards** IEC60079-0: 2011, IEC60079-31: 2008

**Markings** Ex ta IIIC T95 °C T500 105 °C Da (-20 °C ≤ Ta ≤ +85 °C)

#### Special Conditions for Safe Use (X):

1. If the equipment is fitted with an optional 90 V transient suppressor, it is incapable of withstanding a 500 V isolation from earth test, and this must be taken into account during installation.

<b>KA</b>	Combination of E1, I1, and K6
<b>KB</b>	Combination of K5 and K6
<b>KC</b>	Combination of E1, I1, and K5
<b>KD</b>	Combination of K1, K5, and K6
<b>KP</b>	Combination of EP and IP
<b>KM</b>	Combination of EM and IM

## Rosemount 2051G

Rev 1.10

### European Directive Information

A copy of the EU Declaration of Conformity can be found at the end of the Quick Start Guide. The most recent revision of the EU Declaration of Conformity can be found at [Emerson.com/Rosemount](https://www.emerson.com/Rosemount).

### North America

#### E5 USA Explosionproof (XP) and Dust-Ignitionproof (DIP)

**Certificate** 1015441

**Standards** FM Class 3600 – 2011, FM, Class 3615 – 2006, FM Class 3616 – 2011, FM Class 3810 – 2005

**Markings** XP CL I, DIV 1, GP B, C, D; DIP CL II, DIV 1, GP E, F, G; CL III; T5 (58 °F [-50 °C] ≤ Ta ≤ 185 °F [85 °C]); Factory Sealed; Type 4X

#### I5 USA Intrinsic Safety (IS) and Nonincendive (NI)

**Certificate** 1015441

**Standards** FM Class 3600 – 2011, FM Class 3610 – 2010, FM Class 3611 – 2004, FM Class 3810 – 2005

**Markings** IS CL I, DIV 1, GP A, B, C, D; CL II, DIV 1, GP E, F, G; Class III; DIV 1 when connected per Rosemount drawing 02088-1024; NI CL 1, DIV 2, GP A, B, C, D; T4 (58 °F [-50 °C] ≤ Ta ≤ 158 °F [70 °C]); Type 4x

#### E6 Canada Explosionproof, Division 2, Dust-Ignitionproof

**Certificate** 1015441

**Standards** CAN/CSA C22.2 No. 0-M91 (R2001), CSA Std C22.2 No. 25-1966, CSA Std C22.2 No. 30-M1986, CAN/CSA-C22.2 No. 94-M91, CSA Std C22.2 No. 142-M1987, CAN/CSA-C22.2 No. 157-92, CSA Std C22.2 No. 213-M1987, ANSI-ISA-12.27.01–2003

**Markings** Class I, Division 1, Groups B, C and D; Class II, Groups E, F, and G; Class III; Class I Division 2 Groups A, B, C and D; Type 4X; Factory Sealed; Single Seal

#### I6 Canada Intrinsic Safety

**Certificate** 1015441

**Standards** CAN/CSA C22.2 No. 0-M91 (R2001), CSA Std C22.2 No. 25-1966, CSA Std C22.2 No. 30-M1986, CAN/CSA-C22.2 No. 94-M91, CSA Std C22.2 No. 142-M1987, CAN/CSA-C22.2 No. 157-92, CSA Std C22.2 No. 213-M1987, ANSI-ISA-12.27.01–2003

**Markings** Intrinsically Safe Class I, Division 1 when connected in accordance with Rosemount drawing 02088-1024, Temperature Code T4; Ex ia; Type 4X; Factory Sealed; Single Seal

### Europe

#### E1 ATEX/UKEX Flameproof

**ATEX Certificate** KEMA97ATEX2378X

**UKEX Certificate** DEKRA 21UKEX0289X

**Standards** EN IEC 60079-0:2018, EN 60079-1:2014, EN 60079-26:2015

**Markings** ⓈII 1/2 G Ex db IIC T6..T4 Ga/Gb, T6 (-60 °C ≤ Ta ≤ +70 °C), T5/T4 (-60 °C ≤ Ta ≤ +80 °C)

**Table 42: Process Connection Temperature**

Temperature class	Process connection temperature	Ambient temperature
T6	-60 to +70 °C	-60 to +70 °C
T5	-60 to +80 °C	-60 to +80 °C
T4	-60 to +120 °C	-60 to +80 °C

**Special Conditions for Safe Use (X):**

1. This device contains a thin wall diaphragm less than 1 mm thick that forms a boundary between Category 1G (process connection) and Category 2G (all other parts of the equipment). The model code and datasheet are to be consulted for details of the diaphragm material. During installation, maintenance and use the environmental conditions to which the diaphragm will be subjected shall be taken into account. The manufacturer's instructions for installation and maintenance shall be followed in detail to assure safety during its expected lifetime.
2. Flameproof joints are not intended for repair.
3. Non-standard paint options may cause risk from electrostatic discharge. Avoid installations that could cause electrostatic build-up on painted surfaces, and only clean the painted surfaces with a damp cloth. If paint is ordered through a special option code, contact the manufacturer for more information.
4. Appropriate cable, glands and plugs need to be suitable for a temperature of 5 °C greater than maximum specified temperature for location where installed.

**Conduit/cable entries**

Unless otherwise marked, the conduit/cable entries in the housing enclosure use a ½-14 NPT form. Only use plugs, adapters, glands, or conduit with a compatible thread form when closing these entries. Entries marked M20 are M20 x 1.5 thread form. On devices with multiple conduit entries, all entries will have the same thread form. When installing in a hazardous location, use only appropriately listed or Ex certified plugs, glands, or adapters in cable/conduit entries.

**I1 ATEX Intrinsic Safety**

<b>Certificate</b>	BAS00ATEX1166X
<b>Standards</b>	EN60079-0:2012 + A11:2013, EN60079-11:2012
<b>Markings</b>	⊕ II 1 G Ex ia IIC T4 Ga (-55 °C ≤ Ta ≤ +70 °C)

**Table 43: Input Parameters**

Parameter	HART®
Voltage $U_i$	30 V
Current $I_i$	200 mA
Power $P_i$	0.9 W
Capacitance $C_i$	0.012 μF

**Special Conditions for Safe Use (X):**

1. The apparatus is not capable of withstanding the 500 V insulation test required by EN60079-11. This must be taken into account when installing the apparatus.
2. The enclosure may be made of aluminum alloy and given a protective polyurethane paint finish; however, care must be taken to protect it from impact or abrasion if located in a Zone 0 environment.

**N1 ATEX Type n**

<b>Certificate</b>	BAS00ATEX3167X
<b>Standards</b>	EN60079-0:2012 + A11:2013, EN60079-15:2010

**Markings**                    Ⓢ II 3 G Ex nA IIC T5 Gc (-55 °C ≤ Ta ≤ +70 °C)

**Special Condition for Safe Use (X):**

This apparatus is not capable of withstanding the 500V insulation test required by EN60079-15. This must be taken into account when installing the apparatus.

**ND ATEX Dust**

**Certificate:**                    BAS01ATEX1427X  
**Standards:**                    EN60079-0:2012 + A11:2013, EN60079-31:2009  
**Markings:**                    Ⓢ II 1 D Ex t IIIC T50 °C T<sub>500</sub> 60 °C Da

**Special Conditions for Safe Use (X):**

1. Cable entries must be used which maintain the ingress protection of the enclosure to at least IP66.
2. Unused cable entries must be filled with suitable blanking plugs which maintain the ingress protection of the enclosure to at least IP66.
3. Cable entries and blanking plugs must be suitable for the ambient range of the apparatus and capable of withstanding a 7J impact test.

**International**

**E7 IECEX Flameproof**

**Certificate:**                    IECEX KEM 06.0021X  
**Standards:**                    IEC 60079-0:2017, IEC 60079-1:2014, IEC 60079-26:2014  
**Markings:**                    Ex db IIC T6...T4 Ga/Gb T6(-60 °C ≤ T<sub>a</sub> ≤ +70 °C), T5/T4(-60 °C ≤ T<sub>a</sub> ≤ +80 °C)

**Table 44: Process Connection Temperature**

Temperature class	Process connection temperature	Ambient temperature
T6	-60 to +70 °C	-60 to +70 °C
T5	-60 to +80 °C	-60 to +80 °C
T4	-60 to +120 °C	-60 to +80 °C

**Special Conditions for Safe Use (X):**

1. This device contains a thin wall diaphragm less than 1 mm thick that forms a boundary between EPL Ga (process connection) and EPL Gb (all other parts of the equipment). The model code and datasheet are to be consulted for details of the diaphragm material. During installation, maintenance and use the environmental conditions to which the diaphragm will be subjected shall be taken into account. The manufacturer's instructions for installation and maintenance shall be followed in detail to assure safety during its expected lifetime.
2. Flameproof joints are not intended for repair.
3. Non-standard paint options may cause risk from electrostatic discharge. Avoid installations that could cause electrostatic build-up on painted surfaces, and only clean the painted surfaces with a damp cloth. If paint is ordered through a special option code, contact the manufacturer for more information.
4. Appropriate cable, glands and plugs need to be suitable for a temperature of 5 °C greater than maximum specified temperature for location where installed.

**Conduit/cable entries**

Unless otherwise marked, the conduit/cable entries in the housing enclosure use a ½-14 NPT form. Only use plugs, adapters, glands, or conduit with a compatible thread form when closing these entries. Entries marked M20 are M20 x

1.5 thread form. On devices with multiple conduit entries, all entries will have the same thread form. When installing in a hazardous location, use only appropriately listed or Ex certified plugs, glands, or adapters in cable/conduit entries.

### I7 IECEx Intrinsic Safety

<b>Certificate:</b>	IECEX BAS 12.0071X
<b>Standards:</b>	IEC60079-0:2011, IEC60079-11:2011
<b>Markings:</b>	Ex ia IIC T4 Ga (-55 °C ≤ T <sub>a</sub> ≤ +70 °C)

**Table 45: Input Parameters**

Voltage U <sub>i</sub>	30 V
Current I <sub>i</sub>	200 mA
Power P <sub>i</sub>	0.9 W
Capacitance C <sub>i</sub>	0.012 μF

### Special Conditions for Safe Use (X):

1. When fitted with a transient suppression terminal block, the Rosemount™ 2088 is incapable of passing the 500 V isolation test. This must be taken into account during installation.
2. The enclosure may be made of aluminum alloy and given a protective polyurethane paint finish; however, care must be taken to protect it from impact or abrasion if located in a Zone 0 environment.

### N7 IECEx Type n

<b>Certificate:</b>	IECEX BAS 12.0072X
<b>Standards:</b>	IEC60079-0:2011, IEC60079-15:2010
<b>Markings:</b>	Ex nA IIC T5 Gc (-40 °C ≤ T <sub>a</sub> ≤ +70 °C)

### Special Condition for Safe Use (X):

When fitted with a transient suppression terminal block, the Rosemount 2088 is incapable of passing the 500 V isolation test. This must be taken into account during installation.

### NK IECEx Dust

<b>Certificate:</b>	IECEX BAS12.0073X
<b>Standards:</b>	IEC60079-0:2011, IEC60079-31:2008
<b>Markings:</b>	Ex t IIIC T50 °C ≤ T <sub>500</sub> 60 °C Da

**Table 46: Input Parameters**

	<b>HART®</b>
Voltage U <sub>i</sub>	36 V
Current I <sub>i</sub>	24 mA

### Special Conditions for Safe Use (X):

1. Cable entries must be used which maintain the ingress protection of the enclosure to at least IP66.
2. Unused cable entries must be filled with suitable blanking plugs which maintain the ingress protection of the enclosure to at least IP66.
3. Cable entries and blanking plugs must be suitable for the ambient temperature range of the apparatus and capable of withstanding a 7J impact test.

## Brazil

### E2 Brazil Flameproof

- Certificate:** UL-BR 15.0728X
- Standards:** ABNT NBR IEC 60079-0:2013, ABNT NBR IEC 60079-1:2016, ABNT NBR IEC 60079-26:2016
- Markings:** Ex db IIC T6...T4 Ga/Gb T4/T5(-60 °C ≤ T<sub>a</sub> ≤ +80 °C),  
T6(-60 °C ≤ T<sub>a</sub> ≤ +70 °C)

#### Special Conditions for Safe Use (X):

1. This device contains a thin wall diaphragm less than 1 mm thickness that forms a boundary between zone 0 (process connection) and zone 1 (all other parts of the equipment). The model code and data sheet are to be consulted for details of the diaphragm material. Installation, maintenance and use shall take into account the environmental conditions to which the diaphragm will be subjected. The manufacturer's instructions for installation and maintenance shall be followed in detail to assure safety during its expected lifetime.
2. Flameproof joints are not intended for repair.
3. Non-standard paint options may cause risk from electrostatic discharge. Avoid installations that could cause electrostatic build-up on painted surfaces, and only clean the painted surfaces with a damp cloth. If paint is ordered through a special option code, contact the manufacturer for more information.

### I2 Brazil Intrinsic Safety

- Certificate:** UL-BR 13.0246X
- Standards:** ABNT NBR IEC60079-0:2008 + Errata 1:2011, ABNT NBR IEC60079-11:2009
- Markings:** Ex ia IIC T4 Ga (-55 °C ≤ T<sub>a</sub> ≤ +70 °C)

**Table 47: Input Parameters**

Voltage U <sub>i</sub>	30 V
Current I <sub>i</sub>	200 mA
Power P <sub>i</sub>	0.9 W
Capacitance C <sub>i</sub>	0.012 μF
Inductance L <sub>i</sub>	0 mH

#### Special Conditions for Safe Use (X):

1. When fitted with a transient suppression terminal block, the Rosemount™ 2088 is incapable of passing the 500 V isolation test. This must be taken into account during installation.
2. The enclosure may be made of aluminum alloy and given a protective polyurethane paint finish; however, care must be taken to protect it from impact or abrasion if located in a zone 0 environment (areas that require EPL Ga).

## China

### E3 China Flameproof

- Certificate:** GYJ17.1158X
- Standards:** GB3836.1-2010, GB3836.2-2010, GB3836.20-2010
- Markings:** : Ex d IIC T6~T4 Ga/Gb, T5/T4(-60 °C ≤ T<sub>a</sub> ≤ +80 °C), T6(-60 °C ≤ T<sub>a</sub> ≤ +70 °C)

#### Special Condition for Safe Use (X):

Contact the original manufacturer when repair work relates to the flamepath.

**I3 China Intrinsic Safety**

<b>Certificate:</b>	GYJ17.1157X
<b>Standards:</b>	GB3836.1-2010, GB3836.4-2010, GB3836.20-2010
<b>Markings:</b>	Ex ia IIC T4 Ga (-55 °C ≤ T <sub>a</sub> ≤ +70 °C)

**Special Conditions for Safe Use (X):**

1. The enclosure may contain light metal, attention should be taken to avoid ignition hazard due to impact or friction when used in Zone 0.
2. When transient protection board is chosen (option code T1), this apparatus is not capable of withstanding the 500 V r.m.s insulation test required by clause 6.3.12 of GB3836.4-2010.

**N3 China Type n**

<b>Certificate:</b>	GYJ17.1159X
<b>Standards:</b>	GB3836.1-2010, GB3836.8-2014
<b>Markings:</b>	Ex nA IIC T5 Gc (-40 °C ≤ T <sub>a</sub> ≤ +70 °C)

**Special Condition for Safe Use (X):**

When transient protection board is chosen (option code T1), this apparatus is not capable of withstanding the 500 V r.m.s insulation test required by Clause 6.3.12 of GB3836.4-2010.

### Combinations

<b>K1</b>	Combination of E1, I1 and N1
<b>K2</b>	Combination of E2 and I2
<b>K3</b>	Combination of E3 and I3
<b>K5</b>	Combination of E5 and I5
<b>K6</b>	Combination of E6 and I6
<b>K7</b>	Combination of E7, I7, N7 and NK
<b>KB</b>	Combination of K5 and K6
<b>KD</b>	Combination of E1, I1, K5 and K6
<b>KM</b>	Combination of EM and IM

### Conduit plugs and adapters

#### IECEX Flameproof and Increased Safety

<b>Certificate:</b>	IECEX FMG 13.0032X
<b>Standards:</b>	IEC60079-0:2011, IEC60079-1:2007, IEC60079-7:2006-2007
<b>Markings:</b>	Ex d e IIC Gb

#### ATEX Flameproof and Increased Safety

<b>Certificate:</b>	FM13ATEX0076X
<b>Standards:</b>	EN60079-0:2012, EN60079-1:2007, IEC60079-7:2007
<b>Markings:</b>	Ⓔ II 2 G Ex d e IIC Gb

**Table 48: Conduit Plug Thread Sizes**

Thread	Identification mark
M20 x 1.5	M20
½ – 14 NPT	½ NPT
G½	G½

**Table 49: Thread Adapter Thread Sizes**

Male thread	Identification mark
M20 x 1.5 – 6H	M20
½ – 14 NPT	½ – 14 NPT
¾ – 14 NPT	¾ – 14 NPT
Female thread	Identification mark
M20 x 1.5 – 6H	M20
½ – 14 NPT	½ – 14 NPT
G½	G½

#### Special Conditions for Safe Use (X):

1. When the thread adapter or blanking plug is used with an enclosure in type of protection increased safety “e” the entry thread shall be suitably sealed in order to maintain the ingress protection rating (IP) of the enclosure.

2. The blanking plug shall not be used with an adapter.
3. Blanking plug and threaded adapter shall be either NPT or metric thread forms. G½ thread forms are only acceptable for existing (legacy) equipment installations.

## Rosemount 2051 Wireless

Rev 1.11

### European Directive Information

A copy of the EU Declaration of Conformity can be found at the end of the Quick Start Guide. The most recent revision of the EU Declaration of Conformity can be found at [Emerson.com/Rosemount](https://www.emerson.com/Rosemount).

### Telecommunication compliance

All wireless devices require certification to ensure that they adhere to regulations regarding the use of the RF spectrum. Nearly every country requires this type of product certification. Emerson is working with governmental agencies around the world to supply fully compliant products and remove the risk of violating country directives or laws governing wireless device usage.

### FCC and IC

This device complies with Part 15 of the FCC Rules. Operation is subject to the following conditions: This device may not cause harmful interference. This device must accept any interference received, including interference that may cause undesired operation. This device must be installed to ensure a minimum antenna separation distance of 20 cm from all persons.

### Ordinary Location Certification

As standard, the transmitter has been examined and tested to determine that the design meets the basic electrical, mechanical, and fire protection requirements by a nationally recognized test laboratory (NRTL) as accredited by the Federal Occupational Safety and Health Administration (OSHA).

### Installing in North America

The US National Electrical Code® (NEC) and the Canadian Electrical Code (CEC) permit the use of Division marked equipment in Zones and Zone marked equipment in Divisions. The markings must be suitable for the area classification, gas, and temperature class. This information is clearly defined in the respective codes.

## USA

### I5 USA Intrinsically Safe (IS)

**Certificate:** FM19US0050X

**Standards:** FM Class 3600 – 2018, FM Class 3610 – 2018, FM Class 3810 – 2018, ANSI/ISA 60079-0:2013, ANSI/UL 60079-11:2014, NEMA 250: 2003, ANSI/IEC 60529:2014, ANSI/UL 61010:2016

**Markings:** IS CL I, DIV 1, GP A, B, C, D T4; CL 1, Zone 0 AEx ia IIC T4; T4 (-40 °C ≤ T<sub>a</sub> ≤ +70 °C) when installed per Rosemount drawing 03031-1062; Type 4X/IP66/IP68

### Special Conditions for Safe Use (X):

1. The Rosemount 2051 Wireless Pressure Transmitter shall only be used with the 701PGNKF Rosemount SmartPower™ Battery Pack.

2. The inline pressure sensor may contain more than 10 percent aluminum and is considered a potential risk of ignition by impact or friction. Care must be taken into account during installation and used to prevent impact and friction.
3. The surface resistivity of the transmitter housing is greater than one gigaohm. To avoid electrostatic charge build-up, it must not be rubbed or cleaned with solvents or a dry cloth.

## Canada

### I6 Canada Intrinsically Safe

**Certificate:** CSA 2526009

**Standards:** CAN/CSA C22.2 No. 0-M91, CAN/CSA C22.2 No. 94-M91, CSA Std C22.2 No. 142-M1987, CSA Std C22.2 No. 157-92, CSA Std C22.2 No. 60529:05

**Markings:** Intrinsically Safe for Class I, Division 1, Groups A, B, C, D, T4 when installed per Rosemount drawing 03031-1063; Type 4X/IP66/IP68

## Europe

### I1 ATEX Intrinsic Safety

**Certificate:** Baseefa12ATEX0228X

**Standards:** EN 60079-0:2012, EN 60079-11:2012

**Markings:** Ⓢ II 1 G Ex ia IIC T4 Ga, T4 (-40 °C ≤ T<sub>a</sub> ≤ +70 °C) IP66/IP68

#### Special Conditions for Safe Use (X):

1. The plastic enclosure may constitute a potential electrostatic ignition risk and must not be rubbed or cleaned with a dry cloth.
2. The Rosemount 701PGNKF Power Module may be replaced in a hazardous area. The power module has a surface resistivity greater than 1 GΩ and must be properly installed in the wireless device enclosure. Care must be taken during transportation to and from the point of installation to prevent electrostatic charge build-up.

## International

### I7 IECEx Intrinsic Safety

**Certificate:** IECEx BAS 12.0124X

**Standards:** IEC 60079-0:2011, IEC 60079-11:2011

**Markings:** Ex ia IIC T4 Ga, T4 (-40 °C ≤ T<sub>a</sub> ≤ +70 °C) IP66/IP68

#### Special Conditions for Safe Use (X):

1. The plastic enclosure may constitute a potential electrostatic ignition risk and must not be rubbed or cleaned with a dry cloth.
2. The Rosemount 701PGNKF Power Module may be replaced in a hazardous area. The power module has a surface resistivity greater than 1 GΩ and must be properly installed in the wireless device enclosure. Care must be taken during transportation to and from the point of installation to prevent electrostatic charge build-up.

## Brazil

### I2 Brazil Intrinsic Safety

**Certificate:** UL-BR 13.0534X

**Standards:** ABNT NBR IEC 60079-0: 2013, ABNT NBR IEC 60079-11:2013

**Markings:** Ex ia IIC T4 IP66 Ga, T4 ( $-40\text{ °C} \leq T_a \leq +70\text{ °C}$ )

**Special Condition for Safe Use (X):**

See certificate for special conditions.

## China

### I3 China Intrinsic Safety

**Certificate:** GYJ17.1225X  
GYJ20.1487X [Flow meters]

**Standards:** GB3836.1-2010, GB3836.4-2010, GB3836.20-2010

**Markings:** Ex ia IIC Ga T4,  $-40 \sim +70\text{ °C}$

**Special Condition for Safe Use (X):**

See certificate for special conditions.

## Japan

### I4 Japan Intrinsic Safety

**Certificate:** TC22022X (Rosemount 2051C/L)  
TC22023X (Rosemount 2051T)  
TC22024X (Rosemount 2051CFx)

**Markings:** Ex ia IIC T4 Ga, T4 ( $-20 \sim +60\text{ °C}$ )

**Special Condition for Safe Use (X):**

See certificate for special conditions.

## Korea

### IP Korea Intrinsic Safety

**Certificate:** 13-KB4BO-0220X

**Markings:** Ex ia IIC T4 ( $-40\text{ °C} \leq T_a \leq +70\text{ °C}$ )

**Special Condition for Safe Use (X):**

See certificate for special conditions.

## Additional certifications

### SBS American Bureau of Shipping (ABS) Type Approval

**Certificate:** 15-HS1405241-PDA

**Intended use:** Marine & Offshore Applications – Measurement of either gauge or absolute pressure for liquid, gas and vapor.

**ABS rules:** 2015 Steel Vessels Rules 1-1-4/7.7, 1-1-Appendix 3, 1-1-Appendix 4

**SBV Bureau Veritas (BV) Type Approval**

**Certificate:** 23157 BV

**BV rules:** Bureau Veritas Rules for the Classification of Steel Ships

**Application:** Class notations: AUT-UMS, AUT-CCS, AUT-PORT and AUT-IMS; Pressure transmitter type 2051 cannot be installed on diesel engines.

**SDN Det Norske Veritas (DNV) Type Approval**

**Certificate:** TAA000004F

**Intended use:** DNV GL Rules for Classification - Ships and offshore units

**Application:**

Location classes	
Type	2051
Temperature	B
Humidity	B
Vibration	A
EMC	B
Enclosure	D

# Rosemount 485 Annubar Primary Element



Rosemount 485 Annubar Primary Element utilizes a T-shaped sensor design that offers best in class accuracy and performance.

- Up to 0.75 percent flow rate accuracy
- Lowest permanent pressure loss of any DP flow meter
- Available in 2 to 96-in. (50 to 2400 mm) line sizes

#### Additional information

##### [Specifications](#)

See [Relevant documents](#) for dimensional drawings and installation instructions.

[CONFIGURE >](#)[VIEW PRODUCT >](#)

## Online product configurator

Many products are configurable online using our product configurator.

Select the **Configure** button or visit [Emerson.com/global](https://emerson.com/global) to start. With this tool's built-in logic and continuous validation, you can configure your products more quickly and accurately.

## Specifications and options

The purchaser of the equipment must specify and select the product materials, options, or components.

## Sizing and Selection Body

All Rosemount flow meters can be sized to meet your application specific requirements in the DP Flow sizing and selection tool. This tool will verify if a selected product meets your application requirements, provide a comparison between different primary elements, and generate a detailed accuracy comparison graph.

Once a sizing is completed, the configuration tool will help create a complete and valid model code to match your requirements and include any additional options or approvals.

## Optimizing lead time

The starred offerings (★) represent the most common options and should be selected for the fastest delivery times. The non-starred offerings are subject to additional delivery lead time.

## Required model components

### Model

Code	Description	
485	Rosemount Annubar Primary Element	★

### Fluid type

Code	Description	
L	Liquid	★
G	Gas	★
S	Steam	★

### Line size

Actual units are built to customer supplied pipe ID and wall dimensions. Line size codes in model are used as a nominal size and auto-selected by the sizing program.

Code	Description	
020	2-in. (50 mm)	★
025	2 ½-in. (63.5 mm)	★
030	3-in. (80 mm)	★
035	3 ½-in. (89 mm)	★
040	4-in. (100 mm)	★
050	5-in. (125 mm)	★
060	6-in. (150 mm)	★
070	7-in. (175 mm)	★
080	8-in. (200 mm)	★
100	10-in. (250 mm)	★
120	12-in. (300 mm)	★
140	14-in. (350 mm)	
160	16-in. (400 mm)	
180	18-in. (450 mm)	
200	20-in. (500 mm)	
240	24-in. (600 mm)	
300	30-in. (750 mm)	
360	36-in. (900 mm)	
420	42-in. (1066 mm)	
480	48-in. (1210 mm)	
600	60-in. (1520 mm)	
720	72-in. (1820 mm)	
780	78-in. (1950 mm)	

Code	Description	
840	84-in. (2100 mm)	
900	90-in. (2250 mm)	
960	96-in. (2400 mm)	

### Pipe I.D. range

Code	Description	
Z	Custom manufactured for customer's supplied pipe ID	★

### Pipe material/mounting assembly material

Code	Description	
C	CS (A105)	★
S	316 SST	★
0 <sup>(1)</sup>	No mounting (customer supplied)	★
G	Chrome-moly grade F-11	
N	Chrome-moly grade F-22	
J	Chrome-moly grade F-91	

(1) For customer supplied mounting or isolation valve, provide relevant dimension at time of sizing and order.

### Piping orientation

Code	Description	
H	Horizontal piping	★
D	Vertical piping with downwards flow	★
U	Vertical piping with upwards flow	★

### Rosemount Annubar type

Code	Description	
P	Pak-Lok	★
F	Flanged with opposite side support	★
T <sup>(1)</sup>	Threaded	★
L	Flange-lok	
G	Gear-drive flo-tap	
M	Manual flo-tap	

(1) This option is only available in China.

### Sensor material

Code	Description	
S	316 SST	★

Code	Description	
H	Alloy C-276	

**Sensor size**

Code	Description	
1	Sensor size 1 — Line sizes 2-in. (50 mm) to 8-in. (200 mm)	★
2	Sensor size 2 — Line sizes 6-in. (150 mm) to 96-in. (2400 mm)	★
3	Sensor size 3 — Line sizes greater than 12-in. (300 mm)	★

**Mounting type**

Code	Description	
T1	Compression or Threaded Connection	★
A1	Class 150 RF ASME B16.5	★
A3	Class 300 RF ASME B16.5	★
A6	Class 600 RF ASME B16.5	★
A9 <sup>(1)</sup>	Class 900 RF ASME B16.5	
AF <sup>(1)</sup>	Class 1500 RF ASME B16.5	
AT <sup>(1)</sup>	Class 2500 RF ASME B16.5	
D1	PN16 EN-1092-1 RF	★
D3	PN40 EN-1092-1 RF	★
D6	PN100 EN-1092-1 RF	★
R1	Class 150 RTJ ASME B16.5	
R3	Class 300 RTJ ASME B16.5	
R6	Class 600 RTJ ASME B16.5	
R9 <sup>(1)</sup>	Class 900 RTJ ASME B16.5	
RF <sup>(1)</sup>	Class 1500 RTJ ASME B16.5	
RT <sup>(1)</sup>	Class 2500 RTJ ASME B16.5	

(1) Available in remote mount applications only.

## Opposite side support or packing gland

Code	Description			
0	No opposite side support or packing gland (required for pak-lok, flange-lok, and threaded models)			★
<b>Opposite side support - required for flanged models</b>				
C	NPT threaded opposite support assembly			★
D	Welded opposite support assembly			★
<b>Packing gland - required for flo-tap models</b>				
	Packing gland material	Rod material	Packing material	
J <sup>(1)</sup>	SST packing gland/cage nipple	CS	PTFE	
K <sup>(1)</sup>	SST packing gland/cage nipple	SST	PTFE	
L <sup>(1)</sup>	SST packing gland/cage nipple	CS	Graphite	
N <sup>(1)</sup>	SST packing gland/cage nipple	SST	Graphite	
R	Alloy C-276 packing gland/cage nipple	SST	Graphite	

(1) The cage nipple is constructed of 304 SST.

## Isolation valve for flo-tap models

Code	Description	
0 <sup>(1)</sup>	Not applicable or customer supplied	★
1	Gate valve, CS	
2	Gate valve, SST	
5	Ball valve, CS	
6	Ball valve, SST	

(1) For customer supplied mounting or isolation valve, provide relevant dimension at time of sizing and order.

## Temperature measurement

Code	Description	
T	Integral RTD - not available with flanged model greater than Class 600	★
0	No temperature sensor	★
R	Remote thermowell and RTD	

## Transmitter connection platform

Code	Description	
3	Direct-mount, integral 3-valve manifold- not available with flanged model greater than Class 600	★
5	Direct -mount, 5-valve manifold- not available with flanged model greater than Class 600	★
7	Remote-mount NPT connections (½-in. NPT)	★
6	Direct-mount, high temperature 5-valve manifold- not available with flanged model greater than Class 600	
8	Remote-mount SW connections (½-in.)	
A <sup>(1)</sup>	Remote-mount NPT connections, integral needle valves	★

Code	Description	
B <sup>(1)</sup>	Remote-mount SW connections, integral needle valves	★

(1) This option is only available in China.

## Additional options

### Extended product warranty

Code	Description	
WR3	3-year limited warranty	★
WR5	5-year limited warranty	★

### Pressure testing

Code	Description	
P1	Hydrostatic testing with certificate	
PX	Extended hydrostatic testing	

### Special cleaning

Code	Description	
P2	Cleaning for special processes	

### Material testing

Code	Description	
V1	Dye penetrant exam	

### Material examination

Code	Description	
V2	Radiographic examination	

### Flow calibration

Code	Description	
W1	Flow calibration (average K)	

### Special inspection

Code	Description	
QC1	Visual and dimensional inspection with certificate	★
QC7	Inspection and performance certificate	★

## Surface finish

This surface finish option is auto-selected by the sizing tool as necessary.

Code	Description	
RL	Surface finish for low pipe Reynolds number in gas and steam	★
RH	Surface finish for high pipe Reynolds number in liquid	★

## Material traceability certification

Instrument connections for remote mount options and isolation valves for flo-tap models are not included in the Material Traceability Certification.

Code	Description	
Q8	Material traceability certification per EN 10204:2004 3.1	★

## Positive material identification (PMI)

Code	Description	
Q76	PMI verification and certificate	

## Code conformance

Code	Description	
J2	ANSI/ASME B31.1	
J3	ANSI/ASME B31.3	

## Materials conformance

Materials of construction comply with metallurgical requirements within NACE MR0175/ISO for sour oil field production environments. Environmental limits apply to certain materials. Consult latest standard for details. Selected materials also conform to NACE MR0103 for sour refining environments.

Code	Description	
J5	Certificate of Compliance to NACE MR0175/ISO 15156 for wetted materials	

## Country certification

Code	Description	
J6	European Pressure Directive (PED)	★
J1	Canadian Registration	
J8	Chinese Certificate of Special Equipment Type Test	

## Installed in flanged pipe spool section

Refer to [Rosemount 485](#) specifications section for spool section lengths and schedules

Code	Description	
H3	Class 150 flanged connection with Rosemount standard length and schedule	
H4	Class 300 flanged connection with Rosemount standard length and schedule	

Code	Description	
H5	Class 600 flanged connection with Rosemount standard length and schedule	

**Instrument connections for remote mount option**

Code	Description	
G2	Needle valves, SST	★
G6	OS&Y gate valves, SST	★
G1	Needle valves, CS	
G3	Needle valves, alloy C-276	
G5	OS&Y gate valves, CS	
G7	OS&Y gate valves, alloy C-276	

**Special shipment**

Code	Description	
Y1	Mounting hardware shipped separately	★

**Attach to**

Code	Description	
H1	Attach to transmitter	

**Special dimensions**

Code	Description	
VM	Variable mounting	

# Specifications

## Performance specifications

### Performance statement assumptions

Measured pipe I.D. (or measured pipe cross sectional area)

### Discharge coefficient factor

±0.75 percent of flow rate

### Repeatability

±0.1%

### Line sizes

- Sensor size 1: 2-in. to 8-in. (50 to 200 mm)
- Sensor size 2: 6-in. to 96-in. (150 to 2400 mm)
- Sensor size 3: 12-in. to 96-in. (300 to 2400 mm)

### Note

Some Annubar types are not available in larger line sizes.

**Table 50: Reynolds Number and Probe Width**

Sensor size	Minimum rod Reynolds number ( $R_d$ )	Probe width ( $d$ ) (inches)
1	6500	0.590-in. (14.99 mm)
2	12500	1.060-in. (26.92 mm)
3	25000	1.935-in. (49.15 mm)

$$R_d = \frac{d \times v \times \rho}{\mu}$$

Where

$d$  = Probe width (feet)

$v$  = Velocity of fluid (ft/sec)

$\rho$  = Density of fluid (lbm/ft<sup>3</sup>)

$\mu$  = Viscosity of the fluid (lbm/ft-sec)

## Sizing

Visit Emerson [website](#) or contact an Emerson representative for assistance with sizing and selecting a meter. A Configuration Data Sheet is required prior to order for application verification. To complete the Configuration Data Sheet go to [DP Flow Configuration Assistant](#).

## Flow turndown

10:1 or better

## Rosemount Annubar sensor surface finish

The front surface of the Rosemount Annubar primary is textured for high Reynolds number applications (typically gas and steam). The surface texture creates a more turbulent boundary layer on the front surface of the sensor. The increased turbulence produces a more predictable and repeatable separation of flow at the edge of the sensor. The appropriate surface finish will be determined for each application by the Emerson sizing program,

## Functional specifications

### Service

- Liquid
- Gas
- Steam

### Process temperature limits

#### Direct mount transmitter

- 500 °F (260 °C)
- 750 °F (398 °C) when used with a direct mount, high temperature 5-valve manifold (transmitter connection platform code 6). Maximum temperature limit for steam processes is 650 °F (343 °C).

#### Remote mount transmitter

- -325 to 1250 °F (-198 to 677 °C) – Alloy C-276 sensor material (for superheated steam applications above 1000 °F (538 °C), it is recommended that the Rosemount 585 with alloy 800H sensor material is used.)
- -325 to 850 °F (-198 to 454 °C) – SST sensor material
- 600 °F (315 °C) for Rosemount Annubar threaded type

### Pressure and temperature limits

#### Direct mount transmitter

- Up to Class 600 ANSI (1440 psig at 100 °F [99 bar at 38 °C])
- Integral temperature measurement is not available with flanged mounting type greater than Class 600

#### Remote mount transmitter

---

### Note

Static pressure selection may effect pressure limitations.

---

Up to Class 2500 ANSI (6000 psig at 100 °F [416 bar at 38 °C])

## Physical specifications

### Temperature measurement

#### Integral RTD

- 100 Ohm platinum RTD
- 4-wire RTD ( $\alpha = 0.00385$ )

#### Remote RTD

100 Ohm platinum RTD, spring loaded with ½ NPT nipple and union

#### Remote RTD Thermowell

½ × ½ NPT, 316 SST or Alloy C-276 (same as specified Rosemount Annubar Sensor material) with ½-in. weld couplet (same as specified mounting assembly material, if applicable).

#### Rosemount Annubar Sensor material

- 316 SST
- Alloy C-276

#### Mounting material

- CS (A105)
- 316 SST
- Chrome-moly Grade F-11
- Chrome-moly Grade F-22
- Chrome-moly Grade F-91

### Rosemount Annubar type

See [Rosemount 485 Annubar Primary Element](#).

#### Pak-Lok model (option P)

- Provided with a compression sealing mechanism rated up to Class 600 ANSI (1440 psig at 100 °F [99 bar at 38 °C])

<b>Gas/Liquid Temperature limits by sensor material:</b>	SST: (-325 to 850 °F [-198 to 454 °C]) Alloy C-276: (-325 to 1250 °F [-198 to 677 °C])
--	---

<b>Steam Temperature limits by sensor material:</b>	SST: (-325 to 600 °F [-198 to 315 °C]) Alloy C-276: (-325 to 600 °F [-198 to 315 °C])
---	--

- Not available for steam above 600 °F (315 °C)

#### Threaded model (option T)

##### Note

This Annubar type is only available in China.

- Provided with a compression sealing mechanism rated up to Class 600 ANSI (1440 psig at 100 °F [99 bar at 38 °C])
- Temperature limits: -20 to 600 °F (-28 to 315 °C)

#### Flanged with opposite side support model (option F)

- Provided with opposite side support, which is the same material as the pipe and requires a second pipe penetration.

- Sensor flange is the same material as the Rosemount Annubar sensor and the mounting flange is the same material as the pipe material.
- Flanged mounting hardware: nuts, studs and gaskets (DIN units supplied without nuts, studs and gaskets). Standard bolting provided is CS (A193 B7/A194 2H). Standard gaskets provided are spiral wound 304SST flexible graphite filled.

**Gas/Liquid Temperature limits by sensor material:** SST: (-40 to 850 °F [-40 to 454 °C])  
 Alloy C-276: (-40 to 1250 °F [-40 to 677 °C])

**Steam Temperature limits by sensor material:** SST: (-40 to 850 °F [-40 to 454 °C])  
 Alloy C-276: (-40 to 1000 °F [-40 to 538 °C])

**Flange-Lok model (option L)**

- Flange-Lok mounting hardware: nuts, studs and gaskets (DIN units supplied without nuts, studs and gaskets). Standard bolting provided is CS (A193 B7/A194 2H). Standard gaskets provided are spiral wound 304SST flexible graphite filled.

**Gas/Liquid Temperature limits by sensor material:** SST: (-40 to 850 °F [-40 to 454 °C])  
 Alloy C-276: (-40 to 1250 °F [-40 to 677 °C])

**Steam Temperature limits by sensor material:** SST: (-40 to 600 °F [-40 to 315 °C])  
 Alloy C-276: (-40 to 600 °F [-40 to 315 °C])

- Not available for steam above 600 °F (315 °C)

**Flo-Tap models (options G and M)**

- The cage nipple is constructed of 304 SST.
- Opposite side support is not available
- Threaded connection is not available with sensor size 3
- Gear drive is not available with sensor size 1
- Packing gland required
- Packing gland material temperature limits
  - PTFE: -20 to 400 °F (-29 to 204 °C)
  - Graphite: -20 to 850 °F (-29 to 454 °C)
- Isolation valve included
  - The isolation valve will carry the same pressure rating as the sensor flange and mounting flange specified in the mounting type
  - Isolation vales are not supplied with DIN flanges and must be customer supplied
- For threaded Flo-Tap models, the isolation valve NPT size is 1¼-in. (sensor size 1) and 2-in. (sensor size 2).

**Table 51: Rosemount Annubar Type Specification Chart**

Option code	Description	Pak-Lok <sup>(1)</sup>	Threaded	Flange-Lok	Flange	Manual and gear drive Flo-Tap
T1 <sup>(1)</sup>	Pak-Lok body	X				
	Threaded body <sup>(2)</sup>		X			
	Threaded connection					X
A1	Class 150 RF ASME B16.5			X	X	X
A3	Class 300 RF ASME B16.5			X	X	X
A6	Class 600 RF ASME B16.5			X	X	X

**Table 51: Rosemount Annubar Type Specification Chart (continued)**

Option code	Description	Pak-Lok <sup>(1)</sup>	Threaded	Flange-Lok	Flange	Manual and gear drive Flo-Tap
A9 <sup>(2)</sup>	Class 900 RF ASME B16.5				X	
AF <sup>(2)</sup>	Class 1500 RF ASME B16.5				X	
AT <sup>(2)</sup>	Class 2500 RF ASME B16.5				X	
D1	PN16 EN-1092-1 RF			X	X	X
D3	PN40 EN-1092-1 RF			X	X	X
D6	PN100 EN-1092-1 RF			X	X	X
R1	Class 150 RTJ ASME B16.5			X	X	X
R3	Class 300 RTJ ASME B16.5			X	X	X
R6	Class 600 RTJ ASME B16.5			X	X	X
R9 <sup>(2)</sup>	Class 900 RTJ ASME B16.5				X	
RF <sup>(2)</sup>	Class 1500 RTJ ASME B16.5				X	
RT <sup>(2)</sup>	Class 2500 RTJ ASME B16.5				X	

(1) Available up to ANSI Class 600 (1440 psig at 100 °F [99 bar at 38 °C]) rating.

(2) Remote mount only.

**RTD temperature limits**

**Integral** -40 to 900 °F (-40 to 485 °C)

**Remote** -76 to 1112 °F (-60 to 600 °C)

**Instrument connections and electronics connection platform temperature ranges**

**Table 52: Minimum/Maximum Temperature Range**

Code	Description	Temperature
G1	Needle valves, CS	-20 to 775 °F (-29 to 412 °C)
G2	Needle valves, SST	-40 to 850 °F (-40 to 454 °C)
G3	Needle valves, alloy C-276	
G5	OS&Y gate valves, CS	-20 to 775 °F (-29 to 413 °C)
G6	OS&Y gate valves, SST	-40 to 850 °F (-40 to 454 °C)
G7	OS&Y gate valves, alloy C-276	-40 to 1250 °F (-40 to 677 °C)
A	Integral needle valves, SST, remote-mount NPT connections	-20 to 450 °F (-29 to 232 °C)
B	Integral needle valves, SST, remote-mount SW connections	

**Flow meter installed in flanged pipe spool section (option codes H3, H4, and H5)**

- All pipe spool sections are flanged pipe sections.
- The flanged pipe spool section is constructed from the same material as the pipe material/mounting assembly material. Available in Carbon Steel (A105) and 316 Stainless Steel.
- Consult the factory for remote temperature measurement and ANSI ratings above Class 600 and DIN flanges.

**Table 53: Flanged Pipe Spool Section Schedule**

ASME B16.5	Schedule
Class 150	40

**Table 53: Flanged Pipe Spool Section Schedule (continued)**

ASME B16.5	Schedule
Class 300	
Class 600	80

**Table 54: Flange Pipe Spool Section Length**

Nominal pipe size	Length
2-in. (50 mm)	10.5-in. (267 mm)
2½-in. (63.5 mm)	11.0-in. (279 mm)
3-in. (80 mm)	11.4-in. (289 mm)
4-in. (100 mm)	12.7-in. (323 mm)
6-in. (150 mm)	14.3-in. (364 mm)
8-in. (200 mm)	16.6-in. (421 mm)

# Rosemount 486 Annubar Primary Element Mounting Hardware

## Online product configurator

Many products are configurable online using our product configurator.

Select the **Configure** button or visit [Emerson.com/global](https://emerson.com/global) to start. With this tool's built-in logic and continuous validation, you can configure your products more quickly and accurately.

## Specifications and options

The purchaser of the equipment must specify and select the product materials, options, or components.

## Sizing and Selection Body

All Rosemount flow meters can be sized to meet your application specific requirements in the DP Flow sizing and selection tool. This tool will verify if a selected product meets your application requirements, provide a comparison between different primary elements, and generate a detailed accuracy comparison graph.

Once a sizing is completed, the configuration tool will help create a complete and valid model code to match your requirements and include any additional options or approvals.

## Optimizing lead time

The starred offerings (★) represent the most common options and should be selected for the fastest delivery times. The non-starred offerings are subject to additional delivery lead time.

## Required model components

### Model

Code	Description	
486	Rosemount Annubar Primary Element Mounting Hardware	★

### Line size

Actual units are built to customer supplied pipe ID and wall dimensions. Line size codes in model are used as a nominal size and auto-selected by the sizing program.

Code	Description	
020	2-in. (50 mm)	★
025	2 ½-in. (63.5 mm)	★
030	3-in. (80 mm)	★

Code	Description	
035	3 ½-in. (89 mm)	★
040	4-in. (100 mm)	★
050	5-in. (125 mm)	★
060	6-in. (150 mm)	★
070	7-in. (175 mm)	★
080	8-in. (200 mm)	★
100	10-in. (250 mm)	★
120	12-in. (300 mm)	★
140	14-in. (350 mm)	
160	16-in. (400 mm)	
180	18-in. (450 mm)	
200	20-in. (500 mm)	
240	24-in. (600 mm)	
300	30-in. (750 mm)	
360	36-in. (900 mm)	
420	42-in. (1066 mm)	
480	48-in. (1210 mm)	
600	60-in. (1520 mm)	
720	72-in. (1820 mm)	
780	78-in. (1950 mm)	
840	84-in. (2100 mm)	
900	90-in. (2250 mm)	
960	96-in. (2400 mm)	

**Pipe material/mounting assembly material**

Code	Description	
C	Carbon Steel (A105)	★
S	316 stainless steel	★
G	Chrome-Moly Grade F-11	
N	Chrome-Moly Grade F-22	
J	Chrome-Moly Grade F-91	
0	No mounting (customer-supplied)	★

**Rosemount Annubar type**

Code	Description	
P	Pak-Lok	★
F	Flanged with opposite side support	★
L	Flange-Lok	

Code	Description	
G	Gear-drive Flo-Tap	
M	Manual Flo-Tap	

### Sensor material

Code	Description	
S	316 stainless steel	★
H	Alloy C-276	

### Sensor size

Code	Description	
1	Sensor size 1 — Line sizes 2-in. (50 mm) to 8-in. (200 mm)	★
2	Sensor size 2 — Line sizes 6-in. (150 mm) to 96-in. (2400 mm)	★
3	Sensor size 3 — Line sizes greater than 12-in. (300 mm)	★

### Mounting type

Code	Description	
T1	Compression/Threaded Connection	★
A1	Class 150 RF ASME B16.5	★
A3	Class 300 RF ASME B16.5	★
A6	Class 600 RF ASME B16.5	★
A9	Class 900 RF ASME B16.5	
AF	Class 1500 RF ASME B16.5	
AT	Class 2500 RF ASME B16.5	
D1	PN16 EN-1092-1 RF	★
D3	PN40 EN-1092-1 RF	★
D6	PN100 EN-1092-1 RF	★
R1	Class 150 RTJ ASME B16.5	
R3	Class 300 RTJ ASME B16.5	
R6	Class 600 RTJ ASME B16.5	
R9	Class 900 RTJ ASME B16.5	
RF	Class 1500 RTJ ASME B16.5	
RT	Class 2500 RTJ ASME B16.5	

### Opposite side support or packing gland

Code	Description	
0	No opposite side support or packing gland (required for pak-lok, flange-lok, and threaded models)	★

Code	Description	
<b>Opposite side support - required for flanged models</b>		
C	NPT threaded opposite support assembly	★
D	Welded opposite support assembly	★

### Isolation valve for flo-tap models

Code	Description	
0 <sup>(1)</sup>	Not applicable or customer supplied	★
1	Gate valve, CS	
2	Gate valve, SST	
5	Ball valve, CS	
6	Ball valve, SST	

(1) For customer supplied mounting or isolation valve, provide relevant dimension at time of sizing and order.

### Temperature measurement

Code	Description	
T	Integral RTD - not available with flanged model greater than Class 600	★
0	No temperature sensor	★
R	Remote thermowell and RTD	

## Additional options

### Special cleaning

Code	Description	
P2	Cleaning for special processes	

### Material testing

Code	Description	
V1	Dye penetrant exam	

### Material examination

Code	Description	
V2	Radiographic examination	

### Special inspection

Code	Description	
QC1	Visual and dimensional inspection with certificate	★

Code	Description	
QC7	Inspection and performance certificate	★

### Material traceability certification

Instrument connections for remote mount options and isolation valves for flo-tap models are not included in the Material Traceability Certification.

Code	Description	
Q8	Material traceability certification per EN 10204:2004 3.1	★

### Positive material identification (PMI)

Code	Description	
Q76	PMI verification and certificate	★

### Code conformance

Code	Description	
J1	Canadian Registration	★
J6	European Pressure Directive (PED)	★
J2	ANSI/ASME B31.1	
J3	ANSI/ASME B31.3	
J5 <sup>(1)</sup>	Certificate of Compliance to NACE MR0175/ISO 15156 for wetted materials	

(1) *Materials of construction comply with metallurgical requirements within NACE MR0175/ISO for sour oil field production environments. Environmental limits apply to certain materials. Consult latest standard for details. Selected materials also conform to NACE MR0103 for sour refining environments.*

### Special shipment

Include Y1 option on Rosemount 485 model also.

Code	Description	
Y1	Mounting hardware shipped separately	★

# Rosemount 585 Annubar Primary Element



Rosemount 585 Annubar Primary Element utilizes a solid sensor construction that offers capabilities for severe service applications.

- Main steam line mounting hardware available
- Symmetrical sensor design allows bi-directional flow measurement
- Available in 4- to 96-in. (50 to 2400 mm) line sizes

#### Additional information

##### [Specifications](#)

See [Relevant documents](#) for dimensional drawings and installation instructions.

[CONFIGURE >](#)[VIEW PRODUCT >](#)

## Online product configurator

Many products are configurable online using our product configurator.

Select the **Configure** button or visit [Emerson.com/global](https://emerson.com/global) to start. With this tool's built-in logic and continuous validation, you can configure your products more quickly and accurately.

## Specifications and options

The purchaser of the equipment must specify and select the product materials, options, or components.

## Sizing and Selection Body

All Rosemount flow meters can be sized to meet your application specific requirements in the DP Flow sizing and selection tool. This tool will verify if a selected product meets your application requirements, provide a comparison between different primary elements, and generate a detailed accuracy comparison graph.

Once a sizing is completed, the configuration tool will help create a complete and valid model code to match your requirements and include any additional options or approvals.

## Optimizing lead time

The starred offerings (★) represent the most common options and should be selected for the fastest delivery times. The non-starred offerings are subject to additional delivery lead time.

## Required model components

### Model

Code	Description	
585	Severe service Rosemount Annubar Primary Element	

### Application type

Code	Description	
S <sup>(1)(2)</sup>	Severe service Rosemount Annubar	★
M <sup>(3)</sup>	Main steam line Rosemount Annubar	

(1) Required for Rosemount Annubar type F.

(2) Required for Rosemount Annubar type G.

(3) Required for Rosemount Annubar type L.

### Fluid type

Code	Description	
L	Liquid	★
G	Gas	★
S	Steam	★

### Annubar type

Code	Description	
F	Flanged with opposite side support	★
L	Main steam Rosemount Annubar with opposite side support	
G	Gear-drive flo-tap	

### Line size

Actual units are built to customer supplied pipe ID and wall dimensions. Line size codes in model are used as a nominal size and auto-selected by the sizing program.

Code	Description	
040	4-in. (100 mm)	★
050	5-in. (125 mm)	★
060	6-in. (150 mm)	★
080	8-in. (200 mm)	★
100	10-in. (250 mm)	★
120	12-in. (300 mm)	★
140	14-in. (350 mm)	
160	16-in. (400 mm)	

Code	Description	
180	18-in. (450 mm)	
200	20-in. (500 mm)	
240	24-in. (600 mm)	
300	30-in. (750 mm)	
360	36-in. (900 mm)	
420	42-in. (1066 mm)	
480	48-in. (1210 mm)	
600	60-in. (1520 mm)	
720	72-in. (1820 mm)	
780	78-in. (1950 mm)	
840	84-in. (2100 mm)	
900	90-in. (2250 mm)	
960	96-in. (2400 mm)	

### Mounting assembly material

Code	Description	
C	CS (A105)	★
S	316 SST	★
L	CS (A350 LF2)	
G	Chrome-moly grade F-11	
N	Chrome-moly grade F-22	
J	Chrome-moly grade F-91	
0 <sup>(1)</sup>	No mounting (customer-supplied)	★

(1) For customer supplied mounting or isolation valve, provide relevant dimension at time of sizing and order.

### Piping orientation

Code	Description	
H	Horizontal piping	★
D	Vertical piping with downwards flow	★
U	Vertical piping with upwards flow	★

### Sensor material

Code	Description	
S	316 SST	★
H	Alloy C-276	
W <sup>(1)(2)</sup>	Alloy 800H	

Code	Description	
K <sup>(3)</sup>	PVDF	

- (1) Not available with Rosemount Annubar type G.  
 (2) Required for Rosemount Annubar type L.  
 (3) This option is only available with Annubar Type F.

### Sensor size

Code	Description	
11	Sensor size 11	★
22 <sup>(1)</sup>	Sensor size 22	★
44 <sup>(2)(3)</sup>	Sensor size 44	

- (1) Not available with sensor material K.  
 (2) Required for Rosemount Annubar type G.  
 (3) Required for Rosemount Annubar type L.

### Mounting type

Code	Description	
A	ASME B16.5 raised face flanges	★
D <sup>(1)</sup>	EN-1092-1 raised face flanges	★
R <sup>(2)</sup>	ASME B16.5 ring type joint flanges	
0 <sup>(3)</sup>	Main steam packing gland	

- (1) Mounting flange bolting and gasket option code 0 must be selected  
 (2) Mounting flange gasket material option code 2 or 0 must be selected  
 (3) Required for Rosemount Annubar type L.

### Mounting pressure class

Code	Description	
1	Class 150/PN 16	★
3 <sup>(1)</sup>	Class 300/PN 40	★
6 <sup>(1)</sup>	Class 600/PN 100	★
N <sup>(1)(2)</sup>	Class 900	
F <sup>(1)(2)</sup>	Class 1500	
T <sup>(1)(2)</sup>	Class 2500	
0 <sup>(1)(2)(3)</sup>	Main steam packing gland	

- (1) Not available with sensor material K.  
 (2) Not available with Rosemount Annubar type G.  
 (3) Required for Rosemount Annubar type L.

### Opposite side support

Code	Description	
C <sup>(1)</sup>	NPT threaded opposite support assembly	★

Code	Description	
D <sup>(2)</sup>	Welded opposite support assembly	★
E	Flanged opposite support assembly	
0 <sup>(3)</sup>	No opposite side support required	★

- (1) Not available with ASME 2500 mounting pressure class.
- (2) Required for Rosemount Annubar type L.
- (3) Required for Rosemount Annubar type G.

### Packing gland/packing

Code	Description	
0 <sup>(1)</sup>	Not applicable	★
L <sup>(2)(3)</sup>	SS packing gland/graphite packing	★
T <sup>(4)</sup>	Main steam packing gland/graphite packing	

- (1) Required for Rosemount Annubar type F.
- (2) Required for Rosemount Annubar type G.
- (3) The cage nipple is constructed of 304SST.
- (4) Required for Rosemount Annubar type L.

### Insertion mechanism

Code	Description	
0 <sup>(1)</sup>	Not applicable	★
C	Alloy steel insertion rods/nuts	
S	SST insertion rods/nuts	★

- (1) Required for Rosemount Annubar type F and Type L.

### Isolation valve

Customer must supply isolation valve if EN-1092-1 mounting is selected.

Code	Description	
0 <sup>(1)(2)</sup>	Not applicable or customer supplied	★
1	Gate valve, CS	
2	Gate valve, SST	
5	Ball valve, CS	
6	Ball valve, SST	

- (1) Required for Rosemount Annubar type F and type L.
- (2) For customer supplied mounting or isolation valve, provide relevant dimension at time of sizing and order.

### Temperature measurement

Code	Description	
0	No temperature sensor required	★
R <sup>(1)(2)(3)</sup>	Remote RTD (½ NPT aluminum housing) with thermowell	

Code	Description	
S <sup>(1)(2)(3)</sup>	Remote RTD (½ NPT SST housing) with thermowell	★

- (1) *Not available with Rosemount Annubar type L.*  
(2) *Not available with sensor material K.*  
(3) *Not available with ASME 2500 mounting pressure class.*

### Transmitter connection platform

Code	Description	
3 <sup>(1)(2)</sup>	Direct-mount, 3-valve manifold	★
4 <sup>(1)(2)</sup>	Direct-mount, dual 3-valve manifolds	
6 <sup>(1)(2)(3)</sup>	High temperature direct-mount 5-valve manifold	
7	Remote-mount ½-in. NPT threaded connections	
8 <sup>(4)</sup>	Remote-mount ½-in. welded connections	★

- (1) *Only available with sensor material S or H.*  
(2) *Not available with mounting pressure Class N, T, or F.*  
(3) *Only available with sensor material S.*  
(4) *Required for Rosemount Annubar type L.*

### Mounting flange bolting materials

Code	Description	
A	ASTM A193 Gr B7 studs with A194 Gr 2H nuts	★
0	No flange studs/nuts supplied	★

### Mounting flange gasket materials

Code	Description	
1	Spiral wound, ASME B16.20, 304SS, flexible-graphite filler	★
0	No flange gasket supplied	★
2	Ring-joint, ASME B16.20, hexagonal, 316L	
3	Spiral wound, ASME B16.20, 316SS, PTFE filler	

## Additional options

### Extended product warranty

Code	Description	
WR3	3-year limited warranty	★
WR5	5-year limited warranty	★

### Optional mounting for rectangular ducts

Code	Description	
RD	Annubar mounting for rectangular ducts	

### Pressure testing

Code	Description	
P1	Hydrostatic testing with certificate	
PX	Extended hydrostatic testing	

### Special cleaning

This option is not available with sensor material K.

If selected with Rosemount Annubar type F, mounting flange gasket material option code 3 must be selected.

Code	Description	
PA	Cleaning for special processes	

### Material testing

Code	Description	
V1	Dye penetrant exam	

### Material examination

Code	Description	
V2	Radiographic examination	

### Flow calibration

Code	Description	
W1	Flow calibration (average K)	

### Special inspection

Code	Description	
QC1	Visual and dimensional inspection with certificate	★
QC7	Inspection and performance certificate	★

### Material traceability certification

Instrument connections for remote mount options and isolation valves for flo-tap models are not included in the Material Traceability Certification.

Code	Description	
Q8	Material traceability certification per EN 10204:2004 3.1	★

### Positive material identification (PMI)

For pressure retaining parts only, isolation and instrument valves are not included.

Code	Description	
V4	PMI Verification and Certification	

### Code conformance

Code	Description	
J2	ANSI/ASME B31.1	
J3	ANSI/ASME B31.3	

### Materials conformance

Materials of construction comply with metallurgical requirements within NACE MR0175/ISO for sour oil field production environments. Environmental limits apply to certain materials. Consult latest standard for details. Selected materials also conform to NACE MR0103 for sour refining environments.

Code	Description	
J5	Certificate of Compliance to NACE MR0175/ISO 15156 for wetted materials	

### Country certification

Code	Description	
J6	European Pressure Directive (PED)	★
J1	Canadian Registration	

### Instrument valve option

Only available if instrument valves for remote mount option are selected.

Code	Description	
DV	Double instrument valves (four valves total)	★

### Instrument connections for remote mount option

Code	Description	
G2	Needle valves, SST	★
G6	OS&Y gate valves, SST	★
G1	Needle valves, CS	
G3	Needle valves, alloy C-276	
G5	OS&Y gate valves, CS	

### Special shipment

Requires 586 model to be ordered. Include Y1 option on 586 model also.

Code	Description	
Y1	Mounting hardware shipped separately	★

### Assemble mounting hardware

This option is only available with Rosemount Annubar type L.

Code	Description	
WP	Factory-welded main steam packing gland	★

### Special dimensions

Code	Description	
VM	Non-standard mounting dimensions	

### Packing gland plug

This option is only available with Rosemount Annubar type L.

Code	Description	
TP	Packing gland plug for steam blow down	

### Installation alignment bar

This option is only available with Rosemount Annubar type L.

Code	Description	
A1	Installation alignment bar	

# Specifications

## Performance specifications

### Performance statement assumptions

Includes K-factor (flow coefficient) uncertainty only

### Flow coefficient (K-factor) uncertainty

±1.50% (95% confidence)

### Repeatability

±0.10%

### Line sizes

- Sensor size 11: 4-in. to 20-in. (100 to 600 mm)
- Sensor size 22: 6-in. to 36-in. (150 to 900 mm)
- Sensor size 44: 10-in. to 96-in. (250 to 2400 mm)

**Table 55: Reynolds Number and Probe Width**

Sensor size	Minimum rod Reynolds number ( $R_d$ )	Probe width ( $d$ ) (inches)
11	6500	0.80-in. (20,3 mm)
22	10000	1.20-in. (30,5 mm)
44	25000	2.28-in. (57,9 mm)

$$R_d = \frac{d \times v \times \rho}{\mu}$$

Where

$d$  = Probe width (feet)

$\mu$  = Viscosity of the fluid (lbm/ft-sec)

$v$  = Velocity of fluid (ft/sec)

$\rho$  = Density of fluid (lbm/ft<sup>3</sup>)

### Sizing

Visit Emerson [website](#) or contact an Emerson representative for assistance with sizing and selecting a meter. A Configuration Data Sheet is required prior to order for application verification. To complete the Configuration Data Sheet go to [DP Flow Configuration Assistant](#).

### Flow turndown

10:1 or better

## Functional specifications

### Service

- Liquid

- Gas
- Steam

### Process temperature limits

**Table 56: Direct Mount Transmitter Connection Platform**

Transmitter connection platform	Temperature limit
3-valve manifold (option codes 3, 4)	-40 to 500 °F (-40 to 260 °C)
5-valve manifold (option code 6) <sup>(1)</sup>	-40 to 750 °F (-40 to 398 °C)

(1) Specification is 650 °F (343 °C) in steam service.

**Table 57: Remote Mount Transmitter Connection Platform (Option Codes 7, 8)**

Sensor material	Temperature limit
316 SST (option code S)	850 °F (454 °C)
Alloy C-276 (option code H)	1250 °F (677 °C)
Alloy 800H (option code W)	1500 °F (816 °C)
PVDF (option code K)	250 °F (121 °C)

### Pressure and temperature limits

**Table 58: Main Steam Line Rosemount Annubar (Option Code L)**

Mounting material	Sensor material	Max. pressure at temp.	Max. temp.
Chrome-moly grade F-11	Alloy 800H	2317 psig at 1000 °F (160 bar at 538 °C)	1100 °F (593 °C)
Chrome-moly grade F-22		2868 psig at 1000 °F (198 bar at 538 °C)	
Chrome-moly grade F-91		3788 psig at 1100 °F (261 bar at 593 °C)	1200 °F (649 °C)

**Table 59: Severe Service Rosemount Annubar**

Rosemount Annubar type	Sensor material	Max. flange rating
Flanged (option code F)	316 SST	Class 2500
	Alloy C-276	
	Alloy 800H	
	PVDF	Class 150
Flanged flo-tap (option code G)	316 SST	Class 600
	Alloy C-276	

## Physical specifications

### Temperature measurement

#### Remote RTD

- Pt-100, single element, class B accuracy. Includes aluminum or 316SS terminal housing with ½-in. NPT conduit entry.
- Spring loaded with ½ NPT nipple and union thermowell
- ¾-in. socketweld thermowell (4-in. insertion length)
- 316 SST and alloy C-276 thermowell material
- ¾-in. CL 3000 socketweld branch fitting (fitting material matches selected mounting material)
- RTD temperature limit: -76 to 1112 °F (-60 to 600 °C)

#### Rosemount Annubar Sensor material

- 316 SST
- Alloy C-276
- Alloy 800H
- PVDF

#### Mounting material

- CS (A105)
- 316 SST
- CS (A350 LF2)
- Chrome-moly Grade F-11
- Chrome-moly Grade F-22
- Chrome-moly Grade F-91

#### Rosemount Annubar type

See "[Rosemount 585 Annubar Primary Element](#)".

#### Flanged with opposite side support model (option F)

- Provided with opposite side support which requires two pipe penetrations
- Sensor flange is the same material as the Rosemount Annubar sensor
- Mounting materials compatible with common piping materials
- Optional flanged mounting hardware: nuts, studs and gaskets (EN-1092-1 flanged units supplied without nuts, studs, and gaskets)

#### Temperature limits by sensor material:

- SST: -325 to 850 °F (-198 to 454 °C)
- Alloy C-276: -325 to 1250 °F (-198 to 677 °C)
- PVDF: -40 to 250 °F (-40 to 121 °C)
- Alloy 800H: -40 to 1500 °F (-40 to 816 °C)

#### Main steam annubar with opposite side support (option L)

- Provided with opposite side support, which requires two pipe penetrations

**Temperature limits by sensor material:**

- Alloy 800H: -40 to 1200 °F (-40 to 816 °C)
- Only available in sensor size 44

**Flanged flo-tap models (option G)**

- Opposite side support is not available
- The cage nipple is constructed of 304SST.
- Packing gland material temperature limits
  - Graphite: -40 to 850 °F (-40 to 454 °C)
- Isolation valve option
  - The isolation valve will carry the same pressure rating as the sensor flange and mounting flange specified in the mounting type.
  - Isolation valves have a -20 °F (-29 °C) lower temperature limit.
  - Upper temperature limit is 400 °F (204 °C) for ball valves, 800 °F (427 °C) for CS gate valve, and 850 °F (454 °C) for SS gate valve.

**Temperature limits by sensor material**

- 316 SST and Alloy C-276: -40 to 850 °F (-40 to 454 °C)
- Limited to Class 600/PN 100
- Only available in sensor size 44

**Table 60: Severe Service Rosemount Annubar**

Option code	Mounting type/pressure class	Flanged	Main steam	Gear-drive flo-tap
A1	Class 150 RF	X		X
A3	Class 300 RF	X		X
A6	Class 600 RF	X		X
AN <sup>(1)</sup>	Class 900 RF	X		
AF <sup>(1)</sup>	Class 1500 RF	X		
AT <sup>(1)</sup>	Class 2500 RF	X		
D1	PN 16 RF	X		X
D3	PN 40 RF	X		X
D6	PN 100 RF	X		X
R3	Class 300 RTJ	X		X
R6	Class 600 RTJ	X		X
RN <sup>(1)</sup>	Class 900 RTJ	X		
RF <sup>(1)</sup>	Class 1500 RTJ	X		
RT <sup>(1)</sup>	Class 2500 RTJ	X		
00 <sup>(1)</sup>	Main steam packing gland		X	

(1) Remote mount instrument connection only.

**Table 61: Instrument Connection Temperature Ranges**

Code	Description	Temperature
G1	Needle valves, CS	-20 to 850 °F (-29 to 454 °C)
G2	Needle valves, SST	-40 to 850 °F (-40 to 454 °C)
G3	Needle valves, alloy C-276	

**Table 61: Instrument Connection Temperature Ranges** *(continued)*

Code	Description	Temperature
G5	OS&Y gate valves, CS	-20 to 775 °F (-29 to 412 °C)
G6	OS&Y gate valves, SST	-40 to 850 °F (-40 to 454 °C)

# Rosemount 586 Annubar Primary Element Mounting Hardware

## Online product configurator

Many products are configurable online using our product configurator.

Select the **Configure** button or visit [Emerson.com/global](https://emerson.com/global) to start. With this tool's built-in logic and continuous validation, you can configure your products more quickly and accurately.

## Specifications and options

The purchaser of the equipment must specify and select the product materials, options, or components.

## Sizing and Selection Body

All Rosemount flow meters can be sized to meet your application specific requirements in the DP Flow sizing and selection tool. This tool will verify if a selected product meets your application requirements, provide a comparison between different primary elements, and generate a detailed accuracy comparison graph.

Once a sizing is completed, the configuration tool will help create a complete and valid model code to match your requirements and include any additional options or approvals.

## Optimizing lead time

The starred offerings (★) represent the most common options and should be selected for the fastest delivery times. The non-starred offerings are subject to additional delivery lead time.

## Required model components

### Model

Code	Description	
586	Severe service Rosemount Annubar Primary Element Mounting Hardware	★

### Application type

Code	Description	
S <sup>(1)(2)</sup>	Severe service Rosemount Annubar	★
M <sup>(3)</sup>	Main steam line Rosemount Annubar	

(1) Required for Rosemount Annubar type F.

(2) Required for Rosemount Annubar type G.

(3) Required for Rosemount Annubar type L.

## Line size

Actual units are built to customer supplied pipe ID and wall dimensions. Line size codes in model are used as a nominal size and auto-selected by the sizing program.

Code	Description	
040	4-in. (100 mm)	★
050	5-in. (125 mm)	★
060	6-in. (150 mm)	★
080	8-in. (200 mm)	★
100	10-in. (250 mm)	★
120	12-in. (300 mm)	★
140	14-in. (350 mm)	
160	16-in. (400 mm)	
180	18-in. (450 mm)	
200	20-in. (500 mm)	
240	24-in. (600 mm)	
300	30-in. (750 mm)	
360	36-in. (900 mm)	
420	42-in. (1066 mm)	
480	48-in. (1210 mm)	
600	60-in. (1520 mm)	
720	72-in. (1820 mm)	
780	78-in. (1950 mm)	
840	84-in. (2100 mm)	
900	90-in. (2250 mm)	
960	96-in. (2400 mm)	

## Mounting assembly material

Code	Description	
C	Carbon steel (A105)	★
L	Carbon steel (A350 LF2)	
S	316/316L stainless steel	★
G	Chrome-Moly grade F-11	
N	Chrome-Moly grade F-22	
J	Chrome-Moly grade F-91	
0	No mounting (customer-supplied)	★

## Sensor material

Code	Description	
S	316/316L stainless steel	★

Code	Description	
H	Alloy C-276	
W	Alloy 800H	
K	PVDF (KYNAR)	

### Sensor size

Code	Description	
11	Sensor size 11	★
22 <sup>(1)</sup>	Sensor size 22	★
44 <sup>(2)(3)</sup>	Sensor size 44	

- (1) Not available with sensor material K.
- (2) Required for Rosemount Annubar type G.
- (3) Required for Rosemount Annubar type L.

### Mounting type

Code	Description	
A	ASME B16.5 raised face flanges	★
D <sup>(1)</sup>	EN-1092-1 raised face flanges	★
R <sup>(2)</sup>	ASME B16.5 ring type joint flanges	
0 <sup>(3)</sup>	Main steam packing gland	

- (1) Mounting flange bolting and gasket option code 0 must be selected
- (2) Mounting flange gasket material option code 2 or 0 must be selected
- (3) Required for Rosemount Annubar type L.

### Mounting pressure class

Code	Description	
1	Class 150/PN 16	★
3 <sup>(1)</sup>	Class 300/PN 40	★
6 <sup>(1)</sup>	Class 600/PN 100	★
N <sup>(1)(2)</sup>	Class 900	
F <sup>(1)(2)</sup>	Class 1500	
T <sup>(1)(2)</sup>	Class 2500	
0 <sup>(1)(2)(3)</sup>	Main steam packing gland	

- (1) Not available with sensor material K.
- (2) Not available with Rosemount Annubar type G.
- (3) Required for Rosemount Annubar type L.

### Opposite side support

Code	Description	
C <sup>(1)</sup>	NPT threaded opposite support assembly	★

Code	Description	
D <sup>(2)</sup>	Welded opposite support assembly	★
E	Flanged opposite support assembly	
0 <sup>(3)</sup>	No opposite side support required	★

(1) Not available with ASME 2500 mounting pressure class.

(2) Required for Rosemount Annubar type L.

(3) Required for Rosemount Annubar type G.

## Packing gland/packing

Code	Description	
L	SS packing gland/graphite packing	
R	Alloy C-276 packing gland/graphite packing	
T	Main steam packing gland/graphite packing	
0	Not applicable	★

## Isolation valve

Customer must supply isolation valve if EN-1092-1 mounting is selected.

Code	Description	
0 <sup>(1)(2)</sup>	Not applicable or customer supplied	★
1	Gate valve, CS	
2	Gate valve, SST	
5	Ball valve, CS	
6	Ball valve, SST	

(1) Required for Rosemount Annubar type F and type L.

(2) For customer supplied mounting or isolation valve, provide relevant dimension at time of sizing and order.

## Temperature measurement

Code	Description	
0	No temperature sensor required	
R	Remote RTD (½-in. NPT aluminum housing) with thermowell	
S	Remote RTD (½-in. NPT stainless housing) with thermowell	

## Mounting flange bolting materials

Code	Description	
A	A193 Gr B7 studs with A194 Gr 2H nuts	★
0	No flange studs/nuts supplied	★

## Mounting flange gasket materials

Code	Description	
1	Spiral wound, ASME B16.20, 304SS, flexible-graphite filler	★
0	No flange gasket supplied	★
2	Ring-joint, ASME B16.20, hexagonal, 316L	
3	Spiral wound, ASME B16.20, 316SS, PTFE filler	

## Additional options

### Optional mounting for rectangular ducts

Code	Description	
RD	Annubar mounting for rectangular ducts	

### Special cleaning

This option is not available with sensor material K.

If selected with Rosemount Annubar type F, mounting flange gasket material option code 3 must be selected.

Code	Description	
PA	Cleaning for special processes	

### Material testing

Code	Description	
V1	Dye penetrant exam	

### Material examination

Code	Description	
V2	Radiographic examination	

### Special inspection

Code	Description	
QC1	Visual and dimensional inspection with certificate	★
QC7	Inspection and performance certificate	★

### Material traceability certification

Code	Description	
Q8	Material traceability certification per EN 10204:2004 3.1	★

### Positive material identification (PMI)

For pressure retaining parts only, isolation and instrument valves are not included.

Code	Description	
V4	PMI Verification and Certification	

### Code conformance

Code	Description	
J2	ANSI/ASME B31.1	
J3	ANSI/ASME B31.3	

### Materials conformance

Materials of construction comply with metallurgical requirements within NACE MR0175/ISO for sour oil field production environments. Environmental limits apply to certain materials. Consult latest standard for details. Selected materials also conform to NACE MR0103 for sour refining environments.

Code	Description	
J5	Certificate of Compliance to NACE MR0175/ISO 15156 for wetted materials	

### Country certification

Code	Description	
J6	European Pressure Directive (PED)	★
J1	Canadian Registration	

### Special shipment

Include Y1 option on Rosemount 586 model also.

Code	Description	
Y1	Mounting hardware shipped separately	★

### Assemble mounting hardware

This option is only available with Rosemount Annubar type L.

Code	Description	
WP	Factory-welded main steam packing gland	★

### Packing gland plug

This option is only available with Rosemount Annubar type L.

Code	Description	
TP	Packing gland plug for steam blow down	

**Installation alignment bar**

This option is only available with Rosemount Annubar type L.

Code	Description	
A1	Installation alignment bar	

# Rosemount 405 Compact Primary Element



Rosemount 405 Compact Primary Element utilizes an easy to install direct mount primary element assembly.

- Available with conditioning orifice plate technology or Rosemount Annubar Primary Element Technology
- Rosemount 405P/C orifice primary elements are based on ASME/ISO corner tap design
- Typical 405 model code: **405 C S 040 N 040 D3**

**Additional information**

[Specifications](#)

Installation and Dimensional drawings: [Relevant documents](#)

<a href="#">CONFIGURE &gt;</a>	<a href="#">VIEW PRODUCT &gt;</a>
--------------------------------	-----------------------------------

## Online product configurator

Many products are configurable online using our product configurator.

Select the **Configure** button or visit [Emerson.com/global](https://emerson.com/global) to start. With this tool's built-in logic and continuous validation, you can configure your products more quickly and accurately.

## Specifications and options

The purchaser of the equipment must specify and select the product materials, options, or components.

## Sizing and Selection Body

All Rosemount flow meters can be sized to meet your application specific requirements in the DP Flow sizing and selection tool. This tool will verify if a selected product meets your application requirements, provide a comparison between different primary elements, and generate a detailed accuracy comparison graph.

Once a sizing is completed, the configuration tool will help create a complete and valid model code to match your requirements and include any additional options or approvals.

## Optimizing lead time

The starred offerings (★) represent the most common options and should be selected for the fastest delivery times. The non-starred offerings are subject to additional delivery lead time.

## Required model components

### Model

Code	Description	
405	Compact Primary Element	★

## Primary element technology

Code	Description	
A	Rosemount Annubar sensor size 1	★
C	Conditioning orifice plate	★
P	Orifice plate	★

## Material type

Code	Description	
S	316 SST	★

## Line size

Code	Description	
005 <sup>(1)</sup>	½-in. (15 mm)	★
010 <sup>(1)</sup>	1-in. (25 mm)	★
015 <sup>(1)</sup>	1½-in. (40 mm)	★
020	2-in. (50 mm)	★
030	3-in. (80 mm)	★
040	4-in. (100 mm)	★
060	6-in. (150 mm)	★
080	8-in. (200 mm)	★
100 <sup>(2)(3)</sup>	10-in. (250 mm)	★
120 <sup>(2)(3)</sup>	12-in. (300 mm)	★

(1) Available with Primary Element Technology P only.

(2) For the 10- and 12-in. (250 and 300 mm) line size, the alignment ring must be ordered (installation accessories).

(3) 10- and 12-in. (250 and 300 mm) line sizes not available with Primary Element Technology A.

## Temperature measurement

Code	Description	
T <sup>(1)</sup>	Integral RTD	★
N	No temperature sensor	★

(1) Available with Primary Element Technology A only.

## Primary element type

Code	Description	
000	Rosemount Annubar sensor size 1	★
040	0.40 beta ratio ( $\beta$ )	★
050	0.50 beta ratio ( $\beta$ )	★

Code	Description	
065 <sup>(1)</sup>	0.65 beta ratio ( $\beta$ )	★

(1) For 2-in. (50 mm) line sizes the primary element type is 0.60 for Primary Element Technology code C.

## Transmitter connection

Code	Description	
D3	Direct mount integral 3-valve manifold	★
R3	Remote mount, NPT connections	★
A3 <sup>(1)</sup>	Traditional, direct mount, 3-valve integral manifold with adapter plate, SST	

(1) A transmitter connection available with Primary Element Technology C or P only.

## Additional options

### Extended product warranty

Code	Description	
WR3	3-year limited warranty	★
WR5	5-year limited warranty	★

### Installation accessories

Code	Description	
A <sup>(1)</sup>	ANSI alignment ring (Class 150)	★
C <sup>(1)</sup>	ANSI alignment ring (Class 300)	★
D <sup>(1)</sup>	ANSI alignment ring (Class 600)	★
G	DIN alignment ring (PN 16)	★
H	DIN alignment ring (PN 40)	★
J	DIN alignment ring (PN 100)	★
B	JIS alignment ring (10K) <sup>(2)</sup>	
R	JIS alignment ring (20K)	
S	JIS alignment ring (40K)	

(1) This option is only required for 10- and 12-in. [250 and 300 mm] line sizes

(2) Not available on 12 in (300mm) line size.

### Remote adapters

Code	Description	
E	Flange adapters 316 SST (½-in. NPT)	★

## High temperature application

Code	Description	
T	Graphite valve packing ( $T_{\max} = 850$ °F)	

## Flow calibration

Code	Description	
WC <sup>(1)</sup>	Flow calibration, 3-pt, conditioning orifice option C	
WD <sup>(2)(3)</sup>	Flow calibration, 10-pt, conditioning orifice option C, Rosemount Annubar option A	

(1) Available with Primary Element Technology C only.

(2) Available with Primary Element Technology C or A only.

(3) Consult factory for pipe schedules other than schedule 40.

## Pressure testing

Code	Description	
P1	Hydrostatic testing with certificate	

## Special cleaning

Available with Primary Element Technology C or P only.

Code	Description	
P2	Cleaning for special processes	★

## Special inspection

Code	Description	
QC1	Visual and dimensional inspection with certificate	★
QC7	Inspection and performance certificate	★

## Material traceability certification

Code	Description	
Q8	Material traceability certification per EN 10204:2004 3.1	★

## Positive material identification (PMI)

Code	Description	
Q76	PMI verification and certificate	★

## Code conformance

Code	Description	
J2	ANSI/ASME B31.1	

Code	Description	
J3	ANSI/ASME B31.3	
J5 <sup>(1)</sup>	Certificate of Compliance to NACE MR0175/ISO 15156 for wetted materials	

(1) *Materials of construction comply with metallurgical requirements within NACE MR0175/ISO for sour oil field production environments. Environmental limits apply to certain materials. Consult latest standard for details. Selected materials also conform to NACE MR0103 for sour refining environments.*

### Country certification

Code	Description	
J1	Canadian Registration	★
J8	Chinese Certificate of Special Equipment Type Test	

# Specifications

## Performance specifications

**Table 62: Rosemount 405C Compact Conditioning Orifice Technology**

Beta ratio	Discharge coefficient uncertainty
$\beta = 0.40, 0.50, 0.65^{(1)}$	$\pm 1.00\%^{(2)}$

(1) For 0.65 beta and  $ReD < 10,000$  add an additional 0.5 percent to the discharge coefficient uncertainty.

(2)  $\pm 0.50$  percent for 0.40 beta and WD calibration.

**Table 63: Rosemount 405P Compact Orifice Technology**

Line size	Discharge coefficient uncertainty
½-in. (15 mm)	$\pm 2.25\%$
1 to 1½-in. (25 to 40 mm) line size	$\pm 1.75\%$
2 to 12-in. (50 to 300 mm) line size	$\pm 1.25\%$

**Table 64: Rosemount 405A Compact Annubar Technology**

K Factor uncertainty	
Standard	$\pm 1.50\%$
Calibrated (Code WD)	$\pm 0.75\%$

### Line sizes

- ½-in. (15 mm) – not available for the Rosemount 405C and 405A
- 1-in. (25 mm) – not available for the Rosemount 405C and 405A
- 1½-in. (40 mm) – not available for the Rosemount 405C and 405A
- 2-in. (50 mm)
- 3-in. (80 mm)
- 4-in. (100 mm)
- 6-in. (150 mm)
- 8-in. (200 mm)
- 10-in. (250 mm) – not available for the Rosemount 405A
- 12-in. (300 mm) – not available for the Rosemount 405A

### Sizing

Visit Emerson [website](#) or contact an Emerson sales representative for assistance with sizing and selecting a meter. A [Configuration Data Sheet](#) is required prior to order for application verification.

## Functional specifications

### Service

- Liquid
- Gas
- Vapor

### Process temperature limits

Direct mount transmitter	-40 to 450 °F (-40 to 232 °C)
Remote mount transmitter	-315 to 850 °F (-193 to 454 °C)

### Differential pressure limits for primary element technology C and P for all sizes

Table 65: Maximum Allowable DP (Measurement in inH<sub>2</sub>O [bar])

Line size (inches)	Temp (F)	DP limit (inH <sub>2</sub> O)
≤ 8	850	1200
10	850	1000
	800	1050
	700	
	600	1100
	500	1150
	< 400	1200
12	850	700
	800	
	700	750
	600	
	500	800
	400	850
	< 300	900

### Differential pressure limits for primary element technology A

Table 66: Maximum Allowable DP (Measurement in inH<sub>2</sub>O [bar])

Line size	Max DP < 400 °F (200 °C)	Max DP @ 450-850 °F (200-454 °C)
2-in. (50 mm)	1500 (3.73)	1500 (3.73)
3-in. (80 mm)	900 (2.24)	790 (1.97)
4-in. (100 mm)	570 (1.42)	500 (1.24)

**Table 66: Maximum Allowable DP (Measurement in inH<sub>2</sub>O [bar]) (continued)**

Line size	Max DP < 400 °F (200 °C)	Max DP @ 450–850 °F (200–454 °C)
6-in. (150 mm)	290 (0.72)	250 (0.62)
8-in. (200 mm)	190 (0.47)	160 (0.40)

## Maximum working pressure

Pressure retention per ASME B16.5 Class 600 or DIN PN100

## Vibration effect for Rosemount 405A, 405C, and 405P

Qualified per IEC61298-3 (2008) for field with general application or pipeline with low vibration level (10–1000 Hz test frequency range, 0.15 mm displacement peak amplitude, 20 m/s<sup>2</sup> acceleration amplitude).<sup>(15)</sup>

The weight and length of the transmitter assembly shall not exceed 9.8 lb (4,45 kg) and 8.60-in. (218,44 mm).

## Assembly to a transmitter

Select option code C11 for the Rosemount 3051S Transmitter (or option code S3 for the Rosemount 3051C or 2051C transmitters) to factory assemble the Rosemount 405 to a pressure transmitter. If the Rosemount 405 and transmitter are not factory assembled, they may be shipped separately. For a consolidated shipment, inform the Emerson representative when placing the order.

## Physical specifications

### Temperature measurement for primary element technology P and C

#### Integral RTD

##### Note

Only available with Rosemount 3051SFC Compact Orifice Flow Meter.

- 100 ohm platinum RTD temperature sensor assembly (316 SST mineral insulated cable) with ¼ NPT connection to wafer side and ½ NPT connection to transmitter RTD sensor is separated from process fluid by 1/16-in. and is pressure retaining rated for ANSI Class 600. Complies with IEC-751 Class B accuracy. Meets Intrinsic Safety certification.

#### Remote RTD

##### Note

Only available with Rosemount 3051SFC, 3051CFC, or 2051CFC Compact Orifice Flow Meter models.

- 100 Ohm platinum with ½ NPT nipple and union; Rosemount 214C and 114C models: 214CRTSMB1S4E0042SLXW and 114CE0025TAA1SC017AQ8XW.
- Standard RTD cable is shielded armored cable, length is 12 ft. (3,66 m)
- Remote RTD material is SST thermowell
- ½- x ½ NPT, 316 SST

(15) SST temperature housing is not recommended with Primary Element Technology A in applications with mechanical vibration.

## Temperature measurement for Primary Element Technology A

### Integral RTD

- 100 Ohm platinum RTD
- 4-wire RTD ( $\alpha = 0.00385$ )

## Physical details

### Body

316/316L SST

### Manifold head/valves

316 SST

### Orifice plate for primary element technologies C and P

50 micro-inch Ra surface finish

### Rosemount Annubar Primary Element for Primary Element Technology A

Roughened surface finish

### Flange studs and nuts

- Customer supplied
- Available as a spare part

### Transmitter connection studs and nuts

- Studs– 300 Series Stainless Steel
- Nuts– A194 grade 8M

### Gasket and O-rings

- Gaskets are customer supplied.
- Gaskets and O-rings are available as spare parts
- Gaskets and O-rings should be replaced when the Rosemount 405 is disassembled.

## Transmitter connections

### Direct mount

Available with Rosemount 3051SMV, 3051S, 3051, and 2051 Transmitters.

### Remote mount

- Primary element technology C or P available with ¼ NPT (standard) or ½ NPT (option code E) connections
- Remote mount transmitter connections available with ½ NPT for primary element technology A

## Orifice plate design

### Orifice type

Square edged

### Orifice pressure taps

Corner

## Alignment rings

**Table 67: Mounts Between the Following Flange Configurations**

ASME B16.5 (ANSI)	DIN	JIS
Class 150	PN 16 (option code G)	10k (option code B)
Class 300	PN 40 (option code H)	20k (option code R)
Class 600	PN 100 (option code J)	40k (option code S)

ANSI 150 - Class 600 alignment ring is included as standard when ordering for up to 8-in. line size. For the 10- and 12-in. line size, the alignment ring must be ordered (installation accessories).

## Typical orifice hole sizes

For Rosemount 405C, beta is calculated by:  $\beta = dC/\text{Pipe ID}^{(16)}$ , where the calculated bore is equal to 2x typical orifice hole size ( $dC = 2d$ ). The tables below show the diameter of the typical orifice holes.

**Table 68:  $\beta = 0.4$  (Measurement in Inches [mm])**

Tolerance =  $\pm 0.002$ -in.

Line size	Rosemount 405C	Rosemount 405P
½-in. (15 mm)	N/A	0.249 (6.33)
1-in. (25 mm)		0.420 (10.67)
1½-in. (40 mm)		0.644 (16.36)
2-in. (50 mm)	0.413 (10.40)	0.827 (21.01)
3-in. (80 mm)	0.614 (15.60)	1.227 (31.17)
4-in. (100 mm)	0.805 (20.45)	1.610 (40.89)
6-in. (150 mm)	1.213 (30.81)	2.426 (61.62)
8-in. (200 mm)	1.596 (40.54)	3.192 (81.08)
10-in. (250 mm)	2.004 (50.90)	4.008 (101.80)
12-in. (300 mm)	2.400 (60.96)	4.800 (121.92)

**Table 69:  $\beta = 0.50$  (Measurement in Inches [mm])**

Tolerance =  $\pm 0.002$ -in.

Line size	Rosemount 405C	Rosemount 405P
½-in. (15 mm)	N/A	0.311 (7.90)
1-in. (25 mm)		0.525 (13.34)
1½-in. (40 mm)		0.805 (20.45)
2-in. (50 mm)	0.517 (13.13)	1.034 (26.26)
3-in. (80 mm)	0.767 (19.48)	1.534 (38.96)
4-in. (100 mm)	1.007 (25.58)	2.013 (51.13)
6-in. (150 mm)	1.516 (38.51)	3.033 (77.04)
8-in. (200 mm)	1.995 (50.67)	3.991 (101.37)
10-in. (250 mm)	2.505 (63.63)	5.010 (127.25)

(16) Based on schedule 40.

**Table 69:  $\beta = 0.50$  (Measurement in Inches [mm]) (continued)**

Line size	Rosemount 405C	Rosemount 405P
12-in. (300 mm)	3.000 (76.20)	6.000 (152.40)

**Table 70:  $\beta = 0.65$  (Measurement in Inches [mm])**Tolerance =  $\pm 0.002$ -in.

Line size	Rosemount 405C	Rosemount 405P
½-in. (15 mm)	N/A	0.404 (10.26)
1-in. (25 mm)		0.682 (17.32)
1½-in. (40 mm)		1.047 (26.59)
2-in. (50 mm)	0.620 (15.75) <sup>(1)</sup>	1.344 (34.14)
3-in. (80 mm)	0.997 (25.32)	1.994 (50.65)
4-in. (100 mm)	1.309 (33.25)	2.617 (66.47)
6-in. (150 mm)	1.971 (50.06)	3.942 (100.13)
8-in. (200 mm)	2.594 (65.89)	5.188 (131.78)
10-in. (250 mm)	3.257 (82.73)	6.513 (165.43)
12-in. (300 mm)	3.900 (99.06)	7.800 (198.12)

(1) For 2-in. (50 mm) line size, the Beta ( $\beta$ ) = 0.60.

## Standard weight of Rosemount 405 Primary Elements

**Table 71: Rosemount 405 P or C Weight (Measurement in lb [kg])**

Line size	Rosemount 405C	Rosemount 405P
½-in. (15 mm)	3.50 (1.73)	7.5 (3.70)
1-in. (25 mm)	4.25 (2.10)	8.25 (4.07)
1½-in. (40 mm)	4.75 (2.34)	8.75 (4.32)
2-in. (50 mm)	5.00 (2.47)	9.00 (4.44)
3-in. (80 mm)	7.00 (3.45)	11.00 (5.43)
4-in. (100 mm)	9.50 (4.69)	13.50 (6.67)
6-in. (150 mm)	13.00 (6.41)	17.00 (8.40)
8-in. (200 mm)	18.25 (9.00)	22.25 (10.99)
10-in. (250 mm)	23.50 (11.59)	27.50 (13.58)
12-in. (300 mm)	29.50 (14.55)	33.50 (16.54)

**Table 72: Rosemount 405A Weight (Measurement in lb [kg])**

Line size	Direct mount (D3)	Remote mount (R3)
2-in. (50 mm)	5.59 (2.53)	7.26 (3.29)
3-in. (80 mm)	7.41 (3.36)	9.08 (4.12)
4-in. (100 mm)	9.18 (4.16)	10.85 (4.92)
6-in. (150 mm)	13.10 (5.94)	14.76 (6.70)
8-in. (200 mm)	17.12 (7.77)	18.78 (8.52)

# Rosemount 1595 Conditioning Orifice Plate



Rosemount 1595 Conditioning Orifice combines a flow conditioner with an orifice plate into a highly accurate primary element.

- Requires only two diameters of straight pipe run upstream and downstream from most flow disturbances
- Suitable for most gas, liquid, and steam applications
- Available in 2- to 24-in. (50 to 600 mm) line sizes

#### Additional information

[Specifications](#)

Installation and dimensional drawings:

[Relevant documents](#)

[CONFIGURE >](#)

[VIEW PRODUCT >](#)

## Online product configurator

Many products are configurable online using our product configurator.

Select the **Configure** button or visit [Emerson.com/global](https://emerson.com/global) to start. With this tool's built-in logic and continuous validation, you can configure your products more quickly and accurately.

## Specifications and options

The purchaser of the equipment must specify and select the product materials, options, or components.

## Sizing and Selection Body

All Rosemount flow meters can be sized to meet your application specific requirements in the DP Flow sizing and selection tool. This tool will verify if a selected product meets your application requirements, provide a comparison between different primary elements, and generate a detailed accuracy comparison graph.

Once a sizing is completed, the configuration tool will help create a complete and valid model code to match your requirements and include any additional options or approvals.

## Optimizing lead time

The starred offerings (★) represent the most common options and should be selected for the fastest delivery times. The non-starred offerings are subject to additional delivery lead time.

## Required model components

### Model

Code	Description	
1595	Conditioning orifice plate	★

### Plate type

Code	Description	
P	Paddle, square edged	★
U <sup>(1)(2)</sup>	Universal, square edged	★

(1) Currently available up to 12-in. (300 mm) line size.

(2) For use with a plate holder device in RTJ type flanges or orifice fittings.

### Line size

Code	Description	
020	2-in. (50 mm)	★
030	3-in. (80 mm)	★
040	4-in. (100 mm)	★
060	6-in. (150 mm)	★
080	8-in. (200 mm)	★
100	10-in. (250 mm)	★
120	12-in. (300 mm)	
140	14-in. (350 mm)	
160	16-in. (400 mm)	
180	18-in. (450 mm)	
200	20-in. (500 mm)	
240	24-in. (600 mm)	

### Flange rating

Code	Description	
A1	Class150 RF ASME B16.5 (not compatible with standard ASME B16.36 orifice flanges)	★
A3	Class 300 RF ASME B16.36	★
A6	Class 600 RF ASME B16.36	★
A9	Class 900 RF ASME B16.36	★
AF	Class 1500 RF ASME B16.36	★
AT	Class 2500 RF ASME B16.36	★
D1 <sup>(1)</sup>	PN10 EN-1092-1 RF (only available with plate type P)	
D2 <sup>(1)</sup>	PN16 EN-1092-1 RF (only available with plate type P)	

Code	Description	
D3 <sup>(1)</sup>	PN25 EN-1092-1 RF (only available with plate type P)	
D4 <sup>(1)</sup>	PN40 EN-1092-1 RF (only available with plate type P)	
D5 <sup>(1)</sup>	PN63 EN-1092-1 RF (only available with plate type P)	
D6 <sup>(1)</sup>	PN100 EN-1092-1 RF (only available with plate type P)	
R3 <sup>(1)</sup>	Class 300 RTJ ASME B16.36 (only available with orifice plate type code U)	
R6 <sup>(1)</sup>	Class 600 RTJ ASME B16.36 (only available with orifice plate type code U)	
R9 <sup>(1)</sup>	Class 900 RTJ ASME B16.36 (only available with orifice plate type code U)	
RF <sup>(1)</sup>	Class 1500 RTJ ASME B16.36 (only available with orifice plate type code U)	
RT <sup>(1)</sup>	Class 2500 RTJ ASME B16.36 (only available with orifice plate type code U)	

(1) Currently available up to 12-in. (300 mm) line size.

### Material type

Code	Description	
S	316/316L SST	★
M	Alloy 400	
H	Alloy C-276	

### Orifice plate thickness

Code	Description	Plate type P	Plate type U	
A	0.125-in.	Line sizes 2- to 4-in. (50 to 100 mm)	Line size 2- to 6-in. (50 to 150 mm)	★
B	0.250-in.	Line sizes 6- to 12-in. (150 to 300 mm)	Line size 8- to 12-in. (200 to 300 mm)	★
C	0.375-in.	Line sizes 14- to 20-in. (350 to 500 mm)	N/A	
D	0.500-in.	Line size 24-in. (600 mm)	N/A	

### Beta ratio

Code	Description	
020	0.20 beta ratio	★
040	0.40 beta ratio	★
050	0.50 beta ratio	★
065	0.65 beta ratio (0.60 beta ratio for line size option 020 only)	★

### Additional options

#### Extended product warranty

Code	Description	
WR3	3-year limited warranty	★

Code	Description	
WR5	5-year limited warranty	★

### Flow calibration

Code	Description	
WD	Discharge coefficient verification (full 10 points)	

### Plate holder

This option is currently available up to 12-in. (300 mm) line size. Three inches line sizes and below use an integral plate holder. Line sizes 4-in. and above use a screw type plate holder. The plate holder material matches the plate material. The screws provided with all plate holders are 316SST.

Code	Description	
PH	Plate holder for universal type orifice plate for use with RTJ flange	

### Special cleaning

Code	Description	
P2	Cleaning for special processes	

### Special inspection

Code	Description	
QC1	Visual and dimensional inspection with certificate	★
QC7	Inspection and performance certificate	★

### Material traceability certification

Code	Description	
Q8	Material traceability certification per EN 10204:2004 3.1	★

### Positive material identification (PMI)

Code	Description	
Q76	PMI verification and certificate	★

### Materials conformance

Materials of construction comply with metallurgical requirements within NACE MR0175/ISO for sour oil field production environments. Environmental limits apply to certain materials. Consult latest standard for details. Selected materials also conform to NACE MR0103 for sour refining environments.

Code	Description	
J5	Certificate of Compliance to NACE MR0175/ISO 15156 for wetted materials	

Country conformance

Code	Description	
J1	Canadian Registration	
J8	Chinese Certificate of Special Equipment Type Test	

# Specifications

## Performance specifications

### Flow coefficient uncertainty

**Table 73: Rosemount 1595 Uncertainty - Installation Per Reference Manual<sup>(1)</sup>**

Beta ratio range	Discharge coefficient uncertainty <sup>(2)</sup> , 2-sigma (95% confidence)		
	Calibrated (WD Option)	2 to 4-inch pipes <sup>(3)</sup>	6 to 24-inch pipes <sup>(3)</sup>
0.20-0.35	±0.50%	±1.50%	±1.00%
0.40-0.55	±0.75%	±1.50%	±1.00%
0.60-0.70	±1.25%	±1.75%	±1.50%

- (1) Short piping runs, lengths as short as 2D up and downstream (see Manual).  
 (2) For  $\beta \geq 0.65$  and  $ReD < 10,000$ , add an additional 0.5% to the discharge coefficient uncertainty.  
 (3) For model 1595 COP without the WD calibration option.

**Table 74: Rosemount 1595 Uncertainty - Installation Per ISO 5167<sup>(1)</sup>**

Beta ratio range	Discharge coefficient uncertainty <sup>(2)</sup> , 2-sigma (95% confidence)		
	Calibrated (WD Option)	2 to 4-inch pipes <sup>(3)(4)</sup>	6 to 24-inch pipes <sup>(3)(4)</sup>
0.20-0.35	±0.50%	±1.00%	±0.75%
0.40-0.55	±0.50%	±0.75%	±0.50%
0.60-0.70	±0.50%	±0.75%	±0.50%

- (1) For model 1595 COP using flange taps, in Sch40/Std pipe sizes with upstream straight piping of 10 pipe diameters or more, assume the values for bore, pipe ID and  $ReD$  are known without error.  
 (2) For  $\beta \geq 0.65$  and  $ReD < 10,000$ , add an additional 0.5% to the discharge coefficient uncertainty.  
 (3) The orifice bore and the pipe at a point 0.5-D upstream of the plate must be measured to achieve these uncertainty values. For typical errors in bore, pipe ID and  $ReD$ , add 0.4% to the discharge coefficient uncertainty.  
 (4) For model 1595 COP without the WD calibration option.

## Sizing

Visit Emerson [website](#) or contact an Emerson sales representative for assistance with sizing and selecting a meter. A [Configuration Data Sheet](#) is required prior to order for application verification.

## Pressure tap orientation

Orient the Rosemount 1595 so pressure taps are centered between any two (of four) orifice bore holes. In addition, the pressure taps should be located at 90° to the plane of the last upstream elbow under any of these conditions:

- with less than six upstream pipe diameters
- with a 0.65 Beta

The Rosemount 1595 can be used with the following pressure taps:

- Flange pressure taps - all beta sizes
- Radius pressure taps (D and D/2) - 0.4 beta size or smaller

## Centering requirements

The Rosemount 1595 should be installed so that it is centered in the pipes as recommended by ISO-5167.

## Functional specifications

### Service and flow range

Liquid, gas or steam turbulent flow, for pipe Reynold's numbers greater than 5,000.

### Pipe sizes

2- to 24-in. (50 to 600 mm). Contact Emerson for other pipe sizes.

### Operating limits

For line sizes 2- to 24-in. (50 to 600 mm)

**Table 75: Orifice Plate Temperature Range per ASME B31.3**

1595 material	Temperature rating
316/316L SST	-430 to 1200 °F (-257 to 649 °C)
Alloy 400	-325 to 900 °F (-198 to 482 °C)
Alloy C-276	-325 to 1250 °F (-198 to 677 °C)

Up to 1200 inH<sub>2</sub>O differential pressure dependent on temperature, line size, and material.

### Maximum working pressure

Flange rating per ASME B16.5 and DIN EN 1092-1

## Physical specifications

### Material of construction

Code	Description	ASTM	UNS	DIN (W.-Nr.)
S	316/316L SST	A240 Gr 316/316L	S31600/ S31603	1.4401/1.4404 (1.4436/1.4435)
H	Alloy C-276	B575 Gr N10376	N10276	2.4819
M	Alloy 400	B127 Gr N04400	N04400	2.4360

### Flange mounting hardware

The Rosemount 1595 can be used with the Rosemount 1496 Flange Union.

### Orifice type

- Paddle, square-edge
- Universal, square-edge

### Typical orifice hole sizes

Beta is calculated by:  $\beta = d_c / \text{Pipe ID}$ , where the calculated bore is equal to 2x typical orifice hole size ( $d_c = 2d$ ). Table 76 shows the diameter of each of the four orifice holes.

**Table 76: Typical Orifice Hole Sizes**

Line size	Pipe ID	Beta ( $\beta$ ) = 0.20	Beta ( $\beta$ ) = 0.40	Beta ( $\beta$ ) = 0.50	Beta ( $\beta$ ) = 0.65
2-in. (50.8 mm)	2.067-in. (52.502 mm)	0.207 (5.26)	0.413 (10.49)	0.517 (13.13)	0.620 (15.75) <sup>(1)</sup>
3-in. (76.2 mm)	3.068-in. (77.927 mm)	0.307 (7.80)	0.614 (15.60)	0.767 (19.48)	0.997 (25.32)
4-in. (101.6 mm)	4.026-in. (102.26 mm)	0.403 (10.25)	0.805 (20.45)	1.007 (25.57)	1.308 (32.22)
6-in. (152.4 mm)	6.065-in. (154.051 mm)	0.607 (15.42)	1.213 (30.81)	1.516 (38.52)	1.971 (50.06)
8-in. (203.2 mm)	7.981-in. (202.717 mm)	0.798 (20.27)	1.596 (40.54)	1.995 (50.68)	2.594 (65.89)
10-in. (254.0 mm)	10.02-in. (254.508 mm)	1.002 (25.45)	2.004 (50.90)	2.505 (63.63)	3.257 (82.73)
12-in. (304.8 mm)	12.00-in. (304.8 mm)	1.200 (30.48)	2.400 (60.96)	3.000 (76.2)	3.900 (99.06)
14-in. (355.6 mm)	13.124-in. (333.35 mm)	1.312 (33.32)	2.625 (66.68)	3.281 (83.34)	4.265 (108.33)
16-in. (406.4 mm)	15.000-in. (381.00 mm)	1.500 (38.10)	3.000 (76.20)	3.750 (95.25)	4.875 (123.83)
18-in. (457.2 mm)	16.876-in. (428.65 mm)	1.688 (42.88)	3.375 (85.73)	4.219 (107.16)	5.485 (139.32)
20-in. (508.0 mm)	18.812-in. (477.82 mm)	1.881 (47.78)	3.762 (95.55)	4.703 (119.46)	6.114 (155.30)
24-in. (609.6 mm)	22.624-in. (574.65 mm)	2.262 (57.45)	4.525 (114.94)	5.656 (143.66)	7.353 (186.77)

(1) For 2-in. (50.8 mm) line size, the beta ( $\beta$ ) is 0.60.

### Available beta ratio

**Table 77: Available Beta Ratio ( $\beta$ )**

Line size	Pipe schedule	Beta ( $\beta$ ) available
2	≤ 80	0.20, 0.40, 0.50, 0.60
	160	0.20
	XXS	
3	≤ 80	0.20, 0.40, 0.50, 0.65
	160	0.20, 0.40, 0.50
	XXS	0.20
4	≤ 80	0.20, 0.40, 0.50, 0.65
	120	0.20, 0.40, 0.50
	160	
	XXS	0.20
6	≤ 80	0.20, 0.40, 0.50, 0.65
	120	0.20, 0.40, 0.50
	160	0.20, 0.40
	XXS	0.20
8	≤ 80	0.20, 0.40, 0.50, 0.65
	100	
	120	0.20, 0.40, 0.50
	140	

**Table 77: Available Beta Ratio ( $\beta$ ) (continued)**

Line size	Pipe schedule	Beta ( $\beta$ ) available
	160	0.20, 0.40
	XXS	0.20, 0.40, 0.50
10	≤ 80	0.20, 0.40, 0.50, 0.65
	100	
	120	0.20, 0.40, 0.50
	140	
	160	0.20, 0.40
	XXS	0.20, 0.40, 0.50
12	≤ 80	0.20, 0.40, 0.50, 0.65
	100	0.20, 0.40, 0.50
	120	
	140	
	160	0.20, 0.40
	XXS	0.20, 0.40, 0.50
14	≤ 80	0.20, 0.40, 0.50, 0.65
	100	0.20, 0.40, 0.50
	120	
	140	
	160	0.20, 0.40
16	≤ 80	0.20, 0.40, 0.50, 0.65
	100	0.20, 0.40, 0.50
	120	
	140	
	160	0.20, 0.40
18	≤ 80	0.20, 0.40, 0.50, 0.65
	100	
	120	0.20, 0.40, 0.50
	140	
	160	
20	≤ 80	0.20, 0.40, 0.50, 0.65
	100	
	120	0.20, 0.40, 0.50
	140	
	160	
24	≤ 80	0.20, 0.40, 0.50, 0.65
	100	0.20, 0.40, 0.50
	120	
	140	

**Table 77: Available Beta Ratio ( $\beta$ ) (continued)**

Line size	Pipe schedule	Beta ( $\beta$ ) available
	160	0.20, 0.40

# Rosemount 1195 Integral Orifice Primary Element

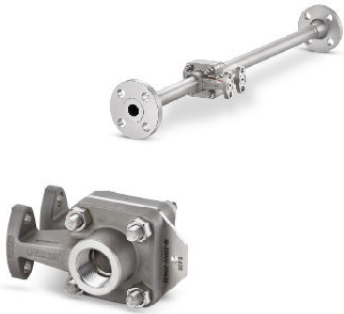

Rosemount 1195 Integral Orifice Primary Element utilizes a self centering orifice plate design to eliminate installation error.

- Enables highly accurate flow measurement in small line sizes
- Available with a variety of process connections
- Available in ½- to 1½-in. (15 to 40 mm) line sizes

Installation and dimensional drawings: [Relevant documents](#)

CONFIGURE >

VIEW PRODUCT >

## Online product configurator

Many products are configurable online using our product configurator.

Select the **Configure** button or visit [Emerson.com/global](https://emerson.com/global) to start. With this tool's built-in logic and continuous validation, you can configure your products more quickly and accurately.

## Specifications and options

The purchaser of the equipment must specify and select the product materials, options, or components.

## Sizing and Selection Body

All Rosemount flow meters can be sized to meet your application specific requirements in the DP Flow sizing and selection tool. This tool will verify if a selected product meets your application requirements, provide a comparison between different primary elements, and generate a detailed accuracy comparison graph.

Once a sizing is completed, the configuration tool will help create a complete and valid model code to match your requirements and include any additional options or approvals.

## Optimizing lead time

The starred offerings (★) represent the most common options and should be selected for the fastest delivery times. The non-starred offerings are subject to additional delivery lead time.

## Required model components

### Model

Code	Description	
1195	Integral orifice primary flow element	★

### Body material and type

Code	Description	
F	316 SST, enhanced support body	★

### Line size

Code	Description	
005	½-in. (15 mm)	★
010	1-in. (25 mm)	★
015	1½-in. (40 mm)	★

### Process connection

Code	Description	
T1	NPT female body (not available with thermowell and RTD)	★
S1 <sup>(1)</sup>	Socket weld body (not available with thermowell and RTD)	★
P1	Pipe ends: NPT threaded	★
P2	Pipe ends: beveled	★
D1	Pipe ends: flanged, PN16 EN-1092-1 RF, slip-on	★
D2	Pipe ends: flanged, PN40 EN-1092-1 RF, slip-on	★
D3	Pipe ends: flanged, PN100 EN-1092-1 RF, slip-on	★
W1	Pipe ends: flanged, Class 150 RF ASME B16.5, weld-neck	★
W3	Pipe ends: flanged, Class 300 RF ASME B16.5, weld-neck	★
W6	Pipe ends: flanged, Class 600 RF ASME B16.5, weld-neck	★
W9	Pipe ends: flanged, Class 900 RF ASME B16.5, weld-neck	★
A1	Pipe ends: flanged, Class 150 RF ASME B16.5, slip-on	
A3	Pipe ends: flanged, Class 300 RF ASME B16.5, slip-on	
A6	Pipe ends: flanged, Class 600 RF ASME B16.5, slip-on	
R1	Pipe ends: flanged, Class 150 RTJ ASME B16.5, slip-on	
R3	Pipe ends: flanged, Class 300 RTJ ASME B16.5, slip-on	
R6	Pipe ends: flanged, Class 600 RTJ ASME B16.5, slip-on	
R9	Pipe ends: flanged, Class 900 RTJ ASME B16.5, weld-neck	

(1) To improve pipe perpendicularity for gasket sealing, socket diameter is smaller than standard pipe O.D.

### Orifice plate material

Code	Description	
S	316/316L SST	★
H	Alloy C-276	
M	Alloy 400	

### Bore size option

Code	Description	
0066	0.066-in. (1.68 mm) for ½-in. pipe	★
0109	0.109-in. (2.77 mm) for ½-in. pipe	★
0160	0.160-in. (4.06 mm) for ½-in. pipe	★
0196	0.196-in. (4.98 mm) for ½-in. pipe	★
0260	0.260-in. (6.60 mm) for ½-in. pipe	★
0340	0.340-in. (8.64 mm) for ½-in. pipe	★
0150	0.150-in. (3.81 mm) for 1-in. pipe	★
0250	0.250-in. (6.35 mm) for 1-in. pipe	★
0345	0.345-in. (8.76 mm) for 1-in. pipe	★
0500	0.500-in. (12.70 mm) for 1-in. pipe	★
0630	0.630-in. (16.00 mm) for 1-in. pipe	★
0800	0.800-in. (20.32 mm) for 1-in. pipe	★
0295	0.295-in. (7.49 mm) for 1½-in. pipe	★
0376	0.376-in. (9.55 mm) for 1½-in. pipe	★
0512	0.512-in. (13.00 mm) for 1½-in. pipe	★
0748	0.748-in. (19.00 mm) for 1½-in. pipe	★
1022	1.022-in. (25.96 mm) for 1½-in. pipe	★
1184	1.184-in. (30.07 mm) for 1½-in. pipe	★
0010	0.010-in. (0.25 mm) for ½-in. pipe	★
0014	0.014-in. (0.36 mm) for ½-in. pipe	
0020	0.020-in. (0.51 mm) for ½-in. pipe	
0034	0.034-in. (0.86 mm) for ½-in. pipe	
XXXX	Special bore size (X.XXX-in.)	

### Transmitter/body bolt material

Code	Description	
C	316 SST (1½-in. transmitter studs)	★
G <sup>(1)</sup>	High temperature (850 °F [454 °C])	

(1) Not available with assemble to transmitter code S4.

## Additional options

### Extended product warranty

Code	Description	
WR3	3-year limited warranty	★
WR5	5-year limited warranty	★

### Temperature sensor

Thermowell material is the same as the body material.

Code	Description	
S	Thermowell and RTD (SST temperature housing)	
T	Thermowell and RTD (Aluminum temperature housing)	★

### Assemble to transmitter

This option is not available with process connection code S1.

Code	Description	
S4	Factory assembly – attach to transmitter and manifold	★

### Optional bore calculation

Code	Description	
BC	Bore calculation	★

### Optional connection

Code	Description	
G1	DIN 19213 transmitter connection	★

### Adapters for remote mounting

Code	Description	
G2	½-14 NPT remote adapters – SST	★

### Pressure testing

Does not apply to process connection codes T1 and S1.

Code	Description	
P1	Hydrostatic testing with certificate	

### Special cleaning

Code	Description	
P2	Cleaning for special processes	

### Material testing

Code	Description	
V1	Dye penetrant exam	

### Material examination

Available only with process connection code W1, W3, W6, and W9.

Code	Description	
V2	Radiographic examination	★

### Flow calibration

This is not available for bore sizes 0010, 0014, 0020, 0034, 0066, or 0109. Does not apply to process connection codes T1 and S1.

Code	Description	
WD	Discharge coefficient verification	

### Special inspection

Code	Description	
QC1	Visual and dimensional inspection with certificate	★
QC7	Inspection and performance certificate	★

### Material traceability certification

Code	Description	
Q8	Material traceability certification per EN 10204:2004 3.1	★

### Positive material identification (PMI)

Code	Description	
Q76	PMI verification and certificate	★

### Code conformance

Not available with DIN process connection codes D1, D2, or D3

Code	Description	
J2	ANSI/ASME B31.1	★
J3	ANSI/ASME B31.3	

### Materials conformance

Materials of construction comply with metallurgical requirements within NACE MR0175/ISO for sour oil field production environments. Environmental limits apply to certain materials. Consult latest standard for details. Selected materials also conform to NACE MR0103 for sour refining environments.

Code	Description	
J5	Certificate of Compliance to NACE MR0175/ISO 15156 for wetted materials	

### Country certification

Code	Description	
J6	European Pressure Directive (PED)	★
J1	Canadian Registration	

### Hardware adjustments and ground screw

Code	Description	
A1	External ground screw for temperature connection head	
A2	Cover clamp and external ground screw for temperature connection head	

# Specifications

## Performance specifications

**Table 78: Discharge Coefficient Uncertainty**

Without associated straight run piping, discharge coefficient uncertainty can add up to 1.5–5 percent additional error. Consult the factory for additional information.

Orifice plate bore	Discharge coefficient uncertainty
Bore < 0.160	±2.50%
0.160 ≤ Bore < 0.500	±1.50%
0.500 ≤ Bore ≤ 1.000	±1.00%
1.000 < Bore	±1.50%

### Line sizes

- ½-in. (15 mm)
- 1-in. (25 mm)
- 1½-in. (40 mm)

### Sizing

Visit Emerson [website](#) or contact an Emerson sales representative for assistance with sizing and selecting a meter. A [Configuration Data Sheet](#) is required prior to order for application verification.

## Functional specifications

### Service

- Liquid
- Gas
- Steam

### Process temperature limits

Standard (direct mount):

–40 to 550 °F (–40 to 288 °C)

Standard (remote mount with PTFE O-rings):

–40 to 572 °F (–40 to 300 °C)

Extended (remote mount only with option code G):

–112 to 850 °F (–80 to 454 °C)<sup>(17)</sup>

(17) Consult factory for all-welded design for extended temperature.

## Maximum working pressure

**Table 79: Standard HydroTest Pressures for Integral Orifice Plates in PSIG**

Rosemount 1195	Body type		316SS	
	Description	Code	Max working pressure	Hydro pressure
½-in. line	Threaded fitting	T1/P1	2160	3240
	Welded fitting	S1/P2	3000	4500
	Class 150 flanged	A1/W1/R1	275	413
	Class 300 flanged	A3/W3/R3	720	1080
	Class 600 flanged	A6/W6/R6	1440	2160
	Class 900 flanged	W9/R9	2160	3240
	DIN PN16 flanged	D1	232	348
	DIN PN 40 flanged	D2	580	870
	DIN PN100 flanged	D3	1450	2175
1-in. line	Threaded fitting	T1/P1	2160	3240
	Welded fitting	S1/P2	2160	3240
	Class 150 flanged	A1/W1/R1	275	413
	Class 300 flanged	A3/W3/R3	720	1080
	Class 600 flanged	A6/W6/R6	1440	2160
	Class 900 flanged	W9/R9	2160	3240
	DIN PN16 flanged	D1	232	348
	DIN PN 40 flanged	D2	580	870
	DIN PN100 flanged	D3	1450	2175
1½-in. line	Threaded fitting	P1	1500	3240
	Threaded/welded fitting	T1/S1/P2	2160	3240
	Class 150 flanged	A1/W1/R1	275	413
	Class 300 flanged	A3/W3/R3	720	1080
	Class 600 flanged	A6/W6/R6	1440	2160
	Class 900 flanged	W9/R9	2160	3240
	DIN PN16 flanged	D1	232	348
	DIN PN 40 flanged	D2	580	870
	DIN PN100 flanged	D3	1450	2175

## Physical specifications

### Material of construction

#### Orifice Plate

- 316/316L SST
- Alloy C-276

- Alloy 400

### Body

A312 Gr 316/316L

### Flange

- A182 Gr 316/316L
- Flange pressure limits are per ASME B16.5
- Flange face finish per ASME B16.5, 125 to 250 RMS

### Body Bolts/Studs

- 300 Series Stainless Steel
- ASTM A193 Gr B8M Class 2 body studs provided for high temperature option code G
- ASTM A193 Gr B8M Class 2 body studs provided for 1–½-in. (code 015) line size units ordered with high pressure process connection Option Codes W9, R9, T1, S1, or P2.

### Transmitter Connection Studs

300 Series Stainless Steel

### Gaskets/O-rings

- Glass filled PTFE
- Alloy X-750 provided for high temperature Option Code G
- Gaskets and O-rings must be replaced each time the Rosemount 1195 is disassembled for installation or maintenance.

## Orifice type

### Square edge – Orifice bore sizes

0.066 in. and larger

### Quadrant edge – Orifice bore sizes (for ½ in. [15 mm] line size only)

- 0.034 in. (0.86 mm)
- 0.020 in. (0.51 mm)
- 0.014 in. (0.35 mm)
- 0.010 in. (0.25 mm)

---

### Note

Integral orifice bodies contain corner tapped pressure ports.

---

### Pipe lengths

Upstream and downstream associated piping sections are available on the Rosemount 1195. See [“Rosemount 1195 Integral orifice plate”](#) on page 237.

### Transmitter connections

2½-in. (54 mm) center-to-center. Other transmitter spacing can be accommodated using the optional remote adapters and customer-supplied impulse piping. DIN 19213 connections are available.

**Figure 6: Bolt Types for Enhanced Support Body**

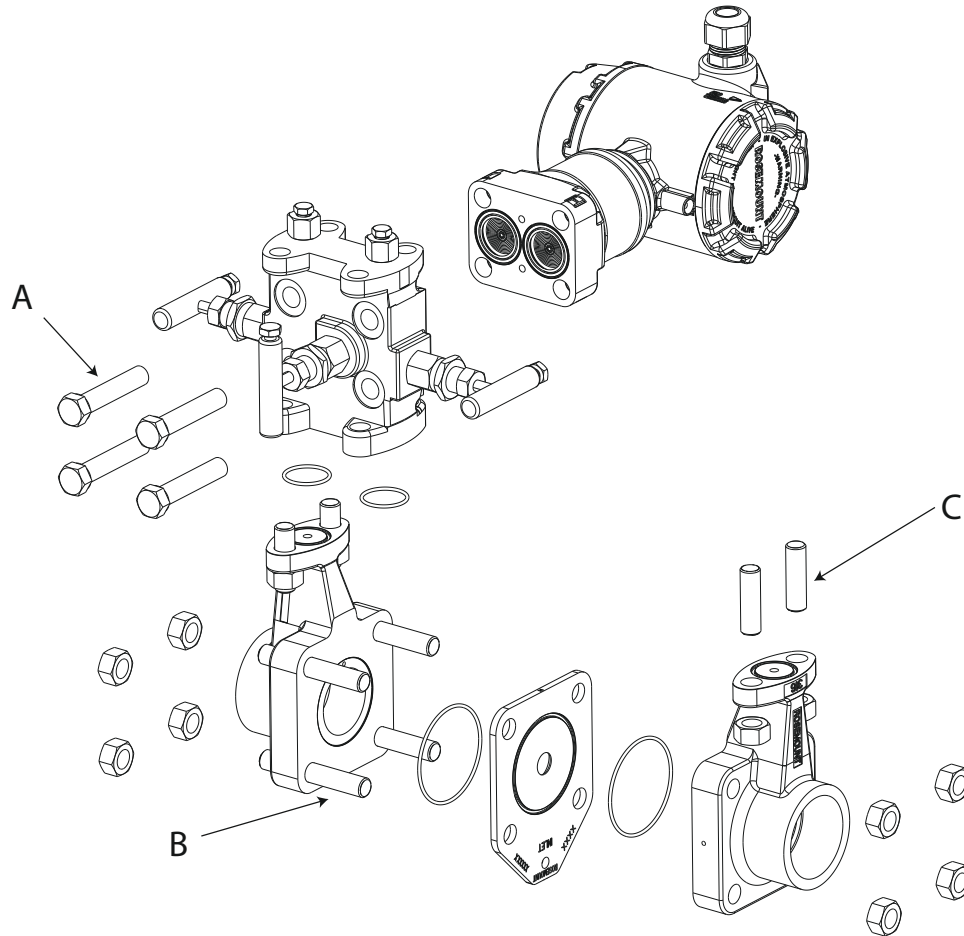

- A. Transmitter bolts- (4x)
- B. Orifice body studs - (4x)
- C. Manifold studs - (4x)

**Table 80: Weight (Weights are Approximate)**

Line size	Rosemount 1195 only		with Flanged piping <sup>(1)</sup>	
	lb	kg	lb	kg
½-in.	5.0	2.3	9.0	4.1
1-in.	7.0	3.2	13.0	5.9
1½-in.	9.0	4.1	26.0	11.8

(1) As supplied with standard lengths, ASME Class 150 flanges.

# Rosemount 1495 Orifice Plate



Standard configuration is with a square-edged concentric bore in both paddle and universal type plates. Also available with a machined gasket sealing surface. Final inspection reports illustrating plate thickness, concentricity, outside dimensions, inside dimensions, roundness, and flatness are available.

- Bore calculations are available if the Configuration Data Sheet (CDS) is completed and option BC is selected.

CONFIGURE >
VIEW PRODUCT >

## Online product configurator

Many products are configurable online using our product configurator.

Select the **Configure** button or visit [Emerson.com/global](https://emerson.com/global) to start. With this tool's built-in logic and continuous validation, you can configure your products more quickly and accurately.

## Specifications and options

The purchaser of the equipment must specify and select the product materials, options, or components.

## Sizing and Selection Body

All Rosemount flow meters can be sized to meet your application specific requirements in the DP Flow sizing and selection tool. This tool will verify if a selected product meets your application requirements, provide a comparison between different primary elements, and generate a detailed accuracy comparison graph.

Once a sizing is completed, the configuration tool will help create a complete and valid model code to match your requirements and include any additional options or approvals.

## Optimizing lead time

The starred offerings (★) represent the most common options and should be selected for the fastest delivery times. The non-starred offerings are subject to additional delivery lead time.

## Required model components

### Model

Code	Description	
1495	Orifice plate primary	★

## Orifice plate type

Code	Description	
PC	Paddle, concentric with better than 50 Ra (1.25 µm) finish	★
PG	Paddle, concentric, with 125–250 Ra (3.2–3.6 µm) surface finish for use with spiral wound gaskets	★
UC	Universal, Concentric	★

## Line size

Code	Description	
020	2-in. (DN50)	★
025	2½-in. (DN65)	★
030	3-in. (DN80)	★
040	4-in. (DN100)	★
060	6-in. (DN150)	★
080	8-in. (DN200)	★
100	10-in. (DN250)	★
120	12-in. (DN300)	★
140	14-in. (DN350)	★
160	16-in. (DN400)	★
180	18-in. (DN450)	★
200	20-in. (DN500)	★
240	24-in. (DN600)	★

## Flange rating

This option determines plate outside diameter for paddle-style plates.

Code	Description	
A1	ASME B16.5 Class 150 RF (not typical for ASME B16.36 flange tapped flanges)	★
A3	ASME B16.36 Class 300 RF	★
A6	ASME B16.36 Class 600 RF	★
A9	ASME B16.36 Class 900 RF	★
AF	ASME B16.36 Class 1500 RF	★
AT <sup>(1)</sup>	ASME B16.36 Class 2500 RF	★
D1	EN-1092-1 PN 10	★
D2	EN-1092-1 PN 16	★
D3	EN-1092-1 PN 25	★
D4	EN-1092-1 PN 40	★
D5 <sup>(2)</sup>	EN-1092-1 PN 63	★
D6	EN-1092-1 PN 100	★
R3	ASME B16.36 Class 300 RTJ	★
R6	ASME B16.36 Class 600 RTJ	★

Code	Description	
R9	ASME B16.36 Class 900 RTJ	★
RF	ASME B16.36 Class 1500 RTJ	★
RT <sup>(1)</sup>	ASME B16.36 Class 2500 RTJ	★

(1) Available in line sizes from 2- to 12-in.

(2) Previously PN 64.

### Orifice plate material type

Code	Description	
S	316/316L SST	★
T	DIN 1.4571 (316Ti SST)	★
L	304/304L SST	★
H	Alloy C-276	
M	Alloy 400	

### Plate thickness

Code	Description	
A	0.125-in. (3.2 mm) – default for line size 2 to 6-in. (50 to 150 mm)	★
B	0.250-in. (6.35 mm) – default for line size 8 to 14-in. (200 to 350 mm)	★
C	0.375 in. (9.53 mm) - default for line size 16 to 20-in. (400 to 500 mm)	★
D	0.500-in. (12.7 mm) – default for line size 24-in. (600 mm)	★

### Bore

Code	Description	
XXXXX	Bore (XXXXX = XX.XXX-in.)	★

## Additional options

### Extended product warranty

Code	Description	
WR3	3-year limited warranty	★
WR5	5-year limited warranty	★

### Bore calculation

Code	Description	
BC	Bore calculation	★

## Drain/vent hole

This option requires pipe I.D. to be specified. Please select alternate pipe schedule option or specify on order. The standard position of the drain/vent hole is opposite the handle on PC/PG plates.

Code	Description	
DV	Drain/vent hole	★

## Plate holder

Three inches line sizes and below use an integral plate holder. Line sizes 4-in. and above use a screw type plate holder. The plate holder material matches the plate material. The screws provided with all plate holders are 316SST.

Code	Description	
PH	Plate holder for RTJ flanges	★

## Alternate bore type

Code	Description	
TC	Conical entrance bore	★
TE <sup>(1)</sup>	Eccentric bore	★
TS <sup>(1)</sup>	Segmental bore	★
TQ	Quadrant edged bore	★
RO <sup>(2)</sup>	Restriction orifice plate	★

(1) This option requires pipe I.D. to be specified. Please select alternate pipe schedule option or specify on order.

(2) A standard beveled orifice plate is provided with the "RO" option code.

## Pipe schedule

Code	Description	
FA	Schedule 5S	★
FB	Schedule 10	★
FC	Schedule 10S	★
FD	Schedule 20	★
FE	Schedule 30	★
FF	Schedule 40	★
FG	Schedule 40S	★
FH	Schedule standard (STD)	★
FI	Schedule 60	★
FJ	Schedule 80	★
FK	Schedule 80S	★
FL	Schedule extra strong (XS)	★
FM	Schedule 100	★
FN	Schedule 120	★
FP	Schedule 140	★

Code	Description	
FQ	Schedule 160	★
FR	Schedule double extra strong (XXS)	★

**Special cleaning**

Code	Description	
P2	Cleaning for special processes	

**Special inspection**

Code	Description	
QC1	Visual and dimensional inspection with certificate	★
QC7	Inspection and performance certificate	★

**Material traceability certification**

Code	Description	
Q8	Material traceability certification per EN 10204:2004 3.1	★

**Code conformance**

Materials of construction comply with metallurgical requirements highlighted within NACE MR0175/ISO 15156 for sour oil field production environments. Environmental limits apply to certain materials. Consult latest standard for details. Selected materials also conform to NACE MR0103 for sour refining environments.

Code	Description	
J5	Certificate of Compliance to NACE MR0175/ISO 15156 for wetted materials	

**Country certification**

Code	Description	
J1	Canadian Registration	

# Rosemount 1496 Orifice Flange Union



Standard flange styles are RF weld neck, RF slip-on, or RF threaded for paddle type orifice plates, and ring type joint RTJ weld neck for universal type plates with plate holders. All flange unions are supplied with studs, nuts, jackscrews, gaskets, and pipe plugs.

- Meets ASME B16.36
- Meets EN-1092-1
- Threaded flange tap connection complying with ISO-5167-2, ASME MFC-3M, and AGA-3 provided 180° apart

The following options are available:

- Socket weld tap connections
- SST flange bolting per ASTM A193 Grade B8M/A194 Grade 8M
- Typical 1496 model code: **1496 WN 040 A3 S**

[CONFIGURE >](#)

[VIEW PRODUCT >](#)

## Online product configurator

Many products are configurable online using our product configurator.

Select the **Configure** button or visit [Emerson.com/global](https://emerson.com/global) to start. With this tool's built-in logic and continuous validation, you can configure your products more quickly and accurately.

## Specifications and options

The purchaser of the equipment must specify and select the product materials, options, or components.

## Sizing and Selection Body

All Rosemount flow meters can be sized to meet your application specific requirements in the DP Flow sizing and selection tool. This tool will verify if a selected product meets your application requirements, provide a comparison between different primary elements, and generate a detailed accuracy comparison graph.

Once a sizing is completed, the configuration tool will help create a complete and valid model code to match your requirements and include any additional options or approvals.

## Optimizing lead time

The starred offerings (★) represent the most common options and should be selected for the fastest delivery times. The non-starred offerings are subject to additional delivery lead time.

## Required model components

### Model

Code	Description	
1496	Orifice flange union	★

### Flange union type

Code	Description	
WN <sup>(1)</sup>	Raised face, weld neck, ASME B16.36	★
TH	Raised face, threaded, ASME B16.36	★
SO	Raised face, slip-on, ASME B16.36	★
DN <sup>(1)</sup>	Raised face, weld neck, EN-1092-1	★
RJ <sup>(1)</sup>	Ring joint, weld neck, ASME B16.36	

(1) WN, DN, and RJ options require pipe schedule option code.

### Line size

Code	Description	
020	2-in. (DN50)	★
025	2½-in. (DN65)	★
030	3-in. (DN80)	★
040	4-in. (DN100)	★
060	6-in. (DN150)	★
080	8-in. (DN200)	★
100	10-in. (DN250)	★
120	12-in. (DN300)	★
140	14-in. (DN350)	★
160	16-in. (DN400)	★
180	18-in. (DN450)	★
200	20-in. (DN500)	★
240	24-in. (DN600)	★

### Flange rating

Code	Description	
A3 <sup>(1)</sup>	ASME B16.36 Class 300 RF	★
A6 <sup>(1)</sup>	ASME B16.36 Class 600 RF	★
A9 <sup>(1)</sup>	ASME B16.36 Class 900 RF	★
AF <sup>(1)</sup>	ASME B16.36 Class 1500 RF	★
AT <sup>(1)(2)</sup>	ASME B16.36 Class 2500 RF	★

Code	Description	
D1	EN-1092-1 PN 10	★
D2	EN-1092-1 PN 16	★
D3	EN-1092-1 PN 25	★
D4	EN-1092-1 PN 40	★
D5 <sup>(3)</sup>	EN-1092-1 PN 63	★
D6	EN-1092-1 PN 100	★
R3	ASME B16.36 Class 300 RTJ	
R6	ASME B16.36 Class 600 RTJ	
R9	ASME B16.36 Class 900 RTJ	
RF	ASME B16.36 Class 1500 RTJ	
RT <sup>(2)</sup>	ASME B16.36 Class 2500 RTJ	

(1) A3-AT require WN, SO, TH, D1-D6 requires DN, R3-RT requires RJ flange type.

(2) Available in line sizes from 2- to 12-in.

(3) Previously PN 64.

## Flange union material type

Code	Description	
C <sup>(1)</sup>	CS	★
S	316/316L SST	★
T	DIN 1.4571 (316Ti SST)	★
L	304/304L SST	★
H	Alloy C-276	
M	Alloy 400	

(1) Standard material is A105, however depending on region, other equivalent materials may be supplied.

## Additional options

### Extended product warranty

Code	Description	
WR3	3-year limited warranty	★
WR5	5-year limited warranty	★

### Pipe schedule

Code	Description	
FA	Schedule 5S	★
FB	Schedule 10	★
FC	Schedule 10S	★

Code	Description	
FD	Schedule 20	★
FE	Schedule 30	★
FF	Schedule 40	★
FG	Schedule 40S	★
FH	Schedule standard (STD)	★
FI	Schedule 60	★
FJ	Schedule 80	★
FK	Schedule 80S	★
FL	Schedule extra strong (XS)	★
FM	Schedule 100	★
FN	Schedule 120	★
FP	Schedule 140	★
FQ	Schedule 160	★
FR	Schedule double extra strong (XXS)	★

### High temperature gaskets

Not available with flange union type code RJ. For more gasket information, see the [Table 81](#).

Code	Description	
G1	High temperature gaskets (spiral wound gaskets for use with 125–250 [3.2–6.3 μm] Ra flange surface finish)	★

### Alternate bolting material

SST bolting (ASTM A193 GR B8M Class 2) is classified as “low strength bolting” by the various ASME B31 piping codes and may not be suitable for all applications requiring code conformance.

Code	Description	
SS	316 SST studs/nuts	

### Alternate pressure tap type

Code	Description	
ST	Socketweld pressure taps	

### Special cleaning

Code	Description	
P2	Cleaning for special processes	

### Special inspection

Code	Description	
QC1	Visual and dimensional inspection with certificate	★

### Material traceability certification

Code	Description	
Q8	Material traceability certification per EN 10204:2004 3.1	★

### Code conformance

Materials of construction comply with metallurgical requirements highlighted within NACE MR0175/ISO 15156 for sour oil field production environments. Environmental limits apply to certain materials. Consult latest standard for details. Selected materials also conform to NACE MR0103 for sour refining environments.

Code	Description	
J5	Certificate of Compliance to NACE MR0175/ISO 15156 for wetted materials	★

### Country certification

Code	Description	
J1	Canadian Registration	
J6	European Pressure Directive (PED)	

# Specifications

## Functional specifications

### Rosemount 1495 Orifice Plate

#### Service and flow range

Liquid, gas or vapor turbulent flow, for pipe Reynold's numbers greater than the following<sup>(18)</sup>

- AGA-3: 4,000
- ASME MFC-3M<sup>(19)</sup>: 5,000 and  $170\beta^2 D$  (whichever is higher)
- ISO-5167<sup>(19)</sup>: 5,000 and  $170\beta^2 D$  (whichever is higher)

### Rosemount 1496 Orifice Flange Union

#### Orifice flange operating limitations

**Table 81: Temperature Limit for Raised Face Flanges (Based on Gasket Material)**

Flange rating	Applicability	Gasket description	Temperature rating
Class 300 PN 10/16/25/40	Default	Compressed sheet gasket material, 1/16-in. thick, aramid and inorganic fibers in nitrile rubber binder.	-100 to 250 °F (-73 to 121 °C)
	If "P2" option	Compressed sheet gasket material, 1/16-in. thick, PTFE with inorganic filler.	-350 to 250 °F (-212 to 121 °C)
	If "G1" option	Spiral wound gasket per ASME B16.20, 0.175-in. uncompressed thickness, high temperature filler, inner ring. wetted material to equal or exceed flange material.	-350 to 1250 °F <sup>(1)</sup> (-212 to 677 °C)
Class 600, 900, 1500, 2500 PN 63/100	Default	Spiral wound gasket per ASME B16.20, 0.175-in. uncompressed thickness, flexible graphite filler, inner ring. wetted material to equal or exceed flange material.	-350 to 900 °F (-212 to 482 °C)
	If "P2" option	Spiral wound gasket per ASME B16.20, 0.175-in. uncompressed thickness, PTFE filler, inner ring. wetted material to equal or exceed flange material.	-300 to 500 °F (-184 to 260 °C)

(18) For flange tap applications.

(19) D = pipe I.D. in mm.  $\beta$  = Beta ratio.

**Table 81: Temperature Limit for Raised Face Flanges (Based on Gasket Material) (continued)**

Flange rating	Applicability	Gasket description	Temperature rating
	If "G1" option	Spiral wound gasket per ASME B16.20, 0.175-in. uncompressed thickness, high temperature filler, inner ring. wetted material to equal or exceed flange material.	-350 to 1250 °F <sup>(1)</sup> (-212 to 677 °C)

(1) *Dependent on flange material.*

### Maximum working pressure

Per ASME B16.36 and B16.5 for types WN, SO, TH, and RJ

Per EN-1092-1 for type DN

### Pipe sizes

2- to 24-in. (50 to 600 mm). Contact Emerson for pipe sizes less than 2-in. (50 mm) or greater than 24-in. (600 mm).

### Operating limits

**Table 82: Orifice Plate Temperature Range**

Rosemount 1495 material	Temperature rating
316/316L SST (ASTM A240 grade 316/316L)	-430 to 1000 °F (-257 to 538 °C)
304/304L SST (ASTM A240 grade 304/304L)	
DIN 1.4571 (316 Ti SS) ASTM A240 gr 316Ti (UNS S31635) (DIN material number 1.4571)	-325 to 1200 °F (-198 to 649 °C)
Alloy C-276 (ASTM B575 UNS N10276)	-325 to 1250 °F (-198 to 677 °C)
Alloy 400 (ASTM B127 UNS N04400)	-325 to 900 °F (-198 to 482 °C)

**Table 83: Orifice Flange Temperature Range (Based on Flange Material Rating per ASME B16.5)**

Rosemount 1496 material <sup>(1)</sup>	Temperature rating
CS (ASTM A105 <sup>(2)</sup> )	-20 to 800 °F (-29 to 427 °C)
316/316L SST (ASTM A182 F316/316L)	-325 to 1000 °F (-198 to 538 °C)
304/304L SST (ASTM A182 F304/304L)	
Alloy C-276 (ASTM B462 N10276)	-325 to 1250 °F (-198 to 677 °C)
Alloy 400 (ASTM B564 N04400)	-325 to 900 °F (-198 to 482 °C)
DIN 1.4571 (316Ti SST) (ASTM A182 F316Ti)	-325 to 1000 °F (-198 to 538 °C)

(1) *Depending on world area, flanges will conform to one or more of the listed material specifications.*

(2) *When the J6 option is selected, this material will be supplied as ASTM A350 LF2.*

## Physical specifications

### Rosemount 1495 Orifice Plate

#### Orifice bore sizes

Standard bore sizes are in 1/8-in. (3,2 mm) increments from 1/2-in. (12,7 mm) to 4-in. (101,6 mm) and in 1/4-in. (6,3 mm) increments from 4 1/4- to 6-in. (107,95 to 152,4 mm).

If required, Emerson can determine the orifice bore. Basic flow data is required at the time of order, see Calculation Data Sheet.

Bore tolerances are within AGA and ASME specifications. Available options allow the user to have the Rosemount 1495 sized for specific operating conditions. The [Rosemount 1495 Orifice Plate](#) specifies the physical parameters of the orifice from a detailed sizing calculation.

### Rosemount 1496 Orifice Flange Union

Standard flange styles are RF weld neck, RF slip-on, or RF threaded for paddle type orifice plates, and RTJ weld neck for universal type plates with plate holders. All flange unions are supplied with studs, nuts, jackscrews, gaskets, and pipe plugs.

- Meets ASME B16.36 (WN, RJ,SO and TH)
- Meets EN-1092-1 (DN)
- Threaded flange tap connection conforming to ISO-5167-2, ASME MFC-3M, and AGA-3 provided 180° apart

#### The following options are available.

- Socket weld tap connections
- SST flange bolting per ASTM A193 Grade B8M/A194 Grade 8M

#### Standard flange mounting hardware

- Studs: CS ASTM A193 Grade B7M
- Nuts: CS ASTM A194 Gr 2H
- Gaskets: Refer to [Table 81](#)
- Pipe plugs: Match flange material

#### Pressure taps

Pressure tap connections are 1/2-in. (12,7 mm) NPT and 180° apart as standard.

The tap hole diameter is 1/4-in. (6,35 mm) for 2-in. (51 mm) and 2 1/2-in. (63,5 mm) size, 3/8-in. (9,6 mm) for 3-in. (76,2 mm) size, and 1/2-in. (12,7 mm) for 4-in. (101,6 mm) and larger sizes.

## Relevant documents

### Rosemount 485, 2051CFA, 3051CFA, 3051SFA Annubar™ Primary Element and Flow Meters

<b>Reference manual</b>	<a href="#">Rosemount Annubar Flow Meter Series</a>
<b>Quick start guide</b>	<ul style="list-style-type: none"> <li>▪ <a href="#">Rosemount 485 Annubar Flanged Assembly</a></li> <li>▪ <a href="#">Rosemount 485 Annubar Pak-Lok Assembly</a></li> <li>▪ <a href="#">Rosemount 485 Annubar Flange-Lok Assembly</a></li> <li>▪ <a href="#">Rosemount 485 Annubar Flanged Flo-Tap Assembly</a></li> <li>▪ <a href="#">Rosemount 485 Annubar Threaded Flo-Tap Assembly</a></li> <li>▪ <a href="#">Rosemount 485 Annubar Threaded Assembly (China only)</a></li> </ul>
<b>Type 1 drawing</b>	<p>Sensor size 1</p> <ul style="list-style-type: none"> <li>▪ <a href="#">Flanged</a></li> <li>▪ <a href="#">Pak-Lok</a></li> <li>▪ <a href="#">Flange-Lok</a></li> <li>▪ <a href="#">Flanged Flo-tap and Threaded Flo-tap</a></li> <li>▪ <a href="#">Rosemount 3051SFA</a></li> </ul> <p>Sensor size 2</p> <ul style="list-style-type: none"> <li>▪ <a href="#">Flanged</a></li> <li>▪ <a href="#">Pak-Lok</a></li> <li>▪ <a href="#">Flanged-Lok</a></li> <li>▪ <a href="#">Flanged Flo-tap and Threaded Flo-tap</a></li> <li>▪ <a href="#">Rosemount 3051SFA</a></li> </ul> <p>Sensor size 3</p> <ul style="list-style-type: none"> <li>▪ <a href="#">Flanged</a></li> <li>▪ <a href="#">Pak-Lok</a></li> <li>▪ <a href="#">Flange-Lok</a></li> <li>▪ <a href="#">Flanged Flo-tap and Threaded Flo-tap</a></li> <li>▪ <a href="#">Rosemount 3051SFA</a></li> </ul>
<b>Rosemount 486 Mounting hardware</b>	<a href="#">Flanged</a>

### Rosemount 405, 2051CFC, 3051CFC, 3051SFC Compact Primary Element and Flow Meters

<b>Reference manual</b>	<a href="#">Rosemount Compact Flow Meters</a>
<b>Quick start guide</b>	<a href="#">Rosemount 405 Compact Primary Element</a>
<b>Type 1 drawing</b>	<a href="#">Rosemount 405 Compact Flow Meter and Primary Element</a>

## Rosemount 1195, 2051CFP, 3051CFP, 3051SFP Integral Orifice Primary Element and Flow Meters

- Reference manual [Rosemount Integral Orifice Flow Meter Series](#)
- Quick start guide [Rosemount 1195 Integral Orifice Assembly](#)
- Type 1 drawing [Rosemount 1195 Flow Meter and Primary Element](#)

## Rosemount 1595 Conditioning Orifice Plate

- Reference manual [Rosemount 1595 Conditioning Orifice Plate](#)
- Quick start guide [Rosemount 1595 Conditioning Orifice Plate](#)
- Type 1 drawing
  - [ANSI Paddle](#)
  - [DIN Paddle](#)
  - [RTJ \(Integral handle\)](#)
  - [Universal](#)

## Rosemount 585 Annubar Primary Element for Severe Service

- Reference manual [Rosemount Annubar Flow Meter Series](#)
- Quick start guide
  - [Rosemount 585 Annubar Flanged Assembly](#)
  - [Rosemount 585 Annubar Flanged Flo-Tap Assembly](#)
  - [Rosemount 585 Main Steam Annubar with Opposite Side Support](#)
- Type 1 drawing
  - [Flanged](#)
  - [Flo-tap](#)
  - [MSL \(Main Stream Line\)](#)

## Rosemount 1495 Orifice Plate and 1496 Orifice Flange Union

- Reference manual [Rosemount 1495 Orifice Plate, 1496 Orifice Flange Union](#)
- Quick start guide [Rosemount 1495 Orifice Plate, Rosemount 1496 Orifice Flange Union](#)
- Type 1 drawing
  - [Rosemount 1496](#)
  - [Rosemount 1495 Universal](#)
  - [Rosemount 1495 Paddle](#)
  - [Rosemount 1495 Paddle Spiral Finish](#)

## Rosemount 9295 Process Flow Meter

- Product data sheet [Rosemount 9295 Process Flow Meter](#)
- Quick start guide [Rosemount 9295 Process Flow Meter](#)
- Type 1 Drawing [Rosemount 9295 Process Flow Meter](#)



For more information: [Emerson.com/global](https://emerson.com/global)

©2024 Emerson. All rights reserved.

Emerson Terms and Conditions of Sale are available upon request. The Emerson logo is a trademark and service mark of Emerson Electric Co. Rosemount is a mark of one of the Emerson family of companies. All other marks are the property of their respective owners.

The "Bluetooth" word mark and logos are registered trademarks owned by Bluetooth SIG, Inc. and any use of such marks by Emerson is under license.

**ROSEMOUNT™**

