



**Badger Meter**

# Industrial Flow Computer

FC-5000 BTU Monitor

## DESCRIPTION

The Badger Meter® FC-5000 is a microprocessor-driven device designed for energy/BTU and flow monitoring. The FC-5000 BTU Monitor is compatible with the complete line of Badger Meter industrial flow meters and temperature sensors, creating a solution to monitor hydronic energy usage, flow rate and totals. Many years of experience in the industrial market has allowed Badger Meter to incorporate features indispensable in control operations.

Features	Benefits
Large, backlit graphical display	Provides enhanced viewing capabilities, near and far from the device
Integrated softkeys and full numerical keypad	Promotes intuitive navigation and programming
Sensor data display screen	Allows user to view raw and calculated flow data, both to and from the device, including flow data, energy usage and temperature readings. Additionally, users can see relay, output and digital I/O statuses
Plug-and-play terminals	Provides easier, user-friendly installation
User-programmable relay configuration	Enables alarms or totalizing output capabilities for rates, totals and temperatures
User-programmable scaled outputs	Outputs transmit rate, total or temperature data via dedicated output channels
Robust enclosure, keypad and mechanical relays	Provides application ruggedness

## PROGRAMMABILITY

Features	Programming Options
<b>Fluid Properties</b>	Custom fluid characteristics can be stored for calculations and reference.
<b>Digital I/O</b>	Ability to reset relays, totals or both remotely via the 6 available I/O ports.
<b>Scaled Outputs</b>	Fully configurable outputs that can be assigned to rates, totals and temperature.
<b>Relay Outputs</b>	Fully configurable relays that can be assigned to rates, totals and temperature as either a totalizing output or alarm indication. Option to enable/disable latching functionality.
<b>Display Properties</b>	Adjustable contrast and brightness for readability and controlling power consumption.
<b>Stored or Custom Units of Measure</b>	Ability to select from a list of standardized units of measure, or complete the customized option with labels and quantity assignments.
<b>Passcodes</b>	User-defined passcodes to manage advanced configuration parameters and reset functions.
<b>Sensor Inputs</b>	Provides accurate and fast programming of flow and temperature sensors with preprogrammed selection lists.



## OPERATION

Input signal—in the form of sine waves or pulses from open collector transistors or dry contact closures—can be scaled to any unit of measure for totalization and instantaneous rate-of-flow indication. Energy rate and flow totals are examples of parameters that can be viewed on the panel display or through communications protocols such as BACnet or Modbus.

Two temperature sensor inputs can be configured to read RTDs or thermistors and are fully customizable to adapt to application needs. When used in conjunction with fluid flow, hydronic energy rates and total usage are achieved, while conforming to EN1434 standards.

Additionally, dedicated analog or frequency output channels provide scaled outputs that are assignable to parameters such as energy rate, total and temperature. A user defined damping function can be applied for improved stability of the flow readings.

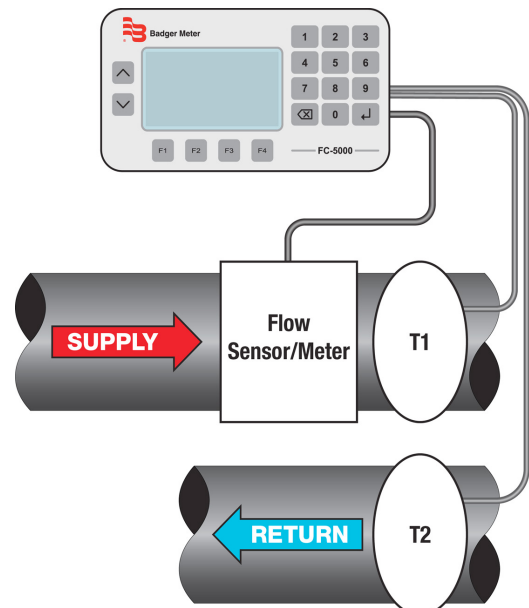

**FLEXIBILITY**

- Non-volatile memory preserves all configured settings and totalization values during power failure
- Low voltage AC/DC power
- Dynamic menu selection and programming reduces potential programming errors
- Ability to restore to factory programmed settings

**VIEWING CAPABILITIES**

Quickly toggle views on the Home screen to switch between:

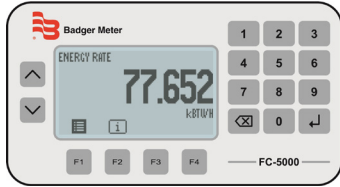

Figure 1: Single display

- Flow Rate
- Flow Total
- Energy/BTU Rate
- Energy/BTU Total

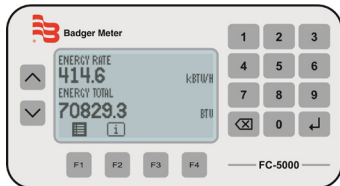

Figure 2: Dual display

- Flow Rate and Flow Total
- Energy/BTU Rate and Energy/BTU Total

**ACCESSORIES**

**RTDs**

Part No.	Description
8RTD100	Replacement RTD Element
8RTD106B	1/4 in. NPT; BR; ADJ Depth; 6 in. Leads
8RTD116B	3/4 in. NPT; BR TW; 1-5/8 in. Depth; 1/2 in. Conduit Conn.
8RTD116S	3/4 in. NPT; SS TW; 1-5/8 in. Depth; 1/2 in. Conduit Conn.
8RTD125	3/4 in. NPT; SS TW; 2-1/2 in. Depth; 1/2 in. Conduit Conn.
8RTD140	3/4 in. NPT; SS TW; 4 in. Depth; 1/2 in. Conduit Conn.
8RTD160	3/4 in. NPT; SS TW; 6 in. Depth; 1/2 in. Conduit Conn.

Table 1: RTD part numbers

**Thermistors**

Part No.	Description
8T106B	1/4 in. NPT; BR Thermistor; ADJ Depth
8T106S	1/4 in. NPT; SS Thermistor; ADJ Depth
8T116B	3/4 in. NPT; BR Thermowell; 1-5/8 in. Depth
8T116S	3/4 in. NPT; SS Thermowell; 1-5/8 in. Depth
8T125	3/4 in. NPT; SS Thermowell; 2-1/2 in. Depth
8T140	3/4 in. NPT; SS Thermowell; 4 in. Depth
8T160	3/4 in. NPT; SS Thermowell; 6 in. Depth
8T180	3/4 in. NPT; SS Thermowell; 8 in. Depth
67002	Replacement Thermistor Element

Table 2: Thermistor part numbers

Consult the factory or your local representative for availability, pricing and delivery estimates for additional parts and accessories.

**EIA-485 (RS-485) NETWORK**

All FC-5000 BTU Monitors come equipped with an EIA-485 (RS-485) physical layer, and use BACnet or Modbus RTU protocols, selectable and programmed in the firmware. Up to 255 FC-5000 products can be run on a single daisy-chain network and be individually queried for flow/energy rate, positive flow/energy accumulator, supply temperature, return temperature and other information.

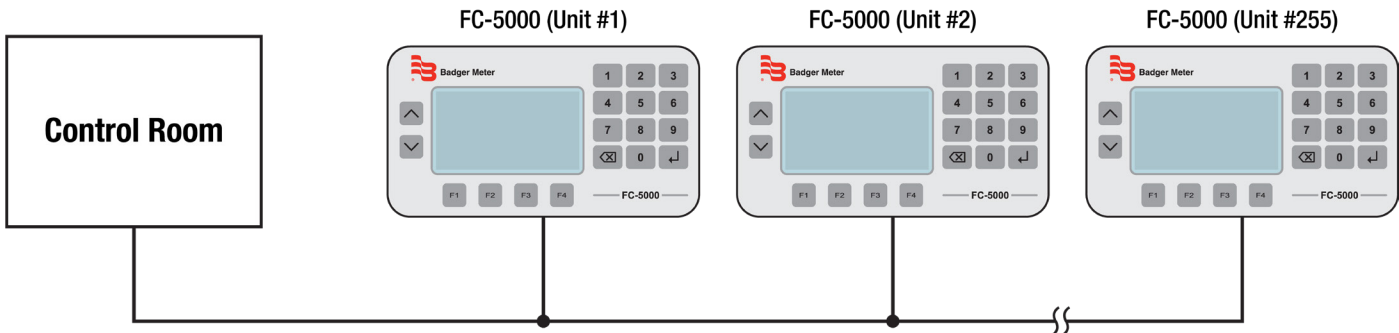
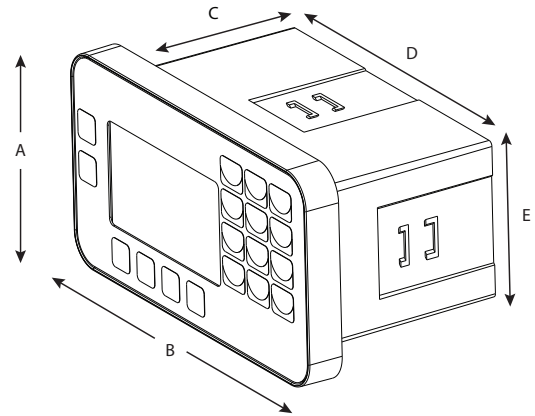
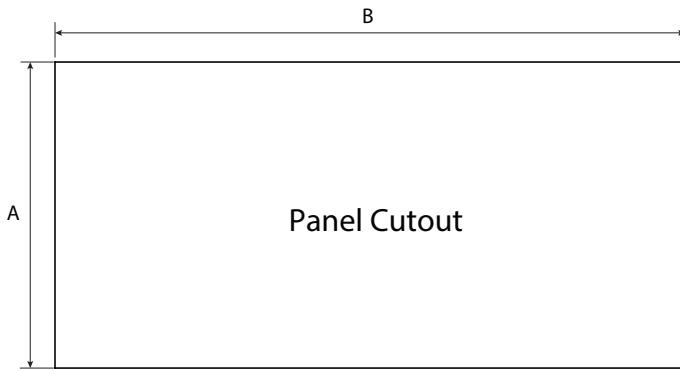

Figure 3: Daisy-chained units

## DIMENSIONS

### Panel Mount Unit

Mounting clips can accommodate a maximum panel thickness of 1.5 in (38.1 mm).



### Wall Mount Unit

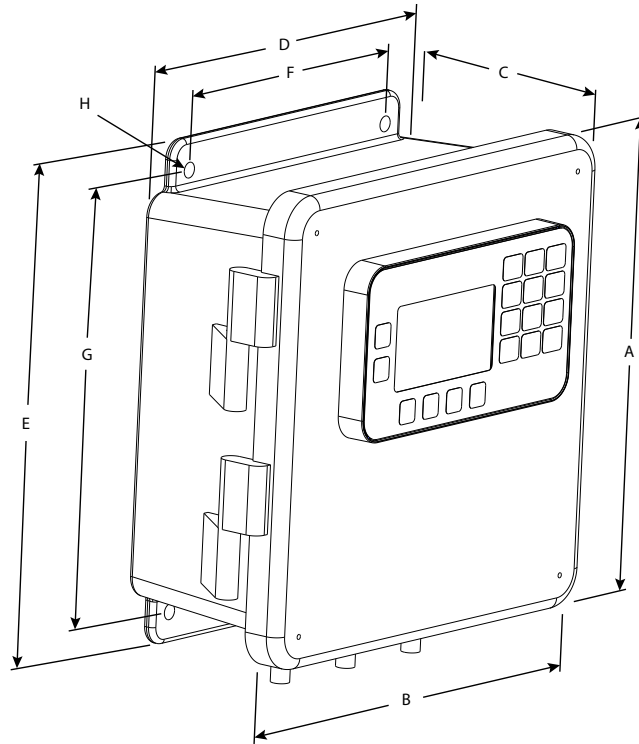

	A	B	C	D	E	F	G	H
	Height in. (mm)	Width in. (mm)	Depth in. (mm)	Width in. (mm)	Height in. (mm)	Width in. (mm)	Height in. (mm)	Hole Dia. in. (mm)
Panel Cutout	2.65 (67.31)	5.40 (137.16)	—	—	—	—	—	—
FC-5000 Unit	3.50 (89.00)	6.22 (158.00)	3.07 (78.00)	5.38 (136.65)	2.54 (64.52)	—	—	—
Wall Mount Unit	9.38 (238.25)	9.38 (238.25)	4.88 (123.95)	8.00 (203.20)	9.56 (242.83)	6.00 (152.40)	8.75 (222.25)	0.31 (7.87)

**SPECIFICATIONS**

<b>Power Supply</b>	Input range: 10...40V DC and 9...28V AC RMS (50...60 Hz)		
	Maximum power consumption: 8 Watts (power supply must provide 8 watts at minimum)		
	Isolated from power ground		
	Over-voltage, transient and reverse polarity protected		
<b>Flow Meter Input</b>	Input Range: 0.3 Hz...10 kHz		
	One (1) independent channel		
	Configurable as square wave 0...30V pulse with 2.5V threshold		
	Configurable as sine wave, zero-centered with 45 mV threshold		
	Configurable debounce		
	<b>Excitation Output</b>	12V DC source	
	<b>Voltage</b>	Low: -0.3...1.85V DC	
		High: 2.5...25V DC	
	<b>Impedance</b>	Pullup to 12V DC	
	<b>VDC Current</b>	±50 mA, short circuit current	
<b>Response</b>	100 µs/3.5 ms min pulse (high/low speed)		
<b>Temperature Inputs</b>	Two (2) independent channels		
	<b>RTD Specifications</b>	50 µA/1000 µA Excitation current source	
		2, 3 and 4-wire compatible	Platinum, 100 and 1000 Ohm RTDs Optional two-point or customizable calibration configuration
		Callendar-Van Dusen coefficients	
	<b>Thermistor Specifications</b>	Type II Thermistors or customizable calibration configuration	
Steinhart-Hart coefficients			
<b>Scaled Outputs</b>	Two (2) independent channels		
	Isolated from power ground		
	Over-voltage, transient and reverse polarity protected		
	Output is multiplexed on the process out pins		
	<b>Analog Output (option A)</b>	Configurable to 0...5V, 0...10V or 4...20 mA	
		Uncertainty: ±0.1% of reading	
		16-bit resolution (0...10V and 4...20 mA), 15-bit resolution (0...5V)	
		200 ms, 90-10% step response	
		Sourcing analog output signal	
	<b>Frequency Output (option F)</b>	TTL, 1...4000 Hz, square wave	
Uncertainty: ±0.01% reading			
Resolution: 0.01 Hz			
<b>Digital I/O</b>	Six (6) independent channels		
	Isolated from power ground		
	Over-voltage, transient and reverse polarity protected		
	0...30V as input		
	Debounce		
	0...5V, TTL, 200 ms 90-10% step response, driving < 0.1 uF		
<b>Calculations</b>	<b>Flow Calculation</b>	Uncertainty: ± 0.01%	
		Adjustable FIR/IIR filtering	
	<b>BTU Calculation</b>	Meets EN 1434 requirements	

Relay Outputs	Configuration Option "C"	Two (2) Form C Mechanical Relays	
	Configuration Option "A"	One (1) Form C Mechanical Relay and One (1) Form A Solid State Relay	
	Isolated coil drivers		
	Over-voltage, transient and reverse polarity protected		
	Form C Relay	<b>Load</b>	Resistive
		<b>Rated Carry Current</b>	5 A (N.C. or N.O.)
		<b>Maximum Switching Voltage</b>	250V AC, 30V DC
		<b>Minimum Permissible Load</b>	10 mA at 5V DC
		<b>Coil Rating</b>	5...24V DC
		<b>Life Expectancy</b>	5,000,000 operations
	Form A Relay (N.O. SPST)	<b>Switching Speed</b>	On (0.25 ms), Off (0.02 ms)
		<b>Current Rating (I<sub>o</sub>)</b>	1 A
		<b>Maximum Output Voltage (V<sub>o</sub>)</b>	60V
<b>Output Withstand Voltage (V<sub>o(off)</sub>)</b>		60-65V @ V <sub>F</sub> = 0.8V, I <sub>o</sub> = 250 μA, T <sub>A</sub> = 77° F (25° C)	
Network Communications	<b>Network Types/Communication Protocols</b>	Modbus RTU, Modbus ASCII and BACnet	
	<b>Physical Layer</b>	EIA-485 (RS-485)	
	<b>Baud Rates</b>	1200...115.2K	
	4-wire interface/half duplex		
	Over-voltage/ESD Protection		
	Isolated from power ground		
USB Communications	<b>USB (HOST)</b>	Type-A Receptacle   Currently not supported	
	<b>USB (DEVICE)</b>	Mini-B Receptacle (used for field updates)	
	Over-voltage/ESD/transient protected		
Display/User interface	<b>Keypad</b>	Membrane overlay, domed tactile response keys	
	<b>Display</b>	128 × 64 pixel LCD graphical display, LED backlit	
	Protected from EMI/RFI		
	Keypad interface is protected from ESD		
Environmental Ratings	<b>Pollution Degree</b>	2	
	<b>Altitude Restriction</b>	Up to 2000 m (6561 ft)	
	<b>Over-Voltage Rating</b>	Category II (CAT II)	
	<b>Ambient Temperature Range</b>	32...130° F (0...55° C)	
	<b>Storage Temperature Range</b>	-40...160° F (-40...70° C)	
	<b>Humidity</b>	0...85%, non-condensing	
Weights (Approx.)	<b>Panel Mount</b>	1.25 lb (0.57 kg)	
	<b>Wall Mount (Including Unit)</b>	4.54 lb (2.06 kg)	
Operator Functions	Unlatch Relays, Reset Totalizers, Unlatch Relays and Reset Totalizers		
Parameters	<b>Maximum Displayed Digits</b>	<b>Rates:</b> Max 8 (7 with decimal)	
		<b>Totals:</b> Max 9 (8 with decimal)	
	<b>Resolution/Display Precision</b>	Configurable, 0...4	
	<b>Volumetric Flow Rate Units Seconds (S), Minute (MIN), Hour (H), Day (D)</b>	US Gallons (US GAL), Imperial Gallons (I GAL), Mega US Gallons (US MGAL), Mega Imperial Gallons (I MGAL), Liters (L), Mega Liters (ML), Cubic Meters (M <sup>3</sup> ), Cubic Feet (FT <sup>3</sup> ), Acre Feet (AC-FT), Oil Barrels (OBBL), Liquid Barrels (LBBL), US Ounces (US OZ), Imperial Ounces (I OZ), Custom (user-specified)	
	<b>Volumetric Flow Total Units</b>	US Gallons (US GAL), Imperial Gallons (I GAL), Mega US Gallons (US MGAL), Mega Imperial Gallons (I MGAL), Liters (L), Mega Liters (ML), Cubic Meters (M <sup>3</sup> ), Cubic Feet (FT <sup>3</sup> ), Acre Feet (AC-FT), Oil Barrels (OBBL), Liquid Barrels (LBBL), US Ounces (US OZ), Imperial Ounces (I OZ), Custom (user-specified)	
	<b>Energy Units</b>	kBTU, BTU, KW, TONS (RT), Custom (user-defined)	
<b>Temperature Units</b>	° F (Fahrenheit), ° C (Celsius), R (Rankine) or K (Kelvin)		

**PART NUMBERING CONSTRUCTION**

**Badger Meter**

FC-5000 BTU Monitor



**FUNCTION**

BTU Monitor

BM

**SENSOR INPUTS**

One Pulse / Two Temperature

P1

**SCALED OUTPUTS**

Two Analog Outputs

A

Two Frequency Outputs

F

**RELAY OUTPUTS**

One Form C Relay / One Form A Relay

A

Two Form C Relays

C

**DIGITAL INPUTS/OUTPUTS**

Six Programable Inputs/Outputs

6

**COMMUNICATIONS**

EIA-485(RS-485); Modbus; BACnet; USB

A

**MOUNTING METHOD**

Panel Mount

P

Wall Mount | Includes NEMA 4X (IP67) Rated Enclosure

W

**INTENTIONAL BLANK PAGE**

## Control. Manage. Optimize.

Trademarks appearing in this document are the property of their respective entities. Due to continuous research, product improvements and enhancements, Badger Meter reserves the right to change product or system specifications without notice, except to the extent an outstanding contractual obligation exists. © 2019 Badger Meter, Inc. All rights reserved.

[www.badgermeter.com](http://www.badgermeter.com)

---

The Americas | **Badger Meter** | 4545 West Brown Deer Rd | PO Box 245036 | Milwaukee, WI 53224-9536 | 800-876-3837 | 414-355-0400  
México | **Badger Meter de las Americas, S.A. de C.V.** | Pedro Luis Ogazón N°32 | Esq. Angelina N°24 | Colonia Guadalupe Inn | CP 01050 | México, DF | México | +52-55-5662-0882  
Europe, Eastern Europe Branch Office (for Poland, Latvia, Lithuania, Estonia, Ukraine, Belarus) | **Badger Meter Europe** | ul. Korfantego 6 | 44-193 Knurów | Poland | +48-32-236-8787  
Europe, Middle East and Africa | **Badger Meter Europa GmbH** | Nurtinger Str 76 | 72639 Neuffen | Germany | +49-7025-9208-0  
Europe, Middle East Branch Office | **Badger Meter Europe** | PO Box 341442 | Dubai Silicon Oasis, Head Quarter Building, Wing C, Office #C209 | Dubai / UAE | +971-4-371 2503  
Slovakia | **Badger Meter Slovakia s.r.o.** | Racianska 109/B | 831 02 Bratislava, Slovakia | +421-2-44 63 83 01  
Asia Pacific | **Badger Meter** | 80 Marine Parade Rd | 19-07 Parkway Parade | Singapore 449269 | +65-63464836  
Switzerland | **Badger Meter Swiss AG** | Mittelholzerstrasse 8 | 3006 Bern | Switzerland | +41-31-932 01 11