





OPTIFLUX 1000 SW

Electromagnetic flow sensor in sandwich design

-  Installation, assembly, start-up and maintenance may only be performed by appropriately trained personnel.
-  This instrument complies with requirements of Low Voltage Directive. Instruments must not be connected to power supply before reading instructions described in the manual.
-  This instrument complies with the requirements of Pressure Equipment Directive. Please refer to the nameplate for operating condition limits. Instruments must not be pressurised before reading instructions described in the manual.
-  The responsibility as to the suitability, intended use and corrosion resistance of the used materials against the measured fluid of this device rests solely with the operator.

 For use in hazardous areas, special codes and regulations are applicable. Instruments must not be connected to power supply before reading instructions described in the supplementary manual.

Special conditions to be observed

- Installation and connection of the flowmeter must be realized conform standard EN IEC 60079-14 ("Electrical Installations in hazardous areas, other than mines") or equivalent national standard.
- Refer to: Supplement to the Quick Start for category 3 apparatus (Ex zone 2)

1 Installation

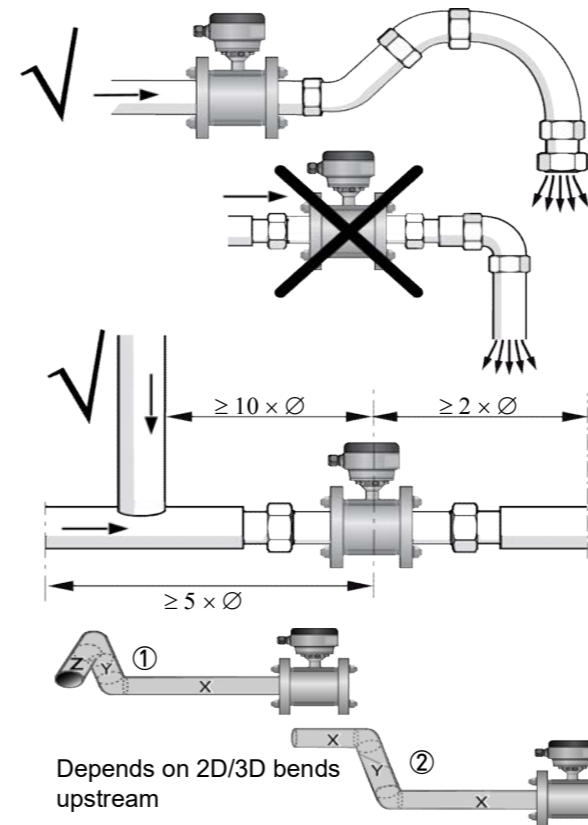



Depends on 2D/3D bends upstream

Inlet length:

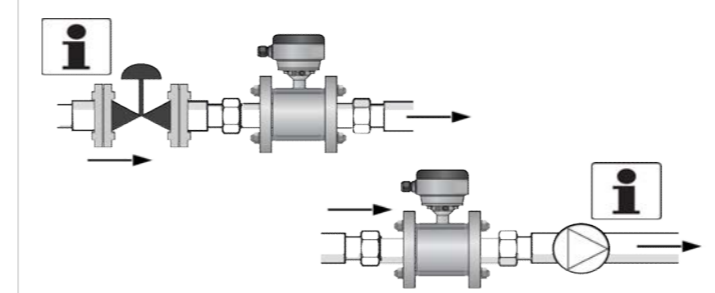
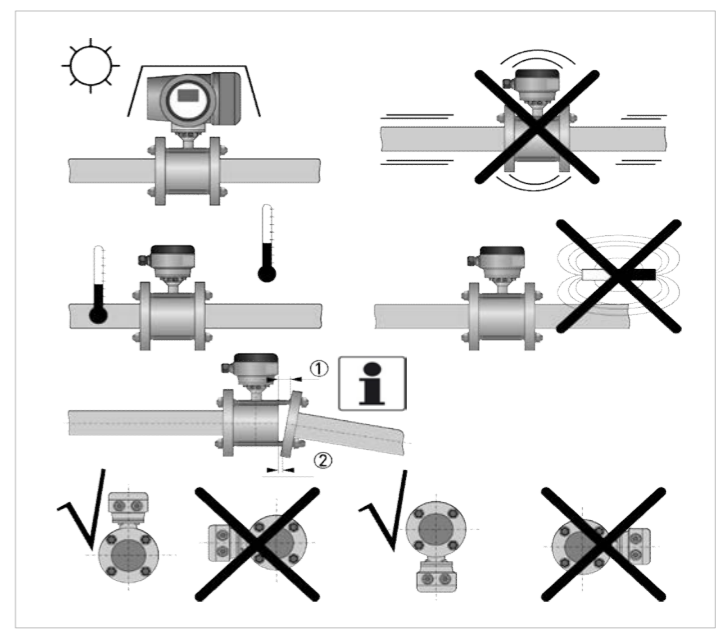
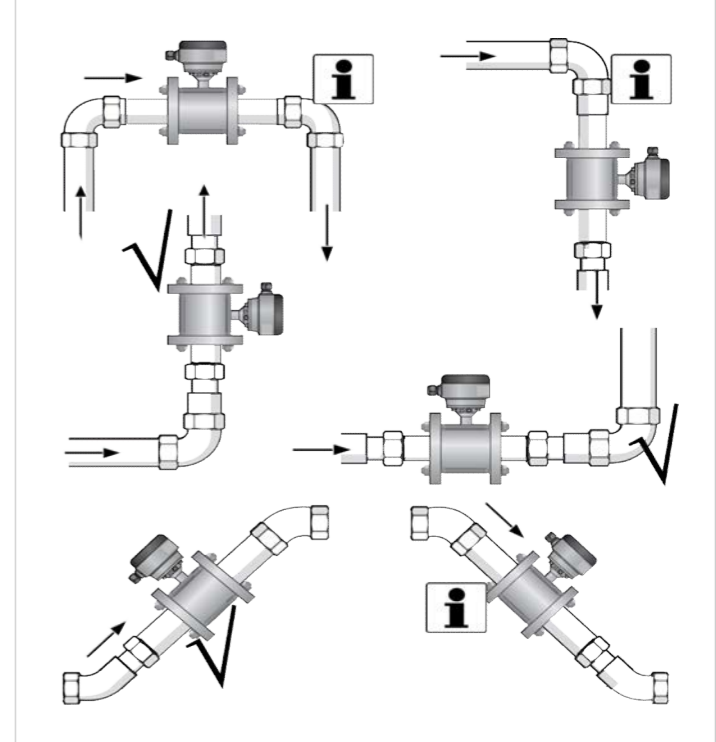
- ① XYZ (3D bends upstream) = 10 DN
- ② XY (2D bends upstream) = 5 DN



 Check the manual for more details on installation options.

 Avoid the risk of ignition as a result of electrostatic charging. Do not use the device in areas, with processes that generate high charges, with mechanical friction and cutting process, near electrostatic painting systems (spraying of electrons), with exposure of airborne powder or dust particles (pressurized systems).

General





Check for damage

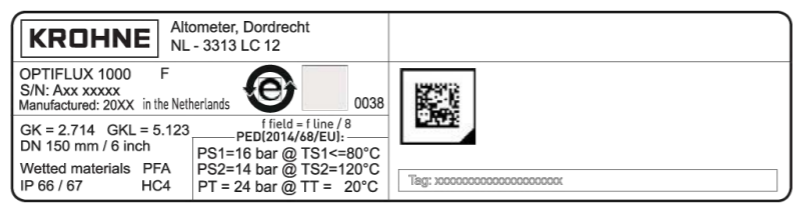

Maximum ambient and process temperatures are depending on version (e.g liner material, size), temperature and protection class and maximum surface temperature of sensor.

Device nameplate (example)



 Check the device nameplate to ensure that the device is delivered according to your order.
Check the Ex data on nameplate in case of an Ex version (if applicable)

Device version(s) (example)

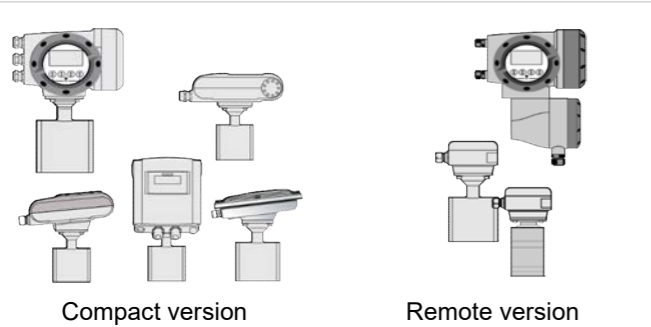

Transport

- No special requirements
- Use the original packing of the device(s) when transporting to the installation location.

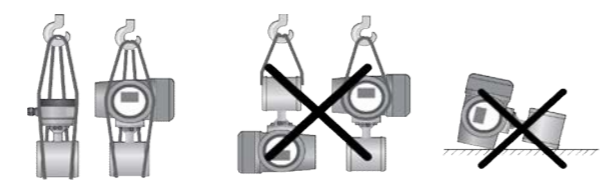

2 Electrical connection



All work on the electrical connections may only be carried out with the power disconnected. Take note of the voltage data on the nameplate! Observe the national regulations for electrical installations!



For devices used in hazardous areas, additional safety notes apply; please refer to the Ex documentation. Refer to the manual for connection of Ex (i) acc. to NAMUR.



Observe without fail the local occupational health and safety regulations. Any work done on the electrical components of the measuring device may only be carried out by properly trained specialists.

Grounding



The device must be grounded in accordance with regulations in order to protect personnel against electric shocks.

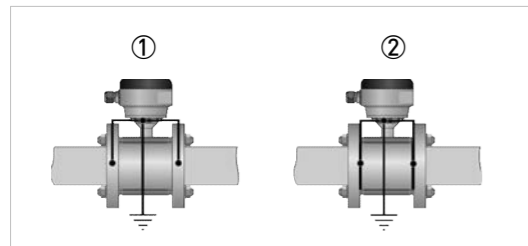

- ① Metal pipelines, without a lining. Ground the device without grounding rings!
- ② Metal pipelines with a lining and non-conductive pipelines. Ground the device with grounding rings!

Virtual reference

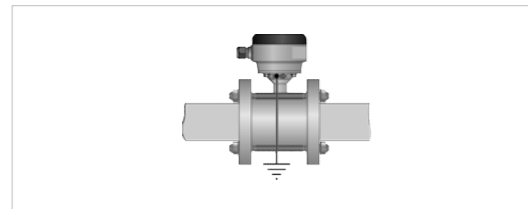

Minimum requirements

- Nominal diameter: \geq DN10 / 3/8"
- Electrical conductivity: \geq 200 μ S/cm
- Electrode cable, type DS: max. 50 m / 164 ft

Only for signal converter: IFC 300

3 Quick Setup



For the start up and menu description please refer to the manual of the applicable signal converter. For the connection diagrams please refer to the applicable manual.

Download documents/software

Scan the code on the nameplate or scan the following code and enter the serial number.



Contact

Select your country from the region / language selector to view your local KROHNE contact details on:

www.krohne.com