

# Micro Motion<sup>®</sup> Model 5700 Transmitters with MVD<sup>™</sup> Technology



## Repeatable, reliable, accurate measurements

- Faster processing speed delivers the best response even in the most challenging applications such as meter proving, filling & dosing, and batching
- Smart Meter Verification provides you with the confidence you need in your meter performance
- Zero verification confirms the calibration and indicates when it's time to re-zero the meter
- Approved for custody transfer and certified for SIL2 and SIL3, which provides measurement confidence and reliability

## A window into your process

- Easy access to detailed measurement history gives you valuable insight into your process for better troubleshooting and optimization
- Real-time indication of multi-phase flow events allow for greater process control
- High-accuracy density measurement reduces or eliminates waste in your process while the embedded historian records upsets and process deviations

## Productivity through simplified solutions

- Designed to minimize the time and expertise needed to install and operate the flowmeter
- Up to five fully configurable input/output channels that can be easily upgraded with changing needs
- Ethernet version includes multiple protocols on dual channels, plus a configurable I/O channel
- FOUNDATION<sup>™</sup> Fieldbus version includes IEC-61158-2 FOUNDATION Fieldbus output, a fixed mA output channel, and a configurable frequency / discrete output channel.
- Offline configuration and auditing through new file shuttling capability

## Micro Motion Model 5700 transmitters

Model 5700 transmitters deliver the best measurement technology and offer unparalleled support – ensuring total measurement confidence, valuable process insight and greater operational efficiency. These transmitters provide the scalability, compatibility and performance that your application demands.

### Simplified installation and commissioning

An intuitive interface, spacious side-access wiring compartment and convenient mounting brackets.



### Smart Meter Verification: advanced diagnostics for your entire system

Our online tool verifies that your meter performs as well as the day it was installed, giving you assurance in less than 90 seconds.



### Measurement history for easier troubleshooting and optimization

Detailed history files deliver key time-stamped information about your process from configuration changes and alerts to process events and statistics.

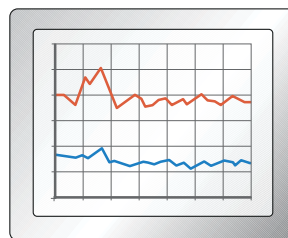

**Unmatched system connectivity and services interfaces**

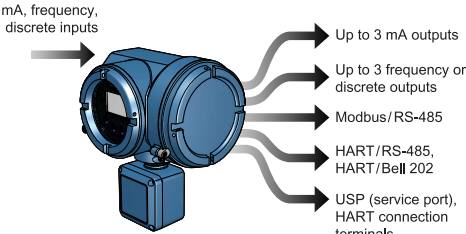
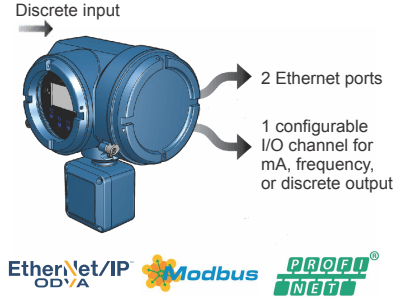
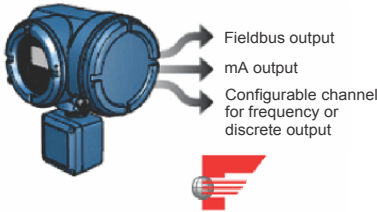
<p>Configurable I/O version</p>	<p>Up to five fully configurable I/O channels with multiple mA, discrete and frequency outputs, and several powerful service interfaces.</p> 
<p>Ethernet version</p>	<p>Two Ethernet outputs with EtherNet/IP, Modbus TCP, or PROFINET – plus one configurable output.</p> 
<p>Fieldbus version</p>	<p>Fieldbus output, mA output, and a configurable channel for frequency or discrete output.</p> 

# Model 5700 enhancements

## Internal memory

The Model 5700 transmitter provides a backup of:

- Transmitter configurations
- Meter verification baseline and history
- Data log
- Licensing key

If you need to replace your transmitter, move your old memory to the new transmitter without losing any data or licensing information.

## Software licensing

Software licensing makes it possible to:

- Purchase permanent features and add them later
- Trial features, such as concentration measurement, for 60 days before buying
- Order up to five input/output channels through the license

## Large graphical display

- Supports multiple languages
- Supports full configuration capabilities directly from the display
- Provides understandable alert codes

## Two-phase flow detection

Two-phase flow detection provides clear, concise information about fluid conditions, including notification about the following three fluid regimes:

- Single phase
- Moderate two-phase flow
- Severe two-phase flow

## Physical design

- Conduit and terminal compartments are accessible from the sides
- Modular board stack design
- Spacious wiring compartments
- Remote mounting bracket
- A Universal Service Port (USP) connects and transfers data using standard, easily available equipment

## Troubleshooting tools

The Model 5700 transmitter stores data in non volatile memory with Real Time Clock, including:

- Meter fingerprint
- Audit trail
- Alert log
- Long term data historian: 5-minute Min, Max, Avg, Std Dev (10 years)
- Short term data historian: 1-second data (30 days)

The Model 5700 transmitter contains descriptive alerts describing the issue and recommended steps for resolution.

- Follows NE 107 Standard

## Applications

Applications are custom designed programs and software that offer additional functionality and performance to transmitters. These applications are available through options in the transmitter model code, see the ordering information section for details.

### Smart Meter Verification

Provides a quick, complete assessment of a Micro Motion Coriolis meter, determining whether the meter has been affected by erosion, corrosion, or other influences affecting meter calibration. No secondary references are required to perform this operation, and the meter can continue normal process measurement while the test is in progress.

Smart Meter Verification Professional on the Model 5700 transmitter also offers coating detection, installation verification, detection of optimal flow range, and two-phase flow detection. A 90-day trial version is included with all Model 5700 transmitters with enhanced core processors. After the 90-day trial, a basic version of Smart Meter Verification will provide simple pass/fail results, and simple diagnostics that run without interrupting your processes.

### Discrete batch control

- Simple batch control based on totalizer values
- Frequency output configured as discrete output for transmitters with analog or intrinsically safe outputs
- Automatic overshoot compensation
- Single and dual stage batching available on the configurable I/O version when ordered with the Batching Software (BS) package option
- Batch ticket printing available if Channel E is enabled (supports Terminal Window, Generic, Epson TM88v, Epson TMU-295 and Digitec 6610A printers)

---

#### Note

Discrete batch control is not available with Model 5700 FOUNDATION Fieldbus models.

---

### Petroleum measurement and API correction option

- Accepts inputs from temperature and pressure devices
- Calculates values as per May, 2004 API Chapter 11.1
  - Relative density (specific gravity and API gravity) at reference temperature from observed density and temperature
  - Volume corrected to reference temperature and pressure
- Calculates flow-weighted average temperature and flow-weighted average observed density (specific gravity and API gravity)

**Concentration measurement**

Provides concentration measurement based on either industry-specific or liquid-specific units and relationships. Standard measurement options include:

- Industry-specific:
  - °Brix
  - °Plato
  - °Balling
  - °Baumé at SG60/60
  - Specific gravity
- Liquid-specific:
  - %HFCS
  - Concentration derived from reference density
  - Concentration derived from specific gravity

Additionally, the application can be customized for site-specific concentration measurement (such as %HNO<sup>3</sup>, %NaOH).

**Advanced Phase Measurement**

- Accurately measures liquid or gas flow in limited multiple-phase conditions
  - Immediate and continuous access to production or process data
  - Real time reporting of Gas Void Fraction (GVF)
- Facilitates reliable measurement at a fraction of the cost of true multi-phase meters
  - Historian automatically captures all production data
  - Little to no maintenance or calibration
- Combines with Net Oil Computer (NOC) or Concentration Measurement to measure two liquids in the presence of gas
  - Provides single well real-time Net Oil and Net Water measurements
  - Improves Concentration Measurement in processes with intermittent entrained gas

## Electrical connections

**Configurable I/O version**

Connection	Description
Input/Output	Up to five pairs of wiring terminals for transmitter I/O and communications
Power	<ul style="list-style-type: none"> <li>■ One pair of wiring terminals accepts AC or DC power</li> <li>■ One internal ground lug for power-supply ground wiring</li> </ul>
Sensor	<ul style="list-style-type: none"> <li>■ 4-wire remote mount – 4 terminals for connection to 4-wire sensor</li> <li>■ 9-wire remote mount – 9 terminals for connection to 9-wire sensor</li> </ul>
Service port (HART)	Two clips for temporary connection to the service port
Universal Service Port (USP)	A USP connected to commercially-available USB equipment and cables

**Ethernet version**

Connection	Description
Ethernet ports	Two Ethernet ports for EtherNet/IP, Modbus TCP, PROFINET, and web server connections
Input/Output	One configurable channel for mA output, frequency output, discrete output, or discrete input
Power	<ul style="list-style-type: none"> <li>■ One pair of wiring terminals accepts AC or DC power</li> <li>■ One internal ground lug for power-supply ground wiring</li> </ul>
Sensor	<ul style="list-style-type: none"> <li>■ 4-wire remote mount – 4 terminals for connection to 4-wire sensor</li> <li>■ 9-wire remote mount – 9 terminals for connection to 9-wire sensor</li> </ul>
Universal Service Port (USP)	A USP connected to commercially-available USB equipment and cables
Embedded web server	Connect to embedded web server via Ethernet connection for on-board configuration or data transfer

**FOUNDATION Fieldbus version**

Connection	Description
Input/Output	<ul style="list-style-type: none"> <li>■ One fixed channel for mA output</li> <li>■ One configurable channel for frequency output or discrete output</li> </ul> <p>These outputs are available as intrinsically safe, or non-intrinsically safe, based on the output option selected.</p>
Power	<ul style="list-style-type: none"> <li>■ One pair of wiring terminals accepts AC or DC power</li> <li>■ One internal ground lug for power-supply ground wiring</li> </ul>
Sensor	<ul style="list-style-type: none"> <li>■ 4-wire remote mount – 4 terminals for connection to 4-wire sensor</li> <li>■ 9-wire remote mount – 9 terminals for connection to 9-wire sensor</li> </ul>
Universal Service Port (USP)	A USP connected to commercially-available USB equipment and cables

**Note**

- Each screw terminal connection accepts one or two solid conductors, 24 to 12 AWG (0.20 to 3.3 mm<sup>2</sup>) or one or two stranded conductors, 22 to 14 AWG (0.38 to 2.3 mm<sup>2</sup>). Each plug type connector accepts one stranded or solid conductor, 24 to 12 AWG (0.20 to 3.3 mm<sup>2</sup>).
- For integral mount transmitters (mounting code I), the connection between the transmitter and the sensor is not normally accessed.

# Input/output signal detail

## Configurable I/O channels (output board code A)

Signal	Channel A		Channel B		Channel C		Channel D		Channel E	
Wiring terminals	1	2	3	4	5	6	7	8	9	10
mA inputs and outputs	mA Output 1 (HART)		mA Output 2		mA Output 3		mA Input		RS-485	
Frequency outputs			Frequency Output 2 <sup>(1)</sup>		Frequency Output 1		Frequency Output 2			
Discrete outputs			Discrete Output 1		Discrete Output 2		Discrete Output 3			
Discrete inputs					Discrete Input 1		Discrete Input 2			
Frequency inputs							Frequency Input			

(1) Frequency Output 2 can be mapped to Channel B or D. For multiple frequency outputs, use Frequency 1 on Channel C and Frequency 2 on either Channel B or D.

## Ethernet channels (output board code C)

Signal	Channel A	Channel B	Channel C
Channel options	EtherNet/IP <sup>(1)</sup>	EtherNet/IP	mA Output
	Modbus TCP	Modbus TCP	Frequency Output
	PROFINET	PROFINET	Discrete Output
			Discrete Input

(1) The same protocol must be ordered on both Channel A and B. ProLink III and the Integrated Webserver can always be connected to either Channel A or B.

## FOUNDATION Fieldbus channels (output board code E with intrinsically safe H1 outputs)

Signal	Channel A	Channel C	Channel D
Channel options	FOUNDATION Fieldbus (FISCO “ia” or FISCO “ic”)	IS mA Output	IS Frequency Output
			IS Discrete Output

## FOUNDATION Fieldbus channels (output board code N with H1 outputs)

Signal	Channel A	Channel C	Channel D
Channel options	FOUNDATION Fieldbus	mA Output	Frequency Output
			Discrete Output

## Channel A specifications

### Configurable I/O (output board code A)

Specification	mA output	mA output max loop resistance
Internal voltage (active power)	24VDC (nom)	820 ohm
External voltage (passive power)	30VDC (max)	1080 ohm @ 30VDC
Scalable range	4-20mA	
Downscale fault	Configurable from 1.0 – 3.6 mA, default value = 2.0 mA	
Upscale fault	Configurable from 21.0 – 23.0 mA, default value = 22.0 mA	
Linearity	0.015 % Span, Span = 16mA	

#### Note

mA output is linear with process from 3.8 to 20.5 mA, per NAMUR NE-43 (February 2003).

### Ethernet (output board code C)

Specifications:

- 10BASE-T
- 100BASE-TX

### FOUNDATION Fieldbus (output board code E)

Specifications:

- FOUNDATION Fieldbus H1 output
- Wiring is intrinsically safe with intrinsically safe power supply
- Transmitter fieldbus circuit is passive, and draws power from the fieldbus segment – current draw is 13 mA
- Manchester encoded digital signal conforms to IEC 61158-2

### FOUNDATION Fieldbus (output board code N)

Specifications:

- FOUNDATION Fieldbus H1 output
- FOUNDATION Fieldbus wiring is non-incendive
- Transmitter fieldbus circuit is passive, and draws power from the fieldbus segment – current draw is 13 mA
- Manchester encoded digital signal conforms to IEC 61158-2

## Channel B specifications

### Configurable I/O (output board code A)

Specification	mA output	mA output max loop resistance	Frequency output (2)	Discrete output (1)
Internal voltage (active power)	24VDC (nom)	820 ohm	24VDC (nom) 22mA sourcing	24VDC (nom) 7mA sourcing

Specification	mA output	mA output max loop resistance	Frequency output (2)	Discrete output (1)
External voltage (passive power)	30VDC (max)	1080 ohm @ 30VDC	30VDC (max) 500mA (max) sinking	30VDC (max) 500mA (max) sinking
Scalable range	4-20mA		0.01 Hz – 10 kHz	
Downscale fault	Configurable from 1.0 – 3.6 mA, default value = 2.0 mA		0Hz	
Upscale fault	Configurable from 21.0 – 23.0 mA, default value = 22.0 mA		Configurable from 10 Hz to 14.5 kHz, default value = 14.5 kHz	
Linearity	0.015 % Span, Span = 16mA		Output is linear with flow rate to 12.5 kHz	
Resolution			+/- 1 pulse	

**Ethernet (output board code C)**

Specifications:

- 10BASE-T
- 100BASE-TX

**FOUNDATION Fieldbus**

**Table 1: Output board code E**

Specification	mA Output	mA Output max loop resistance
External voltage (passive power)	30VDC (max) 10VDC (min)	869 ohms @ 30V
Scalable range	4-20mA	
Downscale fault	Configurable from 1.0 – 3.6 mA, default value = 2.0 mA	
Upscale fault	Configurable from 21.0 – 23.0 mA, default value = 22.0 mA	
Linearity	0.015 % Span, Span = 16mA	
Entity parameters	<ul style="list-style-type: none"> <li>■ Ui=30V</li> <li>■ li=484mA</li> <li>■ Pi=2.05W</li> <li>■ Ci=0.27nF</li> <li>■ Li=5uH</li> </ul>	

**Table 2: Output board code N**

Specification	mA Output	mA Output max loop resistance
External voltage (passive power)	30VDC (max) 10VDC (min)	869 ohms @ 30V
Scalable range	4-20mA	
Downscale fault	Configurable from 1.0 – 3.6 mA, default value = 2.0 mA	

**Table 2: Output board code N (continued)**

Specification	mA Output	mA Output max loop resistance
Upscale fault	Configurable from 21.0 – 23.0 mA, default value = 22.0 mA	
Linearity	0.015 % Span, Span = 16mA	

**Note**

- mA output is linear with process from 3.8 to 20.5 mA, per NAMUR NE-43 (February 2003).
- Fieldbus Channel B graph and equations

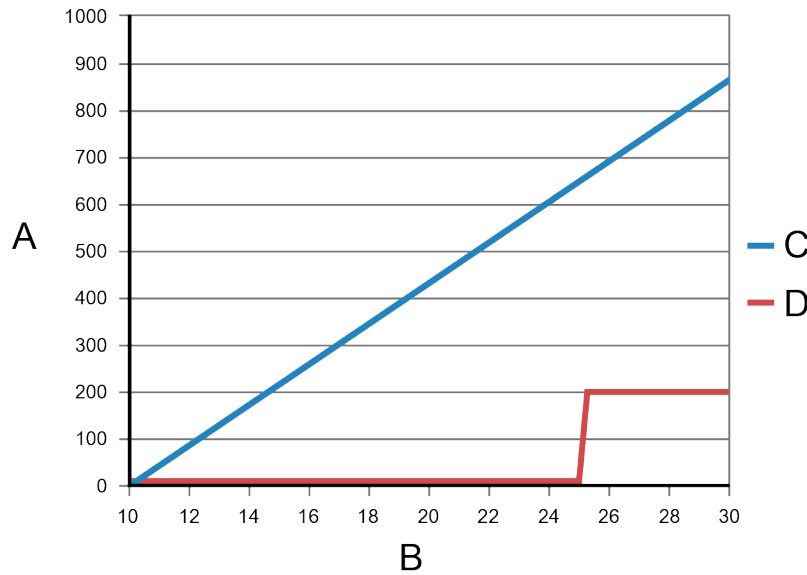

- A. Loop resistor (ohms)
- B. Supply voltage VDC (volts)
- C. Rmax = max value of loop resistor allowed
- D. Rmin = min value of loop resistance required

Loop Resistance Equation  
 $R_{max} = (V_{supply} - 10V) / 0.023$   
 $R_{min} = 0 \Omega, V_{supply} \leq 25V$   
 $R_{min} = 200 \Omega, V_{supply} > 25V$

**Channel C specifications**

**Configurable I/O (output board code A) and Ethernet (output board code C)**

Specification	mA output	mA output max loop resistance	Frequency output <sup>(1)</sup>	Discrete output <sup>(2)</sup>	Discrete input
Internal voltage (active power)	24VDC (nom)	820 ohm	24VDC (nom) 22mA sourcing	24VDC (nom) 7mA sourcing	24VDC (nom) 7mA sourcing
External voltage (passive power)	30VDC (max)	1080 ohm @ 30VDC	30VDC (max) 500mA (max) sinking	30VDC (max) 500mA (max) sinking	30VDC (max)

Specification	mA output	mA output max loop resistance	Frequency output <sup>(1)</sup>	Discrete output <sup>(2)</sup>	Discrete input
Scalable range	4-20mA		0.01 Hz – 10 kHz		
Downscale fault	Configurable from 1.0 – 3.6 mA, default value = 2.0 mA		0Hz		
Upscale fault	Configurable from 21.0 – 23.0 mA, default value = 22.0 mA		Configurable from 10 Hz to 14.5 kHz, default value = 14.5 kHz		
Resolution			+/- 1 pulse		
Linearity	0.015 % Span, Span = 16mA		Output is linear with flow rate to 12.5 kHz		
Maximum positive threshold					3VDC
Minimum negative threshold					0.6VDC

(1) Load resistor (500 Ω resistance recommended for 24V supply.) Use the following equations for other load resistance values:  $R_{max} = [(V_{supply} - 6V) / 0.003] - R_{barrier}$  (maximum value of load resistor allowed)  $R_{min} = 0$  ohms

(2)  $Current = (V_{supply} - 0.8V) / (1690 \text{ ohms} + barrier \text{ internal resistance in ohms} + load \text{ resistor in ohms})$

**Note**

mA output is linear with process from 3.8 to 20.5 mA, per NAMUR NE-43 (February 2003).

**FOUNDATION Fieldbus (output code E)**

Specification	Frequency output <sup>(1)</sup>	Discrete output <sup>(2)</sup>
External voltage (passive power)	30 VDC (max) 8 VDC(min)	30 VDC (max) 8 VDC (min)
Scalable range	0.01 Hz - 10 kHz	
Downscale fault	0Hz	
Upscale fault	Configurable from 10 Hz to 14.5 kHz, default value = 14.5 kHz	
Resolution	+/- 1 pulse	
Entity parameters	<ul style="list-style-type: none"> <li>■ <math>U_i=30V</math></li> <li>■ <math>I_i=484mA</math></li> <li>■ <math>P_i=2.05W</math></li> <li>■ <math>C_i=11.27nF</math></li> <li>■ <math>L_i=5\mu H</math></li> </ul>	

(1) Load resistor (500 Ω resistance recommended for 24V supply.) Use the following equations for other load resistance values:  $R_{max} = [(V_{supply} - 6V) / 0.003] - R_{barrier}$  (maximum value of load resistor allowed)  $R_{min} = 0$  ohms

(2)  $Current = (V_{supply} - 0.8V) / (1690 \text{ ohms} + barrier \text{ internal resistance in ohms} + load \text{ resistor in ohms})$

**FOUNDATION Fieldbus (output code N)**

Specification	Frequency output <sup>(1)</sup>	Discrete output <sup>(2)</sup>
External voltage (passive power)	30 VDC (max) 8 VDC(min) <sup>(3)</sup>	30VDC (max) 8 VDC (min) <sup>(4)</sup>
Scalable range	0.01 Hz - 10 kHz	
Downscale fault	0Hz	
Upscale fault	Configurable from 10 Hz to 14.5 kHz, default value = 14.5 kHz	
Resolution	+/- 1 pulse	

- (1) Load resistor (500 Ω resistance recommended for 24V supply.) Use the following equations for other load resistance values:  $R_{max} = [(V_{supply} - 6V) / 0.003] - R_{barrier}$  (maximum value of load resistor allowed)  $R_{min} = 0$  ohms
- (2)  $Current = (V_{supply} - 0.8V) / (1690 \text{ ohms} + barrier \text{ internal resistance in ohms} + load \text{ resistor in ohms})$
- (3) Load resistor (500 Ω resistance recommended for 24V supply.) Use the following equations for other load resistance values:  $R_{max} = [(V_{supply} - 6V) / 0.003]$  (maximum value of load resistor allowed)  $R_{min} = 250$  ohms (minimum value of load resistance required)
- (4)  $Current = (V_{supply} - 0.8V) / (1690 \text{ ohms} + load \text{ resistor in ohms})$

**Channel D specifications**

Channel D specifications do not apply to Ethernet or FOUNDATION Fieldbus implementations.

**Configurable I/O (output board code A)**

Specification	Frequency output (2)	mA input	Discrete output (3)	Discrete input (2)	Frequency input
Internal voltage (active power)	24VDC (nom) 2.21 kilo ohm pull-up resistor	24VDC (nom)	24VDC (nom) 2.21kilo ohm pull-up resistor	24VDC (nom) 2.21 kilo ohm pull-up resistor	24VDC (nom) 2.21 kilo ohm pull-up resistor
External voltage (passive power)	30VDC (max) 500mA (max) sinking	30VDC (max)	30VDC (max) 500mA (max) sinking	30VDC (max)	30VDC (max)
Scalable range	0.01 Hz – 10 kHz	4 - 20 mA Fault indication if mA input drops below 3.8 mA or goes above 20.5 mA			
Downscale fault	0Hz				
Upscale fault	Configurable from 10 Hz to 14.5 kHz, default value = 14.5 kHz				
Accuracy	+/- 1 pulse				
Input resistance		100 ohm			
Max frequency				100 Hz	3500 Hz
Maximum positive threshold				3VDC	3VDC

Specification	Frequency output (2)	mA input	Discrete output (3)	Discrete input (2)	Frequency input
Minimum negative threshold				0.6VDC	0.6VDC

## Channel E specifications

Channel E is not available for Ethernet or FOUNDATION Fieldbus configurations.

Output option	Specification
Configurable I/O (output board code A)	RS-485 Modbus

## Sensor input mounting codes

Mounting codes	Description
I (integral mount)	Integrally mounted to sensor, no external input connection
C (9-wire remote mount)	One 9-wire sensor signal input connection, intrinsically safe
R (4-wire remote mount)	One 4-wire sensor signal input connection, intrinsically safe

## Digital communications

Protocols	Outputs and descriptions
Modbus/USP	<ul style="list-style-type: none"> <li>■ One service port that can be used for a temporary connection only</li> <li>■ Connects to a PC via USB as if the transmitter had a built-in USB/RS-485 converter</li> <li>■ Supports all Modbus data rates</li> <li>■ Requires a USB A/male-to-A/male cable</li> </ul>
Modbus/RS-485,HART/RS-485	<ul style="list-style-type: none"> <li>■ Available on Channel E, if purchased</li> <li>■ One RS-485 output can be used for direct connection to HART or Modbus host systems</li> <li>■ Accepts data rates between 1200 baud and 38.4 kilobaud</li> <li>■ 115.2 kilobaud is also available as a special order item</li> <li>■ Uses the latest HART 7 standard</li> </ul>
HART/Bell 202	<ul style="list-style-type: none"> <li>■ Available on Channel A, if purchased</li> <li>■ HART Bell 202 signal is superimposed on the primary milliamp output, and is available for host system interface</li> <li>■ Requires 250 to 600 ohms load resistance</li> <li>■ Uses the latest HART 7 standard</li> </ul>

Protocols	Outputs and descriptions
FOUNDATION Fieldbus	<ul style="list-style-type: none"> <li>■ Available on Channel A</li> <li>■ Models/output codes: <ul style="list-style-type: none"> <li>- Model 5700 with output code E is FISCO “ia” certified in Zone 1 / Div 1 and is FISCO “ic” certified in Zone 2 / Div 2 (formerly known as FNICO)</li> <li>- Model 5700 with output code N</li> </ul> </li> <li>■ Transmitters are registered with the Fieldbus Foundation, and conform to the FOUNDATION Fieldbus H1 protocol specification.</li> <li>■ FISCO: <ul style="list-style-type: none"> <li>- Field device in compliance with EN 60079-11:2012 and IEC 60076-11:2011</li> <li>- <math>U_i = 33\text{ V}</math>, <math>I_i = 380\text{ mA}</math>, <math>P_i = 5.32\text{ W}</math>, <math>C_i = 0.27\text{ nF}</math>, <math>L_i = 5\text{ }\mu\text{H}</math></li> </ul> </li> </ul>
EtherNet/IP/Ethernet	<ul style="list-style-type: none"> <li>■ Available on Channel A and Channel B</li> <li>■ Supports Auto Negotiate with data rates of 10 MB and 100 MB and half and full duplex</li> <li>■ Supports Auto Detect of Ethernet Crossover cables</li> <li>■ Supports Dynamic Host Configuration Protocol (DHCP)</li> <li>■ Supports Device Level Ring (DLR)</li> <li>■ Supports Address Conflict Detection (ACD)</li> <li>■ Supports Quality of Service (QoS)</li> <li>■ Supports file object for EDS download</li> <li>■ Conforms to ODVA EtherNet/IP Specification CT 12</li> <li>■ Conforms to the 10BASE-T and 100BASE-TX Ethernet standards</li> </ul>
Modbus TCP/Ethernet	<ul style="list-style-type: none"> <li>■ Available on Channel A and Channel B</li> <li>■ Supports Auto Negotiate with data rates of 10 MB and 100 MB and half and full duplex</li> <li>■ Supports Auto Detect of Ethernet Crossover cables</li> <li>■ Supports Dynamic Host Configuration Protocol (DHCP)</li> <li>■ Uses v1.1b of the Modbus TCP standard</li> <li>■ Conforms to the 10BASE-T and 100BASE-TX Ethernet standards</li> </ul>
PROFINET/Ethernet	<ul style="list-style-type: none"> <li>■ Available on Channel A and Channel B</li> <li>■ Supports Auto Negotiate with data rates of 10 MB and 100 MB and half and full duplex</li> <li>■ Supports Auto Detect of Ethernet Crossover cables</li> <li>■ Conforms to Conformance Class A v2.31 standard</li> <li>■ Conforms to the 10BASE-T and 100BASE-TX Ethernet standards</li> </ul>

## Model 5700 with FOUNDATION Fieldbus support

### Fieldbus software functionality

Model 5700 FOUNDATION Fieldbus software is designed to permit remote testing and configuration of the transmitter using the DeltaV™ Fieldbus Configuration Tool, or other FOUNDATION Fieldbus compliant hosts. The Coriolis sensor signal is channelled through the flowmeter to the control room and the FOUNDATION Fieldbus configuration device.

### Transducer blocks

Transducer blocks hold data from the Coriolis sensor, including process variables, configuration, calibration, and diagnostics.

The Model 5700 transmitter with FOUNDATION Fieldbus provides up to seven transducer blocks:

- Measurement - For process and diagnostic variables and configuration of process parameters.

- Device - For device, display, channels configuration and device alert information
- Total inventory - For configuration of device totals and inventories
- Meter Verification - For Smart Meter Verification
- API referral - For petroleum measurement calculations using API MPMS Chapter 11.1
  - For complex density and concentration calculations (e.g.,%HFCS, SG60/60)
- Concentration Measurement
- APM - For Advance Phase Measurement and NOC calculations

### Resource block

The resource block contains physical device information, including available memory, manufacturer identification, type of device, and features.

### Analog input function blocks

The Analog Input (AI) function block processes the measurement from the Coriolis sensor and makes it available to other function blocks. It also allows filtering, alarm handling, and engineering unit changes. Each of the four Model 5700 AI blocks can be assigned to one of 27 available variables. There are four permanent Analog Input function blocks.

### Analog output function blocks

The AO function block assigns an output value to a field device through a specified channel. The block supports mode control, signal status calculation, and simulation. The AO block can report pressure from an external pressure source, temperature from an external temperature source, or watercut from an external device. There are two permanent Analog Output function blocks.

### Discrete input function block

One permanent Discrete Input (DI) function block can be assigned to any of the Discrete Input variable channels in the transducer block. The DI block channels are: forward/reverse indication, zero in progress, fault condition indication, and meter verification failure.

### Discrete output function block

One permanent Discrete Output (DO) function block can be assigned to any of the Discrete Output variable channels in the transducer block. The DO block channels are: Start Sensor Zero, Increment CM Curve, Start Meter Verification in Continuous Measurement Mode, Reset All Process Totals, Start/Stop All Totals, Reset Config Totals 1-7.

### Proportional integral derivative function block

One permanent Proportional Integral Derivative (PID) function block combines all the necessary logic to perform proportional/integral/derivative control. The block supports mode control, signal scaling and limiting, feed forward control, override tracking, alarm limit detection, and signal status propagation.

### Integrator function block

Two permanent Integrator (INT) function blocks provides functionality for the transmitter totalizers. Any of seven internal totals or any of seven internal inventories can be selected and reset.

### Diagnostics and service

Model 5700 transmitters automatically perform continuous self diagnostics. Using the Device transducer block, the user can perform on-line testing of the transmitter and sensor. Diagnostics are event driven and do not require polling for access.

PlantWeb<sup>®</sup> Field Diagnostic is supported. The diagnostic information is based on NAMUR NE 107 standard.

## Power supply

- Self switching AC/DC input, automatically recognizes supply voltage
- Complies with Low Voltage Directive 2014/35/EU per IEC 61010-1 Ed. 3.0 2010-06; Over voltage Category II, Pollution Degree 2
- For European installations, install a switch or circuit breaker that is suitably located and easily reached. Mark the switch or circuit breaker as the disconnecting device for the transmitter, in compliance with the Low Voltage Directive 2014/35/EU.

Type	Value
AC power	<ul style="list-style-type: none"> <li>▪ 85 to 265 VAC, 50/60 Hz</li> <li>▪ 6 watts typical, 11 watts maximum</li> </ul>
DC power	<ul style="list-style-type: none"> <li>▪ 18 to 100 VDC</li> <li>▪ 6 watts typical, 11 watts maximum</li> <li>▪ Size the length and diameter of power conductors to provide 18VDC minimum at the power terminals at a load current of 0.7A</li> </ul>
Fuse	1.5A Slow Blow (UL 248-14)

## Environmental limits

### Ambient temperature limits

Type	Fahrenheit	Celsius
Operating	-40 to +149 °F	-40 to +65 °C
	<b>Note</b> The display can lose visibility below -22 °F (-30 °C).	
Storage	-40 to +185 °F	-40 to +85 °C

### Vibration limits

Mount type	Value
Non truck mount	Meets IEC 60068-2-6, endurance sweep, 5 to 2000 Hz, 50 sweep cycles at 1.0 g
Truck mount	Meets IEC 60068-2-6, endurance sweep, 5 to 2000 Hz, 50 sweep cycles at 1.0 g (remote mount)

### Humidity limits

The humidity limits are 5 to 95% relative humidity, non-condensing at 140 °F (60 °C).

## Environmental effects

### EMI effects

Complies with:

- EMC directive 2014/30/EU
- NAMUR NE-21 (09.05.2012)

**Ambient temperature effect**

Ambient temperature effect on mA outputs shall not exceed +/-0.005% of span per degree C.

## Hazardous area classifications

### CSA CSA-US

- Ambient temperature is limited to -40°F (-40°C) to 149 °F (65 °C) for CSA compliance.
- Class I, Div. 1, Groups C and D. Class II, Div. 1, Groups E, F, and G explosion proof (when installed with approved conduit seals). Otherwise, Class I, Div. 2, Groups A, B, C, and D.
- Provides nonincendive sensor outputs for use in Class I, Div. 2, Groups A, B, C, and D; or intrinsically safe sensor outputs for use in Class I, Div. 1, Groups C and D or Class II, Div. 1, Groups E, F, and G.

Code	Description
AA	Class I, Div. 1, Groups C and D. Class I, Div. 2, groups A,B,C,D Class II, Div. 1, Groups E, F, and G explosion proof (when installed with approved conduit seals).
2A	Class I, Div. 2, Groups A, B, C, and D.

### IECEX

Ambient temperature range is -40 °F (-40 °C) to 149 °F (65 °C) for IECEx compliance.

### Configurable I/O — ordering code A

**Note**

For EA and 3A approval codes, the marking will change when installed with Smart Wireless 775 THUM.

Classification	Approval code	Approval	
Flameproof	IA	Standard display	Ex db [ib] IIB+H <sub>2</sub> T6 Gb
		No display or IIC display	Ex db [ib] IIC T6 Gb
		Dust marking	Ex tb [ib] IIIC T75 °C Db IP66/IP67
Increased safety	EA	Standard display	Ex db e [ib] IIB+ H <sub>2</sub> T6 Gb
		No display or IIC display	Ex db e [ib] IICT6 Gb
		Dust marking	Ex tb [ib] IIIC T75 °C Db IP66/IP67
Non sparking with an integral transmitter on the sensor	3A	Standard display	Ex nA nC IIB+H <sub>2</sub> T5Gc
		No display or IIC display	Ex nA nC IIC T5 Gc
		Dust marking	Ex tc IIIC T75 °C Dc IP66/IP67
Non sparking with a remote transmitter on the sensor	3A	Standard display	Ex nA nC [ib Gb] IIB+H <sub>2</sub> T5 Gc
		No display or IIC display	Ex nA nC [ib Gb] IIC T5 Gc
		Dust marking	Ex tc [ib Db] IIIC T75 °C Dc IP66/IP67

**Ethernet — ordering code C**

Classification	Approval code	Approval	
Flameproof	IA	Standard display	Ex db [ib] IIB+H <sub>2</sub> T6 Gb
		No display or IIC display	Ex db [ib] IIC T6 Gb
		Dust marking	Ex tb [ib] IIIC T75 °C Db IP66/IP67
Non sparking with an integral transmitter on the sensor	3A	Standard display	Ex nA nC IIB+H <sub>2</sub> T4 Gc
		No display or IIC display	Ex nA nC IIC T4 Gc
		Dust marking	Ex tc IIIC T75 °C Dc IP66/IP67
Non sparking with a remote transmitter on the sensor	3A	Standard display	Ex nA nC [ib Gb] IIB+H <sub>2</sub> T4 Gc
		No display or IIC display	Ex nA nC [ibGb] IIC T4 Gc
		Dust marking	Ex tc [ib Db] IIIC T75 °C Dc IP66/IP67

**FOUNDATION Fieldbus — ordering code N**

Classification	Approval code	Approval	
Flameproof	IA	Standard display	Ex db [ib] IIB+H <sub>2</sub> T6 Gb
		No display or IIC display	Ex db [ib] IIC T6 Gb
		Dust marking	Ex tb [ib] IIIC T75 °C Db IP66/IP67
Increased safety	EA	Standard display	Ex db e [ib] IIB+ H <sub>2</sub> T6 Gb
		No display or IIC display	Ex db e [ib] IICT6 Gb
		Dust marking	Ex tb [ib] IIIC T75 °C Db IP66/IP67
Non sparking with an integral transmitter on the sensor	3A	Standard display	Ex nA IIB+H <sub>2</sub> T4 Gc
		No display or IIC display	Ex nA IIC T4 Gc
		Dust marking	Ex tc IIIC T75 °C Dc IP66/IP67
Non sparking with a remote transmitter on the sensor	3A	Standard display	Ex nA [ib Gb] IIB + H <sub>2</sub> T4 Gc
		No display or IIC display	Ex nA [ib Gb] IIC T4 Gc
		Dust marking	Ex tc [ib Db] IIIC T75 °C Dc IP66/IP67

**FOUNDATION Fieldbus FISCO — ordering code E**

FISCO covers Ex ia, ib, and ic.

Classification	Approval code	Approval	
Flameproof	IA	Standard display	Ex db [ia Ga] [ib] IIB+H <sub>2</sub> T6 Gb
		No display or IIC display	Ex db [ia Ga][ib] IIC T6 Gb
		Dust marking	Ex tb [ia Da] [ib] IIIC T75 °C Db IP66/IP67
Increased safety	EA	Standard display	Ex db e [ia Ga][ib] IIB+H <sub>2</sub> T6 Gb
		No display or IIC display	Ex db e [ia Ga] [ib] IICT6 Gb
		Dust marking	Ex tb [ia Da] [ib] IIIC T75 °C Db IP66/IP67
Non sparking with an integral transmitter on the sensor	3A	Standard display	Ex nA [ic] IIB+H <sub>2</sub> T4 Gc
		No display or IIC display	Ex nA [ic] IIC T4 Gc
		Dust marking	Ex tc IIIC T75 °C Dc IP66/IP67

Classification	Approval code	Approval	
Non sparking with a remote transmitter on the sensor	3A	Standard display	Ex nA [ic] [ib Gb] IIB+H <sub>2</sub> T4 Gc
		No display or IIC display	Ex nA [ic] [ib Gb] IIC T4 Gc
		Dust marking	Ex tc [ib Db] IIIC T75 °C Dc IP66/IP67

Code	Description
IA all mounting options	Used in IECEx EPL Gb/Db Zone 1/21 with flameproof (Ex db) terminal compartment with [ib] output for sensors installed in Zone 1/21
EA all mounting options	Used in IECEx EPL Gb/Db Zone 1/21 with increased safety (Ex e) terminal compartment and flame proof (Ex db) electronic compartment with [ib] output for sensors installed in Zone 1/21
3A mounting option I	Used in IECEx EPL Gc/Dc Zone 2/22, non sparking
3A mounting option R and C	Used in IECEx EPL Gc/Dc Zone 2/22, non sparking with [ib Gb/Db] output for sensors installed in Zone 1/21









## ATEX

Ambient temperature range is -40°F (-40°C) to 149 °F (65 °C) for ATEX compliance.

### Configurable I/O — ordering code A

#### Note

For ZA and VA approval codes, the marking will change when installed with Smart Wireless 775 THUM.

Classification	Approval code	Approval	
Flameproof	FA	Standard display	  II 2 G/D Ex db [ib] IIB+H <sub>2</sub> T6 Gb
		No display or IIC display	Ex db [ib] IIC T6 Gb
		Dust marking	Ex tb [ib] IIIC T75 °C Db IP66/IP67
Increased safety	ZA	Standard display	  II 2 G/D Ex db e [ib] IIB+H <sub>2</sub> T6 Gb
		No display or IIC display	Ex db e [ib] IIC T6 Gb
		Dust marking	Ex tb [ib] IIIC T75 °C Db IP66/IP67
Non sparking with an integral transmitter on the sensor	VA	Standard display	  II 3 G/D Ex nA nC IIB+H <sub>2</sub> T5 Gc
		No display or IIC display	Ex nA nC IIC T5 Gc
		Dust marking	Ex tc IIIC T75 °C Dc IP66/IP67
Non sparking with a remote transmitter on the sensor	VA	Standard display	  II 3(2) G/D Ex nA nC [ib Gb] IIB+H <sub>2</sub> T5 Gc
		No display or IIC display	Ex nA nC [ib Gb] IIC T5 Gc

Classification	Approval code	Approval	
		Dust marking	Ex tc [ib Db] IIIC T75 °C Dc IP66/IP67

**Ethernet — ordering code C**

Classification	Approval code	Approval	
Flameproof	FA	Standard display	CE <sup>2400</sup> Ex II 2 G/D Ex db [ib] IIB+H <sub>2</sub> T6 Gb
		No display or IIC display	Ex db [ib] IIC T6 Gb
		Dust marking	Ex tb [ib] IIIC T75 °C Db IP66/IP67
Non sparking with an integral transmitter on the sensor	VA	Standard display	CE <sup>2400</sup> Ex Ex nA nC IIB+H <sub>2</sub> T4 Gc
		No display or IIC display	Ex nA nC IIC T4 Gc
		Dust marking	Ex tc IIIC T75 °C Dc IP66/IP67
Non sparking with a remote transmitter on the sensor	VA	Standard display	CE <sup>2400</sup> Ex Ex nA nC [ib Gb] IIB+H <sub>2</sub> T4 Gc
		No display or IIC display	Ex nA nC [ib Gb] IIC T4 Gc
		Dust marking	Ex tc [ib Db] IIIC T75 °C Dc IP66/IP67

**FOUNDATION Fieldbus — ordering code N**

Classification	Approval code	Approval	
Flameproof	FA	Standard display	CE <sup>2400</sup> Ex II 2 G/D Ex db [ib] IIB+H <sub>2</sub> T6 Gb
		No display or IIC display	Ex db [ib] IIC T6 Gb
		Dust marking	Ex tb [ib] IIIC T75 °C Db IP66/IP67
Increased safety	ZA	Standard display	CE <sup>2400</sup> Ex II 2 G/D Ex db e [ib] IIB+H <sub>2</sub> T6 Gb
		No display or IIC display	Ex db e [ib] IIC T6 Gb
		Dust marking	Ex tb [ib] IIIC T75 °C Db IP66/IP67
Non sparking with an integral transmitter on the sensor	VA	Standard display	CE <sup>2400</sup> Ex Ex nA IIB+H <sub>2</sub> T4 Gc
		No display or IIC display	Ex nA IIC T4 Gc
		Dust marking	Ex tc IIIC T75 °C Dc IP66/IP67
Non sparking with a remote transmitter on the sensor	VA	Standard display	CE <sup>2400</sup> Ex Ex nA [ib Gb] IIB+H <sub>2</sub> T4 Gc
		No display or IIC display	Ex nA [ib Gb] IIC T4 Gc
		Dust marking	Ex tc [ib Db] IIIC T75 °C Dc IP66/IP67

**FOUNDATION Fieldbus FISCO — ordering code E**

FISCO covers Ex ia, ib, and ic.

Classification	Approval code	Approval	
Flameproof	FA	Standard display	CE <sup>2400</sup> Ex II (1) 2 G/D Ex db [ia Ga] [ib] IIB+H <sub>2</sub> T6 Gb
		No display or IIC display	Ex db [ia Ga] [ib] IIC T6 Gb
		Dust marking	Ex tb [ia Da] [ib] IIIC T75 °C Db IP66/IP67
Increased safety	ZA	Standard display	CE <sup>2400</sup> Ex II (1) 2 G/D Ex db e [ia Ga] [ib] IIB+H <sub>2</sub> T6 Gb
		No display or IIC display	Ex db e [ia Ga] [ib] IIC T6 Gb
		Dust marking	Ex tb [ia Da] [ib] IIIC T75 °C Db IP66/IP67
Non sparking with an integral transmitter on the sensor	VA	Standard display	CE <sup>2400</sup> Ex nA [ic] IIB+H <sub>2</sub> T4 Gc
		No display or IIC display	Ex nA [ic] IIC T4 Gc
		Dust marking	Ex tc IIIC T75 °C Dc IP66/IP67
Non sparking with a remote transmitter on the sensor	VA	Standard display	CE <sup>2400</sup> Ex nA [ic] [ib Gb] IIB+H <sub>2</sub> T4 Gc
		No display or IIC display	Ex nA [ic] [ib Gb] IIC T4 Gc
		Dust marking	Ex tc [ib Db] IIIC T75 °C Dc IP66/IP67

Code	Description
FA (all mounting options)	Used in ATEX II 2 G/D Zone 1/21 with flameproof (Ex db) terminal compartment with [ib] output for sensors installed in Zone 1/21.
ZA (all mounting options)	Used in ATEX II 2 G/D Zone 1/21 with increased safety (Ex e) terminal compartment and flame proof (Ex db) electronic compartment with [ib] output for sensors installed in Zone 1/21
VA mounting option I	Used in ATEX II 3 G/D Zone 2/22 with non-sparking.
VA mounting option R and C	Used in ATEX II (2) 3 G/D Zone 2/22, non-sparking with [ib Gb/Db] output for sensors installed in Zone 1/21.

## Environmental compliance

RoHS and WEEE compliance



The battery in the Model 5700 transmitter cannot be serviced or replaced by users. In compliance with RoHS (Restriction of Hazardous Substances) and WEEE (Waste Electrical and Electronic Equipment), Micro Motion provides a service for battery replacement and disposal. The Model 5700 transmitter complies with RoHS Directive 2011/65/EU.

### Ingress protection

5700 transmitters contain the following ingress protection for specific transmitters:

- Model 5700I Transmitters have IP66/IP67 ingress protection.
- Model 5700C Transmitters have IP66/IP67/IP69(K)<sup>(1)</sup> protection.
- Model 5700R Transmitters have IP66/IP67/IP69(K)<sup>(1)</sup> protection.

## Physical specifications

For transmitters integrally mounted to a sensor, you may need to add the weight of the transmitter to the sensor. Refer to the sensor product data sheet.

## Materials of construction

Where 4-wire cable is required, use Micro Motion 4-wire cable, depending on the specific model number ordered, 10 ft (3 m) of shielded PVC cable (4-wire or 9-wire) will be included (see ordering information for details). For longer cable lengths, contact customer support.

Specification	Value
Housing	<ul style="list-style-type: none"> <li>■ Polyurethane-painted cast aluminum</li> </ul>
Weight	<ul style="list-style-type: none"> <li>■ Painted aluminum, 4-wire and 9-wire remote: 16 lb (7.26 kg)</li> <li>■ Painted aluminum integral: 11 lb (4.99 kg)</li> </ul>
Terminal compartments	<ul style="list-style-type: none"> <li>■ Output terminals are physically separated from the power and service-port terminals</li> </ul>
Cable gland entrances	<ul style="list-style-type: none"> <li>■ 4-wire remote: Either 5 M20 conduit entries or 5 1/2"-14 NPT</li> <li>■ 9-wire remote: 1 3/4"-14 NPT female conduit port for sensor cable and for power and I/O for one of the following entries:                             <ul style="list-style-type: none"> <li>■ - 4 M20 conduit entries</li> <li>■ - 4 1/2" NPT conduit entries</li> </ul> </li> </ul>
Optional M12 Connections (Ethernet version only)	<ul style="list-style-type: none"> <li>■ Pre-installed M12 quick connections available as an option</li> <li>■ Option of (2) pre-installed for Ethernet connections and an option for additional (2) connections for power and configurable output</li> <li>■ Suitable for Class 1, Division 2 approval only</li> </ul>

(1) The protection is IP69K when using standard NEN-ISO 20653:2013 and IP69 when using standard IEC/EN 60529.

Specification	Value		
Mounting	<ul style="list-style-type: none"> <li>■ Integral or remote mounting options</li> <li>■ May be remotely connected to any 4-wire or 9-wire Micro Motion sensor</li> <li>■ Remote-mount transmitters include a 304L and a 316L stainless steel mounting bracket, and the hardware for installing the transmitter on the mounting bracket</li> <li>■ For remote 4-wire or 9-wire mounts, the transmitter can be rotated 360 degrees with respect to customer wall or pipe in 90-degree increments</li> <li>■ For integral mount, the transmitter can be rotated with respect to the sensor in 45-degree increments</li> </ul>		
Maximum cable lengths between sensor and transmitter	Cable type	Wire gauge	Maximum length
	Micro Motion 9-wire	Not applicable	1000 feet (300 meters) <sup>(1)</sup>
	Micro Motion 4-wire	Not applicable	1000 feet (300 meters)
	User-supplied 4-wire	VDC 22 AWG (0.34 mm <sup>2</sup> )	300 feet (90 meters)
		VDC 20 AWG (0.5 mm <sup>2</sup> )	500 feet (150 meters)
		VDC 18 AWG (0.8 mm <sup>2</sup> )	1000 feet (300 meters)
	RS-485 22 AWG (0.34 mm <sup>2</sup> ) or larger	1000 feet (300 meters)	
For the cable sizing formula, see the appropriate Micro Motion Model 5700 installation manual.			
Standard interface/display	<ul style="list-style-type: none"> <li>■ Graphical backlit display with 4-button optical controls and flowmeter-status LED</li> <li>■ Depending on purchase option, transmitter housing cover has either a non-glass lens or tempered glass lens option</li> <li>■ To facilitate various mounting orientations, the display can be rotated on transmitter, 360 degrees, in 90-degree increments</li> <li>■ Display supports English, German, French, Spanish, Portuguese, Russian, Chinese, and Japanese</li> </ul>		
Display functions	<ul style="list-style-type: none"> <li>■ Complete operation and configuration through the display, no service tool required</li> <li>■ View process variables</li> <li>■ Start, stop, and reset totalizers</li> <li>■ View and acknowledge alarms</li> <li>■ View the Smart Meter Verification initiation and results from the display without interrupting process measurement</li> <li>■ Set the flowmeter to zero, simulate outputs, change measurement units, configure outputs, and set RS-485 communications options</li> <li>■ View a three-color LED status light on display panel that indicates flowmeter conditions at a glance</li> </ul>		

(1) For Smart Meter Verification, the limit is 66 feet (20 meters)

## Dimensions

### Remote mount transmitter

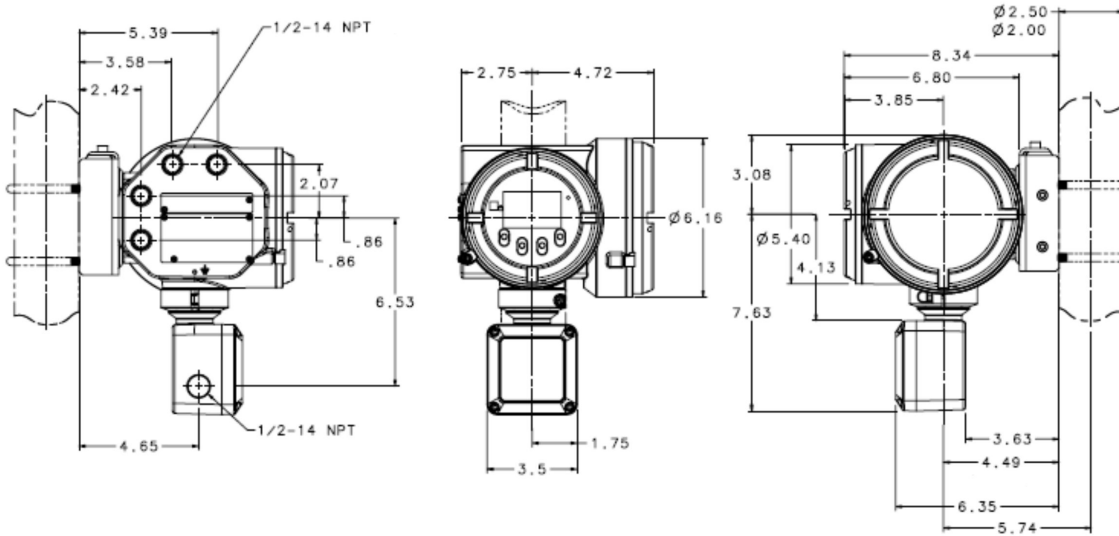

### Integral mount transmitter

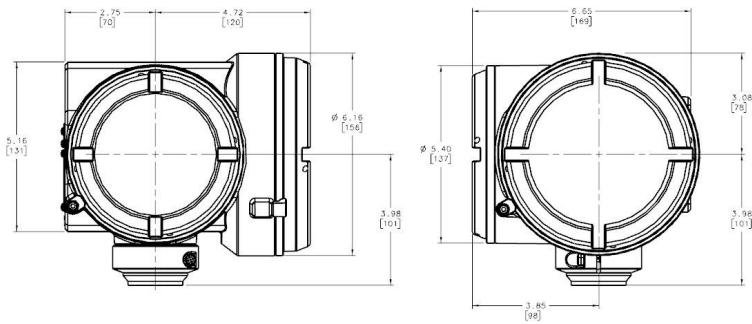

## Ordering information

### Base model

Model	Product description
5700	Micro Motion Coriolis field mount transmitter

Code	Mounting options
I	Integral mount transmitter (polyurethane-painted aluminum housing)
R	4-wire remote mount transmitter (polyurethane-painted aluminum housing), bracket for wall or pipe mounting, and hardware for 2" pipe mount, includes 10 ft. [3m] 4-wire shielded PVC cable
C	9-wire remote transmitter with integrated core processor (polyurethane-painted aluminum housing), bracket for wall or pipe mounting, and hardware for 2" pipe mount, includes 10 ft. [3m] 9-wire CFEPS cable

Code	Power options
1	18 to 100 VDC or 85 to 265 VAC; self switching

Code	Display options
Available with all approval codes	
2	Backlit graphic display for CSA, UL, and IIB + H2 ATEX, and IECEx ratings
3	No display
Available with FA, IA, and R2 approval codes	
5	Backlit graphic display for IIC ATEX, IECEx, and NEPSI rating
Available with MA approval code	
7	Non-glass backlit graphic display

Code	Output board options
A	Configurable outputs
C <sup>(1)(2)(3)</sup>	Ethernet outputs, select EtherNet/IP, Modbus TCP, or PROFINET in channel assignment section
E <sup>(1)(2)</sup>	Intrinsically safe FOUNDATION Fieldbus H1 outputs
N <sup>(1)(2)</sup>	Non-intrinsically safe FOUNDATION Fieldbus H1 outputs

(1) Not available with Certificate Option SI.

(2) Not available with Certificate Option R2.

(3) Not available with approval codes ZA or EA.

Code	Conduit connection options
B	1/2-inch NPT – no gland
C <sup>(1)</sup>	1/2-inch NPT with brass/nickel cable gland
D <sup>(1)</sup>	1/2-inch NPT with stainless steel cable gland
E	M20 - no gland
F <sup>(1)</sup>	M20 with brass/nickel cable gland
G <sup>(1)</sup>	M20 with stainless steel cable gland

(1) Not approved in Class 1 Division 1 installations.

Code	Approval options
MA	Micro Motion Standard (no approval)
AA	CSA (US and Canada): Class I, Division 1, Groups C and D
ZA	ATEX: II 2G, Ex db e, Zone 1 and II 2D Ex tb, Zone 21
FA	ATEX: II 2G, Ex d, Zone 1 and II 2D Ex tb, Zone 21
IA	IECEX: EPL Gb, Ex d, Zone 1 and EPL Db Ex tb, Zone 21
EA	IECEX: EPL Gb, Ex db e, Zone 1 and EPL Db Ex tb, Zone 21
2A	CSA (US and Canada): Class I, Division 2, Groups A, B, C, D; sensor connections will be intrinsically safe without additional barrier
VA <sup>(1)</sup>	ATEX: II 3G, Ex nA nC, Zone 2 and II 3D Ex tc Zone 22
3A <sup>(1)</sup>	IECEX: EPL Gc, Ex nA nC, Zone 2 and EPL Dc, Ex tc, Zone 22
R2	EAC: Ex d, Zone 1

(1) Sensor connections will be Intrinsically Safe without additional barrier.

Code	Transmitter option 1
Z	Standard product

Code	Transmitter option 2
Z	Standard product

Code	Factory options
Z	Standard product
X	ETO product

Channel	Code	Output channel assignment
A	Available with output board code A	
	Z	Channel Off
	A	Channel On; mA Output with HART
	Available with output hardware board code C	
	C	EtherNet/IP output 1
	D	Modbus TCP output 1
	H	PROFINET output 1

Channel	Code	Output channel assignment	
B	Available with output hardware board code E, N		
	F	FOUNDATION Fieldbus output	
	Available with output hardware board code A		
	Z	Channel Off	
	A	Channel On; Configurable to mA Output, Frequency Output, and Discrete Output	
	Available with output hardware board code C (selection must match Channel A)		
	C	EtherNet/IP output 2	
	D	Modbus TCP output 2	
	H	PROFINET output 2	
C	Available with output hardware board code E, N		
	E	Channel On; mA output	
	Available with output hardware board code A		
	Z	Channel Off	
	A	Channel On; Configurable to mA output, frequency output, discrete output, and discrete input	
	Available with output hardware board code C		
	C	Configurable to mA output, frequency output, discrete output, and discrete input	
	Available with output hardware board code E, N		
	E	Channel On; Configurable to frequency output, and discrete output	
D	Available with output hardware board code A		
	Z	Channel Off	
	A	Channel On; Configurable to mA input, frequency input, frequency output, discrete output, and discrete input	
	Available with output hardware board code C		
	Z	Channel Off	
	Available with output hardware board code E, N		
	Z	Channel Off	
	E	Available with output hardware board code A	
		Z	Channel Off On; printing support
A		On; RS-485 Modbus and RS-485 HART	
Available with output hardware board code C			
Z		Channel Off	
Available with output hardware board code E, N			
Z		Channel Off	

Code	Additional features (all optional)
Instrument tagging	
TG	Instrument Tagging -- customer information required (maximum 24 characters)
	Meter verification
MV <sup>(1)</sup>	Smart Meter Verification
Weights and measures approval	
Requires output board code A (or C for option NT only) and display code 2, 5 or 7 (select only one from this group)	
NT	Weights and measures custody transfer approval - NTEP
OG	Weights and measures custody transfer approval - MID & OIML for Gas
OL	Weights and measures custody transfer approval - MID & OIML for Liquid
Enhanced measurement (select only one from this group)	
PS <sup>(2)</sup>	API Referral software
CM <sup>(2)</sup>	Concentration Measurement software
Additional software options (select any from this group)	
BS <sup>(3)(2)</sup>	Batching Software package
Advanced Phase Measurement (select any from this group)	
PG <sup>(4)</sup>	Advanced Phase Measurement Gas with Liquid
PL <sup>(4)</sup>	Advanced Phase Measurement Liquid with Gas
PO <sup>(4)</sup>	Advanced Phase Measurement Net Oil
Additional Certifications, Requires output code A for Channel A and Channel D	
SI	Safety certification of 4-20 mA outputs per IEC 61508
Smart Wireless 775 THUM requires output code A for Channel A (select only one from this group)	
PI <sup>(5)</sup>	Smart Wireless 775 THUM Ready - 775 ordered separately and assembled to 5700
NI	Smart Wireless 775 THUM Ready - 775 ordered separately and not assembled to 5700
Ethernet connectors, requires output hardware board code C (select only one from this group)	
CA <sup>(6)</sup>	(2) M12 Connectors for Ethernet ports
CB <sup>(6)</sup>	(2) M12 Connectors for Ethernet ports and (1) for Channel C and (1) for Power

(1) Available with all Mounting Options, but Mounting C is limited to 60 ft (20m) of 9-wire cable and only available when purchased with new 9-wire sensor.

(2) Not available with Certificate Option SI.

(3) Not available with either Output Hardware Board E or N.

(4) Not available with Add on options NT or SI.

(5) Smart Wireless ready transmitter add on Option "PI" is only available with Approval Options 2A, VA, and 3A.

(6) Only available with approval codes MA and 2A.





**Emerson Automation Solutions**

Worldwide Headquarters  
7070 Winchester Circle  
Boulder, Colorado USA 80301  
T: +1 800-522-6277  
T: +1 303-527-5200  
F: +1 303-530-8459  
Mexico: 52 55 5809 5300  
Argentina: 54 11 4837 7000  
Brazil: 55 15 3413 8147  
Chile: 56 2 2928 4800

**Emerson Automation Solutions**

Central Europe: +41 41 7686 111  
Eastern Europe: +41 41 7686 111  
Dubai: +971 4 811 8100  
Abu Dhabi: +971 2 697 2000  
France: 0800 917 901  
Germany: +49 (0) 2173 3348 0  
Italy: 8008 77334  
The Netherlands: +31 (0) 70 413 6666  
Belgium: +32 2 716 77 11  
Spain: +34 913 586 000  
U.K.: 0870 240 1978  
Russian/CIS: +7 495 981 9811

**Emerson Automation Solutions**

Australia: (61) 3 9721 0200  
China: (86) 21 2892 9000  
India: (91) 22 6662 0566  
Japan: (81) 3 5769 6803  
South Korea: (82) 31 8034 0000  
Singapore: (65) 6 777 8211

©2017 Micro Motion, Inc. All rights reserved.

The Emerson logo is a trademark and service mark of Emerson Electric Co. Micro Motion, ELITE, ProLink, MVD and MVD Direct Connect marks are marks of one of the Emerson Automation Solutions family of companies. All other marks are property of their respective owners.