

# Quick Start Manual



Read the user's manual carefully before starting to use the unit.  
Producer reserves the right to implement changes without prior notice.

### Safety Information

- **DO NOT** exceed maximum temperature or pressure specifications!
- **ALWAYS** wear safety goggles or face-shield during installation and/or service!
- **DO NOT** alter product construction!



### Warning | Caution | Danger

Indicates a potential hazard. Failure to follow all warnings may lead to equipment damage, or failure, injury, or death.



### Note | Technical Notes

Highlights additional information or detailed procedure.

### Basic Requirements & User Safety

- ✔ Do not use the unit in areas threatened with excessive shocks, vibrations, dust, humidity, corrosive gasses and oils.
- ✔ Do not use the unit in areas where there is risk of explosions.
- ✔ Do not use the unit in areas with significant temperature variations, exposure to condensation or ice.
- ✔ Do not use the unit in areas exposed to direct sunlight.
- ✔ Make sure that the ambient temperature (e.g. inside the control box) does not exceed the recommended values. In such cases forced cooling of the unit must be considered (e.g. by using a ventilator).
- ✔ The manufacturer is not responsible for any damages caused by inappropriate installation, not maintaining the proper environmental conditions and using the unit contrary to its assignment.
- ✔ Installation should be conducted by qualified personnel. During installation all available safety requirements should be considered. The fitter is responsible for executing the installation according to this manual, local safety and EMC regulations.
- ✔ GND input of device should be connected to PE wire.
- ✔ The unit must be properly set-up, according to the application. Incorrect configuration can cause defective operation, which can lead to unit damage or an accident.
- ✔ If in the case of a unit malfunction there is a risk of a serious threat to the safety of people or property additional, independent systems and solutions to prevent such a threat must be used.
- ✔ The unit uses dangerous voltage that can cause a lethal accident. The unit must be switched off and disconnected from the power supply prior to starting installation of troubleshooting (in the case of malfunction).
- ✔ Neighboring and connected equipment must meet the appropriate standards and regulations concerning safety and be equipped with adequate overvoltage and interference filters.
- ✔ Do not attempt to disassemble, repair or modify the unit yourself. The unit has no user serviceable parts. Defective units must be disconnected and submitted for repairs at an authorized service center.
- ⚠ **The unit is designed for operation in an industrial environment and must not be used in a household environment or similar.**

# LevelPro® — ShoPro® SP100

## Level Display | Controller

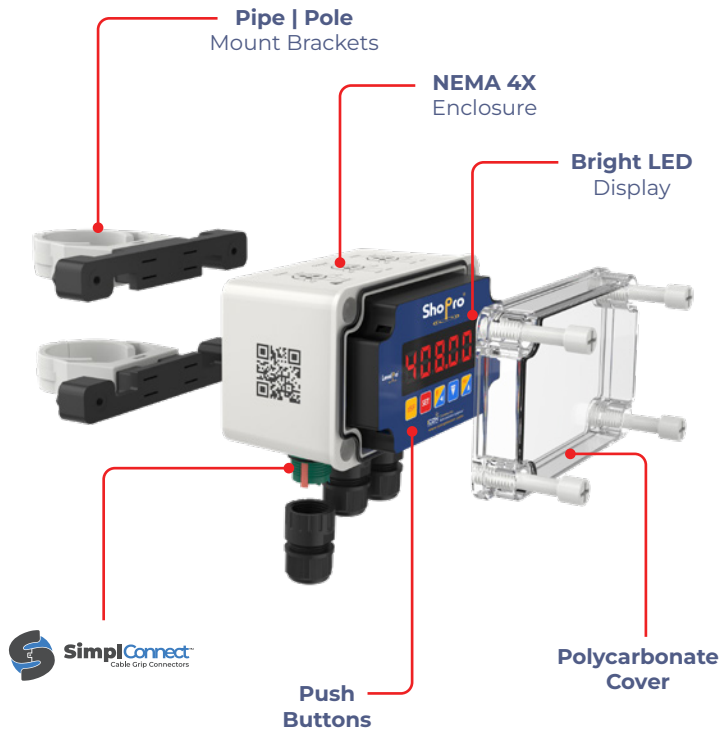

The ShoPro® Series Level Display | Controller is engineered to be the most durable and dependable wall or pipe-mount remote display in the industry. This all-in-one unit is ready to use straight out of the box, featuring a bright LED display, NEMA 4X enclosure, polycarbonate cover, cord grips, and plastic captive screws.

Designed for industrial applications, it withstands even the harshest corrosive environments and is available with multiple output options.

### Features

- ✓ All-in-one | Out of the Box Ready to Use
- ✓ Visual Alarm — High | Low Level
- ✓ NEMA 4X Enclosure
- ✓ Corrosion Resistant Thermoplastic
- ✓ Cord Grips Included – No Tools Required

### Model Selection

ShoPro® SP100 — Liquid Level LED Display		
Part Number	Input	Output
SP100	4-20mA	4-20mA
SP100-A	4-20mA	4-20mA + Audible
SP100-V	4-20mA	4-20mA + Visual
SP100-A-V	4-20mA	4-20mA + Audible & Visual

## Technical Specifications

General	
Display	LED   5 x 13mm High   Red
Displayed Values	-19999 ~ 19999
Transmission Parameters	1200...115200 bit/s, 8N1 / 8N2
Stability	50 ppm   °C
Housing Material	Polycarbonate
Protection Class	NEMA 4X   IP67
Input Signal   Supply	
Standard	Current: 4-20mA
Voltage	85 - 260V AC/DC   16 - 35V AC, 19 - 50V DC*
Output Signal   Supply	
Standard	4-20mA
Voltage	24VDC
Passive Current Output *	4-20mA   (Operating Range Max. 2.8 - 24mA)
Performance	
Accuracy	0.1% @ 25°C One Digit
Accuracy According to IEC 60770 - Limit Point Adjustment   Non-Linearity   Hysteresis   Repeatability	
Temperatures	
Operating Temperatures	-20 to 158°F   -29 to 70°C

\*Optional

### Installation Instructions

The unit has been designed and manufactured in a way assuring a high level of user safety and resistance to interference occurring in a typical industrial environment. In order to take full advantage of these characteristics installation of the unit must be conducted correctly and according to the local regulations.





- ✔ Read the basic safety requirements on page 2 prior to starting the installation.
- ✔ Ensure that the power supply network voltage corresponds to the nominal voltage stated on the unit's identification label. The load must correspond to the requirements listed in the technical data.
- ✔ All installation works must be conducted with a disconnected power supply.
- ✔ Protecting the power supply connections against unauthorized persons must be taken into consideration.

### Package Contents

Please verify that all listed parts are consistent, undamaged and included in the delivery / your specified order. After removing the unit from the protective packaging, please verify that all listed parts are consistent, undamaged and included in the delivery/your specified order.

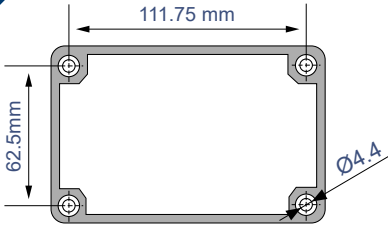
Any transportation damage must be immediately reported to the carrier. Also, write down the unit serial number located on the housing and report the damage to the manufacturer.

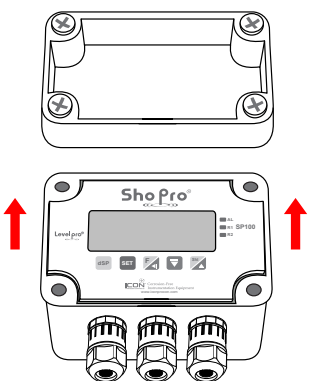
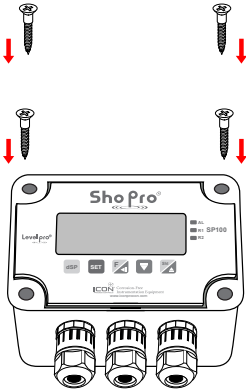
### Wall Mounting

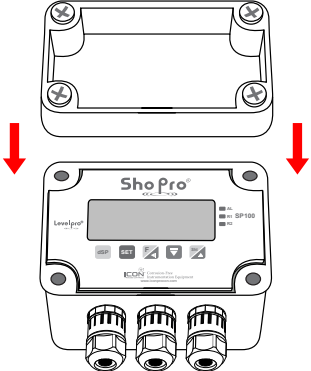
<p><b>1</b></p>  <p>To install device on the wall, pinholes should be made. The distances between holes are mentioned above. This part of the case should be mounted to a wall by screws.</p>	<p><b>2</b></p>  <p>Loosen Box Screws &amp; Open Display Cover</p>	<p><b>3</b></p>  <p>Remove Display Cover</p>
<p><b>4</b></p>  <p>Mount on Wall using Screws</p>	<p><b>5</b></p>  <p>Tighten Screws</p>	<p><b>6</b></p>  <p>Place Display Cover and Tighten Box Screws</p>

### Pipe | Pole Clamp Installation

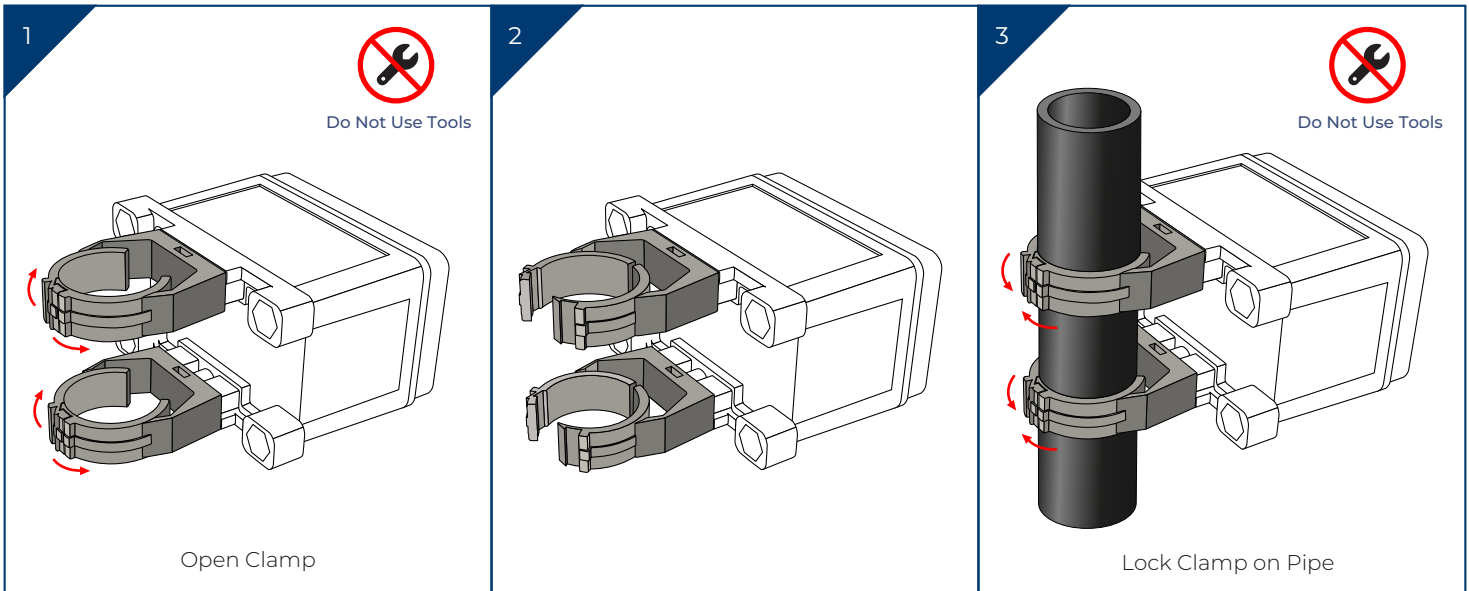

### Wiring



### Dimensions

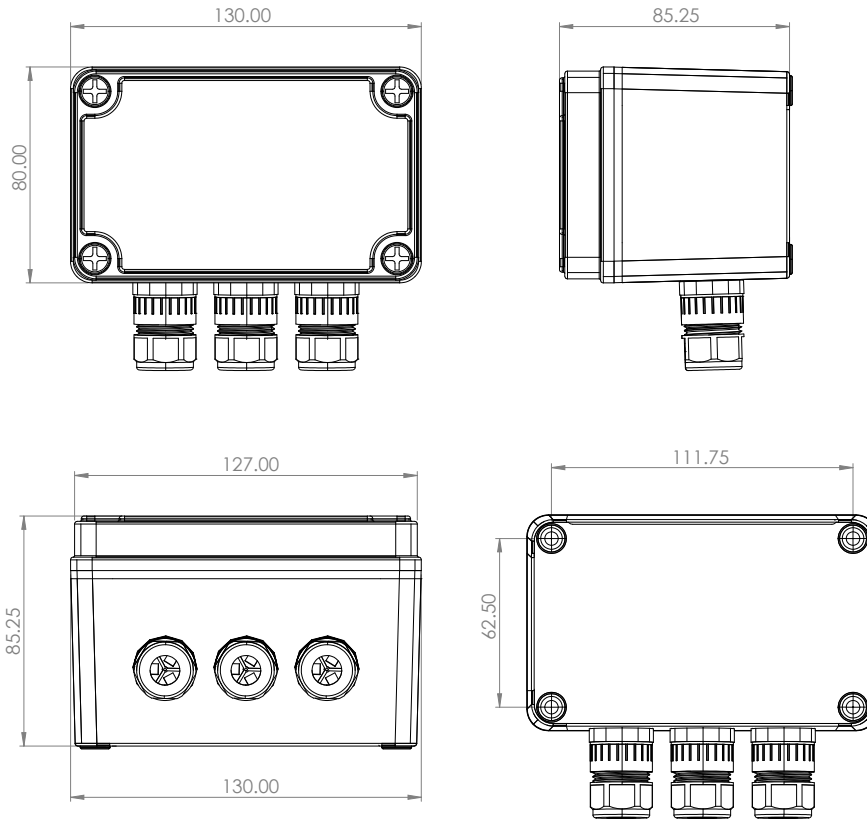

### Wiring Diagram

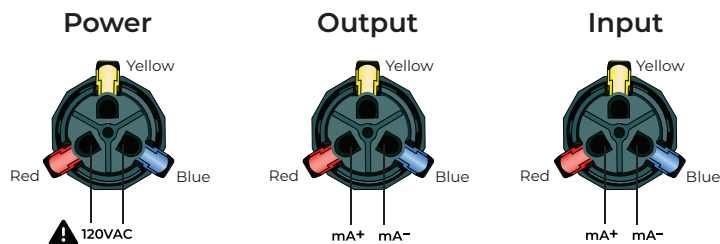
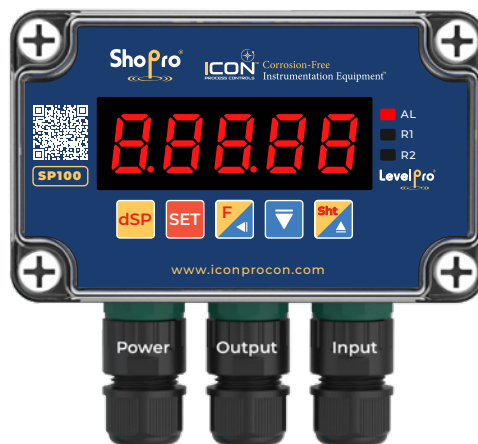

### Wiring - ShoPro + 100 Series Submersible Level Sensor

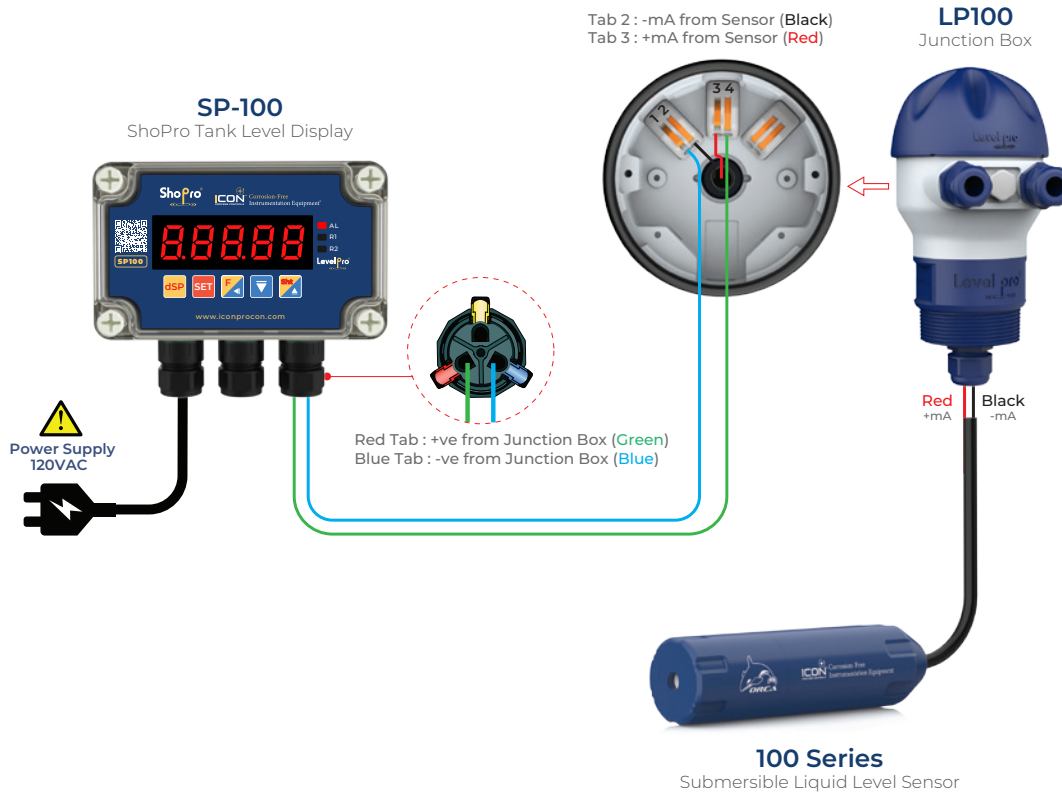

### Wiring - ShoPro + ProScan®3 Radar Level Sensor

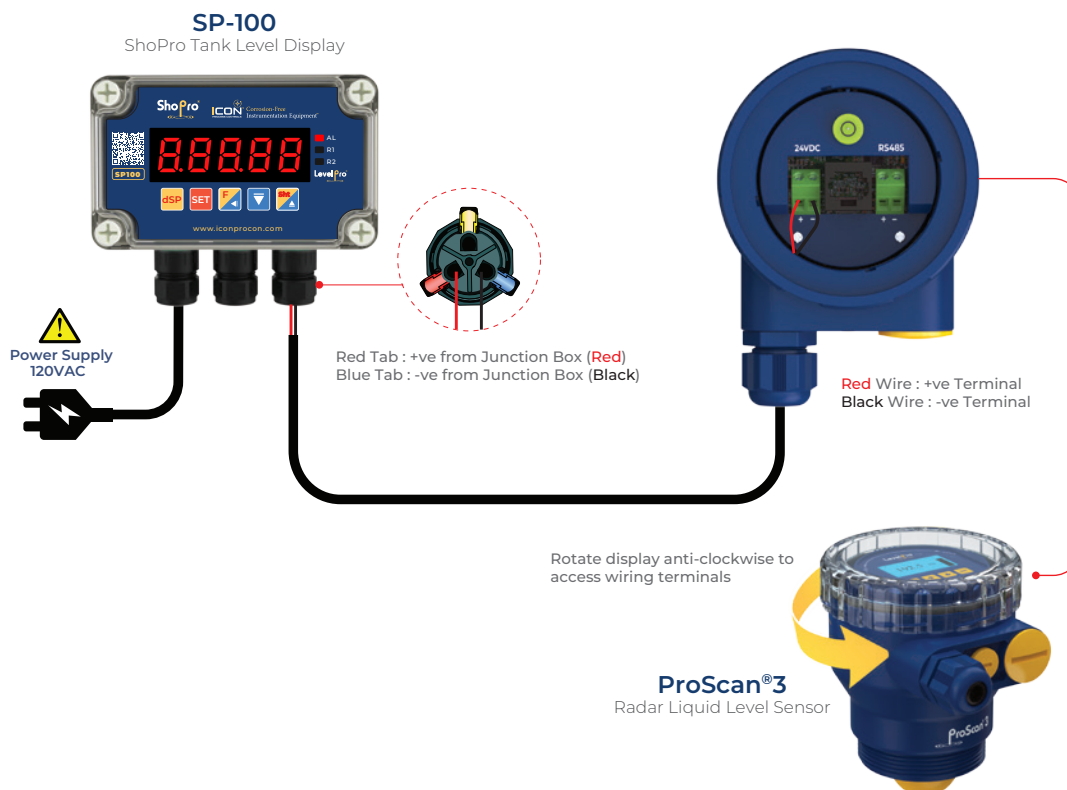

### Display Description & Button Functions



	= Display Programming Menu (Press + Hold for 3 sec.)
	= Save the Value
	= [F] Press & Hold for 3 SEC for Alarm Set
	= [Left Arrow] Back Menu
	= Changing the Values
	= [F] Back to Main Display
	= [Up Arrow] Changing Menu

### Programming 4-20mA



Move Selection Left



Change Digit Value

STEPS	DISPLAY	OPERATION
1 Main Menu 3 SEC		Main Display
2 4mA Settings 		4mA Settings 4mA = Low Level
3 Enter 4mA Value 		Enter 4mA Value Factory Default = 0
4 20mA Settings 		20mA Settings 20mA = High Level
5 Enter 20mA Value 		Enter 20mA Value
6 Main Display		Main Display

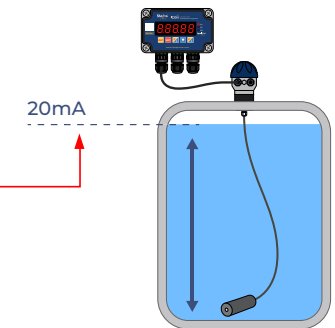
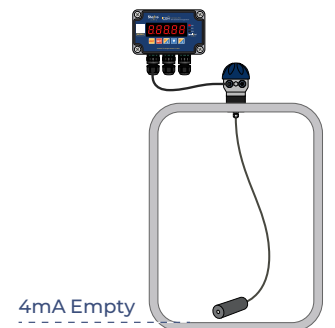

- dSPL = Low Level Value | Empty or Lowest Liquid Level | Factory Default = 0.
- dSPH = High Level Value | Enter Maximum Level.

### Alarm Programming



Move Selection Left



Change Digit Value

STEPS	DISPLAY	OPERATION
<b>1 Main Display</b> 3 SEC		Main Display
<b>2 Alarm 1 Settings</b> 		Alarm 1 Settings
<b>3 Alarm 1 Value</b> 		Alarm 1 Value Enter Alarm 1 Value
<b>4 Alarm 2 Settings</b> 		Alarm 2 Settings
<b>5 Alarm 2 Value</b> 		Alarm 2 Value Enter Alarm 2 Value
<b>6 Hysteresis</b> 		Hysteresis
<b>7 Hysteresis Value</b> 		Hysteresis Value Enter Hysteresis Value
<b>8 Main Display</b>		Main Display

### Alarm Mode Selection

ALt No.	Description	
<b>ALt = 1</b>	<ul style="list-style-type: none"> <li>• CV ≥ AL1 → AL1 ON</li> <li>• CV &lt; (AL1-HYS) → AL1 OFF</li> </ul>	<ul style="list-style-type: none"> <li>• CV ≤ AL2 → AL2 ON</li> <li>• CV &lt; (AL2-HYS) → AL2 OFF</li> </ul>
<b>ALt = 2</b>	<ul style="list-style-type: none"> <li>• CV ≥ AL1 → AL1 ON</li> <li>• CV &lt; (AL1-HYS) → AL1 OFF</li> </ul>	<ul style="list-style-type: none"> <li>• CV ≤ AL2 → AL2 ON</li> <li>• CV &gt; (AL2+HYS) → AL2 OFF</li> </ul>
<b>ALt = 3</b>	<ul style="list-style-type: none"> <li>• CV ≤ AL1 → AL1 ON</li> <li>• CV &gt; (AL1+HYS) → AL1 OFF</li> </ul>	<ul style="list-style-type: none"> <li>• CV ≤ AL2 → AL2 ON</li> <li>• CV &gt; (AL2+HYS) → AL2 OFF</li> </ul>
<b>CV = Current Value</b>		

#### Note:

To access the Alarm Mode Selection Menu, press



And then press



### Reset Programming



Move Selection Left



Change Digit Value

STEPS	DISPLAY	OPERATION
<b>1 Main Display</b> SET +  3 SEC		Main Display
<b>2 Lock Settings</b> SET X 2		Lock Settings Factory Default : Lk.10 Otherwise meter will enter <b>Lockout Mode*</b>
<b>3 Input Settings</b> SET X 7	 	Input Settings Int.2 will be displayed. Change Int.2 to Int.4 using  or  button.
<b>4 Home Screen</b> SET +  3 SEC		Main Display The Value displayed will be 0.00. This value is equal to 4mA output from the sensor
<b>5 Lock Settings</b> SET X 2		Lock Settings
<b>6 Input Settings</b> SET X 7	 	Input Settings Int.4 will be displayed. Change Int.4 to Int.2 using  or  button.
<b>7 Main Display</b> SET +  3 SEC		Main Display The value displayed is equal to 20mA output from the sensor.
<b>8 Lock Settings</b> SET X 3		Lock Settings
<b>9 Decimal Point</b> SET X 6		Decimal Point Change decimal point to 0. (dP.0)
<b>10 Main Display</b>		Main Display Reset Completed

After reset, the dSPL (4mA) and dSPH (20mA) values must be reconfigured. See "Programming 4-20mA" (Page 8) for details.

## Warranty, Returns and Limitations

### Warranty

**Icon Process Controls Ltd** warrants to the original purchaser of its products that such products will be free from defects in material and workmanship under normal use and service in accordance with instructions furnished by **Icon Process Controls Ltd** for a period of one year from the date of sale of such products. **Icon Process Controls Ltd** obligation under this warranty is solely and exclusively limited to the repair or replacement, at Icon Process Controls Ltd option, of the products or components, which **Icon Process Controls Ltd** examination determines to its satisfaction to be defective in material or workmanship within the warranty period. **Icon Process Controls Ltd** must be notified pursuant to the instructions below of any claim under this warranty within thirty (30) days of any claimed lack of conformity of the product. Any product repaired under this warranty will be warranted only for the remainder of the original warranty period. Any product provided as a replacement under this warranty will be warranted for the one year from the date of replacement.

### Returns

Products cannot be returned to **Icon Process Controls Ltd** without prior authorization. To return a product that is thought to be defective, go to [www.iconprocon.com](http://www.iconprocon.com), and submit a customer return (MRA) request form and follow the instructions therein. All warranty and non-warranty product returns to **Icon Process Controls Ltd** must be shipped prepaid and insured. **Icon Process Controls Ltd** will not be responsible for any products lost or damaged in shipment.

### Limitations

This warranty does not apply to products which: 1) are beyond the warranty period or are products for which the original purchaser does not follow the warranty procedures outlined above; 2) have been subjected to electrical, mechanical or chemical damage due to improper, accidental or negligent use; 3) have been modified or altered; 4) anyone other than service personnel authorized by **Icon Process Controls Ltd** have attempted to repair; 5) have been involved in accidents or natural disasters; or 6) are damaged during return shipment to **Icon Process Controls Ltd** reserves the right to unilaterally waive this warranty and dispose of any product returned to **Icon Process Controls Ltd** where: 1) there is evidence of a potentially hazardous material present with the product; or 2) the product has remained unclaimed at **Icon Process Controls Ltd** for more than 30 days after **Icon Process Controls Ltd** has dutifully requested disposition. This warranty contains the sole express warranty made by **Icon Process Controls Ltd** in connection with its products. **ALL IMPLIED WARRANTIES, INCLUDING WITHOUT LIMITATION, THE WARRANTIES OF MERCHANTABILITY AND FITNESS FOR A PARTICULAR PURPOSE, ARE EXPRESSLY DISCLAIMED.** The remedies of repair or replacement as stated above are the exclusive remedies for the breach of this warranty. **IN NO EVENT SHALL Icon Process Controls Ltd BE LIABLE FOR ANY INCIDENTAL OR CONSEQUENTIAL DAMAGES OF ANY KIND INCLUDING PERSONAL OR REAL PROPERTY OR FOR INJURY TO ANY PERSON. THIS WARRANTY CONSTITUTES THE FINAL, COMPLETE AND EXCLUSIVE STATEMENT OF WARRANTY TERMS AND NO PERSON IS AUTHORIZED TO MAKE ANY OTHER WARRANTIES OR REPRESENTATIONS ON BEHALF OF Icon Process Controls Ltd.** This warranty will be interpreted pursuant to the laws of the province of Ontario, Canada.

If any portion of this warranty is held to be invalid or unenforceable for any reason, such finding will not invalidate any other provision of this warranty.

For additional product documentation and technical support visit:

[www.iconprocon.com](http://www.iconprocon.com) | e-mail: [sales@iconprocon.com](mailto:sales@iconprocon.com) or [support@iconprocon.com](mailto:support@iconprocon.com) | Ph: 905.469.9283



by



Corrosion-Free  
Instrumentation Equipment

Phone: 905.469.9283 • Sales: [sales@iconprocon.com](mailto:sales@iconprocon.com) • Support: [support@iconprocon.com](mailto:support@iconprocon.com)