

UltraFlo® 5000 SERIES

Ultrasonic Flow Meter

Operating Manual



Table of Contents

Safety Information	03
Technological Progress	03
Product Description	03
Features	04
Measuring Principle	04
Operational Safety	04
Technical Specifications	05
Installation Instructions	06
Assembly of the Flowmeter	07
Electrical Wiring	09
Commissioning	11
Display and User Menu	12
Menu Organization for 5-Pin Version	13
Menu Organization for 8-Pin Version	14
Functionalities of flow meter and default settings	15
Exchange of Measuring Device	21
Behavior of the Temperature Sensor	22
Possible error text	23
Dimensions and Weight	23
Warranty, Returns and Limitations	24



Corrosion-Free
Instrumentation Equipment

Safety Information

Please always observe the following safety instructions!

Please pay attention to the safety instructions with the following pictograms and signal words in these operating instructions :



Warning | Caution | Danger

indicates general hazardous situations or cases which, if not avoided, could result in serious injury or death.



IMPORTANT!

indicates situations or cases which, if not avoided, could result in damage or failure of the **UltraFlo®** equipment.

Notice : Is used to lead users to helpful information not related to personal injury.

Intended Use

- ❑ The flow meter **UltraFlo®** should only be used for measuring the flow of pure, homogeneous liquids.
- ❑ The **UltraFlo®** is not intended for use in medical applications.
- ❑ The volume flow meter **UltraFlo®** is built in accordance with industry standard EN 61010 regulations (corresponds to VDE 0411 "Safety specifications for electrical measurement, control and laboratory devices").
- ❑ The manufacturer is not liable for any injury, damage or harm due to inappropriate or unintended use or modifications of the flow meter. Conversions and/or changes to the flow meter may only be made, if they are expressly performed in accordance with the operating instructions in this operating manual.

Personnel for Installation, Commissioning and Operation



- ❑ Assembly, electrical installation, commissioning and maintenance of the flow meter must be carried out by qualified, trained personnel. The qualified personnel must have read and understood the operating instructions in this operating manual and must follow the operating instructions in this manual.
- ❑ The installer has to ensure that the flow meter is correctly connected according to the electrical connection diagrams in this operating manual.
- ❑ Serious injury or death from electric shock may occur if wiring, installation, disassembly or removal of wires is performed while electrical power is energized

Technological Progress

The manufacturer reserves the right to revise, alter, or modify the flow meter to the most current technology without special prior notice. Further information about the latest updates and potential additions to these operating instructions are available from www.iconprocon.com

Product Description

The **UltraFlo® 5000** Flow Meter utilizes ultrasonic technology to measure both conductive and non conductive liquids, and is an excellent choice for very corrosive liquids such as strong acids and alkalies.

The **UltraFlo® 5000** has no moving parts and can measure pulsating, dosing and metering flow applications. All parts that contact the liquid are made of corrosion resistant Polysulfone.

The **UltraFlo® 5000** is characterized by its high measurement accuracy, repeatability and guaranteed long-life performance.

Features

- ❑ All Plastic PE Wetted Materials
- ❑ High Accuracy: ± 1.0%
- ❑ M12 Quick Disconnect
- ❑ Superior Corrosion Resistance
- ❑ 4-20mA + Pulse Relay Output | RS-485
- ❑ Negligible Pressure Drop
- ❑ Empty Pipe Alarm
- ❑ Air Bubble Detection

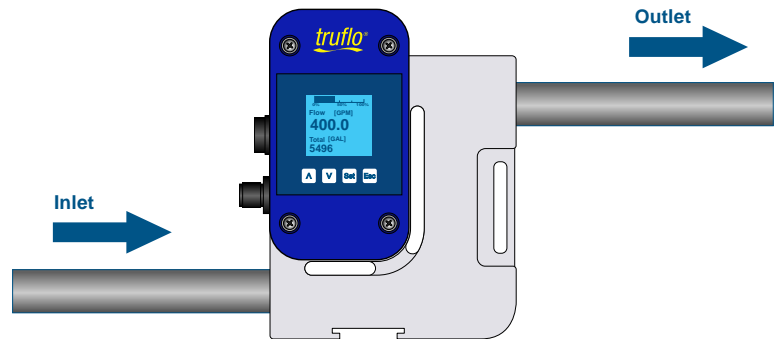

Measuring Principle

The ultrasonic flow measurement is based on the phase-difference approach:

Two ultrasonic-sensors located opposite from each other alternatively transmitting and receiving ultrasonic signals. If there is no liquid flow both sensors receive the transmitted ultrasonic signals in the same phase, i.e. without phase difference. If liquid is flowing there is a phase shift. It differs when measured in direction of the flow than when measured against the direction of the flow. This phase difference is directly proportional to the flow rate.

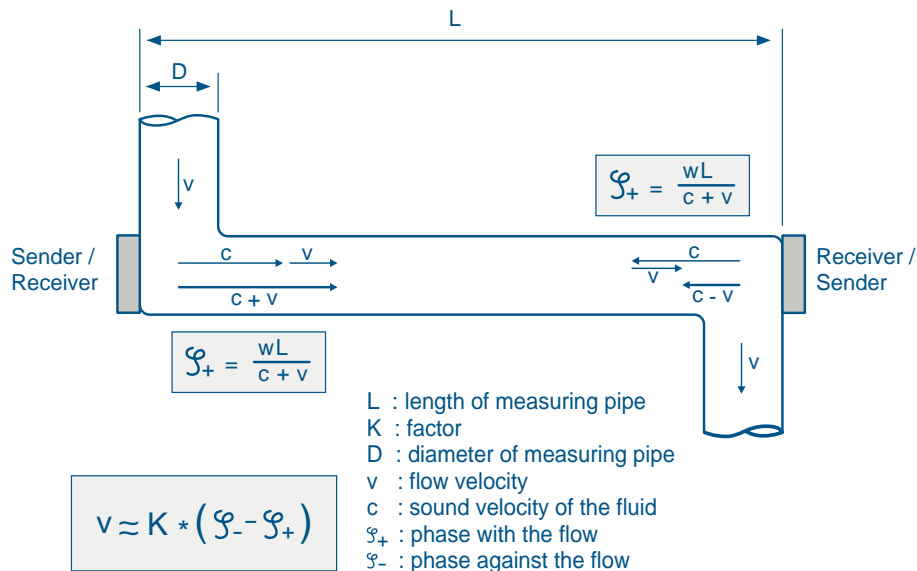

Fig. 1: Presentation of the principle of ultrasonic flow measuring

Operational Safety

- ❑ Comprehensive self-tests ensure highest possible safety.
- ❑ Faults (process or system errors) are output on a digital output or displayed on the display menu.
- ❑ The protection class is IP 67.
- ❑ Flowmeter meets the general EMC immunity requirements according to CE, EN 61000-6-3, EN 61000-4-2, EN 61000-4-3, EN 61000-4-4, EN 61000-4-5, EN 61000-4-6.
- ❑ Flowmeter meets the safety requirements concerning the Protective Extra Low Voltage directive according to EN 50178, SELV, PELV.

Technical Specifications

General			
Material	PE		
Protection Class	IP67 NEMA 4X		
Medium Temperature	14 -176°F -10°- 80°C		
Measuring Range GPM LPM	0.005 - 0.8 0.2 - 3.0	0.02 - 1.6 0.09 - 6	0.08 - 6.3 0.3 - 24
Max. Pressure Non-Shock	100 psi 7 bar	100 psi 7 bar	100 psi 7bar
Dimensions L W H mm	168 147 50	168 147 50	171 147 50
Weight PE lbs	1.4	1.4	1.6
Weight PVDF lbs	2.4	2.4	2.6
Process Connection			
Outside Thread	½"	¾"	1"
Electrical			
Power Supply	18-30VDC		
Power Input	24VDC 3.6W		
Connection	M12 - Plug 5 pins, Plug 8 pins, 10-wire Teflon cable (5m)		
Output			
Output	4-20mA + Pulse Relay RS-485		
Ambient Temperature	-20....+60°C		
Storage Temperature	-20....+70°C		
Current output QA	0/4...20 mA Lower- and upper limit adjustable, Ground connected to supply ground Error Signal according to NAMUR NE43		
Digital output Q1/2	via transistor npn- and pnp-logic max. 30V/100mA output voltage according to DIN 19240: ≤ 5V means LOW ≥ 12V means HIGH Short cut resistant Frequency 0....10kHz		
Data Interface	Data Interface for Parameterize		
Measuring Deviation	± 2% of reading ± 3 mm/s Option: ± 1% of reading ± 3 mm/s Reference conditions (VDE/VDI 2642)		
Repeatability	0.5%		
Display			
LCD Display	Simultaneous Display of volume Flow, Quantity, bar graph, lighted		
Standards and Approvals			
CE FCC RoHS Compliant			

Installation Instructions

The housing of Flowmeter is labeled with an arrow symbolizing the direction of the flow. The flowmeter must be installed in direction of the flow.

Note : The nameplate of the Flowmeter has an arrow, symbolizing the flow direction of measurement. The flow meter has to be installed in a way so that the flow-through is in the same direction as the arrow symbol.

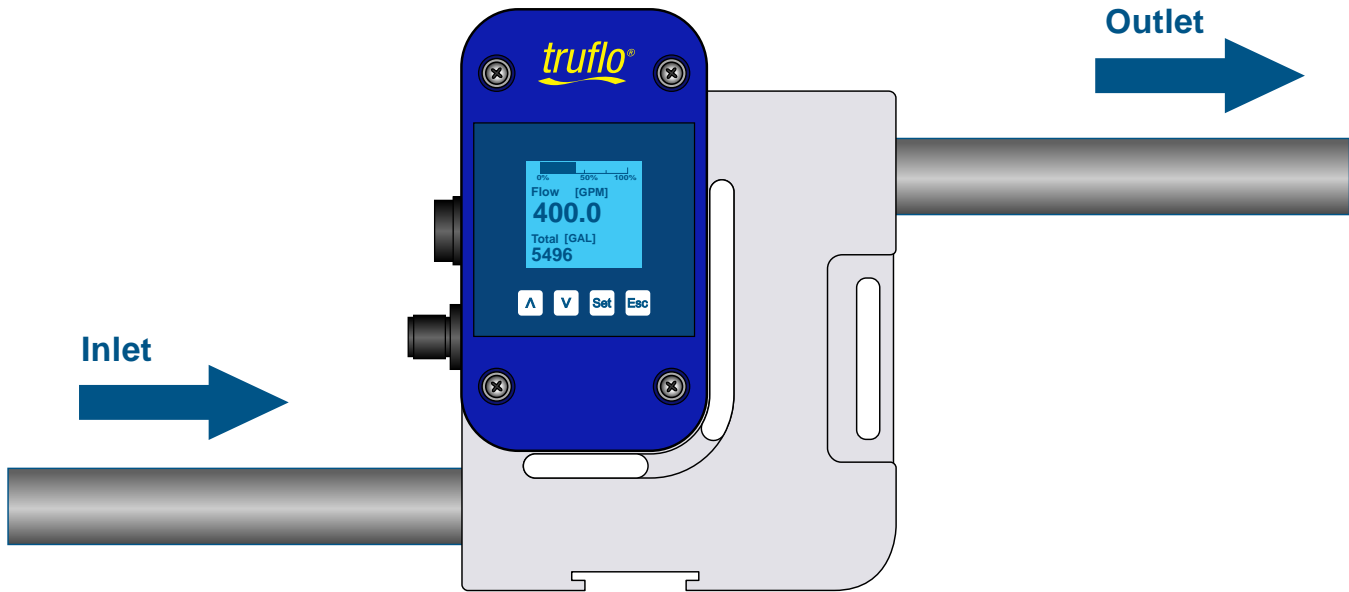

Fig. 2: Installation position of Flowmeter

Note : For fastest possible bubble detection it is important to keep the pipe distance to UltraFlo as short as possible. Accurate measurement can only be assured, if the pipe is completely filled and the liquid does not outgas.

Notwithstanding it may be advantageous for dosing applications to install. The UltraFlo as close as possible to the dosing valve, since soft pipes increases the cross-section depending on the system pressure. This may lead to repeatable differences.

Note : Insure that no cavitations dissolve from the measured liquid. Depending on the measured liquid it can be helpful to have enough back pressure on the outlet of Flowmeter to avoid cavitations. Insure all mechanical connections are tight.

Particles present in the flow stream may result in measuring errors.

When using pumps, Flowmeter must be installed in flow direction on the pressure side, on order to ensure sufficient pressure. The maximum pressure rating of Flowmeter has to be considered.

⚠ Do not exceed the maximum pressure allowance for of the Flowmeter (see Technical specifications - Page-5). Exceed the maximum pressure can lead to destruction of the Flowmeter.

For correct volume flow measurements straight and unobstructed inflow and outflow distances have to be observed. Starting from the connection thread these have to be at least:

Nominal Diameter	DN 5	DN 7	DN 10	DN 15
Inflow Distance	0cm	0cm	5cm	40cm
Outflow Distance	0cm	0cm	5cm	40cm

Assembly of the Flowmeter

Note : The flow meter is mounted into a pipe system by using the mechanical connection. UltraFlo should be mounted vertically into the pipe for the best measuring performance. Do not install the flow meter after a dosing valve where the flow meter can run empty. Placing the flow meter after a dosing valve and allowing it to run empty will cause a measuring deviation at the next measurement. To avoid bubbles in the liquid, UltraFlo should be installed on the pressure side of the pump.

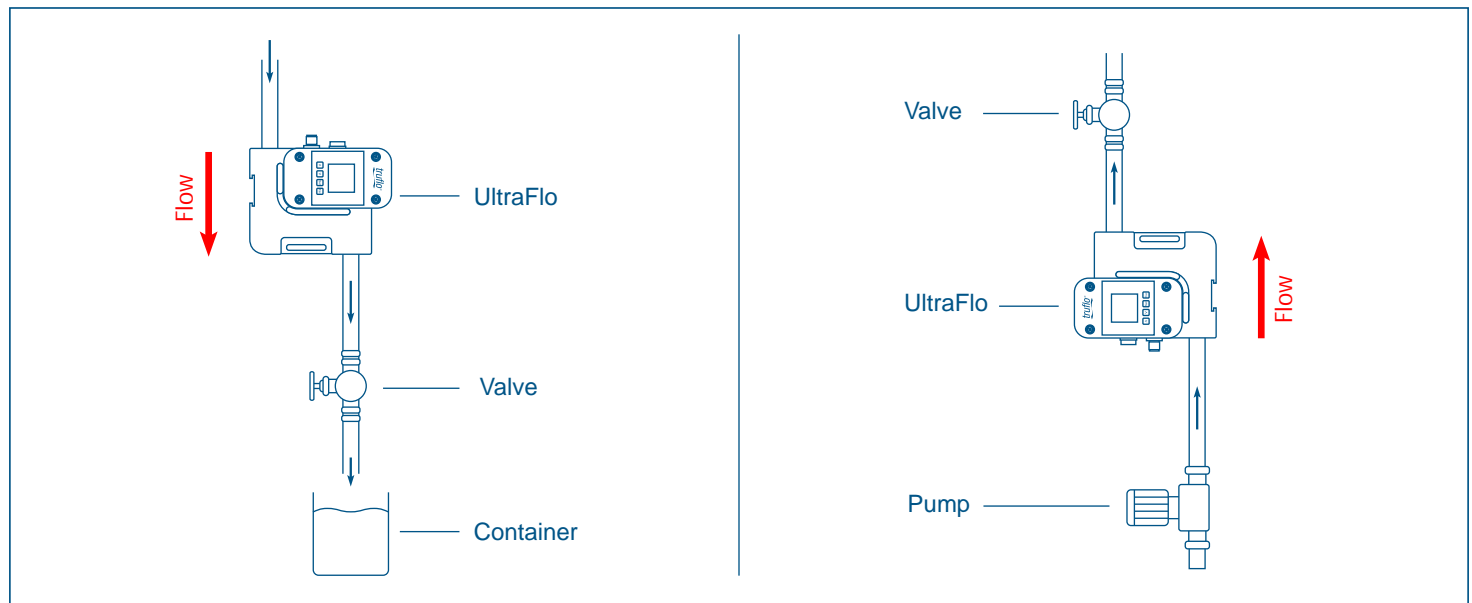

Fig. 3: Mounting examples for UltraFlo

If it is not possible to mount the flow meter vertically, then mount the instrument in a location where the pipe will be filled at all times. The best measuring result is achieved if bubbles do not pass through UltraFlo® 4000 Series.

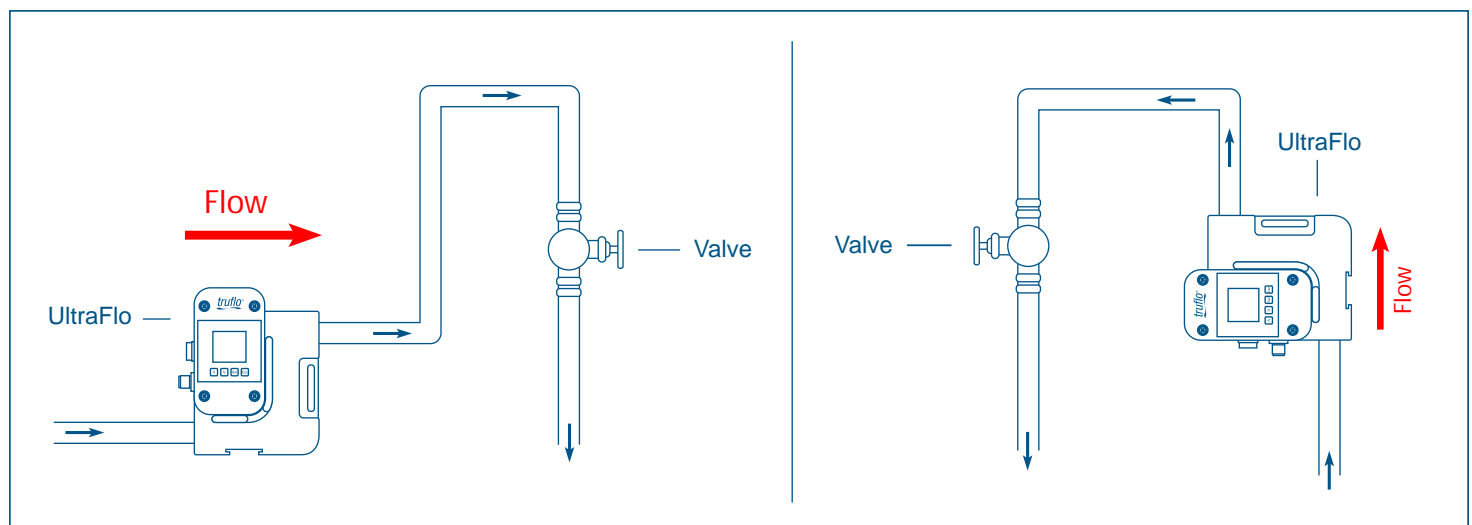

Fig. 4: Mounting possibilities

For applications with a “clean design” for which it is necessary to completely drain the pipe system, we recommend mounting the flow meter in the vertical position. Residual liquid may remain inside the device if flow meter is mounted horizontally.

Vibrations or mechanical forces may decrease measuring accuracy. So if there is due to vibration or mechanical movements is necessary to fix Flowmeter additionally, the instrument can be either mounted on a DIN rail, or be fixed on the lateral slot.

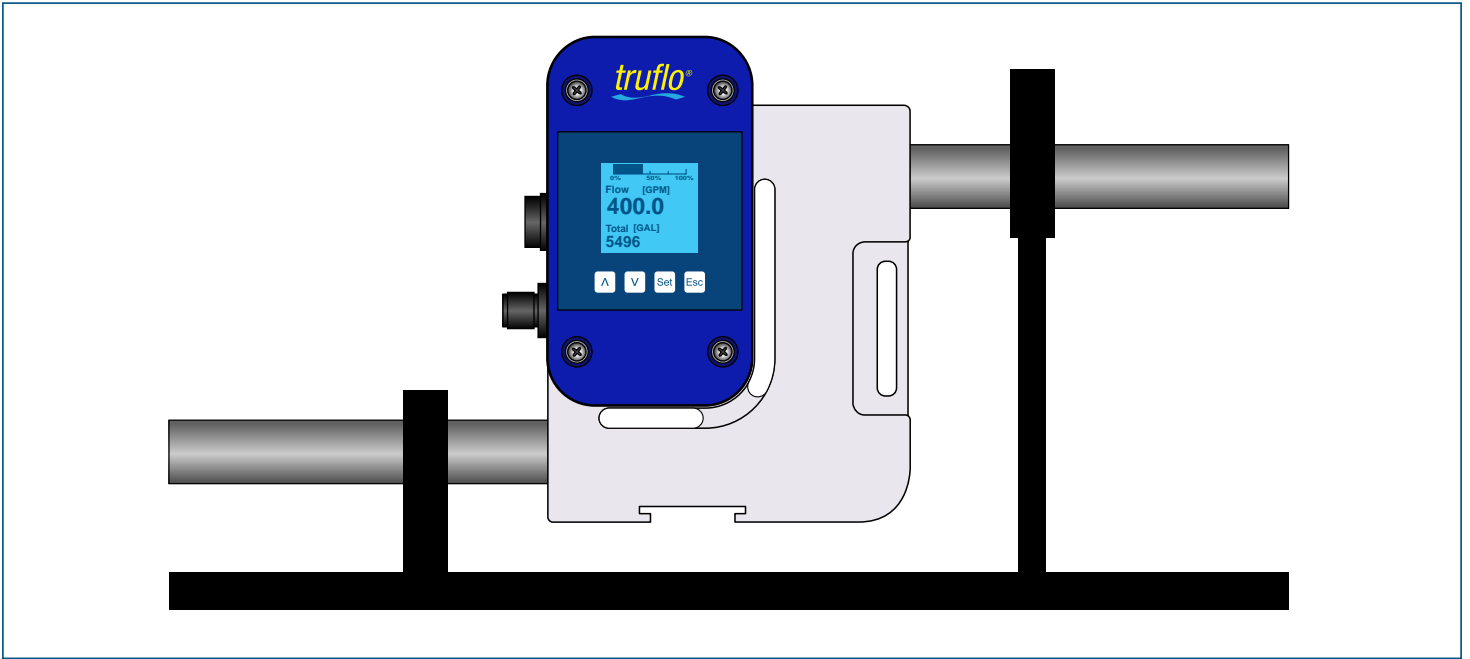

Fig. 5: Fixing Flowmeter

i Flowmeter must be installed without mechanical tensions on the existing pipe system. The flow meter may be damaged if there is tension on the existing pipe system.

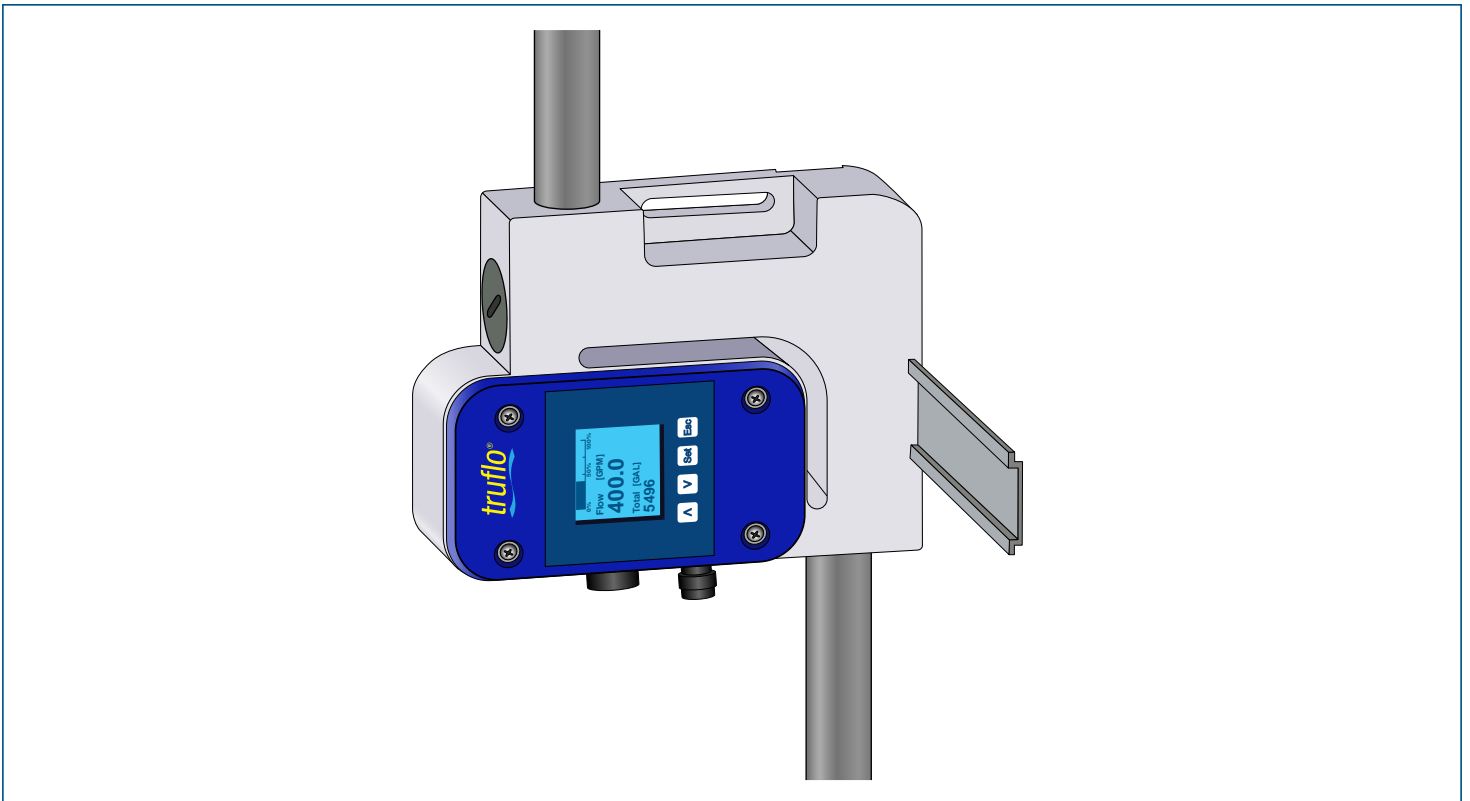

Fig. 6: Flowmeter Mounted on a DIN Rail



Non-compliance of the installation instructions may result in tearing of the housing, liquid may leak out.

Electrical Wiring

Serious injury or death from electric shock may occur if wiring, installation, disassembly or remove of wires is performed while electrical power is energized.

 Always shut off or disconnect electrical power at service panel and lock switch or breaker and tag to prevent energizing electrical power during work or while Flowmeter is not assembled and installed.

Wiring installation, disassembly and removal must be performed by qualified persons experienced and knowledgeable about electrical work.

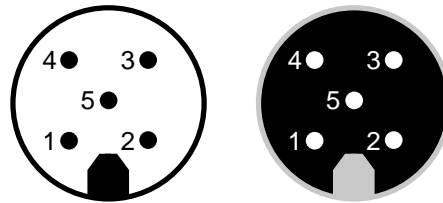



Fig. 7: Pin code: Connection plug / Socket for 5-pin version

Connector cable pin configuration defined by manufacturer The outlets may be re-programmed for specific applications

Pin	Function	Description
1	L+	Power supply : 18...30 VDC
2	Pulse output O1 alternative:	Digital Output Q1 Freely adjustable ranging from 0.1 to 3000 ml/pulse in 0.1 ml/pulse steps, npn-Transistor, max. load 30V/100mA. Max. Voltage must be less than the supply voltage.
	1. Empty pipe output	Configurable output of 0V or 24V when pipe is empty.
	2. Dosing output	Configurable output of 0V or 24V
	3. Upper or Lower Limit output	Configurable output of 0V or 24V when reaching upper or lower limit
	4. Negative flow	Configurable output of 0V or 24V when liquid flows in negative direction
3	GND	Ground : 0 V
4	Communication	Communication interface
5	Analog output QA	4-20mA ; 0-20mA Example: 0L/min => 4mA 60L/min => 20mA Empty pipe Alert => 3.5mA (4-20mA depending on the configured limits)

 **Attention :** Only operate the Flowmeter within the operating limits stipulated on the product label and the operating manual / data sheet. Use outside these conditions lead to overloads which cause permanent damage.

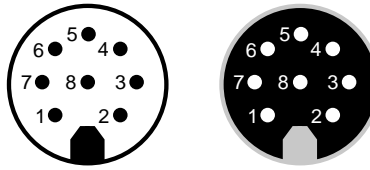

Fig. 8: Pin code: Connection plug / socket for 8-pin version

Connector cable pin configuration defined by manufacturer
The outlets may be re-programmed for specific applications.

Pin	Function	Description
1	L+	Power supply : 18...30 VDC
2	Pulse output O1 alternative:	Digital Output Q1 Freely adjustable ranging from 0.1 to 3000 ml/pulse in 0.1 ml/pulse steps, npn-Transistor, max. load 30V/100mA. Max. Voltage must be less than the supply voltage.
	1. Empty pipe output	Configurable output of 0V or 24V when pipe is empty.
	2. Dosing output	Configurable output of 0V or 24V
	3. Upper or Lower Limit output	Freely adjustable ranging from 0.1 to 3000 ml/pulse in 0.1 ml/pulse steps.
	4. Negative flow	Configurable output of 0V or 24V when flow reaches upper or lower limit.
3	GND	Ground : 0 V
4	Digital output Q2 Functions:	Digital output Q2 Configurable npn- or pnp-Transistor, max. Load 30V/ 100mA. Max. Voltage must be less than the supply voltage.
	1. Empty pipe output	Configurable output of 0V or 24V when pipe is empty.
	2. Dosing output	Configurable output of 0V or 24V
	3. Pulse output	Freely adjustable ranging from 0.1 to 3000 ml/pulse in 0.1 ml/pulse steps.
	4. Upper or Lower Limit output	Configurable output of 0V or 24V when flow reaches upper or lower limit.
	5. Negative flow	Configurable output of 0V or 24V when liquid flows in negative direction.
5	Analog output QA	4-20mA ; 0-20mA Example: 0L/min => 4mA 60L/min => 20mA Empty pipe Alert => 3.5mA (4-20mA depending on the configured limits)
6	Communication	Communication Interface
7	Digital input I1	Digital input I1
	1. Dosing output	Starts the dosage by a rising edge of 24V.
	2. Set offset	The Offset is set by a rising edge of 24V.
	3. Reset counter	Reset of the counter by a rising edge of 24V.
	4. Creeping flow off	Creeping suppression is deactivated as long as there are 24V at the input.
8	Shielding	EMC safety

i Attention : Only operate the Flowmeter within the operating limits stipulated on the product label and the operating manual / data sheet. Use outside these conditions lead to overloads which cause permanent damage.

Commissioning

NOTE : If Flowmeter is used for a fluid other than water the "basic trim" has to be carried out during commissioning. Therefore the device has absolutely be filled with medium.

The basic trim can be done on the device display (alternatively Programtool). During the adjustment the medium may not flow as it affects the function

Operation

If Flowmeter is used as volume flowmeter for water or water-like liquids, it will not require on-site calibration. Parameters for water are calibrated at the factory. Notwithstanding the Flowmeter may also be supplied with customized settings. The coordination must be done at time of purchase order.

NOTE : If necessary, e.g. if viscosity and/or speed of sound deviate significantly from water, the pre-set parameters can be adjusted via Programtool. It is always necessary to adjust the manufacturer pre-set parameters when using the Flowmeter as a dosing device according to section 3.2 (Dosing 1. Flowmeter as a dosing device). Adjusting the manufacturer pre-set parameters requires Programtool.

The following parameters may be changed to settings suitable for the individual conditions: for 5-pin version

- ❑ Digital output Q1, function and behavior
- ❑ Analog output QA, function and behavior
- ❑ Flow range, for which shall apply 4...20 mA
- ❑ Pulse value
- ❑ Creeping suppression
- ❑ Optimization of measurement curve with up to 8 interpolation values (medium matrix)

The following parameters may be changed to settings suitable for the individual conditions: for 8-pin version

- ❑ Digital output Q1, function and behavior
- ❑ Digital output Q2, function and behavior
- ❑ Digital input I1, function and behavior
- ❑ Analog output QA, function and behavior
- ❑ Flow range, for which shall apply 4...20 mA
- ❑ Pulse value
- ❑ Creeping suppression
- ❑ Optimization of measurement curve with up to 8 interpolation values (medium matrix)

Also reference the UltraFlo® operating instructions

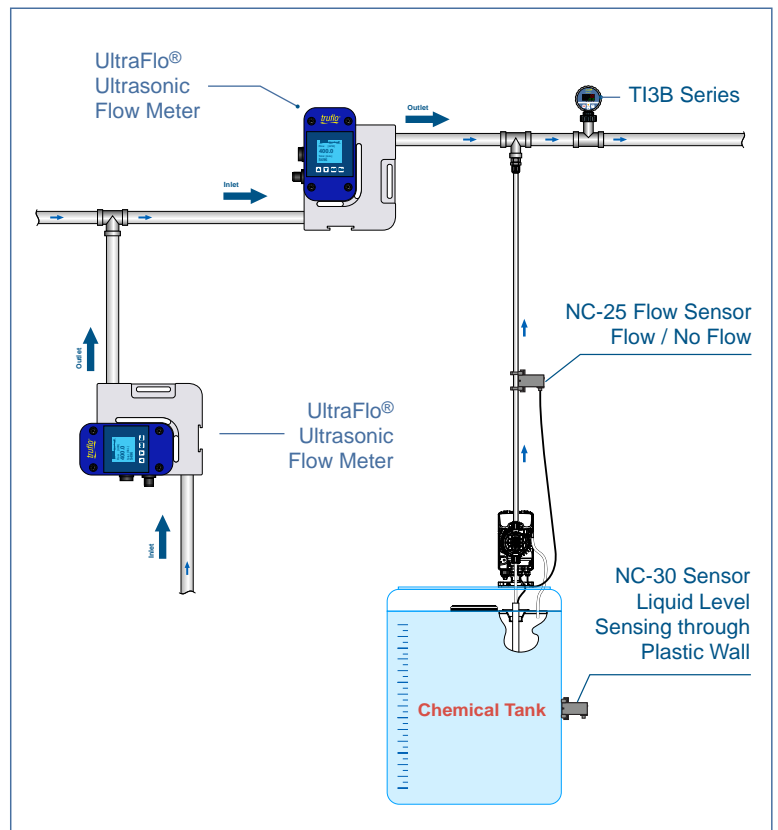

Display and User Menu

Flowmeter is equipped with a display to visualize actual measurement values and to change parameters of the flow meter. Menu navigation and parameter changes are controlled by the four keys on the keypad.

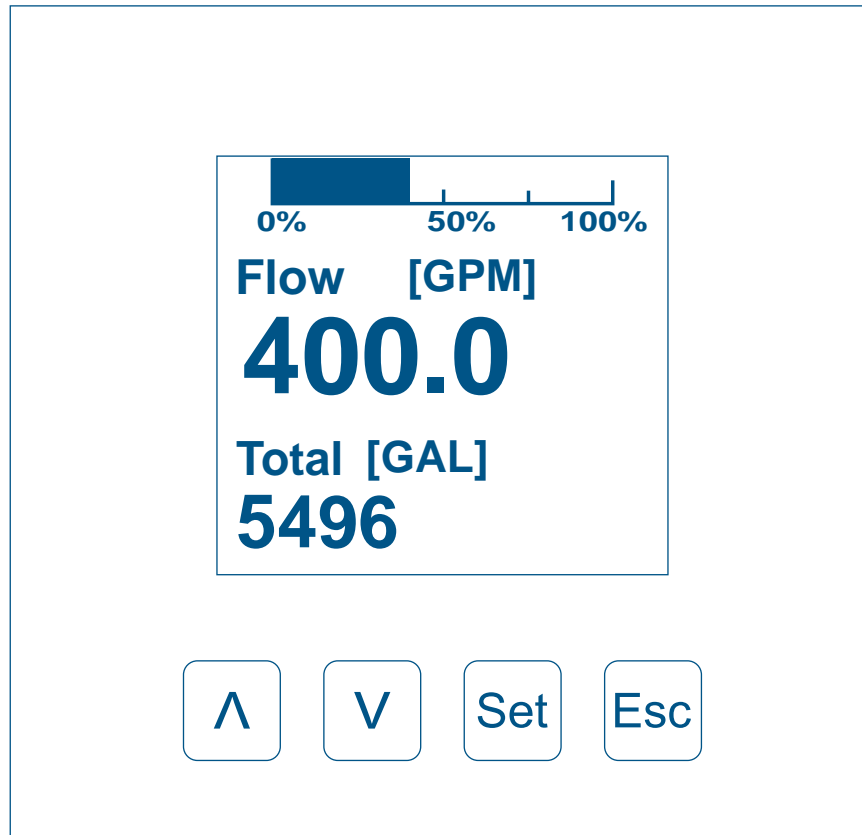







Fig. 9: Operating with the key pad

Press the **[Set]**  key to display the main menu. Different menu options can be selected by using the two arrow keys.

To enter e.g. analog limits "Analog output - Upper limit" use the arrow  or  keys to change values and press **[Set]**  key to confirm. To switch back to the last menu level press the **[Esc]**  key. As soon as the operator tries to change values the user will be prompted to enter a password. Password protection is used to ensure changes to values or configurations are done by authorized personnel.

The default password for Flowmeter is **41414**. The password can be changed with Programmtool. The user level will remain active for 5 minutes after the last press on any button.

 **The Password should only be shared with personnel authorized to make changes to setting.**

NOTE : Always the first parameter of the menu appears in the display. This need not be the adjusted enabled parameter. The enabled parameter appears inverted and possibly visible by scrolling.

NOTE : Functions marked with asterisk (*) are only available for the Flowmeter 8-pin version. Flowmeter without user display supports the same functions as the display-version. The display and programming unit Programmtool is needed to change configurations of Flowmeter without user display.

Menu Organization for 5-Pin Version

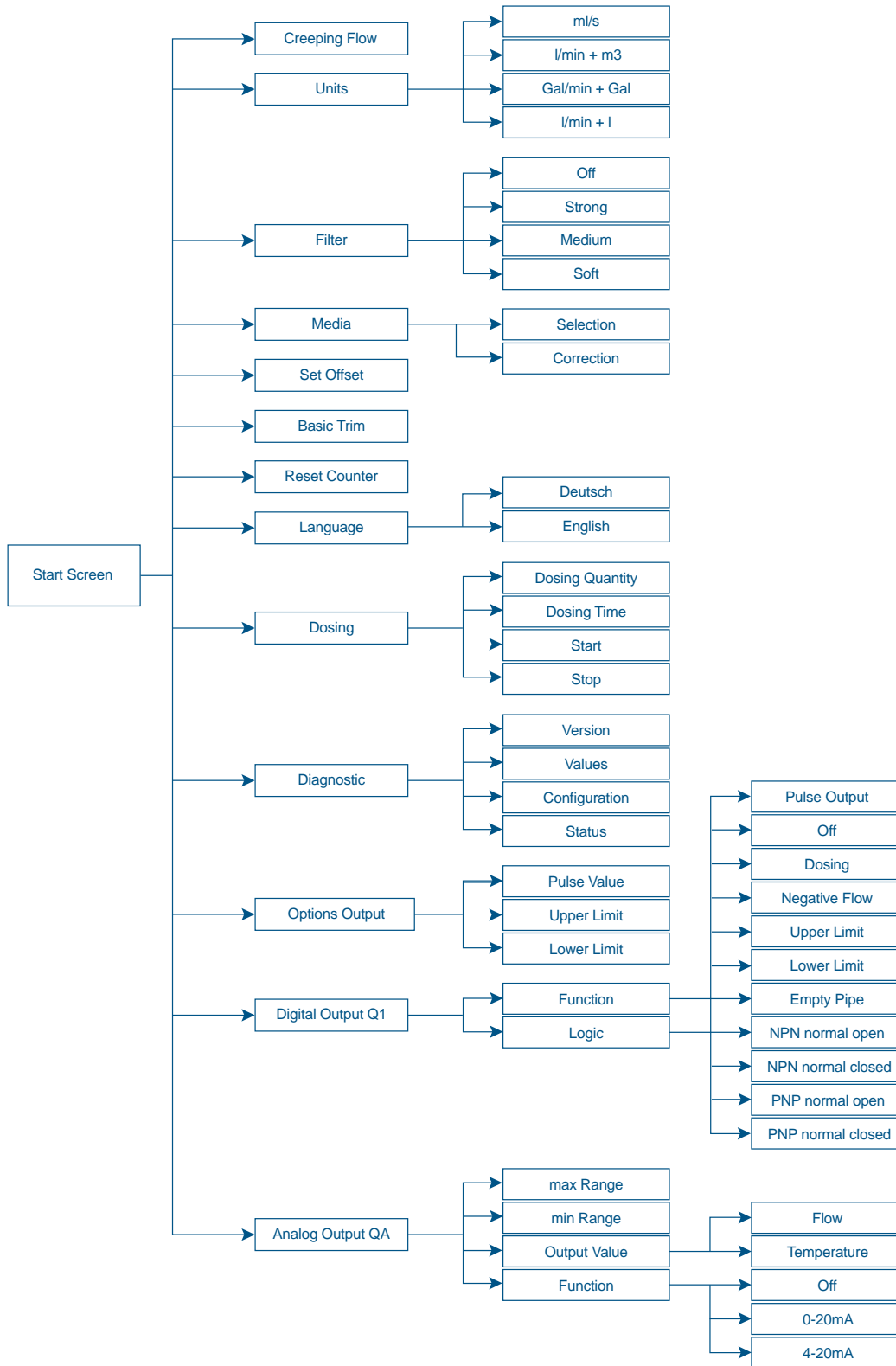

Menu Organization for 8-Pin Version

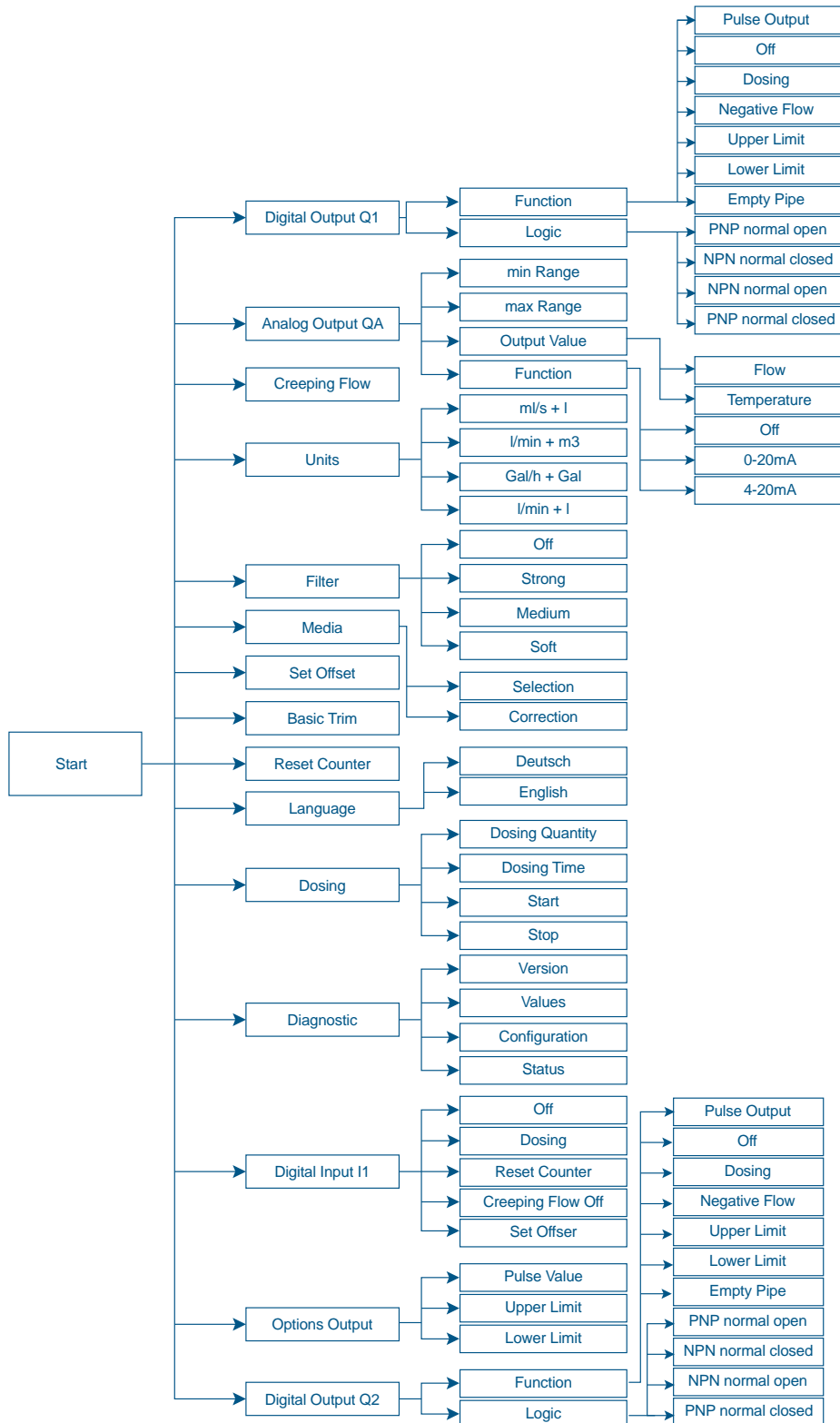

Functionalities of flow meter and default settings

Set Offset

In the sub menu “Set Offset” it is possible to set the actual offset of the flow meter. Use this function only when UltraFlo is completely filled with liquid, and there is no flow. If the offset is set while flow is present or when the pipe is empty it will cause an offset drift what results in a faulty measurement.

A small offset change, e.g. caused by variable temperatures, is automatically done by the flow meter. It is also possible to set the offset via the configurable digital inputs.

Language

The language of the display can be changed. Available languages are English and German.

Filter

The function “Filter“ averages the analog output signal. Possible settings: Soft, Medium, Strong, Off. The analog output signal reacts faster to signal changes when average determination is set to “soft”. Whereas the analog output signal reacts slower when average determination is set to “strong”.

Units

UltraFlo is able to show actual flow or the volume in different units. Following units can be selected: ml/s + l , Gal/min +Gal , l/min + l , l/min + m³.

The first letters correspond to the unit of the flow value. The letters after the + correspond to the unit of the volume value.

Reset Counter

The volume counter of UltraFlo can be reset.

 **Important!** : Once reset, counter values cannot be restored. After a reset the counter works normally.

Basic Trim

NOTE : The “Basic Trim” function insures that the flow meter is conforming to the media specific characteristics. To execute this function, UltraFlo runs a selfdiagnostic function which optimizes all important parameters. This process lasts approximately 1 minute.

 **Important!** : To make sure the basic trim is correctly done, the flow meter has to be filled with liquid without a flow.
When there is an error detected while performing the basic trim function, the display shows “Error”. After successfully finishing the basic trim function, the display will show “Done”.

Digital Outputs

All outputs switch over to high resistance when the supply is smaller than 18V. When overload or short circuit is detected the digital outputs are switched off after 100µs for a period of 2s. When time is up the outputs get applied again.

Empty Pipe Output		
	Empty Pipe	Filled, No Flow
0V Normal Closed	High resistant	0V
0V Normal Open	0V	High resistant
24V Normal Closed	High resistant	24V
24V Normal Open	24V	High resistant

Pulse Output			
	Empty Pipe	Filled, No Flow	Filled, Flow
0V Normal Closed	0V	0V	0V Pulses
0V Normal Open	0V	0V	0V Pulses
24V Normal Closed	High Resistance	High Resistance	24V Pulses
24V Normal Open	High Resistance	High Resistance	24V Pulses
Upper Limit Output			
	Below Lower Limit	Between the Limits	Above Upper Limit
0V Normal Closed	High resistance	High resistance	0V
0V Normal Open	0V	0V	High resistance
24V Normal Closed	High Resistance	High Resistance	24V
24V Normal Open	24V	0V	High resistance
Lower Limit Output			
	Below Lower Limit	Between the Limits	Above Upper Limit
0V Normal Closed	0V	High Resistance	High Resistance
0V Normal Open	High Resistance	0V	0V
24V Normal Closed	24V	High Resistance	High Resistance
24V Normal Open	High Resistance	24V	24V
Dosing Output			
	Startup of Device	While Dosing	Before/After Dosing
0V Normal Closed	High Resistance	High Resistance	0V
0V Normal Open	High Resistance	0V	High Resistance
24V Normal Closed	High Resistance	High Resistance	24V
24V Normal Open	High Resistance	24V	High Resistance

i Important! When using the dosing function the output should not be configured as normal closed!
If the dosing output is configured as normal closed the valve will stay open after the

□ Digital output Q1

Digital output Q1 may be used as pulse output, empty pipe detection, for switching dosing valve or limit control. By using Programtool the user can switch between npn and pnp-transistor logic. In case of inductive load a diode has to be connected parallel to the coil.

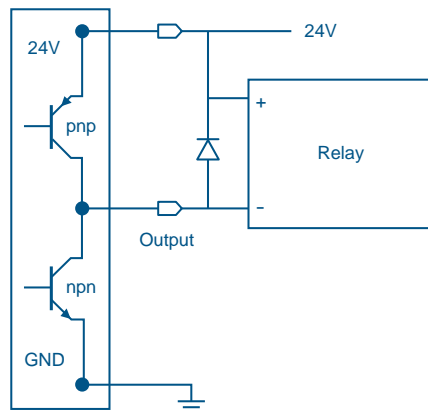

Fig. 5: Connecting Output Q1 to Relay

Setting area : off, pulse output, empty pipe, dosing output, lower limit, upper limit, negative flow

❑ Digital output Q2*

Digital outputs 2 may be used as pulse output, empty pipe detection, for switching dosing valve, limit control or flow direction control. See Page- 7 **Electrical Wiring** table connection

The **npn** or **pnp** logic can be selected. When the output is connected to an inductive consumer a diode has to be installed parallel to the load.

Flowmeter via pnp, external counter e.g. PLC

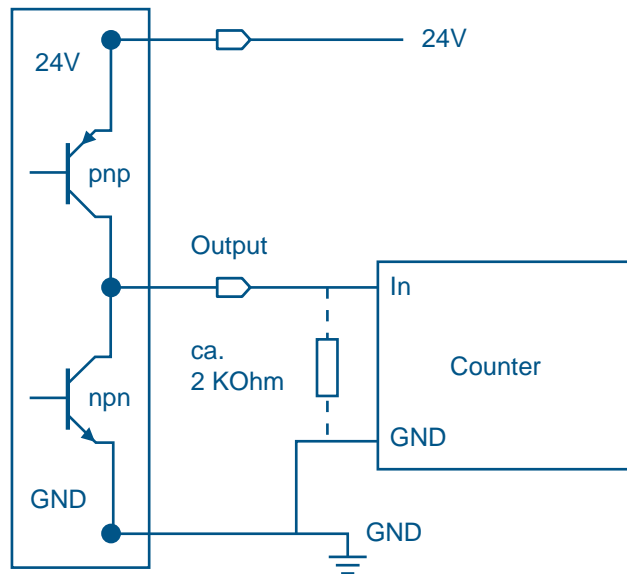

Fig. 6: Connecting Output Q2 to counter

Setting area : off, pulse output, empty pipe, dosing output, lower limit, upper limit, negative flow

i Important! Inductive load on the digital outputs without an installed diode may cause damage on the Flowmeter electronics. dosing batch.

Dosing Function

Dosing can be determined in different ways :

1. Flowmeter as dosing device (dosing control via Flowmeter)

Flowmeter controls the complete dosing function. The dosing quantity (e.g. 400 ml) is pre-set in the Flowmeter via Programmtool. Dosing starts, as soon as line start of dosing is wired to 24 V, e.g. via a pushbutton. Flowmeter will now open the dosing valve via the output configured for it. When the pre-set dosing quantity is reached, the dosing valve is closed via the above output. The second output can be used independently for signalling empty pipe, limit control, pulse output or signalling negative flow.

2. Flowmeter as flowmeter (dosing control via dosing equipment)

The dosing equipment controls the entire dosing function. The dosing quantity is fixed in the dosing equipment control during commissioning by pre-selecting the meter pulses. Dosing starts, when the relevant pushbutton of the dosing equipment is pushed. The control will now open the dosing valve. From now on Flowmeter will send a voltage pulse to the control for each volume unit that has flown through (e.g. per 1ml). When the pre-selected pulse quantity is reached, the control closes the dosing valve. In this case, output 1 is used to send out pulses, output 2 is independently usable for empty pipe detection, limit control or signalling negative flow.

⚠ The customer has to provide an emergency stop and an overfilling stop to prevent hazardous situations. Both functions must perform safety shut down of pumps and WARNING! closing of valves.

❑ Pulse value

This section determines the output settings for pulsed outputs.

Choose configuration such as to neither exceed the maximum output frequency of the Flowmeter (10kHz) nor the maximum input frequency of the control. If the maximum frequency is exceeded the Flowmeter will not output pulses correctly.

Example	2.0 ml/Pulse
This Means	a pulse is emitted every 2.0 ml.
Setting Range	0.1...3000.0 ml/Pulse, in 0.1 ml/Pulse steps
Default Setting	1.0 ml/Pulse

Flow	Pulse value	Frequency	Period	Duration of the Pulse	
ml/s	ml/Pulse	Hz	s	s	ms
1	1	1	1	0.5	500
100	1	100	0.01	0.005	5
1000	0.1	10000	0.0001	0.00005	0.05
100	10	10	0.1	0.05	50
0.5	10	0.05	20	1	50

In the last case every 20 seconds, a pulse of 1 second duration is put out.

Dosing

The Flowmeter can be configured for manually dosing by choosing the dosing function via the user display. The Volume "Dosing Batch" and the "Dosing Time" are freely adjustable. When the "Dosing Time" is set to zero, the timer control is inactive. A dosage can be started and stopped with the menu function keys "Start" and "Stop".

Setting Range "Dosing Batch"	0 - 3500 Liters
Setting Range "Dosing Time"	0 -30000 Seconds
Default Setting "Dosing Batch"	0 Liters
Default Setting "Dosing Time"	3 Seconds

i **Important!** If Dosing Time = 0 the time switch-off is inactive.

❑ Analog output QA

The analog output is available as current output 4-20mA or 0-20mA. This is selected with the purchase order. As standard it comes with current output 4-20mA. It can also be switched off by using Programmtool.

The current output ranges from 0 to 22.6mA measuring the flow rate or the condition of the flow measurement.

The values here signify for 4-20mA configuration

- ❑ 20 mA the upper limit of the relevant measurement
- ❑ 4 mA the lower limit of the relevant measurement
- ❑ 3.5 mA empty pipe

Upper and lower limit parameters can be set within the type-specific measurement of the device. By default zero flow is set at 4 mA and the maximum flow is set at 20 mA

Setting range	0-20mA, 4-20mA, off
Output value	Flow, Temperature

i **Important!** When current output is used, the load must not be higher than 500 Ohm. A higher load prevents the device from providing the maximum current of 22.6mA

Characteristic Curves Analog Output

0 - 20mA

For the following graphic "min Range" is used for 0% and "max Range" is used for 100%.

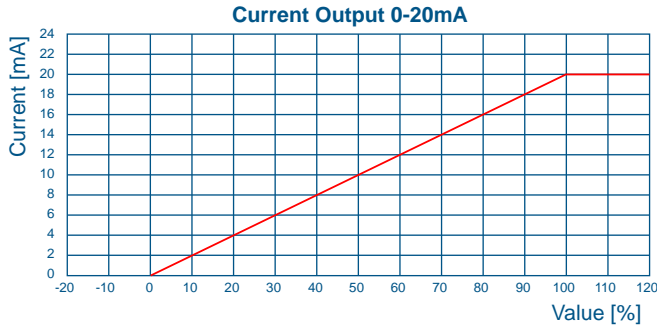

Value	Current [mA]
Smaller 0%	0
0% (min Range)	0
Between 0% and 100%	Linear interpolation from 0 to 20 mA
100% (max Range)	20
Bigger 100%	20

4 - 20mA

For the following graphic "min Range" is used for 0% and "max Range" is used for 100%.

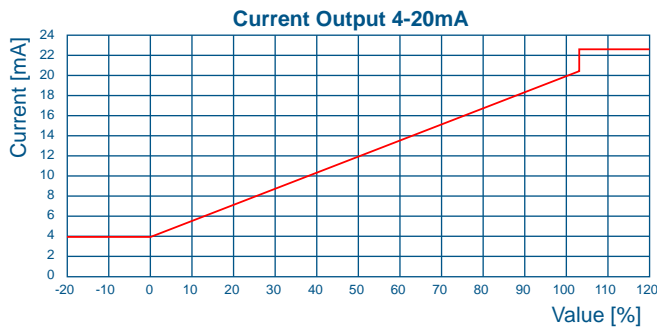

Value	Current [mA]
Empty pipe	3.5
Smaller -1.2%	3.8
Between -1.2% and 0%	Linear interpolation from 3.8 to 4mA
0% (min Range)	4
Between 0% and 100%	Linear interpolation from 4 to 20mA
100% (max Range)	20
Between 100% and 103%	Linear interpolation from 20 to 20.5mA
Bigger 103%	22.6

Filter options for Analog Output

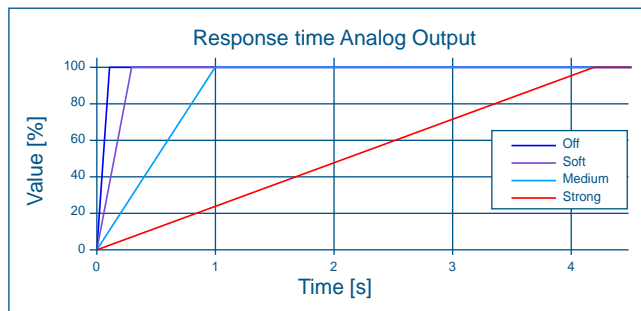

Filter	100%
off	16ms
soft	0.3s
medium	1s
strong	4.2s

Creeping Suppression

The creeping suppression excludes flow measurements that result from convection in a narrow band around zero, even with a closed valve. At the factory, the creeping suppression is set at a standard value in relation to the cross-section of the flowmeter.

There are higher tolerances below the Standard Default Settings.

- Setting range : 0.0...20 l/min, in 0.006 l/min steps
- Default settings : 0.09 l/min for DN7 / 3/8", LowFlow option 0.03l/min
- 0.3 l/min for DN10 / 1/2"
- 0.9 l/min for DN15 / 3/4"
- 1.2 l/min for DN20 / 1"

The Creeping Suppression Works with a Hysteresis of -25%.

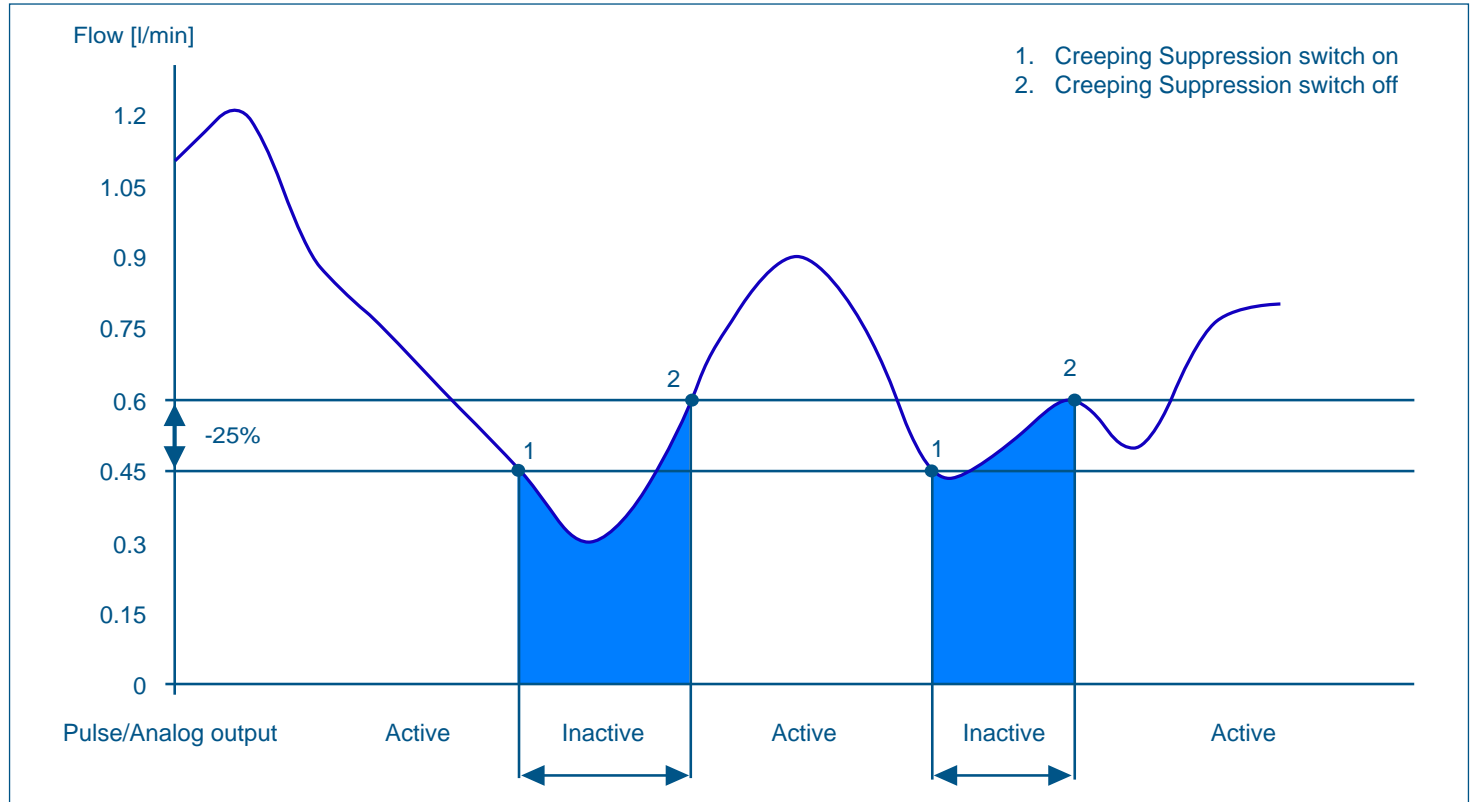

Fig. 7: Function of the creeping suppression illustrated with 0.6 l/min

Example : Creeping suppression = 0.6 l/min

If the flow rate is lower than 0.45 l/min the pulse output/analog output becomes inactive.

If the flow rate exceeds 0.6 l/min a pulse is output again and added to the totalizer.

Similarly, a value is transmitted to the analog output again.

Digital input

Flowmeter has a digital input that is programmable to following functions: dosing input, set offset, creeping suppression inactive and reset counter. In order to start a dosing process, 24V DC power is required. The status of the dosing parameters is modified with the Programmtool.

NOTE : The dosing input is locked so that a re-start is not possible during a running dosing process. After changing configurations via Programmtool a restart of the device is necessary to activate the doing input function.

Available Input Functions

	Set offset	Creeping flow off	Dosing	Reset Counter	off
0V	-	-	-	-	-
24V	Rising edge: 0->24V Set offset	State : deactivating creeping flow	Rising edge: 0->24V start dosing	Rising edge: 0->24 Vcounter is reset	-
Run only in stationary medium					

The input function "Set Offset" may only be used when there is no flow through the meter. If an offset trim is done while liquid flow is present an offset drift will cause measurement deviations. If the Flowmeter shows an offset drift caused by a wrong offset setting, run the function "Set Offset" or "Basic Trim" again with filled flow meter and no present flow.

Overview of Default Settings

Function	Default Settings
Digital output Q1	Pulse output as 24V normal open
Digital output Q2*	Empty pipe detection as 24V normal open
Digital input	No function assigned
Analog output QA	Current output
Current output	4-20mA
Current output QA	20mA -> 6 l/min for 3/8" 24 l/min for 1/2" 60 l/min for 3/4" 120 l/min for 1"
Pulse value	1 ml/pulse
Creeping suppression	0.09 l/min for 3/8", 0.03l/min LowFlow 0.3 l/min for 1/2" 0.9 l/min for 3/4" 1.2 l/min for 1"

General Information

Please check the following before powering the flowmeter for the first time:

- Check the electrical connections and cable allocations
- Check the installation position of the flowmeter. Are the direction of the arrow on the name plate and the actual flow direction in the pipe congruent?
- Is the measurement pipe completely filled with fluid?

When everything has been checked, switch on power. After 30 minutes with power running the measuring device reaches the maximum accuracy.

Now, Flowmeter is operational!

Exchange of Measuring Device

- Switch off power before disconnecting the electrical connections!
- Wiring installation, disassembly and removal must be performed by qualified persons experienced and knowledgeable about electrical work.
- Serious injury or death from electric shock may occur if wiring, installation, disassembly or remove of wires is performed while electrical power is energized
- Please note that after replacing the flowmeter



- a) the programming of the previous flowmeter should be saved and copied on the new flowmeter
- b) when using the dosing function, set a quantity

If the device requires a configuration change, the display and programming unit Programmtool is required.

Repair, Hazardous Substances

Before sending the flowmeter for repair, the following precautions must be taken:

⚠ Clean all process chemicals from the device. Fully rinse the flow path. Please pay close attention to the process fittings. All media must be removed before returning. This is particularly important, if the medium to be measured is health hazardous.

Devices judged to be insufficiently cleaned will be returned to sender. No inspection of device will be done until proper cleaning is completed by user.

Costs due to inadequate cleaning of the instrument for possible disposal or injury (burns, etc.) will be charged to the sender of the meter into account.

⚠ With the flowmeter send a detailed report describing the failure, the application and the physical-chemical properties of the medium parameters. (e.g. a decontamination declaration).

In order to be able to process your repair order quickly and smoothly it is important that you provide a technical contact person including phone and fax number as well as e-mail address.

Behavior of the Temperature Sensor

The integrated temperature sensor has no direct contact to the liquid and is used to calculate the expansion of the housing. The environment temperature greatly influences the actual temperature of the temperature sensor. The response time of temperature changes relates to the mounting position of the temperature sensor inside the housing.

Step-Response Time

Step-response time after a significant temperature change. (Filter "Off")

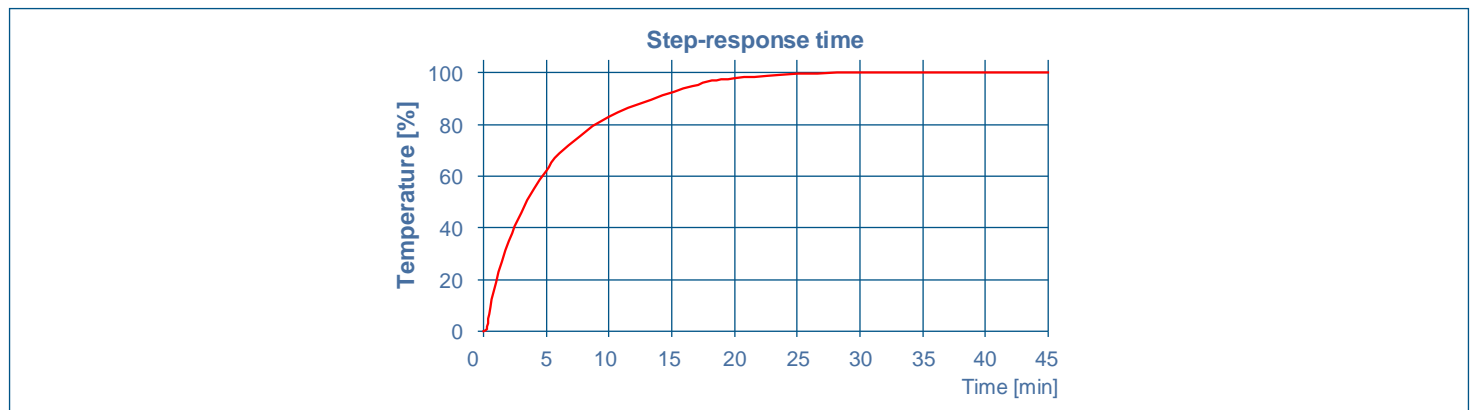

Filter Configurations for Temperature Sensor

Filter	100%
Off	1s
Soft	16s
Medium	1min
Strong	4min

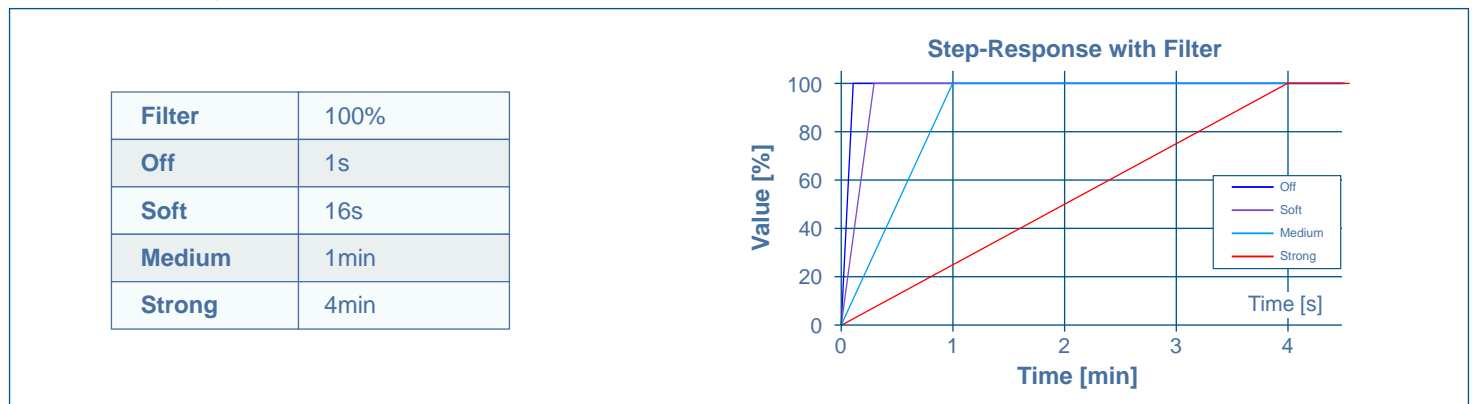

Influence of the environment temperature

In the table below some examples of the temperature influence are shown.

Liquid Temp	X	0.7	+	Environment temp.	X	0.3	=	Measured Temp.
40	X	0.7	+	20°C	X	0.3	=	34°C
40	X	0.7	+	20°C	X	0.3	=	37°C
40	X	0.7	+	20°C	X	0.3	=	40°C
60	X	0.7	+	20°C	X	0.3	=	48°C

Possible Error Text

Display text	Pulse value	Behavior
Empty Pipe	When "Empty Pipe" is detected, no flow measurement	Display flashing + text
Low Voltage	When power supply is less than 18V the outputs are inactive.	Display flashing + text
Short Circuit	When over load of the digital outputs is detected (>100mA), outputs are inactive.	Only text
Lower Limit	When the flow is less than an adjustable limit and the output is configured for limit control.	Only text
Upper limit	When the flow is more than an adjustable limit and the output is configured for limit control.	Only text
Sonic Speed	Actual sonic speed out of specified value. Run basic trim!	Only text

Dimensions [mm] & Weight

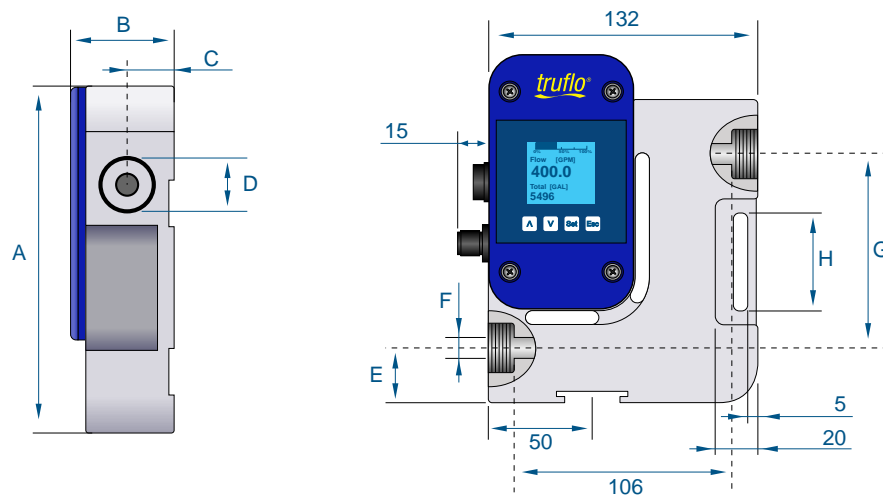

Nominal Diameter	Length A	Depth B	C	D [Inches]	Width E	F	G	H	Weight [g] PE-HD	Weight [g] PVDF
DN 5	167.5	50	23	G ½"	25	7	98	40	670	1100
DN 7	167.5	50	23	G ½"	25	7	98	40	670	1100
DN 10	170.5	50	23	G ¾"	26.5	10	95	40	720	1190
DN 15	175.5	55	25	G 1"	29	15	90	40	895	1470

Warranty, Returns and Limitations

Warranty

Icon Process Controls Ltd warrants to the original purchaser of its products that such products will be free from defects in material and workmanship under normal use and service in accordance with instructions furnished by Icon Process Controls Ltd for a period of one year from the date of sale of such products. **Icon Process Controls Ltd** obligation under this warranty is solely and exclusively limited to the repair or replacement, at **Icon Process Controls Ltd** option, of the products or components, which **Icon Process Controls Ltd** examination determines to its satisfaction to be defective in material or workmanship within the warranty period. Icon Process Controls Ltd must be notified pursuant to the instructions below of any claim under this warranty within thirty (30) days of any claimed lack of conformity of the product. Any product repaired under this warranty will be warranted only for the remainder of the original warranty period. Any product provided as a replacement under this warranty will be warranted for the one year from the date of replacement.

Returns

Products cannot be returned to **Icon Process Controls Ltd** without prior authorization. To return a product that is thought to be defective, go to www.iconprocon.com, and submit a customer return (MRA) request form and follow the instructions therein. All warranty and non-warranty product returns to **Icon Process Controls Ltd** must be shipped prepaid and insured. **Icon Process Controls Ltd** will not be responsible for any products lost or damaged in shipment.

Limitations

This warranty does not apply to products which: 1) are beyond the warranty period or are products for which the original purchaser does not follow the warranty procedures outlined above; 2) have been subjected to electrical, mechanical or chemical damage due to improper, accidental or negligent use; 3) have been modified or altered; 4) anyone other than service personnel authorized by Icon Process Controls Ltd have attempted to repair; 5) have been involved in accidents or natural disasters; or 6) are damaged during return shipment to **Icon Process Controls Ltd** reserves the right to unilaterally waive this warranty and dispose of any product returned to **Icon Process Controls Ltd** where: 1) there is evidence of a potentially hazardous material present with the product; or 2) the product has remained unclaimed at Icon Process Controls Ltd for more than 30 days after Icon Process Controls Ltd has dutifully requested disposition. This warranty contains the sole express warranty made by **Icon Process Controls Ltd** in connection with its products. **ALL IMPLIED WARRANTIES, INCLUDING WITHOUT LIMITATION, THE WARRANTIES OF MERCHANTABILITY AND FITNESS FOR A PARTICULAR PURPOSE, ARE EXPRESSLY DISCLAIMED.** The remedies of repair or replacement as stated above are the exclusive remedies for the breach of this warranty. **IN NO EVENT SHALL Icon Process Controls Ltd BE LIABLE FOR ANY INCIDENTAL OR CONSEQUENTIAL DAMAGES OF ANY KIND INCLUDING PERSONAL OR REAL PROPERTY OR FOR INJURY TO ANY PERSON. THIS WARRANTY CONSTITUTES THE FINAL, COMPLETE AND EXCLUSIVE STATEMENT OF WARRANTY TERMS AND NO PERSON IS AUTHORIZED TO MAKE ANY OTHER WARRANTIES OR REPRESENTATIONS ON BEHALF OF Icon Process Controls Ltd.** This warranty will be interpreted pursuant to the laws of the province of Ontario, Canada.

If any portion of this warranty is held to be invalid or unenforceable for any reason, such finding will not invalidate any other provision of this warranty

For additional product documentation and technical support visit www.iconprocon.com | e-mail: sales@iconprocon.com support@iconprocon.com | Ph: 905.469.9283



Corrosion-Free
Instrumentation Equipment

CORROSION

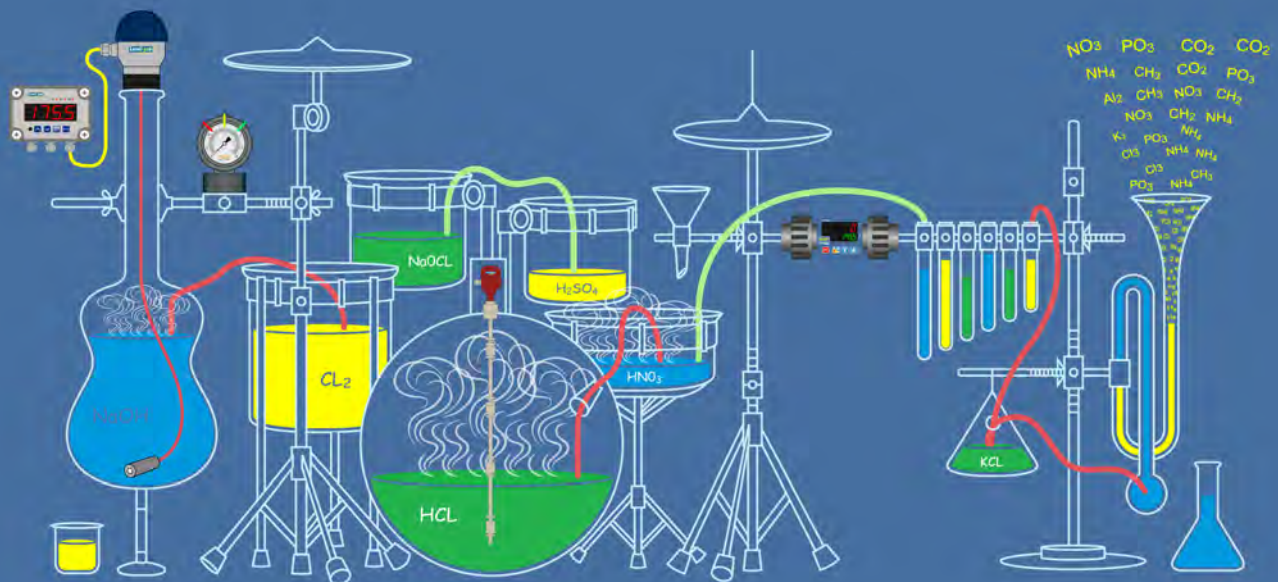

We Measure & Control
All Kinds of Corrosive Liquid S#*o%

'Industry's Most Extensive Line of
Corrosion-Free Instrumentation' Equipment'



Corrosion-Free
Instrumentation Equipment