

Krautkrämer USM Go / USM Go+

Operating Manual

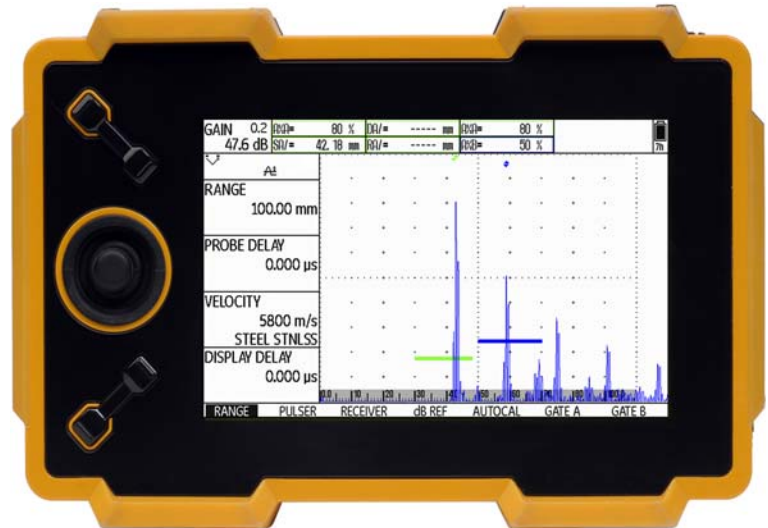

This Rev. 10 (06/2021) applies to the following software versions:

USM Go: 2.08 (March 6, 2013)

USM Go+: 2.08 (May 28, 2013)

You will find the software version and the serial number of your instrument on the second operating level (CONFIG2 - ABOUT)

© Baker Hughes Digital Solutions GmbH | Technical content subject to change without notice.

First operating level (Base)

range 5.00 mm	VOLTAGE LOW	FREQUENCY BROADBAND	MODE OFF	gate a start 0.72 mm	gate a start 0.72 mm	gate b start 90.00 mm
PROBE DELAY 0.000 μs	ENERGY LOW	RECTIFY RF	REFERENCE (NO REF)	s-ref1 12.50 mm	gate a width 2.50 mm	gate b width 20.00 mm
VELOCITY 3200 m/s STEEL MILD (S)	DAMPING 50 OHM	DUAL OFF	RECORD (NO REF)	s-ref2 100.00 mm	A THRESHOLD 70%	B THRESHOLD 30%
DISPLAY DELAY 0.000 μs	PRF MODE AUTO LOW 400 Hz	REJECT 0%	DELETE REF	RECORD OFF	TOF MODE FLANK	TOF MODE PEAK
RANGE	PULSER	RECEIVER	dB REF	AUTOCAL	GATE A	GATE B

To change between the first and the second operating level:

USM Go: Press the joystick for 2 seconds.

USM Go+: Press the center key of the keypad for 2 seconds.

First operating level (Options)

gate a start 12.50 mm
AUTO80
RECORD 0 POINTS
FINISH (NO CURVE)

DAC/TCG

gate a start 12.50 mm
REFERENCE TYPE BW
REF SIZE -----
RECORD REF (NO REF)

DGS

A INDICATION ***** (RUNNING)
B REFERENCE *****
C ATTENUATION *****
D DL1 RATING *****

AWS DL1

gate a start 12.50 mm
AUTO80
RECORD 0 POINTS
FINISH (NO CURVE)

JISDAC

gate a start 12.50 mm
AUTO80
RECORD 0 POINTS
FINISH (NO CURVE)

CNDAC

To change between the first and the second operating level:

USM Go: Press the joystick for 2 seconds.

USM Go+: Press the center key of the keypad for 2 seconds.

Second operating level

MEMO/HDR	FILENAME	REPORT	VIDEO
HEADER EDIT <NEW HEADER>	FILENAME FILES	IMAGE IN REPOR YES	SOURCE/DEST MEMORY
MEMO EDIT <NEW MEMO>	ACTION STORE REPORT	PARAM IN REPOR YES	FILENAME VID
MEMO IN REPORT NO	ENTER	PARAMETERS SUMMARY	MODE REPLAY
HDR IN REPORT NO	DIRECTORY GUI		ENTER
FILES	EVAL	dB REF	CONFIG1 CONFIG2 CONFIG3

SETUP			
MODE OFF			
REFERENCE (NO REF)			
RECORD (NO REF)			
DELETE REF			
FILES	EVAL	dB REF	CONFIG1 CONFIG2 CONFIG3

EVALMODE	TRIG	RESULTS	RESULTS2
EVAL MODE dB REF	PROBE ANGLE 45.0 1.00 (K)	READING 1 A%A	MODE SMALL
COLOR LEG OFF	THICKNESS 50.00 mm	READING 2 SA	READING 5 A%A
MAGNIFY GATE GATE A	X VALUE 0.00 mm	READING 3 A%B	READING 6 A%B
AGT OFF	O-DIAMETER FLAT	READING 4 SB	LARGE SA
FILES	EVAL	dB REF	CONFIG1 CONFIG2 CONFIG3

CODE	REGIONAL	STARTUP	DISPLAY
SERIAL NUMBER USMGO09100154	LANGUAGE ENGLISH	DATE 09. 01. 2013	COLOR SCHEME 3
CODE 000000	UNITS mm	TIME 11: 34	GRID GRID1 WO RULER
CONFIRM	DECIMAL PERIOD	ORIENTATION RIGHT HANDED	ASCAN COLOR BLUE
ECHO MAX OFF	DATE FORMAT D.M.Y 24H	JOY CONTROL ON	BRIGHTNESS 10
FILES	EVAL	dB REF	CONFIG1 CONFIG2 CONFIG3

Second operating level (continued)









SETUP	GATEMODE	SETUP 2	PULSER
FUNCTION 1 NONE NONE	GATE A LOGIC NEGATIVE	CAL REMINDER OFF	PULSER TYPE SQUARE
FUNCTION 2 FREEZE COPY	GATE B LOGIC POSITIVE	CAL RESET	PRF MODE AUTO LOW 400 Hz
ABOUT SHOW	B START MODE IP	USER GAIN STEP 10.0dB	PHANTOM PRF ON
ASCAN FILL OFF	OUTPUT SELECT A (-)	dB STEP 0.6	
FILES	EVAL	dB REF	CONFIG1
			CONFIG2
			CONFIG3
			◀▶









FREEZE	YEARLY CAL	TOF in LAYER	BEA
FREEZE MODE STANDARD	DATE 01.01	TOF in LAYER OFF	BEA OFF
ENVELOPE OFF	CAL REMINDER OFF	LAYER TYPE STANDARD	BW GAIN 9.5dB
ENVELOPE COLOR BLUE	CAL RESET	LAYER EDIT EDIT	
POWER SAVER 255 MIN			
FILES	EVAL	dB REF	CONFIG1
			CONFIG2
			CONFIG3
			◀▶

PARAM MODE	Auto Gain Ctrl		
PARAM MODE EXPERT	CTRL MODE OFF		
PARAM EDIT ENTER	MAX AMP.% 0		
PASSWORD ENTER	MIN AMP.% 0		
	NOISE LEVEL.% 0		
EVAL	dB REF	CONFIG1	CONFIG2
			CONFIG3
			CONFIG4
			◀▶



DR SETUP	DR NAV		
FILENAME <NEW FILE>	TOP 1A		
CREATE	BOTTOM 1A		
DR VIEW OFF	ADV DIRECTION RIGHT		
DR THICKNESS SBA			
dB REF	CONFIG1	CONFIG2	CONFIG3
			CONFIG4
			DR
			◀▶

Status display icons

Icon	Meaning
	SD memory card is inserted, flashes when the SD card is accessed
	Freeze active (Freeze), Display is „frozen“.
	Magnify gate is active
	Pulsar-receiver separation is turned off
	Pulsar-receiver separation is turned on
	Pulsar-receiver separation is turned on and set to through-transmission mode
	Reject function is active
	AGT is active
	One or more special functions programmed on the F1-F4 buttons

Icon	Meaning
	Angle-beam probe 30° ... 90°, flat surface, Reflection from the backwall
	Angle-beam probe 30°, curved surface, Reflection from the inner surface of tube
	Angle-beam probe 80°, curved surface, Reflection from the outer surface of tube
	Angle-beam probe 90°, surface wave
	DAC mode = TCG is active
	DGS reference echo has been recorded
	DGS reference echo has been recorded, transfer loss > 0
	dB REF is active
	Calibration reminder

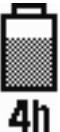
Power level indicators

Icon	Meaning
	Battery charge level, remaining operating time in hours (approximate value)
	Charger/power adapter is connected, percentage of battery charge level (approximate value)
	Warning: Low battery charge level, remaining operating time in minutes (approximate value)

Keypad functions

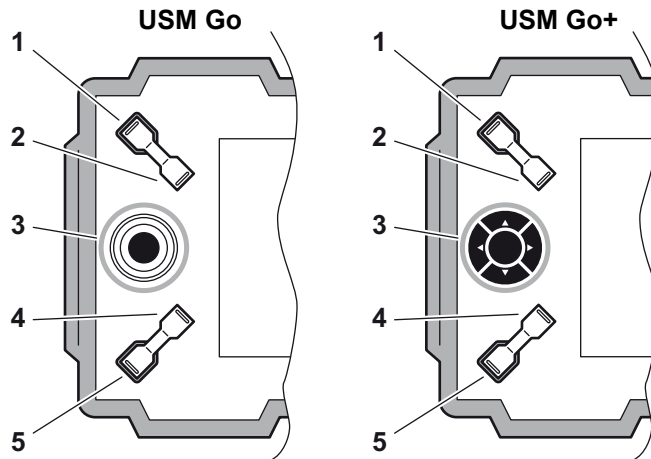

- 1 Increasing the gain level in increments
- 2 Decreasing the gain level in increments
- 3 Navigation operating levels and function groups
- 4 Function key 1, individually assignable
- 5 Function key 2, individually assignable

Navigation using joystick (USM Go) or keypad (USM Go+)

USM Go

USM Go+

Function



Navigation between function groups,
adjusting values

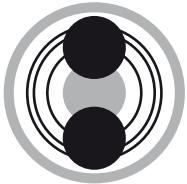

Navigation within a function group,
adjusting values



Changing between operating levels (press for 2 seconds)

0 Overviews

First operating level (Base) 0-3
 First operating level (Options) 0-4
 Second operating level 0-5
 Second operating level (continued) 0-6
 Status display icons 0-7
 Power level indicators 0-8
 Keypad functions 0-8
 Navigation using joystick (USM Go)
 or keypad (USM Go+) 0-9

1 Introduction

1.1 Safety information 1-2
 Battery operation 1-2
 Software 1-2
 Defects/errors and exceptional stresses . . 1-3

1.2 Important information on ultrasonic testing 1-3

Prerequisites for testing with ultrasonic test equipment 1-3
 Operator training 1-4
 Technical test requirements 1-4
 Limits of testing 1-5
 Ultrasonic wall thickness measurement . . 1-5
 Effect of the test object material 1-5
 Effect of temperature variations 1-6
 Measurement of remaining wall thickness 1-6
 Ultrasonic evaluation of flaws 1-6
 Flaw boundary method 1-6
 Echo display comparison method 1-7

1.3 The USM Go 1-8

Instrument versions USM Go and USM Go+ 1-9
 Options 1-10
 Special features of the USM Go 1-11

1.4 The DMS Go 1-12

1.5 How to use this manual 1-12

1.6	Layout and presentation in this manual	1-13	3.3	Connecting a probe	3-9
	Attention and note symbols.	1-13	3.4	Inserting the SD memory card	3-10
	Listings	1-13	3.5	Starting the USM Go	3-11
	Operating steps.	1-13		Powering On	3-11
2	Standard package and accessories			Powering Off	3-12
	2.1 Standard package.	2-2	4	Factory default setting (Reset)	3-12
	2.2 Add-on functions	2-3	4	Principles of operation	
	2.3 Preconfigured function packages.	2-4	4.1	Overview of operator's controls	4-2
	2.4 Recommended accessories.	2-5	4.2	Display screen	4-3
3	Initial start-up			A-scan representation.	4-3
	3.1 Instrument positioning	3-2		Functions on the display screen	4-4
	3.2 Power supply.	3-2		Gain.	4-5
	Operation with charger/power adapter . . .	3-2		Measurement line	4-5
	Operation using batteries	3-4		Status display icons	4-6
	Charging the batteries.	3-8		Alarms	4-6

4.3 Navigation and function keys 4-7
 Navigation 4-7
 Function keys 4-7
 Key combinations 4-8
 Power key 4-8

4.4 Operational concept 4-9
 Operating levels 4-9
 Selecting and setting functions 4-9
 Function HOME 4-11
 Activating functions 4-12

4.5 Important default settings 4-13
 Language setting 4-13
 Units setting 4-14
 Decimal separator 4-14
 Date format, Date, and Time 4-15
 Selecting the instrument orientation 4-16

4.6 Default settings of the display 4-16
 Selecting the color scheme 4-16
 Selecting the A-scan color 4-17
 Selecting the grid 4-18

Setting the brightness 4-18

4.7 Saving the settings 4-19
 Recalling settings 4-21
 Displaying dataset name 4-22

5 Operation

5.1 Overview of the functions 5-2
 Function groups first operating level 5-3
 Function groups second operating level . . 5-4

5.2 Setting the gain 5-6
 Setting the dB increment of gain 5-6

5.3 Assignment of function keys 5-8

5.4 Setting the display range (function group RANGE) 5-10
 RANGE 5-11
 PROBE DELAY 5-11
 VELOCITY 5-12
 DISPLAY DELAY 5-13

**5.5 Setting the pulser
(function group PULSER) 5-14**

VOLTAGE (pulser voltage) 5-14

ENERGY 5-15

WIDTH 5-16

DAMPING 5-17

PRF MODE (pulse repetition frequency) . . 5-17

**5.6 Setting the receiver
(function group RECEIVER) 5-19**

FREQUENCY 5-19

RECTIFY 5-20

DUAL (pulser-receiver separation) 5-20

REJECT 5-21

**5.7 Setting the gates
(function groups
GATE A and GATE B) 5-22**

Tasks of the gates. 5-22

A-START/B-START
(starting point of the gate) 5-23

A-WIDTH/B-WIDTH
(width of the gates) 5-23

A-THRESHOLD/B-THRESHOLD
(response and measurement
threshold of the gate) 5-24

TOF MODE 5-25

Starting point of gate B 5-27

Automatic gate height 5-28

5.8 Calibrating the USM Go 5-29

Calibrating the display range. 5-29

Choice of the measuring point 5-29

Calibration with straight-beam and
angle-beam probes 5-30

Calibration using dual-element probes . . 5-34

5.9 Making measurements 5-37

General notes 5-37

**5.10 dB-difference measurement
(function group dB REF) 5-38**

Recording a reference echo 5-39

Deleting a reference echo 5-39

Echo height comparison 5-40

5.11 Rating of welds (function group AWS D1.1) 5-41
 Rating of welds according to AWS D1.1 . 5-42

5.12 Flaw position calculation with angle-beam probes 5-45
 PROBE ANGLE 5-46
 THICKNESS 5-47
 X VALUE 5-48
 O-DIAMETER 5-48
 COLOR LEG 5-49

5.13 Defining the probe angle 5-50
 BLOCK 5-51

5.14 Enabling options (Upgrade) 5-52

5.15 Configuring the USM Go for test tasks 5-53
 TOF MODE 5-53
 Phantom echo detector 5-58
 Configuring the measurement line 5-59
 Enlarged display of reading 5-62
 LARGE (alarm signal) 5-64

MAGNIFY GATE (spanning the gate) . . . 5-65
 Activating the magnify gate function 5-66
 Automatic A-scan freeze (Freeze) 5-68

5.16 Setting the display 5-70
 ASCAN FILL 5-71
 Working with Echo Max 5-72

5.17 General setup 5-73
 EVAL MODE 5-73
 Gate logic 5-74
 Selecting the pulser type 5-75
 Locking the joystick 5-76
 Configuring the alarm output 5-77
 Power saving mode 5-79
 TOF in LAYER 5-80
 Backwall echo attenuation (BEA) 5-82
 Displaying the envelope curve (ENVELOPE) 5-83
 Automatic gain control (Auto Gain Control) 5-84

Calibration reminder 5-86

Password protection 5-87

5.18 Distance-amplitude correction (DAC) . 5-91

Recording a DAC curve 5-92

Setting up the DAC 5-94

Turning the DAC evaluation off. 5-95

Deleting the DAC curve 5-96

Editing DAC points 5-96

Adding DAC points 5-97

Multiple DAC curves 5-97

AWS D1.1 in DAC/TCG 5-99

Sensitivity correction. 5-99

Echo evaluation using DAC/TCG 5-100

5.19 Distance-amplitude curve according to JIS Z3060-2002 (JISDAC) 5-102

Activating JISDAC (DAC according to JIS) 5-102

Recording a DAC curve 5-102

Setting up JISDAC 5-105

Sensitivity correction. 5-106

Turning the JISDAC evaluation off 5-106

Deleting the DAC curve. 5-107

Echo evaluation using DAC 5-107

5.20 Distance-amplitude curve according to JB/T4730 and GB 11345 (CNDAC) 5-109

Evaluations according to CNDAC 5-109

Standards and reference blocks 5-110

Activating the CNDAC. 5-111

Recording a DAC curve 5-111

Setting up CNDAC 5-114

Sensitivity correction 5-115

Adjusting reference lines. 5-116

Turning the CNDAC evaluation off 5-116

Deleting the DAC curve. 5-117

Echo evaluation using DAC 5-117

5.21 Evaluation according to the DGS method 5-119

Using the DGS for measurements 5-119

Validity of the DGS method. 5-121

Starting the echo height evaluation according to DGS 5-123

Basic settings for the DGS measurement 5-123

Recording a reference echo and turning the DGS curve on 5-125

Locks, error messages 5-127

Sound attenuation and transfer correction 5-128

Using multiple DGS curves 5-128

Turning the DGS evaluation off 5-129

Deleting a DGS reference echo 5-129

Probe data 5-130

trueDGS angle-beam probes 5-133

6 Documentation

6.1 Test reports 6-2

Storing test reports 6-2

Displaying test reports 6-4

Printing test reports 6-6

Deleting test reports 6-7

Storing the A-scan and parameters in the test report 6-9

6.2 Storing memos 6-10

Creating a new memo file 6-10

Editing a memo file 6-11

Attaching a memo file to test report 6-12

6.3 Storing a report header 6-13

Creating a new header file 6-13

Editing a header file 6-14

Including a header file in the test report . 6-15

6.4 Viewing and storing parameters 6-16

6.5 Videos 6-17

Recording a video 6-17

Viewing a video 6-19

6.6 Documentation using UltraMATE 6-21

6.7 Data Recorder (option) 6-22

Creating a Data Recorder file 6-23

Activating a Data Recorder file 6-25

Storing readings in the grid matrix 6-26

Deleting readings	6-27
A-scan preview	6-28
Viewing Data Recorder files	6-28
Turning the grid matrix on/off	6-29

7 Maintenance and care

7.1 Instrument care	7-2
7.2 Battery care	7-2
Battery care.	7-2
Charging the batteries.	7-3
7.3 Maintenance	7-3
7.4 Software updates	7-4
Download of update files.	7-4
Installing an update.	7-5

8 Interfaces and Peripherals

8.1 Interfaces	8-2
Overview	8-2
USB interface	8-3

Service interface (Mini RS232-C)	8-3
--	-----

8.2 Peripherals	8-4
----------------------------------	------------

9 Appendix

9.1 Function directory	9-2
9.2 EU Declaration of Conformity	9-11
9.3 Manufacturer/Service addresses	9-11
9.4 Environmental protection regulations 9-13	
WEEE directive (Waste Electrical and Electronic Equipment)	9-13
Disposal of batteries	9-14

10 Specifications

10.1 Specifications of	
USM Go and USM Go+	10-2
Display screen	10-2
Display	10-3
Connectors	10-3
Memory	10-4
Pulser	10-4
Receiver	10-5
Gates	10-6
Memory	10-6
Environment	10-7
Protection	10-8
Options	10-9
10.2 Specifications according to	
EN 12668	10-11

11 Index

Introduction 1

1.1 Safety information

The USM Go has been designed and tested according to IEC 61010-1, Safety requirements for electrical equipment for measurement, control and laboratory use, and was technically in perfectly safe and faultless condition when leaving the manufacturing works.

In order to maintain this condition and to ensure a safe operation, you should always read the following safety information carefully before putting the instrument into operation.



ATTENTION

The USM Go is an instrument for materials testing. Any use for medical or any other applications is not permitted!

The instrument may only be used in industrial environments.

The USM Go is waterproof according to IP67. It can be operated either with the corresponding lithium-ion batteries or with the charger/power adapter. The charger/power adapter meets the requirements of electrical safety class II.

Battery operation

For the battery operation of the USM Go, we recommend the corresponding lithium-ion battery. You should only use this battery for the battery operation.

You can charge the lithium-ion battery either within the instrument itself or in an external charger. If a lithium-ion battery is inserted, charging starts automatically as soon as you connect the charger/power adapter to the USM Go and to the mains power supply.

For power supply, please also see Chapter 3.2 **Power supply**, page 3-2. For the use of batteries, please also see Chapter 7.2 **Battery care**, page 7-2.

Software

According to the current state of the art, software is never completely free from errors. Before using any software-controlled test equipment, it is therefore necessary to make sure that the required functions operate perfectly in the intended combination.

If you have any questions about the use of your test equipment, please contact your nearest representative of Waygate Technologies.

Defects/errors and exceptional stresses

If you have reason to believe that a safe operation of your USM Go is no longer possible, you have to disconnect the instrument and secure it against unintentional re-connection. Remove the lithium-ion battery.

A safe operation is no longer possible for example

- if the instrument shows visible damages,
- if the instrument no longer operates perfectly,
- after prolonged storage under adverse conditions (e.g. exceptional temperatures or especially high air humidity, or corrosive environmental conditions),
- after being subjected to heavy stresses during transportation.

FCC compliance

This device complies with part 15 of the FCC Rules. Operation is subject to the following two conditions:

- 1 This device may not cause harmful interference.
- 2 This device must accept any interference received, including interference that may cause undesired operation.

This equipment has been tested and found to comply with the limits for a Class A digital device, pursuant to Part 15 of the FCC Rules. These limits are designed to provide reasonable protection against harmful interference when the equipment is operated in a commercial environment.

This equipment generates, uses, and can radiate radio frequency energy and, if not installed and used in accordance with the instruction manual, may cause harmful interference to radio communications.

Operation of this equipment in a residential area is likely to cause harmful interference, in which case the user will be required to correct the interference at his own expense.

1.2 Important information on ultrasonic testing

Please read the following information before using your USM Go. It is important that you understand and observe this information to avoid any operator errors that might lead to false test results. Such false test results could result in personal injuries or property damages.

Prerequisites for testing with ultrasonic test equipment

This operating manual contains essential information on how to operate your test equipment. In addition, there are a number of factors that affect the test results, but a description of all these factors goes beyond the scope of this operating manual. The three most important prerequisites for a safe and reliable ultrasonic inspection are:

- Operator training
- Knowledge of special technical test requirements and limits
- Choice of appropriate test equipment

Operator training

The operation of an ultrasonic test device requires proper training in ultrasonic test methods.

Proper training comprises for example adequate knowledge of:

- the theory of sound propagation,
- the effects of sound velocity in the test material,
- the behavior of the sound wave at interfaces between different materials,
- the propagation of the sound beam,
- the influence of sound attenuation in the test object and the influence of surface quality of the test object.

Lack of such knowledge could lead to false test results with unforeseeable consequences. You can contact for example NDT societies or organizations in your country (DGZfP in Germany; ASNT in the USA), or also Waygate Technologies, for information on the existing opportunities for training of ultrasonic inspectors as well as on the qualifications and certificates that can finally be obtained.

Technical test requirements

Every ultrasonic test is subject to specific technical test requirements. The most important ones are:

- the definition of the scope of inspection
- the choice of the appropriate test method
- the consideration of material properties
- the determination of limits for recording and evaluation.

It is the task of the those with overall responsibility for testing to ensure that the inspector is fully informed about these requirements. The best basis for such information is experience with identical test objects. It is also essential that the relevant test specifications be clearly and completely understood by the inspector.

Waygate Technologies regularly holds specialized training courses in the field of ultrasonic testing. The scheduled dates for these courses will be given to you on request.

Limits of testing

The information obtained from ultrasonic tests only refers to those parts of the test object which are covered by the sound beam of the probe used.

Any conclusions from the tested parts to be applied to the untested parts of the test object should be made with extreme caution.

Such conclusions are generally only possible in cases where extensive experience and proven methods of statistical data acquisition are available.

The sound beam can be completely reflected from boundary surfaces within the test object so that flaws and reflection points lying deeper remain undetected. It is therefore important to make sure that all areas to be tested in the test object are covered by the sound beam.

Ultrasonic wall thickness measurement

All ultrasonic wall thickness measurements are based on a time-of-flight measurement. Accurate measurement results require a constant sound velocity in the test object. In test objects made of steel, even with varying alloying constituents, this condition is mostly fulfilled. The variation of sound velocity is so slight that it is only

of importance for high-precision measurements. In other materials, e.g. nonferrous metals or plastics, the sound velocity variations may be even larger and thus affect the measuring accuracy.

Effect of the test object material

If the material of the test object is not homogeneous, the sound waves may propagate at different velocities in different parts of the test object. An average sound velocity should then be taken into account for the range calibration. This is achieved by using a reference block with a sound velocity equal to the average sound velocity of the test object.

If substantial sound velocity variations are expected, then the instrument calibration should be adjusted to the actual sound velocity values at shorter time intervals. Failure to do so may lead to false thickness readings.

Effect of temperature variations

The sound velocity within the test object also varies as a function of the material's temperature. This can cause appreciable errors in measurements if the instrument has been calibrated on a cold reference block, whereas the measurement is carried out on a warm test object. Such measurement errors can be avoided either by adjusting the temperature of the reference block used for calibration or by taking the temperature effect into consideration on the basis of a correction factor obtained from published tables.

Measurement of remaining wall thickness

The measurement of the remaining wall thickness on plant components, e.g. pipes, tanks, and reaction vessels of all types which are corroded or eroded from the inside, requires a perfectly suitable gauge and special care in handling the probe.

The inspectors should always be informed about the corresponding nominal wall thicknesses and the likely amount of wall thickness losses.

Ultrasonic evaluation of flaws

In present-day test practice, there are basically two different methods of flaw evaluation:

If the diameter of the sound beam is smaller than the extent of the flaw, then the sound beam can be used to explore the boundaries of the flaw and thus determine its area.

If, however, the diameter of the sound beam is larger than the extent of the flaw, the maximum echo indication from the flaw must be compared with the maximum echo indication from an artificial flaw provided for comparison purposes.

Flaw boundary method

The smaller the diameter of the probe's sound beam, the more accurately the boundaries, i.e. the actual flaw area, can be determined by the flaw boundary method. If, however, the sound beam is relatively broad, the flaw area determined can substantially differ from the actual flaw area. Care should therefore be taken to select a probe which will give a sufficiently narrow sound beam at the position of the flaw.

Echo display comparison method

The echo from a small, natural flaw is usually smaller than the echo from an artificial comparison flaw, e.g. circular disc flaw of the same size. This is due, for instance, to the roughness of the surface of a natural flaw, or to the fact that the sound beam does not impinge on it at right angles.

If this fact is not taken into account when evaluating natural flaws, there is a risk of false evaluation.

In the case of very jagged or fissured flaws, e.g. shrink holes in castings, it may be that the sound scattering occurring at the boundary surface of the flaw is so strong that no echo at all is produced. In such cases, a different evaluation method should be chosen, e.g. use of the backwall echo attenuation in the evaluation.

The distance sensitivity of the flaw echo plays an important part when testing large components. Attention should be paid here to choosing artificial comparison flaws which are as far as possible governed by the same "distance laws" as the natural flaws to be evaluated.

The ultrasonic wave is attenuated in any material. This sound attenuation is very low, e.g. in parts made of fine-grained steel, likewise in many small parts made of other materials. However, if the sound wave travels larger distances through the material, a high cumulative sound attenuation can result, even with small attenuation coefficients. There is then a danger that echoes from natural flaws appear too small. For this reason, an estimate must always be made of the effects of attenuation on the evaluation result and taken into account if applicable.

If the test object has a rough surface, part of the incident sound energy will be scattered at its surface and is not available for the test. The larger this initial scattering, the smaller the flaw echoes appear, and the more errors occur in the evaluation result.

It is therefore important to take the effect of the test object's surfaces on the height of the echo into account (transfer correction).

1.3 The USM Go

The USM Go is a lightweight and compact ultrasonic flaw detector which is especially suitable

- for locating and evaluating material flaws,
- for measuring wall thicknesses,
- for saving and documenting test results.

Due to its design, the USM Go can be used in almost all flaw detection applications in a wide range of industries, including aerospace, power generation, automotive, as well as oil and gas. These include:

Weld inspection

- Trigonometric projections
- AWS
- DAC
- DGS

Inspection of forgings and castings

- Manual PRF adjustment
- Phantom echo detector
- DGS

Rail inspection

- High PRF (up to 2000 Hz)
- Lightweight: 850 g (1.87 lb)
- Small and ergonomic

Inspection of composites

- RF display
- 2 gates A and B
- Gate B is triggered by the event in gate A

For even more demanding applications

- Narrow band-pass filters
- Low-noise digital amplifiers
- Optional square pulsers
- DAC (TCG) with 120 dB/ μ s slope
- Backwall echo attenuation (BEA)

Instrument versions USM Go and USM Go+

A joystick is used in the **USM Go** for navigation, for changing settings, and for selecting adjustment values.

These functions are carried out by means of five keys in the keypad of the **USM Go+**. The arrow keys in the keypad correspond to the movement of the joystick in the corresponding direction, and pressing the center key corresponds to pressing the joystick.

USM Go

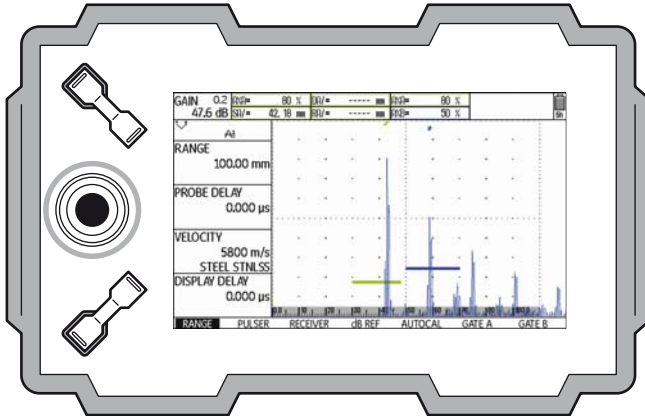

USM Go+

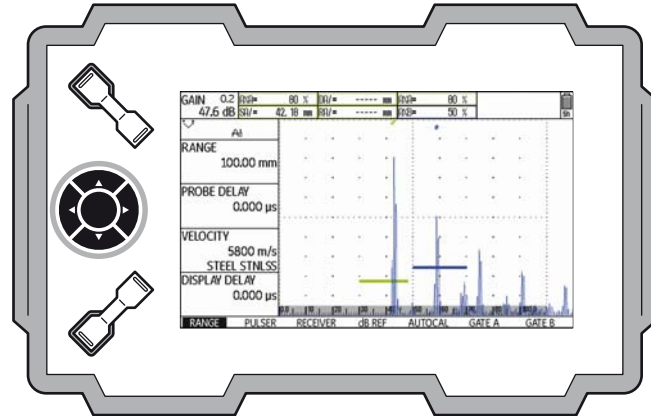

Options

Various options extend the basic functions of the USM Go and can be enabled by a code in each case.

USM Go Base

- Basic version, for universal ultrasonic test jobs.

USM Go AWS

- Amplitude evaluation according to AWS D1.1 for the weld inspection.

USM Go DAC

- DAC amplitude evaluation using up to 16 points according to EN ISO 11666, EN ISO 17640, ASME, and ASME III, in conformity with JIS Z3060
- DAC (TCG) 110 dB dynamic
- DAC (BEA) 120 dB/ μ s slope

USM Go DGS

- DGS amplitude evaluation according to EN ISO 11666

USM Go with an on-board data logger

- Recording and documentation of measurement values in linear and grid file mode.

USM Go with square pulser

- Enables the fine adjustment of initial pulse parameters
- Voltage setting 120 ... 300 V in increments of 10 V
- Pulse duration setting 30 ... 500 ns in increments of 10 ns
- PRF
- 3G (gate C)

Special features of the USM Go

- small, lightweight, rugged
- dust-tight and waterproof housing according to IP67
- long operating time (six hours) due to lithium-ion battery with internal and external charging possibility
- one-handed operation is possible
- keys for direct adjustment of gain
- two independent gates for accurate wall thickness measurements from the material surface up to the first echo or between two backwall echoes, including a measurement on coated materials with a resolution of 0.01 mm (up to 100 mm), referred to steel
- Magnify gate: spreading of the gate range over the entire display range
- high-resolution color display (800 × 480 Pixel) for the representation of digitized signals
- color display of gates and the corresponding readings for easy distinction
- easily perceptible reflection geometry when using angle-beam probes due to changing A-scan or background color at every reflection point
- high memory capacity with 2 GB SD card. SD cards with a memory capacity up to 16 GB can be used.
- increased calibration range: up to 9999 mm (steel), depending on the frequency range
- semiautomatic two-point calibration
- pulse repetition frequency adjustable in 3 steps (AUTO LOW, MED, HIGH) or MANUALLY in steps of 5 Hz.
- optional connection of phantom-echo detector
- choice of the frequency range for the connected probe
- Signal display: full-wave rectification, positive or negative half rectification, and radio frequency
- display of seven user-selectable measured readings at the top of the A-scan, one of which is displayed in enlarged mode, or four user-selectable measured readings displayed in enlarged mode

1.4 The DMS Go

The USM Go uses the same operating principle as the portable thickness gauge DMS Go.

You can extend your USM Go by a DMS Go quickly and easily by means of a software upgrade. You will then have two instruments available in one housing. When you power the instrument on, you can choose the instrument that you want to use (see Chapter 3.5 **Starting the USM Go**, page 3-11).

A separate operating manual is available for the DMS Go. The functions of the DMS Go are therefore not described in the operating manual of the USM Go.

1.5 How to use this manual

This operating manual applies to all instrument versions of the USM Go. Any differences in the functions or adjustment values are marked in each case.

Before operating the instrument for the first time, it is absolutely necessary that you read the chapters 1, 3, and 4. They will inform you about the necessary preparations of the instrument, give you a description of all keys and displays, and explain the operating principle.

In doing this, you will avoid any errors or failures of the instrument and be able to use the full range of instrument functions.

You will find the specifications of the instrument in Chapter 10 **Specifications**.

1.6 Layout and presentation in this manual

To make it easier for you to use this manual, all operating steps, listings, and special notes are always presented in the same way. This will help you find individual pieces of information quickly.

Attention and note symbols



ATTENTION

The **ATTENTION** symbol indicates peculiarities and special aspects in the operation which could affect the accuracy of the results.



Note

Note contains e.g. references to other chapters or special recommendations for a function.

Listings

Listings are presented in the following form:

- Variant A
- Variant B
- ...

Operating steps

Operating steps appear as shown in the following example:

- Loosen the two screws at the bottom.
- Remove the cover.
- ...

Standard package and accessories **2**

2.1 Standard package

Product code	Description	Order number
	Ultrasonic flaw detector USM Go or USM Go+	
TC-096	Transport case	
LI-138	Lithium-ion battery, 7.4 V, 3.9 Ah, rechargeable	
LiBC-139	AC power adapter/charger, 100V ... 260V AC	
	SD memory card 2 GB	
	Display screen protector foils (10 pieces)	
WS-342	Safety hand strap	
	Brief operating manual	
	Operating manual on USB stick	
	Manufacturer's certificate	

2.2 Add-on functions

Product code	Description	Order number
DAC/TCG	Echo evaluation method DAC, JISDAC, CNDAC, TCG	
DGS	Echo evaluation method DGS	
AWS	Echo evaluation method AWS D1.1	
SWP	Square-wave pulser	
PPRF	Phantom echo detector	
3Gate	Third gate C	
DL	Wall thickness data logger	

2.3 Preconfigured function packages

Product code	Description	Order number
Basic	Ultrasonic flaw detector USM Go or USM Go+	
DAC	Basic with DAC/TCG, AWS, SWP	
DGS	Basic with DGS, AWS, SWP	
Advanced	Basic with DAC, DGS, AWS, SWP, PPRF	

2.4 Recommended accessories

Product code	Description	Order number
LI-138	Lithium-ion battery, 7.4 V, 3.9 Ah, rechargeable	
LiBC-139	AC power adapter/charger, 100V ... 260V AC	
CA-040	Battery adapter for external charging of battery	
TC-096	Transport case	
CH-097	Shoulder strap	
WH-098	Shoulder bag for instrument and couplant	
WS-342	Safety hand strap	
EK-492	Ergonomic set (CH-097, WH-098, WS-342)	
CBL-604	Probe cable: Lemo 00-90° - Microdot	
CBL-819	Probe cable: Lemo 00-90° - Lemo 00	

Product code	Description	Order number
CBL-820	Probe cable: Lemo 00-90° - Lemo 01	
CBL-821	Probe cable: Lemo 00-90° - KBA 533	
CBL-822	Probe cable: Lemo 00-90° - BNC	
EN-499	Certificate EN 12668-1	

Initial start-up **3**

3.1 Instrument positioning

Fold out the prop-up stand on the rear side of the USM Go and position the instrument on a flat base so that you can easily read the display.

If the instrument has been brought from a cold room into a warmer one, wait until it has adapted to the room temperature before you power it on (to avoid condensation).

If (in rare cases) condensation has developed inside the instrument, the cover may mist up from the inside. In this case, open the cover until the damp has dried up. You should not power the instrument on until this has happened.

3.2 Power supply

The USM Go can be operated either with an external charger/power adapter or with the corresponding lithium-ion battery.

You can also connect the USM Go to the mains power supply if the battery is in the instrument. A discharged battery is charged in this case, during the instrument operation.

Operation with charger/power adapter

Connection to power supply

For the operation using a charger/power adapter, you should only use the charger/power adapter included in the standard package.

The charger/power adapter is automatically adjusted to every AC voltage between 90 V and 240 V (nominal voltage).

Connecting the instrument

Connect the USM Go to the mains socket-outlet by means of the corresponding charger/power adapter. The socket-contact for connecting the charger/power adapter is located on the side of the USM Go.

- Align the Lemo plug of the charger/power adapter with the red mark on the socket (1).
- Push the plug into the socket until it locks into place with a clearly audible click.
- When removing the Lemo plug, pull the metal sleeve on the plug back first in order to open the lock.



ATTENTION

In order to power the instrument off correctly, press the power On/Off key (2) on the side of the instrument. If the power supply is interrupted (removing the battery, disconnecting the power plug), the operation does not end correctly.

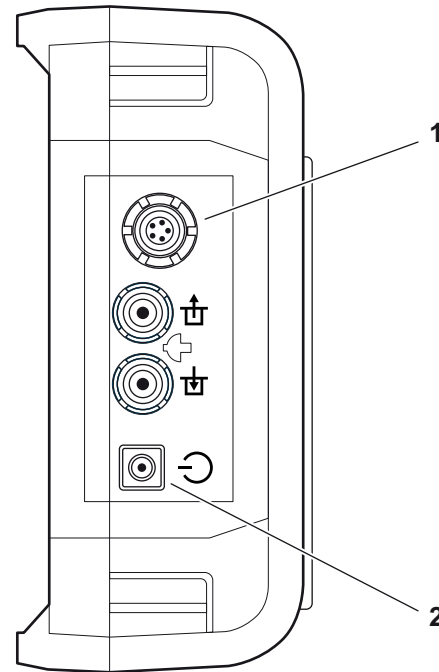

Operation using batteries

You should only use the corresponding lithium-ion battery for the battery operation.

Inserting batteries

The battery compartment is located on the rear of the instrument. The cover is fastened with two attachment screws.

- Turn the two attachment screws (1) of the battery compartment counterclockwise by one quarter of a turn each in order to loosen them.
- Lift the cover off upward. In the open battery compartment, you will see several connector pins (2) on one side.

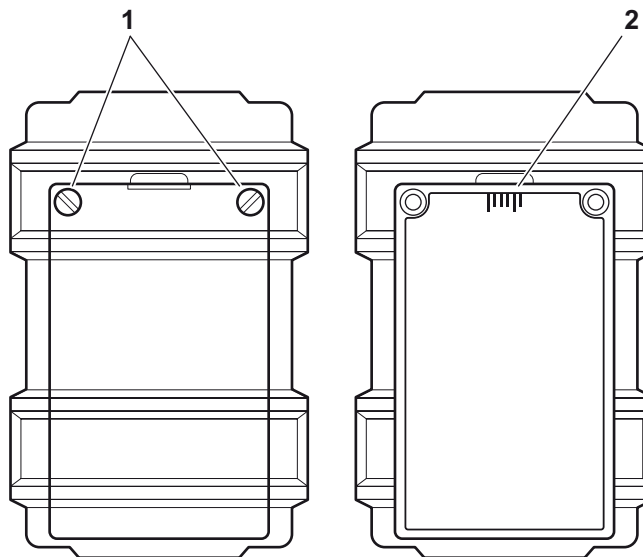

- Place the battery in the battery compartment so that the marking faces upwards and the contacts are pushed against the connector pins (1).
- Insert the cover of the battery compartment with the side opposite to the screws at first, and push the lugs (3) into the housing recesses.
- Press the cover firmly down on the side of the screws and turn the two screws (2) clockwise by one quarter of a turn each in order to lock the cover.

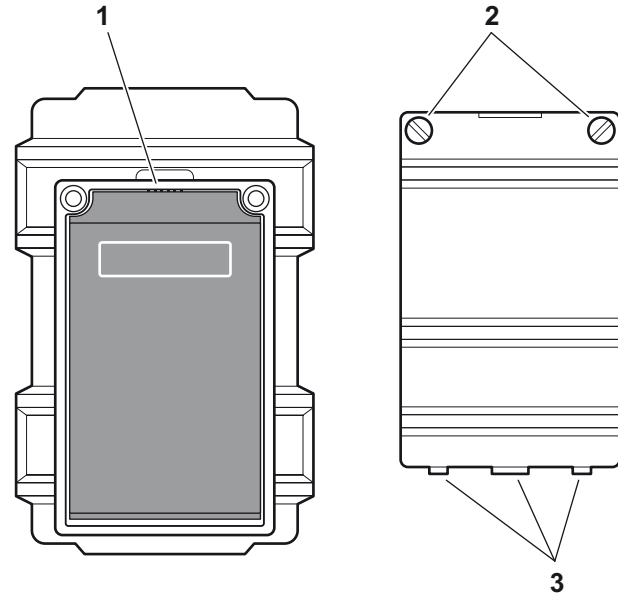

Checking the charge level of the lithium-ion battery

The lithium-ion battery is provided with a battery charge level indicator. Five light-emitting diodes (1) indicate the level of battery charge. Check the battery charge level before inserting it into the instrument.

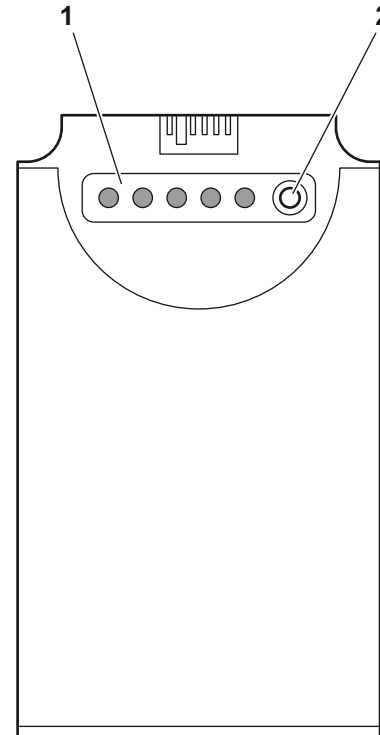

The number of diodes that are lit up has the following meaning:

- 5 LEDs: Battery charge level 100 ... 80 %
 - 4 LEDs: Battery charge level 80 ... 60 %
 - 3 LEDs: Battery charge level 60 ... 40 %
 - 2 LEDs: Battery charge level 40 ... 20 %
 - 1 LED: Battery charge level 20 ... 10 %
 - 1 LED is flashing: Battery charge level <10 %
- Press the key (2) next to the LEDs. The LEDs indicate the battery charge level.

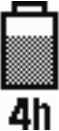

Power level indicator

The USM Go is equipped with a power level indicator that allows to estimate the remaining operating time of the instrument. A battery icon with the corresponding charge level is displayed in the top right corner on top of the A-scan. The charge level is indicated in percent by means of the battery icon.

Icon	Meaning
	Battery charge level, remaining operating time in hours (approximate value)
	Charger/power adapter is connected, percentage of battery charge level (approximate value)
	Warning: Low battery charge level, remaining operating time in minutes (approximate value)

The USM Go is automatically powered off if the operation is no longer ensured. All settings are retained during battery exchange and are immediately available again afterwards.



Note

If the battery charge level is low, it is absolutely necessary that you finish your test job, power off the instrument, and replace the battery. You should carry a second battery along with you if you cannot use mains power supply to operate the instrument.

Charging the batteries

You can charge the lithium-ion batteries either directly within the instrument or in an external charger.

Internal charging

If a lithium-ion battery is inserted, charging starts automatically as soon as you connect the charger/power adapter to the USM Go and to the mains power supply. You can carry out ultrasonic tests and charge the batteries at the same time.

The charging time is approx. ten hours with simultaneous ultrasonic testing. If the instrument is not used for ultrasonic testing, the charging time is approx. eight hours. This charging time applies to ambient temperatures of 25 ... 30 °C.

Charging status

All battery charge controls and status updates are internal to the instrument. Updates are given at the upper right corner of the display as described on the previous page.

The charger/power adapter is a simple power supply with no charging controls or intelligence. The LED on the charger is a power indicator only and will show a steady green light when AC power is provided at the input.

External charging

You can charge lithium-ion batteries with an external charger of the USM Go. Do not use any other chargers for charging the lithium-ion batteries for the USM Go.

3.3 Connecting a probe

To prepare the USM Go for operation, you have to connect a probe to it. Any Waygate Technologies probe can be used for the USM Go, provided the appropriate cable is available and the operating frequency is within an adequate range.





ATTENTION

If a probe is connected incorrectly, the consequence would be a mismatching which may lead to considerable power losses or even to echo waveform distortions.

The probe is connected to the sockets on the side of the instrument casing.

Both connector sockets are equally suitable (connected in parallel) for connecting probes equipped with only one ultrasonic element (ultrasonic transducer) so that it does not matter which one of the two sockets is used.

When connecting a dual-element (TR) probe (having one transmitter or pulser element and one receiver element) or two probes (of which one is transmitting and the other one receiving), attention should be paid to the correct allocation of connecting cables (please see symbols on the instrument):

Icon	Meaning
	Pulser connection
	Receiver connection

3.4 Inserting the SD memory card

You can use any SD memory card in the USM Go. To insert and to remove the memory card, you have to open the watertight cover at the top of the instrument.

- Push the lock of the hinged cover (1) in the direction of the arrow in order to open the cover.
- Insert the SD memory card into the card slot so that the contacts (2) of the card face the instrument front side.
- Press the card down into the card slot until it locks into place.
- Close the cover and make sure that it is locked tightly. If necessary, push the lock up to the limit stop in the opposite direction of the arrow in order to close the cover watertight again.
- To remove the SD card, open the cover and shortly press down the card to unlock it.

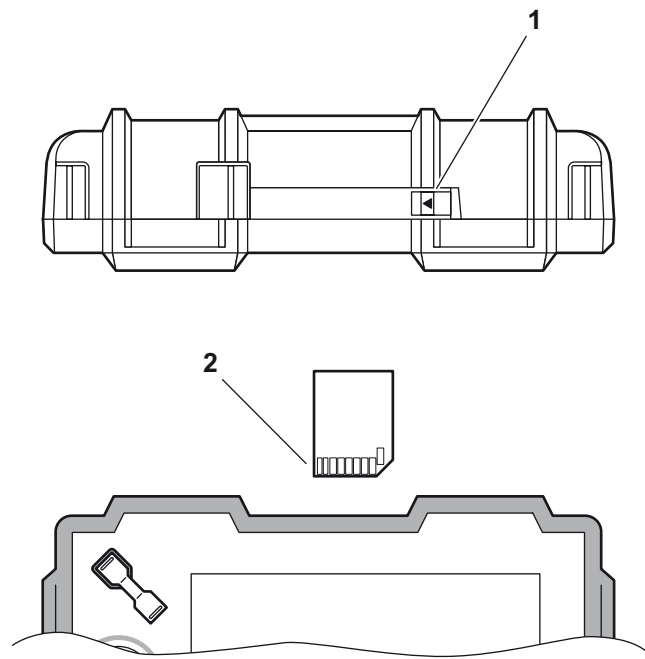

3.5 Starting the USM Go

Powering On

To start the USM Go, shortly press the Power key (1) on the side of the instrument casing.

The software is initialized. During this, the display will remain blank for about 3 seconds. If the license for the DMS Go is also installed, the display will show the page for selecting the required instrument. Select the required instrument by means of the joystick (USM Go) or the arrow keys of the keypad (USM Go+).

After that, the start display showing the name of the instrument and information on the software, serial number, and the installed options will appear.

The instrument carries out a self-check and then switches over to stand-by mode.

The settings of all function values and the default settings (language and units) are the same as before powering the instrument off.

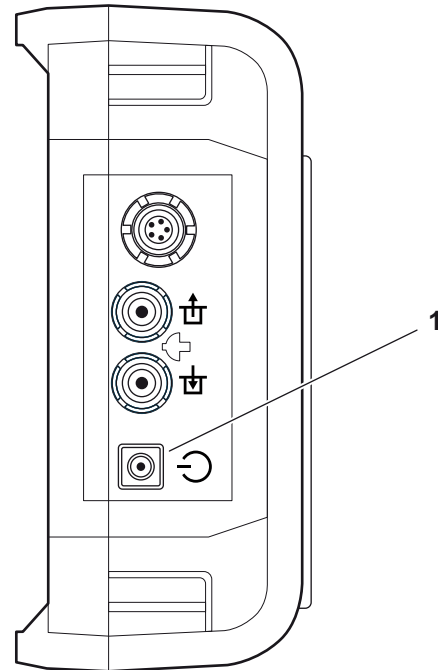

Powering Off

To power the USM Go off, shortly press the Power key (1) on the side of the instrument casing.

The settings of all function values and the default settings (language and units) are retained after powering off.

Factory default setting (Reset)

If you can no longer use the functions of your instrument or if the instrument no longer reacts as expected, you can reset it to the factory default settings. Any data saved to the SD card will be retained, all other individual settings, e.g. language and units, will be reset to the factory default settings.

- Power the instrument off.
- Press the further end of the Gain key (1), the further end of the Function key (2), and the Power key (3) simultaneously, and hold all three keys pressed until the start display or the page of the instrument selection appears.

The instrument starts with the factory default settings (for language selection, see Section **Language setting**, page 4-13).

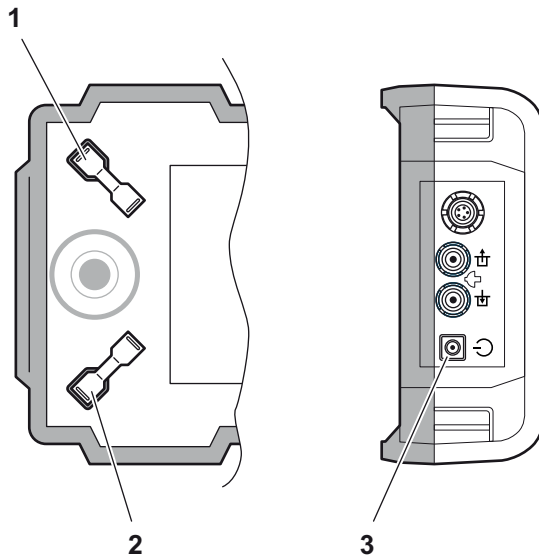

Principles of operation 4

4.1 Overview of operator's controls

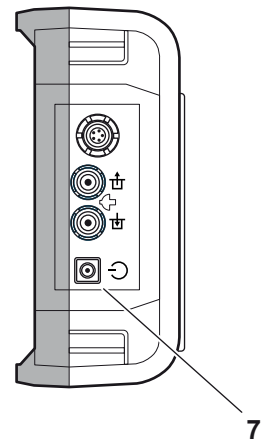
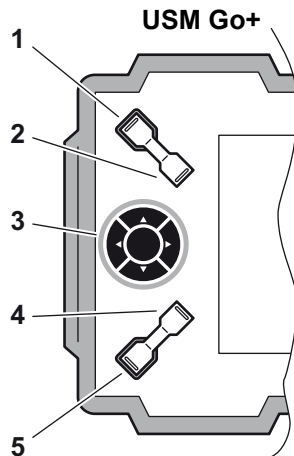
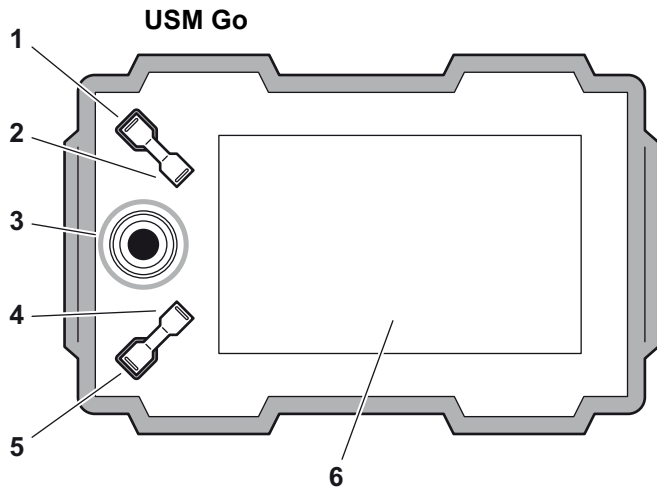

1 Increasing the gain level in increments

2 Decreasing the gain level in increments

3 Operating levels and function groups navigation

4 Function key 1, individually assignable

5 Function key 2, individually assignable

6 Display for representation of A-scan and functions

7 Power key for powering on and off

4.2 Display screen

A-scan representation

The USM Go has a high-resolution display screen for the display of the A-scan.

A-scan display in the normal mode

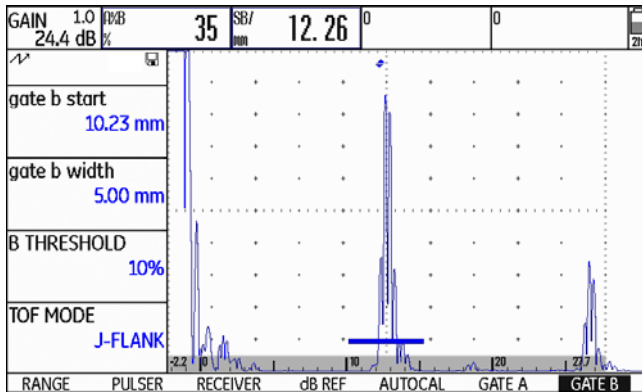

A-scan display in the zoom mode

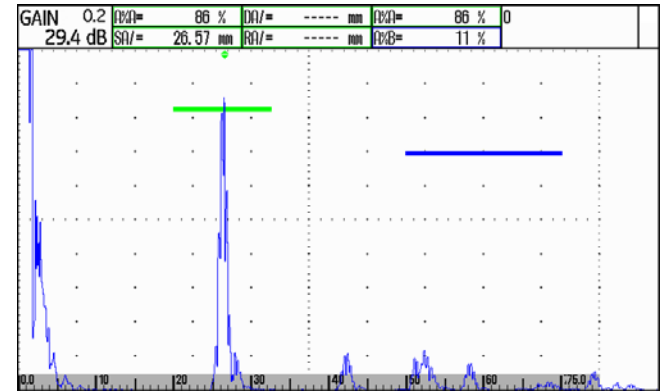

The gain and the adjusted dB step value are shown in the top left corner of the display screen. The access to all other instrument functions is disabled in the zoom mode of the A-scan display.

toggling the A-scan display mode

To toggle between the normal and the zoomed A-scan display mode, shortly press the joystick (USM Go) or the center key of the keypad (USM Go+) once.

Functions on the display screen

Function groups

The names of the seven function groups are shown at the bottom of the display screen. The currently selected function group is highlighted.

First operating level (A-scan):



Second operating level (settings):



Functions

On the first operating level, the functions of the currently selected function group are shown on the left of the display screen, next to the A-scan.

GAIN	1.0	dB
	24.4	dB
↖ ↗		
gate b start	10.23	mm
gate b width	5.00	mm
B THRESHOLD	10%	
TOF MODE	J-FLANK	
RANGE	PULSER	

The functions are hidden in the zoomed A-scan display mode; no operation is possible in this case.

Gain

The current gain value and the adjusted dB step value are always displayed in the top left corner of the screen.



Measurement line

The measurement line on top of the A-scan shows seven different measurement readings. One reading can be displayed in enlarged mode in a box on the far right. The readings for the individual boxes are user selectable (see Section **Configuring the measurement line**, page 5-59).



One or four measurement readings can be displayed in enlarged mode. The number of the other boxes of the measurement line is then reduced (see Section **Enlarged display of reading**, page 5-62).

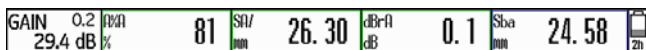

In addition to the measurement reading, the measuring point (peak or flank) is displayed with a symbol in sound path measurements:

^ = measuring point Peak

/ = measuring point Flank

Examples:

SA^ = sound path within gate A, at the measuring point Peak

SA/ = sound path within gate A, at the measuring point Flank



Note

The measuring point for amplitude is marked for the corresponding gate bar at the top edge of the display by a triangle pointing upwards in the color of the gate, the measuring point for distance is marked by a triangle pointing downwards.

Status display icons

To the left of the A-scan, below the measurement line, there is an area for various status displays. The status display icons inform about active functions and certain settings (see Section **Status display icons**, page 0-7 at the beginning of the present operating manual).

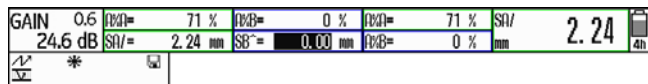

Alarms

You can display an alarm signal in the form of a virtual LED in the far right box on top of the A-scan (see Section **LARGE (alarm signal)**, page 5-64).

When an alarm is triggered, the color of the alarm signal changes from green to red.



4.3 Navigation and function keys

Navigation

A joystick is used in the **USM Go** for navigation, for changing settings, and for selecting adjustment values.

These functions are carried out by means of five keys in the keypad of the **USM Go+**. The arrow keys in the keypad correspond to the movement of the joystick in the corresponding direction, and pressing the center key corresponds to pressing the joystick.

The navigation is used

- for toggling between the operating levels,
- for selecting function groups,
- for selecting and setting functions,
- for selecting the zoom mode of A-scan display

Function keys

Two key groups consisting of two function keys each are arranged next to the display screen.

The two upper function keys are used for changing the gain and turning the function **AUTO 80** on (see Section **Key combinations**, page 4-8).

The two lower function keys are used

- for changing values or settings,
- for selecting options,
- for triggering user-assigned functions (see Chapter 5.3 **Assignment of function keys**, page 5-8).



Note

You can change many values either by means of the navigation (small increments) or by means of the lower function keys (large increments).

Key combinations

You can carry out some functions by means of key combinations. To achieve this, you have to press several keys at the same time (see Section **Overview of operator's controls**, page 4-2).

Function	Keys
HOME	Function key 1 + function key 2
AUTO 80	Increase gain + decrease gain
UPDATE	Decrease gain + function key 2 + Power key
RESET	Increase gain + function key 2 + Power key

Power key

The key for powering the instrument on and off is located on the instrument side, next to the probe connectors.

4.4 Operational concept

Operating levels

The USM Go is an easy-to-use instrument. It has two operating levels between which you can toggle by pressing the joystick (USM Go) or the center key (USM Go+).

The first operating level shows the A-scan and is used during normal operation.

It contains seven function groups for the settings during normal operation.

The second operating level contains all functions for the instrument configuration. This is where you will also find functions for saving and printing, for data management using the data logger, and for special applications, e.g. software updates.

Selecting and setting functions

Shown below the A-scan are the seven function groups which you can directly select using the navigation. The name of the currently selected function group is highlighted and the corresponding four functions are displayed on the left, next to the A-scan.

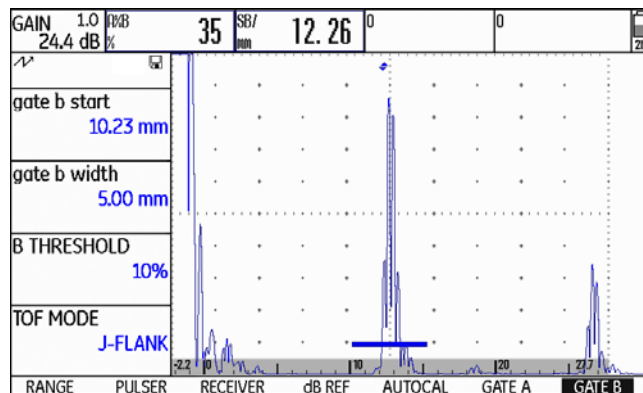

You can likewise directly select the individual functions using the navigation.

If a function is selected, the name of the function group is marked red. You can then change the value using the navigation or the function keys.

Coarse and fine adjustment of functions

You can choose between coarse and fine adjustment for some functions.

The fine adjustment is made using the navigation. The fastness of change is influenced by the movement of the joystick during this (e.g. for the function **VELOCITY**).

Use the lower function keys to make the coarse adjustment. The value will then change either in large increments (e.g. for the function **RANGE**) or you can choose from a series of factory-saved values (e.g. for the function **VELOCITY**)

During the fine adjustment, the name of the function is displayed in lower-case letters (**range**), whereas it is displayed in capital letters during the coarse adjustment (**RANGE**).

As long as a function is selected, you can only change the corresponding value but you cannot toggle between the function groups. To toggle between the function groups, you have to first select a function group again using the navigation (the name is highlighted).



Note

You can lock the joystick in the USM Go. Any changes to the adjustments using the joystick are then no longer possible (see Section **Locking the joystick**, page 5-76).

Function HOME

You can or must select the function **HOME** in various cases (e.g. to confirm certain settings). To do this, press the function keys at the same time (see Section **Overview of operator's controls**, page 4-2).



Note

You can assign the function **HOME** to one of the function keys (see Section **Assignment of function keys**, page 5-8).

Choosing the start value

You can use the function **HOME** for some functions to quickly choose the start value of the adjustment range. To do this, press the two lower function keys at the same time after selecting the function. In this way, you can e.g. set the value of the function **DISPLAY DELAY** to **0.000** μs .

This quick adjustment option is available for the following functions:

Function	Function group
PROBE DELAY	RANGE
DISPLAY DELAY	RANGE
REJECT	RECEIVER

Activating functions

You have usually two options for choosing functions, for triggering actions, or for changing settings on the second operating level:

- using the function keys directly after selecting a function,
- using the function keys or the navigation after activating a function.



Note

The direct change of settings or functions is disabled for some functions and, in any case, you must activate the function first before you can change any settings. This is the case e.g. for the function **DIRECTORY** for selecting a directory on the SD memory card.

Example

- Switch over to the second operating level.
- In the function group **EVAL**, select the function **MAGNIFY GATE**.

Option 1:

- Press the function keys to directly choose the gate for the magnify gate function.

Option 2:

- Press the joystick (USM Go) or the center key of the keypad (USM Go+) briefly to activate the function **MAGNIFY GATE**. The currently selected setting is highlighted.
- After that, change the setting using either the navigation or the function keys.
- After changing the setting, press the joystick (USM Go) or the center key of the keypad (USM Go+) briefly again to deactivate the function. You can then use the navigation again to switch over to another function.

4.5 Important default settings

Language setting

REGIONAL
LANGUAGE ENGLISH
UNITS mm
DECIMAL PERIOD
DATE FORMAT D.M.Y 24H

Use the function **LANGUAGE** (function group **CONFIG1** on the second operating level) to choose the language for the displayed texts.

The following languages are available:

- Bulgarian
- Chinese
- German
- English
- Finnish
- French
- Italian
- Japanese
- Dutch
- Norwegian
- Polish
- Portuguese
- Romanian
- Russian
- Swedish
- Spanish
- Czech
- Hungarian

- Switch over to the second operating level.
- In the function group **CONFIG1**, select the function **LANGUAGE**.
- Press the function keys to choose the required language. The language changes immediately.

Units setting

REGIONAL	
LANGUAGE	ENGLISH
UNITS	mm
DECIMAL	PERIOD
DATE FORMAT	D.M.Y 24H

You can use the function **UNITS** (function group **CONFIG1** on the second operating level) to select the required units (mm, in, or μ s). You can change the units any time. All values are adjusted accordingly.

- Switch over to the second operating level.
- In the function group **CONFIG1**, select the function **UNITS**.

Press the function keys to choose the required units.

Decimal separator

REGIONAL	
LANGUAGE	ENGLISH
UNITS	mm
DECIMAL	PERIOD
DATE FORMAT	D.M.Y 24H

You can choose the decimal separator mark. All data are displayed and saved using the selected decimal separator.

- Switch over to the second operating level.
- In the function group **CONFIG1**, select the function **DECIMAL**.

Press the function keys to choose the required setting.

Date format, Date, and Time

REGIONAL	STARTUP
LANGUAGE ENGLISH	DATE 09. 01. 2013
UNITS mm	TIME 11: 34
DECIMAL PERIOD	ORIENTATION RIGHT HANDED
DATE FORMAT D.M.Y 24H	JOY CONTROL ON

The date is saved together with the inspection results. You can set the date format, the date, and the time using the corresponding functions of the function group **CONFIG1** on the second operating level.



ATTENTION

In view of a correct documentation, always make sure that you are using the correct date and the correct time. Remember to turn the clock during the change from winter time to summer time.

- Switch over to the second operating level.
- In the function group **CONFIG1**, select the function **DATE FORMAT**.
- Press the function keys to change the date format. The time format is changed together with the date format.
- Select the function **DATE**.
- Press the joystick (USM Go) or the center key of the keypad (USM Go+) to change the setting. The first value (day, month, or year) is highlighted.
- Use the navigation to change the highlighted value and switch over to the next value.
- Change the other values in the same way.
- Finally, press the joystick (USM Go) or the center key of the keypad (USM Go+) to close the setting. The new values apply immediately.
- Select the function **TIME**.
- Change the time in the same way as you did previously for the date.
- Finally, press the joystick (USM Go) or the center key of the keypad (USM Go+) to close the setting. The new values apply immediately.

Selecting the instrument orientation

STARTUP	
DATE	09. 01. 2013
TIME	11: 34
ORIENTATION	RIGHT HANDED
JOY CONTROL	ON

You can configure the instrument for right-handed or left-handed operation (referred to the probe). The screen display is then rotated through 180°, the functions of navigation and function keys are adjusted accordingly.

- Switch over to the second operating level.
- In the function group **CONFIG1**, select the function **ORIENTATION**.
- Press the function keys to choose the required orientation.

4.6 Default settings of the display

The USM Go is equipped with a high-resolution color display. You can optimize the display according to your own viewing habits and to the operating environment.

Selecting the color scheme

DISPLAY	
COLOR	SCHEME 3
GRID	GRID1 WO RULER
ASCAN COLOR	BLUE
BRIGHTNESS	10

You can choose one of four color schemes using the function **COLOR** (function group **CONFIG1** on the second operating level). The color scheme determines the color of all displays and of the background. You can set the color of the A-scan separately (please see the section below).



Note

All color schemes are suitable for indoor use. For outdoor use, we recommend Scheme 3 and Scheme 4.

- Switch over to the second operating level.
- In the function group **CONFIG1**, select the function **COLOR**.
- Press the function keys to select the required color scheme.

Selecting the A-scan color

DISPLAY	
COLOR	SCHEME 3
GRID	GRID1 WO RULER
A-SCAN COLOR	BLUE
BRIGHTNESS	10

You can choose the color of the A-scan using the function **A-SCAN COLOR** (function group **CONFIG1** on the second operating level). The color options depend on the selected color scheme (see Section **Selecting the color scheme**, page 4-16).

- Switch over to the second operating level.
- In the function group **CONFIG1**, select the function **A-SCAN COLOR**.
- Press the function keys to choose the required color for the A-scan.

Selecting the grid

DISPLAY	
COLOR	SCHEME 3
GRID	GRID1 WO RULER
ASCAN COLOR	BLUE
BRIGHTNESS	10

Using the function **GRID** (function group **CONFIG1** on the second operating level), you can choose a grid for the A-scan. Two grids, each with and without a ruler at the bottom edge of the display, are available as options.

- Switch over to the second operating level.
- In the function group **CONFIG1**, select the function **GRID**.
- Press the function keys to choose the required grid for the A-scan.

Setting the brightness

DISPLAY	
COLOR	SCHEME 3
GRID	GRID1 WO RULER
ASCAN COLOR	BLUE
BRIGHTNESS	10

To set the brightness of the display, use the function **BRIGHTNESS** (function group **CONFIG1** on the second operating level). You can choose a value from 1 to 10.



Note

A high brightness value increases the power consumption, due to which the operating time is reduced in battery operation.

- Switch over to the second operating level.
- In the function group **CONFIG1**, select the function **BRIGHTNESS**.
- Press the function keys to select the required value.

**Note**

You can extend the operating time by means of the power saver function (see Section **Power saving mode**, page 5-79).

4.7 Saving the settings

FILENAME
FILENAME FILES
ACTION STORE REPORT
ENTER
DIRECTORY GUI

You can save the current instrument settings to a file on the SD memory card. The files for the USM Go have the filename extension UGO.

**ATTENTION**

The filename can be up to 14 characters long for saving data sets. However, only the first 7 characters are shown in the display on top of the A-scan (see Section **Displaying dataset name**, page 4-22).

Please note this limitation when saving data sets in order to avoid any confusions between filenames starting with the same character.

- Switch over to the second operating level.
 - In the function group **FILES**, select the function **DIRECTORY** and briefly press the joystick (USM Go) or the center key of the keypad (USM Go+). The directory of the SD memory card appears.
 - Press the function keys to select a directory on the SD card.
 - Press the joystick (USM Go) or the center key of the keypad (USM Go+) briefly to choose the selected directory.
- Switch over to the function **ACTION** and press the function keys to select the function **STORE DATA-SET**.
 - Switch over to the function **FILENAME** and briefly press the joystick (USM Go) or the center key of the keypad (USM Go+).
 - Use the navigation to choose the option **<NEW FILE>** and briefly press the joystick (USM Go) or the center key of the keypad (USM Go+).
 - Use the navigation to choose the first character of the filename.
 - Use the navigation to switch over to the next item, and choose the next character.
 - Press the joystick (USM Go) or the center key of the keypad (USM Go+) briefly to close the filename entry.

- Switch over to the function **ENTER** and briefly press the joystick (USM Go) or the center key of the keypad (USM Go+).

The current instrument settings are saved to the selected directory on the SD memory card under the name entered here.



Note

You can create and delete directories by inserting the SD memory card into the SD card reader of your PC or by connecting the USM Go to a PC via a USB cable (see Section **USB interface**, page 8-3).

Recalling settings

You can recall and use instrument settings saved to the SD memory card.



Note

You can only recall datasets having the file-name extension UGO. Other files on the SD memory card are not displayed as options.

- Switch over to the second operating level.
- In the function group **FILES**, select the function **DIRECTORY** and briefly press the joystick (USM Go) or the center key of the keypad (USM Go+). The directory of the SD memory card appears.
- Press the function keys to select a directory on the SD card.
- Press the joystick (USM Go) or the center key of the keypad (USM Go+) briefly to choose the selected directory.

- Switch over to the function **ACTION** and press the function keys to select the function **RECALL DATASET**.
- Switch over to the function **FILENAME** and briefly press the joystick (USM Go) or the center key of the keypad (USM Go+).
- Use the navigation to select the name of the required dataset.
- Press the joystick (USM Go) or the center key of the keypad (USM Go+) briefly. The selection is automatically changed to the function **ENTER**.
- Press the joystick (USM Go) or the center key of the keypad (USM Go+) briefly.

The instrument settings of the selected dataset are recalled and they are immediately active after closing the recalling process.

Displaying dataset name

RESULTS	
READING 1	A%A
READING 2	SA
READING 3	A%B
READING 4	SB

You can display the filename of the currently recalled instrument settings (dataset name) in the measurement line on top of the A-scan.



Note

The dataset name can only be displayed in the box on the far right.

- Switch over to the second operating level.
- Select the function group **EVAL**.
- Select the function **LARGE**.
- Press the function keys to choose the parameter **DSET** as value.
- Switch over to the first operating level.

After recalling the instrument settings, the corresponding filename (dataset name) is displayed in red letters in the measurement line on top of the A-scan in the box on the far right.

GAIN	0.2	0.2	81	SN/	26.30	dBr-1	0.1	DATE	GE 2013	
	29.4 dB	%		mm		dB				40



ATTENTION

The filename can be up to 14 characters long for saving data sets (on the second operating level). However, only the first 7 characters are shown in the display on top of the A-scan (on the first operating level).

Please note this limitation when saving data sets in order to avoid any confusions between filenames starting with the same character.

Operation **5**

5.1 Overview of the functions

The functions of the USM Go are combined into function groups on two operating levels.

- Press the joystick (USM Go) or the center key of the keypad (USM Go+) for about 2 seconds to toggle between the two operating levels.
- Use the navigation to select a function or a setting.
- Press the function keys to change a setting.



Note

You will find detailed descriptions of how to use the operator's controls in Chapter 4 **Principles of operation**.

The gain is always directly available to you by means of the two keys at the top, next to the display.

You will find an overview of the function groups and their corresponding functions on the first pages of this operating manual.

The first operating level contains seven function groups in the default view.



Note

When certain functions are activated, other associated function groups become visible by navigating upwards. You can return to the previous view by pressing the center key.

The second operating level contains eight function groups.

First operating level

RANGE	PULSER	RECEIVER	dB REF	AUTOCAL	GATE A	GATE B
-------	--------	----------	--------	---------	--------	--------

Second operating level

FILES	EVAL	dB REF	CONFIG1	CONFIG2	CONFIG3	◀▶
-------	------	--------	---------	---------	---------	----

dB REF	CONFIG1	CONFIG2	CONFIG3	CONFIG4	DR	◀▶
--------	---------	---------	---------	---------	----	----

Function groups first operating level

RANGE	This is where you will find functions required for the basic setting of the signal representation on the display screen.
PULSER	This group is a combination of functions used for setting the pulser.
RECEIVER	This group is a combination of functions used for setting the receiver.
dB REF	This group contains functions for evaluation. The name and functions of this group vary depending on the selected evaluation method.
AUTOCAL	This is where you will find the functions for the semi-automatic calibration of the instrument.
GATE A	In this group, you will find all functions required for setting the gate A.
GATE B	In this group, you will find all functions required for setting the gate B.
GATES	Only if the option 3B is enabled: All functions for setting the gates A, B, and C. The function groups GATE A and GATE B are then no longer visible.

Function groups second operating level

FILES	This is where you will find functions used for the management of files, test reports, and videos.
EVAL	This group is a combination of functions for evaluation methods. In addition, you can configure the measurement line here (see Section Measurement line , page 4-5).
dB REF	This group contains functions for the evaluation method dB Ref. The name and functions of this group vary depending on the selected evaluation method.
DAC/TCG	This group contains the functions for the evaluation method DAC/TCG (option).
DGS	This group contains the functions for the evaluation method DGS (option).
AWS D1.1	This group contains the functions for the evaluation method AWS D1.1 (option).
JISDAC	This group contains the functions for the evaluation method JISDAC (option).
CNDAC	This group contains the functions for the evaluation method CNDAC (option).

- CONFIG1** This is where you will find various default settings, e.g. language, color, and A-scan display options.
- CONFIG2** This is where you will find special functions for the instrument setup for test and measurement applications.
- CONFIG3** This is where you will find additional functions for the instrument setup for test and measurement applications.
- CONFIG4** This group contains functions for the automatic gain control.
- DR** This group contains all functions for the data logger (option).

5.2 Setting the gain

To enable you to set the gain quickly and directly, this function is always available to you with the two keys at the top, next to the display screen.

You can use the gain to adjust the sensitivity necessary for making echoes from reflectors to be detected visible on the display screen at the required height.

- Press the upper key to increase the gain. The current gain is displayed in the top left corner of the display screen.
- Press the lower key to decrease the gain.

Setting the dB increment of gain

SETUP 2	
CAL REMINDER	OFF
CAL RESET	
USER GAIN STEP	10.0dB
dB STEP	0.6

By pressing the keys, you will always set the gain by a certain dB increment. You can define this dB increment.

The following settings are possible:

- LOCK (locked)
- 0.2 dB
- 0.6 dB
- 1.0 dB
- 2.0 dB
- 6.0 dB
- 0.2 ... 60.0 dB

**Note**

The setting **LOCK** locks the gain thus preventing its adjustment by mistake.

- Switch to the second operating level.
- In the function group **CONFIG2**, select the function **dB STEP**.
- Press the function keys to choose the required dB increment.

You can define the dB increment of the seventh level using the function **USER GAIN STEP**.

You can set the display range by coarse adjustment steps or by fine adjustment (see Section **Coarse and fine adjustment of functions**, page 4-10).

- Select the function **USER GAIN STEP**.
- Set the user gain step by means of the function keys or using the navigation.

5.3 Assignment of function keys

SETUP	
FUNCTION 1	MAGNIFY GATE NONE
FUNCTION 2	FREEZE COPY
ABOUT	SHOW
ASCAN FILL	OFF

You can assign various functions to the two function keys at the bottom, next to the display screen, so that you will be able to trigger these functions any time without switching the operating level.

Each one of the two function keys can have two function assigned to it, one of which is triggered by briefly pressing the key, whereas the other one is triggered by pressing the key for a longer time (approx. 2 seconds). All in all, this means that you can assign four different functions to the two function keys.

The following settings are possible:

- **NONE** (no function selected)
- **FREEZE** (see page 5-68)
- **JOYSTICK LOCK** (see page 5-76)
- **COPY** (see page 6-2)
- **AUTO80** (see page 5-92)
- **MAGNIFY GATE** (see page 5-65)
- **dB STEP** (see page 5-6)
- **RECALL DATASET** (see page 4-21)
- **ORIENTATION** (see page 4-16)
- **ENVELOPE** (see page 5-83)
- **HOME** (see page 4-8)
- **ANGLE+**
- **ANGLE-**
- **BW GAIN+** (see page 5-82)
- **BW GAIN-** (see page 5-82)

- Switch to the second operating level.
- In the function group **CONFIG2**, select the function **FUNCTION 1** to assign functions to the upper function key.
- Activate the function (see Section **Activating functions**, page 4-12). The upper option is selected and you can now choose the function for the brief key press.
- Use the navigation to choose the required function for the brief key press.
- Press one of the function keys to choose the function for the long key press. The selection changes to the lower option and the name of the function changes to **(HOLD)func 1**.
- Press the function keys to choose the function for the long key press.
- Finally, deactivate the function **(HOLD)func 1**.
- Switch to the function **FUNCTION 2** to assign functions to the lower function key.

5.4 Setting the display range (function group RANGE)



Note

For an exact adjustment of the sound velocity and the probe delay, please start by reading Chapter 5.8 **Calibrating the USM Go**, page 5-29.

range	5.00 mm
PROBE DELAY	0.000 μ s
VELOCITY	3200 m/s STEEL MILD (S)
DISPLAY DELAY	0.000 μ s

You need the function group **RANGE** for the basic setting of the display range. The display range must be adjusted to the sound velocity used (function **VELOCITY**) and to the probe used (function **PROBE DELAY**).

- Switch to the first operating level.
- Select the function group **RANGE**.

RANGE

You can use the function **RANGE** to set the range (the display range) for making measurements.

You can set the display range by coarse adjustment steps or by fine adjustment (see Section **Coarse and fine adjustment of functions**, page 4-10).

The adjustment range is 0.5 ... 20000.00 mm.



Note

The adjustment range for display range depends on the sound velocity setting and on the frequency range setting (function **FREQUENCY** in the function group **RECEIVER**).

- Select the function **RANGE**.
- Set the required display range by means of the function keys or using the navigation.
- Press the two function keys at the same time to quickly adjust an average value (254.00 mm).

PROBE DELAY

Every probe is equipped with a delay line between the transducer and the coupling face. The sound pulse must first pass through this delay line before it can enter the test object. You can compensate for this influence of the delay line in the probe in the function **PROBE DELAY**.

You can set the probe delay by coarse adjustment steps or by fine adjustment (see Section **Coarse and fine adjustment of functions**, page 4-10).

The adjustment range is 0 ... 1000.000 μ s.



Note

If the value for the probe delay is not known, please read Chapter 5.8 **Calibrating the USM Go**, page 5-29 to determine this value.

- Select the function **PROBE DELAY**.
- Set the probe delay by means of the function keys or using the navigation.
- Press the two function keys at the same time to set the value to zero.

VELOCITY



Note

If **µs** are selected as units, the function **VELOCITY** is deactivated for safety reasons and it does not appear on the display screen.

You can use the function **VELOCITY** to set the sound velocity in the test object.

You can choose between different materials and their sound velocities. The additional information **TR.** and **TRANS** refer to the sound velocities in transverse wave excitation mode. In longitudinal wave excitation mode, the material name remains without additional information.

If you deviate from a specified material velocity when using the navigation, the material name is automatically replaced by the information **CUSTOM**. You can set the sound velocity by coarse adjustment steps or by fine adjustment (see Section **Coarse and fine adjustment of functions**, page 4-10).

The adjustment range is 250 ... 16000 m/s.



ATTENTION

Please always make sure that the setting of the function **VELOCITY** is correct. The USM Go calculates all range and distance indications on the basis of the value adjusted here.

- Select the function **VELOCITY**.
- Set the sound velocity by means of the function keys or using the navigation.

DISPLAY DELAY

You can use this function to choose whether to display the adjusted display range (for example 250 mm) starting from the surface of the test object or in a section of the test object starting at a later point. This allows you to shift the complete screen display and consequently also the display zero.

For example, if the display should start from the surface of the test object, you have to adjust the value 0 for **DISPLAY DELAY**.

You can set the display delay by coarse adjustment steps or by fine adjustment (see Section **Coarse and fine adjustment of functions**, page 4-10).

The adjustment range is -15.000 ... 3500.000 μ s.

- Select the function **DISPLAY DELAY**.
- Set the sound velocity by means of the function keys or using the navigation.
- Press the two function keys at the same time to set the value to zero.

5.5 Setting the pulser (function group PULSER)

VOLTAGE	LOW
ENERGY	LOW
DAMPING	50 OHM
PRF MODE	AUTO LOW 400 Hz

You will find all functions for setting the pulser in the function group **PULSER**.

- Switch to the first operating level.
- Select the function group **PULSER**.

VOLTAGE (pulser voltage)

You can use the function **VOLTAGE** to set the pulser voltage.

The following settings are possible:

- **HIGH** – high voltage
- **LOW** – low voltage

The setting **HIGH** is recommended for all tests in which maximum sensitivity is important, e.g. for the detection of small flaws. Choose the setting **LOW** for broadband probes or if narrow echoes are required (better lateral resolution).

Square-wave pulser

If your USM Go is equipped with a square-wave pulser (option) and if the square-wave pulser is chosen as pulser type (see Section **Selecting the pulser type**, page 5-75), then you can set the pulser voltage within the range of 120 ... 300 V in steps of 10 V. Instead of the function **ENERGY**, the function **WIDTH** is then available.

**ATTENTION**

Use the data sheet for your probe to check which maximum voltage is allowed to be applied.

**Note**

The pulser voltage and the pulse width can be automatically limited, depending on the pulse repetition frequency (see Section **PRF MODE (pulse repetition frequency)**, page 5-17) setting. This function helps to avoid heat accumulations in the pulser electronics.

- Select the function **VOLTAGE**.
- Press the function keys to choose the required pulser voltage.

ENERGY

You can use the function **ENERGY** to set the penetration or sound energy.

The following settings are possible:

- **HIGH** – high energy
- **LOW** – low energy

The setting **HIGH** is recommended for all tests in which maximum sensitivity is important, e.g. for the detection of small flaws. Choose the setting **LOW** for broadband probes or if narrow echoes are required (better lateral resolution).

- Select the function **ENERGY**.
- Press the function keys to choose the required setting.

WIDTH

This function is only available if the option square-wave pulser is chosen as pulser type (see Section **Selecting the pulser type**, page 5-75).

You can use the function **WIDTH** to adjust the pulse width for the square-wave pulser. You can adjust a value within the range of 30 ... 500 ns (nanoseconds) in steps of 10 ns.

The following equation produces an approximation for the suitable pulse width:

$$\begin{aligned} \text{Nominal width in nanoseconds} \\ = 500/\text{probe frequency in MHz} \end{aligned}$$

For example, the equation for a 2.25 MHz probe results in:

$$\begin{aligned} \text{Nominal width in nanoseconds} \\ = 500/2.25 \text{ ns} = 222 \text{ nanoseconds} \end{aligned}$$



Note

The pulser voltage and the pulse width can be automatically limited, depending on the pulse repetition frequency (see Section **PRF MODE (pulse repetition frequency)**, page 5-17) setting. This function is used for limiting the signal loss.

- Select the function **WIDTH**.
- Press the function keys to select the required value.

DAMPING

This function is used for matching the probe. By setting the damping of the probe oscillating circuit you can vary the height, width, and resolution of the echo display.

The following settings are possible:

- **1000 Ohm**
low damping, the echoes become higher and broader.
 - **50 Ohm**
reduces the echo height but produces narrower echoes with a higher resolution.
- Select the function **DAMPING**.
- Press the function keys to select the required value.

PRF MODE (pulse repetition frequency)

The pulse repetition frequency indicates the number of times an initial pulse is triggered per second. You can decide whether you need the highest possible PRF value or whether you are satisfied with a low value. You have three fixed steps and one user-variable step available for the adjustment.

The larger your test object, the smaller PRF values are needed to avoid phantom echoes. However, the A-scan update rate becomes lower in the case of smaller PRF values; high values are therefore required if a test object should be scanned fast.

The best way to determine the suitable PRF value is by experimenting: Start from the highest step and reduce the value until there are no more phantom echoes.

The following settings are possible:

- AUTO LOW 400 Hz
- AUTO MED 1000 Hz
- AUTO HIGH 1500 Hz
- MANUAL

- Select the function **PRF MODE**.
- Press the function keys to select the required value.
- If you have selected **MANUAL**, set the required value using the navigation.



Note

You can detect and avoid phantom echoes by means of the optional function phantom PRF (see Section **Phantom echo detector**, page 5-58).

5.6 Setting the receiver (function group RECEIVER)

FREQUENCY BROADBAND	
RECTIFY	RF
DUAL	OFF
REJECT	0%

You will find all functions for setting the receiver in the function group **RECEIVER**.

- Switch to the first operating level.
- Select the function group **RECEIVER**.

FREQUENCY

In this function, you can set the frequency of the receiver according to the frequency of your probe.

The following settings are possible:

- BROADBAND
- 1 - 5 MHz
- 2 MHz
- 2.25 MHz
- 4 MHz
- 5 MHz
- 10 MHz
- 13 MHz
- 15 MHz

- Select the function **FREQUENCY**.
- Press the function keys to select the required value.

RECTIFY

You can use the function **RECTIFY** to select the rectification mode of the echo pulses according to your application.

The following settings are possible:

- **FULLWAVE**
All half-waves are displayed above the base line on the screen.
 - **POS HALFWAVE**
Only positive half-waves are displayed above the base line on the screen.
 - **NEG HALFWAVE**
Only negative half-waves are displayed above the base line on the screen.
 - **RF** (radio frequency)
There is no rectification. Both positive and negative wave portions are displayed with true amplitude.
- Select the function **RECTIFY**.
- Press the function keys to choose the required setting.

DUAL (pulser-receiver separation)

You can use the function **DUAL** to activate the pulser-receiver separation (see Chapter 3.3 **Connecting a probe**, page 3-9).

- **OFF**
Single-element operation; the probe connector sockets are connected in parallel.
 - **ON**
Dual mode for using dual-element probes; one probe connector is connected to the amplifier input, the initial pulse is applied to the other probe connector.
 - **THROUGH**
Through-transmission mode for using two separate probes; the receiver is connected to one probe connector and the pulser is connected to the other. As the sound wave passes through the test object only once in through-transmission mode, all range and wall thickness measurement functions are adjusted accordingly.
- Select the function **DUAL**.
- Press the function keys to choose the required setting.

REJECT

You can use the function **REJECT** to suppress unwanted echo indications, e.g. structural noise from the test object.

The height in % indicates the minimum height that the echoes must attain in order for them to be displayed on the screen at all. The reject setting cannot be higher than 80 %.



ATTENTION

You should handle this function with great caution as it may of course happen that you suppress echoes from flaws as well. Many test specifications expressly forbid using the reject function.

- Select the function **REJECT**.
- Press the function keys to select the required value.

5.7 Setting the gates (function groups GATE A and GATE B)

gate a start	0.72 mm
gate a width	2.50 mm
A THRESHOLD	70%
TOF MODE	FLANK

You will find all functions for setting the gates A and B in the function groups **GATE A** and **GATE B**.

- Switch to the first operating level.
- Select the function group **GATE A** or **GATE B**.

Tasks of the gates

- The gates monitor the area of the test object where you expect to detect a flaw. If an echo exceeds or falls below the gate, an alarm signal is output (see Section **Alarms**, page 4-6).
- The gates A and B are independent of each other. Gate A can also assume the function of an echo start gate for gate B.
- The gate chooses the echo for the digital time-of-flight and amplitude measurement. The measured value is displayed in the measurement line (see Section **Measurement line**, page 4-5).

Display of the gates

The gates are displayed in different colors for easier allocation.

A-START/B-START **(starting point of the gate)**

You can set the starting point of the gates A or B within an adjustment range of 0 ... 27940 mm.

You can set the value by coarse adjustment steps or by fine adjustment (see Section **Coarse and fine adjustment of functions**, page 4-10).

- Select the function **A-START** or **B-START**.
- Set the required value by means of the function keys or using the navigation.

A-WIDTH/B-WIDTH **(width of the gates)**

You can set the width of the gates A or B within an adjustment range of 1.00 ... 27940.00 mm.

You can set the value by coarse adjustment steps or by fine adjustment (see Section **Coarse and fine adjustment of functions**, page 4-10).

- Select the function **A-WIDTH** or **B-WIDTH**.
- Set the required value by means of the function keys or using the navigation.

A-THRESHOLD/B-THRESHOLD

(response and measurement threshold of the gate)

You can define the threshold value of the gates A or B within the range of 5 ... 95 % screen height for triggering an alarm if this value is exceeded or not reached.

In RF mode, you can additionally set the threshold within the range of -5 ... -95 %.

- Select the function **A-THRESHOLD** or **B-THRESHOLD**.
- Press the function keys to select the required value.

TOF MODE

The sound path measurement by means of the echo evaluation depends on the choice of measuring point.

The following settings are possible:

- PEAK** (peak measurement)
 The amplitude and the time-of-flight are measured at the absolutely highest amplitude value within the gate with maximum resolution of the instrument.
- FLANK** (flank measurement)
 The amplitude is measured as in the case of **PEAK**, however, the time-of-flight is measured at the first point of intersection between the echo and the gate with maximum resolution of the instrument.
- J-FLANK**
 The time-of-flight is measured as in the case of **FLANK**, the amplitude measurement before the 1st change of direction downwards, when the gate threshold is afterwards yet again not reached, is determined with the maximum resolution of the instrument. In the case of larger values for the function **RANGE**, it may happen that several points are combined into one. In these cases, the evaluation no longer corresponds to the displayed A-scan.

- FIRST PEAK**

The measurement is made as in the case of **J-FLANK**, however, with screen resolution. If the evaluation using the displayed A-scan is of prime importance, **FIRST PEAK** should be preferred.

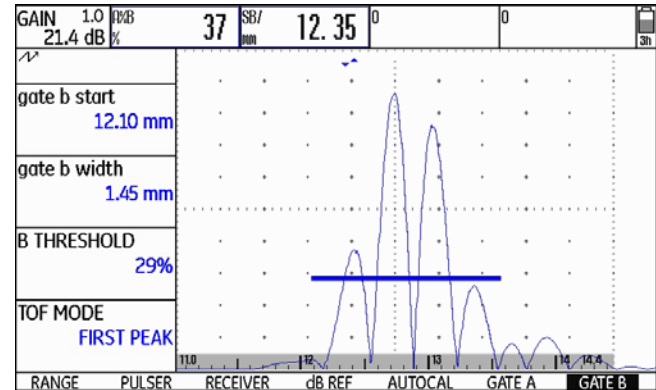

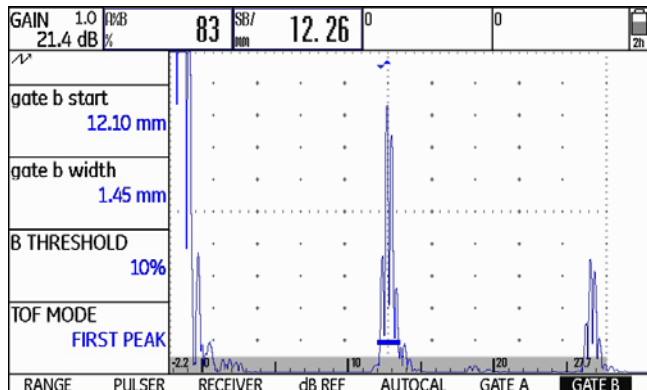

ATTENTION

In any case, the setting of the measuring point in TOF mode for the calibration and for the subsequent test use must always be identical. Otherwise, measuring errors may occur.

- Select the function **TOF MODE**.
- Press the function keys to choose the required setting.

Starting point of gate B

GATEMODE	
GATE A LOGIC	NEGATIVE
GATE B LOGIC	POSITIVE
B START MODE	IP
OUTPUT SELECT	A (-)

The start of the gate B (function **B-start**) is normally positioned starting from the initial pulse, as in the case of gate A.

You can alternatively specify the start of the gate B in relation to an event in gate A. This function is also referred to as automatic gate tracking.

If there is no event in the gate A, the starting point of the gate B is identical with the value of the function **A-start**.

- Switch to the second operating level.
- In the function group **CONFIG2**, select the function **B START MODE**.
- Press the function keys to choose the required setting.

If you choose the setting **A**, the gate B is afterwards always shifted automatically when you shift the starting point of the gate A

The width and the threshold of the gate B are not affected by the gate tracking.

The tracking of the optional gate C is identical with that of the gate B. However, the gate C can additionally still be coupled to events in the gate B.

Automatic gate height

GATEMODE	
GATE A LOGIC	NEGATIVE
GATE B LOGIC	POSITIVE
B START MODE	IP
OUTPUT SELECT	A (-)

The USM Go can adjust the height of the gates automatically to the echo amplitude in the corresponding gate by means of the function AGT (Automatic Gate Threshold).

You will then no longer define the height of the gate in % screen height but in % echo amplitude.

You can set the value within the range of 5 ... 95 % and -5 ... -95 %.

This function is not available for the optional gate C.

- Switch to the second operating level.
- In the function group **EVAL**, select the function **AGT**.
- Press the function keys to choose the required gate for the automatic adjustment.

If you have turned on the function AGT for one gate or for the two gates, the setting THRESHOLD on the first operating level is no longer displayed as % but as AGT = %, in the RF mode provided with the sign + or –.

gate a start	30.00 mm
gate a width	15.00 mm
A THRESHOLD	AGT = 50%
TOF MODE	FLANK

5.8 Calibrating the USM Go

Calibrating the display range

Before working with the USM Go, you have to calibrate the instrument: You have to adjust the material velocity and the display range, as well as allow for the probe delay, depending on the material and the dimensions of the test object.

To ensure a safe and proper operation of the USM Go, it is necessary that the operator be adequately trained in the field of ultrasonic testing technology.

Below you will find some examples of common calibration methods for certain test applications. In addition, the USM Go is provided with a semi-automatic calibration function (see Section **Case B: With unknown material velocity**, page 5-31).

Choice of the measuring point

The sound path measurement by means of the echo evaluation depends on the choice of measuring point (see Section **TOF MODE**, page 5-25).



ATTENTION

In any case, the setting of the measuring point in TOF mode for the calibration and for the subsequent test use must always be identical. Otherwise, measuring errors may occur.

Calibration with straight-beam and angle-beam probes

Case A: With known material velocity

- Set the known material velocity (function group **RANGE**).
- Couple the probe to the calibration block.
- Set the required display range using the function **RANGE**. The calibration echo must be displayed on the screen.
- Position the gate on one of the calibration echoes until the sound path of the echo is indicated in the measurement line.
- After this, adjust the setting of the function **PROBE DELAY** until the correct sound path for the selected calibration echo is indicated in the measurement line.

Example

You are carrying out the calibration for the calibration range 100 mm using the calibration standard K1 (thickness 25 mm) which is laid down flat.

- Set **RANGE** to 100 mm.
- Set the known material velocity of 5920 m/s (please see ISO 10863).
- Set the gate so that it is positioned on the first calibration echo (from 25 mm).
- Read the sound path in the measurement line. If this value is not equal to 25 mm, adjust the setting of the function **PROBE DELAY** until it is at 25 mm.

This completes the calibration of the USM Go to the material velocity of 5920 m/s with a calibration range of 100 mm for the probe used.

Case B: With unknown material velocity

Use the semi-automatic calibration function of the USM Go with the functions of the function group **AUTO-CAL** for this calibration case.

gate a start	0.72 mm
s-ref1	12.50 mm
s-ref2	100.00 mm
RECORD	OFF

You have to enter the distances (lines) of two calibration echoes as default settings. The USM Go will then carry out a plausibility check, calculate the material velocity and the probe delay, and set the parameters automatically if the plausibility is given. Otherwise, an error message is given.

- Set the required display range using the function **RANGE**. The two selected calibration echoes must be displayed on the screen. Set the range so that the second calibration echo is positioned in the right half of the screen.
- Switch to the function group **AUTOCAL**.
- Enter the distances of the two calibration echoes in **S-REF 1** and **S-REF 2**.
- Position the gate on the first calibration echo (**A-START**).
- Switch to the function **RECORD** and press a function key.
- Press a function key again to record the first calibration echo.
- Shift the gate to the second calibration echo.
- Switch to the function **RECORD** again and press a function key to record the second calibration echo.

The correct calibration is confirmed by the message **AUTOCAL COMPLETE**.

The USM Go will then automatically determine the material velocity and the probe delay, and set the corresponding functions accordingly.



Note

If the instrument cannot carry out any valid calibration on the basis of the values entered and the echoes recorded, a corresponding error message is displayed. In this case, check the values of your calibration lines and record the calibration echoes again.

Example

- Enter the two calibration lines (thicknesses) **S-REF 1** (5.00 mm) and **S-REF 2** (20.00 mm).

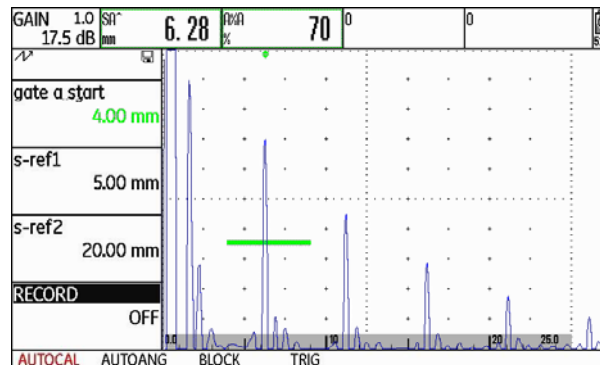

- Position the gate on the first calibration echo.

- Record the first calibration echo.

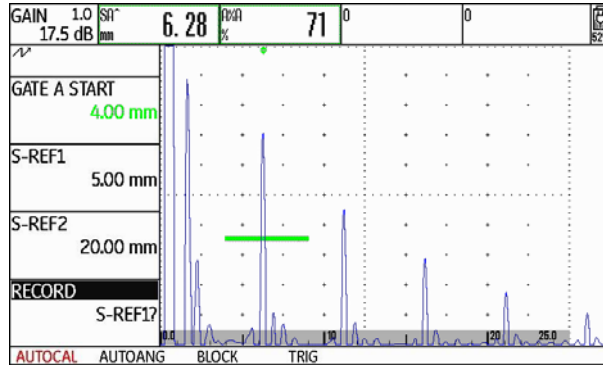

- Position the gate on the second calibration echo and record the second calibration echo.

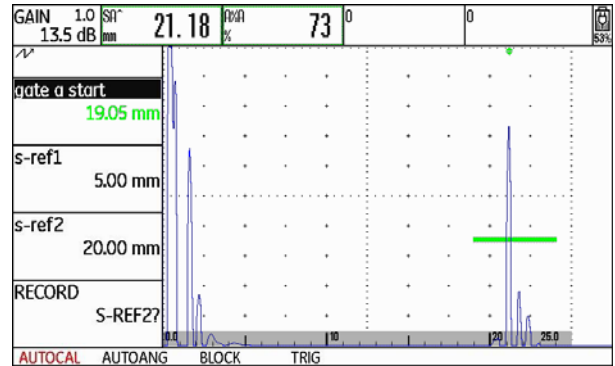

- The valid calibration is carried out and confirmed.

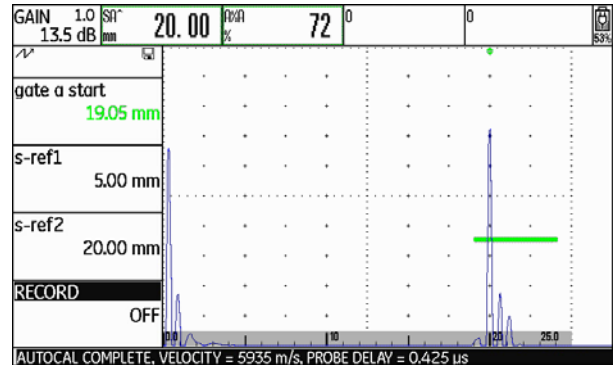

You can read the material velocity and the probe delay in the function group **RANGE**.

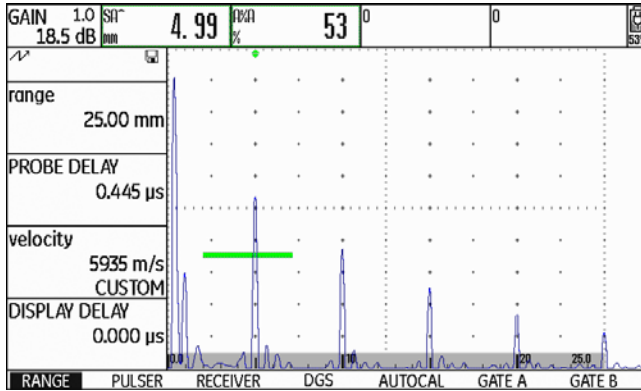

Calibration using dual-element probes

Dual-element probes are especially used for wall thickness measurements. The following special features should be taken into account when using these probes:

V-path error

Dual-element probes produce a v-shaped sound path from the pulser via the reflection from the backwall to the receiver element. This V-path error affects the measuring accuracy. You should therefore choose two wall thicknesses that cover the expected thickness measurement range for the calibration. In this way, the V-path error can be corrected to a large extent.

Higher material velocity

Due to the V-path error, a higher material velocity than that of the material to be tested is given during calibration, especially with small thicknesses. This is typical of dual-element probes and serves for the compensation of the V-path error.

With small wall thicknesses, the effect described above leads to an echo amplitude drop which has to be especially taken into account with thicknesses <2 mm.

A stepped reference block having different wall thicknesses is required for calibration. The wall thicknesses must be selected in such a way that they cover the expected measurement readings.

The use of the semi-automatic calibration is recommended for calibration with a dual-element probe.

- Set the required test range.
- Vary the probe delay until the two calibration lines are displayed within this range.
- Set the functions of pulser and receiver according to the probe used and to the test application.
- Set the function **TOF MODE** (function group **GATE A**) to **FLANK**.
- Select the gain so that the highest echo reaches approximately the full screen height.

- Set the gate threshold to the required height for measuring the sound paths at the echo flanks.
- Switch to the function group **AUTOCAL**.
- Enter the two calibration lines (thicknesses) **S-REF 1** and **S-REF 2**.
- Position the gate on the first calibration echo (function **A-START**).
- Record the first calibration echo.
- After this, couple the probe to the calibration block with the second calibration line and adjust the echo height so that it is approximately as high as for the first calibration echo.
- If necessary, shift the gate to the second calibration echo.
- Record the second calibration echo.

The correct calibration is confirmed by the message **AUTOCAL COMPLETE**. The material velocity and probe delay are set and displayed.

- Check the calibration on one or several known calibration lines, e.g. using the stepped calibration block VW.



Note

Always keep in mind that the measurement value is determined at the intersection point of the gate and the echo flank if the function **TOF MODE** has been set to **FLANK**. The correct setting of the echo height and the gate threshold is therefore decisive for the accuracy of calibration and measurement! The use of the function **AGT** can be of help in this connection (see Section **Automatic gate height**, page 5-28).

Calibrations or measurements in **PEAK** mode require some experience when using dual-element probes in order to choose and set the correct echoes.

5.9 Making measurements

General notes

Please pay attention to the following notes when using the USM Go for measurements:

- A prerequisite for the measurement is always the correct calibration (material velocity, probe delay).
- All amplitude measurements are made at the highest or the first signal in the gate.
- All distance measurements are made at the intersection point between the gate and the first echo flank (**TOF MODE = FLANK, J-FLANK, FIRST PEAK**) or at the peak of the highest echo in the gate (**TOF MODE = PEAK**).
- If the amplitudes of the echoes in the gate do not exceed 5 % screen height, all corresponding sound path and amplitude readings are rejected. This enables to avoid quickly changing, random readings based on background noise of the USM Go.

The following example shows the dependency of distance measurement on the echo waveform, i.e. on the height of the gate threshold and thus on the selection of the intersection point at the signal.

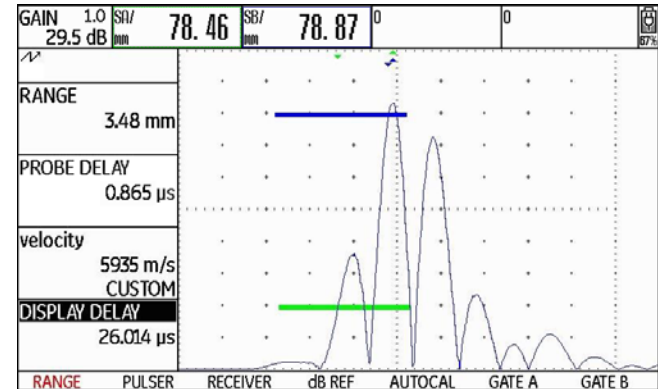

Gate A set to 20 % screen height
measured sound path **SAI** = 78.46 mm

Gate B set to 80 % screen height
measured sound path **SBI** = 78.87 mm

5.10 dB-difference measurement (function group dB REF)

MODE	OFF
REFERENCE	(NO REF)
RECORD	(NO REF)
DELETE REF	

You can evaluate reflector echoes by means of reference echoes. The function group **dB REF** provides you with all the functions needed for the echo height comparison between a reflector echo and a reference echo.

- Switch to the first operating level.
- Select the function group **dB REF**.



Note

Depending on the evaluation mode selected, one of the function groups **DAC/TCG**, **DGS**, **AWS D1.1**, **JISDAC** or **CNDAC** can also be displayed at this point (see Section **EVAL MODE**, page 5-73).

You will find the following functions:

MODE	Activating dB-difference measurement
REFERENCE	Display of reference gain
RECORD	Storing the reference echo
DELETE REF	Deleting the reference echo

The functions are described in the order in which you need them during your work.

Recording a reference echo

Before using the dB-difference measurement, you have to record a reference echo at first.

If a reference echo has already been stored, you have to delete it at first before recording a new reference echo (please see section below).

- Peak the reference echo according to the test instruction.
- Use the function **A-start** to position the gate A on the reference echo.
- Select the function **RECORD** and press a function key. The reference echo is recorded and stored.

Deleting a reference echo

You can delete a stored reference echo at any time.

- If necessary, select the function **DELETE REF** and press a function key to delete the stored reference echo.
- Press the two function keys at the same time to confirm the deletion.

Echo height comparison

You can compare the echo from any chosen reflector with the reference echo.

The following values are available for indication in the measurement line:

- **dBrA**
dB-difference between the reference echo and the highest echo in the gate A.
- **A%rA**
Amplitude of the signal in the gate A in percent referred to the reference amplitude as 100 %.
- **dBrB**
dB-difference between the reference echo and the highest echo in the gate B.
- **A%rB**
Amplitude of the signal in the gate B in percent referred to the reference amplitude as 100 %.



Note

The dB-difference is independent of any possible gain variation.

- Switch to the function group **EVAL** on the second operating level.
- Use the functions **READING** to choose one or several values to be indicated in the measurement line.
- Position the gate A on the echo.
- Select the function **MODE** and press a function key to turn on the function.

The selected readings are then indicated in the measurement line.

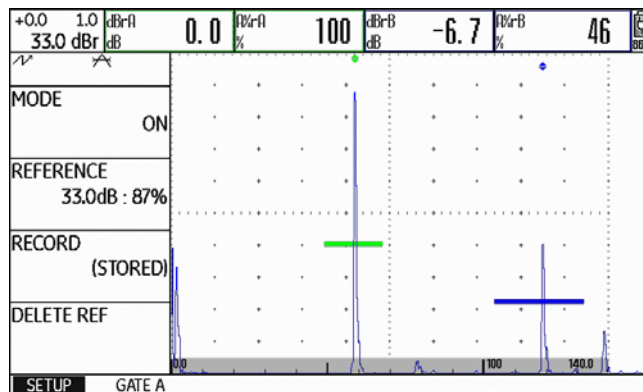

5.11 Rating of welds (function group AWS D1.1)

A INDICATION ***** (RUNNING)
B REFERENCE *****
C ATTENUATION *****
D D1.1 RATING *****

- Switch to the second operating level.
- In the function group **EVAL**, select the function **EVAL MODE** and press the function keys to choose the evaluation method **AWS D1.1**.
- Switch to the first operating level.
- Select the function group **AWS D1.1**.

You can evaluate defects in welds according to the specification AWS D1.1. You will find the corresponding functions in the function group **AWS D1.1**.

Rating of welds according to AWS D1.1

The rating of defects in welds according to the specification AWS D1.1 is based on an evaluation of the signal amplitude. In this method, the echo amplitude of the flaw echo is compared with the echo amplitude of a known reference reflector. In addition, the sound attenuation in the test object is also taken into account.

The result is a dB value which is called flaw class. The flaw class D is calculated according to the formula:

$$D = A - B - C$$

with:

- **A = flaw gain (in dB)**
Absolute instrument gain with which the maximum flaw echo is at 50 % (± 5 %) echo height.
- **B = reference gain (in dB)**
Absolute instrument gain with which the maximum reference echo (e.g. the 1.5 mm side-drilled hole from the reference standard V1 or IIW type 1 or 2) is at 50 % (± 5 %) echo height.
- **C = sound attenuation factor (in dB)**
The value is calculated according to the formula:
 $C = 0.079 \text{ dB/mm} \cdot (s - 25.4 \text{ mm})$, with s = sound path of the flaw echo.

The sound attenuation correction is calculated and displayed automatically by the instrument. The value is set to zero for sound paths smaller than or equal to 25.4 mm (1 inch).
- **D = flaw class (in dB)**
This is the result of the evaluation according to AWS. The calculation is made in the USM Go according to the above-mentioned formula.

**Note**

Make sure that all instrument options for the specific test are calibrated before starting the rating according to AWS D1.1.

Remember to peak an echo with an amplitude between 45 % and 55 % screen height. A rating is not possible with other amplitudes.

- Apply couplant and couple the probe to the reference standard. Maximize the echo from the 1.5 mm side-drilled hole.
- Select the function **A-START** and adjust the gate A on the reference echo.
- Vary the gain so that the reference echo is indicated at 50 % screen height.
- Switch to the function group **AWS D1.1**.
- Select the function **B REFERENCE** and confirm the selection to store the reference gain.

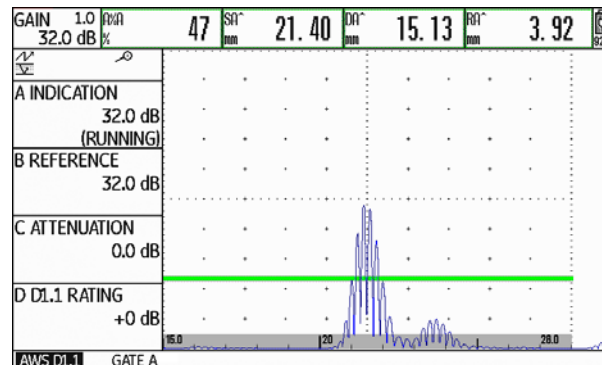

- Couple the probe to the test object to evaluate a flaw echo.
- Select the function **A-START** and adjust the gate A on the flaw echo.
- Vary the gain so that the flaw echo is indicated at 50 % screen height.
- Switch to the function group **AWS D1.1**.
- Store the current gain by means of the function **A INDICATION**. The current gain is stored.

The USM Go determines automatically the values of the AWS variables C and D. You can then evaluate the rating D using the corresponding requirements from AWS D1.1.

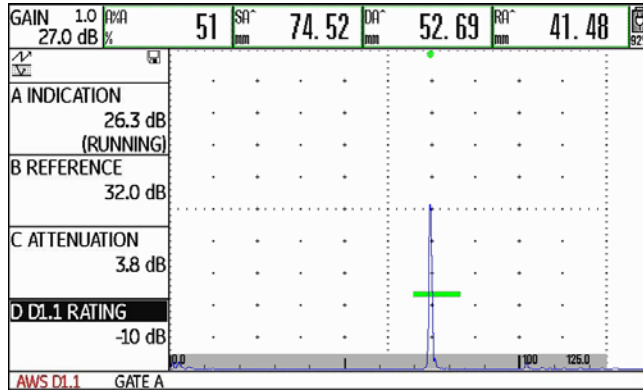

5.12 Flaw position calculation with angle-beam probes

TRIG	
PROBE ANGLE	45.0 1.00 (K)
THICKNESS	50.00 mm
X VALUE	0.00 mm
O-DIAMETER	FLAT

You will find the functions for setting the flaw position calculation when using angle-beam probes in the function group **AUTOCAL > TRIG** on the first operating level and in the function group **EVAL**, in the column **TRIG** on the second operating level.

- If necessary, switch to the second operating level.
- Select the function group **EVAL**.

In addition to the sound path S , the (reduced) projection distance and the true depth of the flaw are calculated automatically and indicated in the measurement line by means of these functions.

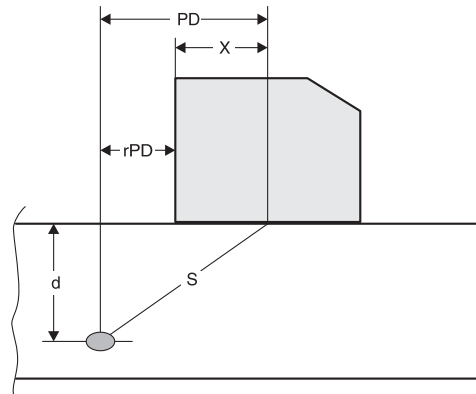

- **Projection distance PD**

Distance from the probe beam index point to the position of the flaw, projected onto the surface.

- **Reduced projection distance rPD**

Distance from the probe front edge to the position of the flaw, projected onto the surface.

- **Depth d**

Distance between flaw position and surface.

When working with angle-beam probes, the USM Go can calculate the leg **L** up to the next reflection point as well. This leg can be indicated as the reading **LA**, **LB**, or **LC** in the measurement line.

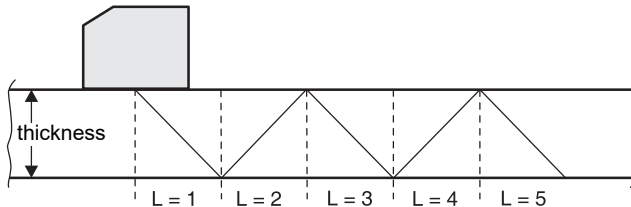

PROBE ANGLE

You can use the function **PROBE ANGLE** to adjust the angle of incidence of your probe for the material used. This value is required for the automatic calculation of flaw position.

The following settings are possible:

- OFF (the function is turned off)
- 30° ... 90°

You can set the value by coarse adjustment steps or by fine adjustment (see Section **Coarse and fine adjustment of functions**, page 4-10).

When a setting is selected, the tangent of the angle is additionally indicated for information below the angle indication.

This value enables a good estimation of the position of the first reflection after the probe index (sound exit) with regard to the object thickness of the test block.

Example: Object thickness 20 mm

- Angle of incidence 45°,
K = 1, 1. Reflection after 20 mm
 - Angle of incidence 60°,
K = 1.73, 1. Reflection after
 $1.73 \times 20 \text{ mm} = 34.6 \text{ mm}$
 - Angle of incidence 70°,
K = 2.75, 1. Reflection after
 $2.75 \times 20 \text{ mm} = 55.0 \text{ mm}$
 - Angle of incidence 80°,
K = 5.67, 1. Reflection after
 $5.67 \times 20 \text{ mm} = 113.4 \text{ mm}$
- Select the function **PROBE ANGLE**.
- Press the function keys to choose the required setting.

THICKNESS

You can use the function **THICKNESS** to set the wall thickness of the test object. This value is required for the automatic calculation of the true depth.

The adjustment range is 1.00 ... 27940.00 mm.

You can set the value by coarse adjustment steps or by fine adjustment (see Section **Coarse and fine adjustment of functions**, page 4-10).

- Select the function **THICKNESS**.
- Set the required value by means of the function keys or using the navigation.

X VALUE

You can use the function **X VALUE** to set the X value (distance of probe front edge from the probe index or sound exit point) of the probe used. This value is required for the automatic calculation of the reduced projection distance.

The adjustment range is 0.00 ... 254.00 mm.

You can set the value by coarse adjustment steps or by fine adjustment (see Section **Coarse and fine adjustment of functions**, page 4-10).

- Select the function **X VALUE**.
- Set the required value by means of the function keys or using the navigation.

O-DIAMETER

You need the function **O-DIAMETER** when working with circular curved surfaces, e.g. when inspecting longitudinally welded tubes perpendicular to the main axis of the tube. To make the USM Go carry out the corresponding correction of the (reduced) projection distance and depth, enter the outside diameter of your test object here.

If you want to carry out the flaw position calculation for flat plane-parallel test objects, the function **O-DIAMETER** must be set to **FLAT**.

You can set the value by coarse adjustment steps or by fine adjustment (see Section **Coarse and fine adjustment of functions**, page 4-10).

The following settings are possible:

- 50 ... 2000 mm
- FLAT

- Select the function **O-DIAMETER**.
- Set the required value by means of the function keys or using the navigation.

COLOR LEG

For better orientation, the instrument can mark the legs for the first three reflections with different background colors.

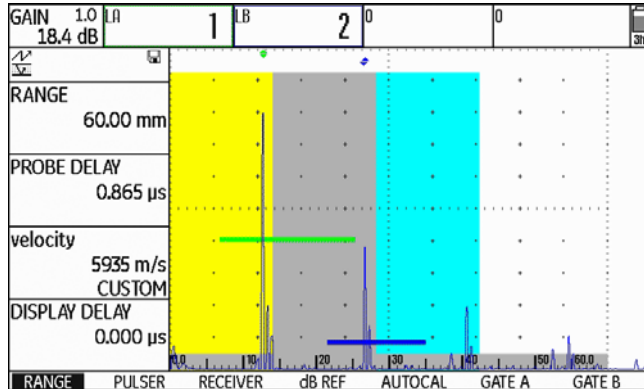

- If necessary, switch to the second operating level.
- Select the function group **EVAL**.
- Select the function **COLOR LEG**.
- Press a function key to turn the function on.

5.13 Defining the probe angle

You can use the function **AUTOANG** to define the current index angle of a probe on a reference block. The current probe index angle is influenced, e.g. by different materials or by the wear of the probe contact face.

BLOCK	K2 30-65
gate a start	14.27 mm
A THRESHOLD	23%
RECORD	OFF



ATTENTION

You have to carry out calibration before using the function **AUTOANG** (see Chapter 5.8 **Calibrating the USM Go**, page 5-29).

- After calibration, switch to the function group **AUTOANG**.
- Select the function **BLOCK** and press a function key to choose the range of the calibration standard that includes the nominal value of the probe angle (for example K2 30-65 for the nominal value 45°).
- Shift the gate to the calibration echo.
- Switch to the function **RECORD** and press a function key to record the calibration echo.
- Peak the echo. The USM Go will automatically record the time-of-flight of the echo with the maximum amplitude occurring during this.
- Press a function key to set the function **RECORD** back to **OFF**.

The calculated angle is briefly displayed at the bottom edge of the display screen.

AUTOCAL COMPLETE, ANGLE = 45.3, K = 1.01

The values of the last measurement are automatically entered in the function group **TRIG**, i.e. in the function **PROBE ANGLE** there.

BLOCK

You can read the preselected test ranges of various calibration standards in the function group **BLOCK**.

Example: K2 65-75

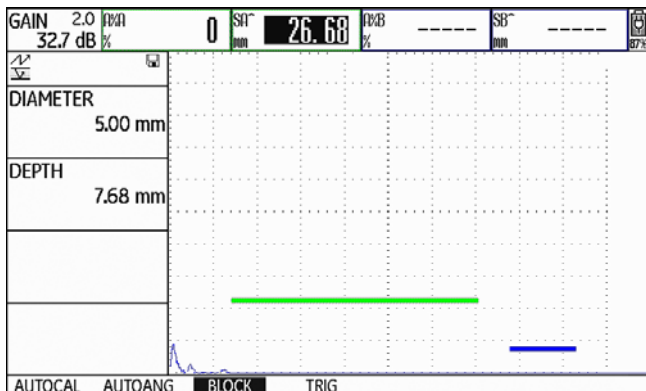

The side-drilled hole is located at a depth of 7.68 mm and has a diameter of 5.00 mm.

The option **CUSTOM** in the function **BLOCK** (function group **AUTOANG**) enables you to design a calibration standard of your own and to enter its values in the functions **DIAMETER** and **DEPTH** (function group **BLOCK**).

BLOCK	CUSTOM
gate a start	14.27 mm
A THRESHOLD	23%
RECORD	OFF

DIAMETER	1.50 mm
DEPTH	15.00 mm

In this regard, it is important that **DEPTH** always refers to the center of the side-drilled hole and not to the real reflecting surface.

5.14 Enabling options (Upgrade)

CODE
SERIAL NUMBER USMGO09100154
CODE 000000
CONFIRM
ECHO MAX OFF

The USM Go is equipped with various options, e.g. for different evaluation methods. You can enable these options by entering the corresponding codes.



Note

To order options, you need the serial number of your instrument (please see function group **CONFIG1** on the second operating level).

- Switch to the second operating level.
- In the function group **CONFIG1**, select the function **CODE** and briefly press the joystick (USM Go) or the center key of the keypad (USM Go+).
- Use the navigation to choose the first character of the code.
- Use the navigation to switch over to the next position, and choose the next character.
- Press the joystick (USM Go) or the center key of the keypad (USM Go+) briefly to close the code entry.
- Switch to the function **CONFIRM** and press a function key to confirm the code you have entered.

If the code you have just entered is correct, the option is enabled and is immediately available.

- Switch to the function group **CONFIG2** and to the function **ABOUT** there.
- Press the joystick (USM Go) or the center key of the keypad (USM Go+) briefly to display the start display with the information about the options available.

5.15 Configuring the USM Go for test tasks

Besides the default settings for the instrument operation, you have to configure the USM Go for calibration and test tasks. You will find functions for this purpose primarily in the function groups **EVAL**, **CONFIG1**, and **CONFIG2** on the second operating level.

You will find the function **TOF MODE** in the function groups **GATE A** and **GATE B** on the first operating level.

Moreover, you have to check and, if necessary, correct the current date and time so that this information is stored correctly together with the test results.

TOF MODE

gate a start	0.72 mm
gate a width	2.50 mm
A THRESHOLD	70%
TOF MODE	FLANK

The sound path measurement by means of the echo evaluation depends on the choice of the measuring point.

The following settings are possible:

- **PEAK** (peak measurement)
The amplitude and the time-of-flight are measured at the absolutely highest amplitude value within the gate with maximum resolution of the instrument.
- **FLANK** (flank measurement)
The amplitude is measured as in the case of **PEAK** and the time-of-flight is measured at the first point of intersection between the echo and the gate with maximum resolution of the instrument.
- **J-FLANK**
The time-of-flight is measured as in the case of **FLANK**, the amplitude measurement from the 1st change of direction downwards if the gate threshold is afterwards not reached yet another time.
- **FIRST PEAK**
The measurement is made as in the case of **J-FLANK**, however, with screen resolution.



ATTENTION

The highest echo in the gate does not have to be identical with the echo for which the sound path is measured. This can lead to evaluation errors!

Two measurement arrows are used in order to clearly identify readings and to avoid any misinterpretations. The display shows

- the position at which the sound path (distance) is measured: arrowhead downwards, and
- where the amplitude is measured: arrowhead upwards.

In addition to the measurement reading, the TOF mode measuring point (peak or flank) is displayed with a symbol in the measurement line in sound path measurements:

^ = measuring point Peak

/ = measuring point Flank

Examples:

SA^ = sound path within gate A, measuring point Peak

SA/ = sound path within gate A, measuring point Flank

Example: PEAK

With the setting **PEAK**, the sound path and amplitude measurements are made at the peak of the highest echo in the gate.

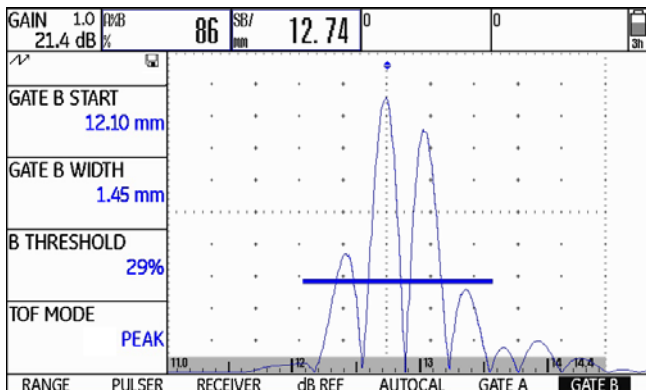

measured sound path: 12.74 mm
amplitude: 86 %

Example: FLANK

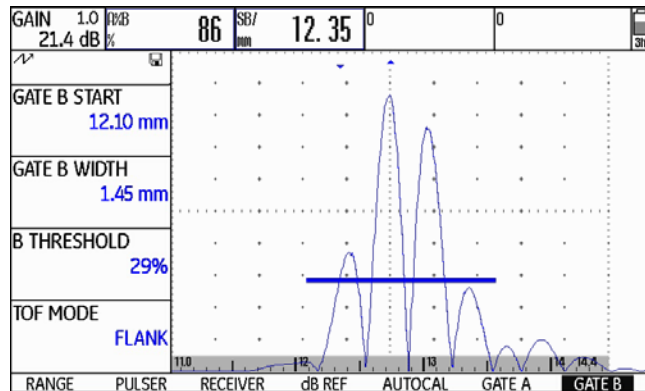

measured sound path: 12.35 mm
amplitude: 86 %

Example: J-FLANK

With the setting **J-FLANK**, the sound path measurement is made at the intersection point between the gate threshold and the leading edge of the first echo, and the amplitude measurement is made at the peak of the first echo in the gate, even if there are other, higher signals within the gate.

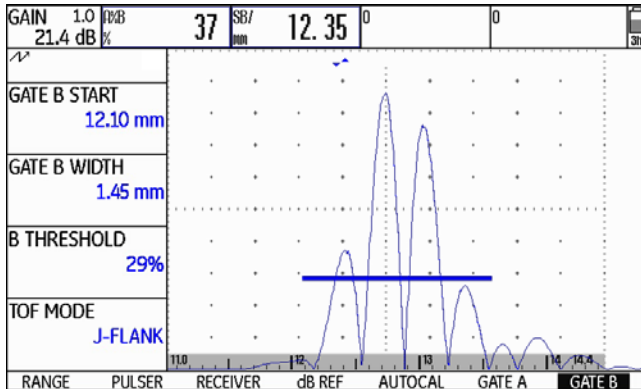

measured sound path: 12.35 mm
 amplitude: 37 %

Example: FIRST PEAK

Since the gate is not reached yet another time after the first PEAK, **J-FLANK** and **FIRST PEAK** show the same results for **A%B**: 37 %

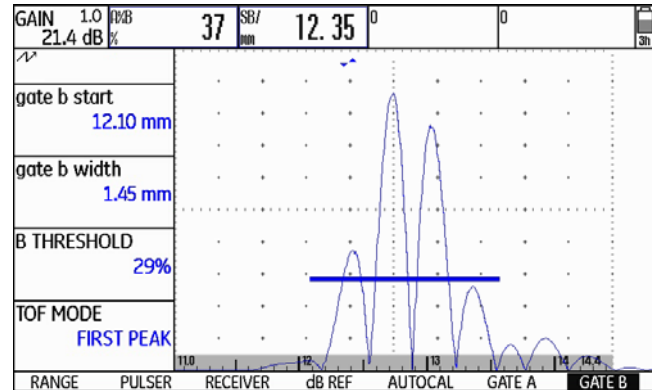

measured sound path: 12.35 mm
 amplitude: 37 %

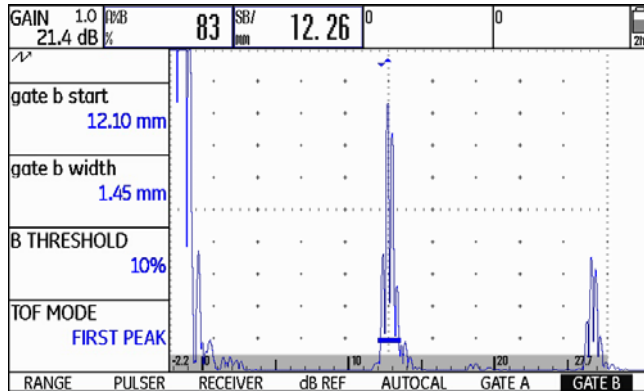

ATTENTION

In any case, the setting of the measuring point in TOF mode for the calibration and for the subsequent test use must always be identical. Otherwise, measuring errors may occur.

- Switch to the first operating level.
- Select the function group **GATE A** or **GATE B**.
- Select the function **TOF MODE**.
- Press the function keys to choose the required setting.

Phantom echo detector

PULSER
PULSER TYPE SQUARE
PRF MODE AUTO LOW 400 Hz
PHANTOM PRF ON

You can use the function **PHANTOM PRF** to turn on the phantom echo detector of the USM Go. When the function is turned on, phantom echoes become visible due to a regular movement sideways.

Especially when inspecting forgings, it is recommended to leave the phantom echo detector turned on permanently in order to detect phantom echoes.

As long as no phantom echoes occur, no distinction can be made in the echo representation between the settings **ON** and **OFF**.

As soon as the phantom echoes appear in the setting **ON**, they can be recognized at once by a regular movement back and forth (approx. 3/s). If this is the case, vary the pulse repetition frequency until the phantom echoes disappear or have at least become sufficiently small.



Note

It is recommended to always leave the phantom echo detector turned on. In this way, problems are recognized at once.

- Switch to the second operating level.
- Select the function group **CONFIG2**.
- Select the function **PHANTOM PRF** and press a function key to turn on the phantom echo detector.

Configuring the measurement line

RESULTS2	
MODE	SMALL
READING 5	A%A
READING 6	A%B
LARGE	SA

You can configure the individual items of the measurement line by means of the functions **READING 1** to **READING 6** of the function group **EVAL**, i.e. you can choose the reading and the possible position at which it should be directly displayed during the test.



Note

As an alternative to a reading, you can display the virtual alarm LED (see Section **LARGE (alarm signal)**, page 5-64) or the dataset name (see Section **Displaying dataset name**, page 4-22) in the large box on the far right.

The following readings are selectable:

- A%A** Echo height in gate A in % screen height
- A%B** Echo height in gate B in % screen height
- A%C** Echo height in gate C in % screen height
- SA** Sound path for gate A
- SB** Sound path for gate B
- SC** Sound path for gate C

SBA	Difference between single measurements of sound path (gate B - gate A)	PA	Projection distance for gate A
SCB	Difference between single measurements of sound path (gate C - gate B)	PB	Projection distance for gate B
dBrA	Echo height in gate A in dB	RA	Reduced projection distance for gate A
dBrB	Echo height in gate B in dB	RB	Reduced projection distance for gate B
dBrC	Echo height in gate C in dB	Only for DGS:	
LA	Number of legs in gate A	ERS	Equivalent reflector size
LB	Number of legs in gate B	Gt	DGS test sensitivity
Only for flaw position calculation:		Gr	DGS reference gain (= instrument gain for the reference echo at 80 % screen height)
DA	Depth for gate A	CLS	Only with JISDAC: flaw class according to JIS (I, II, III, IV)
DB	Depth for gate B		

dBrA	Difference of the amplitude of the highest echo in gate A below or above the DAC or TCG reference curve in dB	A%rA	Amplitude of the highest echo in gate A in relation (in %) to the DAC or TCG reference curve (as 100 %)
dBrB	Difference of the amplitude of the highest echo in gate B below or above the DAC or TCG reference curve in dB	A%rB	Amplitude of the highest echo in gate B in relation (in %) to the DAC or TCG reference curve (as 100 %)
SLA	Only with CNDAC: Difference of the amplitude of the highest echo in gate A below or above the DAC or TCG reference curve in dB	A%rC	Amplitude of the highest echo in gate C in relation (in %) to the DAC or TCG reference curve (as 100 %)
SLB	Only with CNDAC: Difference of the amplitude of the highest echo in gate B below or above the DAC or TCG reference curve in dB		
SLC	Only with CNDAC: Difference of the amplitude of the highest echo in gate C below or above the DAC or TCG reference curve in dB		

- Switch to the second operating level.
- Select the function group **EVAL** .
- Select the function **READING 1** to choose the reading for the first position.
- Press the function keys to select the required value.
- Choose the readings for the other positions in the same way.



Note

While a reading is chosen, brief information about the reading is displayed at the top edge of the display screen.

Enlarged display of reading

RESULTS2	
MODE	SMALL
READING 5	A%A
READING 6	A%B
LARGE	SA

The functions **MODE** and **LARGE** enable you to display one or four readings in enlarged mode on top of the A-scan.

If only a single reading is displayed in enlarged mode, six other boxes are available for readings in the measurement line. If four readings are displayed in enlarged mode, no other readings are displayed.

Enlarged display of one reading:

GAIN	0.6	71 %	0 %	71 %	SN/	2.24
24.6 dB	SN/ =	2.24 mm	SB =	0.00 mm	71 %	2.24

Enlarged display of four readings:

GAIN	0.2	81	SN/	26.30	dB	0.1	Sba	24.58
29.4 dB	%	mm	mm	dB	mm	mm	mm	mm

Readings referring mainly to the gate A are put in green frames, readings referring to the gate B in blue frames, and readings referring to the gate C in red frames.

The same readings can be selected for the enlarged display as for the display in small boxes (see Section **Configuring the measurement line**, page 5-59).



Note

As an alternative to a reading, you can display the virtual alarm LED (see Section **LARGE (alarm signal)**, page 5-64) or the dataset name (see Section **Displaying dataset name**, page 4-22).

- Switch to the second operating level.
- Select the function group **EVAL**.
- Select the function **LARGE** to display a single reading in enlarged mode.
- Press the function keys to select the required value.
- Select the function **MODE** to display four readings in enlarged mode.
- Press a function key to select the setting **LARGE**. The readings selected in the functions **READING 1** to **READING 4** are displayed in enlarged mode.



Note

For the selection of readings, see Section **Configuring the measurement line**, page 5-59.

All boxes which cannot be displayed are **DISABLED**.

LARGE (alarm signal)

RESULTS2	
MODE	SMALL
READING 5	A%A
READING 6	A%B
LARGE	SA

You can display an alarm signal in the form of a virtual LED in the far right box in the measurement line on top of the A-scan. When an alarm is triggered, the color of the alarm signal changes from green to red.



Note

For the configuration of the alarm output, see Section **Configuring the alarm output**, page 5-77.

- Switch to the second operating level.
- Select the function group **EVAL**.
- Select the function **LARGE** or **READING 4** and press a function key to select the setting **VIRTUAL LED**.

This turns the alarm signal on, and it is displayed next to the readings on top of the A-scan.

GAIN	0.2	REF=	83 %	DM=	----	mm	REF=	83 %	A
	47,4 dB	SN=	42.83 mm	RM=	----	mm	REF=	54 %	



Note

You can turn the alarm trigger on by means of the gate logic (see Section **Gate logic**, page 5-74).

All boxes which cannot be displayed are **DISABLED**.

MAGNIFY GATE (spanning the gate)

EVALMODE	
EVAL MODE	dB REF
COLOR LEG	OFF
MAGNIFY GATE	GATE A
AGT	OFF

The setting of the function **MAGNIFY GATE** causes the selected gate to span over the entire displayed range. You can choose a gate for the magnify gate function.

- Switch to the second operating level.
- Select the function group **EVAL**.
- Select the function **MAGNIFY GATE** to choose the gate for this function.
- Press the function keys to choose the required gate.



Note

In order to use the magnify gate function, the function **MAGNIFY GATE** must be assigned to one of the function keys (see Section **Activating the magnify gate function**, page 5-66).

Activating the magnify gate function

SETUP	
FUNCTION 1	MAGNIFY GATE NONE
FUNCTION 2	FREEZE COPY
ABOUT	SHOW
ASCAN FILL	OFF

To be able to use the magnify gate function for spanning a gate over the entire displayed range you must configure one of the function keys accordingly.

Besides this, the gate must be broad enough, otherwise an error message is given.



Note

In order to use the magnify gate function, a gate must be chosen for it (see Section **MAGNIFY GATE (spanning the gate)**, page 5-65).

- Switch to the second operating level.
- Select the function group **CONFIG2**.
- For example, select the function **FUNCTION 1** in order to use the upper function key for the magnify gate function.
- Activate the function (see Section **Activating functions**, page 4-12). The upper option is selected and you can now choose the function for the brief key press.
- Use the navigation to select the function **MAGNIFY GATE** for the brief key press.
- Finally, deactivate the function **FUNCTION 1**.
- Switch over to the first operating level and briefly press the upper function key. The gate is displayed over the entire range.

Normal A-scan:

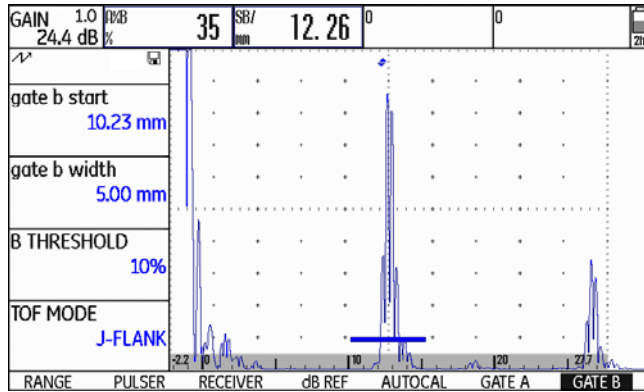

A-scan with magnify gate turned on for the gate B:

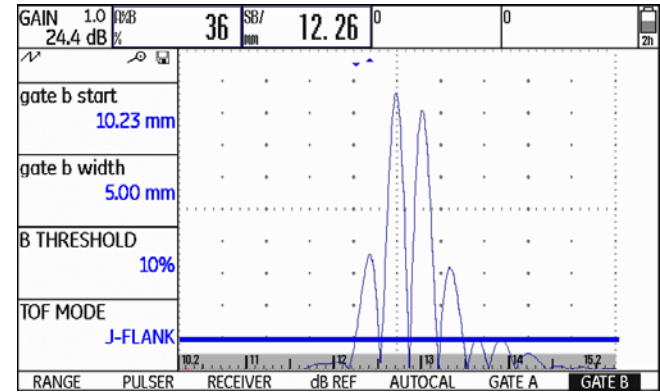

Automatic A-scan freeze (Freeze)

FREEZE	
FREEZE MODE	STANDARD
ENVELOPE	OFF
ENVELOPE COLOR	BLUE
POWER SAVER	OFF

In the function group **CONFIG3**, the USM Go offers with its function **FREEZE MODE** various options for automatic freezing of the A-scan.

The following settings are possible:

- **STANDARD**

By assigning the function **FREEZE** to one of the function keys, you can manually freeze the A-scan (see Chapter 5.3 **Assignment of function keys**, page 5-8).

- **A-FREEZE**

The A-scan is frozen automatically when the signal touches the gate A. This setting is suitable e.g. for measurements on hot test objects, for measurements in difficult coupling conditions, or for spot weld testing.

- **B-FREEZE ***

The A-scan is frozen automatically when the signal touches the gate B. This setting is suitable e.g. for measurements on hot test objects, for measurements in difficult coupling conditions, or for spot weld testing.

- **AB-FREEZE ***

The A-scan is frozen automatically when the signal touches either one of the gates A or B.

- **COMPARE**

The manually frozen A-scan is displayed for comparison purposes in the background while the currently active A-scan is at the same time visible in the foreground. When leaving the function **FREEZE**, the last A-scan is recorded and displayed for comparison purposes.

- * If the function **B START MODE** is set to **A** for the gate B, the function **FREEZE** will not be effective until the interface echo has also reached the gate A beforehand.

- Switch to the second operating level.
- Select the function group **CONFIG3**.
- Select the function **FREEZE MODE** and press the function keys to select the required setting.

Manual A-scan freeze

To be able to manually freeze the A-scan, you have to configure one of the function keys accordingly.

- Switch to the second operating level.
- Select the function group **CONFIG2**.
- For example, select the function **FUNCTION 1** in order to use the upper function key for the A-scan freeze.
- Activate the function (see Section **Activating functions**, page 4-12). The upper option is selected and you can now choose the function for the brief key press.

- Use the navigation to select the function **FREEZE** for the brief key press.
- Finally, deactivate the function **FUNCTION 1**.
- Switch to the first operating level and briefly press the upper function key. The A-scan is frozen.
- Press the upper function key briefly again. You will again see the live A-scan.

5.16 Setting the display

The most important default settings of the display screen are described in Chapter 4.6 **Default settings of the display**:

- Scheme (see page 4-16)
- A-scan color (see page 4-17)
- Grid (see page 4-18)
- Brightness (see page 4-18)

Additional settings affecting the representation on the display screen are described below.

ASCAN FILL

SETUP	
FUNCTION 1	MAGNIFY GATE NONE
FUNCTION 2	FREEZE COPY
ABOUT	SHOW
ASCAN FILL	OFF

You can use the function **ASCAN FILL** to turn on the filled echo display mode. Due to the higher contrast, the filled echo display mode can improve the detectability of echoes, especially during faster scanning of test objects.

- Switch to the second operating level.
- Select the function group **CONFIG2**.
- Select the function **ASCAN FILL** and press a function key to choose the filled A-scan display mode.

Filled A-scan:

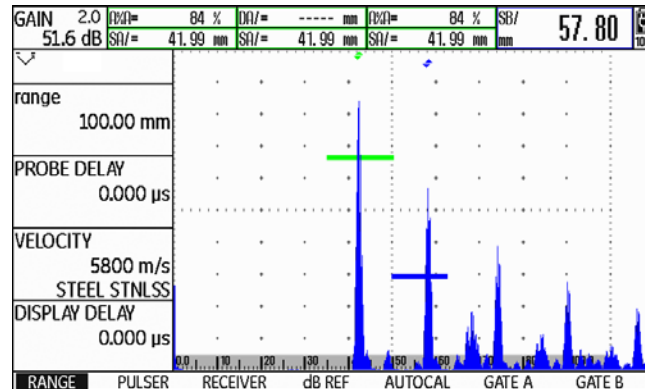

Working with Echo Max

CODE
SERIAL NUMBER USMGO09100154
CODE
000000
CONFIRM
ECHO MAX OFF

The USM Go usually produces more A-scans per second (= PRF) than the display screen of the instrument is able to show (= 60 A-scans per second). In this connection, the displayed A-scans are chosen at random from the raw data.

With the function Echo Max turned on and with PRF > 60 Hz, the USM Go analyzes the raw data and shows the maximum amplitudes at every one of the 800 single points.

- Switch to the second operating level.
- Select the function group **CONFIG1**.
- Select the function **ECHO MAX** and press a function key to turn on the function.

Example

With a PRF of 1200 Hz and the function **ECHO MAX** turned on, $1200/60 = 20$ A-scans are analyzed as raw data.

The highest amplitude at each one of the 800 single points is displayed as a combined A-scan.



Note

With a PRF = 60 Hz and lower, no echo maximizing takes place any longer.

5.17 General setup

The functions for the basic setup of the instrument are described in Chapter 4.5 **Important default settings**:

- Language (see page 4-13)
- Units (see page 4-14)
- Date format, date, time (see page 4-15)
- Instrument orientation (see page 4-16)

Additional settings for the setup of the USM Go are described below.

EVAL MODE

This is where you can choose a method for evaluating the measured reflector echoes.

Depending on the options activated, you can choose from different methods:

- **dB REF** (default setting, see page 5-38)
 - **DAC/TCG** (see page 5-91)
 - **DGS** (see page 5-119)
 - **AWS D1.1** (see page 5-41)
 - **JISDAC** (see page 5-102)
 - **CNDAC** (see page 5-109)
-
- Switch to the second operating level.
 - Select the function group **EVAL**.
 - Select the function **EVAL MODE** and press a function key to choose the required evaluation method.

Gate logic

GATEMODE	
GATE A LOGIC	NEGATIVE
GATE B LOGIC	POSITIVE
B START MODE	IP
OUTPUT SELECT	A (-)

You can use the functions **GATE A LOGIC** and **GATE B LOGIC** to set the criteria for triggering a gate alarm.



Note

For the configuration of the alarm output, see Section **Configuring the alarm output**, page 5-77.

The following settings are available:

- **OFF**
The gate is turned off, alarms and measurement functions are disabled, and the gate is not visible on the display screen.
 - **POSITIVE**
The alarm is triggered if the gate is exceeded.
 - **NEGATIVE**
The alarm is triggered if the gate is not reached.
- Switch to the second operating level.
 - Select the function group **CONFIG2**.
 - Select the function **GATE A LOGIC** and press a function key to choose the setting for the gate A.
 - Switch to the function **GATE B LOGIC** and choose the required setting there in the same way.

Selecting the pulser type

PULSER
PULSER TYPE SQUARE
PRF MODE AUTO LOW 400 Hz
PHANTOM PRF ON

The USM Go is equipped with an optional square-wave pulser. If this option is available, you can choose between a spike and a square pulser type.

- Switch to the second operating level.
- Select the function group **CONFIG2**.
- Select the function **PULSER TYPE** and press a function key to choose the pulser type.



Note

If you have chosen the square-wave pulser, the default function **ENERGY** on the first operating level changes into the function **WIDTH** (see Chapter 5.5 **Setting the pulser (function group PULSER)**, page 5-14).

Locking the joystick

STARTUP
DATE 09. 01. 2013
TIME 11: 34
ORIENTATION RIGHT HANDED
JOY CONTROL ON

You can lock the joystick and, in this way, prevent accidental changes to settings due to touching the joystick.

- Switch to the second operating level.
- Select the function group **CONFIG1**.
- Select the function **JOY CONTROL** and press a function key to lock the joystick by setting the function to **OFF**.



Note

Even if the joystick is locked, functions can still be operated by pressing the joystick (e.g. toggling between the operating levels). Only the joystick movement does not function.

Configuring the alarm output

GATEMODE	
GATE A LOGIC	NEGATIVE
GATE B LOGIC	POSITIVE
B START MODE	IP
OUTPUT SELECT	A (-)

You can configure the alarm output of the service interface (see Chapter 8.1 **Interfaces**, page 8-2). This enables you to define the criteria for the gate alarm output.

The settings for **VIRTUAL LED** and **OUTPUT SELECT** are logically dependent in the operation of the gates A and B, however, the gate polarity can be set independently:

- for the **VIRTUAL LED** by means of **GATE A LOGIC** and **GATE B LOGIC** and
- for **OUTPUT SELECT A** and **OUTPUT SELECT B** by means of **(+)** and **(-)**.

The optional gate C is excluded in this connection.

The following settings are available:

- **A (+)**

The alarm is triggered if the gate A is exceeded.

- **B (+)**

The alarm is triggered if the gate B is exceeded.

- **A / B (+)**

The alarm is triggered if one of the gates A or B is exceeded.

- **A (-)**

The alarm is triggered if the gate A is not reached.

- **B (-)**

The alarm is triggered if the gate B is not reached.

- **A / B (-)**

The alarm is triggered if the two gates A and B are not reached.

- Switch to the second operating level.
- Select the function group **CONFIG2**.
- Select the function **OUTPUT SELECT**.
- Press a function key to choose the required setting.

Power saving mode

FREEZE
FREEZE MODE STANDARD
ENVELOPE OFF
ENVELOPE COLOR BLUE
POWER SAVER OFF

You can use the function **POWER SAVER** to increase the operating time of the battery by setting a time after which the display screen is automatically turned off if the instrument is not used during this time.

The display screen is automatically turned on again as soon as you use a control element.

You can define the turn-off time within the range of 1 ... 30 minutes.

- Switch to the second operating level.
- Select the function group **CONFIG3**.
- Select the function **POWER SAVER** and press the function keys to select the required setting.

TOF in LAYER

TOF in LAYER
TOF in LAYER OFF
LAYER TYPE STANDARD
LAYER EDIT EDIT

As an alternative to the display of an exact value (time-of-flight or distance), the USM Go can only display the layer in which a reflector is located.

You can specify layers of varying depth (but with identical material velocity) for this purpose. They are automatically numbered consecutively. With the function **TOF in LAYER** turned on, only the number of the layer is displayed in which the flaw (e.g. inclusion or separation) is located.

Defining layers

You can define either the thickness of a single layer or the thicknesses of 10 layers within a range of 1.00 ... 10.0 mm each.

- Switch to the second operating level.
- Select the function group **CONFIG3**.
- Select the function **TOF in LAYER** and press a function key to turn on the function.
- Switch to the function **LAYER TYPE** and press the function keys to choose the mode for a single layer (**STANDARD**) or for 10 layers (**CUSTOM**).
- Switch to the function **LAYER EDIT** and briefly press the joystick (USM Go) or the center key of the keypad (USM Go+) to set one or several layer thicknesses. The list of layers with the corresponding thicknesses in each case is displayed.
- Use the navigation or the function keys to set the required values.

- Press the joystick (USM Go) or the center key of the keypad (USM Go+) briefly to close the setting.

This completes the definition of the layer thicknesses.

If the function **TOF in LAYER** is turned on, only the number of the layer is displayed instead of the numerical reading for **SA**, **SB**, and **SC** in the measurement line on top of the A-scan, e.g. **7 LA**
(= Layer 7).

Backwall echo attenuation (BEA)

BEA	
BEA	OFF
BW GAIN	9.5dB

You can use the function **BEA** (**B**ackwall **E**cho **A**ttenuation) to set a separate gain for the range of gate B. This gain is independent of the gain for the rest of the test range.

The backwall echo attenuation therefore enables a selective attenuation or peaking of the echoes in the gate B.

A typical application case for this is the testing of forgings. In this application case, the gain is reduced in gate B until the backwall echo is completely displayed in

the A-scan. The backwall echo can then be selectively integrated into the flaw evaluation.

However, the backwall echo attenuation also allows to systematically increase the gain. In this way, you can, for example, only increase the gain within the flaw expectancy range in order to peak the echo in this range.

- Switch to the second operating level.
- Select the function group **CONFIG3**.
- Select the function **BEA** and press a function key to turn on the backwall echo attenuation.
- Switch to the function **BW GAIN**.
- Press the function keys to select the required gain value.

Displaying the envelope curve (ENVELOPE)

FREEZE	
FREEZE MODE	
STANDARD	
ENVELOPE	OFF
ENVELOPE COLOR	BLUE
POWER SAVER	OFF

In addition to the live A-scan, a frozen A-scan is displayed as an envelope curve in the background. The frozen A-scan is updated every time the maximum amplitudes are exceeded.

You can select the color of the envelope curve.

- Switch to the second operating level.
- Select the function group **CONFIG3**.
- Select the function **ENVELOPE** and press a function key to turn on the envelope curve.
- Switch to the function **ENVELOPE COLOR**.
- Press the function keys to choose the required setting.

A-scan with envelope curve:

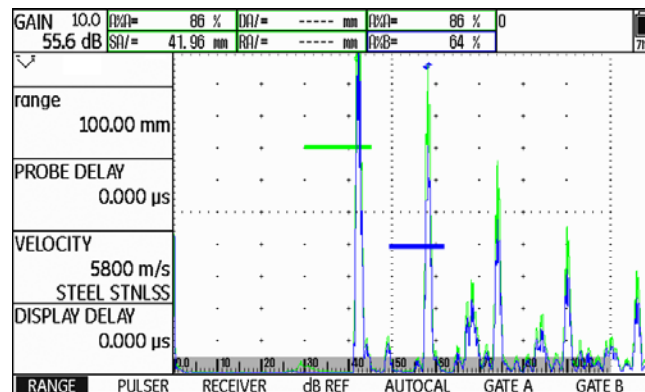

Automatic gain control (Auto Gain Control)

Auto Gain Ctrl	
CTRL MODE	OFF
MAX AMP.%	60
MIN AMP.%	50
NOISE LEVEL.%	20

You can use the functions of the column **Auto Gain Ctrl** to turn on and to configure the automatic gain control of the USM Go.

Even smaller variations of the echo amplitude can lead to incorrect measurement results in wall thickness measurements. In these cases, the exact monitoring of the amplitude is therefore highly important. The automatic gain control of the USM Go offers practical help for this purpose.

The automatic gain control of the USM Go keeps the echo amplitude fully automatically at a specified screen height and, in this way, compensates for the amplitude variations of the signal received. This enables to clearly improve especially the wall thickness measurement and to make it easier.

To configure the automatic gain control, enter the minimum and the maximum height of amplitude in percent screen height that the echo signal should reach within the gate.

In addition, you can define a threshold for the noise. Signals below this threshold are not taken into account for the automatic gain control.



Note

The smaller the ratio between the values **MIN AMP.%** and **MAX AMP.%**, the more sensitive the control process.

- Switch to the second operating level.
- Select the function group **CONFIG4**.
- Select the function **CTRL MODE** and press a function key to turn on the automatic gain control.
- Switch to the function **MAX AMP.%** and press the function keys to set the required value.
- Switch to the function **MIN AMP.%** and press the function keys to set the required value.
- Switch to the function **NOISE LEVEL.%** and press the function keys to set the required value.

**Note**

The automatic gain control is helpful, e.g. in the calibration using **AUTOCAL** (setting **MAX AMP.% = 81**, **MIN AMP.% = 79**), to keep the reference amplitude of 80 % screen height constant at ± 1 %.

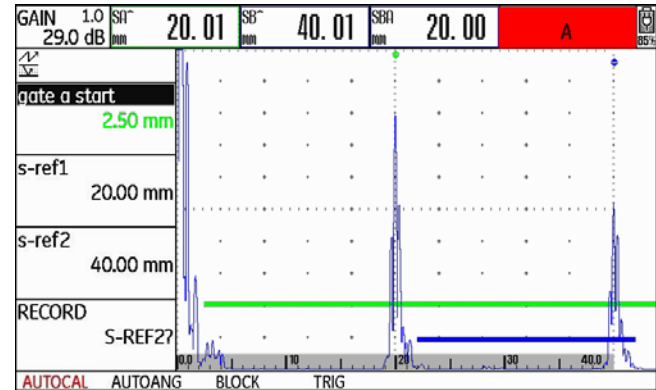

Calibration reminder

SETUP 2	YEARLY CAL
CAL REMINDER OFF	DATE 01. 01
CAL RESET	CAL REMINDER OFF
USER GAIN STEP 10.0dB	CAL RESET
dB STEP 0.6	

Certain test specifications require a recalibration of the entire system (instrument, cable, probe, material) at regular time intervals.

If you turn the reminder function of the USM Go on, a reminder icon is displayed next to the A-scan as soon as the scheduled point of time is reached (see Section **Status display icons**, page 0-7, at the beginning of this operating manual).

You can turn on a short-term calibration reminder for a time period within the range of 0.5 ... 4 hours and a reminder for the yearly calibration.

In the case of the yearly reminder, define the date at which the calibration should be carried out. You can decide how long before this date the reminder icon should be displayed.

Short-term calibration reminder

- Switch to the second operating level.
- Select the function group **CONFIG2**.
- Select the function **CAL REMINDER** and press the function keys to select the required period of time.
- Switch to the function **CAL RESET** and press a function key to acknowledge the reminder and to reset the starting point for the defined period of time to zero.

Yearly calibration reminder

- Switch to the second operating level.
- Select the function group **CONFIG3**.
- Switch to the function **DATE** and briefly press the joystick (USM Go) or the center key of the keypad (USM Go+).
- Use the navigation to select the date of the yearly calibration.
- Press the joystick (USM Go) or the center key of the keypad (USM Go+) briefly to close the date entry.
- Switch to the function **CAL REMINDER** and press the function keys to select the required setup time for the reminder.
- Switch to the function **CAL RESET** and briefly press the joystick (USM Go) or the center key of the keypad (USM Go+) to acknowledge the reminder.
- To confirm, press the two function keys at the same time. The reminder will then become effective only after the next calibration date.

Password protection

PARAM MODE
PARAM MODE EXPERT
PARAM EDIT ENTER
PASSWORD ENTER

The USM Go can administer two users:

- Inspector
- Expert

A user logged in as Expert can disable individual functions so that the inspector has no access to them. This makes it possible to work with the instrument and, at the same time, to protect the instrument settings from any unwanted changes. All functions are always available to an expert.

To activate this function, you have to set a password. After saving the password, it is only possible to switch to the mode Expert after entering the password.

Saving a new password



ATTENTION

After saving the password, it is only possible to have full access to the instrument functions after entering the password. If the password is lost, you have to reset the instrument (see Section **Factory default setting (Reset)**, page 3-12).

You can save a password only if there is no password protection yet or if you are logged in as Expert.

- Switch to the second operating level.
- Select the function group **CONFIG4**.
- Select the function **PASSWORD** and briefly press the joystick (USM Go) or the center key of the keypad (USM Go+).

- Use the navigation to enter the first character of the password.
- Enter other characters in the same way. You can enter a maximum of 12 characters.
- Press the joystick (USM Go) or the center key of the keypad (USM Go+) briefly to close the password entry.
- Enter the password again and briefly press the joystick (USM Go) or the center key of the keypad (USM Go+). The new password is saved.

Changing a password

You can change the password at any time. To do this, you must first enter the current password.

- Switch to the second operating level.
- Select the function group **CONFIG4**.
- Select the function **PASSWORD** and briefly press the joystick (USM Go) or the center key of the keypad (USM Go+).

- Use the navigation to enter the current password.
- Press the joystick (USM Go) or the center key of the keypad (USM Go+) briefly to close the entry of the current password.
- Use the navigation to enter a new password.
- Press the joystick (USM Go) or the center key of the keypad (USM Go+) briefly to close the entry of the new password.
- Enter the password again and briefly press the joystick (USM Go) or the center key of the keypad (USM Go+). The new password is saved.

**Note**

If you only enter an empty character as password, the password protection is canceled and all functions are freely accessible again.

Protecting settings

After saving a password, you can protect the individual functions of the USM Go. The access to these functions is then only possible as Expert after entering the password.

- Switch to the second operating level.
- Select the function group **CONFIG4**.
- Select the function **PARAM EDIT** and briefly press the joystick (USM Go) or the center key of the keypad (USM Go+).
- Use the navigation to enter the password and press the joystick (USM Go) or the center key of the keypad (USM Go+) briefly to close the password entry. The list of functions is displayed.
- Use the navigation to scroll through the list of functions and use the navigation to set the functions that you want to protect to **OFF**.
- Press the joystick (USM Go) or the center key of the keypad (USM Go+) briefly to close the editing process of the list of functions. The settings are saved.

- Switch to the function **PARAM MODE** and briefly press the joystick (USM Go) or the center key of the keypad (USM Go+).
- Use the navigation to change the user from **EXPERT** to **INSPECTOR** in order to activate the password protection.
- Switch to the first operating level.
- Try to use a protected function.

It should then not be possible to use protected functions. In these cases, the message

NOT AVAILABLE FOR OPERATOR.

is displayed at the bottom of the display screen.

To be able to use the protected functions, you have to be logged in as Expert.

Login as Expert

- Switch to the second operating level.
- Select the function group **CONFIG4**.
- Select the function **PARAM MODE** and briefly press the joystick (USM Go) or the center key of the keypad (USM Go+).
- Use the navigation to change the user from **INSPECTOR** to **EXPERT**. The text box for the entry of the password is displayed.
- Use the navigation to enter the password and press the joystick (USM Go) or the center key of the keypad (USM Go+) briefly to close the password entry. If the correct password is entered, **EXPERT** is now displayed.
- Press the joystick (USM Go) or the center key of the keypad (USM Go+) briefly to exit the function.

You are now logged in as Expert and have access to all functions.

5.18 Distance-amplitude correction (DAC)

The USM Go has an optional DAC function for the echo evaluation by means of the distance-amplitude correction (DAC).

Due to the angle of beam spread and the sound attenuation in the material, the echo height of equally sized reflectors depends on the distance to the probe.

A distance-amplitude correction curve, recorded using defined reference reflectors, is a graphical representation of these influencing factors.

If you use a reference block having artificial flaws to record a DAC curve, you can use this echo amplitude for the evaluation of a flaw without any further corrections. The reference block should be made of the same material as the test object.

The time-corrected gain TCG increases the gain in distance sensitive mode so that all reference echoes reach 80 % screen height. The amplitude evaluation of echo indications is made in relation to the first reference echo.

EVALMODE
EVAL MODE
dB REF
COLOR LEG
OFF
MAGNIFY GATE
GATE A
AGT
OFF

gate a start
12.50 mm
AUTO80
RECORD
0 POINTS
FINISH
(NO CURVE)

- Switch to the second operating level.
- Select the function group **EVAL**.
- Select the function **EVAL MODE** and press a function key to choose **DAC/TCG**.
- Switch back to the first operating level. The function group **DAC/TCG** is now displayed there.

If a stored DAC curve exists, it becomes effective now.

Recording a DAC curve



ATTENTION

Before starting to record a reference curve, the instrument has to be correctly calibrated (see Chapter 5.8 **Calibrating the USM Go**, page 5-29).

As soon as a new curve is recorded, a possibly already existing curve must be deleted. If necessary, make sure that the old curve has been saved to a free dataset before starting to record a new curve.



Note

You can configure the measurement line accordingly to display the specific readings (see Section **Configuring the measurement line**, page 5-59).

- Select the function group **DAC/TCG**.
- Use the navigation to move **upwards** in order to display the specific function groups and functions for the DAC/TCG.

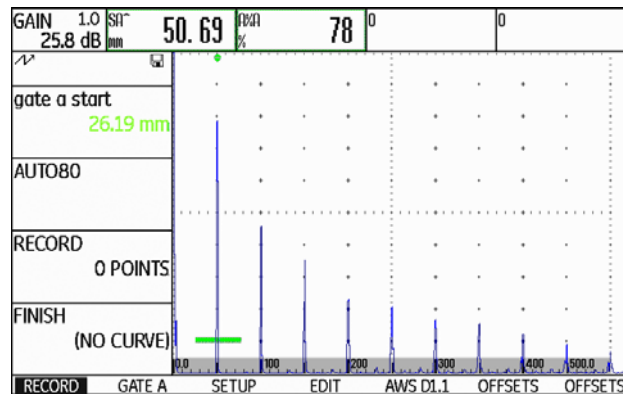

- Select the function **gate a start** and position the gate A on the first DAC echo.

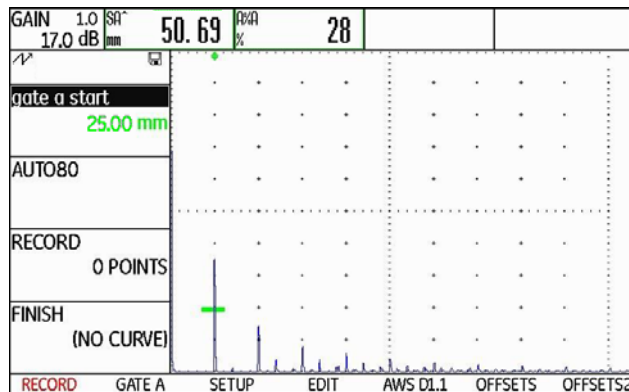

- Select the function **AUTO80** and press a function key to automatically set the echo to 80 % screen height.
- Select the function **RECORD** and press a function key to store the first DAC curve point. The indication **(1 POINT)** confirms the recording. After this, the function **gate a start** is automatically selected.

- Position the gate A on the second DAC echo.
- Select the function **AUTO80** and press a function key to automatically set the echo to 80 % screen height.
- Select the function **RECORD** and press a function key to store the second DAC curve point. The indication **(2 POINTS)** confirms the recording. After this, the function **gate a start** is automatically selected again.

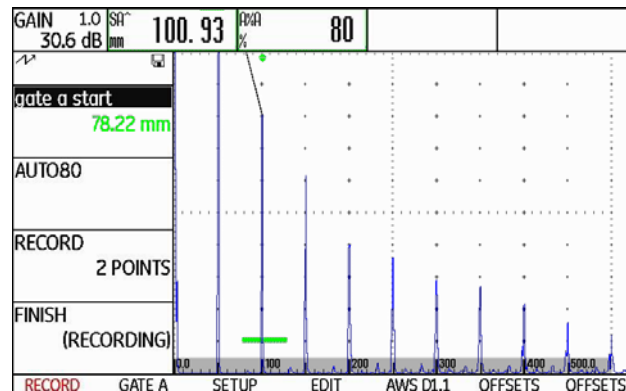

- Record further DAC curve points in the same way.

- Finally, select the function **FINISH** and press a function key to finish the recording of the DAC echoes. The finishing is confirmed by the indication **(STORED)**.

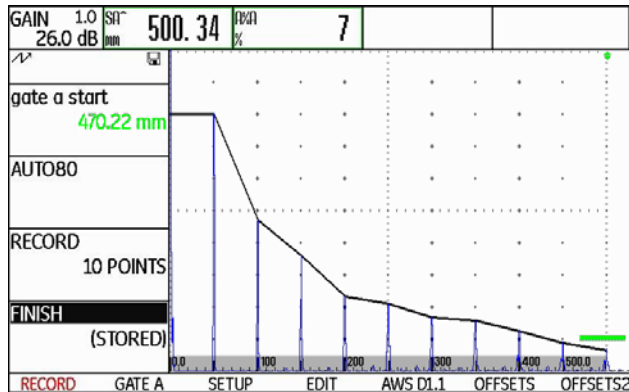

Setting up the DAC

- Select the function group **SETUP**. The function **TCG/DAC MODE** is automatically set to **DAC**.

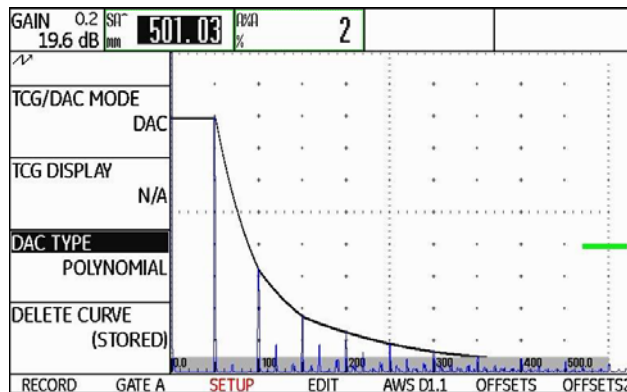

- Select the function **DAC-TYPE** and press the function keys to choose the required curve display type (**STRAIGHT**, **CURVED**, or **POLYNOMIAL**).
- Select the function group **GATE A** and position the gate in the expectancy range of the echoes.
- Adjust the gain.

- Select the function **TCG/DAC MODE** and press a function key to switch to **TCG** (time-corrected gain) mode. The horizontal line of the time-corrected gain is displayed in the A-scan and all echoes are displayed at 80 % screen height.

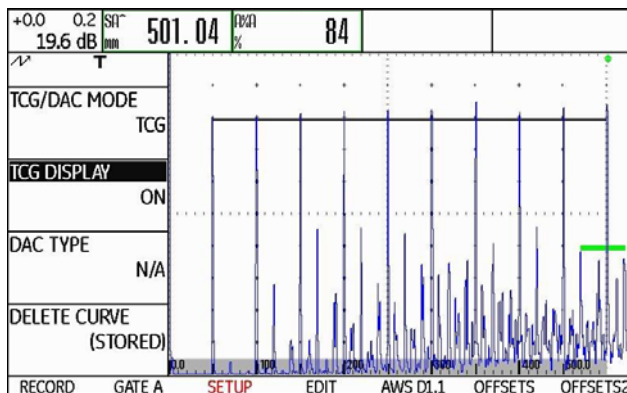

Turning the DAC evaluation off

You can turn the DAC evaluation off any time.

- Switch to the first operating level.
- Select the function group **DAC/TCG**.
- Use the navigation to move **upwards** in order to display the specific function groups and functions for the DAC/TCG.
- Select the function group **SETUP**.
- Select the function **TCG/DAC MODE** and press a function key to turn the DAC evaluation off (**OFF**). The DAC curve is no longer displayed in the A-scan.



Note

The DAC curve is not lost by turning the function off. By turning it on again, you can use the function **TCG/DAC MODE** to go back to the DAC evaluation again without losing any settings.

Deleting the DAC curve

You can delete the DAC curve at any time. After this, the DAC evaluation is not possible until you have recorded a new DAC curve.

- Switch to the first operating level.
- Select the function group **DAC/TCG**.
- Use the navigation to move **upwards** in order to display the specific function groups and functions for the DAC/TCG.
- Select the function group **SETUP**.
- Select the function **DELETE CURVE** and press a function key. A message prompting you to confirm is displayed.
- Press the two function keys at the same time to confirm the deletion of the reference echo. The deletion is acknowledged by the indication **(NO CURVE)**.

Editing DAC points

You can edit individual DAC points at any time.

- Select the function group **EDIT**.
- Select the function **POINT** and press a function key to choose the number of a DAC point for editing.
- Select the function **POINT GAIN** and press the function keys to change the gain value of the point.

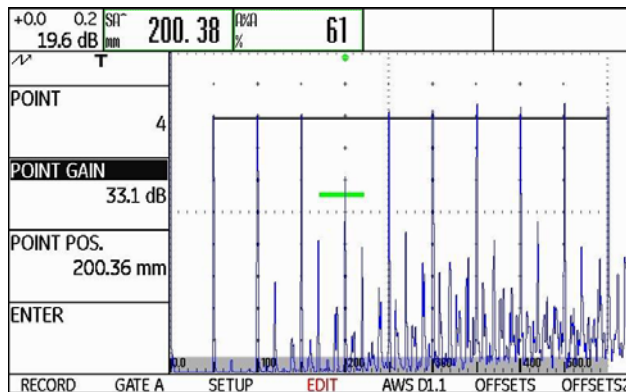

- Select the function **POINT POS.** and press the function keys to change the distance of the point.

Adding DAC points

You can add individual DAC points at any time.

- Select the function group **EDIT**. The function **POINT** is automatically set to **NEW** in order to define a new DAC point.
- Select the function **POINT GAIN** and press the function keys to change the gain value of the new point.
- Select the function **POINT POS.** and press the function keys to change the distance of the point.
- Finally, select the function **ENTER** to store the new DAC point. The changed DAC is now displayed in the A-scan.

Multiple DAC curves

MODE	FIXED
OFFSET	0.5 dB
TRANSFER CORR.	0.0 dB

OFFSET 1	-1.0 dB
OFFSET 2	-0.5 dB
OFFSET 3	+0.5 dB
OFFSET 4	+1.0 dB

You can activate multiple DAC curves and, at the same time, define the offsets between the multiple curves and the recording curve.

The offset 0.0 dB only represents the recording curve. Every setting varying from 0 produces four other curves with the corresponding dB offset between them.

For better distinction, the recording curve is shown in bold with multiple DAC curves.

You can use fixed offsets for all curves. In this case, the adjustment range is 0 ... 12 dB in steps of 0.5 dB.

As an alternative you can set the offset for each curve individually and turn off single curves of the multiple curves. In this case, the adjustment range is -24 ... +24 dB in steps of 0.1 dB.

- Select the function group **OFFSETS**.
- Select the function **OFFSET** and press the function keys to set multiple curves with a fixed offset.

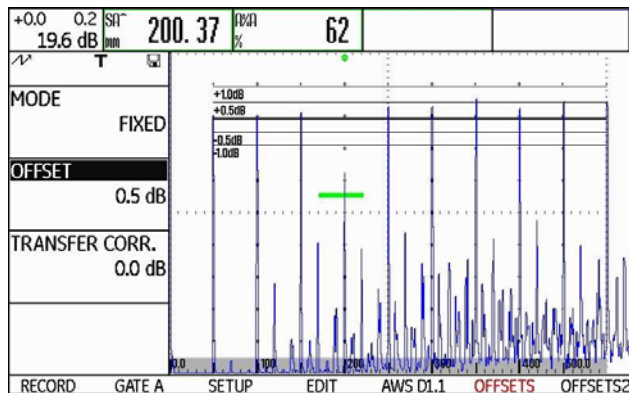

- Select the function **MODE** and press a function key to turn on the individual curve definition by means of **CUSTOM**. The function **OFFSET** is disabled.
- Switch to the function group **OFFSET2**.
- Select the function **OFFSET 1** and press the function keys to individually set the first curve.
- Set the other curve offsets in the same way.

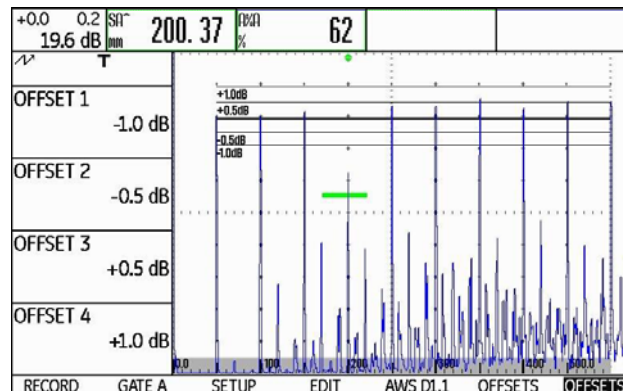

AWS D1.1 in DAC/TCG

A INDICATION	*****
(RUNNING)	
B REFERENCE	*****
C ATTENUATION	*****
D D1.1 RATING	*****

The function group AWS D1.1 is available as an add-on to DAC/TCG for angle-beam probes.

You can use the 1st reference echo to set the reference gain by means of the function **B REFERENCE**.

For detailed information on AWS D1.1, see Chapter 5.11 **Rating of welds (function group AWS D1.1)**, page 5-41.

Sensitivity correction

You can use the function **TRANSFER CORR.** to compensate for transfer losses in the material to be tested. A correction is necessary if the test object and the reference standard have different surface qualities.

You have to determine the adjustment value for the compensation of transfer losses by way of experiment. In this connection, the gain is varied accordingly but the curve shape remains the same.

- Select the function group **OFFSETS**.
- Select the function **TRANSFER CORR.** and press the function keys to adjust the required value.

Echo evaluation using DAC/TCG

To be able to evaluate a flaw echo by means of the DAC/TCG, certain conditions must be met:

- The distance-amplitude correction curve has to be recorded beforehand.
- It only applies to the same probe that was used for recording the curve. It is not allowed to use even another probe of the same type!
- The curve only applies to the material corresponding to the material of the reference block.
- All functions affecting the echo amplitude must be set in the same way as they existed during the recording of the curve. This applies especially to the parameters voltage, frequency, rectification, material velocity, and reject.

Change in the probe delay with DAC/TCG

Generally, a change in the probe delay automatically also affects the shape of the sound field. This means that a new recording of the reference echo would be theoretically required. However, minor changes in the delay line, typically occurring due to the wear of the delay line, have no noticeable effect on the programmed distance laws.



ATTENTION

A recorded DAC curve no longer applies if the probe delay changes to a larger extent, e.g. caused by adding or removing a delay line after a DAC curve has been recorded.

The same applies to immersion testing: The DAC curve must be recorded after setting up the final water delay line.

Failure to do so may lead to evaluation errors.

Automatic variation of the measuring point in TOF mode

An echo amplitude evaluation is normally carried out at the echo peak of the signal under examination because this is the only way of ensuring that the displayed echo amplitude and the sound path (projection distance, depth position) always belong to the highest echo in the gate.



Note

The USM Go checks the measuring point setting in TOF mode before processing any reference amplitudes. If **PEAK** is not set as measuring point, the instrument will automatically switch to **PEAK**. In this case, a note is displayed at the bottom edge of the display screen.

5.19 Distance-amplitude curve according to JIS Z3060-2002 (JISDAC)

The USM Go has an optional DAC function for the echo evaluation by means of the distance-amplitude correction (DAC) and an additional class rating according to JIS Z3060-2002.

With the function JISDAC, you can activate a distance-amplitude curve according to JIS including three evaluation lines marked with the letters L (low), M (medium), and H (high). They are permanently connected to the DAC and shifted accordingly if the gain is varied.

In addition, a class rating takes place. Flaw echoes are evaluated according to their amplitude with reference to their position within the set of curves:

- Class I: Amplitude < Line L
- Class II: Line L < Amplitude < Line M
- Class III: Line M < Amplitude < Line H
- Class IV: Amplitude < Line H

Activating JISDAC (DAC according to JIS)

EVALMODE	
EVAL MODE	
	dB REF
COLOR LEG	
	OFF
MAGNIFY GATE	
	GATE A
AGT	
	OFF

gate a start
12.50 mm
AUTO80
RECORD
0 POINTS
FINISH
(NO CURVE)

- Switch to the second operating level.
- Select the function group **EVAL**.
- Select the function **EVAL MODE** and press a function key to choose **JISDAC**.
- Switch back to the first operating level. The function group **JISDAC** is now displayed there.

If a stored DAC curve exists, it becomes effective now.

Recording a DAC curve



ATTENTION

Before starting to record a reference curve, the instrument has to be correctly calibrated (see Chapter 5.8 **Calibrating the USM Go**, page 5-29).

As soon as a new curve is recorded, a possibly already existing curve must be deleted. If necessary, make sure that the old curve has been saved to a free dataset before starting to record a new curve.

- Select the function group **JISDAC**.
- Use the navigation to move **upwards** in order to display the specific function groups and functions for the JISDAC.

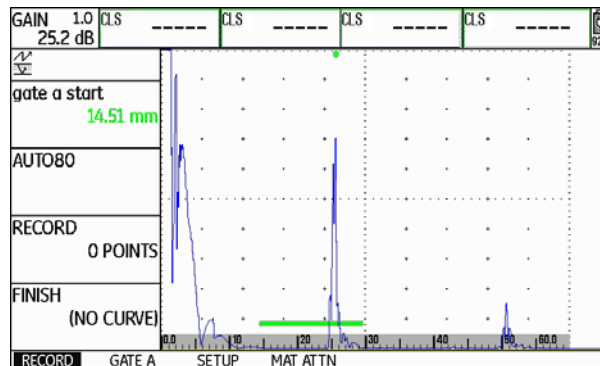

5 Operation

Distance-amplitude curve according to JIS Z3060-2002 (JISDAC)

- Select the function **gate a start** and position the gate A on the first DAC echo.

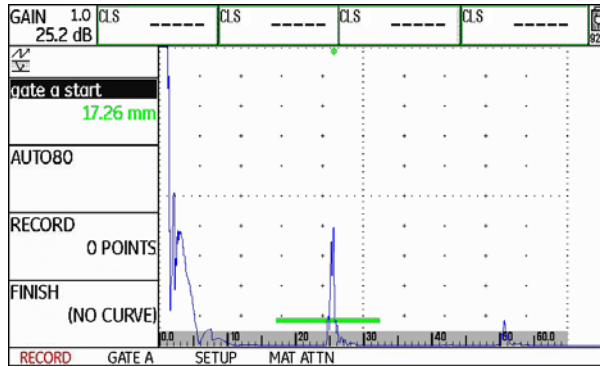

- Select the function **AUTO80** and press a function key to automatically set the echo to 80 % screen height.
- Select the function **RECORD** and press a function key to store the first DAC point. The indication **(1 POINT)** confirms the recording. After this, the function **gate a start** is automatically selected.

- Position the gate A on the second DAC echo.
- Select the function **AUTO80** and press a function key to automatically set the echo to 80 % screen height.
- Select the function **RECORD** and press a function key to store the second DAC point. The indication **(2 POINTS)** confirms the recording. After this, the function **gate a start** is automatically selected again.

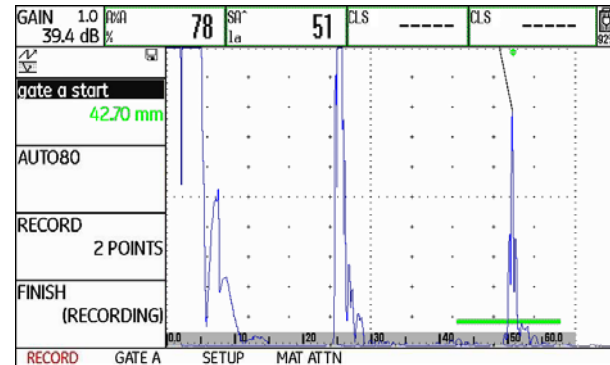

- Record further DAC points in the same way.

- Finally, select the function **FINISH** and press a function key to finish the recording of the DAC echoes. The finishing is confirmed by the indication **(STORED)**.

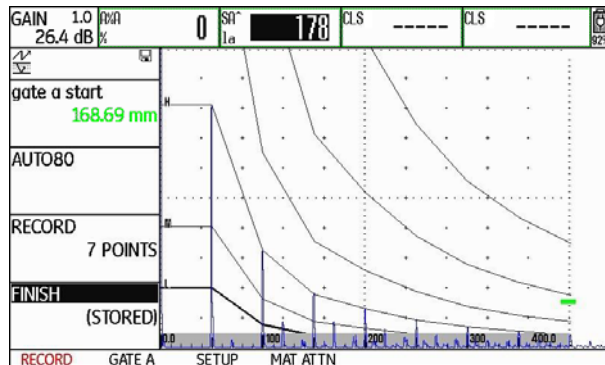

Setting up JISDAC

- Select the function group **SETUP**. The function **JISDAC** is automatically set to **ON**.

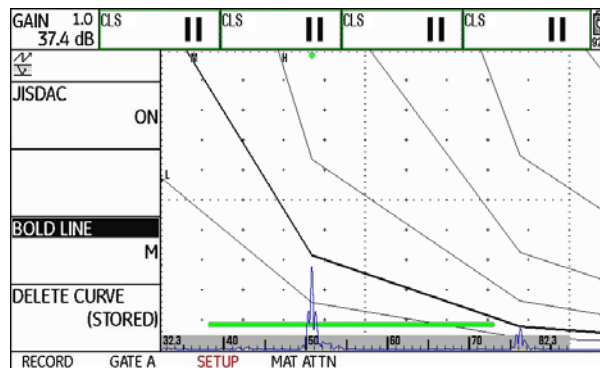

- Select the function **BOLD LINE** and press the function keys to choose the required evaluation line.
- Select the function group **GATE A** and position the gate in the expectancy range of the echoes.
- Adjust the gain.

Sensitivity correction

You can use the function **TRANSFER CORR.** to compensate for transfer losses in the material to be tested. A correction is necessary if the test object and the reference standard have different surface qualities.

You have to determine the adjustment value for the compensation of transfer losses by way of experiment. In this connection, the gain is varied accordingly but the curve shape remains the same.

- Select the function group **MAT ATTN.**
- Select the function **TRANSFER CORR.** and press the function keys to adjust the required value.

Turning the JISDAC evaluation off

You can turn the JISDAC evaluation off at any time.

- Switch to the first operating level.
- Select the function group **JISDAC.**
- Use the navigation to move **upwards** in order to display the specific function groups and functions for the JISDAC.
- Select the function group **SETUP.**
- Select the function **JISDAC** and press a function key to turn the JISDAC evaluation off (**OFF**). The DAC curve and the evaluation lines are no longer displayed in the A-scan.



Note

The DAC curve is not lost by turning the function off. By turning it on again, you can use the function **JISDAC** to go back to the JISDAC evaluation again without losing any settings.

Deleting the DAC curve

You can delete the DAC curve at any time. After this, the JISDAC evaluation is not possible until you have recorded a new DAC curve.

- Switch to the first operating level.
- Select the function group **JISDAC**.
- Use the navigation to move **upwards** in order to display the specific function groups and functions for the JISDAC.
- Select the function group **SETUP**.
- Select the function **DELETE CURVE** and press a function key. A message prompting you to confirm is displayed.
- Press the two function keys at the same time to confirm the deletion of the reference echo. The deletion is acknowledged by the indication (**NO CURVE**).

Echo evaluation using DAC

To be able to evaluate a flaw echo by means of the DAC, certain conditions must be met:

- The distance-amplitude correction curve has to be recorded beforehand.
- It only applies to the same probe that was used for recording the curve. It is not allowed to use even another probe of the same type!
- The curve only applies to the material corresponding to the material of the reference block.
- All functions affecting the echo amplitude must be set in the same way as they existed during the recording of the curve. This applies especially to the parameters voltage, frequency, rectification, material velocity, and reject.

Change in the probe delay

Generally, a change in the probe delay automatically also affects the shape of the sound field. This means that a new recording of the reference echo would be theoretically required. However, minor changes in the delay line, typically occurring due to the wear of the delay line, have no noticeable effect on the programmed distance laws.



ATTENTION

A recorded DAC curve no longer applies if the probe delay changes to a larger extent, e.g. caused by adding or removing a delay line after a DAC curve has been recorded.

The same applies to immersion testing: The DAC curve must be recorded after setting up the final water delay line.

Failure to do so may lead to evaluation errors.

Automatic variation of the measuring point in TOF mode

An echo amplitude evaluation is normally carried out at the echo peak of the signal under examination because this is the only way of ensuring that the displayed echo amplitude and the sound path (projection distance, depth position) always belong to the highest echo in the gate.



Note

The USM Go checks the measuring point setting in TOF mode before processing any reference amplitudes. If **PEAK** is not set as measuring point, the instrument will automatically switch to **PEAK**. In this case, a note is displayed at the bottom edge of the display screen.

5.20 Distance-amplitude curve according to JB/T4730 and GB 11345 (CNDAC)

CNDAC (China Distance Amplitude Correction) is an evaluation method for ultrasonic weld testing, based on the standards JB/T4730 and GB 11345 of the People's Republic of China.

In CNDAC, reference lines are defined for:

- the rejection (Reject Line RL),
- the amplitude measurement (Sizing Line SL), and
- the evaluation (Evaluation Line EL).

Defined as references are side-drilled holes having certain diameters.

The option **CUSTOM** in the function **CODE NAME** enables you to specify a reference block of your own the data of which have to be documented separately.

Evaluations according to CNDAC

After recording the reference echo, the CNDAC shows the reference lines **RL**, **SL**, and **EL** depending on the corresponding choice in the functions **CODE NAME** (standard) and **BLOCK** (reference block).

The reference line **SL** is used for the amplitude measurement. It can be assigned to all gates available (**READING = SLA, SLB**, optionally **SLC**).

Examples:

SLA indicates the difference in amplitude of an echo in the gate A in relation to the reference curve SL at the position of the echo in dB.

dBrA is identical with **SLA**.

A%rA indicates the difference in amplitude of an echo in the gate A in relation to the reference curve SL at the position of the echo in %. In this connection, the reference curve at the position of the echo is assumed at 100 %.

Standards and reference blocks

CODE NAME	BLOCK	Ø side-drilled hole (mm)	Wall thickness test object (mm)	RL (dB)	SL (dB)	EL (dB)
11345A	RB	3	–	DAC	DAC – 10	DAC – 16
11345B	RB	3	–	DAC – 4	DAC – 10	DAC – 16
11345C	RB	3	–	DAC – 2	DAC – 8	DAC – 14
4730	CSK IIA	2	8 ... 46	DAC – 4	DAC – 12	DAC – 18
4730	CSK IIA	2	46 ... 120	DAC + 2	DAC – 8	DAC – 14
4730	CSK IIIA	1	8 ... 15	DAC + 2	DAC – 6	DAC – 12
4730	CSK IIIA	1	15 ... 46	DAC + 5	DAC – 3	DAC – 9
4730	CSK IIIA	1	46 ... 120	DAC + 10	DAC	DAC – 6
4730	CSK IVA	–	–	DAC	DAC – 10	DAC – 16
CUSTOM	CUSTOM	–	–	DAC	DAC	DAC

Activating the CNDAC

EVALMODE	
EVAL MODE	dB REF
COLOR LEG	OFF
MAGNIFY GATE	GATE A
AGT	OFF

gate a start	12.50 mm
AUTO80	
RECORD	0 POINTS
FINISH	(NO CURVE)

- Switch to the second operating level.
- Select the function group **EVAL**.
- Select the function **EVAL MODE** and press a function key to choose **CNDAC**.
- Switch back to the first operating level. The function group **CNDAC** is now displayed there.

If a stored DAC curve exists, it becomes effective now.

Recording a DAC curve



ATTENTION

Before starting to record a reference curve, the instrument has to be correctly calibrated (see Chapter 5.8 **Calibrating the USM Go**, page 5-29).

As soon as a new curve is recorded, a possibly already existing curve must be deleted. If necessary, make sure that the old curve has been saved to a free dataset before starting to record a new curve.

- Select the function group **CNDAC**.
- Use the navigation to move **upwards** in order to display the specific function groups and functions for the CNDAC. The function group **CODE** is selected.

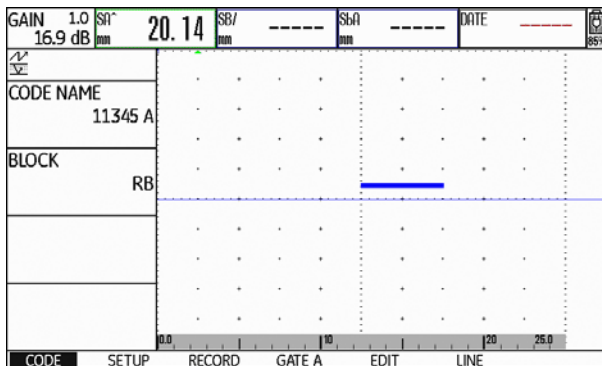

- Select the function **CODE NAME** and press the function keys to select the required standard.
- Switch over to the function **BLOCK** and choose the suitable reference block (see Section **Standards and reference blocks**, page 5-110).

- Select the function **gate a start** and position the gate A on the first DAC echo.

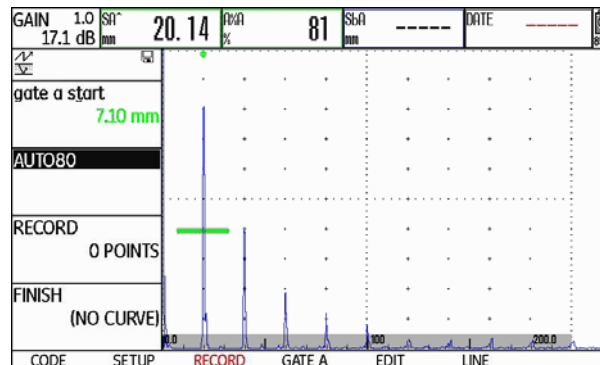

- Select the function **AUTO80** and press a function key to automatically set the echo to 80 % screen height.
- Select the function **RECORD** and press a function key to store the first DAC point. The indication **(1 POINT)** confirms the recording. After this, the function **gate a start** is automatically selected.

- Position the gate A on the second DAC echo.
- Select the function **AUTO80** and press a function key to automatically set the echo to 80 % screen height.
- Select the function **RECORD** and press a function key to store the second DAC point. The indication **(2 POINTS)** confirms the recording. After this, the function **gate a start** is automatically selected again.

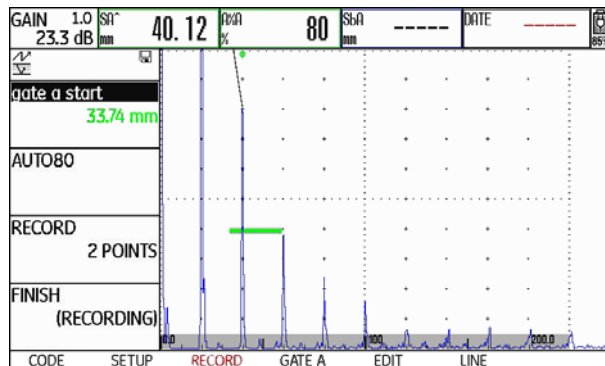

- Record further DAC points in the same way.

- Finally, select the function **FINISH** and press a function key to finish the recording of the DAC echoes. The finishing is confirmed by the indication **(STORED)**.

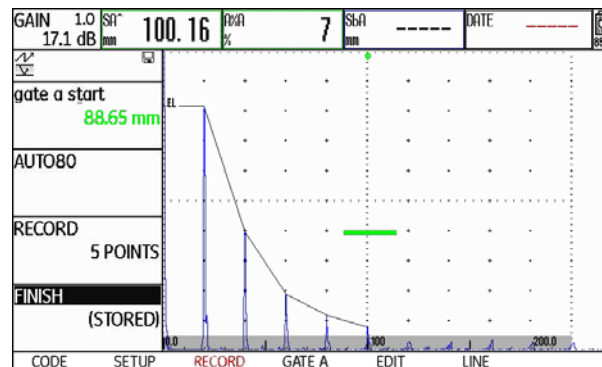

Setting up CNDAC

- Select the function group **SETUP**. The function **CNDAC MODE** is automatically set to **ON**.

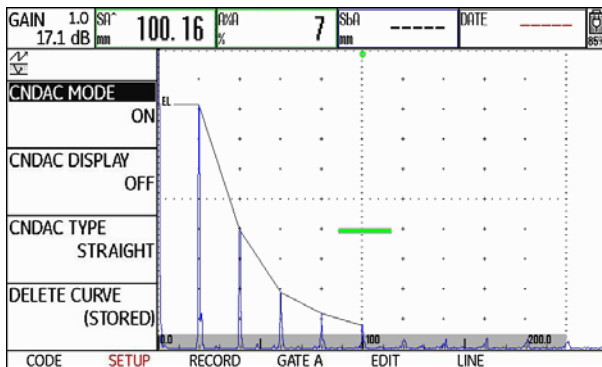

- Select the function **CNDAC DISPLAY** and press a function key to turn the evaluation line on.
- Select the function group **GATE A** and position the gate in the expectancy range of the echoes.
- Adjust the gain.

- Select the function **CNDAC TYPE** and press the function keys to choose the required line display type (**STRAIGHT**, **CURVED**, or **POLYNOMIAL**). Depending on the choice, the values for **SLA**, **A%rA**, **SLB**, and **A%rB** slightly vary.

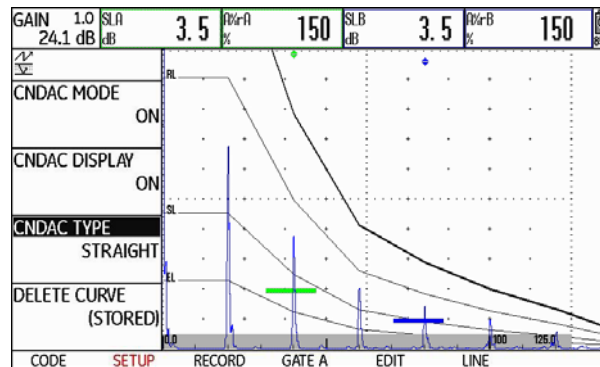

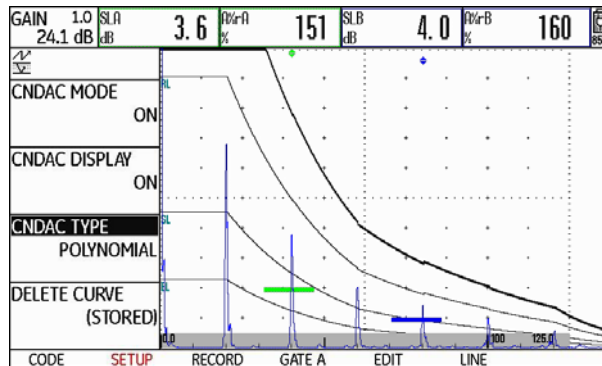
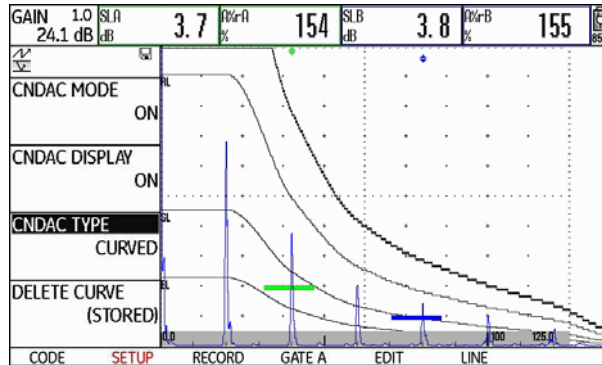

Sensitivity correction

You can use the function **TRANSFER CORR.** to compensate for transfer losses in the material to be tested. A correction is necessary if the test object and the reference standard have different surface qualities.

You have to determine the adjustment value for the compensation of transfer losses by way of experiment. In this connection, the gain is varied accordingly but the curve shape remains the same.

- Select the function group **LINE**.
- Select the function **TRANSFER CORR.** and press the function keys to adjust the required value.

Adjusting reference lines

You can change the reference lines for RL and EL at any time. The dB values always refer to the reference line during recording. These values can also be positive, i.e. positioned above the reference.

- Select the function group **LINE**.
- Select the function **RL** and press a function key to individually change the reference line RL.
- Adjust the reference lines SL and EL in the same way.

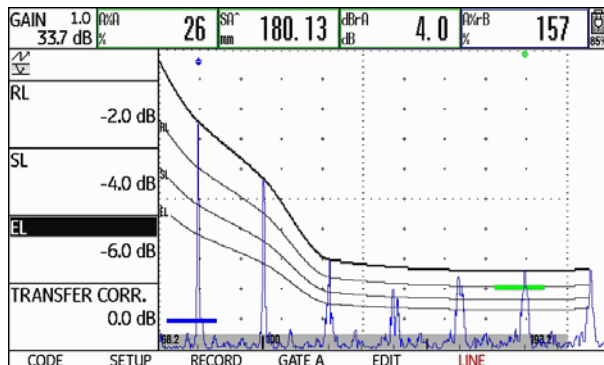

Turning the CNDAC evaluation off

You can turn the CNDAC evaluation off at any time.

- Switch to the first operating level.
- Select the function group **CNDAC**.
- Use the navigation to move **upwards** in order to display the specific function groups and functions for the JISDAC.
- Select the function group **SETUP**.
- Select the function **CNDAC MODE** and press a function key to turn the CNDAC evaluation off (**OFF**). The DAC curve and the evaluation lines are no longer displayed in the A-scan.



Note

The DAC curve is not lost by turning the function off. By turning it on again, you can use the function **CNDAC MODE** to go back to the CNDAC evaluation again without losing any settings.

Deleting the DAC curve

You can delete the DAC curve at any time. After this, the CNDAC evaluation is not possible until you have recorded a new DAC curve.

- Switch to the first operating level.
- Select the function group **CNDAC**.
- Use the navigation to move **upwards** in order to display the specific function groups and functions for the JISDAC.
- Select the function group **SETUP**.
- Select the function **DELETE CURVE** and press a function key. A message prompting you to confirm is displayed.
- Press the two function keys at the same time to confirm the deletion of the reference echo. The deletion is acknowledged by the indication (**NO CURVE**).

Echo evaluation using DAC

To be able to evaluate a flaw echo by means of the DAC, certain conditions must be met:

- The distance-amplitude correction curve has to be recorded beforehand.
- It only applies to the same probe that was used for recording the curve. It is not allowed to use even another probe of the same type!
- The curve only applies to the material corresponding to the material of the reference block.
- All functions affecting the echo amplitude must be set in the same way as they existed during the recording of the curve. This applies especially to the parameters voltage, frequency, rectification, material velocity, and reject.

Change in the probe delay

Generally, a change in the probe delay automatically also affects the shape of the sound field. This means that a new recording of the reference echo would be theoretically required. However, minor changes in the delay line, typically occurring due to the wear of the delay line, have no noticeable effect on the programmed distance laws.



ATTENTION

A recorded DAC curve no longer applies if the probe delay changes to a larger extent, e.g. caused by adding or removing a delay line after a DAC curve has been recorded.

The same applies to immersion testing: The DAC curve must be recorded after setting up the final water delay line.

Failure to do so may lead to evaluation errors.

Automatic variation of the measuring point in TOF mode

An echo amplitude evaluation is normally carried out at the echo peak of the signal under examination because this is the only way of ensuring that the displayed echo amplitude and the sound path (projection distance, depth position) always belong to the highest echo in the gate.



Note

The USM Go checks the measuring point setting in TOF mode before processing any reference amplitudes. If **PEAK** is not set as measuring point, the instrument will automatically switch to **PEAK**. In this case, a note is displayed at the bottom edge of the display screen. The recording of the reference echo can only be repeated after this has taken place.

5.21 Evaluation according to the DGS method

The USM Go offers the optional evaluation method DGS (distance - gain - size).

Using the DGS for measurements

You can use the DGS mode to compare the reflecting power of a natural flaw in the test object with that of a theoretical flaw (circular disk-shaped equivalent reflector) at the same depth.



ATTENTION

You are comparing the reflecting power of a natural flaw with that of a theoretical flaw. No definitive conclusions may be drawn about the natural flaw (roughness, inclined position, etc.).

The so-called DGS diagram forms the basis for this comparison of the reflecting power. This diagram consists of a set of curves showing the connection of three influencing variables:

- Distance **D** between the probe coupling face and the circular disk-shaped equivalent reflector
- Difference in gain **G** between a circular disk-shaped equivalent reflector and a reference reflector, e.g. an infinitely large backwall
- Size **S** of the circular disk-shaped equivalent reflector
The influencing variable **S** remains constant for one curve in each set of curves.

The advantage of the DGS method lies in the fact that you can carry out reproducible evaluations of small discontinuities. This reproducibility is especially important, e.g. whenever you want to carry out an acceptance test.

In addition to the influencing variables already mentioned, there are other factors affecting the curve shape:

- sound attenuation,
- transfer losses,
- amplitude correction value,
- probe.

The following parameters of the probe affect the curve shape:

- element or crystal diameter,
- frequency,
- length of delay line,
- delay velocity.

You can adjust these parameters in the USM Go in such a way that you can use the DGS method with many different probes and on various materials.



Note

Before setting up the DGS mode, the instrument has to be calibrated at first since none of the functions affecting the DGS evaluation (**VELOCITY, PROBE DELAY, VOLTAGE, ENERGY, DAMPING, FREQUENCY, RECTIFY**), can be changed any more after recording the reference echo.

For dual-element probes, the sound velocity can only be set between 5350 and 6500 m/s.

For more information on this subject, please refer to Chapter 5.8 **Calibrating the USM Go**, page 5-29.

Validity of the DGS method

Echo amplitude evaluations using the DGS method are only reliable and reproducible under the following conditions:

- In test objects showing sound attenuation characteristics that cannot be neglected, the sound attenuation coefficient must be determined and entered in the DGS table. For this purpose, the sound attenuation coefficient is measured in the test object itself or in a reference test block made of identical material, with known reference reflectors at various distances according to the known methods and, afterwards, entered in the DGS tables. The subsequently displayed evaluation curve will then take the effective sound attenuation into account, independently of the distance.
- The reference echo must come from the test object if possible. If this is not possible, it should be ensured that the reference block is made of the same materials as the test object.
- The evaluation must be carried out using the same probe that was used for recording the reference echo. Another probe of the same type can be used after recording a new reference echo.
- Echo amplitudes for reflector distances smaller than half of the near-field length of the probe used are subject to considerable variations, for physical reasons, due to the interference phenomena being effective in this area. Evaluation results may therefore vary by more than the usually permissible ± 2 dB. Although a DGS evaluation is possible, it is not recommended in this case.

Change in the probe delay with DGS

Generally, a change in the probe delay automatically also affects the shape of the sound field. This means that a new recording of the reference echo for the DGS setting would be theoretically required. However, minor changes in the delay line, typically occurring due to the wear of the delay line, have no noticeable effect on the programmed distance laws.



ATTENTION

An existing DGS setting no longer applies if the probe delay changes to a larger extent, e.g. caused by adding or removing a delay line after recording a DGS reference echo before changing the delay line.

The same applies to immersion testing: The DGS setting must be made after setting up the final water delay line.

Failure to do so may lead to evaluation errors.

Automatic variation of the measuring point in TOF mode

An echo amplitude evaluation is normally carried out at the echo peak of the signal under examination because this is the only way of ensuring that the displayed echo amplitude and the sound path (projection distance, depth position) always belong to the highest echo in the gate.



Note

The USM Go checks the measuring point setting in TOF mode before processing any reference amplitudes. If **PEAK** is not set as measuring point, the instrument will automatically switch to **PEAK**. In this case, a note is displayed at the bottom edge of the display screen.

Starting the echo height evaluation according to DGS

EVALMODE	
EVAL MODE	dB REF
COLOR LEG	OFF
MAGNIFY GATE	GATE A
AGT	OFF

gate a start	12.50 mm
REFERENCE TYPE	BW
REF SIZE	----
RECORD REF	(NO REF)

- Switch to the second operating level.
- Select the function group **EVAL**.
- Select the function **EVAL MODE** and press a function key to choose **DGS**.
- Switch back to the first operating level. The function group **DGS** is now displayed there.

Basic settings for the DGS measurement

You can choose the probe and set other DGS parameters in this step.

- Select the function group **DGS**.
- Use the navigation to move **upwards** in order to display the specific function groups and functions for the DGS.

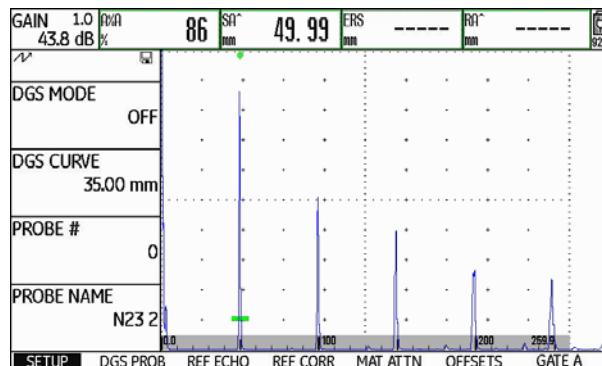

- Select the individual functions in the different function groups, and press the function keys to define the corresponding settings:

- **DGS CURVE** (recording curve for DGS evaluation)
You can use this to select the circular disk-shaped reflector diameter to be used for displaying the DGS curve and as a recording threshold for echo evaluations.
- **PROBE #** (probe number)
The probe numbers refer to fixed-programmed probes with all settings (name, probe delay, element diameter, and frequency cannot be changed, see page 5-130). The probe number **0** is user programmable with regard to all parameters.
- **PROBE NAME** (Probe name)
The probe name belongs to the selected probe number and can only be changed for the probe number **0** on the second operating level if necessary (function group **DGS**, function **PROBE NAME**).
- **XTAL FREQUENCY** (probe frequency)
Frequency of the element or crystal; preset for programmed probes.
- **EFF. DIAMETER**
Effective element or crystal diameter of the probe used; preset for programmed probes.
- **DELAY VELOCITY**
Sound velocity in the probe delay line; preset for programmed probes.
- **REFERENCE TYPE**
Type of the reference reflector used (backwall, side-drilled hole, or circular disk-shaped equivalent reflector).
- **REF SIZE**
Diameter of the reference reflector.
- **REF ATTEN**
Sound attenuation in the reference block.
- **AMPL CORRECT** (amplitude correction)
This is required if you are using an angle-beam probe and the circular-arc echo from the reference standards K1 or K2 as a reference reflector.

For the angle-beam probes SWB...-5, the amplitude correction value refers to the 3 mm side-drilled hole on the reference standard K1 as reference reflector.
- **TEST ATTEN**
Sound attenuation in the test object.
- **TRANSFER CORR.**
Transfer losses in the test material.

- Select the function group **GATE A**.
- Select the function **TOF MODE** and press a function key to set the measuring point in TOF mode to **PEAK**.
- Select the function group **AUTOCAL** and calibrate the USM Go (see Chapter 5.8 **Calibrating the USM Go**, page 5-29).

Recording a reference echo and turning the DGS curve on

To be able to display the required DGS curve, you have to record the reference echo.

- Select the function group **DGS**.
- Use the navigation to move **upwards** in order to display the specific function groups and functions for the DGS.
- Select the function group **GATE A**.
- Peak the echo of the reference reflector, in this case the backwall echo from the test object.
- After this, position the gate A on the reference echo.
- Select the function group **REF ECHO**.
- Select the function **RECORD REF** and press a function key. The recording is confirmed by the indication **(recorded)**. The status icon **A DGS reference is stored** is displayed in the top left corner, next to the A-scan (see page 0-7).

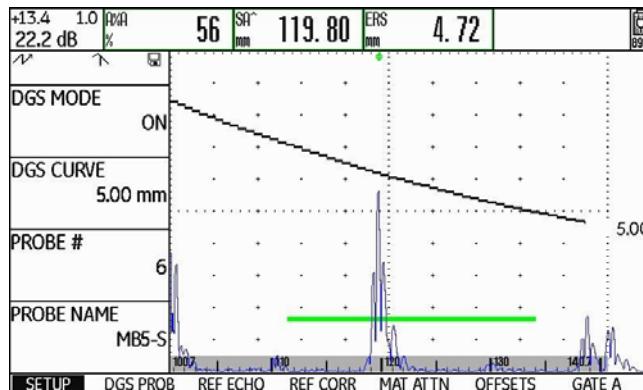
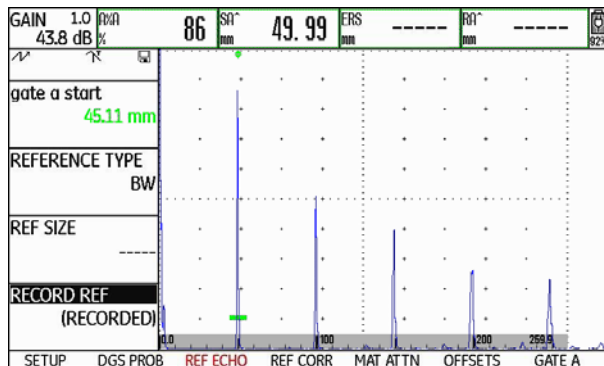

- Select the function group **SETUP**.
- Select the function **DGS MODE** and press a function key to turn on the DGS evaluation. The DGS curve is calculated and displayed in the A-scan.

Taking the general DGS diagram as a basis, the USM Go calculates the required test sensitivity for displaying the 3 mm curve with its maximum at 80 % screen height, and makes this setting. The current gain is set to 0 during this.

The curve is automatically adjusted in the case of subsequent gain variations.

The gain can be varied at any time. The difference in relation to the calibration value during the DGS calibration is directly displayed in the top left corner on top of the gain value (without designation). If you set the function **DGS MODE** to **OFF** and then to **ON** again, the original gain setting is displayed with the difference value **+0.0**.

You can also adjust the DGS curve to the expected value of the ERS (equivalent reflector size) later on.

- Switch to the second operating level.
- Select the function group **EVAL**.
- Select the reading **ERS** for one of the items in the measurement line (see Section **Configuring the measurement line**, page 5-59).

Locks, error messages

As long as a valid reference echo is stored, no functions can be changed which could cause an incorrect DGS evaluation, with the exception of **PROBE DELAY** (within tight limits). If an attempt is made to change such a function, the following error message appears:

Function locked: DGS reference has been recorded!

The DGS evaluation must likewise be turned off and the reference echo deleted when selecting a new probe, e.g. for a new test application.

Sound attenuation and transfer correction

There are two possibilities for setting the sound attenuation in the test object:

- before the DGS calibration
in the DGS function group **REF CORR** using the function **REF ATTN**
- at any time (even after the DGS calibration)
in the function group **MAT ATTN** using the function **TEST ATTN**

The transfer corrections can be set as follows:

- before the DGS calibration
in the DGS function group **REF CORR** using the function **AMPL CORRECT**
- at any time (even after the DGS calibration)
in the function group **MAT ATTN** using the function **TRANSFER CORR.**

The settings of the functions **AMPL CORRECT** and **TRANSFER CORR.** have an additive effect, likewise the settings of the functions **REF ATTN** and **TEST ATTN.**

Using multiple DGS curves

After turning the DGS evaluation on, at least one curve is displayed for a certain ERS (equivalent reflector size). For some test specifications according to DGS, certain tolerance limits in dB below and/or above this curve must be monitored.

You can set up to four additional curves by adjusting their offsets from the original curve in dB values. These curves have no effect on the displayed measurement reading or on other settings.

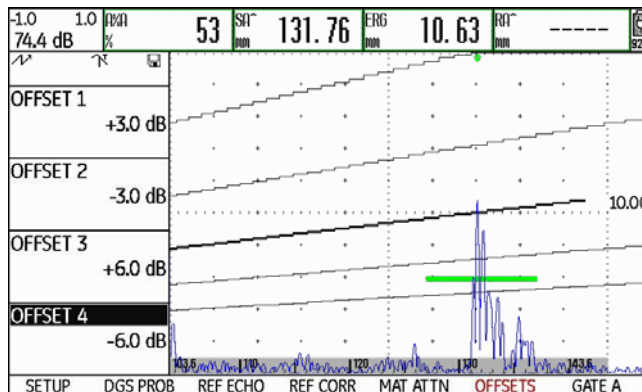

Turning the DGS evaluation off

You can turn the DGS evaluation off at any time.

- Switch to the first operating level.
- Select the function group **DGS**.
- Use the navigation to move **upwards** in order to display the specific function groups and functions for the DGS.
- Select the function group **SETUP**.
- Select the function **DGS MODE** and press a function key to turn the DGS evaluation off (**OFF**). The DGS curve is no longer displayed in the A-scan.



Note

The DGS calibration is not lost by turning the function off. By turning it on again, you can use the function **DGS MODE** to go back to the DGS evaluation again without losing any settings.

Deleting a DGS reference echo

You can delete the echo of the reference reflector. After this, the DGS evaluation is not possible until you have recorded a new reference echo.

- Switch to the first operating level.
- Select the function group **DGS**.
- Use the navigation to move **upwards** in order to display the specific function groups and functions for the DGS.
- Select the function group **REF CORR**.
- Select the function **DELETE REF** and press a function key. A message prompting you to confirm is displayed.
- Press the two function keys at the same time to confirm the deletion of the reference echo. The deletion is acknowledged by the indication (**NO REF**).

Probe data

#	Probe name	Wavelength in steel [mm]	Minimum diameter of side-drilled hole [mm]	Near-field length in steel [mm]	Minimum distance in steel [mm]
1	B1-S	6.0	9.0	23	35
2	B2-S	3.0	4.5	45	68
3	B4-S	1.5	2.3	90	135
4	MB2-S	3.0	4.5	8	12
5	MB4-S	1.5	2.3	15	23
6	MB5-S	1.2	1.8	20	30
7 ... 9	MWB ...-2	1.6	2.4	15	23
10 ... 12	MWB ...-4	0.8	1.2	30	45
13 ... 15	SWB ...-2	1.6	2.4	39	59
16 ... 18	SWB ...-5	0.7	1.1	98	147
19 ... 21	WB ...-1	3.3	5.0	45	68
22 ... 24	WB ...-2	1.6	2.4	90	135

#	Probe	Wavelength in steel [mm]	Focus depth in steel [mm]
25	MSEB-2	3.0	8 ±2
26	MSEB-4	1.5	10 ±2
27	MSEB-4 0°	1.5	18 ±4
28	MSEB-5	1.2	10 ±2
29	SEB-1	5.9	20 ±4
30	SEB-2 KF5	3.0	6 ±2
31	SEB-4 KF8	1.5	6 ±2
32	SEB-2	3.0	15 ±3
33	SEB-4	1.5	12 ±2
34	SEB-2 0°	1.5	12 ±2

**Note**

The DGS curves for the dual-element probes are not derived from the general DGS diagram but have been individually measured for steel (5920 m/s) and stored in the instrument.

You can only carry out a DGS evaluation with one of the dual-element probes available if the sound velocity is between 5330 and 6500 m/s.

trueDGS angle-beam probes

trueDGS[®] angle-beam probes generate a rotationally symmetric sound field in the material to be tested like vertically beaming circular elements.

Because of this, the DGS evaluation using these angle-beam probes is considerably more accurate than with the conventional angle-beam probes which contain rectangular elements. In the case of conventional angle-beam probes, it may happen the the reflectors evaluated according to the DGS method are over-evaluated.

The following probes using the trueDGS[®] technology are currently available:

- MWB45-2 tD (probe # **35**)
- MWB60-2 tD (probe # **36**)
- MWB70-2 tD (probe # **37**)
- MWB45-4 tD (probe # **38**)
- MWB60-4 tD (probe # **39**)
- MWB70-4 tD (probe # **40**)

These new probes can be selected in the instrument. The corresponding settings are stored in the instrument and activated when the probe is selected.

Documentation **6**

6.1 Test reports

Storing test reports

You can use the USM Go to store test reports and A-scans. Test reports are stored as an image in the format JPG and BMP, as well as an ASCII file in the format UGO.



Note

All data are saved to the SD memory card. Make sure that the SD card used in the instrument has a sufficient amount of free storage capacity for your tasks.

You can store A-scans as well as current settings and readings at any time using the function **COPY** if you have assigned this function to one of the function keys (see Chapter 5.3 **Assignment of function keys**, page 5-8).

As an alternative, you can store test reports using the corresponding function on the second operating level.

Storing using COPY



Note

If you repeatedly select the same filename for storing, a consecutive numbering is automatically attached to the filename, for example FILE_002.

- Check in the function group **FILES** on the second operating level whether the required memory location and filename are selected.
- Switch back to the first operating level and press the function key that has the function **COPY** assigned to it.

During the process of storing, the corresponding icon is displayed next to the A-scan (see Section **Status display icons**, page 0-7 at the beginning of this operating manual).

Storing on the second operating level

FILENAME
FILENAME FILES
ACTION STORE REPORT
ENTER
DIRECTORY GUI

- Switch to the second operating level.
- In the function group **FILES**, select the function **DIRECTORY** and briefly press the joystick (USM Go) or the center key of the keypad (USM Go+). The directory of the SD memory card appears.
- Press the function keys to select a directory on the SD card.
- Press the joystick (USM Go) or the center key of the keypad (USM Go+) briefly to choose the selected directory.
- Switch to the function **ACTION** and press the function keys to select one of the functions **STORE REPORT** (test report) or **FAST REPORT** (fast report).
- Switch to the function **FILENAME** and briefly press the joystick (USM Go) or the center key of the keypad (USM Go+).
- Use the navigation to choose the option **<NEW FILE>** and briefly press the joystick (USM Go) or the center key of the keypad (USM Go+).
- Use the navigation to choose the first character of the filename.
- Use the navigation to switch to the next position, and choose the next character.
- Press the joystick (USM Go) or the center key of the keypad (USM Go+) briefly to close the filename entry.

- Switch to the function **ENTER** and briefly press the joystick (USM Go) or the center key of the keypad (USM Go+).

The test report is stored in the selected directory on the SD memory card under the name entered here.



Note

You can create and delete directories by inserting the SD memory card into the SD card reader of your PC or by connecting the USM Go to a PC via a USB cable (see Section **USB interface**, page 8-3).

Displaying test reports

You can display test reports saved to the SD card on the display screen of your instrument.



Note

You can only display files having the file-name extension BMP. Other files on the SD memory card are not displayed as options.

- Switch to the second operating level.
- In the function group **FILES**, select the function **DIRECTORY** and briefly press the joystick (USM Go) or the center key of the keypad (USM Go+). The directory of the SD memory card appears.
- Press the function keys to select a directory on the SD card.
- Press the joystick (USM Go) or the center key of the keypad (USM Go+) briefly to choose the selected directory.

- Switch to the function **ACTION** and press the function keys to select the function **SHOW REPORT**.
- Switch to the function **FILENAME** and briefly press the joystick (USM Go) or the center key of the keypad (USM Go+).
- Use the navigation to select the name of the required file.
- Press the joystick (USM Go) or the center key of the keypad (USM Go+) briefly. The selection switches automatically to the function **ENTER**.
- Press the joystick (USM Go) or the center key of the keypad (USM Go+) briefly.

After the loading process, which takes a few seconds, the test report is displayed on the display screen.

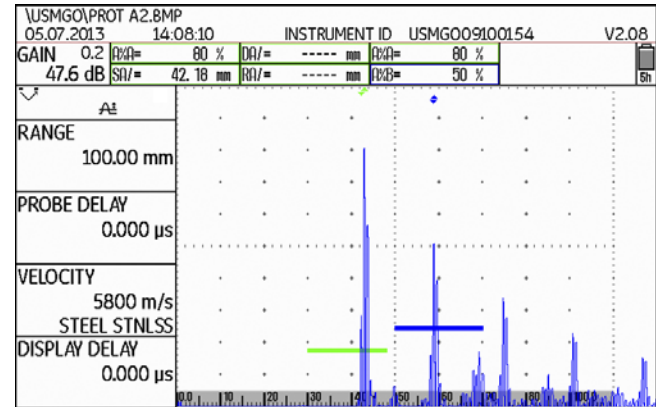

In the top part, you will see various data of the report:

- memory location and filename
- date and time
- instrument number and software version

- Use the navigation to shift the view in order to display other data of the test report, provided they were also selected during storing.

RANGE	PULSER	RECEIVER	dB REF	AUTOCAL	GATE A	GATE B
CV Parameter Table						
RANGE	RANGE	PROBE DELAY	VELOCITY	DISPLAY DELAY		
	100.00 mm	0.000 μ s	5800 m/s	0.000 μ s		
PULSER	VOLTAGE		DAMPING			
	LOW		1000 OHM			
RECV	FREQUENCY	RECTIFY	DUAL	REJECT		
	1 - 5 MHz	NEG HALFWAVE	ON	0%		
PRF	PRF MODE	PRF VALUE				
	AUTO LOW	400 Hz				
GATES	GATE A START	GATE A WIDTH	A THRESHOLD	TOF MODE		
	29.97 mm	17.90 mm	AGT = 23%	FLANK		
	GATE B START	GATE B WIDTH	B THRESHOLD	TOF MODE		
	50.00 mm	20.00 mm	AGT = 50%	FLANK		
	GATE C START	GATE C WIDTH	C THRESHOLD	TOF MODE		
	50.00 mm	50.00 mm	20%	FLANK		
TRIG	PROBE ANGLE	THICKNESS	X VALUE	O-DIAMETER		
	OFF	50.00 mm	0.00 mm	FLAT		
GAIN	GAIN	REF GAIN	TRANSFER CORR.			
	47.6 dB	0.0 dB	1.4 dB			
FILE	LAST DATASET LOADED					
	PROT A2					
dB REF	MODE	REFERENCE				

- Press the joystick (USM Go) or the center key of the keypad (USM Go+) briefly to close the test report display.

Printing test reports

The USM Go is not meant to be directly connected to a printer.

You can use the corresponding standard programs (text and image editors) on your PC to view, edit, and print out the test reports and A-scans stored by means of the USM Go in the format JPG and BMP, as well as the AS-CII files in the format UGO.

To do this, insert the SD memory card into the SD card reader of your PC or connect the USM Go to your PC via a USB cable (see Section **USB interface**, page 8-3).

Deleting test reports

You can delete files and directories easily by inserting the SD memory card into the SD card reader of your PC or by connecting the USM Go to a PC via a USB cable (see Section **USB interface**, page 8-3).

You can also delete single dataset files on the second operating level of the USM Go.

FILENAME
FILENAME FILES
ACTION STORE REPORT
ENTER
DIRECTORY GUI



Note

Only files of the type UGO are deleted. Files of the types BMP and JPG are retained.

- Switch to the second operating level.
- In the function group **FILES**, select the function **DIRECTORY** and briefly press the joystick (USM Go) or the center key of the keypad (USM Go+). The directory of the SD memory card appears.
- Press the function keys to select a directory on the SD card.
- Press the joystick (USM Go) or the center key of the keypad (USM Go+) briefly to choose the selected directory.
- Switch to the function **ACTION** and press the function keys to select the function **DELETE DATASET**.

- Switch to the function **FILENAME** and briefly press the joystick (USM Go) or the center key of the keypad (USM Go+).
- Use the navigation to select the name of the required dataset file.
- Press the joystick (USM Go) or the center key of the keypad (USM Go+) briefly. The selection switches automatically to the function **ENTER**.
- Press the joystick (USM Go) or the center key of the keypad (USM Go+) briefly. The message **DOUBLE KEY PRESS KEY TO CONFIRM** is displayed at the top of the display screen.
- To confirm, press the two function keys at the same time. The dataset file is deleted.

Storing the A-scan and parameters in the test report

REPORT
IMAGE IN REPOR YES
PARAM IN REPOR YES
PARAMETERS SUMMARY

When storing test reports, you can decide whether to store the A-scan and the list of parameters as well. To do this, you have to turn on the corresponding function.

- Switch to the second operating level.
- In the function group **FILES**, select the function **IMAGE IN REPOR** and press a function key to turn on the function by choosing **YES**.
- Select the function **PARAM IN REPOR** and press a function key to turn on the function by choosing **YES**.

Next time a test report is stored, the selected information is inserted.

6.2 Storing memos

MEMO/HDR
HEADER EDIT <NEW HEADER>
MEMO EDIT <NEW MEMO>
MEMO IN REPORT NO
HDR IN REPORT NO

You can store short notes or memos as text files. The contents of these memo files are attached to the test reports if you turn on the corresponding function. Each memo file can contain a maximum of 5 lines consisting of 31 characters each.

The memo file is stored in the subdirectory MEMO of the currently selected directory on the SD memory card.

Creating a new memo file

- Switch to the second operating level.
- In the function group **FILES**, select the function **MEMO EDIT** and briefly press the joystick (USM Go) or the center key of the keypad (USM Go+).
- Use the navigation to choose the option **<NEW FILE>** and briefly press the joystick (USM Go) or the center key of the keypad (USM Go+).
- Use the navigation to choose the first character of the filename.
- Use the navigation to switch to the next position, and choose the next character.
- Press the joystick (USM Go) or the center key of the keypad (USM Go+) briefly to close the filename entry. You can then enter the text.
- Use the navigation to enter the text.
- Finally, press the joystick (USM Go) or the center key of the keypad (USM Go+) briefly to close the entry.

Editing a memo file

You can edit a memo file saved to the SD memory card at any time.

- Switch to the second operating level.
- In the function group **FILES**, select the function **MEMO EDIT** and briefly press the joystick (USM Go) or the center key of the keypad (USM Go+).
- Use the navigation to choose the name of the required file and briefly press the joystick (USM Go) or the center key of the keypad (USM Go+).
- Use the navigation to edit the text.
- Finally, press the joystick (USM Go) or the center key of the keypad (USM Go+) briefly to close the entry.



Note

You can use any text editor to edit memo files by inserting the SD memory card into the SD card reader of your PC or by connecting the USM Go to a PC via a USB cable (see Section **USB interface**, page 8-3).

Please keep in mind that a memo file may contain a maximum of 5 lines consisting of 31 characters each.

Attaching a memo file to test report

You can attach the text of a memo file to one or several test reports. To do this, you have to select a memo file and turn on the function **MEMO IN REPORT**.

- Switch to the second operating level.
- In the function group **FILES**, select the function **MEMO EDIT** and briefly press the joystick (USM Go) or the center key of the keypad (USM Go+).
- Use the navigation to choose the name of the required file and briefly press the joystick (USM Go) or the center key of the keypad (USM Go+).
- Finally, press the joystick (USM Go) or the center key of the keypad (USM Go+) briefly again to close the text edit box.
- Switch to the function **MEMO IN REPORT** and press a function key to turn on the function by choosing **YES**.

Next time a test report is stored, the contents of the selected memo file are attached to the end of the test report.

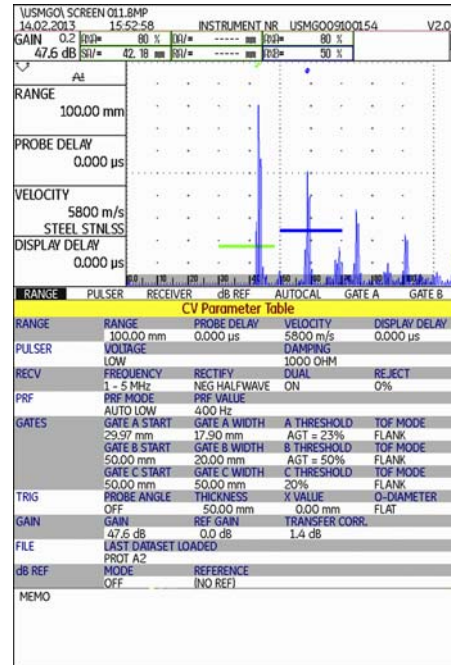

6.3 Storing a report header

MEMO/HDR	
HEADER EDIT	
<NEW HEADER>	
MEMO EDIT	
<NEW MEMO>	
MEMO IN REPORT	
	NO
HDR IN REPORT	
	NO

You can store brief information for the header area of test reports as text files. The contents of these header files are positioned at the head of the test reports if you turn on the corresponding function. Each header file can contain a maximum of 5 lines consisting of 31 characters each.

The header file is stored in the subdirectory **HEADER** of the currently selected directory on the SD memory card.

Creating a new header file

- Switch to the second operating level.
- In the function group **FILES**, select the function **HEADER EDIT** and briefly press the joystick (USM Go) or the center key of the keypad (USM Go+).
- Use the navigation to choose the option **<NEW FILE>** and briefly press the joystick (USM Go) or the center key of the keypad (USM Go+).
- Use the navigation to choose the first character of the filename.
- Use the navigation to switch to the next position, and choose the next character.
- Press the joystick (USM Go) or the center key of the keypad (USM Go+) briefly to close the filename entry. You can then enter the text.
- Use the navigation to enter the text.
- Finally, press the joystick (USM Go) or the center key of the keypad (USM Go+) briefly to close the entry.

Editing a header file

You can edit a header file saved to the SD memory card at any time.

- Switch to the second operating level.
- In the function group **FILES**, select the function **HEADER EDIT** and briefly press the joystick (USM Go) or the center key of the keypad (USM Go+).
- Use the navigation to choose the name of the required file and briefly press the joystick (USM Go) or the center key of the keypad (USM Go+).
- Use the navigation to edit the text.
- Finally, press the joystick (USM Go) or the center key of the keypad (USM Go+) briefly to close the entry.



Note

You can use any text editor to edit header files by inserting the SD memory card into the SD card reader of your PC or by connecting the USM Go to a PC via a USB cable (see Section **USB interface**, page 8-3).

Please keep in mind that a header file may contain a maximum of 5 lines consisting of 31 characters each.

Including a header file in the test report

You can insert the text of a header file into one or several test reports. To do this, you have to select a header file and turn on the function **HDR IN REPORT**.

- Switch to the second operating level.
- In the function group **FILES**, select the function **HEADER EDIT** and briefly press the joystick (USM Go) or the center key of the keypad (USM Go+).
- Use the navigation to choose the name of the required file and briefly press the joystick (USM Go) or the center key of the keypad (USM Go+).
- Finally, press the joystick (USM Go) or the center key of the keypad (USM Go+) briefly again to close the text edit box.
- Switch to the function **HDR IN REPORT** and press a function key to turn on the function by choosing **YES**.

Next time a test report is stored, the contents of the selected header file are inserted into the head of the test report.

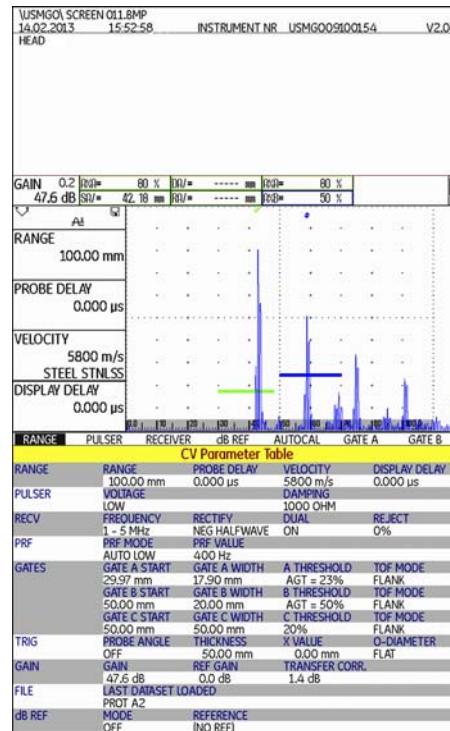

6.4 Viewing and storing parameters

REPORT
IMAGE IN REPOR YES
PARAM IN REPOR YES
PARAMETERS SUMMARY

You can view a complete list of parameters and settings on the display screen of the USM Go and store them in a file.

The list of parameters is stored as a PDF file in the currently active directory on the SD memory card.

- In the function group **FILES**, select the function **PARAMETERS** and briefly press the joystick (USM Go) or the center key of the keypad (USM Go+). The first page of the list of all parameters and settings is displayed on the screen.
- Use the navigation to browse through further pages of the parameter list.
- Press the two function keys at the same time to store the parameter list.
- Press the joystick (USM Go) or the center key of the keypad (USM Go+) briefly to hide the parameter list again.

You cannot view the stored parameter list on the display screen of the USM Go.

You can use the program Acrobat Reader available in the Internet free of charge to view PDF files by inserting the SD memory card into the SD card reader of your PC or by connecting the USM Go to a PC via a USB cable (see Section **USB interface**, page 8-3).

6.5 Videos

You can record and replay videos. During recording, all movements on the display screen are recorded at a frame rate of 10 or 50 frames per second. You can directly view recorded videos on the display screen of the USM Go.

Recording a video

VIDEO	
SOURCE/DEST	MEMORY
FILENAME	
UID	
MODE	REPLAY
ENTER	

You can store a video in the internal memory of the instrument or on the SD memory card. The frame rate is 50 frames per second when using the internal memory and 10 frames per second when using the SD card.

During recording, various control functions and the operation of the gates are available to you. In addition, you can set several flags in order to find single sequences faster later on.



Note

Make sure that the SD card used in the instrument has a sufficient amount of free storage capacity for your tasks. The storage capacity of the internal memory is sufficient for approx. 8 minutes of recording time (24,000 single frames).

- Switch to the second operating level.
- In the function group **FILES**, select the function **SOURCE/DEST**.
- Press the function keys to select the memory location.
- Switch to the function **FILENAME** and briefly press the joystick (USM Go) or the center key of the keypad (USM Go+).
- Use the navigation to choose the option **<NEW FILE>** and briefly press the joystick (USM Go) or the center key of the keypad (USM Go+).

- Use the navigation to choose the first character of the filename.
- Use the navigation to switch to the next position, and choose the next character.
- Press the joystick (USM Go) or the center key of the keypad (USM Go+) briefly to close the filename entry.
- Switch to the function **MODE** and press a function key to select the **RECORD** mode.
- Switch to the function **ENTER** and briefly press the joystick (USM Go) or the center key of the keypad (USM Go+).
- If the note **FILE EXISTS. DOUBLE KEY PRESS TO OVERWRITE FILE.** ... is displayed, press the two function keys at the same time to overwrite the existing file.

You will then automatically switch to the first operating level with the A-scan.

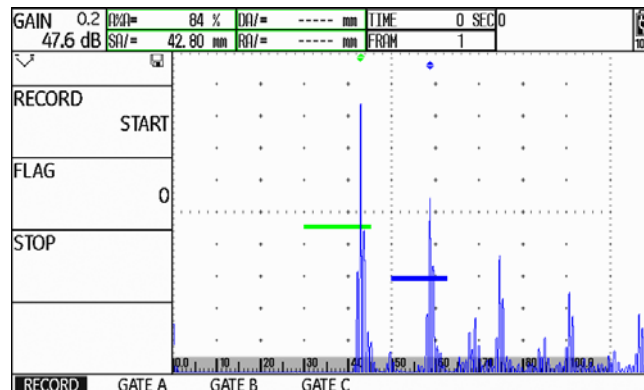

Next to the A-scan, the control functions are displayed in the function group **RECORD**, whereas the settings for each gate in question are displayed in the function groups of gates.

Recording information is displayed on top of the A-scan:

- **TIME** = current time of recording,
- **FRAM** = number of single frames.

- In the function group **RECORD**, select the function **RECORD** and press a function key. The video recording starts.
- Switch to the function **FLAG** and press a function key to set a flag. The name of the flag corresponds to the number of the single frame when the function key is pressed.
- Switch to one of the function groups of gates and operate the gates as usual.
- Vary the gain as usual.
- In the function group **RECORD**, select the function **RECORD** and press a function key to interrupt the recording.
- In the function group **RECORD**, select the function **STOP** and press a function key. The recording is stopped, and you will see the normal display view of the first operating level with the A-scan and the function groups.

Viewing a video

VIDEO	
SOURCE/DEST	MEMORY
FILENAME	
UID	
MODE	REPLAY
ENTER	

You can view the videos stored in the internal memory or on the SD memory card directly on the display screen of the USM Go.

On the USB stick belonging to the USM Go, there is also a small reading program for PC's which can be used for viewing videos recorded by means of the USM Go on the display screen of a PC.

- Switch to the second operating level.
- In the function group **FILES**, select the function **SOURCE/DEST**.
- Press the function keys to select the memory location.
- Switch to the function **FILENAME** and briefly press the joystick (USM Go) or the center key of the keypad (USM Go+).
- Use the navigation to select the name of the required dataset file.
- Press the joystick (USM Go) or the center key of the keypad (USM Go+) briefly to confirm the selection.
- Switch to the function **MODE** and press a function key to select the **REPLAY** mode.
- Switch to the function **ENTER** and briefly press the joystick (USM Go) or the center key of the keypad (USM Go+).

You will then automatically switch to the first operating level with the A-scan. The replay starts automatically.

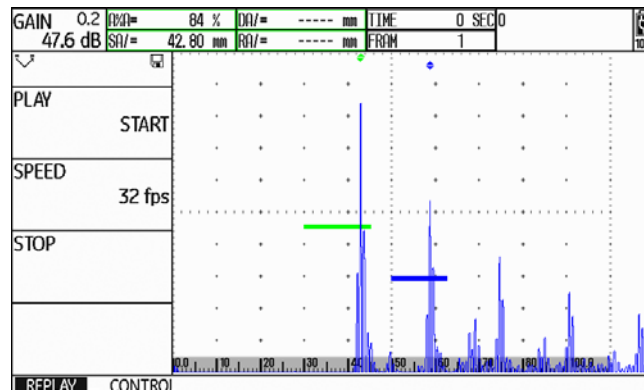

The control functions in the function groups **REPLAY** and **CONTROL** are displayed next to the A-scan.

Recording information is displayed on top of the A-scan:

- **TIME** = current time of recording,
- **FRAM** = number of single frames.

- In the function group **REPLAY**, select the function **PLAY** and press a function key. The replay starts.
- Switch to the function **SPEED** and press the function keys to change the replay speed.
- In the function **REPLAY**, select the function **PLAY** and press a function key to interrupt the recording.
- Switch to the function group **CONTROL** and select the function **FLAG**.
- Press the function keys to toggle between the flags set during recording.
- Select the function **TIME** and press the function keys to choose and to display a certain point of time of the video recording.
- Select the function **FRAME** and press the function keys to choose and to display a certain single frame of the video recording.
- In the function **REPLAY**, select the function **STOP** and press a function key to stop the replay.

6.6 Documentation using UltraMATE

The special application program UltraMATE provided by Waygate Technologies enables you to remotely control the USM Go and to include instrument settings in ASCII format or display contents in your test report.

All data can be further processed using customary word processing or DTP programs.

You will find information on how to use the program in a detailed operating manual.



Note

The version 2.60 or a later version of UltraMATE must be available.

6.7 Data Recorder (option)

The functions of the option Data Recorder are available to you in the function group **DR** on the second operating level.

DR SETUP	DR NAV		
FILENAME <NEW FILE>	TOP 1A		
CREATE	BOTTOM 1A		
DR VIEW OFF	ADV DIRECTION RIGHT		
DR THICKNESS SBA			
dB REF	CONFIG1	CONFIG2	CONFIG3
			CONFIG4
			DR

The data recorder enables you to easily manage test tasks with wall thickness measurements, and to store and to document readings in a structured manner with or without an A-scan.

You can store readings in a grid matrix and, in this way, structure them according to the test tasks. The grid matrix consists of rows and columns.

In this way, you can e.g. use the rows for test locations and the columns for single test points. In a grid matrix consisting of 9 rows and 4 columns, you will then store the results of a test location in one row each. You can store the readings from one, two, or three test points for each test location. If you have not processed a test point, the corresponding cell in the grid matrix remains empty.

	1	2	3	4
A	42.81	EMPTY	EMPTY	EMPTY
B	EMPTY	EMPTY	EMPTY	EMPTY
C	EMPTY	EMPTY	EMPTY	EMPTY
D	EMPTY	EMPTY	EMPTY	EMPTY
E	EMPTY	EMPTY	EMPTY	EMPTY
F	EMPTY	EMPTY	EMPTY	EMPTY
G	EMPTY	EMPTY	EMPTY	EMPTY
H	EMPTY	EMPTY	EMPTY	EMPTY
I	EMPTY	EMPTY	EMPTY	EMPTY

Start by creating an empty grid matrix in a Data Recorder file. After this, you can display this grid matrix on the screen and fill it with thickness readings.

Creating a Data Recorder file

DR SETUP	DR NAV
FILENAME <NEW FILE>	TOP 1A
CREATE	BOTTOM 1A
DR VIEW OFF	ADV DIRECTION RIGHT
DR THICKNESS SBA	

Before you are able to store readings in a grid matrix, you have to create a Data Recorder file.

When doing this, you have to define the following parameters:

- the size (number of rows and columns),
- the automatic filling advance direction for the readings (in rows or in columns), and
- the required measuring method for determining the wall thickness value (sound path in a gate or between two gates).



ATTENTION

After generating the file, you can no longer change the number of rows and columns that you have defined using the function **BOTTOM**.

- Switch to the second operating level.
- In the function group **DR**, select the function **FILENAME** and briefly press the joystick (USM Go) or the center key of the keypad (USM Go+).
- Use the navigation to choose the option **<NEW FILE>** and briefly press the joystick (USM Go) or the center key of the keypad (USM Go+).
- Use the navigation to choose the first character of the filename.
- Use the navigation to switch to the next position, and choose the next character.

- Press the joystick (USM Go) or the center key of the keypad (USM Go+) briefly to close the filename entry.
- Switch to the function **TOP** and briefly press the joystick (USM Go) or the center key of the keypad (USM Go+).
- Select the coordinates for the first cell in the top left corner of the grid matrix. The choice of the option **1A** means that the column names start with **1** and the row names with **A**.
- Press the joystick (USM Go) or the center key of the keypad (USM Go+) briefly to close the selection.
- Switch to the function **BOTTOM** and briefly press the joystick (USM Go) or the center key of the keypad (USM Go+).
- Select the coordinates for the last cell in the bottom right corner of the grid matrix. The choice of the option **4H** means that **4** columns and **8** rows (**A** to **H**) are created.
- Press the joystick (USM Go) or the center key of the keypad (USM Go+) briefly to close the selection.
- Switch to the function **ADV DIRECTION** and press the function keys to select the automatic filling advance direction for the grid matrix.
- Switch to the function **DR THICKNESS** and press the function keys to select the measuring method (for example **SA** = sound path in the gate A).
- Switch to the function **CREATE** and briefly press the joystick (USM Go) or the center key of the keypad (USM Go+). The Data Recorder file is created.

After creating the Data Recorder file, the number of rows and columns is indicated.

DR NAV	
NUM OF COLS	4
NUM OF ROWS	8
ADV DIRECTION	RIGHT

Activating a Data Recorder file

DR SETUP	
FILENAME	<NEW FILE>
CREATE	
DR VIEW	OFF
DR THICKNESS	SBA

You can activate every one of the Data Recorder files created and use them for storing readings.

- Switch to the second operating level.
- In the function group **DR**, select the function **FILE-NAME** and briefly press the joystick (USM Go) or the center key of the keypad (USM Go+).
- Use the navigation to select the name of the required Data Recorder file.

- Press the joystick (USM Go) or the center key of the keypad (USM Go+) briefly to close the selection of the filename.
- Switch to the first operating level. You will see the A-scan.
- Press the joystick (USM Go) or the center key of the keypad (USM Go+) briefly.

The A-scan is displayed in a slightly reduced mode with the grid matrix of the selected Data Recorder file on its right. You can now store readings in the grid matrix.

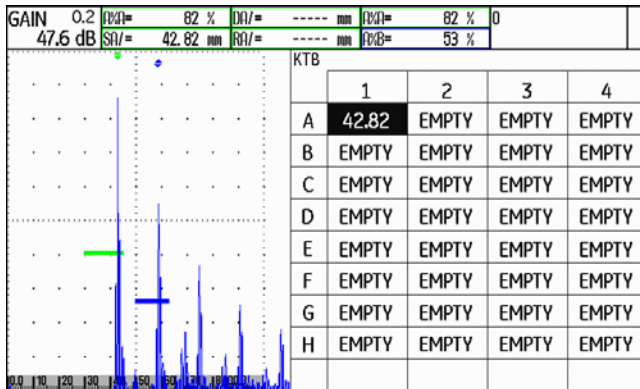

Storing readings in the grid matrix

When you see the grid matrix on the display screen, you can store readings and the corresponding A-scans in the individual cells.



Note

While the grid matrix is displayed, most A-scan functions cannot be used (for example the settings of the gates). You can only vary the gain.

- Couple the probe to the first measuring point. The reading is immediately indicated in the currently selected cell of the grid matrix.
- Use the navigation to select another cell.
- Press the lower function key briefly to store the indicated reading together with the A-scan. After storing, the next cell is automatically selected.
- Press the lower function key briefly to only store the indicated reading, without the A-scan.

If an A-scan has been stored together with the reading, you will see a mark in the top left corner of the cell.

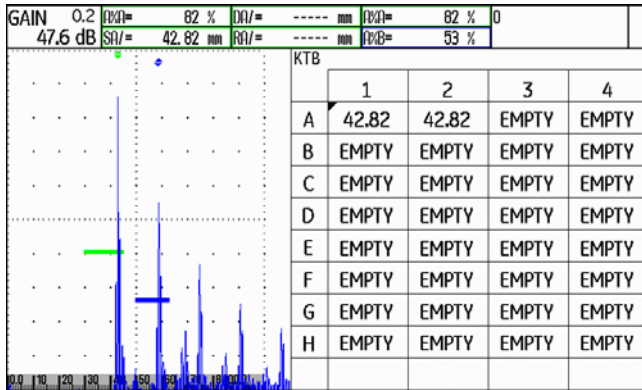

- To finish storing the readings, press the joystick (USM Go) or the center key of the keypad (USM Go+) briefly.

The grid matrix disappears and you will see the normal display view of the first operating level again.

Deleting readings

You cannot overwrite any readings. If you want to change a reading, you have to delete the stored reading, after which you will be able to store a new reading in the empty cell.

The deletion applies both to the reading and to the corresponding A-scan.

- Use the navigation to select a cell with a stored reading.
- Press the two function keys at the same time. The reading is deleted and the entry **EMPTY** appears in the cell again.

You can now store a new reading in this cell.

A-scan preview

If you select a cell containing a stored reading with an A-scan attached to it, the A-scan is displayed next to the grid matrix. The live A-scan is not displayed during this time.

Viewing Data Recorder files

You can view stored Data Recorder files, with or without readings and A-scans, on the display screen of the USM Go at any time.

- Switch to the second operating level.
- In the function group **DR**, select the function **FILE-NAME** and briefly press the joystick (USM Go) or the center key of the keypad (USM Go+).
- Use the navigation to select the name of the required Data Recorder file.
- Press the joystick (USM Go) or the center key of the keypad (USM Go+) briefly to close the selection of the filename.

- Switch to the first operating level. You will see the A-scan.
- Press the joystick (USM Go) or the center key of the keypad (USM Go+) briefly.

The A-scan is displayed in a slightly reduced mode with the grid matrix of the selected Data Recorder file on its right.

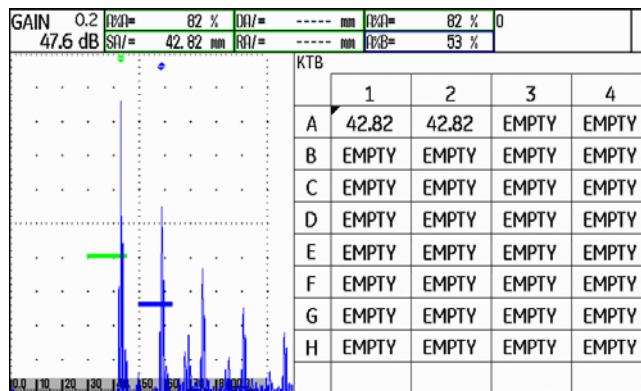

Turning the grid matrix on/off

DR SETUP	
FILENAME	<NEW FILE>
CREATE	
DR VIEW	OFF
DR THICKNESS	SBA

In general, the functions of the grid matrix are automatically turned on when you create a new Data Recorder file or select a stored Data Recorder file for editing or viewing.

When the functions of the grid matrix are turned on, you can display the grid matrix on the first operating level by briefly pressing the joystick (USM Go) or the center key of the keypad (USM Go+). It is not possible to switch over to the zoomed A-scan display mode during this. To be able to switch to the zoomed A-scan display mode, you have to turn off the functions of the grid matrix at first.

Turning the grid matrix off

- Switch to the second operating level.
- In the function group **DR**, select the function **DR VIEW**.
- Press a function key to set the function to **OFF**. This turns off the functions of the grid matrix.

Turning the grid matrix on

- Switch to the second operating level.
- In the function group **DR**, select the function **DR VIEW**.
- Press a function key to set the function to **ON**. This turns on the functions of the grid matrix.

Maintenance and care **7**

7.1 Instrument care

Clean the instrument and its accessories using a moist cloth. The following are exclusively recommended for cleaning:

- Water,
- a mild household cleaner, or
- alcohol (no methyl alcohol).



ATTENTION

Do not use any methyl alcohol, and no solvents or dye penetrant cleaners! The plastic parts may be damaged or become brittle due to them.

7.2 Battery care

Battery care

The capacity and life of batteries mainly depend on the correct handling. Therefore, please observe the tips below:

You should charge the batteries in the following cases:

- before the initial startup,
- after a storage time of 3 months or longer,
- after frequent partial discharge.

Charging the batteries

You can charge the lithium-ion battery either within the instrument itself or by means of the external charger recommended by us. Please observe the operating instructions for the charger in this regard.

The handling of batteries, the charging process, and the meaning of LED's and power indicators is described in detail in Chapter **Operation using batteries**, page 3-4.



ATTENTION

You should only use the batteries recommended by us and the corresponding charger. Any improper handling of the batteries and charger involves an explosion hazard.

7.3 Maintenance

The USM Go requires basically no maintenance.



ATTENTION

Any repair work may only be carried out by members of authorized Waygate Technologies service staff.

7.4 Software updates

You can install the latest software updates for the USM Go yourself. Look up the version installed in your instrument on the second operating level.

- Switch to the function group **CONFIG2** and further to the function **ABOUT**.
- Press the joystick (USM Go) or the center key of the keypad (USM Go+) briefly to display the start display with the information about the instrument and software.

The line **MAIN CODE** shows the version number and the date of the installed software.

Download of update files

You can download the latest software version for your instrument from the Waygate Technologies website by means of any customary web browser.

After downloading, you have to copy the update file to the main directory of the SD memory card.

- Open the browser and enter the address **<https://www.industrial.ai/inspection-technologies/ultrasound-portables/flaw-detectors/usm-go-portable-flaw-detector>**.
- Select the file **USM Go Field Upgrade - English, German, French, Spanish, Chinese, Japanese.zip** and start the download.
- Unzip the downloaded archive file (.zip) and save the update file (.sdu) to an appropriate location.
- Copy the update file (.sdu) to the main directory of the SD memory card.

Installing an update



Note

Only one file with the extension **.sdu** may be located in the main directory of the SD card for the installation. If several update files are located in the main directory, the installation process is aborted and an error message is displayed.

To install the new software, proceed as follows:

- Check whether the file has the extension **.sdu**. If not, the file is not suitable for the USM Go and must not be used.
- Power the USM Go off.
- Insert the SD memory card containing the update file into the USM Go (see Chapter 3.4 **Inserting the SD memory card**, page 3-10).

- Press the inner end of the Gain key (1), the further end of the Function key (2), and the Power key (3), and hold all three keys pressed until the display screen is turned on and the message **FLASH UP-GRADE MODE** appears.

The installation process will then start. The following messages are displayed one by one:

LOADING FILE

VERIFYING FILE

PROGRAMMING FLASH

At the end of the installation, the instrument is powered off automatically. After this, you can power the USM Go on again and use the new software version.

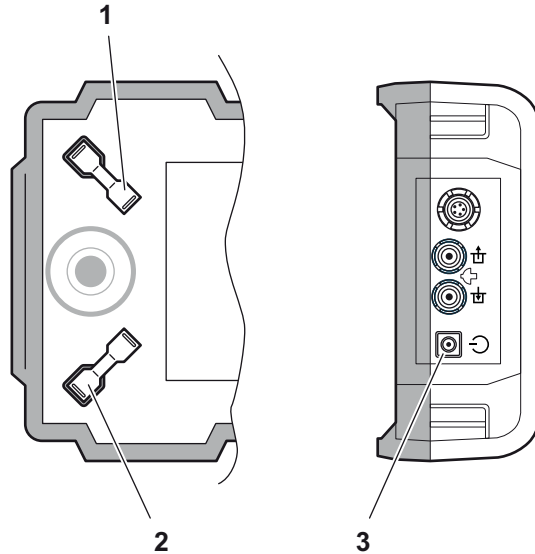

Note

For resetting the instrument to factory default settings, see Section **Factory default setting (Reset)**, page 3-12.

Interfaces and Peripherals 8

8.1 Interfaces

Overview

The interfaces are located under the watertight cover on the top of the instrument.

- Push the lock of the hinged cover (1) in the direction of the arrow in order to open the cover.
- Close the cover and make sure that it is locked tightly. If necessary, push the lock up to the limit stop in the opposite direction of the arrow in order to close the cover watertight again.

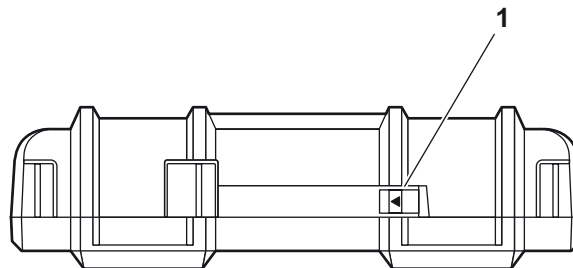

The following are located under the cover:

- USB interface (2)
- Card slot for SD memory cards (3)
- Service interface (4)

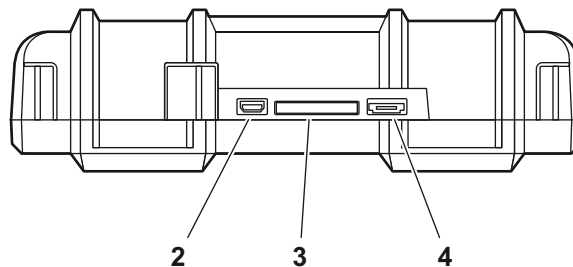

USB interface

The USB interface is executed as micro USB connector and is used for data exchange with a PC.

When you connect the instrument to a PC via a standard USB cable, the SD memory card inserted into the instrument is added to the list of active drives on the PC.

After this, you can carry out all normal file operations on the SD memory card, e.g. copying and deleting of files.

To learn more about handling of the SD memory card, see Chapter 3.4 **Inserting the SD memory card**, page 3-10.



Note

If the instrument is connected to a PC via the USB interface, it functions as an external drive. It is then not possible to use the instrument. After disconnecting the USB cable, the normal operation is possible again.

Service interface (Mini RS232-C)

The service interface is meant for using the alarm output and for service purposes for the Customer Support of Waygate Technologies.

Pin assignment of the connecting cable

Pin #	Color of wire	Signal
1	Brown	+5 V
2	Red	SAP
3	Orange	Alarm
4	Yellow	RS232 CTS
5	Green	RS232 TX
6	Blue	RS232 RX
7	Purple	GND

The alarm signal is available at the pins **3** and **7**.

8.2 Peripherals

The USM Go is not provided for the direct connection of peripherals, e.g. printers or monitors.

For more details on printing, see Section **Printing test reports**, page 6-6.

Appendix 9

9.1 Function directory



Note

Some functions are only available if the corresponding options are enabled by entering the license code.

Function	Function group	Operating level	Description	see page
A INDICATION	AWS D1.1	first		5-41
ASCAN FILL	CONFIG2	second	Choice of echo display mode (filled or normal)	5-71
A-START	AUTOCAL	first	Starting point of the gate A	5-29
A-START	DGS	first	Starting point of the gate A	5-119
A-START	GATE A	first	Starting point of the gate A	5-22
A-START	CNDAC	first	Starting point of the gate A	5-109
A-START	DAC/TCG	first	Starting point of the gate A	5-91
A-START	JISDAC	first	Starting point of the gate A	5-102
A-SCAN COLOR	CONFIG1	second	Choice of color for the A-scan	4-17
A-WIDTH	GATE A	first	Width of the gate A	5-22
A-THRESHOLD	GATE A	first	Response threshold of the gate A	5-22
AGT	EVAL	second		5-28
ACTION	FILES	second	Choice of file processing: store, recall, or delete	6-2

Function	Function group	Operating level	Description	see page
OUTPUT SELECT	CONFIG2	second		5-77
RECORD	dB REF	second	Recording of a reference echo for the dB difference measurement	5-38
FINISH	CNDAC	first	Finishing of the recording of points (curve points) for the DAC	5-109
FINISH	DAC/TCG	first	Finishing of the recording of points (curve points) for the DAC	5-91
FINISH	JISDAC	first	Finishing of the recording of points (curve points) for the DAC	5-102
RECORD	AUTOCAL	first	Start of the semi-automatic calibration function	5-29
RECORD	CNDAC	first	Recording of points (curve points) for the DAC	5-109
RECORD	DAC/TCG	first	Recording of points (curve points) for the DAC	5-91
RECORD	JISDAC	first	Recording of points (curve points) for the DAC	5-102
ENTER	FILES	second	Execution of the file processing mode selected using the function ACTION	6-2
AUTO80	CNDAC	first		5-109
AUTO80	DAC/TCG	first		5-91
AUTO80	JISDAC	first		5-102
B REFERENCE	AWS D1.1	first		5-41

Function	Function group	Operating level	Description	see page
B START MODE.	CONFIG2	second	Basis for the starting point of the gate B	5-27
B-START	GATE B	first	Starting point of the gate B	5-22
B-WIDTH	GATE B	first	Starting point of the gate B	5-22
B-THRESHOLD	GATE B	first	Starting point of the gate B	5-22
BW GAIN	CONFIG3	second	Setting of the backwall echo gain	5-82
BEA	CONFIG3	second	Activation of the backwall echo attenuation	5-82
RANGE	RANGE	first	Measuring range (display width)	5-10
DISPLAY DELAY	RANGE	first	Setting of display start	5-10
CONFIRM	CONFIG1	second	Confirmation of the entry in the function CODE	4-12
EVAL MODE	EVAL	second	Choice of echo evaluation	5-73
RECORD REF	DGS	first		5-119
REF SIZE	DGS	first	Diameter of the reference reflector	5-119
REFERENCE	dB REF	first		5-38
IMAGE IN REPOR	FILES	second	Inserting an A-scan into the test report	6-9
GRID	CONFIG1	second	Choice of a grid for the A-scan	4-18
MODE	dB REF	first	Activation of the echo comparison	5-38
MODE	EVAL	second	Size of boxes in the measurement line	4-5

Function	Function group	Operating level	Description	see page
GATE A LOGIC	CONFIG2	second	Evaluation logic of the gate A	5-74
GATE B LOGIC	CONFIG2	second	Evaluation logic of the gate B	5-74
BLOCK	AUTOANG	first		
C ATTENUATION	AWS D1.1	first		5-41
TOP	DR	second	Setting of coordinates of the first cell in the grid matrix (Data Recorder)	6-22
CODE	CONFIG1	second	Entry of the enabling code for optional functions and extensions	4-12
CTRL MODE	CONFIG4	second	Activation of the automatic gain control	5-84
dB STEP	CONFIG2	second	Choice of increment for the gain	5-6
D D1.1 RATING	AWS D1.1	first	Flaw gain in dB for the AWS evaluation	5-41
DAMPING	PULSER	first	Damping of the probe oscillating circuit	5-14
FILENAME	FILES	second	Choice or entry of filenames for reports	6-2
FILENAME	DR	second	Choice or entry of filenames for the Data Recorder	6-22
DATE	CONFIG1	second	Setting of the date	4-15
DATE	CONFIG3	second	Entry of the date for the yearly calibration	5-86
DATE FORMAT	CONFIG1	second	Choice of date format	4-15
DECIMAL	CONFIG1	second	Choice of decimal separator	

Function	Function group	Operating level	Description	see page
DIRECTORY	FILES	second	Choice of the directory for file actions	6-2
DR VIEW	DR	second	Display of grid matrix (Data Recorder)	6-22
DR THICKNESS	DR	second	Choice of the measuring method for storing readings in the grid matrix (Data Recorder)	6-22
DIAMETER	BLOCK	first		
ECHO MAX	CONFIG1	second	Activation of the function Echo Max	5-72
UNITS	CONFIG1	second	Choice of units	4-14
PROBE ANGLE	TRIG	first	Entry of the angle for the calculation of the (reduced) projection distance for angle-beam probes	5-46
PROBE ANGLE	EVAL	second		5-46
ENVELOPE	CONFIG3	second	Activation of the envelope curve	5-83
ENVELOPE COLOR	CONFIG3	second	Choice of the color for the envelope curve	5-83
CREATE	DR	second	Creating a dataset	6-22
COLOR	CONFIG1	second	Choice of color scheme for the display screen	4-16
COLOR LEG	EVAL	second	Activation of the color marking for legs	5-49
FREEZE MODE	CONFIG3	second	Setting of the automatic display freeze (Freeze)	5-68
USER GAIN STEP	CONFIG2	second	User-adjustable increment for the gain variation	5-6
FREQUENCY	RECEIVER	first	Frequency range of the connected probe	5-19

Function	Function group	Operating level	Description	see page
FUNCTION 1	CONFIG2	second	Assignment of the function key 1 (upper end of key)	5-8
FUNCTION 2	CONFIG2	second	Assignment of the function key 2 (lower end of key)	5-8
ABOUT	CONFIG2	second	Start display with information about version and software	5-52
RECTIFY	RECEIVER	first	Choice of rectification mode	5-19
LARGE	EVAL	second	Choice of a reading for the enlarged display	4-5
BRIGHTNESS	CONFIG1	second	Setting of display brightness	4-18
PRF MODE	CONFIG2	second	Pulse repetition frequency	5-17
PRF MODE	PULSER	first	Pulse repetition frequency	5-14
ENERGY	PULSER	first	Intensity of the initial pulse	5-14
JOY CONTROL	CONFIG1	second	Locking of the joystick	5-76
CAL REMINDER	CONFIG2	second	Activation of the reminder function for the calibration	5-86
CAL REMINDER	CONFIG3	second	Activation of the reminder function for the yearly calibration	5-86
CAL RESET	CONFIG2	second	Resetting of the reminder function for the calibration	5-86
CAL RESET	CONFIG3	second	Resetting of the reminder function for the yearly calibration	5-86
S-REF1	AUTOCAL	first	The first reference echo for the semi-automatic calibration	5-29
S-REF2	AUTOCAL	first	The second reference echo for the semi-automatic calibration	5-29
HDR IN REPORT	FILES	second	Inserting the header into the test report	6-15

Function	Function group	Operating level	Description	see page
HEADER EDIT	FILES	second	Editing of data for the header of the test report	6-14
BOTTOM	DR	second	Setting of coordinates of the last cell in the grid matrix (Data Recorder)	6-22
DELETE REF	dB REF	first	Deleting the stored reference echo for the dB difference measurement	5-38
MAGNIFY GATE	EVAL	second	Choice of the gate for spanning the gate	5-65
MAX AMP. %	CONFIG4	second		5-84
MEMO IN REPORT	FILES	second	Inserting the memo text into the test report	6-12
MEMO EDIT	FILES	second	Editing the memo text for the test report	6-11
TOF MODE	GATE A	first	Choice of measuring point at the signal in the gate A	5-22
TOF MODE	GATE B	first	Choice of measuring point at the signal in the gate B	5-22
READING 1 READING 2 READING 3 READING 4 READING 5 READING 6	EVAL	second	Choice of the readings for the six boxes of the measurement line	4-5
MIN AMP. %	CONFIG4	second		5-84
MODE	FILES	second	Choice of an action for video files	6-17
NOISE LEVEL. %	CONFIG4	second		5-84

Function	Function group	Operating level	Description	see page
O-DIAMETER	TRIG	second	Toggling between plane-parallel and curved test objects	5-48
O-DIAMETER	EVAL	second		5-48
THICKNESS	TRIG	first	Entry of test object thickness for calculating the true flaw depth	5-47
THICKNESS	EVAL	second		5-47
ORIENTATION	CONFIG1	second	Configuration of the instrument for left-handed or right-handed operation	4-16
PARAM EDIT	CONFIG4	second	Enabling and disabling of settings	5-87
PARAM MODE	CONFIG4	second	Choice of the user: Inspector or Expert	5-87
PARAMETERS	FILES	second	Display of the current instrument settings	6-16
PARAM IN REPOR	FILES	second	Inserting the adjustment values into the test report	6-9
PASSWORD	CONFIG4	second	Password for the instrument access	5-87
PHANTOM PRF	CONFIG2	second	Activation of the phantom echo detection	5-58
POWER SAVER	CONFIG3	second	Activation of the power saving mode	5-79
PROBE DELAY	RANGE	first	Compensation of the probe delay line	5-10
SOURCE/DEST	FILES	second	Choice of the memory location for video files	6-17
ADV DIRECTION	DR	second	Advance direction for the automatic filling of the grid matrix	6-22
DUAL	RECEIVER	first	Pulser-receiver separation	5-19

Function	Function group	Operating level	Description	see page
VELOCITY	RANGE	first	Velocity	5-10
LAYER EDIT	CONFIG3	second	Adjustment of layer thicknesses for the function TOF in LAYER	5-80
LAYER TYPE	CONFIG3	second	Toggling between a single layer and 10 layers	5-80
PULSER TYPE	CONFIG2	second	Toggling between square-type pulser and spike-type pulser	5-75
SERIAL NUMBER	CONFIG1	second	Display of the serial number of the instrument	
LANGUAGE	CONFIG1	second	Choice of language	4-13
DEPTH	BLOCK	first		
TOF in LAYER	CONFIG3	second	Turning on of the function TOF in LAYER	5-80
REFERENCE TYPE	DGS	first		5-119
REJECT	RECEIVER	first	Suppression of unwanted echo indications	5-19
VOLTAGE	PULSER	first	Pulser voltage	5-14
X VALUE	TRIG	first	Entry of the distance between the probe index point and the face of the angle-beam probe	5-48
X VALUE	EVAL	second	Entry of the distance between the probe index point and the face of the angle-beam probe	5-48
TIME	CONFIG1	second	Setting of time	4-15

9.2 EU Declaration of Conformity

The USM Go conforms to the requirements of the following EU directives:

- 2014/30/EU (Electromagnetic compatibility)

The conformity with the requirements of the EU directive is proven by the observance of the standard specifications

- EN 55 011:1998, Class A, Group 2, and
- EN 61 000-6-2:2005
- EN 61 000-6-4:2001

The conformity with the requirements of the EU directive 73/23/EEC, amended by 93/68/EEC, is proven by the observance of the standard specification

- EN 61 010-1:2001

9.3 Manufacturer/Service addresses

The ultrasonic flaw detector USM Go is manufactured by:

Baker Hughes Digital Solutions GmbH

Robert-Bosch-Straße 3
50354 Hürth
Germany

T +49 (0) 22 33 601 111

F +49 (0) 22 33 601 402

The USM Go is manufactured according to the state-of-the-art methods using high-quality components. Thorough in-process inspections or intermediate tests and a quality management system certified to ISO 9001 ensure an optimum quality of conformance and workmanship of the instrument.

Should you nevertheless detect an error on your instrument, power the instrument off and remove the batteries. Inform your local Waygate Technologies customer service and support, indicating the error and describing it.

Keep the shipping container for any repairs possibly required which cannot be made on the spot.

If there is anything special that you would like to know about the use, handling, operation, and specifications of the instruments, please contact your nearest Waygate Technologies representative or turn directly to:

Baker Hughes Digital Solutions GmbH

Service-Center

Robert-Bosch-Straße 3

50354 Hürth

Germany

or:

Postfach 1363

50330 Hürth

Germany

T +49 (0) 22 33 601 111

F +49 (0) 22 33 601 402

USA

Waygate Technologies

Baker Hughes Digital Solutions

721 Visions Drive

Skaneateles, NY 13152

USA

T +1 888-332-3848, 315-554-2000 ext. 1

9.4 Environmental protection regulations

This section contains information about the following topics:

- WEEE directive
- Disposal of batteries

WEEE directive (Waste Electrical and Electronic Equipment)

Waygate Technologies is an active participant in Europe's Waste Electrical and Electronic Equipment (WEEE) take-back initiative, directive 2012/19/EU.

The instrument that you have bought has required the extraction and use of natural resources for its production. It may contain hazardous substances that could impact health and the environment.

In order to avoid the dissemination of those substances in the environment and to diminish the pressure on our natural resources, we advise you to use the appropriate take-back systems. Those systems will reuse or recycle in an environmentally safe way most of the materials of your instrument which is no longer capable of functioning.

The crossed-out wheeled bin symbol invites you to use those systems.



If you need more information on the collection, reuse, and recycling of recyclable material, please contact your local waste management company.

Visit ec.europa.eu/environment/waste/weee/index_en.htm for take-back instructions and more information about this initiative.

Disposal of batteries

This product contains batteries that cannot be disposed of as unsorted municipal waste in the European Union. Please read carefully the data sheets for the battery type used. Each battery is marked with this symbol which indicates that the product may contain cadmium (Cd), lead (Pb), or mercury (Hg). For proper recycling, return the batteries to the manufacturer or to a designated collection point.

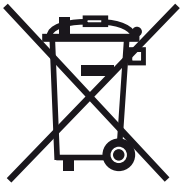

What do the markings mean?

Batteries and accumulators must be marked (either on the battery, on the accumulator, or on their packaging, depending on the size) with the separate collection symbol. In addition, the marking must include the chemical symbols of specific levels or toxic metals as follows:

- Cadmium (Cd) over 0.002 %
- Lead (Pb) over 0.004 %
- Mercury (Hg) over 0.0005 %

The risks and your role in minimizing them

By participating in the proper waste disposal, you would make a valuable contribution towards reducing the damages possibly caused to the environment and human health by the batteries or accumulators. For proper recycling, you should return the instrument and/or the batteries it contains to the manufacturer or to a designated collection point.

Some batteries or accumulators contain toxic metals that pose serious risks to human health and to the environment. When required, the product marking may include chemical symbols that indicate the presence of toxic metals in the product: Pb for lead, Hg for mercury, and Cd for cadmium.

- **Cadmium** poisoning can result in cancer of the lungs and prostate gland. Chronic diseases may include kidney damage, pulmonary emphysema, as well as bone diseases such as osteomalacia and osteoporosis. Cadmium may also cause anemia, discoloration of the teeth, and anosmia (loss of smell).
- **Lead** is poisonous in all compounds. It accumulates in the body so that any form of exposure is critical. Ingestion and inhalation of lead can cause severe internal injuries. These may result in brain damage, convulsions, malnutrition, and sterility.
- **Mercury** creates hazardous vapors already at room temperature. Exposure to high concentrations of mercury vapor can cause a variety of severe symptoms. These include e.g. chronic inflammation of mouth and gums, personality change, nervousness, fever, and rashes.

Specifications **10**

10.1 Specifications of USM Go and USM Go+

Display screen

Active range (W × H)	108.0 × 64.8 mm, diagonal 5 inches
Size	5 inches
Resolution (W × H)	800 × 480 pixels
Contrast ratio	≥300
Brightness	≥200 cd/m ²
Range	14,016 mm (552 inches) for longitudinal wave

Display

Display shift (DISPLAY DELAY)	-15 ... 3,500 μ s
Probe delay	0 ... 1,000 μ s
Velocity	250 ... 16,000 m/s
PRF	Automatically optimized 15 ... 2,000 Hz, 3 automatic setting modes: Auto Low, Auto Med, Auto High, Manual

Connectors

Probe connectors	2 \times LEMO-00, mechanical reverse polarity protection
USB interface	Micro USB connector
Service interface	1 \times Mini-RS232C, only used for service purposes

Memory

Card slot SD card slot for all standard SD cards

Pulser

Pulser mode Spike pulser, optionally: Square-wave pulser

Pulser voltage (SQ mode) 120 ... 300 V, in steps of 10 V with a tolerance of 10 %

Pulser falling/rising time max. 10 ns

Pulser width (SQ mode) 30 ... 500 ns, in steps of 10 ns with a tolerance of 10 %

Pulser amplitude (spike mode) low: 120 V, high: 300 V

Pulser energy (spike mode) low: 30 nS, high: 100 nS

Damping 50 ohms, 1000 ohms

Receiver

Digital gain	Dynamic range 110 dB, adjustable in steps of 0.2 dB
Analog bandwidth	0.9 ... 20 MHz
Equivalent input noise	<80 μ V, across the full bandwidth
Recovery time	Target of <10 μ s
Input linearity	5 % for method E317, for output data on all 4 ADC's
Filters	Broadband 1-5 MHz 2, 2.25 MHz 4, 5 MHz 10 MHz 13, 15 MHz

Gates

Independent gates	2 gates A and B (triggering by gate A), gate C (option)
Rectification	positive half-wave, negative half-wave, full wave, RF signal
Measuring position	Peak, Flank, J-FLANK, FIRST PEAK

Memory

Capacity	2 GB, SD card
Datasets	UGO data structure in ASCII
Reports	JPG- or BMP-type A-scans

Environment

Battery	Operating time: 6 hours with full charge Charging method (standard): internal with charger/power adapter Charging method (optional): external charger Charge level: proportional charge level indicator
Charger/power adapter	Universal power supply unit 100 ... 240 VAC, 50/60 Hz, meets the requirements of CCC, CE, UL, CSA, and PSE
Size (W × H × D)	175 × 111 × 50 mm
Weight	850 g incl. battery
Languages	Bulgarian, Chinese, Czech, Dutch, English, Finnish, French, German, Hungarian, Italian, Japanese, Norwegian, Polish, Portuguese, Romanian, Russian, Spanish, Swedish

Protection

Damp heat and humidity (storage)	10 cycles: 10 hrs at +60 ... +30 °C, 10 hrs at +30 ... +60 °C, transition within 2 hrs (507.4)
Temperature shock (storage)	3 cycles: 4 hrs at -20 ... +60 °C, 4 hrs at +60 °C transition within 5 minutes (503.4, Procedure II)
Vibration:	General exposure: 1 hr per axis, 514.5-5 Procedure I, Annex C, Figure 6
Shocks	6 cycles per axis, 15 g, 11 ms, half-sine (516.5 Procedure I)
Loose cargo (in shipping containers)	514.5 Procedure II
Transit drop (packaged for shipment)	26 drops, 516.5 Procedure IV
Enclosure	IP67 according to IEC 529
Operating temperature range	0 ... 55 °C

Storage temperature range	-20 ... +60 °C, 24 hrs including battery
Compliance	EMC/EMI: EN 55011, EN 61000-6-2:2001 Ultrasound: EN 12668, ASTM E1324, E317, ANSI/NCSL Z 540-1-1994, MIL STD 45662A, MIL STD 2154

Options

AWS	AWS calibration tool, according to AWS D1.1 Structural Welding Code
DAC	DAC calibration tool, 16 points, according to EN ISO 11666, EN ISO 17640, ASTM E164, ASME, ASME III, JIS Z3060 TCG: 120 dB dynamic, 110 dB/μs slope
DGS	DGS calibration tool, according to: EN ISO 11666, EN ISO 17640, ASTM E164
Data logger	Grid file creation
3G	Gate C

SWP	for pulser parameter optimization, voltage setting 120 ... 300 V in steps of 10 V, pulse width setting 30 ... 500 ns in steps of 10 ns
JIS, CN, DGS, BEA, Phantom-PRF	Phantom-PRF for the identification of erroneous echoes caused by multiple reflections in low-attenuation materials
JIS, CN, DGS, BEA	

10.2 Specifications according to EN 12668

You will find the specifications according to EN 12668 for your instrument on the USB stick included in the standard package.

Index **11**

- A**
- ABOUT 5-52, 7-4
- AC power adapter 3-2
- ACTION 4-20, 4-22, 6-3, 6-5, 6-7
- Addresses 9-11
- Adjustment range 4-11
- ADV DIRECTION 6-24
- A-FREEZE 5-68
- AGT 0-7, 5-28
- Alarm 4-6, 5-77, 8-3
 - Gate logic 5-74
 - Signal 5-64
- Alarm output 5-77
- AMPL CORRECT (DGS) 5-124
- Angle of incidence 5-46
- Angle-beam probe 0-7, 5-45
- A-scan 4-3
 - Fill 5-71
 - Freezing 5-68, 5-69
 - Normal 4-3
 - Storing 6-9
 - Zoom 4-3
 - Zoomed 6-29
- A-SCAN COLOR 4-17
- A-scan color 4-17
- A-scan freeze 5-68
- ASCANFILL 5-71
- A-START 5-23
- A-THRESHOLD 5-24
- Auto Gain Control 5-84
- AUTO80 4-8
- AUTOANG 5-50
- AUTOCAL 5-31
- Automatic gain control 5-84
- Automatic gate height 5-28
- A-WIDTH 5-23
- AWS D1.1 5-41
- AWSD1.1 in DAC/TCG 5-99

B

B REFERENCE 5-99

Backwall Echo Attenuation 5-82

Backwall echo attenuation 5-82

Batteries

External charging 3-8

Inserting 3-4

Internal charging 3-8

Battery 0-8

Care 7-2

Charge level 0-8, 3-7

Charging 7-3

Checking 3-6

Indicator 3-7

Warning of low charge level 3-7

Battery charge level 0-8, 3-7

Battery icon 3-7

Battery operation 1-2, 3-4

Battery warning 0-8

BEA 5-82

B-FREEZE 5-68

BLOCK 5-51

BOTTOM 6-24

BRIGHTNESS 4-18

Brightness 4-18

B-START 5-23

BSTARTMODE. 5-27

B-THRESHOLD 5-24

B-WIDTH 5-23

C

Calibration

Dual-element probes 5-34

Straight-beam probes 5-30

Calibration reminder 5-86

Care 7-2

Changing

Operating level 0-3, 0-9

Charge level of battery 3-6

Charger/power adapter 3-2

Charging

Batteries 3-8

Charging status 3-8

CNDAC 5-109, 5-111

Turning off 5-116

Turning on 5-111

Coarse and fine adjustment 4-10

CODE 5-52

Code for options 5-52

COLOR 4-17

COLOR LEG 5-49

Comma/Period 4-14

Components 9-22

Condition

DAC/TCG 5-100

JISDAC 5-107, 5-117

Connecting

Charger/power adapter 3-3

Probe 3-9

CONTROL 6-20, 6-21

CREATE 6-24

D

DAC 0-7

Adding points 5-97

Echo evaluation 5-100, 5-107, 5-117

Editing points 5-96

Multiple DAC curves 5-97

Sensitivity correction 5-99, 5-106, 5-115

Setting up 5-94

Turning off 5-95

Turning on 5-91

DAC according to JIS 5-102

DAC curve

Deleting 5-96

Recording 5-92

Recording (CNDAC) 5-111

Recording (JISDAC) 5-102

DAC/TCG 5-91

DAMPING 5-17

Data Recorder

-
- Turning off 6-29
 - Turning on 6-29
 - Data Recorder (option) 6-22
 - Data Recorder file 6-22
 - Activating 6-25
 - Creating 6-23
 - DATASET 4-23
 - Date
 - Format 4-15
 - Setting 4-15
 - DATE FORMAT 4-15
 - dB increment 5-6
 - dB REF 0-7, 5-38
 - dB STEP 5-7
 - dB step 4-5
 - Decimal separator 4-14
 - Default settings 4-13
 - Date and Time 4-15
 - Display 4-16
 - Instrument 3-12
 - Language 4-13
 - Scheme 4-16
 - Units 4-14
 - Defects/errors 1-3
 - Defining probe angle 5-50
 - Defining the probe index angle 5-50
 - DELAY VELOCITY (DGS) 5-124
 - DELETE DATASET 6-7
 - Deleting
 - CNDAC 5-117
 - DAC curve 5-96
 - DGS reference echo 5-129
 - Directory 6-4
 - File 6-7
 - JISDAC 5-107
 - Reading 6-27
 - Reference echo 5-39
 - Test report 6-7
 - Deleting the DAC curve (CNDAC) 5-117
 - Deleting the DAC curve (JISDAC) 5-107
 - DGS 0-7
 - Basic settings 5-123

- Deleting a reference echo 5-129
- Locks 5-127
- Recording a reference echo 5-125
- Starting 5-123
- Turning off 5-129
- DGS CURVE (DGS) 5-124
- DGS evaluation 5-119
- DGS MODE 5-126, 5-129
- Difference measurement 5-38
- Directive 2002/96/EC 9-13
- Directive 89/336/EEC 9-11
- DIRECTORY 4-12
- Display
 - Brightness 4-18
 - Grid 4-18
 - Scheme 4-17
 - Setting 5-70
- DISPLAY DELAY 5-13
- Display delay 5-13
- Display freeze 5-68
- Display range 5-10, 5-11

- Display screen 4-3
 - A-scan representation 4-3
- Display zero 5-13
- Displaying dataset name 4-22
- DR 6-22, 6-23, 6-25, 6-28, 6-29
- DR THICKNESS 6-24
- DR VIEW 6-29
- DUAL (pulser-receiver separation) 5-20

E

- Echo evaluation 5-25, 5-29, 5-53
- Echo height comparison 5-38
- ECHO MAX 5-72
- Echo Max 5-72
- Echo start gate 5-22
- Editing
 - DAC points 5-96
 - Header file 6-14
 - Memo file 6-11
 - Test report 6-6

-
- EFF. DIAMETER (DGS) 5-124
 - EMPTY 6-27
 - EN 12668 10-11
 - Ending 3-12
 - ENERGY 5-15
 - Enlarged display of reading 5-62
 - ENTER 4-21, 6-4, 6-18, 6-20
 - ENVELOPE 5-83
 - Envelope curve 5-83
 - Environmental compatibility 9-13
 - Environmental protection regulations 9-13
 - Error messages 5-127
 - EVAL MODE 5-73
 - Evaluation of flaws 1-6

 - F**
 - Factory default setting 3-12
 - FAST REPORT 6-3
 - Features 1-11

 - File operations 8-3
 - FILENAME 4-20, 4-22, 6-3, 6-5, 6-8, 6-17, 6-20, 6-23, 6-25, 6-28
 - Fine and coarse adjustment 4-10
 - Firmware 7-4
 - First operating level 4-9, 5-3
 - FIRST PEAK 5-25, 5-54
 - Flag 6-19, 6-21
 - FLANK 5-25, 5-54
 - Flaw class 5-42
 - Flaw gain 5-42
 - Flaw position calculation 5-45
 - FRAME 6-21
 - Freeze 0-7, 5-68
 - FREEZE MODE 5-68
 - FREQUENCY 5-19
 - FULLWAVE 5-20
 - FUNCTION 1 5-9
 - FUNCTION 2 5-9
 - Function groups 4-4

- Changing 0-9
- Function keys 4-7
- Functions
 - Activating 4-12
 - Display on the screen 4-4
 - First operating level (Base) 0-3
 - First operating level (Options) 0-4
 - Keypad 0-8
 - Navigation 0-9
 - Second operating level 0-5, 0-6
- Functions (in alphabetical order) 9-2

G

- Gain 0-8, 4-2, 4-5
 - Setting 5-6
- Gain control 5-84
- Gate
 - Setting 5-22
 - Spanning 5-65
 - Starting point 5-23
- GATE A 5-22

- GATE A LOGIC 5-74
- GATE B 5-22
- Gate B
 - Start 5-27
- Gate logic 5-74
- Gate tracking 5-27
- GB 11345 5-109
- GRID 4-18
- Grid matrix 6-22
 - Turning off 6-29
 - Turning on 6-29

H

- HDR IN REPORT 6-15
- Header 6-13
- HEADER EDIT 6-13
- Header file
 - Creating 6-13
 - Editing 6-14
 - Including in the test report 6-15

HOLDfunc 5-9
HOME 4-8, 4-11

I

IMAGE IN REPOR 6-9
Index angle of probe 5-50
Instrument orientation 4-16
Instrument settings 4-19
Interfaces 8-2

J

J-FLANK 5-25, 5-54
JISDAC 5-102, 5-106, 5-116
 Turning off 5-106
 Turning on 5-102
Joystick
 Locking 5-76

K

Key combinations 4-8

Keypad functions 0-8

L

LANGUAGE 4-13
Language 4-13
LARGE 5-62
 Alarm 5-64
Layer 5-80
LED on charger/power adapter 3-8
LED on power supply unit 3-8
Legs 5-49
Limits of testing 1-5
LINE 5-116
LOCK 5-7
Locks
 DGS 5-127

M

MAGNIFY GATE 5-65

11 Index

Magnify gate 0-7
Magnify gate function 5-65
Maintenance 7-3
Making measurements 5-37
Material
 Instrument 9-13
 Test object 1-5
Materials 9-22
Matrix 6-22
 Turning off 6-29
 Turning on 6-29
Measurement line 4-5
 Configuring 5-59
Measuring point (symbol) 4-5
Memo
 Creating 6-10
 Editing 6-11
 Storing 6-10
MEMO EDIT 6-10
Memo file
 Attaching to test report 6-12

 Creating 6-10
 Editing 6-11
MEMO IN REPORT 6-12
Memory card
 Inserting 3-10
 Removing 3-10
MODE 5-62, 6-18, 6-20
Monitor 8-4
Multiple DGS curves 5-128

N

Navigation 0-9, 4-7
NEG HALFWAVE 5-20
Notes 6-10

O

Object diameter 5-48
O-DIAMETER 5-48
OFFSET 5-98
OFFSET2 5-98

- OFFSETS 5-98
 - Operating level
 - Changing 0-9
 - Function groups 5-2
 - Operating levels
 - Concept 4-9
 - Operating manual 1-12
 - Operating time 0-8
 - Operational concept 4-9
 - Operator training 1-4
 - Operator's controls 4-2
 - Options 1-10
 - Enabling 5-52
 - ORIENTATION 4-16
 - Output of alarm 5-77, 8-3
 - Outside diameter 5-48
 - Overview
 - Functions of the first operating level 0-3, 0-4
 - Functions of the second operating level 0-5, 0-6
 - Keypad functions 0-8
 - Navigation 0-9
 - Power level indicators 0-8
 - Status display icons 0-7
 - USMGo 1-8
- ## P
- PARAM IN REPOR 6-9
 - Parameters
 - Storing 6-9, 6-16
 - Viewing 6-16
 - Password 5-87
 - Changing 5-88
 - Lost 5-88
 - Saving 5-88
 - Password protection 5-87
 - Canceling 5-89
 - PEAK 5-25, 5-54
 - Penetration 5-15
 - Phantom echo detector 5-58
 - PHANTOM PRF 5-58
 - Play 6-21
 - POINT 5-96, 5-97

11 Index

POINT GAIN 5-96
POINT POS. 5-97
POS HALFWAVE 5-20
Power key 4-8
Power level indicator 0-8
POWER SAVER 5-79
Power saving mode 5-79
Power supply 3-2
Powering Off 3-12
Powering On 3-11
Prerequisite
 Measurement 5-37
Prerequisites
 Testing 1-3
 Training 1-4
 Wall thickness measurement 1-5
PRF MODE 5-17
Printer 8-4
Printing 6-6
Probe
 Connecting 3-9
 PROBE # (DGS) 5-124
 PROBE ANGLE 5-46, 5-50
 Probe data (DGS) 5-130
 PROBE DELAY 5-11
 Probe delay 5-11
 PROBE DELAY (probe delay) 5-11
 Probe matching 5-17
 PROBE NAME (DGS) 5-124
 Probe table
 DGS evaluation 5-130
 Pulse repetition frequency 5-15, 5-16, 5-17
 PULSER 5-14
 Pulser 5-14
 Pulser connection 3-9
 Pulser type 5-75
 Pulser voltage 5-14
 Pulser-receiver separation 0-7, 5-20

R

Radio frequency 5-20

RANGE 5-10, 5-11

Rating

Welds 5-41

READING 5-59

Reading 4-5

Deleting 6-27

Storing 6-26

RECALL DATASET 4-22

Recalling

Dataset 4-22

Dataset name 4-23

Settings 4-21

RECEIVER 5-19

Receiver 5-19

Receiver connection 3-9

Receiver frequency 5-19

RECORD 6-18

Record

Calibration echo 5-31

Recording

DAC curve 5-92

JISDAC 5-102, 5-111

Reference echo for dB-difference
measurement 5-39

Reference echo for DGS 5-125

Videos 6-17

Recording a reference echo (DGS) 5-125

RECTIFY 5-20

Recycling 7-6

REF ATTEN (DGS) 5-124

REF SIZE (DGS) 5-124

Reference block (CNDAC) 5-109, 5-110

Reference echo

Deleting 5-39

Echo height comparison 5-40

Recording 5-39

Reference gain 5-42

Reference lines (CNDAC) 5-116

REFERENCE TYPE (DGS) 5-124

REJECT 5-21

Reject 0-7

Remaining wall thickness 1-6

Reminder 0-7

Reminder for calibration 5-86

Remote control 6-21

Repair 7-3

REPLAY 6-20

Report header 6-13

RESET 4-8

Reset 3-12

Restart 3-12

Restoring 3-12

RF 5-20

S

Safety information 1-2

Saving

 Password 5-88

 Settings 4-19

Scheme 4-16

SD card

 Icon 0-7

 Inserting 3-10

 Removing 3-10

SD memory card 0-7

Second operating level 4-9, 5-4

Semi-automatic calibration 5-31, 5-35

Sensitivity correction 5-99, 5-106, 5-115

Serial number 3-11

Service addresses 9-11

Service interface 8-3

Setting

 Gain 5-6

Setting units 4-14

Setting up DAC (CNDAC) 5-114

Setting up DAC (JISDAC) 5-105

Settings

 Displaying dataset name 4-22

 Protecting 5-89

Recalling 4-21, 6-4
Saving 4-19
SHOW REPORT 6-5
Side-drilled hole 5-51
Software 1-2, 3-11, 7-4
Sound attenuation (DGS evaluation) 5-128
Sound attenuation factor 5-42
Sound energy 5-15
SOURCE/DEST 6-17, 6-20
Spanning the gate 5-65
Specifications 10-2
Specifications according to EN12668 10-11
Speed 6-21
Square-wave pulser 5-14, 5-75
Start display 3-11, 5-52, 7-4
Start value 4-11
Starting 3-11
Starting point of gateB 5-27
Starting points of the gates 5-23

Status display icons 0-7, 4-6
STOP 6-19, 6-21
Store
 Readings 6-22
STORE DATASET 4-20
STORE REPORT 6-3
Storing 6-2
 A-scan 6-9
 DAC curve point 5-93
 Memo 6-10
 Parameters 6-9, 6-16
 Reference echo 5-39
 Reference gain 5-43
 Report header 6-13
 Test report 6-2
 Video 6-17

T

TCG 0-7
TCG/DAC MODE 5-95
Technical test requirements 1-4

11 Index

- Temperature 1-6
 - TEST ATTEN (DGS) 5-124
 - TEST ATTEN (sound attenuation in the test object)
 - DGS evaluation 5-128
 - Test object material 1-5
 - Test report 6-2
 - Deleting 6-7
 - Displaying 6-4
 - Printing 6-6
 - Storing 6-2
 - THICKNESS 5-47
 - Thickness 5-47
 - Through-transmission 5-20
 - TIME 4-15, 6-21
 - Time 4-15
 - TOF in LAYER 5-80
 - TOF MODE 5-25, 5-53
 - TOF mode 5-29
 - TOF mode (symbol) 5-54
 - Toggling
 - A-scan display mode 4-3
 - Function group 4-9, 4-10
 - TRANSFER CORR. (sensitivity correction) 5-99, 5-106, 5-115
 - Transfer correction (DGS) 5-128
 - Transfer correction (JISDAC) 5-99, 5-106, 5-115
 - Transfer loss 0-7
 - TRIG 5-45
 - trueDGS 5-133
- ## U
- UGO 4-19
 - UltraMATE 6-21
 - UNITS (setting units) 4-14
 - UPDATE 4-8
 - Updates 7-4
 - Upgrade 5-52
 - USB interface 8-2, 8-3
 - USER GAIN STEP 5-7

V

VELOCITY 5-12

Velocity 5-12

Version number 5-52, 7-4

Video

Recording 6-17

Viewing 6-19

VIRTUAL LED 5-64

VOLTAGE 5-14

W

Wall thickness 5-47

Wall thickness measurement 1-5

Waste disposal 7-6, 9-14

WEEE directive 9-13

Weld

Rating 5-41

WIDTH 5-16

X

X VALUE 5-48

XTAL FREQUENCY (DGS) 5-124

Z

Zoom 4-3

RemoteService@bakerhughes.com

waygate-tech.com

ISO 9001
REGISTERED COMPANY

© 2021 Baker Hughes

All rights reserved. Specifications subject to change without notice.

Printed in USA

Baker Hughes 

bakerhughes.com